

Towards Optimal Green Plant Irrigation: Watering and Body Electrical Impedance

Original

Towards Optimal Green Plant Irrigation: Watering and Body Electrical Impedance / Garlando, Umberto; Bar-On, Lee; Ros, Paolo Motto; Sanginario, Alessandro; Peradotto, Sebastian; Shacham-Diamand, Yosi; Avni, Adi; Martina, Maurizio; Demarchi, Danilo. - ELETTRONICO. - (2020), pp. 1-5. (Intervento presentato al convegno 2020 IEEE International Symposium on Circuits and Systems (ISCAS) tenutosi a Sevilla, Spain nel 10-21 Oct. 2020)
[10.1109/ISCAS45731.2020.9181290].

Availability:

This version is available at: 11583/2858379 since: 2020-12-21T16:58:52Z

Publisher:

IEEE

Published

DOI:10.1109/ISCAS45731.2020.9181290

Terms of use:

This article is made available under terms and conditions as specified in the corresponding bibliographic description in the repository

Publisher copyright

IEEE postprint/Author's Accepted Manuscript

©2020 IEEE. Personal use of this material is permitted. Permission from IEEE must be obtained for all other uses, in any current or future media, including reprinting/republishing this material for advertising or promotional purposes, creating new collecting works, for resale or lists, or reuse of any copyrighted component of this work in other works.

(Article begins on next page)

Towards Optimal Green Plant Irrigation: Watering and Body Electrical Impedance

Umberto Garlando*, Lee Bar-On[†], Paolo Motto Ros*, Alessandro Sanginario*, Sebastian Peradotto*, Yosi Shacham-Diamand[†], Adi Avni[‡], Maurizio Martina* and Danilo Demarchi*

*Dept. of Electronics and Telecommunications, Politecnico di Torino, Torino, Italy

[†]School of Electrical Engineering, Tel Aviv University, Tel Aviv, Israel

[‡]Faculty of Life Sciences, Tel Aviv University, Tel Aviv, Israel

Email: umberto.garlando@polito.it

Abstract—With the growth of world population and food demand, it is crucial to optimize water consumption for agriculture cultivation. Here we propose a method to monitor plant status, relating the measured parameters to the watering or drying situation of a single plant. Plant trunk electrical impedance measurements and environmental parameters were analyzed with a statistical approach. Correlation and causality among the data are showed and analyzed. In this way, it was possible to easily obtain the needed information about plant status.

I. INTRODUCTION

Green plant irrigation is planned according to farmer's experience, water supply and weather forecasts. Sensor technology for these applications is mainly based on the monitoring of external plant parameters. With growing world population, where nutrition and food security depend on agricultural production, accurate monitoring is required. Such monitoring can allow to optimization of water use, and offer improved irrigation planning. Water consumption is expected to be amongst the most important future challenges, as reported in the 'Food and Agriculture Organization' of United Nations [1].

Plant monitoring is based on data collection of different parameters from the surrounding plant environment, such as temperature, humidity, soil moisture, etc [2]–[4]. As these parameters are not a direct indication of plant status, here we propose monitoring the plant impedance changes in order to understand its hydration status and to adapt irrigation in a more accurate and faster responding manner. Thus we implemented a monitoring system able to measure plant body impedance of multiple plants simultaneously, in addition to monitoring their surrounding environment [4]. The combined analysis of collected data can be used to improve plant irrigation: water needs are directly measured from the plant and not from the environment.

II. EXPERIMENTAL SETUP

The study was carried out on both tobacco and tomato plants. The measurement system, described in [5], consists of two parts. A collection of environment sensors and a direct impedance measurement of the plant. The electrical impedance measurement, is collected at intervals of 15 minutes, while the measurement is multiplexed between a number of plants.

This is controlled by a LabView [6] software interface. The second part consists of a system of sensors collecting the surrounding plant environment changes [7] and is based on the RPi[®] hardware [8]. It is programmed using Python. In order to simultaneously measure multiple plants, a multiplexing circuit was fabricated using a set of reed relays controlled by the software system.

A schematic diagram of the system is shown in Figure 1, where 2 plants are measured. They are connected through a multiplexing circuit to the impedance analyzer (Agilent 4294a) using four terminals, which is connected to a user interface (running in LabView) and can be controlled with the main system software. The system of environment sensors is controlled through the same software. The collected data are saved on the system.

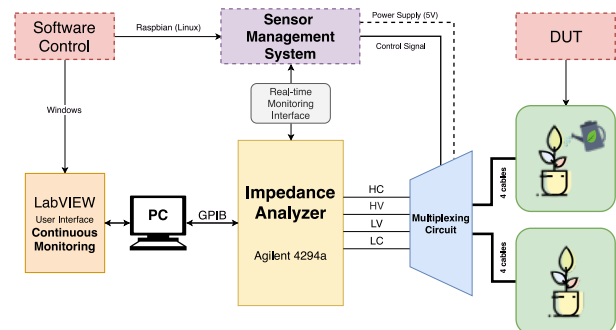

Fig. 1. Full system architecture showing impedance measurements and environment sensors connection

The measurements were conducted across different time periods, ranging from a few days up to two weeks. The environment sensors were calibrated according to manufacturer's instructions and within working range. Impedance measurements were carried out according to established results [7]. Impedance was measured across frequency range of 40Hz-1MHz, collecting a maximal number of measurements, within equipment capacity and sampling intervals. A study of the effect of irrigation and changes in environment sensors was carried out.

III. MEASUREMENTS AND RESULTS

Plants were measured according to their hydration status and results are plotted across time, inspecting the changes in measured impedance. A study of the effect of irrigation on impedance was completed, in relation to changes measured using a standard soil moisture sensor.

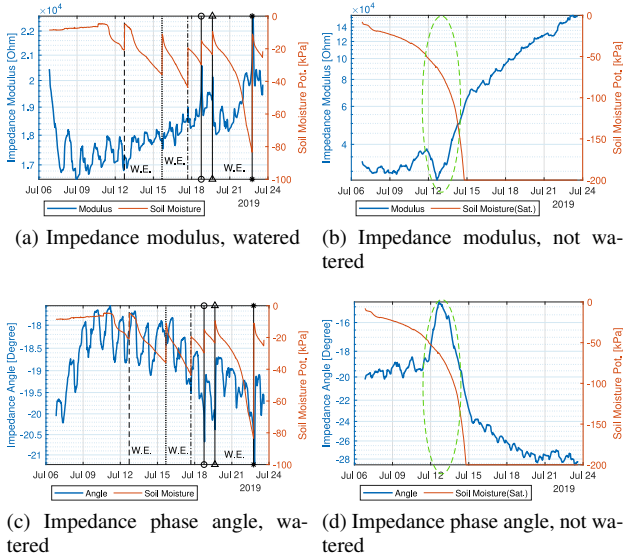

Fig. 2. Excerpt from the collected data, showing the body electrical impedance (modulus and phase angle) for two tomato plants, regularly watered and not watered respectively; soil moisture potential has been reported as reference.

Fig. 2a and 2b show the changes in impedance w.r.t. watering events, reflected by the instantaneous changes in the soil moisture potential (and marked with a dashed line); impedance angle (phase) is reported, for the same conditions in Fig. 2c and 2d. Instead of presenting the full spectrum of the measured impedance, we pre-analyzed the data and deemed that, to this aim, focusing on just one key frequency (here 1 kHz) was enough to correctly represent the scenario. From these graphs can be easily seen that, in case of the watered plant, both the modulus (Fig. 2a) and the angle (Fig. 2c) are quite constant (e.g., the modulus in the range of few kΩ), despite the periodic daily behavior (which could be well explained by the diurnal cycle, for example). On the opposite side, when the plant is not watered, we can observe a steady (and mostly monotonic) increase in the impedance of up to about one order of magnitude (Fig. 2b, with the soil moisture potential decreasing down to the saturation limit of the sensor of -200 kPa), as well as a significant and identifiable change in the impedance angle (Fig. 2d).

However, in order not to limit our observations at just one frequency and the corresponding impedance, we looked also at maximum/minimum impedance and their location in the spectrum, so to have an estimate of the whole range of impedance (along with the possible changes) we could expect in these tests. In Fig. 3a are reported both the value and the frequency of the maximum impedance across all the spectrum. While the maximum values exhibit the same trend seen before, i.e., a significant increase in correspondence of a lack of

watering events, the related frequency remains in a small range (about 40-42.5 Hz). Fig. 3b shows similar results regarding the impedance angle, however whilst in the previous analysis the frequency range was more compact, here the frequency shift is more pronounced, thereby suggesting that this kind of analysis should be better performed on the modulus.

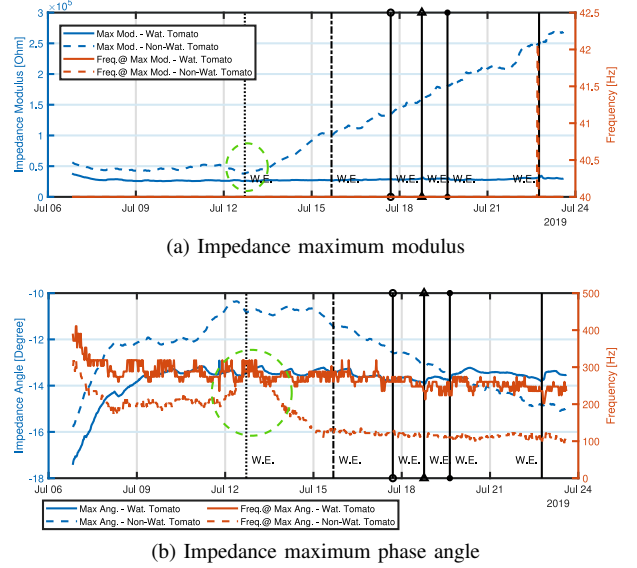

Fig. 3. Maximum impedance analysis, showing both the values (modulus and phase angle) and the related frequency, for both a regularly watered tomato plant and a not watered one.

The same measurement/analysis has been performed on the minimum of the impedance across all the spectrum. Results are reported in Fig. 4a and 4b, showing exactly the same behavior (although the related frequencies are different) as in the maximum impedance case.

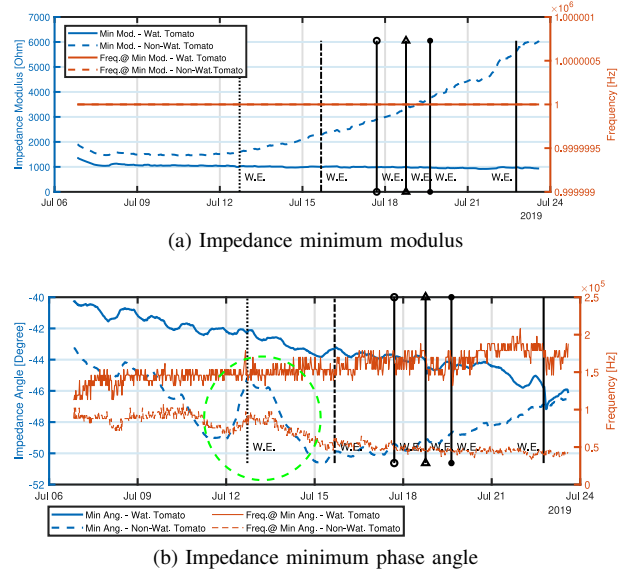
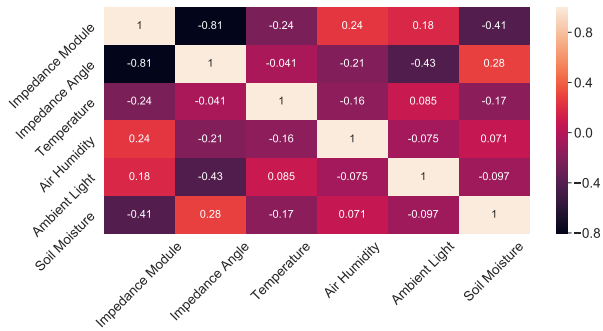

Fig. 4. Minimum impedance analysis, showing both the values (modulus and phase angle) and the related frequency, for both a regularly watered tomato plant and a not watered one.

IV. DISCUSSION AND ANALYSIS

Given the results of the measurements discussed in the previous section, another important analysis relates to the relation among the different measured quantities .

The visual inspection of Fig.2 shows evidence of correlation among soil moisture and impedance. However, a mathematical approach is needed to demonstrate the effective relation. Firstly the correlation is studied. Correlation is the measure of the relationships among two variables. The Pearson correlation coefficient [9] is the most commonly used and it can be computed using Python Pandas [10] built-in functions. This Python package was used to analyze the measured data. In particular, the *corr* function implements the computation of the Pearson coefficients for the measurements. The Pearson coefficient, a number ranging from -1 to 1, estimates the linear correlation among different data series. A correlation coefficient equal to 1 means the strongest positive correlation. For example, each series has self-correlation equal to 1. Similarly, the perfect negative correlation is associated with coefficient -1. A coefficient almost equal to 0 shows that the two quantities are completely uncorrelated. The analysis here described was applied to the data presented in the previous section: two tomato plants, one watered and one non-watered. Impedance values are the ones obtained considering frequency equal to 1 kHz. In this way each impedance spectrum is reduced to a single value, simplifying the analysis. Data of almost one thousand measurements were used as data-set. The resulting correlation matrices are reported in Fig. 5.



(a) Correlation matrix, watered

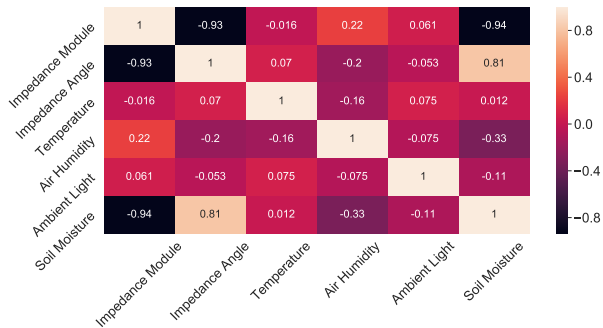

(b) Correlation matrix, not watered

Fig. 5. Correlation matrices for watered and not watered plant.

From the correlation matrices reported in Fig. 5, the following assumptions can be extracted. The impedance module and angle are highly correlated, as expected. Furthermore, the soil moisture shows high values for both the plants. In the not watered case, this relation is even stronger. In fact, in this case, the correlation coefficients among impedance values and the ambient measurements (light, humidity, and temperature) are almost zero. In the watered plant, on the contrary, the correlation matrix shows that the soil moisture correlation is not predominant and also humidity and light are correlated with the impedance.

However, the correlation does not imply a causal relationship between two variables. The definition of causality implies that one variable is caused by another one if the knowledge of the latter increases the accuracy of the prediction of the former. Furthermore, it is mandatory that a third variable, influencing the first two, does not exist. In statistics, the Granger causality [11] is a mathematical model used to find a causality relation among two variables. The Granger causality is limited to linear relations. In this case, the correlation matrix showed before gives reasonable results and therefore the Granger method is applied to our measurements.

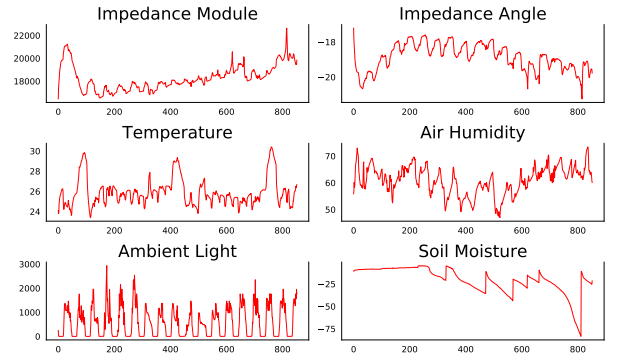

(a) Original data series

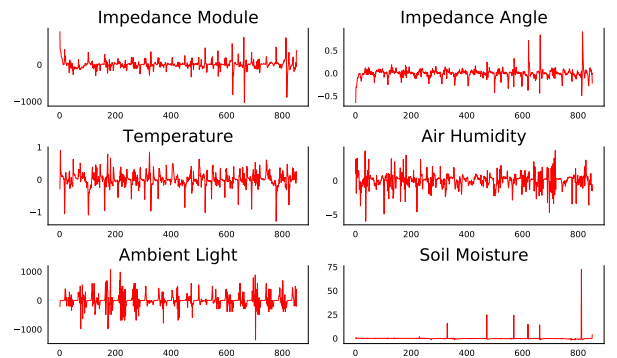

(b) Data series after difference

Fig. 6. Data series of the watered plant before and after "difference" application. The series in the bottom figure are covariance stationary

In order to test the causality among the variables, the following approach was used. A Python script was used to perform data manipulation and causality tests. The tests were performed using the function available in a Python package developed for statistics, named *StatsModels* [12]. In order to

perform the Granger causality test, it is important to verify the covariance stationarity of the data series. This implies that the mean and standard deviation of the series do not change in time. The augmented Dickey-Fuller test is commonly used to determine if a unit root is present in the series; its presence implies a non-stationarity of the data. This test is implemented in the used package and it was applied to plants data. Some of the series of measurements tested showed non-stationarity, preventing a direct analysis of the causality relationship. Therefore, “difference” technique was applied to our data. This technique, commonly used in statistics, consists of replacing each value in the series with a new one equal to the difference with the previous element. The new data was tested again for stationarity with positive results. Fig. 6 shows a comparison of our signals before and after the difference application.

The new series match all the prerequisites for the application of the Granger causality test. Also in this case, a specific function of the package is available to perform this test. This function receives two series and test if one is “Granger causing” the other. The test needs the number of “lagged samples” to be used. This value defines the order of the test: it is the number of past samples of the series considered to perform the test. The maximum value for the number of lags is set to one hundred, considering that, with the sampling rate of our system, one day of sampling is equal to ninety-six values. The script calls the function to perform the test for each value of lag, starting from zero and getting to the selected parameter. Each time an F Test is performed. An F test is used in statistics to verify a hypothesis. In this case, the hypothesis is that one series is not causing the other. A value is obtained with the test and if this value is below a certain threshold, we can reject the hypothesis. Furthermore, we select the minimum result obtained with the different values of lagged samples. The resulting matrices are reported in Fig. 7.

The matrices can be read in this way: each column refers to one quantity. If the number in the column is smaller than 0.01 we can say that the quantity corresponding to the column is “Granger causing” the row’s quantity with a 99% confidence level. Looking at our matrices it is clear that the soil moisture is causing both impedance module and angle in the watered and not watered case. The other parameters, on the contrary, show different behaviors in the two experiments. In the watered plant case, the impedance angle seems to be caused by all the quantities, while the module only by the soil moisture. In the other case, the causality is detected for every ambient quantity, excepted for air humidity that is not causing impedance angle.

The main result obtained with these analyses is that the impedance of a plant stem is strictly correlated with the soil moisture, and with the ambient parameters (light, temperature, and humidity). Furthermore, the Granger causality method was applied to our data and a causality relation among soil moisture and the electrical impedance both in watered and not watered plants was proved. However, even the ambient parameters are statistically causing the electrical impedance. The relation is not the same in the two experiments, demonstrating the

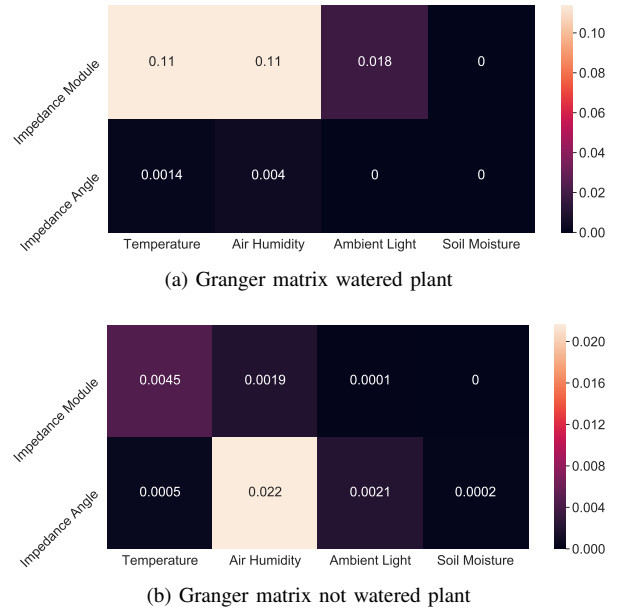

Fig. 7. Results of the Granger causality test for watered and not watered plants.

effectiveness of the proposed method, where the measurement and the analysis of the parameters as a whole, and not just as a separated entity, increases the confidence for understanding the watering or dryness of the plant.

V. CONCLUSION

We have presented a study of plant well being parameters correlated to electrical impedance measurements of the plant body. We have shown that the impedance changes show direct link with watering events indicating plant watered status. In addition, monitoring further parameters in the surrounding environment provides more accurate correlations to the changes. Obtained results indicate an effective possibility of adapting the system for field use, allowing easy data collection and consequent planning of irrigation.

ACKNOWLEDGEMENT

The authors would like to thank the *Italian Ministry of Foreign Affairs and Cooperation* for collaboration grant 2019-2020 for supporting this work.

REFERENCES

- [1] Food and Agriculture Organization of United Nations, “Coping with water scarcity: an action framework for agriculture and food security.” Available at <http://www.fao.org/3/i3015e/i3015e.pdf>, 2008. [Accessed 5-12-2019].
- [2] A. Luvisi, “Electronic identification technology for agriculture, plant, and food. a review,” *Agronomy for Sustainable Development*, vol. 36, no. 1, p. 13, 2016.
- [3] A. Walter, R. Finger, R. Huber, and N. Buchmann, “Opinion: Smart farming is key to developing sustainable agriculture,” *Proceedings of the National Academy of Sciences*, vol. 114, no. 24, pp. 6148–6150, 2017.
- [4] S. Fritz, L. See, J. C. L. Bayas, and et al. Waldner, “A comparison of global agricultural monitoring systems and current gaps,” *Agricultural Systems*, vol. 168, no. May 2018, 2019.

- [5] L. Bar-on, S. Peradotto, A. Sanginario, P. Motto Ros, Y. Shacham-Diamand, and D. Demarchi, "In-vivo monitoring for electrical expression of plant living parameters by an impedance lab system," in *2019 IEEE International Conference on Electronics, Circuits, and Systems (ICECS)*, 2019. In press.
- [6] National Instruments, "Labview Software."
- [7] L. Bar-on, A. Jog, and Y. Shacham-Diamand, "Four Point Probe Electrical Spectroscopy Based System for Plant Monitoring," *2019 IEEE International Symposium on Circuits and Systems (ISCAS)*, pp. 1–5, 2019.
- [8] "Raspberry pi 3, specs, benchmarks & testing. the magpi magazine." Available at <https://www.raspberrypi.org/magpi/raspberry-pi-3-specs-benchmarks>. [Accessed 3-12-2019].
- [9] S. Williams, "Pearson's correlation coefficient.," *The New Zealand medical journal*, vol. 109, no. 1015, p. 38, 1996.
- [10] W. McKinney, "Data structures for statistical computing in python," in *Proceedings of the 9th Python in Science Conference* (S. van der Walt and J. Millman, eds.), pp. 51 – 56, 2010.
- [11] C. W. J. Granger, "Investigating causal relations by econometric models and cross-spectral methods," *Econometrica*, vol. 37, no. 3, pp. 424–438, 1969.
- [12] S. Seabold and J. Perktold, "statsmodels: Econometric and statistical modeling with python," in *9th Python in Science Conference*, 2010.