

A novel procedure to adjust the equivalent circuit parameters of photovoltaic modules under shading

Original

A novel procedure to adjust the equivalent circuit parameters of photovoltaic modules under shading / Ciocia, A.; Di Leo, P.; Fichera, S.; Giordano, F.; Malgaroli, G.; Spertino, F.. - ELETTRONICO. - (2020), pp. 711-715. (Intervento presentato al convegno 2020 International Symposium on Power Electronics, Electrical Drives, Automation and Motion, SPEEDAM 2020 tenutosi a ita nel 2020) [10.1109/SPEEDAM48782.2020.9161878].

Availability:

This version is available at: 11583/2850713 since: 2020-11-01T15:58:45Z

Publisher:

Institute of Electrical and Electronics Engineers Inc.

Published

DOI:10.1109/SPEEDAM48782.2020.9161878

Terms of use:

This article is made available under terms and conditions as specified in the corresponding bibliographic description in the repository

Publisher copyright

(Article begins on next page)

A Novel Procedure to Adjust the Equivalent Circuit Parameters of Photovoltaic Modules under Shading

Alessandro Ciocia
Dip. Energia “Galileo Ferraris”
Politecnico di Torino
Corso Duca degli Abruzzi 24, Torino,
Italy
alessandro.ciocia@polito.it

Paolo Di Leo
Dip. Energia “Galileo Ferraris”
Politecnico di Torino
Corso Duca degli Abruzzi 24, Torino,
Italy
paolo.dileo@polito.it

Stefania Fichera
Dip. Energia “Galileo Ferraris”
Politecnico di Torino
Corso Duca degli Abruzzi 24, Torino,
Italy
stefania.fichera@polito.it

Francesco Giordano
Dip. Energia “Galileo Ferraris”
Politecnico di Torino
Corso Duca degli Abruzzi 24, Torino,
Italy
francesco.giordano@polito.it

Gabriele Malgaroli
Dip. Energia “Galileo Ferraris”
Politecnico di Torino
Corso Duca degli Abruzzi 24, Torino,
Italy
gabriele.malgaroli@polito.it

Filippo Spertino
Dip. Energia “Galileo Ferraris”
Politecnico di Torino
Corso Duca degli Abruzzi 24, Torino,
Italy
filippo.spertino@polito.it

Abstract—Commercial PhotoVoltaic (PV) modules generally consist of a number of PV cells ranging between 60 and 96. The solar cells in a PV module are connected in series and partitioned in 3 or 4 strings, each protected by a bypass diode. In general, the terminals of each string are available by opening the junction box but, in case of partial shading, the current-voltage (I - V) curves of a single defective solar cell cannot be directly measured and only the I - V curve of the PV string can be obtained by experimental tests. In the present work, a novel indirect procedure to extract the parameters of shaded PV cells using models generally adjusted for irradiated cells is proposed. It is defined “One Module (or One String), Two Tests” and it requires two tests performed as close as possible: in the first step, all the N_s cells of a PV module or a string are irradiated while, in the second step, the PV module or string have a shaded cell and N_s-1 irradiated cells. In the present work, the procedure is applied to a string of a p-Si module consisting of 20 solar cells.

Keywords—Shaded PV cell, indirect procedure, equivalent circuit, irradiated models, parameters of shaded cell.

I. INTRODUCTION

In last decades, the energy demand is rapidly growing due to several factors like the urbanization process and the increase of human population. This last aspect is particularly relevant in the developed countries where the energy consumptions increase up to 5% per year [1,2]. Although most of the generated electricity still comes from fossil fuels, the challenge for all the countries around the world is the reduction of the polluting emissions and global warming. This goal can be reached through the exploitation of Renewable Energy Sources (RES) and the most important and reliable is the solar energy. Indeed, PhotoVoltaic (PV) technology requires low costs of installation, operation and maintenance also in building applications [3] and it is a clean, noise-free and highly available technology [4]. Researchers in the PV field are actually focusing on different topics, such as cheaper or more efficient materials and the improvement of the efficiency and reliability of traditional PV technologies [5]. In order to deeply study and simulate the operation of a PV generator, the measurement of the current–voltage (I - V) characteristic curve and the derived parameters of the equivalent circuit are necessary. These data are used in many applications such as studies of mismatch in complex grid-connected PV systems [6,7] or the performance investigation of Maximum Power Point Trackers (MPPT) under different irradiance conditions [8,9]. In such conditions, the electrical performance of PV generators is optimized thanks to a proper detection of Maximum Power Point (MPP) and the use of bypass diodes, which protect PV strings in case of mismatch or partial shading [10]. In order to obtain the parameters of the equivalent circuit, the I - V characteristic is measured and elaborated according to precise models defined in literature [11]. During the last two decades, several algorithms were developed in order to extract the equivalent parameters with more accuracy; the development of more powerful computers and new optimization algorithms permits a more efficient identification of PV parameters [12-14]. However, researchers focused their work only on the parameters estimation of PV generators in irradiated condition and no information about the model parameters in case of partial shading is available. The knowledge of the equivalent parameters of a shaded PV cell is fundamental for the performance analysis of the generator and of the connected MPPT system [15].

In the present work, a novel procedure is proposed to obtain the parameters of PV cells under shading conditions using models generally adjusted for irradiated cells. The procedure starts with I - V curve measurements of irradiated and shaded cells and it is applied to a string of a p-Si module consisting of 20 solar cells. This paper is organized as follows: section II describes the effects of partial shading depending on the PV array configuration and the most used solutions to mitigate it. Section III introduces the indirect method and shows the methodology adopted to carry out the measurements. In section IV, the results of the analysis are presented for a PV string of a p-Si module. Finally, Section V contains the conclusions.

II. EFFECTS OF PARTIAL SHADING

In terms of power loss, the effect of partial shading on PV arrays depends on the connection configuration. Fig. 1 shows the main PV plant configurations. Series and parallel configurations (Fig. 1-a, and 1-b) are the basic configurations and the performance of these configurations has been widely discussed in literature [16-18]. The major drawback of PV strings, consisting of series-connected PV modules, is that the partial shading strongly affects the generated current. In fact, in series connected strings, all the cells carry the same output current. Hence, if just few cells under shading produce less power, the entire array will produce the maximum current permitted by the shaded cells. Moreover, in this condition, the shaded cells may get reverse biased, acting as loads, thus draining power from the irradiated cells, and with the risk of being irreversibly damaged [16]. On the contrary, partial shading, in case of parallel strings, directly affects the generated voltage but the solar cells do not present risk of damage because no cells are forced to carry more than their contribution of current [19]. However, in simple parallel connection, the obtainable voltage is limited to the 1-cell voltage. Fig. 1-c shows a typical Series-Parallel (SP) configuration. In SP configurations, PV modules are first connected in series to get the required voltage and then series-connected strings are paralleled to achieve the required current and thus the needed power. Finally, Fig. 1-d shows the Total Cross-Tied (TCT) configuration which is directly derived from the SP configuration by connecting ties across the series connected arrays. In this case the voltages across the ties are equal. The performance of the different configurations under shaded conditions is described in [17, 19, 20]. The literature agrees to conclude that TCT is the best configuration from a technical point of view.

The TCT configuration overcomes some of the drawbacks of the series array. In particular, since none of modules are directly connected in series, the stress on the cells is reduced as well as the drawing of power from the shaded cells. However, as described until now, even TCT does not overcome the strong loss of generated current in the series connected arrays embedded in the TCT. A common way to partially mitigate the power reduction is represented by the use of by-pass diodes connected in antiparallel with PV modules. Fig. 2-a shows a typical SP configuration with by-pass diodes. During the normal operation (all the modules uniformly irradiated) the diodes are inversely biased, thus the current flows through all the PV modules of the array. When one of the PV modules gets in the shade, its voltage drops, and the diode results directly biased. Therefore, the current generated by the irradiated PV modules of the array can again flow through the diode. The use of the by-pass diodes helps to mitigate the power loss as well as in preventing the PV module of being irreversibly damaged. Therefore, SP configuration with by-pass diodes is widely adopted at the PV field level [19]. However, the insertion of the diodes impacts on the I - V curve and, consequently, the P - V curve of the field. In normal condition, the generation presents a unique MPP, and the corresponding I - V and P - V curves are respectively represented in Fig.2-b (black curves). During partial shading, the diode activates, two stairs appear in the I - V curve, and, as a consequence, the P - V curve is characterized by different local peaks and one global peak (Fig. 2-b, blue curves) [21]. In case of absence of a by-pass diode, the P - V curve will exhibit only a single peak, but a significant reduction of power will be obtained as highlighted in Fig.2-b (red curve).

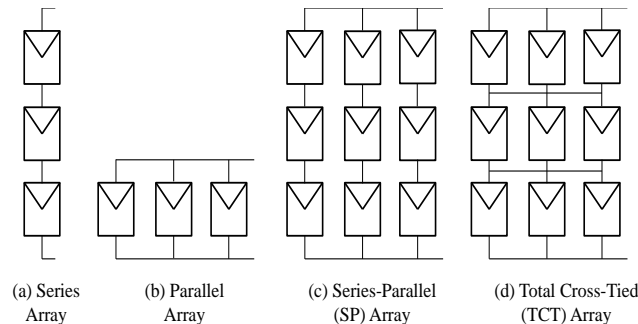

Fig. 1. Principal PV plant connection configurations.

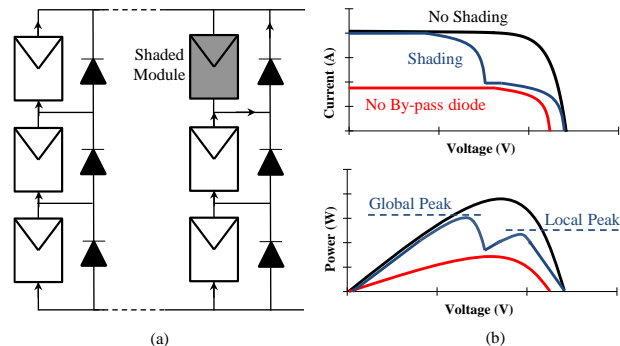

Fig. 2. SP configuration under uniform insolation and partial shading (a); relative I - V and P - V curves (b).

During on-field operation of a PV plant, the main aim is obviously trying to extract always the maximum possible power. Therefore, at the design level, avoiding the obstacles which obstruct the sun light is essential. However, in case of large or building integrated plants, it is difficult to avoid partial shading (due to temporary clouding or neighborhood buildings) throughout the day in all the seasons. In such cases, the MPP of the P - V curve needs to be continuously pointed. With this aim,

different MPPT algorithms have been developed. Moreover, with the presence of by-pass diodes and the complexification of the P - V curve, it is crucial to guarantee the tracking of the global peak avoiding the permanence in local peaks. Hence, MPPT algorithms need to be sophisticated to achieve this goal (Modified MPPT). The variety of the MPPT algorithms can be summarized into two principal techniques: Perturb and Observe (P&O) and Incremental Conductance (IC).

- Within the P&O, the algorithm introduces a perturbation in the PV array by modifying its operating voltage/current. Then, the variation in the operating power is observed: an increment on the operating power implies that the algorithm is getting closer to the MPP. In the next sampling, the direction of the perturbation is maintained and the operating voltage/current is updated at the corresponding value. Once the algorithm reaches the localities of the MPP, the sign of the perturbation is alternatively changed. Therefore, the algorithm will never be settled exactly at the MPP, but it will oscillate in the enclosing. In order to make the algorithm faster and more accurate on the MPP surrounding, the P&O can be improved with adaptive (not fixed) perturbation magnitudes [21, 22]. However, the working principle behind this approach has intrinsically the limitation of being not able to recognize if a peak is local or global. Thus, permanence in local peaks is likely to occur. In order to overcome this issue in case of partial shading, usually the main P&O program is supported by a global peak tracking routine [23]. The main P&O program operates continuously to achieve a peak operating point. On the contrary, the global peak tracking routine is activated for certain shaded conditions (or at every pre-fixed time interval) aiming to scan the totality (or a large part) of the P - V curve.
- The IC, instead, consists of computing and comparing the load conductance (I/V) and the incremental conductance ($\Delta I/\Delta V$) of I - V curve, starting from PV voltage V and PV current I . This methodology relies on the fact that, in the presence of a peak of the P - V curve, its derivative is zero and $-\Delta I/\Delta V$ is equal to I/V . Therefore, if the variation $-\Delta I/\Delta V$ results lower than I/V , the operating point lies at the left side of the MPP and the operating voltage needs to be increased to reach the MPP. On the contrary, if $-\Delta I/\Delta V$ is higher than I/V , the operating point is at the right side and the voltage needs to be decreased. Even with this approach, since both local and global peaks exhibit zero as derivative, it is not possible to guarantee the operation at the global peak. An example of modified IC methods for partial shading condition, consists of forcing the PV array to work into the neighborhood of the global peak [21, 24]. Practically, knowing open circuit voltage (V_{oc}) and short circuit current (I_{sc}), the operating point is approximated at the 80% of V_{oc} and 95% of I_{sc} . Finally, adjustments are made moving the operating point according to the IC method.

III. PROCEDURE AND EXPERIMENTAL SETUP

A. Description of the indirect procedure

Commercial PV modules generally consist of a number of PV cells ranging from 60 to 96, partitioned in 3 or 4 strings in series, each string protected by a bypass diode. In these cases, by opening the junction box, the terminals of each string are available. However, in case of partial shading, the I - V curve of a single shaded cell cannot be directly measured but an indirect method is required.

This procedure, defined “One Module (or One String), Two Tests”, requires two I - V measurements of the same PV module or string: in the first condition, all the N_s cells of a module or a string are under uniform irradiance while, in the second measurement, (N_s-1) cells are irradiated and a single cell is shaded. In order to avoid abrupt variations of environmental conditions (cell temperature T_c and irradiance G), the measurements need to be performed as close as possible. Obviously, in case of series connection, for each current value, the voltage of the string is the sum of every cell voltage. The I - V curve of a single cell can be defined dividing the I - V characteristic of the whole string by the N_s number of series connected cells. This procedure can provide very accurate results assuming that: the cells are characterized by identical electrical parameters, due to a correct sorting during their manufacturing, and they have uniform irradiance and temperature conditions in the absence of mismatch. In order to evaluate the I - V characteristic of N_s-1 cells, a proportionality assumption can be applied, starting from the I - V curve of the string in the following way:

$$V_{N_s-1} = V_{N_s} \cdot (N_s-1)/N_s \quad (1)$$

where V_{N_s} is the voltage of all the N_s cells in uniform conditions, while V_{N_s-1} is the voltage of the $(N_s - 1)$ cells. In case of shadings in a single cell, the I - V curve of the string is the sum of the voltages of the (N_s-1) well-working cells and the I - V curve of the shaded cell (Fig. 3).

Finally, with opposite reasoning, the I - V curve of the shaded cell is obtained as the difference between the I - V curve of the PV string (including the shaded cell) and the I - V curve of the $(N_s - 1)$ cells subject to uniform irradiance.

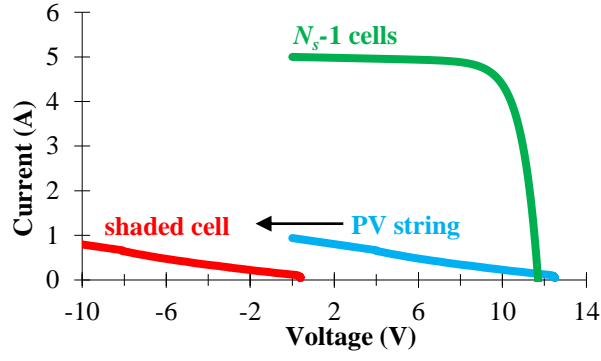

Fig. 3. I - V curves of a string with (N_s-1) cells under uniform irradiance condition and a single shaded cell.

B. Experimental setup of I - V curve tracing

The I - V curves of PV generators under test are traced using an Automatic Data Acquisition System (ADAS), which permits to store simultaneously the irradiance G , the air temperature T_a , and the current and voltage values. In particular, the measurements of the I - V curves are performed with a capacitive load, initially discharged, which is charged by PV generators from short-circuit to open-circuit states. The duration of the capacitor charging transient is affected by its capacitance (as well as the irradiance level), and it is properly selected to obtain time intervals shorter than 0.2 s. The ADAS is periodically calibrated and it is made up of the components as follows [25]:

- A notebook PC in which a LabVIEW software emulates a digital storage oscilloscope.
- A multifunction data acquisition board with one A/D converter (successive approximation technology, 16 bit-resolution, sampling rate up to 1.25 MSa/s, maximum input of ± 10 V, internal amplifier gains for lower ranges) and multiplexer.
- A differential voltage probe with two attenuation ratios 20:1 and 200:1 for voltage levels up to 140 V and 1400 V, respectively.
- Two current probes (Hall effect) with output sensitivity of 100 mV/A for current values up to ± 30 A, one for current measurement and one for trigger source.
- A reference cell in monocrystalline silicon for the measurement of irradiance with typical accuracy of ± 20 W/m².
- A thermometer, for measuring ambient temperature.
- A capacitive load with capacitance equal to 10 mF.

The schematic of the measurement circuit is presented in Fig. 4 with the involved instruments.

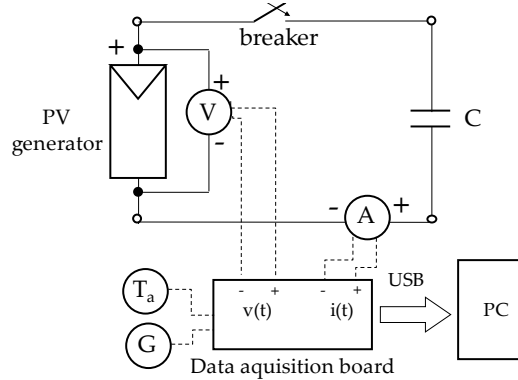

Fig. 4. Schematic of the measurement circuit.

IV. EQUIVALENT CIRCUIT OF A PV GENERATOR

The electrical performance of PV generators can be described by an equivalent model with parameters. In literature, the most used is the Single Diode Model (SDM) due to its simplicity with reasonable accuracy. But, it consists of five parameters [3], that can be determined experimentally: for these reasons, the SDM is used in this work. However, the two-diode model is preferred to SDM in case of partial shading [26]. In this paper, the SDM is applied also for shaded cells: the applicability of this model in such condition and the variation of cells parameters are investigated. As previously mentioned, this model is characterized by five parameters [3]: the photo-generated current I_{ph} , the saturation current I_0 , the quality factor n of the p-n junction, the series resistance R_s and the shunt resistance R_{sh} . In particular, the first current is the production of the solar cell, while the second term is a source of loss, reducing the output of the solar cell. Moreover, R_s is due to the front electrical contacts of the cell and it has to be low in order to reach an optimal compromise between good electrical contacts and high surface area available for sunlight

conversion. Regarding R_{sh} , it is due to the leakage currents flowing through the lateral surfaces of the solar cell and it has to be maximized in order to ensure a better lateral insulation. At cell level, the relevant equation of the SDM is the following:

$$I = I_{ph} - I_j - (V + R_s \cdot I)/R_{sh} = I_{ph} - I_0 \cdot \left(e^{\frac{q(V+R_s \cdot I)}{n \cdot k \cdot T_c}} - 1 \right) - (V + R_s \cdot I)/R_{sh} \quad (2)$$

where q is the charge of the electron, $= 1.602 \cdot 10^{-19}$ C, k is the Boltzmann constant, equal to $1.38 \cdot 10^{-23}$ J/K and T_c is the cell temperature. The representation of the SDM according to electric circuit theory is presented in Fig. 5. The Levenberg-Marquardt (LM) algorithm, which is a combination of the Gauss-Newton (GN) method and the Gradient Descent (GD) method, has been used to adjust the parameters.

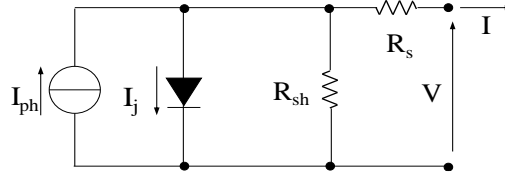

Fig. 5. Equivalent circuit of a PV cell according to SDM.

V. RESULTS

In the present work, a string of a p-Si module (rated power=280 W) has been analyzed. The string consists of 20 series-connected cells ($N_s=20$): in the first condition, all the 20 cells are under uniform irradiance (close to Standard Test Conditions, STC) while, in the second measurement, 19 are exposed to the same irradiance and a cell is totally shaded. Fig. 6 shows the I - V curves of 20 uniformly irradiated cells connected in series (black curve) while the green and yellow curves refer, respectively, to 19 irradiated cells and a single irradiated cell, obtained dividing the voltage by 20. Then, the I - V curve of the shaded cell (red curve in Fig. 7) is calculated according to the indirect methodology described in section III-A. Moreover, the parameters of the equivalent circuit have been determined for the shaded cell and an irradiated one. Fig. 8 presents the I - V curves from experimental data (blue points) and the model (red curve) for two shaded cells: the SDM well approximates their I - V curves, confirming the possibility to use this model in case of shading. In this analysis, ten cells of the PV string operate similarly to cell A, while the others result in I - V curves close to the one of cell B. Regarding the resulting PV parameters of cell A, the variation of n is negligible, while the other parameters decrease in case of shading except for R_s . In particular, I_{ph} and I_0 decrease from 8.3 A and $2.39 \cdot 10^{-7}$ A to 0.3 A and $2.80 \cdot 10^{-8}$ A, respectively. In this case, the ratio I_{ph}/I_0 decreases, resulting in a higher impact of current losses on output current. Regarding R_s , it increases from $4.59 \cdot 10^{-3} \Omega$ to 0.19Ω , resulting in a worse efficiency. On the contrary, R_{sh} of the shaded cell, 105Ω , is about half of the irradiated cell, 241Ω . Regarding the parameters of cell B, I_{ph} decreases from 7.6 A (irradiated cell) to 0.2 A under shading, resulting in a lower current absorption than shaded cell A. Moreover, I_0 is almost constant, ranging between $2.37 \cdot 10^{-7}$ A (irradiated cell) and $3.50 \cdot 10^{-7}$ A (under shading), while n decreases from 1.14 (irradiated cell) to 0.83 (shaded cell). Finally, the parameters R_s and R_{sh} increase from $4.62 \cdot 10^{-3} \Omega$ and 348Ω to 0.59Ω and 630Ω , respectively.

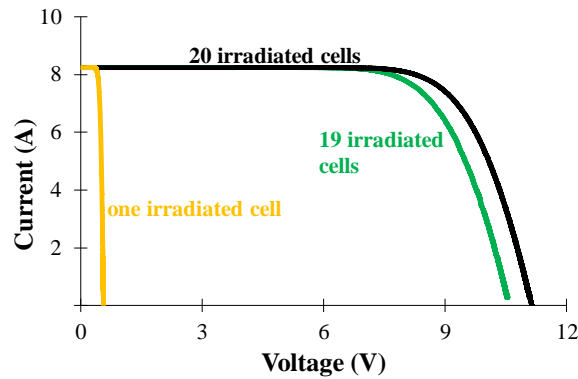

Fig. 6. I - V curves of a string with one, 19 and 20 cells under uniform irradiance condition.

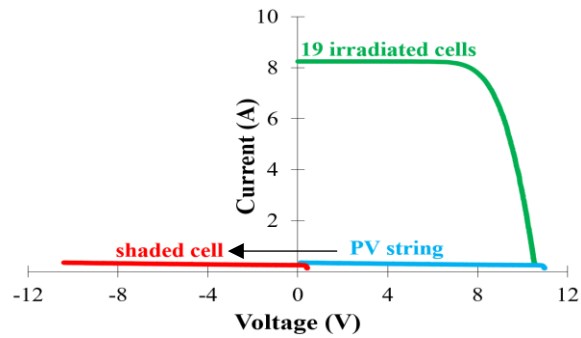

Fig. 7. I - V curve of a string with 19 cells in uniform irradiance condition and a single shaded cell.

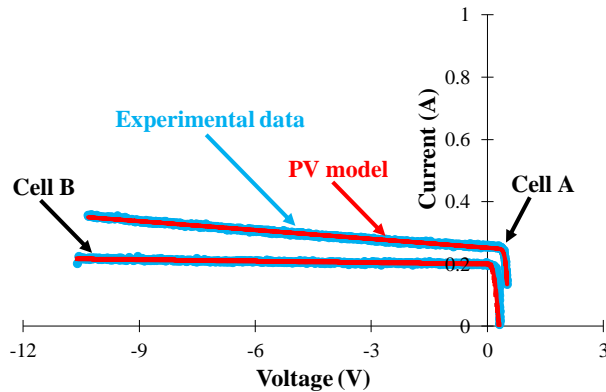

Fig. 8. I - V curve of the shaded cell: experimental data and model curve.

VI. CONCLUSIONS

The present work proposes a novel procedure to extract the parameters of shaded PV cells using models generally adjusted for irradiated cells. The procedure, defined “One Module (or One String), Two Tests”, consists of two measurements. In the first step, all the N_s cells of a module or a string are irradiated while, in the second step, the PV module or string have a shaded cell and (N_s-1) irradiated cells. In the present work, the methodology is applied to a string of a p-Si module consisting of 20 cells. As well known, in case of shading, I_{ph} decreases but the other equivalent parameters are, generally, supposed constant and equal to the irradiated ones. The present work demonstrates that this assumption is not correct and the worse electrical performance of a shaded cell is not due only to a reduction of I_{ph} . In particular, a worse behavior of the series resistance in the cell occurs (R_s increases of about two orders of magnitude), while the behavior of R_{sh} is not uniform (can increase or decrease).

REFERENCES

- [1] M. I. Al-Najideen, S. S. Alwashdeh, “Design of a solar photovoltaic system to cover the electricity demand for the faculty of Engineering- Mu'tah University in Jordan,” *Resource-Efficient Technologies*, Vol. 3, pp. 440-445, 2017.
- [2] E.H. Borgstein, R. Lamberts, J.L.M. Hensen, “Evaluating energy performance in non-domestic buildings: A review,” *Energy and Buildings*, Vol. 128, pp. 734-755, 2016.
- [3] F. Spertino, A. Ciocia, P. Di Leo, S. Fichera, G. Malgaroli and A. Ratclif, “Toward the Complete Self-Sufficiency of an nZEBs Microgrid by Photovoltaic Generators and Heat Pumps: Methods and Applications,” in *IEEE Transactions on Industry Applications*, vol. 55, no. 6, pp. 7028-7040, 2019.
- [4] M. Bahrami, R. Gavagsaz-Ghoachani, M. Zandi, M. Phattanasak, G. Maranzana, B. Nahid-Mobarakeh, S. Pierfederici, F. Meibody-Tabar, “Hybrid maximum power point tracking algorithm with improved dynamic performance,” *Renewable Energy*, Vol. 130, pp 982-991, 2019.
- [5] F. Spertino, E. Chiodo, A. Ciocia, G. Malgaroli and A. Ratclif, “Maintenance Activity, Reliability Analysis and Related Energy Losses in Five Operating Photovoltaic Plants,” 2019 IEEE International Conference on Environment and Electrical Engineering and 2019 IEEE Industrial and Commercial Power Systems Europe (EEEIC / I&CPS Europe), Genova, Italy, 2019, pp. 1-6.
- [6] F. Spertino, A. Ciocia, P. Di Leo, R. Tommasini, I. Berardone, M. Corrado, A. Infuso, M. Paggi, A power and energy procedure in operating photovoltaic systems to quantify the losses according to the causes, *Solar Energy*, Volume 118, 2015, Pages 313-326
- [7] K. Lappalainen, S. Valkealahti, Effects of PV array layout, electrical configuration and geographic orientation on mismatch losses caused by moving clouds, *Solar Energy*, Volume 144, 2017, Pages 548-555
- [8] A. Mohapatra, B. Nayak, P. Das, K. B. Mohanty, “A review on MPPT techniques of PV system under partial shading condition,” *Renewable and Sustainable Energy Reviews*, Volume 80, 2017, Pages 854-867
- [9] J. Ahmad, F. Spertino, A. Ciocia, P. Di Leo, “A maximum power point tracker for module integrated PV systems under rapidly changing irradiance conditions.” In: 2015 International Conference on Smart Grid and Clean Energy Technologies (ICSGCE), Offenburg, 2015, Pages 7–11.
- [10] J. Ahmad, F. Spertino, P. Di Leo and A. Ciocia, “An efficient maximum power point tracking algorithm for photovoltaic arrays under partial shading conditions,” 2016 IEEE International Power Electronics and Motion Control Conference (PEMC), Varna, 2016, pp. 322-327.
- [11] J.W. Bishop, Computer simulation of the effects of electrical mismatches in photovoltaic cell interconnection circuits, *Solar Cells*, Volume 25, Issue 1, 1988, Pages 73-89

- [12] D.Oliva, M. A. E. Aziz, A. E. Hassanien, Parameter estimation of photovoltaic cells using an improved chaotic whale optimization algorithm, *Applied Energy*, Volume 200, 2017, Pages 141-154
- [13] Alireza Askarzadeh, Alireza Rezazadeh, Parameter identification for solar cell models using harmony search-based algorithms, *Solar Energy*, Volume 86, Issue 11, 2012, Pages 3241-3249
- [14] L. Jiang, D. L. Maskell, J. C. Patra, 2013 "Parameter estimation of solar cells and modules using an improved adaptive differential evolution algorithm", *Applied Energy*, Volume 112, Pages 185-193.
- [15] F. Spertino, J. Ahmad, A. Ciocia and P. Di Leo, "A technique for tracking the global maximum power point of photovoltaic arrays under partial shading conditions," 2015 IEEE 6th International Symposium on Power Electronics for Distributed Generation Systems (PEDG), Aachen, 2015, pp. 1-5.
- [16] V. Quaschnig, R. Hanitsch, "Numerical simulation of current-voltage characteristics of photovoltaic systems with shaded solar cells," *Solar Energy*, vol. 56, no. 6, pp. 513-520, 1996.
- [17] N. D. Kaushika, N. K. Gautam, "Energy yield simulations of interconnected solar PV arrays," *IEEE Transactions on Energy Conversion*, vol. 18, no. 1, pp. 127-134, 2003.
- [18] F. Giraud and Z. Salameh, "Analysis of the effects of a passing cloud on a grid-interactive photovoltaic system with battery storage using neural networks," *IEEE Transactions on Energy Conversion*, vol. 14, no. 4, pp. 1572-1577, 1999.
- [19] R. Ramaprabha, B. L. Mathur, "A Comprehensive Review and Analysis of Solar Photovoltaic Array Configurations under Partial Shaded Conditions," *International Journal of Photoenergy*, vol. 2012, Article ID 120214, 16 pages, 2012.
- [20] Y. J. Wang and P. C. Hsu, "An investigation on partial shading of PV modules with different connection configurations of PV cells," *International Journal on Energy*, vol. 36, no. 5, pp. 3069-3078, 2011.
- [21] K. Ishaque, Z. Salam " A Review of Maximum Power Point Tracking Techniques of PV System for Uniform Insolation and Partial Shading Condition", *Renewable and Sustainable Energy Reviews*, Vol. 19, pp. 475-488, 2013.
- [22] Patel H, Agarwal V. MPPT scheme for a PV-fed single-phase single-stage grid-connected inverter operating in CCM with only one current sensor, *energy conversion*. *IEEE Transactions on* 2009;24:256-63.
- [23] Patel H, Agarwal V. Maximum power point tracking scheme for PV systems operating under partially shaded conditions, *industrial electronics*. *IEEE Transactions on* 2008;55:1689-98.
- [24] Kobayashi K, Takano I, Sawada Y. A study of a two stage maximum power point tracking control of a photovoltaic system under partially shaded insolation conditions. *Solar Energy Materials and Solar Cells* 2006;90:2975-88.
- [25] F. Spertino, J. Ahmad, A. Ciocia, P. Di Leo, A. F. Murtaza, M. Chiaberge, "Capacitor charging method for I-V curve tracer and MPPT in photovoltaic systems", *Solar Energy*, Volume 119, 2015, pp. 461-473.
- [26] N. Pattanaik , P. K. Shill , S. Nath , P. Das, "Study of Partial Shading Effects on Photovoltaic Arrays with Two-Diode Model", *International Journal of Engineering Research & Technology (IJERT)*, September 2019, Volume 08, Issue 09.