

Italian approach to suborbital space transportation: From setup of harmonized framework to spaceport and ground segment evaluation for enabling operations in the Italian territory

*Original*

Italian approach to suborbital space transportation: From setup of harmonized framework to spaceport and ground segment evaluation for enabling operations in the Italian territory / Santoro, Francesco; Del Bianco, Alberto; Viola, Nicole; Fusaro, Roberta; Albino, Vito; Binetti, Mario; Marzioli, Paolo. - ELETTRONICO. - (2017). (Intervento presentato al convegno 67th International Astronautical Congress (IAC) tenutosi a Adelaide (Australia) nel 25-29 September 2017).

*Availability:*

This version is available at: 11583/2695176 since: 2020-07-08T12:02:00Z

*Publisher:*

IAF

*Published*

DOI:

*Terms of use:*

This article is made available under terms and conditions as specified in the corresponding bibliographic description in the repository

*Publisher copyright*

(Article begins on next page)

IAC-17-D6.3.5x37541

## ITALIAN APPROACH TO SUBORBITAL SPACE TRANSPORTATION: FROM SETUP OF HARMONIZED FRAMEWORK TO SPACEPORT AND GROUND SEGMENT EVALUATION FOR ENABLING OPERATIONS IN THE ITALIAN TERRITORY

Francesco Santoro<sup>a\*</sup>, Alberto Del Bianco<sup>b</sup>, Nicole Viola<sup>c</sup>, Roberta Fusaro<sup>d</sup>, Vito Albino<sup>e</sup>, Mario Binetti<sup>f</sup>, Paolo Marzioli<sup>g</sup>

<sup>a</sup> ALTEC S.p.A. Torino, Italy, [francesco.santoro@altec.space.it](mailto:francesco.santoro@altec.space.it)

<sup>b</sup> ALTEC S.p.A. Torino, Italy, [alberto.delbianco@altec.space.it](mailto:alberto.delbianco@altec.space.it)

<sup>c</sup> Politecnico di Torino, Italy, [nicole.viola@polito.it](mailto:nicole.viola@polito.it)

<sup>d</sup> Politecnico di Torino, Italy, [roberta.fusaro@polito.it](mailto:roberta.fusaro@polito.it)

<sup>e</sup> Politecnico di Bari, Italy, [vito.albino@poliba.it](mailto:vito.albino@poliba.it)

<sup>f</sup> Politecnico di Bari, Italy, [mario.binetti@poliba.it](mailto:mario.binetti@poliba.it)

<sup>g</sup> Università di Roma Sapienza, Italy, [paolomarzioli@gmail.com](mailto:paolomarzioli@gmail.com)

\* Corresponding Author

### Abstract

Italy has increasing interest in Commercial Space Transportation and in particular in suborbital flights. A suborbital spaceflight system is an opportunity to involve the Italian industry in the development of new technologies, exploit opportunities of microgravity experimentation and pilots/astronauts training, as well as catalyse the national industry. The central position of Italy in the Mediterranean basin, the generically favourable climate condition, the touristic vocation resulting in hospitality at the highest level, pretty much allow year round suborbital operations and unique customer experience. Consequently, Italy is particularly suitable to host a Spaceport, even though the density of population has to be factored in as a key aspect, together with a proper environmental assessment. This paper outlines the basic Italian approach that, instead of focusing on the development of new Spaceport from scratch, evaluates the capabilities of existing airports and their possible upgrades to achieve the Spaceport license, when a proper regulatory frame will be established. Advances in the technical activities that are being conducted to assess various Italian sites of interest will be described, including trade off methodologies and ranking criteria. Different aspects will be considered, from the availability of civil and military airports, to the identification of the best location between coastline or inland sites but, first of all, in compliance to the safety requirements. Some specific Spaceport infrastructures and operational aspects will be described, along with their integration with the already existing ones. These include hangars, propellant storage facilities, ground support equipment, high and low airspace surrounding the airport area, ascent and descent corridors, as well as tracking telemetry station to support specific mission profiles in integrated fashion with the existing airport infrastructures and air traffic. The paper will also describe the approach to the definition of a harmonized cooperative regulatory framework, according to the Aviation Authority, that represents the basis to assess suborbital operations and allows the relevant missions execution. In this activity, basing upon an established Memorandum of Cooperation between FAA, ENAC and the Italian Space Agency, the existing FAA/AST regulatory work frame will be considered as reference benchmark and further tailored to the Italian case. Some considerations will also be developed relevant to initial challenges to be faced, by interested stakeholders, in starting commercial spaceflight initiatives as a new ground and emerging business opportunity.

**Keywords:** (Italy, suborbital, experimentation, spaceport, regulatory, tracking)

### Acronyms/Abbreviations

Italian Space Agency	ASI	International Civil Aviation Organization	ICAO
Air Traffic Control:	ATC	International Space Station	ISS
European Aviation Safety Agency	EASA	International Traffic in Arms Regulations	ITAR
Ente Nazionale per l'Aviazione Civile:	ENAC	Intermediate Experimental Vehicle	IXV
Ente Nazionale Assistenza al Volo	ENAV	Military Operating Area	MOA
Emergency Response Plans:	ERP	National Transportation Safety Board	NTSB
Federal Aviation Administration/Space		Reusable Launch Vehicles	RLV
Transportation Office:	FAA/AST	Search and Rescue	SAR
Frequency Difference of Arrival	FDOA		

Safety Management Systems:	SMS
Time Difference of Arrival	TDOA
Terminal Control Area	TMA
Takeoff Runway Available	TORA
United Nations Office for Outer Space Affairs	UNOOSA
Vertical takeoff and landing	VTOL

## 1. Introduction

Objective of the present work is the evaluation of aspects associated with establishing a spaceport for suborbital flight capabilities in the Italian territory. Considering the current status of the available technologies, many commercial initiatives are being carried out, especially in the USA, to accomplish suborbital flights with a parabolic trajectory beyond the Karman line, conventionally located at 100 Km altitude. In these flights, the centrifugal force is always negligible due to a small component of the velocity vector parallel to the horizontal line, and the corresponding Earth track length will be smaller in comparison to the Earth Radius.

As a consequence, a parabolic trajectory allows a return to the same departure point and both, the take-off and landing, will be horizontal from runway, particularly with an air launch approach. Future developments in the years to come, will include long range suborbital flights where the vehicle will not achieve orbit but will fall back to the Earth and re-enter the atmosphere in aero-braking mode a few minutes after engine shutdown. The relevant kinematics is such to insert the vehicle in an ellipse-arc trajectory beyond the aerospace domain: therefore, the initial speed shall be sufficient to allow the take-off and landing in two different locations of the Earth respectively, so that the flight may cover noticeable horizontal distances. For this reason, these flights can be considered as the candidate approach for the Future Generation Transportation. For this kind of flight, the technology for both the take-off and the inertial motion of the aerospace vehicle have reached a sufficient level of readiness; the most critical point that deserve specific attention is the stability and controllability in the re-entry phase. In the sub-orbital flight, the velocity is almost completely aligned with the horizontal line, so the centrifuge force will be comparable to the vehicle's weight.

The present paper will be focusing on the suborbital parabolic flights with departure and reentry in the same Spaceport site.

Fig. 1 shows a pictorial view of suborbital parabolic trajectory compared with Space Shuttle and other vehicles orbit.

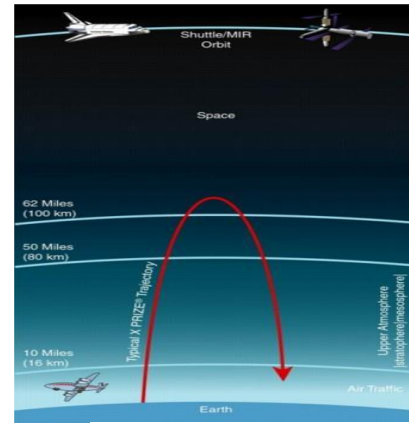

Fig. 1: Typical suborbital parabolic trajectory

In the United States different commercial Spaceports have been built from scratch, such as Spaceport America [1] or Oklahoma Air & Spaceport [2] that are based on very promising business forecast. In particular, Spaceport America is the first, purpose built commercial Spaceport. Both Spaceports are FAA licensed and Oklahoma Air & Spaceport has the only FAA approved corridor in the U.S. National Airspace System (NAS) currently for flight operations, not within restricted airspace or Military Operating Areas (MOAs). Fig. 2 and Fig. 3 show an overview of both Spaceports facilities.



Fig. 2: Spaceport America facilities



Fig. 3: Oklahoma Air & Spaceport operation center

Italy is pursuing the innovative approach of selecting and properly upgrading one or more Spaceport-eligible sites, selected among existing airports, rather than building new Launch sites from scratch [3]. There is a number of airports in Italy that are potentially suitable to host suborbital operations and are licensed by ENAC for commercial operations. Once a currently lacking suborbital operations regulatory framework will be established in Italy, it is evident that considering existing licensed airport sites is a smoother pathway to the final goal and allows the layout of favorable business models that optimize the associated investments. On the Operations point of view, relying upon existing sites allows easier handling of specific aspects such as air space management and proper fitting and easier planning of suborbital flights within the existing airport air traffic activities. Also, some airports in the Country are used far below their full potential and some local governments appear to be interested in investing into augmenting the existing capabilities to match the potential needs of suborbital spaceflight system operations and in general in developing specific sites to accommodate other aerospace experimental activities. Such situations are expected to act as catalyst to the development of the areas in proximity to the Spaceport and to the development of the general economy in the area. Section 2 summarizes the main reasons for considering a Spaceport in Italy, mostly related to the Country long standing industrial and scientific experience in aerospace, to the participation with a very significant role in major international Projects and to its favorable location and touristic vocation. In Section 3, specific marketing opportunities are described, along with projected benefits, related to setting up suborbital initiative in the Italian Country. Section 4 elucidates the main selection criteria and requirements categories to be considered in evaluating a site in Italy as candidate Spaceport and Section 5 deals with the selection of specific areas in Italy where sites of interest are located. Section 6 describes a study case outline, relevant to the analysis of a possible suborbital spaceplane tracking approach using Kalman filtering technique based on the observation of the vehicle downlinked signal. Section 7 shows the approach that is currently been pursued in Italy to reach a suitable regulatory framework allowing suborbital flight operations in the Country, basing upon the FAA AST regulatory approach. Section 8 is an outline of which aspects need to be strategically addressed to establish and operate a spaceport, along with the potential associated risks and recommended actions. An overview of possible business models will also be provided therein.

## **2. Why a Spaceport in Italy**

Italy has a very favourable position, pretty much at the centre of the Mediterranean rim with in general acceptable weather condition throughout the Country. Also, the touristic vocation of the Country may play a significant role in attracting potential tourists and to foster the suborbital flight market. The establishment of a suborbital flight capability in the Italian territory may also be a tremendous asset that provide easy access to microgravity experimentation, astronauts and pilots training, and other experimental aerospace activities, like launch of satellites, thus in general enabling the Country as a Gateway to provide access to Space. Many of the Italian candidate sites are located on the coast, which is a big advantage in reducing the environmental risk and improving safety. It is clear that the selection of the most appropriate site should be carried out properly balancing the envisaged benefits (see Section 3) with possible drawbacks.

## **3. Market opportunities and benefits to Italian Economy**

Establishing spaceport and suborbital spaceflight capabilities in Italy will significantly affect the Italian Economy. In general, it will support the emerging commercial space industry, act as a catalyst for the Italian industry, and attract space-related business to the region According to previous studies [4], a market demand of more than 4000 seat-cargo equivalent is expected worldwide for the suborbital reusable flights over ten year time span. The study states [4] that this represents just a baseline case, with the possibility to ramp up to more than 13.000 in an optimistic growth scenario. A significant share of this market demand can be captured by the European/Italian market taking advantage of a suborbital spaceflight initiative based on an Italian Spaceport. Spinoff of suborbital spaceflight operation is the direct and indirect value the Italian Government receives from the initiative. The Italian Government value is driven by tax revenues from the space industry growth and incremental tourism in Italy. It is quite evident setting up an Italian suborbital spaceflight Operator is anticipated to require direct and indirect jobs to support the supply chain and spaceflight operations support services. Spaceport development and construction jobs are supposed to be developed even with participation from the local regional entities and will add significant economic benefits. To understand the types of infrastructure needed to build a Spaceport, it is critical to review the general market areas that commercial suborbital vehicles would likely service: space tourism, microgravity experimentation, astronauts and pilots training, enabling technology demonstration, precursors of

hypersonic vehicles [4] and hardware testing. In the following subsections, an overview of the most promising markets and the associated benefits are reported.

### 3.1 Space Tourism

One of the most promising emerging markets for spacecraft and spaceports is space tourism. Space Tourists can eventually be considered as flight participants; in accordance with the FAA regulations [5], flight participants are individuals, not crew, carried aboard a launch or re-entry vehicle. Space Tourists number is anticipated to significantly grow shortly after vehicles currently under construction begin flying and as soon as early operations mature into more frequent flight rate. Space participants will require flight training, medical support, ground support and other basic amenities, and lodging. The Italian Spaceport shall be able to provide part of such services, while some others can be offered by the surrounding community; in general, the economic impact of relatively wealthy individuals taking exciting once-in-a-lifetime trips from an Italy-based Spaceport holds the potential to be quite substantial towards improving benefits to Italian economy.

### 3.1 Microgravity Experimentation

A potential emerging market for commercial suborbital spaceflight is suborbital science. This represents a significant future market [4]. The scientific fields that have potential benefits include microgravity life sciences, microgravity physical sciences, aeromedical science, health-physics, Earth sciences, astronomy, and planetary sciences.

While traditional parabolic flights in the commercial airspace are intended as preparatory to manned space missions on board the International Space Station and other manned spacecraft [6], the execution of suborbital parabolic flights significantly enhances this capability and enables it to a further range of experimentation. Depending upon the type and frequency of flights conducted for the diverse scientific fields and on the scientific outcome, the demand for this capability could become quite large. Currently, the parabolic flight capability to perform microgravity experimentation in the commercial airspace is offered by different operators and is based upon 22 to 45 seconds of microgravity duration per parabola, depending on the flight envelope of the used aircraft, in particular a modified commercial vehicle or a jet fighter [6],[7]. On the other hand, a typical suborbital flight offers 4 to 6 minutes of microgravity, thus significantly extending the microgravity exposure time. Also, current suborbital spaceflight technologies offer cargo capabilities featuring racks accommodating typical Space Shuttle

middeck lockers or cargo transfer bags, as shown in Fig.4. Microgravity research will for sure be the entry point to suborbital commercial operations, even prior to allowing paying flight participants on board, and the high degree of spaceplanes cabin customization adds significant flexibility to widen the range of research and associated operations, definitely attracting more potential users.

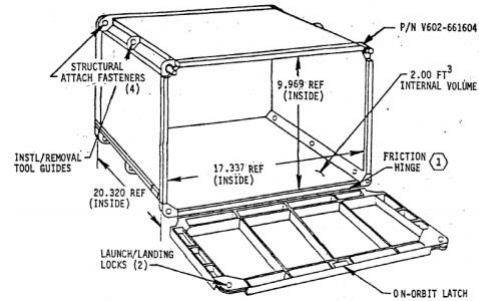

Fig.4: NASA Space Shuttle Middeck Locker Dimensions (Source: NSTS-21000-IDD-MDK)

The Spaceport shall offer adequate infrastructures and services for microgravity experimentation; this includes infrastructures for payloads preparation and integration in the Spaceplane, pre-and post-flight processing, late/early payload integration/de-integration and data gathering facilities, enabling the site to sustain scientific activities at fast pace over multiple, back to back flights.

### 3.2 Astronauts and pilots training

A suborbital spaceflight system mission typically offers a set of diverse conditions in terms of acceleration experienced during the flight. High levels of acceleration are experienced during the ascent and re-entry phases, while some minutes of high quality microgravity are available during the coasting phase of the flight. It is evident that such a set of conditions offers tremendous opportunities for astronauts and pilots training using an asset platform that can typically allow exposure to these conditions with a predicted flight rate of two times a week or more. For instance, astronauts can take advantage of the microgravity offered by suborbital flights to accomplish or simulate operations that they are planning to perform in long duration missions on board the ISS and in preparation to future exploration flights. Additionally, the suborbital flights represent an excellent opportunity to collect medical data on the trainees, that can be integrated and evaluated within the existing space medicine activities and data analysis. A permanent suborbital spaceflight asset in Italy could easily be exploited at European level and can eventually be incorporated within the Institutional astronauts training programs, pending proper agreements. The significant difference with the

parabolic flights in the traditional air-space is the microgravity exposure duration that steps up from tenth of seconds to the range of 4-6 minutes, thus offering extended training time.

### 3.3 Technology Demonstration and Hardware Testing

Another application of suborbital spacecraft is testing hardware under development or in the process of certification for future space missions. The cost of ensuring that such hardware can successfully operate in space or at high altitude can be extremely high. However, there are a number of technology areas where it would be quite economical to fly prototype hardware in the space environment as opposed to performing testing and analysis operations on the ground. This could be a significant market for suborbital vehicles, but will require the support of ground facilities capable of handling the test hardware and the vehicles. This particular application would also likely require additional hangars and other support facilities to modify and assemble components and then integrate them with vehicles as appropriate.

### 3.4 Education

The setup of suborbital flight capability in the Italian territory will also tremendously foster the education in the Country at all levels. Major opportunities will be provided to schools, colleges, universities, research centres to increase awareness and access to space. Relying upon such an asset located 'home' will be triggering additional interest in experimenting new technologies and providing significant scientific advancement. Payloads implementing new ideas and developed within educational institutions may benefit of a quick domestic pathway to access space over multiple missions conducted at high rate.

### 3.5 Economic Benefits

The development of spaceport infrastructure has a variety of benefits for the spaceport itself, the surrounding community, and the industry that will make use of it. Beyond the immediate impact associated with the construction, the infrastructure can attract business to the spaceport, stimulate additional economic impact in the surrounding community, and also support the industry by providing it with the infrastructure needed to serve existing and emerging markets. Funding any infrastructure projects has the most immediate impact by creating construction jobs around the improvement itself. In most cases these types of projects provide a few tens to a few hundred jobs for the duration of construction. Generally, these jobs are located in the immediate area around or on the spaceport with a

more limited impact on the regional supply and manufacturing base.

### 3.5 Impact on Depressed Economic Areas

Due to the need for large open spaces, almost every spaceport is located in a rural and/or underutilized area, which in general may provide incentives for business and allow specific areas to be targeted for economic development.

The more challenging aspect of estimating economic impact is dealing with the potential for long-term growth. Constructing a Spaceport starting from existing sites may more easily lead to reshape underutilized areas; developing suitable Spaceport infrastructures can have a very significant return on the overall economy by the growth of a suborbital initiative and investments by local governments.

### 3.6 Italian Industry return

In Italy specific competencies are available at considerable level of excellence (Industry, Institutions, Universities and Research Centers) that cover the most relevant and enabling aerospace technological areas; some of these have already been exploited and developed in previous and ongoing programs, while some others haven't been applied yet but are able to adequately address future projects. In particular, deep experience was gathered by the Italian Industry throughout its involvement in the ESA IXV project, a technology demonstrator that was injected in a suborbital path by a VEGA rocket after launch from the European Spaceport in French Guyana (see Fig. 5) and successfully accomplished its mission on February 11<sup>th</sup>, 2015. The development and operations of the IXV Ground Segment [8] provided to the Italian Industry opportunity to gather experiences and skills that can be applied to the development of Spaceports infrastructure in the Country, even aimed at the long haul point to point suborbital transportation.

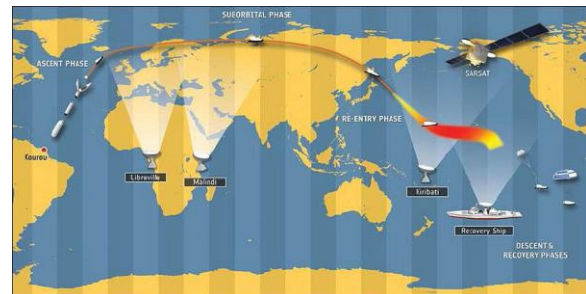

Fig. 5: The IXV mission profile

The setup of suborbital flight capabilities in Italy represents a tremendous opportunity to get the Italian industry involved at different levels and extend its level of excellence to the new challenge of

commercial access to space. The promotion of the spaceflight industry as a mean for generating economic and technological growth within the Italian Country is an aspect of extremely significant importance, even because it may also have positive impact on other fields that do not seem to be related to space as of today. The optimization and reduction of the flight operations cost will constitute over the long haul one of the main keys to success.

#### 4. Spaceport requirements identification

The primary guideline in this paper for the selection of a Spaceport in Italy is to evaluate existing sites and not building new Spaceports from scratch. The selected site has to be compliant with a set of specific requirements that are currently being developed in Italy as applicable to horizontal take-off and landing suborbital operations, where the launch site is in general also the landing site; considering the large number of Spaceport candidate airports in Italy, it might also be considered to evaluate and eventually license more than one site to improve operations flexibility. Over the long haul, the horizontal operations could be a proving ground to VTOL spaceplanes operations.

Once the proper relevant requirements are identified, they will further be refined and applied to the Italian Sites to assess the best match. The described process has to be carried out considering the specific characteristics of the Italian territory, in particular the wide length of coastline and the density of population around the sites of interest. A list of preliminary general Spaceport requirements has already been elicited and reported in [9]. These are currently being reassessed with the purpose of deriving a final set of requirements, officially issued by the Italian Civil Aviation Authority, that a designated Spaceport candidate has to fulfil. Starting with a top level initial evaluation, it can be stated that the Italian Spaceport requirements belong to the set of categories described in the following subsections.

##### 4.1 Air Space

The selected site shall be part of a Radar Controlled Area (Class A, B or C) in order to handle interferences between the suborbital flight activities that require availability of dedicated operating slots and the regular air commercial activity. Anyway airports with low level of commercial air traffic should be preferred. Sub-Orbital Operations shall be conducted within segregated air spaces to insure the safety of the busy airspace users and the population.

##### 4.2 Territorial

The selected site location shall be such to ensure the compliance to required safety levels relevant to both the site and the affected territory. The density of population, in the affected operations areas, shall be sufficiently low relevant to emergency situation that can potentially result in hazards. Distance from the populated areas shall be also evaluated with reference to the take-off & landing direction and the ascent phase. Specific procedures shall have to be put in place, relevant to the Search and Rescue (SAR) to be included within the Safety Management System of that specific site. Safety Management System (SMS) shall be prepared 'ad hoc' by the Spaceport Operator for the specific activities to be carried out. Purpose of the Safety Management System is to put in place a proper organization for the management of all the Safety aspects. The Safety Management System shall properly be documented in a dedicated SMS plan for the specific Spaceport as described in detail in [9] and managed by an appointed Spaceport Safety Manager.

##### 4.3 Safety

Safety is the first aspect to be considered in the identification of the best candidate for the spaceport. In particular, looking at the existing regulations [10], three different aspects should be properly assessed: Expected Casualty, Airport sites boundaries and propellant storage limits. These aspects are briefly addressed in the following Sub-subsections.

###### 4.3.1: Expected Casualty

Referring to FAA, the purpose of the requirement is to ensure that risks to public safety, derived by launch and reentry operations, is limited to an acceptable level, consistently defined with the acceptable launch risk at national ranges. After a series of about 5000 launches, the US Airforce defined the following requirement:

$$E_C < 1 \cdot 10^{-4}$$

Where  $E_C$  is the expected casualty. While the suitability of this requirement to the Italian case needs to be assessed, a proper methodology to carry out a structured analysis of the expected casualty must be set up. A proper formulation for the evaluation of this requirement for a specified vehicle can be derived from the following equation:

$$E_C = \sum_{n=1}^n P_i * A_{C_i} * D_{P_i}$$

where:

$n$  = number of possible catastrophic hazardous events

$P_i$  = probability of the  $i$ th event

$A_{C_i}$  = casualty area related to the  $i$ th event

$D_{P_i}$  = population density related to the area that might be affected by the  $i$ th event.

Fig. 6 shows a flow chart of the activities suggested for the evaluation of the expected casualty.

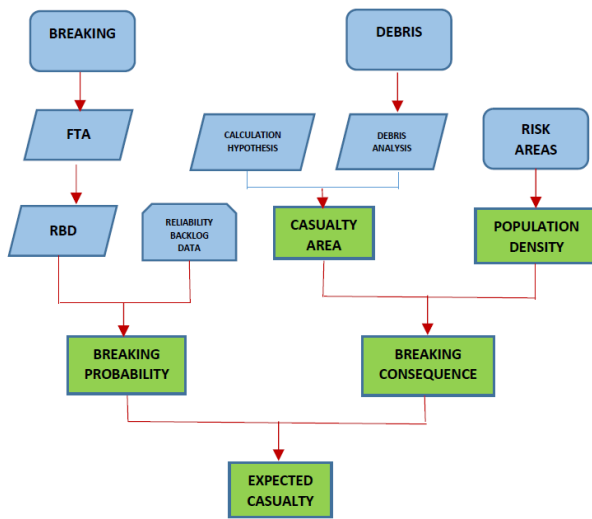

Fig. 6: Expected casualty evaluation flow chart

#### 4.3.2: Launch site boundaries

In the assessment of suitable candidate sites to support suborbital operations, proper areas restrictions shall be evaluated to prevent not-intended people from being damaged from any kind of debris. Fig. 7 shows the process activities flow to perform such evaluation. For this analysis, especially in preliminary simplified evaluation phases, it could be sufficient to identify three different reference debris objects:

- The overall aircraft
- The smallest but heaviest object
- The biggest but lightest object.

The most critical situation should help in the definition of a proper impact area and so, it may be used to evaluate whether the current airport boundaries need to be redefined to allow operations.

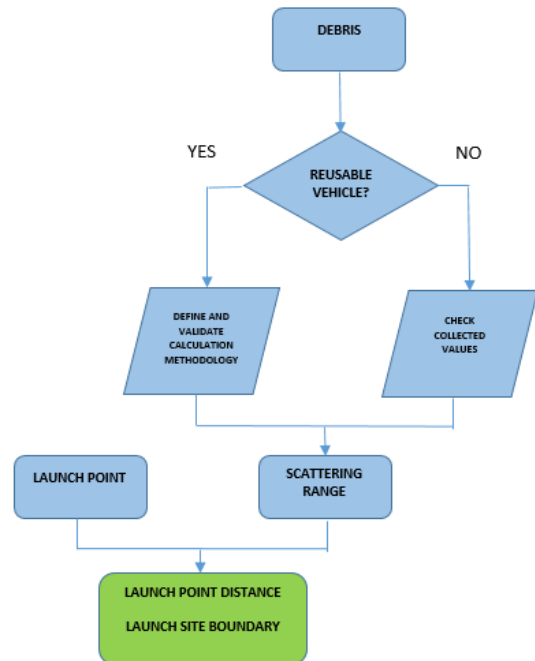

Fig. 7: Spaceport area restriction evaluation flow

#### 4.3.3: Propellant storage

The storage of propellants (i.e. explosive materials) is already regulated and the capability of each site strictly depends on the type of propellant required by the vehicles that are supposed to be operated from that specific site. In particular, the flow chart in Fig. 8 summarizes the major steps for defining the maximum amount of propellant that could be stored within the airport areas, without endangered personnel nor flight participants.



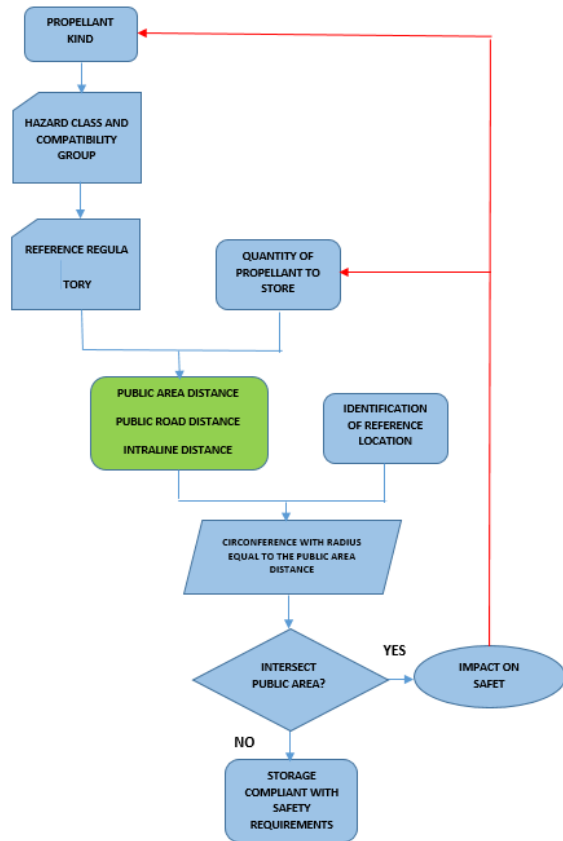

Fig. 8: Maximum propellant storage evaluation flow

#### 4.4 Meteorological

The selection of a site as candidate Spaceport shall take into account the relevant climatic conditions, with special emphasis to the maximum and minimum annual temperatures, humidity, rain, wind and fog. The intensity and orientation of the ground prevailing winds shall be adequate to perform operations. Possibility of crosswinds situation could, in particular, significantly constrain the suborbital operations.

The presence of high altitude wind (Jetstream) occurrences has also to be considered, in particular between 30.480 meters and 60.960 meters. These aspects are also significant on a commercial perspective, since the presence of this meteorological conditions could affect the sub-orbital flight profile. The Weather Service Provider has the responsibility of issuing the weather forecasts for the airports and the airspace under its responsibility.

#### 4.5 Environmental

The site setup and operations shall have to be compliant with the applicable Italian regulations in term of environment. In particular, [11] special focus shall be given to the environmental impacts resulting from operations, such as water and air pollution, perturbation of ecosystems, noise, and presence or

release of dangerous materials. In this context, it has to be noticed that, similarly to safety, the issues related to the environmental impact can be properly assessed only once for one or more reference vehicle, or the fleet that has been selected. Indeed, the air and noise pollution is both dependent on the meteorological conditions of the area surrounding the selected site and the spaceplane itself, especially in view of its propulsion strategy and envisaged exploitation plan.

#### 4.6 Spaceport Access

A close evaluation of the site logistics, in particular of the relevant access ways (roads, highways etc.) shall be conducted to make sure that flight hardware and hazardous materials can safely be transferred into the designated locations at the site. Also, proper intra site transportation shall be considered, which requires appropriate internal roads or rails, to allow correct operations execution and transfer of parts from their assembly facilities. How spacecraft will taxi from their assembly and processing facilities to the launch site or take-off runway is one of the primary engineering and planning decisions, to be undertaken when considering a spaceport. Proper site partitioning shall also be implemented to segregate public access areas from operation zones. All the above aspects shall be assessed well in advance to allow sufficient time to implement adequate infrastructures retrofit.

#### 4.7 Infrastructures and Operations

This category includes several requirements that the candidate spaceport has to comply with to properly support suborbital operations. Some of these criteria shall have to be specific to the selected spaceflight system. The runway length shall be at least 3000 meters located between mean sea level and 155 meters of elevation. Runway lengths is considered the sum of Take-off Runway Available (TORA) and stop ways. This will become an official requirement in the Italian regulatory framework and several commercial sites in Italy are definitely compliant. The referred runway length is relevant to a specific suborbital spaceflight system developer and presumably is compliant with engineering evaluations based on simulations and experimental flights. Actually, Spaceport America has a runway length of 3658 meters. Other infrastructure requirements include accessibility, suitable facilities for propellant storage (located at the proper distance) compliant with the applicable regulatory, a fire extinguishing system suitable with the planned operations. The site shall first of all include properly sized hangars of adequate dimensions to accommodate the vehicles and allow all the necessary pre-flight and post-

flight/turnaround activities, keeping into account that the operating spaceflight system shall be reusable and able to be turned around for the next flight within a short time. The hangars shall feature all utilities like environmental control, power supply, water, shop air as well as the proper facilities to perform any flight vehicles handling and assembly operations. For instance, in case of an air launched spaceflight system (i.e. a two stages vehicle), a proper device shall be incorporated to allow mate and de-mate of the spaceflight to the carrier aircraft. Since a significant part of the suborbital flights will be used for microgravity experimentation, the Spaceport infrastructures shall include specific labs properly outfitted with experiment processing and preparation tools. An adequate clean room shall also be considered in scenarios that encompass the launch of small satellites as part of the Spaceport activities. The Spaceport shall be able to accommodate Ground Support Equipment unique and provided by the selected spaceflight system provider but shall also include equipment like stands and platforms, A7C Jet fueling trucks and tugs. The first commercial phase of spaceflight could leverage existing, publicly-owned and underutilized facilities for private events. Commercial spaceports will need to develop long-stay hostels and facilities for medical observation and training of the new space travelers, as well as tourism and grandstand facilities for public observation of launches and landings.

### 5. Existing airport assessment

Italy has a considerable number of existing airport sites located close to the coastline or inland, spanning from the North to the South of the Country, both civil and military, that show potentially interesting features to act as a spaceport, both for hosting temporary experimental activities and for conducting commercial activities on a regular basis. While the final identification of the Italian Spaceport will be performed by the Italian Civil Aviation Authority (ENAC), it is possible to develop specific technical consideration that can be driving the whole process. Fig. 9 and Fig. 10 show some areas of the Country where possible sites of interest are located. It is important to notice that there may be additional sites that can be showing interest and trigger investments to upgrade their existing infrastructures to match the specific Spaceport requirements. The base assumption is that only horizontal take-off and landing capabilities are considered. Some of these sites are good bases for inland operations, while some others better fit with off-shore activities, especially when air launch spaceplanes are considered.



Fig. 9: Area of possible airport sites in South Italy

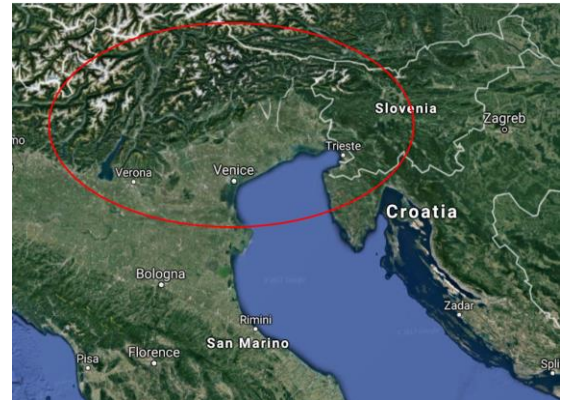

Fig. 10: Area of possible airport sites in North Italy

A set of sites located in the areas indicated by the above figures were preliminary evaluated versus low traffic, runway length capability, existing alternate sites, low density of population in the area, airspace segregation and climate. In general, it can be stated that airports located in the North of the Country feature more calm winds, but are more often affected by fog build up and mostly are located within heavy airway traffic that makes more airspace segregation very difficult. Airports located in the Center and South of Italy definitely offer better year round weather condition, even though winds maybe a factor and a closer assessment will be required. In some cases, specific interest has been shown by local Italian governments in supporting proper local airports improvements and infrastructures implementation to fulfill the Spaceports requirements. In addition, an Italian Spaceport is regarded as an infrastructure to host more than one operator and conduct not only suborbital operations but other specific aerospace experimental activities. The Spaceports identification process will consist of a different levels of screening. The first set of candidate Spaceports will be identified basing upon the experience, taking out the ones that are not believed suitable. With higher probability, certified or certifiable sites within adequate timeframes according to the (EU) 139/2004 Regulations will be considered. The initial selection criteria is related to Meteorology;

further, the density of population is considered; the Italian navigation regulation includes specific risk plans that factor in the density of population in the site vicinity, also including specific future developments. This approach shall have to further be extended to the suborbital operations specific risks, such as the possible falling of debris all along the flight corridors. Then, the Air Space, Routes and Traffic aspects are considered. Also, special emphasis has to be given to the Environmental Assessment, in particular noise and pollution. The environmental assessment will be carried out for the infrastructures and shall be submitted by ENAC to the Ministry of Environment for approval. Only the regular operations will be considered in this perspective, while specific occurrences are factored in within the risk analysis.

In general, the basic approach that will be pursued in Italy is first of all to evaluate the general spaceports requirements and the specific operations scenario relevant to the spaceflight system that will be selected. In the same time, a proper suborbital regulatory framework will be established for both spaceports and operators and as the suborbital regulatory framework will be complete, then the Italian selected site will be identified and possible upgrades will be implemented in preparation to the Spaceport licensing process, managed by the Italian Civil Aviation Authority.

## 6. Tracking System

The development and the potentials offered by the suborbital flights introduce new challenges to the national civil aviation authorities, related to the need of performing constant monitoring of the suborbital spaceplanes position and determining the needed separation between the suborbital and the conventional air traffic. This section describes the evaluation of three passive surveillance tracking systems by the development of an Extended Kalman Filter, able to merge the measurements of each method, individually considered, to obtain a trajectory prediction model that includes the vehicle dynamics. The passive surveillance methodologies implementation represent an adequate compromise between the usage of traditional, uncooperative tracking systems, such as primary radars, and the total dependency of the adopted tracking method from the positioning information transmitted by the spaceplane. The adopted passive surveillance techniques are:

- Time Difference of Arrival (TDOA), often used in terminal Air Traffic Control (ATC) applications [12],[13]. This method relies on the presence on ground of multiple receiving stations, able to associate a timestamp to each

received signal. A master station evaluates all the timestamps, along with the stations position, in order to determine the signal source coordinates on the base of the relative delays among the receiving times of different stations;

- Frequency Difference of Arrival (FDOA), also called “Differential Doppler”. The method is based on multiple cooperating stations able to assess the Doppler frequency shift of a spaceplane signal from the transmitting frequency, which shall be known. From the Doppler frequency shift, it is possible to evaluate the radial speed of the spaceplane with respect to the station position. By evaluating multiple radial speeds from different positions, it is possible to correctly estimate the velocity components of the signal source. With the implementation of a proper trajectory estimator, such a Bayesian or Kalman filter, the position is obtained by integrating the calculated velocity [14];
- A data fusion algorithm including Doppler and angular data, simulating the presence of a single motorized station. This should be provided with the auto-tracking feature that allows its directional antenna to remain constantly pointed at the target throughout its visibility time. Along with the station pointing angles, the method is supposed to evaluate the radial velocity by means of the Doppler shift frequency.

The achieved results on each tracking system architecture evaluation are reported in the following subsections.

### 6.1 Time Difference of Arrival

As reported before, the TDOA tracking depends on the evaluation of time differences among signal receiving times. Therefore, the achievable accuracy on the target position estimation is obviously depending on the stations relative distances and on their average ground distances from the suborbital vehicle trajectory.

A preliminary analysis showed that the best performances are achieved when the stations are located at the same average distance from the spaceplane ground track. Moreover, further analyses have demonstrated how the mean position error on the TDOA tracking decreases when the average distance between the stations and the spaceplane trajectory overcomes 20 km. Therefore, a set of Monte Carlo simulations has been executed on an example network of stations located at 25 km from the vehicle trajectory. The maximum peak of recurrences identifies a mean error of 25.3 m on the position estimation, with a consequent great result in

the spaceplane tracking. However, the installation of a TDOA network would require a precise synchronism among the cooperating stations, with a consequent increase of the system operations costs.

### 6.2 Frequency Difference of Arrival

The potential achievements of the FDOA tracking technique application to suborbital flights is influenced by the predominant vertical direction of such vehicles flight path. Indeed, since the FDOA stations are in charge of measuring the radial speed of the vehicle with respect to the station position, a quasi-vertical trajectory would result in a high correlation among the measurements of stations at ground. A great opportunity is offered by the potential development of a stratospheric platform equipping a FDOA receiver, whose different altitude would highly influence the performed measurements and their correlation with the ground-based stations data.

A preliminary analysis on the mean achievable error on the spaceplane position estimation has led to the conclusion that a great average distance is needed to reach sufficient mean error values in the suborbital vehicle tracking. In particular, the error remains at mean and maximum error values namely higher than 1500 and 3000 meters when considering average ground distances that are lower than 300 km. However, elementary link budget considerations on the spaceborne and FDOA antennas, whose pattern are mostly omni-directional, suggest how the defined distance is excessive when compared to the usual radiated power rates of aircraft and spacecraft antennas. Therefore, the conducted analyses on the FDOA technique shows how this method is hardly suitable for suborbital vehicles tracking, when admitting most part of the stations located at ground level.

### 6.3 Single motorized station

The definition of a single motorized station, able to measure the pointing angles and the Doppler frequency shift of the received signal, yields preliminary considerations on the station staging. These have been related to the Italian civilian and military airports currently considered as suitable as spaceport candidate. The staging analysis has been performed only to better describe the performances and features of the developed EKF when applied to the station measurements.



Fig. 11: Grottaglie airport mission profile map

The suborbital flight profile location has been selected by considering several design drivers, including a sufficient separation average distance between the spaceplane ground track and the coast line, and the selection of a flight heading possibly parallel to the nearby coast lines, in order not to guide the vehicle towards the coast, with a consequent risk of performing the spaceplane re-entry phase over ground and populated areas, or away from the coast lines, with the dangerous possibility to terminate the spaceflight phase of the mission at distances that would not allow a vehicle return to the departure spaceport.



Fig. 12: Decimomannu airport mission profiles map

The first analyzed infrastructure is the Grottaglie Airport, located in Apulia, Italy. Two suborbital mission profiles have been analyzed, namely over the Adriatic and Ionian seas. The tracking station was assumed located at the spaceport in both the analyzed cases. Fig. 11 shows the produced mission profile for the Grottaglie spaceport study case. The orange areas represent the mission profile phases that appear out of the coverage of the nearby ATC services, while the “T” flag indicates the tracking station. The red lines

represent the station lines of sight at the initial and final simulation times.

A Monte-Carlo simulations set has been executed separately for each study case, demonstrating the high suitability of this tracking method for the considered suborbital mission. The maximum peak of recurrences of the mean error values equal 257 and 135 meters, namely for the Adriatic and Ionian sea cases.

The second considered air field is the Decimomannu military airport, located in Sardinia, Italy. As for the first case, two mission profiles have been calculated on the Eastern and Western Sardinian coasts. Due to the military nature of the considered infrastructure, the Eastern profile is assumed tracked by a station installed on another military base, located in Perdasdefogu (Province of Nuoro). The mission profiles map are shown in Fig. 12.

The Monte-Carlo simulations reveal a mean error maximum peak of recurrences of 179 meters and 277 meters, namely for the Eastern and Western coast profiles.

To conclude, the motorized station application provides adequate tracking accuracy levels, with a relatively simple system architecture, relying on the presence of a single station. Moreover, the station could be applied also for the telemetry down link, in addition to the tracking purposes.

## 7. Approach to regulatory framework in Italy

Italy is currently lacking a regulatory backbone that allows Suborbital Flight Operation in the Country. The renewal in 2016 (see Fig. 13) of the 2014 Memorandum of Cooperation on Commercial Spaceflight between FAA and ENAC and its extension to ASI, allowed very significant interaction between the two Countries on the matter and led to a the possible definition of an approach based on considering the FAA regulatory system as a reference to adapt to the Italian case.



Fig. 13: Signature of the FAA/ASI/ENAC MOC

This would obviously imply adding specific Italy unique requirements, for instance relevant to the environmental protection. In [9], special emphasis has been given to possibility of adapting the FAA Regulatory approach to the Italian case (in particular FAA 14 CFR part 420, License to operate a launch site). The goals of the definition of a national regulatory system should be related to allow the national development in the suborbital flight capabilities, grant safety of the areas affected by suborbital flight and critical ground infrastructures, air space users, occupants, and protection of environment. In addition, allow a smooth and seamless transition to the future International regulatory frame (EASA and ICAO/UNOOSA) to facilitate long term investments. In general it can be stated that the near term objectives of an Italian suborbital regulatory workframe is to allow international suborbital spaceflight systems to operate in Italy, while gaining specific experience to face the relevant challenges associated with an unexplored pathway. Assuming the FAA regulatory system as the initial reference, integrated with the Italian specific national requirements related to the existing Country legal and regulatory framework, the approach is the validation of the licenses and flight permits released by FAA matched to the Italian case. The Spaceport and or alternate sites would be licensed by ENAC after assessing the site compliance to the relevant requirements that have also to include operator-specific features. The main aspects affected by the regulatory workframe are:

- Criteria for risk analysis related to flight operations
- Air space management procedures
- Spaceport requirements
- Environmental protection related to noise, emissions, hazardous propellants
- Medical requirements for crew and occupants
- Insurance aspects
- Informed consent assessment, as used in the USA

A significant advantage of this approach is the mitigation of the issues related to the ITAR that considers a spaceplane with rocket engine as an armament and consequently subject to the US Department of State authorizations. At a certain point in the regulatory evaluation process a specialized inter-government agreement will be needed to address the various aspects.

## 8. Spaceport operations strategy considerations

The general goals of a Spaceport and the relevant potential impacts have been discussed earlier in this paper. When it comes to starting a commercial spaceflight initiative, in general it can be stated that

Spaceport operations can possibly be managed by a company that uses an infrastructure owned by a different public or private entity.

If we consider operations and infrastructures as a whole aggregation, business and local development goals interact to one another and are partially overlapped. Let us consider with the term spaceport the whole aggregation.

Then, first and foremost, the spaceport must generate enough business activity and commerce revenue to cover operational expenses, accommodate new growth, and provide funds to continue to maintain the spaceport [15].

The second strategic goal for the spaceport is to drive local job and population growth and create in the regional economy with greater demand for goods, services and skilled workforce.

The third major strategic goal for a spaceport is to deliver efficient and effective services to all customers, whether commercial launch tenants, governmental research and development clients, or visiting guests.

In terms of market sectors, a spaceport can have four addressable markets of opportunity in the next future: commercial space, government space, tourism, and education. In regards to these market sectors, the following considerations should have to be kept in to account [15] on the relevant strategies and risks:

a) Commercial Space:

The major risks concern the following issues:

- Slow growth of commercial space industry
- Export Control and International Traffic in Arms Regulations (ITAR) compliance
- Lack of robust Space Flight Informed Consent legislation

In terms of strategies, the spaceport management should consider to:

- Diversify customer base
- Network and participate in industry to acquire customers
- Incentivize selected customers
- Promote upgrade of Space Flight Informed Consent legislation

b) Government Space:

The major risks concern the following issues:

- Uncertainty of government funding
- Export Control and International Traffic in Arms Regulations (ITAR) compliance

In terms of strategies, the spaceport management should consider to:

- Develop agreements with ASI and ESA (and other space agencies)

- Develop business relationship
- Strength government space advocacy
- Hire ITAR consultant to draft procedural guidelines

c) Tourism:

The major risks concern the following issues:

- Sluggish economy
- Lack of local tourism community readiness
- Underfunded and/or poorly marketed visitor experience

In terms of strategies, the spaceport management should consider to:

- Attract visitors worldwide bundling space experience offer with local available attractions
- Develop supporting infrastructure for visitor experience
- Generate a profit from visitor services
- Hire world-class visitor experience development contractors
- Increase outside investment with pre-opening partnerships
- Plan and execute strong grand opening program
- Encourage local community preparation for space tourism

d) Education:

The major risks concern the following issues:

- Lack of coordination with related existing educational services and programs
- Lack of public education support for field trips
- Poorly targeted activities, materials and interpretive content for students and teachers

In terms of strategies, spaceport management should:

- Attract more young visitors
- Develop strong spaceport education and workforce development plan
- Develop robust internship/co-op program, supporting many interns
- Host many student-focused events per year
- Engage world-class learning professionals
- Develop education and workforce annual fund
- Incentivize student and teacher attendance through targeted admission pricing

- Coordinate with pre-existing programs and organizations
- Provide professional development resources to teachers

On the local development perspective, the spaceport could impact in different ways. Based on [16], the regional effect of operating a spaceport can be associated to the following types of industrial districts: hub-and-spoke, state-anchored, and satellite platform.

In the hub-and-spoke industrial district, a number of key firms and/or facilities act as anchors or hubs to the regional economy, with suppliers and related activities spread out around them like spokes of a wheel. The dynamism in hub-and-spoke economies is associated with the position of this anchor organization in the national and international markets, while other local firms tend to have subordinate relationships with it.

In the state-anchored industrial district, a public or nonprofit entity, that is a military base, a defense plant, an university, or a concentration of government offices, is a key anchor tenant in the district. Here, the local business structure is dominated by the presence of such facilities, whose localization decision and economic relationships are determined in the insitutional realm, rather than by private-sector firms.

This type of district is much more difficult to theorize, as specific contingencies related to the involved activity may affect its operations and characteristics.

Finally, the satellite platform industrial district is a congregation of branch facilities of externally based multi-plant firms. Often these are assembled at a distance from major conurbations by national governments or entrepreneurial local governments as a way of stimulating regional development in outlying areas and simultaneously lowering the cost of business for competitively squeezed firms bristling under relatively high urban wages, rents, and taxation.

Tenants of satellite platforms may range from routine assembly functions to relatively sophisticated research, but they must be able to more or less “stand alone”.

It seems clear that depending on the specific actors and related role they will play in the spaceport, different models of development can be affordable. Strength and weakness issues are then associated and will need to be evaluated. The approach that will be pursued in Italy is currently in discussion and may be based on one or a combination of the above described industrial districts.

## 9. Conclusions

The identification and outfitting of a suitable Spaceport in Italy for suborbital operations appears to be very promising considering the long time experience of the Italian Industry in Aerospace and the favourable geographic location, weather conditions and touristic vocation of the Country. Significant Italian and European market opportunities might be captured by establishing such capabilities, ranging from microgravity experimentation, to astronauts and pilots training to technology demonstration. A strong impact on education and research is also expected. The setup of suborbital flight capabilities in Italy represents a tremendous opportunity to get the Italian industry involved at different levels and extend its level of excellence to the new challenge of commercial access to space. Activities are going on to develop a detailed set of Spaceport requirements, which will lead the Italian Civil Aviation Authority to identify the most suitable site. Spaceport requirements will be integrated within a regulatory framework in the Country that will support the execution of suborbital operations, guaranteeing the required level of Safety. A Spaceport must be equipped with proper infrastructures to support all the planned operations and in particular shall feature adequate tracking capabilities for the specific spaceflight system that will operate at the designated site. In the perspective of suborbital flights being conducted at a regular flight rate, whenever the proper technical maturity will be reached by the available technologies, constant monitoring of the suborbital spaceplanes position shall be ensured such to guarantee the needed separation between the suborbital and the conventional air traffic. Specific techniques based on implementation of a Kalman filtering approach appear to perform quite well, yet require further in depth analysis in the future. The strategic approach associated to an Italian Spaceport and relevant operations is currently under evaluation; major strategic goals include generating adequate business activities and revenues, driving local and national economy and obtain relevant customers satisfaction.

## References

- [1] Spaceport America Business Plan 2016-2020, Bringing the future to present-  
www.spaceportamerica.com
- [2] Oklahoma Space Industry Development Authority-Gateway to Space-  
www.airspaceportok.com
- [3] F. Santoro, A. Bellomo, A. Bolle, R. Vittori: the Italian Spacegate: study and innovative approaches to future generation transportation based on high altitude flight, 64<sup>th</sup> International Astronautical Conference, Beijing China 2013
- [4] A 10 years forecast of market demand, Tauri Group, Federal Aviation Administration Office of Commercial Space Transportation and Space Florida
- [5] FAA Code of Federal Regulations-Title 14-Chapter III, Subchapter A-Part 401.5-Definitions
- [6] V. Pletser, S. Rouquette, U. Friedrich, J. F. Clervoy, T. Gharib, F. Gai, C. Mora. Parabolic Flight Campaigns in Europe with the Airbus A300 Zero G: An Evaluation of the Scientific Outcome, 67<sup>th</sup> IAC Congress. Jerusalem, 2015
- [7] M. Studer, G. Bradacs, A. Hiliger, E. Hurlimann, S. Engeli, C. S. Thiel, P. Zeitner, B. Denier, M. Binggeli, T. Syburra, M. Egli, F. Engelmann, O. Ullrich. Parabolic maneuvers of the Swiss Air Force fighter jet F-5E as a research platform for cell culture experiments in microgravity.
- [8] F. Santoro, J. M. Gallego Sanz, G. Billig, A. Bellomo, G. Martucci, M. Rabaioli, The IXV Ground Segment as an initial approach to the support of commercial suborbital missions
- [9] F. Santoro, A. Del Bianco, R. Fusaro, V. Albino, M. Binetti, F. Moretti, Advances in Italian Spaceports identification as Infrastructures for suborbital flight activities and mission profiles
- [10] FAA Code of Federal Regulations-Title 14-Chapter III, Subchapter C-Part 420.21-License to operate a launch site
- [11] Final Environmental Assessment for the Launch and Reentry of SpaceShipTwo Reusable Suborbital Rockets at the Mojave Air and Space Port, May 2012
- [12] Vasyliiev, V. M., Vasyliiev, D. V., Naumenko, K. V., "Using data of multilateration surveillance system for aircraft tracking", presented at the 4<sup>th</sup> International Conference on Methods and Systems of Navigation and Motion Control (MSNMC), Kyiv, Ukraine, 18-20 October 2016
- [13] Galati, G., Gasbarra, M., Leonardi, M., "Multilateration algorithms for time of arrival estimation and target location in airports", presented at the First European Radar Conference (EURAD), Amsterdam, The Netherlands, 14 October 2004  
Battistelli, G., Chisci, L., Fantacci, C., Farina, A., Graziano, A., "A new approach for Doppler-only target tracking", presented at the 16<sup>th</sup> International Conference on Information, Fusion, Istanbul, Turkey, 9-12 July 2013
- [15] New Mexico Spaceport Authority, Strategic Business Plan 2013-2018, January 2013
- [16] Markusen, A. (1996) Sticky places in slippery space: A typology of industrial districts, *Economic Geography*, 72, pp. 293-313