

The effects of digital predistortion in a CO-OFDM system – a stochastic approach

Original

The effects of digital predistortion in a CO-OFDM system – a stochastic approach / Sime, Jacqueline E.; Morel, Pascal; Younes, Mohamad; Stievano, Igor S.; Telescu, Mihai; Tanguy, Noel; Azou, Stephane. - In: IEEE PHOTONICS TECHNOLOGY LETTERS. - ISSN 1041-1135. - ELETTRONICO. - 32:13(2020), pp. 763-766.
[10.1109/LPT.2020.2994892]

Availability:

This version is available at: 11583/2830799 since: 2020-06-30T18:46:40Z

Publisher:

IEEE

Published

DOI:10.1109/LPT.2020.2994892

Terms of use:

This article is made available under terms and conditions as specified in the corresponding bibliographic description in the repository

Publisher copyright

IEEE postprint/Author's Accepted Manuscript

©2020 IEEE. Personal use of this material is permitted. Permission from IEEE must be obtained for all other uses, in any current or future media, including reprinting/republishing this material for advertising or promotional purposes, creating new collecting works, for resale or lists, or reuse of any copyrighted component of this work in other works.

(Article begins on next page)

The effects of digital predistortion in a CO-OFDM system – a stochastic approach

Jacqueline E. Sime, Pascal Morel, Mohamad Younes, Igor S. Stievano, Mihai Telescu, Noël Tanguy, and Stéphane Azou

Abstract—Digital predistortion is topic of significant interest in telecommunications – both in the wireless radio field and, more recently, in photonics. In the present letter, the authors undertake a sensitivity analysis of various digital predistortion algorithms. Using recent metamodeling techniques designed for efficient stochastic analysis, the authors show that using predistortion not only leads to a reduction of the error vector magnitude in general but can also make the system less sensitive to uncertainties.

Index Terms—Optical communication, digital predistortion, stochastic analysis, CO-OFDM, Semiconductor Optical Amplifier

I. INTRODUCTION

Linearization has been widely explored in telecommunications. It is based on common sense engineering – if a signal propagates through a nonlinear channel, transmission quality may be improved by compensating the channel’s nonlinearity with an inverse function. In the case of digital predistortion (DPD) the strategy consists in numerically altering the signal on the emitter side according to a well-chosen algorithm. Doing so minimizes the impact of the transformations the signal suffers from before being decoded on the receiver side. Digital predistortion has first come to the attention of researchers and engineers working in radiofrequencies, particularly in wireless applications, and has been subject to significant interest in recent years [1]. With the development of optical access and metropolitan networks and the race for high data throughputs at affordable costs, digital predistortion has also become a topic of investigation for the optical communication community.

The scenario considered in this paper is that of a link implementing Coherent Optical Orthogonal Frequency Division Multiplexing (CO-OFDM) and using Semiconductor Optical Amplifiers (SOAs) as boosters for access or metropolitan networks. The context of CO-OFDM and multi-carrier modulation was found promising and is still being explored as it allows for more resilience toward dispersion, simplicity in frequency equalization and dynamic allocation of bandwidth [2]. The added solution of introducing the SOA has been investigated as a possible way to achieve very high data-rates at moderate costs [3]. In this context, the use of DPDs becomes even more appealing. Indeed, unlike in the case of passive

networks or networks using fiber amplifiers, dealing with SOAs implies facing significant nonlinear effects. Recent publications highlight this issue and compare different DPD techniques [4]. Note that higher launch powers and the accumulation of multiple channels bring fiber nonlinearities. However, the scope of this paper is to send an appropriate waveform into the fiber by compensating transmitter nonlinearities coming mainly from amplifiers but also modulators.

Any communication system is affected by intrinsic uncertainties due to manufacturing tolerances, environmental conditions, and calibration imperfections which can have significant impact on overall system performance. Some of the authors conducted a robustness analysis in a previous publication [4] and showed that even when some of the parameters related to the SOA or the modulator drift from their nominal values, DPD continues to be beneficial with some DPD algorithms performing better than others.

The paper provides new insight by modeling the uncertain nature of the system via probabilistic models; a method that has proven useful in other fields (see [5] and the references therein) is the Polynomial Chaos Expansion (PCE). The present letter investigates predistorter sensitivity by performing a full stochastic analysis, thus accounting for the simultaneous fluctuation of several system parameters. Note that although the context of this letter is multicarrier modulation, this analysis is also relevant in other scenarios (e.g. non-constant envelope in single carrier).

II. CO-OFDM IN METROPOLITAN AND ACCESS NETWORKS

The scenario considered throughout this paper is illustrated in Fig. 1. The input bit stream undergoes M-QAM modulation then is coded into 32 OFDM frames (bandwidth of 5 GHz) composed of $N_{sc} = 128$ subcarriers among which 11 are nulled at DC and both extremities to avoid laser and adjacent channels interferences, respectively. The constant length time signal is obtained through an IFFT and includes a cyclic prefix amounting to $\frac{1}{8}$ of the duration of each OFDM frame. The constructed signal is hard-clipped at a 6 dB ratio. Follow the standard digital-to-analog conversion and electro-optic conversion includes a laser diode and an IQ modulator. The SOA in this configuration acts as a booster. The receiver includes a reference laser, photodetectors and trans-impedance amplifiers. Once the received signal is converted back to the electrical domain, it undergoes synchronization and is subsequently demodulated.

This paper looks more specifically into the effects of uncertainties present in the parameters shown in Fig. 2. The IQ modulator is comprised of two Mach-Zehnder modulators (MZMs) operating at null point with driving peak-to-peak voltages (V_{pp}) of $1.25 \times V_{\pi}$ and a phase difference ϕ between its two branches of $\frac{\pi}{2}$. The SOA is supplied by a 150 mA bias current (I_{bias}). Considering uncertainties in these variables goes beyond their external uncertainty and can also mimic variability induced in component manufacturing. For instance, a change in the SOA’s active region length affects the SOA gain; similarly so, a change in I_{bias} will also affect the SOA gain.

Manuscript received XX XX XXXX

Jacqueline E. Sime, Stéphane Azou and Pascal Morel are with the École Nationale d’Ingénieurs de Brest, Lab-STICC, CNRS, UMR 6285, CS 73862 – 29238, Brest Cedex 3, France (e-mail: jacqueline.sime@enib.fr, stephane.azou@enib.fr, pascal.morel@enib.fr).

Mohamad Younes, Mihai Telescu and Noël Tanguy are with the Univ Brest, Lab-STICC, CNRS, UMR 6285, F-29200 Brest, France (e-mail: mihai.telescu@univ-brest.fr, noel.tanguy@univ-brest.fr).

Igor Simone Stievano, Politecnico di Torino, Dipartimento di Elettronica e Telecomunicazioni, 10129 Torino, Italy (e-mail: igor.stievano@polito.it).

The optical fiber is considered ideal in this scenario as the focus of this paper is the effects of the amplifier and the modulator. These effects are to be compensated by the predistorter block.

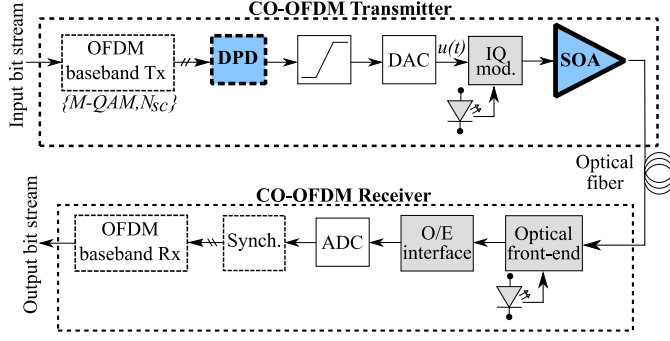

Fig. 1. CO-OFDM transmission system with DPD and SOA blocks

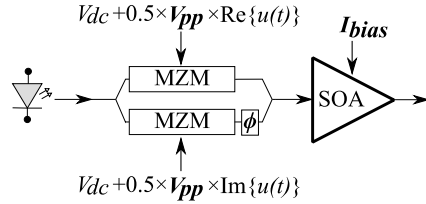

Fig. 2. IQ modulator and SOA blocks

III. DIGITAL PREDISTORTION TECHNIQUES

The idea behind predistortion is to consider the device under test (DUT), in the present case the MZMs combined with the SOA, as a nonlinear function causing some undesirable effects on the signal. An inverse nonlinear function is introduced into the system to counteract the DUT's effects.

There are two possible approaches to predistorter identification: direct learning and indirect learning [1]. The latter casts the problem as a rather standard case of parametric identification which does not require analytic inversion. Of course, the choice of the parametric structure is instrumental and requires some form of educated guess. In the present paper, indirect learning was used with the optimization criterion being the normalized mean square error (NMSE) between the OFDM time signal at the emitter and at the receiver after synchronization.

Selecting the predistorter structure is significant and this topic is explored extensively [1]. Since photonics deal with high data rates compared to RF, low complexity algorithms should be a priority. Some structures that are simplified, lower complexity versions of the Volterra series have already proven worthy in photonics while meeting these high data rates constraints. Memory polynomials (MP) are one example. The input-output relation for the MP is given by

$$y_{MP}(n) = \sum_{k=0}^{K-1} \sum_{l=0}^{L-1} a_{kl} x(n-l) |x(n-l)|^k \quad (1)$$

where the nonlinearity order and the memory depth of the model are represented by K and L respectively. Another structure, which looks solely at the envelope of the signal, is the envelope memory polynomials (EMP). It was found to be more effective than the MP and this seems to be in line with the physics of the SOA (i.e. carrier density depends mostly on the input envelope). The EMP is defined by

$$y_{EMP}(n) = x(n) \left(c_0 + \sum_{k=1}^{K-1} \sum_{l=0}^{L-1} a_{kl} |x(n-l)|^k \right). \quad (2)$$

More recently, in the RF field in particular, a structure that encompasses both the MP and the EMP has been proposed: the

generalized memory polynomials (GMP). To the authors' knowledge the present letter is the first attempt to use it in photonics. The output of the GMP is obtained by

$$y_{GMP}(n) = \sum_{k=0}^{K_a-1} \sum_{l=0}^{L_a-1} a_{kl} x(n-l) |x(n-l)|^k + \sum_{k=1}^{K_b} \sum_{l=0}^{L_b-1} \sum_{m=1}^{M_b} b_{klm} x(n-l) |x(n-l-m)|^k + \sum_{k=1}^{K_c} \sum_{l=0}^{L_c-1} \sum_{m=1}^{M_c} c_{klm} x(n-l) |x(n-l+m)|^k \quad (3)$$

with K_a , K_b and K_c being the nonlinearity orders, and L_a , L_b and L_c , and M_b and M_c being the memory depths.

It is important to choose the appropriate structural parameters (all orders of nonlinearity and memory depths) in the identification of predistorters. Indeed, it is possible to find a compromise between efficiency (minimum NMSE) and complexity (number of coefficients) through them. The Hill-Climbing algorithm used in this paper is a simple and automated way to select these parameters without exploring all combinations [6]. As the structural parameters are searched, the coefficients of the DPDs are calculated using least squares. The coefficients associated with the parameters that correspond to the best compromise are then preserved.

IV. POLYNOMIAL CHAOS EXPANSION

Once the efficiency of the DPD algorithms has been evaluated, it is useful to look into performing an uncertainty analysis. Indeed, in practical scenarios several variables will conjointly stir away from their nominal values thus changing the system's behavior. A widely used method to carry out this type of analysis is Monte Carlo (MC) simulation which comes at a great computational cost. A proposed solution to that problem is the Polynomial Chaos Expansion (PCE).

A. General Concept

The idea behind PCE is to take a random vector $\mathbf{X} \in \mathbb{R}^N$ composed of independent components with specific probability distributions and model their outcome, a random variable Y assumed to have finite variance, through the polynomial expansion

$$Y = \mathcal{M}(\mathbf{X}) = \sum_{\alpha \in \mathbb{N}^M} z_{\alpha} \Psi_{\alpha}(\mathbf{X}) \quad (4)$$

where \mathcal{M} designates a computational model, z_{α} are the coefficients associated to the multivariate, orthonormal polynomials Ψ_{α} which form a basis of the Hilbert space. α contains ordered lists of integers such that $\alpha = (\alpha_1, \dots, \alpha_M)$ and is associated with Ψ_{α} through

$$\Psi_{\alpha}(\mathbf{X}) = \prod_{i=1}^M \psi_{\alpha_i}(X_i) \quad (5)$$

where ψ_{α_i} are the univariate polynomials chosen according to the distribution of X_i . Table I shows the advised polynomials for a variable with uniform distribution.

TABLE I
Legendre Polynomial Basis for a maximum degree of 3

ψ_{α_1}	$\psi_0 = 1$	$\psi_1 = \frac{X_1}{\sqrt{1/3}}$	$\psi_2 = \frac{3X_1^2 - 1}{2\sqrt{1/5}}$	$\psi_3 = \frac{5X_1^3 - 3X_1}{2\sqrt{1/7}}$
-------------------	--------------	-----------------------------------	---	--

In the case of real-life applications, it is necessary to reduce the space α to a set \mathcal{A} by limiting the total degree of a multivariate polynomial $|\alpha| = \sum_{i=1}^M \alpha_i$ to a degree p (usually of degree 3 to 5). Several truncation schemes are proposed in [7] including standard truncation.

The coefficients can be calculated either by means of orthogonal projection or least-square minimization. The latter is of more interest

to this paper; its definition is given by

$$\mathbf{z} = \underset{\mathbf{z} \in \mathbb{R}^{card, \mathcal{A}}}{\operatorname{argmin}} \mathbb{E} \left[\left(\mathbf{y} - \sum_{\alpha \in \mathcal{A}} z_{\alpha} \psi_{\alpha}(\mathbf{X}) \right)^2 \right]. \quad (6)$$

Experimentally, $\mathbf{X} = \{\mathbf{x}^{(1)}, \dots, \mathbf{x}^{(n)}\}$ is a sample set of points that can be obtained through different sampling schemes. In order to estimate the coefficients, the communication chain is simulated for each point in \mathbf{X} and stored in a vector $\mathbf{y} = \{\mathcal{M}(\mathbf{x}^{(1)}), \dots, \mathcal{M}(\mathbf{x}^{(n)})\}$. Note that as a rule the size of \mathbf{X} should be two to three times bigger than the number of terms in the series (4).

In addition to restraining the computed series through a truncation scheme, it is also possible to add sparsity to the problem notably in the case of high degree and high number of parameters of (4) and (5). In practice, some terms are deemed more useful than others and several coefficients end up getting computed despite their nearly non-existent contribution [7]. A penalty term $\lambda \|\mathbf{z}\|_1$, where $\|\mathbf{z}\|_1 = \sum_{\alpha \in \mathcal{A}} |z_{\alpha}|$, can then be added to (6) to give priority to low rank solutions.

Once the coefficients are found and the PCE model is fully constructed, it is then possible to get the probabilistic content of the quantity of interest. Note that despite some of the earlier assumptions the algorithm has been successfully tested with correlated input variables and a vector as the quantity of interest [7].

B. Application for Optical Transmission

Considering the scenario illustrated in Section II, PCE permits to look at how the uncertainties of V_{pp} , ϕ , and I_{bias} seen in Fig. 2 affect a quantity of interest such as the Error Vector Magnitude (EVM).

As there is no a priori knowledge on the distributions of these variables, they are assumed to have uniform distribution and thus Legendre polynomials are used as basis functions. Considering a standard truncation scheme with $p=3$, the reduced series has 20 terms according to TABLE I and (5).

The experimental design $\mathbf{X} = \{\mathbf{x}^{(1)}, \dots, \mathbf{x}^{(50)}\}$ is generated through Latin hypercube sampling (LHS) which is a method found to be computationally cost efficient and representative of the real variability of a system as it visits all regions of a cumulative density function that has been divided into equiprobable regions [8].

Fifty simulations are then run and the vector \mathbf{y} containing the corresponding EVM values is used to compute the coefficients. This is done through a sparse least-angle regression whose basic concept is to limit the model's complexity by removing the polynomials with least impact [7].

V. RESULTS

This segment illustrates the scenario portrayed in Section II where the optical transmission block features a 750 μm INPHENIX-IPSAD1501 SOA with a gain of 18 dB, an alpha factor of 3.3 and a noise figure of 9 dB. The simulation framework based on MATLAB and ADS was already validated experimentally [9][10] and is known to be very reliable. The UQLab toolbox was used for the stochastic analysis [11]. Note that the process is non-intrusive, i.e. MC simulations and the PCE are introduced as an outside layer which envelops the already existing simulation code.

The following cases are scrutinized for a fluctuation in V_{pp} , ϕ , and I_{bias} : no DPD, MP, EMP, and GMP. The same superframe constituted of 32 OFDM frames is used throughout the whole analysis in order to keep the results meaningful and avoid introducing undesired uncertainty due to the OFDM signal itself. Note that extensive investigation confirms that the conclusions presented hereafter hold regardless of the emitted sequence.

A reliability analysis is first performed on the no DPD case for a 4-QAM signal sent at a reference input power for the SOA $P_{ref} = -14$ dBm. A PCE model for the EVM is first constructed from 50 simulation runs. Then, the EVM values of 10^4 MC runs and the values of the PCE model evaluated using the same experimental design are compared as depicted in Fig. 3. It is shown from this figure that the PCE model mirrors the MC representation very well and is therefore reliable in further analysis. The models for the other cases are then validated as well but on a smaller scale.

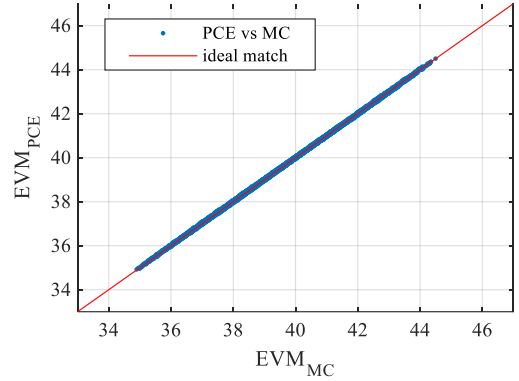

Fig. 3. Polynomial Chaos Expansion comparison with Monte Carlo simulations for the no DPD case for a 4-QAM configuration at $P_{ref} = -14$ dBm. It can be seen from Table II that PCE saves 200 times more simulation time compared to MC and once the PCE model has been constructed, the time to evaluate 10^4 points is negligible.

TABLE II
MC vs. PCE simulation times

	No of runs	Total time
Single run	1	141.5 s
MC analysis	10^4	1,415,000 s (16.4 days)
PCE model construction	50	7075 s (2 h)
PCE analysis	10^4	0.5s
PCE vs MC speedup ratio	200	

Probability density functions (PDF) are then estimated with the PCE models of all cases (no DPD, MP, EMP, GMP) at different levels of uncertainties and are shown in Fig. 4. There are two noteworthy observations to draw: a horizontal translation and a vertical stretch. The horizontal translation proves that the average EVM improves with predistortion with all predistorters meeting an EVM objective of 30% [12]. This entails that a higher input power to the SOA could be used signifying more reach. The vertical stretch more interestingly illustrates the improvement in terms of variance with the steepest curve demonstrating more robustness to the uncertainties. All DPDs show improvements with respect to both. Note that the better the DPD, the closer the output EVM is to a minimum threshold mostly caused by the SOA ASE noise and the clipping which is highlighted by the asymmetry seen for EMP and GMP. Fig. 5 confirms these observations by looking at a 2D-histogram of the QAM symbols received after 100 simulations. The population density of the QAM symbols is color coded from dark to bright (lowest to highest density). While the constellation is scattered at first, it is more concentrated in the GMP case which has the brightest constellation. It can be seen from the same figure that EMP shows some phase noise in its constellation. This seems consistent with the EMP structure.

Another uncertainty analysis is performed for a 16-QAM signal with $P_{ref} = -17$ dBm. An acceptable EVM for that scenario is in the 16% range [12] therefore it is safer to lower the SOA input power even though it also lowers the reach. Higher modulation formats call for more stringent material requirements so a $\pm 5\%$ uncertainty

seems reasonable. Fig. 6 shows that although the MP is not able to consistently pass the threshold set for an acceptable transmission, the GMP and the EMP meet the requirements. However, Fig. 6 also reiterates the results found in the 4-QAM case as once again the GMP improves both the average EVM and the robustness to the uncertainties to the best extent. In Fig. 7, the GMP is shown to have the better QAM symbol distribution and concentration.

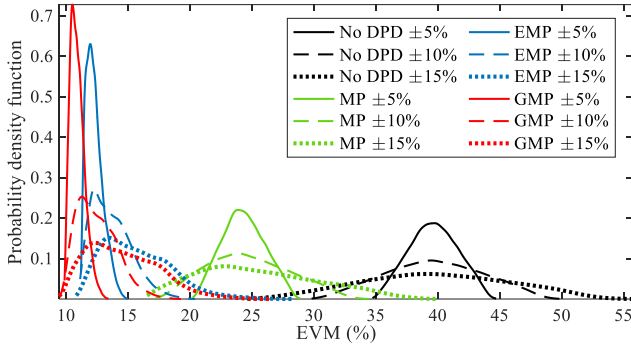

Fig. 4. PDF of DPDs for a 4-QAM configuration at $P_{\text{ref}} = -14$ dBm

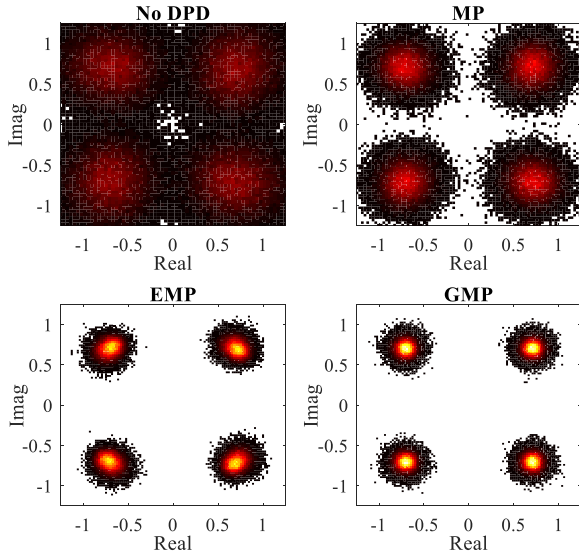

Fig. 5. 2D-histogram of a 4-QAM constellation at $P_{\text{ref}} = -14$ dBm

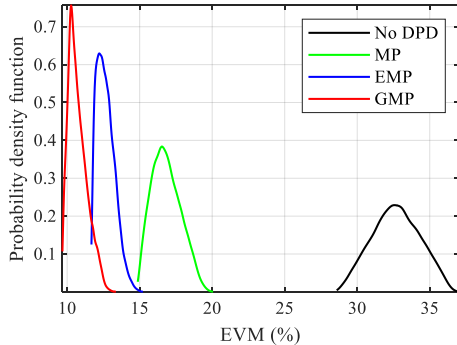

Fig. 6. PDF of DPDs for a 16-QAM configuration at $P_{\text{ref}} = -17$ dBm

VI. CONCLUSION

In the present letter, stochastic analysis is used to study the effects of different DPD algorithms in optical communications systems using an SOA. The approach is made possible by the use of the PCE technique which avoids the huge computational cost of MC simulations. The results show that not only does DPD compensate nonlinearities in a deterministic sense but by improving channel linearity it also significantly reduces the impact of system uncertainties on overall performance. While this conclusion seems

intuitive, the paper quantifies the improvement and allows ranking of the different DPD algorithms with GMP performing best in terms of average EVM, but also in terms of robustness.

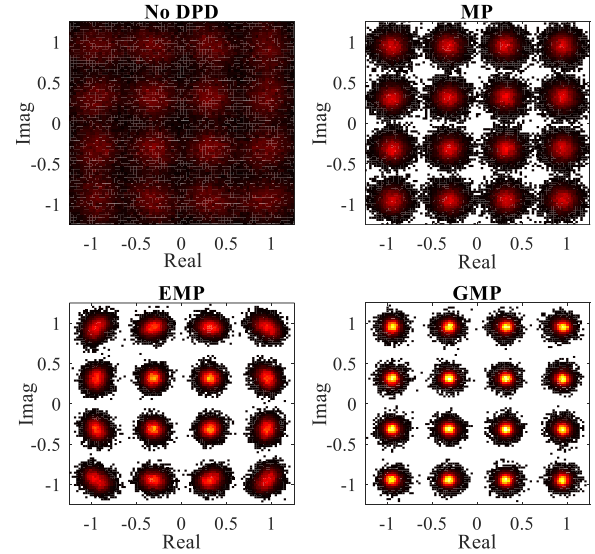

Fig. 7. 2D-histogram of a 16-QAM constellation at $P_{\text{ref}} = -17$ dBm

REFERENCES

- [1] F. M. Ghannouchi, O. Hammi, and M. Helaoui, *Behavioral Modeling and Predistortion of Wideband Wireless Transmitters*, 1st ed. Chichester, UK: Wiley, 2015.
- [2] O. Vassiliev, I. Kim, T. Oyama, S. Oda, H. Nakashima, T. Hoshida, and T. Ikeuchi, "Reach extension with 32- and 64 GBaud single carrier vs. multi-carrier signals," *IEEE OFC*, Los Angeles, CA, USA, pp.1-3, 2017.
- [3] G. Talli, C. Antony, M. Power, P. Townsend, "SOA-based Metro-Access Coherent Transmission Systems" *CLEO*, San Jose, CA, USA, pp. SM4G-1, 2019.
- [4] C. Diouf, M. Younes, A. Noaja, S. Azou, M. Telescu, P. Morel, N. Tanguy, "Robustness analysis of a parallel two-box digital polynomial predistorter for an SOA-based CO-OFDM system," *Opt. Commun.*, vol. 402, pp. 442-452, Nov. 2017.
- [5] P. Manfredi, D. V. Ginste, I. S. Stievano, D. De Zutter, and F. G. Canavero, "Stochastic transmission line analysis via polynomial chaos methods: an overview," *IEEE Electromagn. Compat. Mag.*, vol. 6, no. 3, pp.77-84, Nov. 2017.
- [6] S. Wang, M.A. Hussein, O. Venard, and G. Baudoin, "Optimal sizing of generalized memory polynomial model structure based on hill-climbing heuristic," *IEEE 46th EuMC*, London, UK, 2016, pp. 190-193.
- [7] B. Sudret, "Polynomial chaos expansions and stochastic finite element methods," in *Risk and Reliability in Geotechnical Engineering*, Boca Raton, FL, USA: CRC Press, 2014, ch. 6, pp. 265-300.
- [8] McKay, M.D., Beckman, R.J. and Conover, W.J., "Comparison of three methods for selecting values of input variables in the analysis of output from a computer code," *Technometrics*, 21(2), pp.239-245, 1979.
- [9] H. Khaleghi, P. Morel, A. Sharaiha, and T. Rampone, "Experimental validation of numerical simulations and performance analysis of a coherent optical-OFDM transmission system employing semiconductor optical amplifier," *J. Lightw. Technol.*, vol. 31, no. 1, pp. 161-170, Jan. 2013.
- [10] S. Bejan, S. Azou, P. Morel, M. Telescu, N. Tanguy, and A. Sharaiha, "A joint linearization/companding approach for improving a CO-OFDM Transmitter," *IEEE Photon. Technol. Lett.*, vol. 27, no. 20, pp. 2162-2165, Oct. 2015.
- [11] S. Marelli, and B. Sudret, "UQLab: A framework for uncertainty quantification in Matlab," *Proc. 2nd ICVRAM*, Liverpool, UK, 2014, pp. 2554-2563.
- [12] R. Schmogrow, B. Nebendahl, M. Winter, A. Josten, D. Hillerkuss, S. Koenig, J. Meyer, M. Dreschmann, M. Huebner, C. Koos, and J. Becker, "Error vector magnitude as a performance measure for advanced modulation formats," *IEEE Photonics Technol. Lett.*, vol. 24, no. 1, pp. 61-63, Oct. 2011.