

Inductive power transfer for automotive applications: State-of-the-art and future trends

Original

Inductive power transfer for automotive applications: State-of-the-art and future trends / Cirimele, Vincenzo; Freschi, Fabio; Mitolo, Massimo. - ELETTRONICO. - (2016), pp. 1-8. (Intervento presentato al convegno 52nd Annual Meeting on IEEE Industry Application Society, IAS 2016 tenutosi a USA nel 2-6 ottobre 2016) [10.1109/IAS.2016.7731966].

Availability:

This version is available at: 11583/2661200 since: 2020-06-26T12:12:14Z

Publisher:

Institute of Electrical and Electronics Engineers Inc.

Published

DOI:10.1109/IAS.2016.7731966

Terms of use:

This article is made available under terms and conditions as specified in the corresponding bibliographic description in the repository

Publisher copyright

(Article begins on next page)

Inductive power transfer for automotive applications: state-of-the-art and future trends

Vincenzo Cirimele, IEEE Student Member
Fabio Freschi, IEEE SM
Department of Energy – Politecnico di Torino
corso Duca degli Abruzzi, 24 10129 Torino, Italy
Email: *name.surname@polito.it*

Massimo Mitolo, IEEE SM
Engineering Systems Inc. (ESI)
26632 Towne Centre Drive, Foothill Ranch, CA, 92618
Email: *mitolo@ieee.org*

Abstract—The paper discusses the status of the development status of the inductive power transmission for automotive applications. This technology is, in fact, gaining the interest of electric vehicle manufacturers as an effective strategy to improve the market penetration of electric mobility. Starting from the origin of this technology, the paper presents an overview of the current state-of-the-art as well as the current research and industrial projects. Particular attention is devoted to the description of a prototypal system for the dynamic inductive power transmission whose goal is to extend the battery range by a fast partial recharging during the movement of the vehicle.

Index Terms—Wireless power transmission, inductive power transmission, electric vehicles, resonant systems.

I. INTRODUCTION

Electricity is a very common vector to convey energy, and its wireless transmission has been of interest of researchers for centuries. Remarkable examples are Faraday’s experiments on electromagnetic induction and energy transmission through fluids in 1832 [1], the applications of the radio frequencies communications investigated by Hertz in 1895 [2], and the Tesla’s experiments on the wireless electric energy transmission at long distances [3] in 1904. In the last decades, the scientific community has defined as *wireless power transmission* (WPT) the different ways to transfer energy at distance without wires. Today this definition covers several technologies in a wide range of applications, power and distances. Fig. 1 schematically shows the most common technologies for WPT involving electromagnetic fields [4]. WPT technologies seem to represent an effective way to reduce the problems of costs and management of the batteries installed on electrical vehicles (EVs) eliminating the major barrier to the electro-mobility diffusion. In this paper, the authors provide a review of a particular technology in the domain of WPT called *resonant inductive power transmission* (IPT) for the charge of electric vehicles.

II. THE RESONANT INDUCTIVE POWER TRANSMISSION

The two fundamental principles that govern the IPT are the Ampère’s law of 1820 and the principle of magnetic induction discovered by Faraday in 1831. While Ampère proved that a current can produce a magnetic field, Faraday showed that a time-varying magnetic field interacting with an electrical circuit can induce into it an electromotive force.

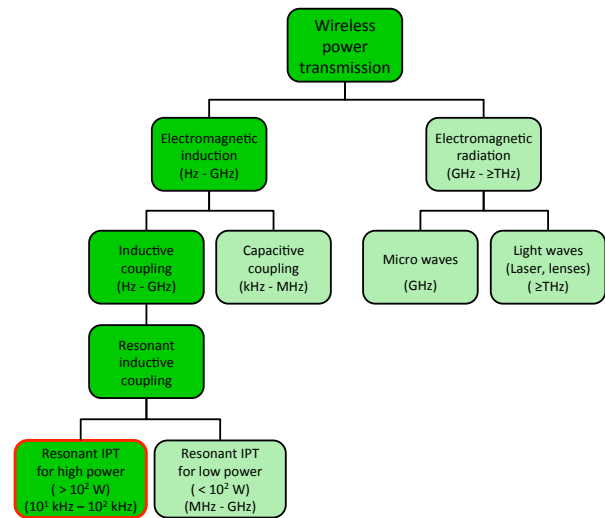

Fig. 1: Different methods for the WPT using electromagnetic fields and waves. The red frame indicates the technology investigated in this work.

These two laws allowed countless applications, and led the development of the modern electric machines. Tesla coined the definition wireless power transmission [5], and presented a contactless system at the World Exposition of Chicago in 1893. Seven years later Tesla obtained the patent for an apparatus for the wireless transmission of electrical energy over long distances using inductors, in which he identified two important parameters of the inductive transmission [6]:

- 1) the increase of frequency to improve the power transfer capability.
- 2) the use of capacitors (i.e. a Leyden jar in the Tesla’s prototype) connected to the coils to create a resonant system and improve the effectiveness of the transmission.

A functional block diagram of an IPT system for EVs is depicted in Fig. 2. It basically consists of the inductive coupling between a coil above or below ground, defined as the transmitter, and a movable coil placed under the vehicle, defined as the receiver. The transmitter is powered through a power electronics converter, which provides a high-frequency current, and a high-frequency field; the field couples with

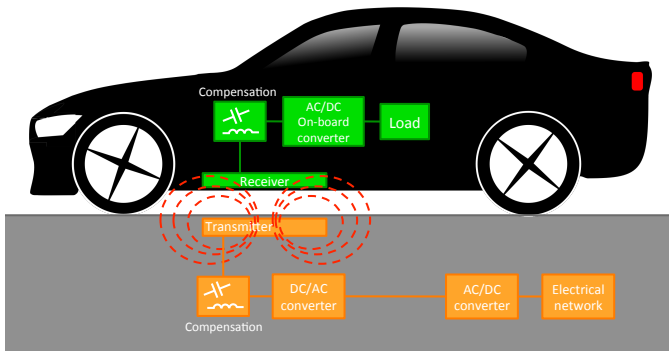

Fig. 2: General block diagram of an IPT system for electric vehicles.

the receiver, and allows the wireless transfer of electrical power. Downstream the receiver, a rectification stage converts the signal to dc, which allows the battery of the vehicle to be charged. In general, ferromagnetic, conductive and other auxiliary materials are added to the coils, and the ensemble is defined as a pad. Thanks to the absence of electrical contacts, the transmitter and receiver of an IPT system are independent. This feature can lead to the absence of external installations with the recharge process that can start automatically when the vehicle is over the transmitter, without any human interaction. This arrangement remarkably increases the safety of the operations, and reduces the possibility of vandalism. In addition, the system is inherently protected against environmental conditions (e.g. water, dirt, chemicals etc.). The absence of electrical contacts eliminates the typical problems of electrical erosion and dust deposition, reducing the maintenance costs and providing a more robust system with a longer life cycle. This technology, defined as static because the vehicle is parked during the charge, will most likely substitute the conductive systems. However, the absence of mechanical constraints opens to the possibility of the inductive transfer during the motion of the vehicle, which is the dynamic IPT. The installation of dynamic IPT systems into the road infrastructure would eliminate the necessity of stops for the vehicle charge and, consequently, lead to a possible reduction of the on-board battery capacity. A successful implementation of the dynamic IPT would improve the acceptance of electric vehicles, and solve the most critical aspects in their use. A third possible use of the IPT is the *stationary* or *en-route static* IPT, during which the charge takes place during the stops of the vehicle during the trip, e.g. the stops at the traffic lights. This case represents an intermediate way between the static and the dynamic IPT, as the vehicle alignment with the receiver cannot be accurate, however the vehicle position is practically stable.

A. The dawn of the power electronics

The first real application of the IPT arrived from the soviet electrical engineer Georgiy Babat, who in 1943 built an electric car, named HF automobile supplied through IPT. The system was composed by copper tubes buried under the



Fig. 3: Cross-section of the buried transmitter and the on board receiver of the PATH prototype [10].

asphalt, and a receiver placed under the vehicle at about 20 cm from ground. The system was supplied through an electron-tube oscillator [7] providing a current of hundreds of amperes with a frequency of 50 kHz. The induced current was rectified and used to directly supply a 2 kW motor. This first prototype had only 4% efficiency, but it was the first working implementation of an IPT system for electric vehicles [4]. The first IPT system with solid state devices appeared in 1974 [8], and it used thyristor inverters with a nominal current of 2000 A and frequency of 10 kHz. The resonance of the receiver was assured through series connected capacitors, and a rectifier supplied a dc motor. This design was abandoned in the same year [9]. In the 1980s, a first working IPT system with a moving vehicle was designed within the project PATH in California [10]. The goal of the project was the development of a segment of an electric roadway to inductively power of a small electric bus. The system operated with a variable air-gap between 5 cm and 10 cm, and provided a power of 200 kW through a maximum current of 2000 A generated by an electric machine working at the fundamental frequency of 400 Hz. To control the power transmission, variable capacitors were employed to detune the receiver resonant frequency. The achieved efficiency was of about 60%, but the prototype presented different critical aspects, such as bulky and heavy pads: the receiver was 4.5 m long and 1 m large with a mass of 850 kg [9] (Fig. 3). In the 90s the massive interest of researchers and industries in the IPT technology started due to the improved performance of the power electronics devices at frequencies above the tens of kilohertz, with currents between tens and hundreds of amperes. At the end of the last century, the dissemination of IPT systems for the charge of hybrid and electric busses began. In 1997, the German Wampfler AG, implemented a first commercialized IPT system for public transportation based on patents developed by the Auckland University [11], [12]. This system was conceived to charge stationary busses, and the technology was commonly named static IPT. For the charge to be effective, the receiver needed to be aligned with the buried transmitter, and lowered to the distance of about 4 cm (Fig. 4); to this purpose, a camera was placed under the vehicle. Electric buses wirelessly charged during parking, in a completely automated fashion, operate in Genoa and Turin since 2002 [13]. The Wampfler system operates at a frequency of about 15 kHz with a rated current of

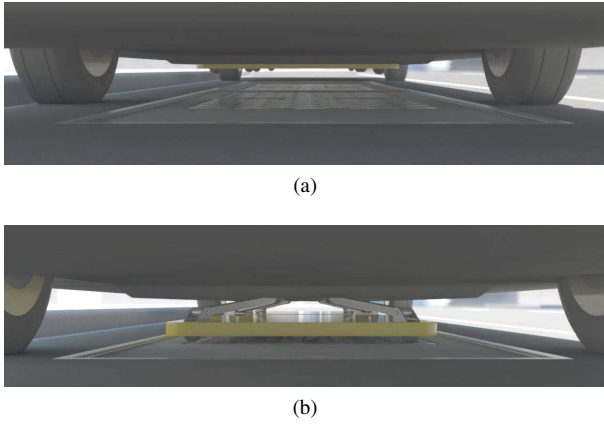

Fig. 4: Position of the receiver in the Conductix system. Receiver up (a), receiver down during the charge (b) [14].

80 A, transmitting a rated power of 30 kW. The small air-gap between transmitter and receiver guarantees a good magnetic coupling and reduced stray fields. Wampfler continued to work on these applications of the IPT as Conductix, and in January 2014 it spun off as IPT Technology.

III. STATE-OF-THE-ART

In the recent years, several companies and research centers have proposed their own systems to improve the electric mobility through the IPT. WAVE, a startup born within the Utah State University, commercializes its IPT technology for the recharge of electrical busses. The first prototype was implemented in a campus shuttle equipped with a receiver having the same dimensions as the transmitter embedded in the pavement of the bus stops. This system allows the transfer of 25 kW at 20 kHz at each bus stop. The power transfer takes place over an air-gap of 15 – 25 cm obtaining an efficiency of 90% [15]. Bombardier has recently announced the development of a suite of solutions for IPT involving busses, light commercial vehicles, and private cars called PRIMOVE. The implementation of the PRIMOVE IPT system for electric busses is ongoing in the cities of Mannheim and Berlin (Germany), and in the city of Bruges (Belgium). With this system, the transferring to the bus of a power of about 200 kW occurs during its stop [16]. The only working IPT system currently operating is the shaped magnetic field in resonance (SMFIR) system developed by the Korea Advanced Institute of Science and Technology (KAIST) since 2009. The SMFIR concept is based on the use of a massive quantity of ferrite to confine the flux into a defined path (Fig. 5). This concept was applied to the OLEV (online electric vehicle) bus in 2011 and, currently two OLEV busses are active in the KAIST campus in the cities of Daejeonn and Gumi, both in South Korea [18]. As shown in Fig. 6, the system is composed by a roadside power conversion stage that rectifies the power received by the electrical network and supplies the buried power tracks (i.e. transmitters) at the frequency of 20 kHz. The road embedded power tracks are installed in sections of

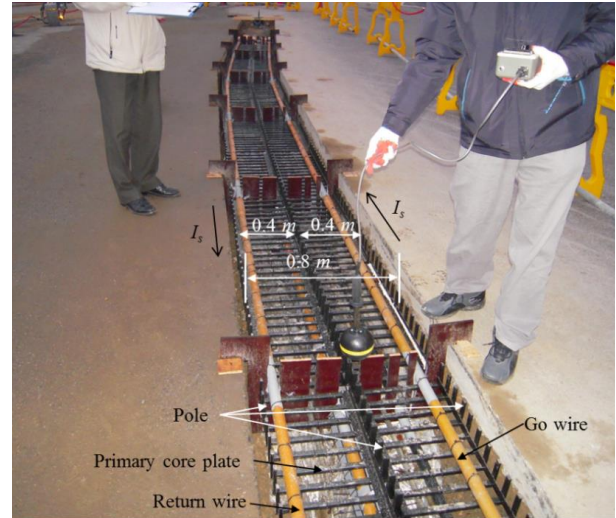

Fig. 5: Ferrite track of the OLEV system embedded in road [17].

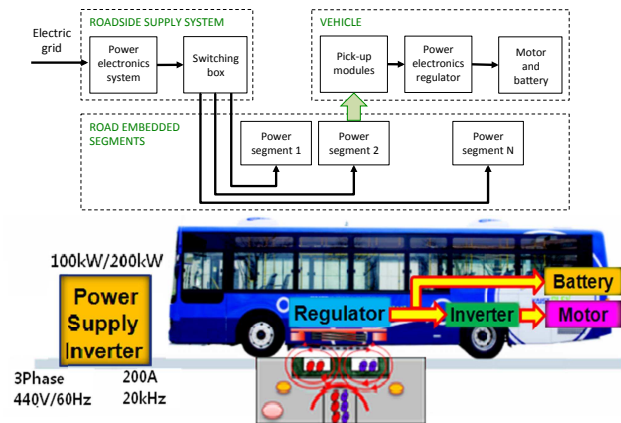

Fig. 6: Scheme of the architecture of the OLEV bus IPT system [17].

122.5 m in length, and each section is divided into segments, whose length can range from 2.5 m to 24 m [18]. A system of complex active and passive shielding solutions is installed on the bus, with the purposes of confining the magnetic field along the desired path, improving the electromagnetic compatibility (EMC), and reducing the electromagnetic field emissions. An example of shielding system is depicted in Fig. 7, where a series of copper twisted brushes is used to create a closed conductive shielding path [19]. KAIST developed different versions of OLEVs. The last one (3G) reached a maximum power transfer of about 200 kW with an efficiency of 74% [20]. In the automotive sector several products for the static IPT will be soon available in the market. In 2011, Qualcomm acquired HaloIPT, a New Zealand company spun off by the University of Auckland. The HaloIPT developed IPT solutions in a power range between 3.3 kW and 20 kW, and in 2011 became partner with Rolls Royce, which proposed the IPT technology to charge the luxury Phantom EV [21]. A spin off

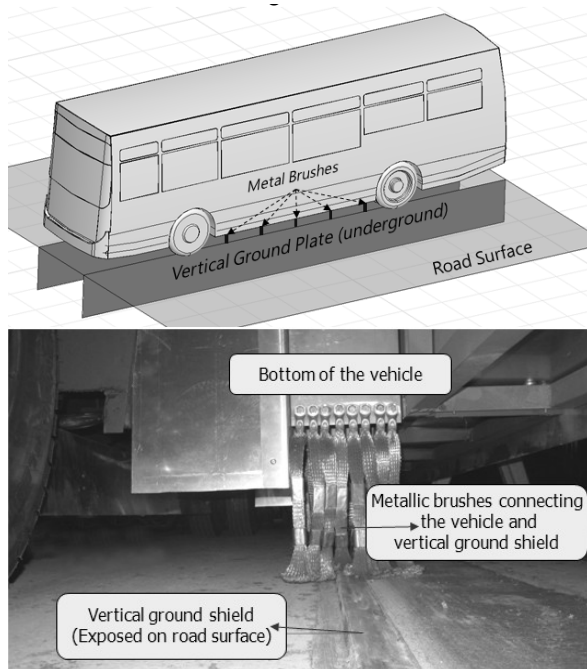

Fig. 7: Illustration of a passive shielding solution applied to the OLEV bus [19].

of the Massachusetts Institute of Technology (MIT), WiTricity, that develops wireless power transfer systems for various industries and applications, also proposes a solution for the static IPT. A 3.3 kW system has been proven to be functional, but it is not yet commercially available. However, Toyota has licensed the WiTricity wireless system and started trials and verification tests for their Electric and Hybrid models [22]. Another product available in the market is the Plugless Power, a 3.3 kW IPT stationary charger developed by Evatran and commercialized in partnership with Bosch. It consists of a system adaptable to each EV model, with a transmitter system composed of a control panel containing the power electronics directly linked into the electrical LV network, and a transmitter pad that can be placed on the floor. The Plugless Power were successfully tested with the Chevrolet VOLT and the Nissan Leaf EVs [23].

IV. RESEARCH PROJECTS

To respond to the necessity of additional investigations about the broad aspects of the dynamic IPT, dedicated research projects are being conducted thanks to both public and industry funding. While the University of Auckland and the MIT are trying to extend their static applications technologies to include the dynamic IPT with their spin offs HaloIPT and WiTricity, other research centers and universities are involved in joint projects all over the world. In the United States, the Oak Ridge National Laboratory (ORNL) is greatly investing in IPT research. The ORNL has carried out research on static and dynamic inductive power transfer, and is presently developing know-how on coupling coil design, power flow



Fig. 8: Picture of the laboratory prototype developed at ORNL [25].

regulations, leakage field minimization, misalignment tolerance and interoperability [24]. The ORNL focuses on the use of a single power electronics stage that supplies the different transmitters (as done by the KAIST), determining the relative position of the vehicle by a radio communication system coupled with optical sensors as backup verification. Transmitters and receiver coils are constituted by the same circular pad [25] (Fig. 8). At the same time, the KAIST is developing the sixth generation of OLEV, by improving efficiency with new solutions for the transmitter section layout and the design of the receiver [14]. In the European Union, a series of research project are being founded to investigate possible improvements of the electric mobility by developing solutions for the inductive charge. The projects Fastincharge and UNPLUGGED, both born in 2012, have investigated the impact of different charging solutions (i.e. plug-in, static and dynamic IPT) on the public acceptance of the electric mobility. In both projects different solutions for the static inductive charge have been proposed, based on economic feasibility, safety and standardization; an analysis of the expansion of these solutions toward the dynamic IPT was also performed [26], [27], [28]. Both projects demonstrated a good efficiency about 90% of two different static IPT solutions in condition of perfect alignment between transmitter and receiver together with the communication between the different components of the charging infrastructure. These results indicated as the use of IPT can really represent an effective way to overcome the actual problems related to range and size of the on-board storage.

At the end of 2012, the eCo-FEV project began [29]. eCo-FEV intended to create an electric mobility platform for the integration of electric vehicles into a cooperative infrastructure. This platform would allow the communication

between multiple infrastructure systems, including road IT infrastructure, parking infrastructure, public transportation operators and vehicle charging infrastructure; this would assist user on trip planning, decreasing range anxiety (i.e. the fear that the electric vehicle has insufficient power to reach its destination). The results of the project proved the functionality of the proposed architecture for the integration of the EVs into different infrastructures, to create a cooperative network capable to provide precise telematic services, and charging management service based on real time data.

In Spain the researches on the IPT are continuing through the project Victoria [30]. The project started in 2013 with a consortium that comprises different industrial and academic partners. The aim is to double the range of electric buses without affecting operating times adopting IPT in static and dynamic developing a solution directly applied on an bus in the city of Malaga.

V. STANDARDIZATION PROCESS

IPT systems, as electric vehicles, involve several fields of engineering, therefore the related technical standards and guidelines must include many different view points. As pointed out in the previous section, several commercial stationary IPT technologies exist, but most of them are not compatible with each other, due to the absence of standards when they were developed. Nevertheless, there are several active groups working now to standardize stationary wireless charging systems. The U.S. Society of Automotive Engineers (SAE International), a globally active professional association and standards organization for engineering principally focused on transport industries, provides the standards SAE J2954 and UL 2750 [31], and pairs them to other related standards as SAE J2847/6, SAE J2931/6 and SAE J2836/6 [32]. SAE published a Technical Information Report (TIR) J2954 for *Wireless Power Transfer for Light-Duty Plug-In/ Electric Vehicles and Alignment Methodology* for stationary charging applications on 2016 that is planned to be standardised within 2018 [33]. The International Electrotechnical Commission (IEC) has created in the 90s the subcommittee TC69 that is working on a dedicated standard for electric vehicles equipped with IPT systems, which is intended to be published as IEC 61980. The IEC 6190 reached the Committee Draft stage in 2000 and, since 2013 the standards has been in a “circulated as committee draft with vote” phase [14] and his “Part 1: General Requirement”, is now in the Publication being printed (BPUB) state [34]. ISO started his activities on a new ISO standard, the ISO/AWI PAS 19363, in February 2014 [35]. The group responsible for the drafting is subcommittee TC22/SC2 “Road Vehicles-Electrically propelled Road Vehicles” [36]. The main activities of the different standardization committees can be summarized as follows:

- vehicle alignment methods;
- interoperability of the different solutions;
- frequency and power levels;
- location of the receiver or receivers in the vehicle;

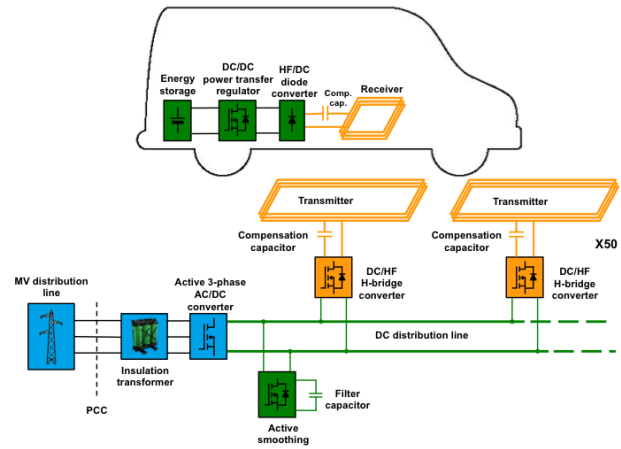

Fig. 9: Electrical infrastructure for the dynamic IPT proposed by the team of the Politecnico di Torino.

- different aspects of safety, such as obstacle detection, electric shock protection, reference standard for the magnetic field levels, EMC;
- communication protocols between power grid, vehicle and IPT infrastructure;
- testing of the solutions.

Despite the fact that IPT technologies evolve very fast, there are no published standards on IPT for automotive applications at the present. The same is also true for dynamic IPT. On this aspect, the IEEE Standards association industry connection activity has recently approved a working group for the pre-standardization, with the goal to be a complement to the activities of the SAE J2954. This is currently the only group working on dynamic IPT [37].

VI. A PROPOSAL FOR AN INTEROPERABLE DYNAMIC IPT

Starting within the eCo-FEV project, the team of the Department of Energy of the Politecnico di Torino, Italy, developed a first prototype for the dynamic IPT for a light commercial vehicle consisting of five transmitters installed in cable wireways placed over the road (Fig. 10) supplied by a single six-pole inverter [38]; the vehicle presence was identified solely through optical sensors. This system has been tested only for a limited power and limited speed, but has provided important data regarding the management of the charging infrastructure in the presence of a complex environment, which includes electric vehicles, energy providers and data infrastructure [39]. The goal of the research activities of the POLITO group is the development of an IPT solution applicable to light commercial vehicles. The target is private transportation companies that interact with public urban infrastructure as well as private charging spots. The system is oriented to the large scale market and includes an IT infrastructure for the communication and management of the billing. This research is now continuing under the FABRIC project [40], [41]. FABRIC started in 2014 as a systematic feasibility analysis of different on-road charging technologies for the range extension of electric vehicles.



Fig. 10: First prototype of a dynamic IPT system for a light commercial vehicle within the eCo-FEV project (Italy).

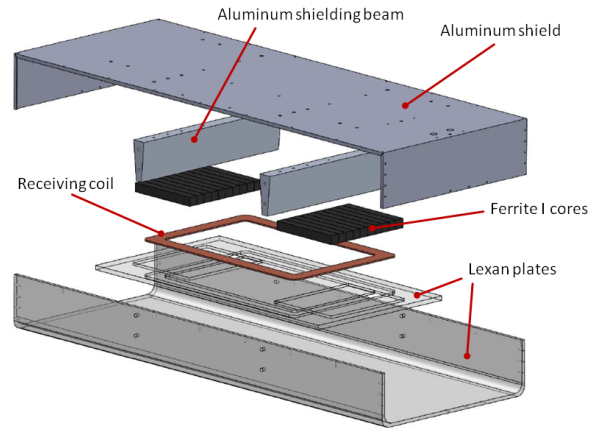

Fig. 11: 3D model of the receiving structure.

The architecture developed by the team of the Politecnico di Torino in the framework of the project, called charge while driving (CWD), is shown in Fig. 9. It consists of a series of 50 transmitters 1.5 m long and 50 cm large with an interspace of 50 cm. In contrast with the solution proposed within eCo-FEV, in the FABRIC system, each transmitter is supplied by a dedicated dc/ac H-bridge converter with a nominal power of 20 kW working at 85 kHz. The operating frequency has been chosen to keep the compliance with the SAE standard J2954 as a base for future interoperability between static and dynamic systems. The system is directly connected to the LV distribution network through an ungrounded insulation transformer that electrically separates the utility three-phase distribution system from the IPT, allowing a dedicated IT system [42]. This solution guarantees the continuity of the power supply also after a first ground-fault without compromising the safety of the operators. The IT grounding system was chosen as the protection against indirect contact in TN systems¹ [42] is challenged by the presence of active converters. In the case of ground-faults, in fact, converters positively reduce the fault current to nearly their nominal current, to protect their circuitry. This limitation of the current would prevent overcurrent protective devices from promptly tripping, exposing persons to the risk of electric shock. A three-phase ac/dc converter provides for a 630 V stabilized dc distribution line that supplies the dc/ac (i.e. direct current to high frequency alternate current) converters forming a distributed dc link. Aboard the vehicle, a dc/dc converter is connected between the diode rectification stage and the battery to effectively manage the power being received. The receiving coil is part of a structure designed to maximize the coupling and minimize the stray field outside the vehicle, so that to be in compliance with the ICNIRP restrictions on human exposure [43], [44]. The receiving structure therefore also plays the role of a shield whose role is to confine the magnetic field in a defined volume under the vehicle (Fig. 11) . The

¹Systems in which the neutral point of the power supply system is grounded, and enclosures of equipment are connected by a protective conductor to the main grounding bus of the installation, which is connected to the grounded point of the power supply.



Fig. 12: Back of the vehicle during the CWD operation. Under the vehicle plane is visible the receiving structure mounted.

receiving structure is mounted on the rear of the vehicle with the addition of supports to guarantee mechanical robustness and protection against vibrations (Fig. 12). The passage of the vehicle from one transmitter to the next can generate an abrupt variation of the absorbed power, causing stress at the point of common coupling (PCC) with the utility network. This stress may cause degradation of the power quality due to possible voltage fluctuations. To mitigate this problem, the introduction of an active smoothing architecture is proposed, based on a single-pole and bidirectional converter, which would maintain constant the current at the output of the ac/dc converter, thereby reducing the harmonic content at the PCC.

This technique would allow the management of the energy stored in the capacitor in a more effective way, and a reduction of its capacitance [45].

VII. CONCLUSIONS AND OPEN ISSUES

Static inductive power transfer is a mature technology that most likely will be widely used for automotive applications. The lack of electrical contacts makes the system more reliable and non-invasive in urban contexts. Dynamic IPT is an interesting improvement of the IPT: the massive use of electrified road infrastructure may change the perception of the user about the electric mobility, improving the market penetration thanks to an extended battery autonomy.

However, the dynamic IPT is still under development and many challenges are still unsolved:

- different answers have been provided for the sizing of the pads, with opposite solutions: long track transmitters (in the order of hundred meters) [46] coexists with the use of small circular pads [47] as well as overlapping coils [48];
- the integration and durability of the on-road infrastructure is unknown and may interfere with the typical road lifetime;
- the power levels and frequency range, which affect the choice of power electronics components, are still under discussion;
- the effects of the electromagnetic bursts on the electronic on-board components as well as the compliance with the ICNIRP recommendations for human exposure must be evaluated during the entire charging phase [49], [50], [51];
- different techniques for the vehicle detection and identification when approaching the charging pads as well as the handoff between consecutive coils are under investigation, such as the use of auxiliary coils [52], [53], optical sensors, radio or wired communications [47] between the power electronics;

As detailed in this paper, many actors are working on different solutions to these problems, with possible conflicting outcomes. The standardization process is in its early stage, however the general trend is to replicate procedures and standards from the static IPT in order to enforce the interoperability between the static and dynamic systems. Despite the uncertainty surrounding the dynamic IPT, it looks promising as confirmed by the numerous private and public investments in this field. The final penetration into the market is however limited by the high costs of the road infrastructures, which requires investments by public institutions and governments.

REFERENCES

- [1] M. Faraday, "Experimental researches in electricity," *Philosophical Transactions of the Royal Society of London*, vol. 122, pp. 125–162, 1832.
- [2] D. J. Cichon and W. Wiesbeck, "The Heinrich Hertz wireless experiments at Karlsruhe in the view of modern communication," in *100 Years of Radio., Proceedings of the 1995 International Conference on. IET*, 1995, pp. 1–6.
- [3] N. Tesla, "The transmission of electrical energy without wires," *Electrical World and Engineer*, vol. 1, 1904.
- [4] S. S. Valtchev, E. N. Baikova, and L. R. Jorge, "Electromagnetic field as the wireless transporter of energy," *Facta universitatis-series: Electronics and Energetics*, vol. 25, no. 3, pp. 171–181, 2012.
- [5] N. Tesla, "World system of wireless transmission of energy," *Telegraph and Telephone Age*, 1927.
- [6] —, "Apparatus for transmission of electrical energy." May 15 1900, uS Patent 649,621. [Online]. Available: <https://www.google.com/patents/US649621>
- [7] G. I. Babat, "Electrodeless discharges and some allied problems," *Electrical Engineers - Part III: Radio and Communication Engineering, Journal of the Institution of*, vol. 94, no. 27, pp. 27–37, January 1947.
- [8] D. V. Otto, "Power supply equipment for electrically-driven vehicle," Jun. 19 1974, jP Patent 49 063 111.
- [9] G. A. Covic and J. T. Boys, "Inductive power transfer," *Proceedings of the IEEE*, vol. 101, no. 6, pp. 1276–1289, 2013.
- [10] S. E. Shladover *et al.*, "Path at 20-history and major milestones," *IEEE Transactions on intelligent transportation systems*, vol. 8, no. 4, pp. 584–592, 2007.
- [11] J. Boys and A. Green, "Inductive power pick-up coils," Apr. 27 1995, wO Patent App. PCT/NZ1994/000,115. [Online]. Available: <https://www.google.com/patents/WO1995011545A1?cl=en>
- [12] —, "Flux concentrator for an inductive power transfer system," Oct. 13 1998, uS Patent 5,821,638. [Online]. Available: <https://www.google.com/patents/US5821638>
- [13] "Award for conductix-wampfler: Wireless charging of electric vehicles," <http://www.conductix.fr/sites/default/files/downloads/PR%2011-02-14%20Award%20for%20Conductix-Wampfler.pdf>, accessed July 21, 2016.
- [14] M. Emre, P. Vermaat, D. Naberezhnykh, Y. Damousuis, T. Theodoropoulos, V. Cirimele, and A. Doni, "D 3.3.1 - Review of existing power transfer solutions," *Public Deliverable EU FABRIC project (605405)*, 2014.
- [15] "Wave website," <http://www.waveipt.com/>, accessed July 21, 2016.
- [16] "Primove bombardier website," <http://primove.bombardier.com/applications/e-bus.html>, accessed in July 21, 2016.
- [17] C. T. Rim, "The development and deployment of on-line electric vehicles (OLEV)," in *Energy Convers. Congr. Expo. (ECCE)*. IEEE, Sep. 2013.
- [18] I. Suh, "Application of shaped magnetic field in resonance (SMFIR) technology to future urban transportation," in *CIRP design conference*, 2011.
- [19] S. Ahn and J. Kim, "Magnetic field design for high efficient and low EMF wireless power transfer in on-line electric vehicle," in *Antennas and Propagation (EUCAP), Proceedings of the 5th European Conference on.* IEEE, 2011, pp. 3979–3982.
- [20] J. Huh, S. W. Lee, W. Y. Lee, G. H. Cho, and C. T. Rim, "Narrow-width inductive power transfer system for online electrical vehicles," *Power Electronics, IEEE Transactions on*, vol. 26, no. 12, pp. 3666–3679, 2011.
- [21] "HaloIPT to provide induction charging system for Phantom EE," <http://www.greencarcongress.com/2011/03/haloipt-to-provide-induction-charging-system-for-phantom-ee.html>, Mar. 2 2011, accessed July 21, 2016.
- [22] "Toyota licenses WiTricity patent portfolio for wireless power," <http://witricity.com/news/toyota-licenses-witricity-patent-portfolio-for-wireless-power/>, Dec. 5 2013, accessed July 21, 2016.
- [23] R. W. Carlson and B. Normann, "Test results of the plugless inductive charging system from evatran group, inc," *SAE Int. J. Altern. Power-trains*, vol. 3, pp. 64–71, 2014.
- [24] J. M. Miller, P. T. Jones, J. M. Li, and O. C. Onar, "ORNL experience and challenges facing dynamic wireless power charging of EV's," *IEEE Circuits and Systems Magazine*, vol. 15, no. 2, pp. 40–53, Secondquarter 2015.
- [25] J. M. Miller, O. C. Onar, C. White, S. Campbell, C. Coomer, L. Seiber, R. Sepe, and A. Steyerl, "Demonstrating dynamic wireless charging of an electric vehicle: The benefit of electrochemical capacitor smoothing," *Power Electronics Magazine, IEEE*, vol. 1, no. 1, pp. 12–24, 2014.
- [26] "UNPLUGGED project website," <http://unplugged-project.eu/wordpress/>, accessed in July 21, 2016.
- [27] J. Sanz, J. Villa, J. Sallán, J. Perić, and L. García Duarte, "UNPLUGGED project: Development of a 50 kW inductive electric vehicle battery charge system," in *Electric Vehicle Symposium and Exhibition (EVS27), 2013 World*, Nov 2013, pp. 1–7.

- [28] "Fastincharge project website," <http://www.fastincharge.eu/index.php>, accessed July 21, 2016.
- [29] "eCo-FEC project website," <https://www.eco-fev.eu/>, accessed July 21, 2016.
- [30] "Endesa develops wireless en-route charging for electric buses in malaga," <http://www.endesa.com/en/saladeprensa/noticias/wireless-en-route-charging-electric-buses>, accessed July 21, 2016.
- [31] J. Schneider, "SAE J2954 overview and path forward," 2013.
- [32] A. Gil and J. Taiber, "A literature review in dynamic wireless power transfer for electric vehicles: Technology and infrastructure integration challenges," in *Sustainable Automotive Technologies 2013*. Springer, 2014, pp. 289–298.
- [33] "SAE international web site," <http://standards.sae.org/wip/j2954/>, Mar. 31 2016, accessed July 21, 2016.
- [34] "IEC 61980-1:2015 Electric vehicle wireless power transfer (WPT) systems – Part 1: General requirements," <https://webstore.iec.ch/publication/22951>, accessed July 21, 2016.
- [35] "ISO/AWI PAS 19363. electrically propelled road vehicles – magnetic field wireless power transfer – safety and interoperability requirements," http://www.iso.org/iso/home/store/catalogue_tc/catalogue_detail.htm?csnumber=64700, accessed July 21, 2016.
- [36] C. Kalialakis and A. Georgiadis, "The regulatory framework for wireless power transfer systems," *Wireless Power Transfer*, vol. 1, no. 02, pp. 108–118, 2014.
- [37] J. Taiber, "Electric vehicle wireless power transfer," *Industry connections activity initiation document (ICAID). Version*, vol. 1, p. 12, 2013.
- [38] V. Cirimele, F. Freschi, and P. Guglielmi, "Wireless power transfer structure design for electric vehicle in charge while driving," in *Electrical Machines (ICEM), 2014 International Conference on*, Sept 2014, pp. 2461–2467.
- [39] V. Cirimele, M. Diana, N. El Sayed, F. Freschi, and P. Guglielmi, "An innovative next generation E-mobility infrastructure: The eCo-FEV project," in *Electric Vehicle Conference (IEVC), 2014 IEEE International*, Dec 2014, pp. 1–7.
- [40] "FABRIC project website," <http://www.fabric-project.eu/>, accessed July 21, 2016.
- [41] A. Amditis, G. Karaseitanidis, I. Damousis, P. Guglielmi, and V. Cirimele, "Dynamic wireless charging for more efficient FEVS: The fabric project concept," in *MedPower 2014*, Nov 2014, pp. 1–6.
- [42] M. Mitolo, *Electrical Safety of Low-Voltage Systems*. McGraw-Hill Education, 2009. [Online]. Available: <https://books.google.fr/books?id=eQLvNwAACAAJ>
- [43] ICNIRP, "Guidelines for limiting exposure to time-varying electric and magnetic fields (1 Hz to 100 kHz)," *Health Phys*, vol. 99, no. 6, pp. 818–836, 2010.
- [44] H. Jiang, P. Brazis, M. Tabaddor, and J. Bablo, "Safety considerations of wireless charger for electric vehicles – a review paper," in *Product Compliance Engineering (ISPCE), 2012 IEEE Symposium on*, Nov 2012, pp. 1–6.
- [45] R. Ruffo, V. Cirimele, P. Guglielmi, and M. Khalilian, "A coupled mechanical-electrical simulator for the operational requirements estimation in a dynamic ipt system for electric vehicles," in *2016 IEEE Wireless Power Transfer Conference (WPTC)*, May 2016, pp. 1–4.
- [46] S. Choi, J. Huh, W. Lee, S. Lee, and C. Rim, "New cross-segmented power supply rails for roadway-powered electric vehicles," *Power Electronics, IEEE Transactions on*, vol. 28, no. 12, pp. 5832–5841, Dec 2013.
- [47] O. C. Onar, J. M. Miller, S. L. Campbell, C. Coomer, C. White, L. E. Seiber *et al.*, "A novel wireless power transfer for in-motion ev/phev charging," in *Applied Power Electronics Conference and Exposition (APEC), 2013 Twenty-Eighth Annual IEEE*. IEEE, 2013, pp. 3073–3080.
- [48] G. Covic and J. Boys, "Modern trends in inductive power transfer for transportation applications," *Emerging and Selected Topics in Power Electronics, IEEE Journal of*, vol. 1, no. 1, pp. 28–41, March 2013.
- [49] I. Laakso, A. Hirata, and O. Fujiwara, "Computational dosimetry for wireless charging of an electrical vehicle," in *Electromagnetic Compatibility, Tokyo (EMC'14 Tokyo), 2014 International Symposium on*. IEEE, 2014, pp. 202–205.
- [50] P.-P. Ding, L. Bernard, L. Pichon, and A. Razek, "Evaluation of electromagnetic fields in human body exposed to wireless inductive charging system," *Magnetics, IEEE Transactions on*, vol. 50, no. 2, pp. 1037–1040, Feb 2014.
- [51] L. Lu, J. Nadakuduti, and P. Guckian, "Compliance assessment of human exposure from wireless electric vehicle charging system," Dec. 17 2014, uS Patent App. 14/574,095.
- [52] G. Nagendra, L. Chen, G. Covic, and J. Boys, "Detection of EVs on IPT Highways," *Emerging and Selected Topics in Power Electronics, IEEE Journal of*, vol. 2, no. 3, pp. 584–597, Sept 2014.
- [53] F. Lu, H. Zhang, H. Hofmann, and C. Mi, "A dynamic charging system with reduced output power pulsation for electric vehicles," *IEEE Transactions on Industrial Electronics*, vol. PP, no. 99, pp. 1–1, 2016.