

Probabilistic framework to evaluate the resilience of engineering systems using Bayesian and dynamic Bayesian networks

Original

Probabilistic framework to evaluate the resilience of engineering systems using Bayesian and dynamic Bayesian networks / Kammouh, O.; Gardoni, P.; Cimellaro, G. P.. - In: RELIABILITY ENGINEERING & SYSTEM SAFETY. - ISSN 0951-8320. - ELETTRONICO. - 198:(2020), p. 106813. [10.1016/j.ress.2020.106813]

Availability:

This version is available at: 11583/2840566 since: 2020-07-17T12:07:14Z

Publisher:

Elsevier Ltd

Published

DOI:10.1016/j.ress.2020.106813

Terms of use:

This article is made available under terms and conditions as specified in the corresponding bibliographic description in the repository

Publisher copyright

Elsevier postprint/Author's Accepted Manuscript

© 2020. This manuscript version is made available under the CC-BY-NC-ND 4.0 license
<http://creativecommons.org/licenses/by-nc-nd/4.0/>. The final authenticated version is available online at:
<http://dx.doi.org/10.1016/j.ress.2020.106813>

(Article begins on next page)

1 **Probabilistic Framework to Evaluate the Resilience of Engineering Systems Using Bayesian**
2 **and Dynamic Bayesian Networks**

3 Omar Kammouh¹, Paolo Gardoni², and Gian Paolo Cimellaro³

4 **Abstract**

5 Resilience indicators are a convenient tool to assess the resilience of engineering systems. They are often used
6 in preliminary designs or in the assessment of complex systems. This paper introduces a novel approach to
7 assess the time-dependent resilience of engineering systems using resilience indicators. A Bayesian network
8 (BN) approach is employed to handle the relationships among the indicators. BN is known for its capability of
9 handling causal dependencies between different variables in probabilistic terms. However, the use of BN is
10 limited to static systems that are in a state of equilibrium. Being at equilibrium is often not the case because
11 most engineering systems are dynamic in nature as their performance fluctuates with time, especially after
12 disturbing events (e.g. natural disasters). Therefore, the temporal dimension is tackled in this work using the
13 Dynamic Bayesian Network (DBN). DBN extends the classical BN by adding the time dimension. It permits
14 the interaction among variables at different time steps. It can be used to track the evolution of a system's
15 performance given an evidence recorded at a previous time step. This allows predicting the resilience state of a
16 system given its initial condition. A mathematical probabilistic framework based on the DBN is developed to
17 model the resilience of dynamic engineering systems. Two illustrative examples are presented in the paper to
18 demonstrate the applicability of the introduced framework. One example evaluates the resilience of Brazil. The
19 other one evaluates the resilience of a transportation system.

20 Keywords: Bayesian Network; Dynamic Bayesian Network; Resilience analysis; critical infrastructure; Resilience indicators, Recovery

21

¹ Postdoc researcher, Dept. of Civil Engineering and Geosciences (CEG), Delft University of Technology, Corso Duca degli Abruzzi
24, 10129, Torino, Italy, E-mail: o.kammouh@tudelft.nl

² Professor and MAE Center Director, Dept. of Civil and Environmental Engineering, University of Illinois at Urbana-Champaign, 3118
Newmark Civil Engineering Laboratory, 205 N. Mathews Ave., Urbana, IL 61801, United States Email: gardoni@illinois.edu

³Associate Professor, Dept. of Structural, Geotechnical and Building Engineering (DISEG), Politecnico di Torino, Corso Duca degli
Abruzzi 24, 10129, Torino, Italy (Corresponding author) E-mail: gianpaolo.cimellaro@polito.it

1. Introduction

Research on disaster resilience has recently been fostered due to the noticeable increase in the number of natural and human-caused disasters. Resilience has been defined differently depending on the field of study ([Doorn et al. 2018](#); [Hosseini et al. 2016b](#); [Manyena 2006](#)). In engineering, resilience is the ability to withstand a disturbance caused by an external agent and recover quickly if damage occurs ([Cimellaro et al. 2010b](#); [Cimellaro et al. 2016a](#); [Cimellaro et al. 2014b](#)). Current scientific contributions are aimed at understanding disaster resilience and finding new ways to measure it, quantitatively or qualitatively. Several solutions exist in the literature to measure resilience at the community level ([Cutter et al. 2014](#); [Kammouh and Cimellaro 2018b](#); [Kammouh et al. 2018c](#)) and at the infrastructure level ([Gardoni 2018](#); [Liu et al. 2017](#); [Sharma et al. 2018](#)); however, research on resilience quantification is still in the early stage of development and no universal method exists so far. Among others, resilience indicators are an effective tool to compute the resilience of engineering systems because they allow modeling complex systems easily and effectively ([Cimellaro et al. 2016b](#); [Cimellaro et al. 2015](#); [Cutter et al. 2008](#)). Several authors have proposed indicator-based methodologies to evaluate the resilience of engineering systems; some are deterministic ([Henry and Ramirez-Marquez 2012](#); [Kammouh et al. 2017b](#); [Kammouh et al. 2019b](#)) and the others are probabilistic ([Cockburn and Tesfamariam 2012](#); [De Juiis et al. 2019b](#); [Kammouh et al. 2018b](#); [Kammouh et al. 2018d](#); [Shahriar et al. 2012](#)). Nevertheless, developing a standardized indicator-based methodology to quantify resilience is still challenging. The main challenge is the presence of uncertainty in the resilience model and its inputs. The interdependency and the weighting factors distribution among the variables are also other issues that cannot be handled in a deterministic way. Therefore, probabilistic methods are usually preferred over deterministic methods. Probabilistic models are more powerful to model uncertainties and interdependencies and they are more appropriate to represent reality. In fact, deterministic models are considered a particular case of probabilistic models ([Pourret et al. 2008](#)).

While probabilistic models solve the gap of modeling capability that deterministic models suffer from, not all probabilistic approaches are suitable to model the behavior of engineering systems, especially in cases where past data is not readily available ([Cimellaro 2016](#)). One way to properly model the behavior of a system in a probabilistic manner is through the use of Fuzzy analysis and Bayesian Networks (BNs). Fuzzy theory represents a method for solving problems which are related to uncertainty and vagueness. It has been implemented in several research works to study the resilience of infrastructure systems ([De Juiis et al. 2019a](#); [Kammouh et al. 2018e](#)). Fuzzy theory is usually implemented in cases with no data, which is replaced with expert judgements. The output of fuzzy-based methods are heavily subjective given that they are based on opinions rather than data. On the other hand, BN is a Directed Acyclic Graph where the nodes represent variables of interest and the links between them indicate causal dependencies. BNs are widely used for knowledge representation and reasoning under uncertainty, especially in the context of partial information. They are effective when different types of variables and knowledge from various sources need to be integrated within a single framework. In addition, BN provides probabilistic relationships among the variables, which allows modeling the interdependencies among them. In the literature, there is a limited number of research contributions that use the BN in resilience analysis. [Johansen and Tien \(2018\)](#) proposed a probabilistic

59 methodology based on the BN approach to model the interdependencies between critical infrastructure systems.
60 Their research aims at understanding the effect of interdependencies on the fragility of the overall system. [Cai
61 et al. \(2017\)](#) developed a universal resilience metric for infrastructure systems. A BN approach was employed
62 to calculate the resilience metric value. The proposed resilience metric can be used to design and/or optimize
63 different types of engineering systems against various hazards, such as earthquakes, floods, cyber-attacks
64 ([Kammouh and Cimellaro 2018a](#)), etc. Moreover, [Hosseini and Barker \(2016\)](#) introduced a resilience
65 quantification methodology using BN. In their research, the resilience is defined using three parameters:
66 absorptive capacity, adaptive capacity, and restorative capacities. A case study on an inland waterway port, an
67 essential component in the intermodal transportation network, was used to demonstrate the methodology.
68 [Hosseini et al. \(2016a\)](#) employed a BN to quantify the supply chain system resilience of sulfuric acid
69 manufacturer in Iran. Their work consists of a formulation for supplier selection, that accounts for operational
70 (e.g., customer demand) and disruption (e.g., natural disaster) risks and their effect on resilient suppliers.
71 ([Hossain et al. 2019b](#)) applied Bayesian Network to rank ports infrastructure assets. Their study proposes a
72 formulation for supplier selection, accounting for operational (e.g., customer demand) and disruption (e.g.,
73 natural disaster) risks and their effect on resilient suppliers. ([Hossain et al. 2019b](#)) introduced a BN approach to
74 rank port infrastructure assets. ([Eldosouky et al. 2017](#)) introduced a novel analytical resilience index to measure
75 the effect of each critical infrastructure's physical component on its probability of failure using Bayesian
76 network. The proposed framework was applied to a case study of hydropower dams and their interdependence
77 to the power grid. Finally, ([Hossain et al. 2019a](#)) addressed a range of possible risks to the electrical power
78 system and its interdependent networks (EIN) using the BN.

79 Rather than the static approaches, [Tabandeh et al. \(2018\)](#) developed an indicator-based probabilistic formulation
80 to model the societal impact and estimate the impact considering the immediate consequences and the recovery
81 condition. The methodology uses DBN to integrate the predictive model of the indicators. BNs have also been
82 employed by researchers in fields other than disaster resilience ([Cockburn and Tesfamariam 2012](#); [Ismail et al.
83 2011](#); [Kabir et al. 2016](#); [Kabir et al. 2015](#); [Kammouh et al. 2019a](#); [Siraj et al. 2015](#)). For example, [Cockburn
84 and Tesfamariam \(2012\)](#) used BNs to estimate the risk of several cities located in Canada, [Kabir et al. \(2015\)](#)
85 evaluated the risk of water mains failure using a BN model, while [Siraj et al. \(2015\)](#) employed BNs in the
86 seismic risk assessment of high voltage transformers.

87 Resilience can be an outcome (static) or a process (dynamic) ([Cutter et al. 2008](#)). While most of the
88 abovementioned researches focused on analyzing engineering resilience from a static point of view, there is a
89 significant gap in assessing the dynamic nature of resilience through quantitative approaches. In fact, BN does
90 not capture the behavior of dynamic systems and the interdependencies among the system's components and
91 variables. BN is a snapshot of the system, which implies that the restoration process, which is inherently time-
92 dependent, cannot be modeled. Moreover, a feedback loop is not allowed in a BN model; thus, it cannot be used
93 to model a cyclic relationship. Although there are some research works that use the DBN as an inference tool
94 to express resilience in a dynamic manner, the resilience models adopted in those researches and the transitional
95 model from one step to another in the time space was not clearly defined.

96 This paper first proposes a static framework to model systems of static nature (e.g., assessing a system's
97 performance at a specific instance of time). It employs the BN as a tool to quantify the system's resilience. The
98 framework is demonstrated using a case study in which the resilience of a country, namely Brazil, is assessed.
99 In general, BN is good tool to assess a physical-causal model; however, learning and updating a BN requires an
100 extensive computational load. Updating a BN is necessary for resilience modeling, especially in monitoring the
101 possibility of disruptive events. Thus, this paper also presents a dynamic framework to quantitatively assess the
102 resilience of systems of dynamic nature (i.e., critical infrastructures, buildings, communities, etc.) The
103 framework can be used to assess the resilience of multiple systems at once and it adopts the DBN as an inference
104 tool. In fact, a DBN model can be obtained by expert knowledge, from a database using a combination of
105 machine-learning techniques, or both. These properties make the DBN formalism very useful in the disaster
106 resilience domain as this domain has an abundance of both expert knowledge and databases records. Moreover,
107 a DBN allows performing a transient analysis of the system after the occurrence of disruption until the system
108 was recovered from its disruptive states. The transient analysis can be rather useful to model the restoration
109 process of the damaged system. The proposed resilience framework is presented in the form of a mathematical
110 formulation that integrates the probability distribution of all variables' states. An illustrative example of a
111 transportation network is used to demonstrate the proposed methodology. Results show the ability of the
112 framework to dynamically model complex systems even in cases where data are scarce.

113 The rest of the paper is organized as follows: Section 2 is dedicated to review the basics of the BN and DBN.
114 Section 3 introduces a framework to assess the resilience of static systems where the BN is used as the inference
115 method. In Section 4, an illustrative example is presented to show the applicability of the static resilience
116 framework. Section 5 discusses the general framework for modeling and quantifying the resilience of dynamic
117 systems using the DBN approach. A transportation network is presented in Section 6 to illustrate the
118 effectiveness of the proposed framework.. In Section 7, further considerations and applications are discussed.
119 Finally, conclusions are given in Section 8 together with the proposed future work.

120 **2. Bayesian and Dynamic Bayesian Networks**

121 2.1 Bayesian Network (BN)

122 The Bayesian Network, also known as Bayesian Belief Network, is a graphical model that allows the design of
123 stochastic relationships among a group of variables ([De Jullis et al. under review](#)). Applications of BN can be
124 found in a variety of fields, from social to economic and biological disciplines ([Ismail et al. 2011](#); [Schultz and
125 Smith 2016](#)). BN permits the usage of different types of knowledge, both quantitative and qualitative, and can
126 cope with missing data considering the uncertainty embedded in the system ([Balbi et al. 2014](#)). To construct a
127 BN, several hypotheses have to be made. Each hypothesis is decomposed into a set of random variables. Each
128 variable can take values within a finite set of states (also known as beliefs), mutually exclusive and collectively
129 exhaustive (MECE) ([Grover 2013](#)). The dependency of one variable on another is represented in the network
130 as a directed edge (or link). The relationships between the variables in a BN are expressed in terms of family
131 relationships. The link starts from the so-called father node and points at the son node, which is the impacted

132 variable. The set of edges and nodes builds a directed acyclic graph. The network itself is normally learned from
 133 data or specified by experts who not only provide the main hypotheses (and consequently the variables to be
 134 considered in the model), but also the dependencies between the variables. The foundation and the inference
 135 process of BN is set in the Bayes' Theorem. Given a state b for a variable B and a number k of MECE states a_j ,
 136 $j = 1, \dots, k$ for a variable A , the updated probability is computed as:

$$137 \quad P(a_j | b) = \frac{P(b | a_j)P(a_j)}{P(b)} \quad (1)$$

138 where $P(a_j|b)$ is one's belief for hypothesis a_j upon observing evidence b , $P(b|a_j)$ is the likelihood that b is
 139 observed if a_j is true, $P(a_j)$ is the probability that the hypothesis holds true, and $P(b)$ is the probability that the
 140 evidence takes place. $P(a_j|b)$ is known as *posterior* probability and $P(a_j)$ is called prior probability ([Laskey](#)
 141 [1995](#)). The dependencies of one variable (the son node) on another (the father node) are usually quantified using
 142 a Conditional Probability Table (CPT), where the likelihood of the son node to assume a certain state under a
 143 certain father node state is assigned ([Grover 2013](#)). In the case of a variable with no parents, the probabilities
 144 are reduced to the unconditional probability. The quantitative part of the BN starts by assigning conditional
 145 probability distributions (CPD) to the nodes. Each node in a BN has a CPT that determines the CPD of the
 146 random variable. The CPTs provide information on the probability of a node given its parents ([Murphy and](#)
 147 [Russell 2002](#)).

148 Once the BN is constructed, we pinpoint that the outcome is highly dependent on the assigned probabilities
 149 ([Ismail et al. 2011](#)). To test the robustness of the model and the dependency of the outcome on each father node,
 150 a sensitivity analysis is usually performed. This allows identifying the most important and impactful variables,
 151 leading to consequent emphatic attention in the collection of data for the concerned variables ([Laskey 1995](#)).
 152 For more details, several examples of BN applications can be found in the literature ([Cockburn and Tesfamariam](#)
 153 [2012](#); [Ismail et al. 2011](#); [Kabir et al. 2016](#); [Kabir et al. 2015](#); [Siraj et al. 2015](#)).

154 2.2 Dynamic Bayesian Network (DBN)

155 BNs are used when the analyzed system is in a static state. This is often not the case in a dynamic, continuously
 156 changing world. This raises the need for a tool that is capable of accounting for system changes, such as the
 157 Dynamic Bayesian Network. DBN is a Bayesian network extended with additional mechanisms that are capable
 158 of modeling influences over time ([Murphy and Russell 2002](#)). It extends the classical BN by adding the time
 159 dimension. It is suitable for describing dynamic systems where the performance fluctuates (e.g. before and after
 160 a disaster). Like the BN, the DBN is a directed acyclic graphical model used for statistical processes. A DBN
 161 consists of multiple BNs (often referred to as time-slices or time steps), each with its own variables. The
 162 variables within a single and/or successive time-slices are connected using links. A DBN can be defined as $(B_1,$
 163 $B \rightarrow)$, where B_1 is a BN that specifies the initial distribution of the variable states $P(Z_1)$ ([Murphy and Russell](#)
 164 [2002](#)), where $Z_t = (U_t, X_t, Y_t)$ is the input, hidden, and output variables of the model at time step t , while $B \rightarrow$ is
 165 called a "two-slice temporal Bayesian network" (2TBN), which defines the transition model $P(Z_t|Z_{t-1})$, as in

166 Equation (2). The nodes in the first slice of the 2TBN network do not have parameters associated with them,
 167 while CPTs are required for the nodes in the second slice.

$$168 \quad p(Z_t | Z_{t-1}) = \prod_{i=1}^N p(Z_t^i | Pa(Z_t^i)) \quad (2)$$

169 where Z_t^i is the i^{th} node at time t and could be a component of X_t , Y_t , or U_t . $Pa(Z_t^i)$ are the parents of Z_t^i , which
 170 can be in the same or the previous time-slice.

171 The process in a DBN is stationary and the structure repeats after the second time-slice, so the variables for the
 172 slices $t=2, 3, \dots, T$ remain unchanged. This allows expressing the system using only two slices (i.e., the first and
 173 the second time-slices). Therefore, an unbounded sequence length could be modeled using a finite number of
 174 parameters. The probability distribution for a sequence of time-slices can be obtained by unrolling the 2TBN
 175 network, as follows:

$$176 \quad p(Z_{1:T}) = \prod_{t=1}^T \prod_{i=1}^N p(Z_t^i | Pa(Z_t^i)) \quad (3)$$

177 The DBN is often seen as a generalization of other temporal reasoning developments, such as the hidden Markov
 178 model (HMM) and the Kalman filter model (KFM) ([Hulst 2006](#)). These models, which can be expressed in a
 179 compact form, are popular for their fast learning and fast inference techniques. In fact, DBNs generalize HMMs
 180 by expressing the state space in not only a single discrete random variable but also in a factored form.

181 ***Temporal plate and contemporal nodes***

182 The temporal plate is the area within the DBN model that includes temporal information (i.e., information that
 183 changes from a time step to another). The temporal plate includes the variables that evolve over time. These
 184 variables are the part of the DBN that can be unrolled. However, nodes that have a constant value at every time
 185 step are considered a waste of memory and computational power if copied in each time step. Therefore, it is
 186 wise to introduce these nodes outside the temporal plates. The collection of these nodes is called the contemporal
 187 space, and the nodes are called contemporal nodes ([Murphy and Russell 2002](#)).

188 ***Anchor and terminal nodes***

189 One extension of the original DBN formalism was established in ([Hulst 2006](#)), where the author introduced
 190 nodes that are only connected to the first and last time slices of the DBN. Such variables do not affect the
 191 intermediate time slices like the contemporal nodes.

- 192 • Anchor node (A): a node that is outside the temporal plate but has at least one child node inside the
 193 temporal plate in the first time slice of the unrolled DBN.
- 194 • Terminal node (T): a node that is outside the temporal plate and has at least one parent inside the
 195 temporal plate in the last time slice of the unrolled DBN.

196 Figure 1(a) presents a single time slice of a DBN (a snapshot of the system) where all variables appear to be
 197 static. Figure 1(b) shows a general DBN where the variables that are in the temporal plate (the dotted rectangle)

198 are those that are repeated when the DBN is unrolled, and the variables that are outside the temporal plate are
 199 the static (contemporal, anchor, or terminal) nodes. Figure 1(c) shows the unrolled DBN where the variables
 200 that are inside the temporal plate are connected with one another through temporal arcs and appear in every
 201 time-step, while the other variables appear only once since their value is constant. The transition model of the
 202 DBN can be represented as follows:

$$203 \quad p(Z_t | Z_{t-1}, Z_{t-2}, \dots, Z_{t-k}, C) = \prod_{i=1}^N p(Z_t^i | Pa(Z_t^i), C^i) \quad (4)$$

204 where $Pa(Z_t^i)$ is the parents of Z_t^i inside the temporal plate, C^i for $i = 1, \dots, N$ are the contemporal variables
 205 that are a parent of Z_t^i . The joint distribution of a DBN sequence of length T including the additional variables
 206 (A) and (T) is given as follows:

$$207 \quad p(A, C, Z_{1:T}, T) = p(C) \cdot p(A|C) \prod_{i=1}^N p(Z_1^i | Pa(Z_1^i), A^i, C^i) \prod_{t=2}^T \prod_{i=1}^N p(Z_t^i | Pa(Z_t^i), C^i) \prod_{i=1}^N p(T^i | Z_T^i, C^i) \quad (5)$$

208 where A^i is the anchor variables that are a parent of Z_1^i , T^i is the terminal variables that are a child of Z_T^i .

209

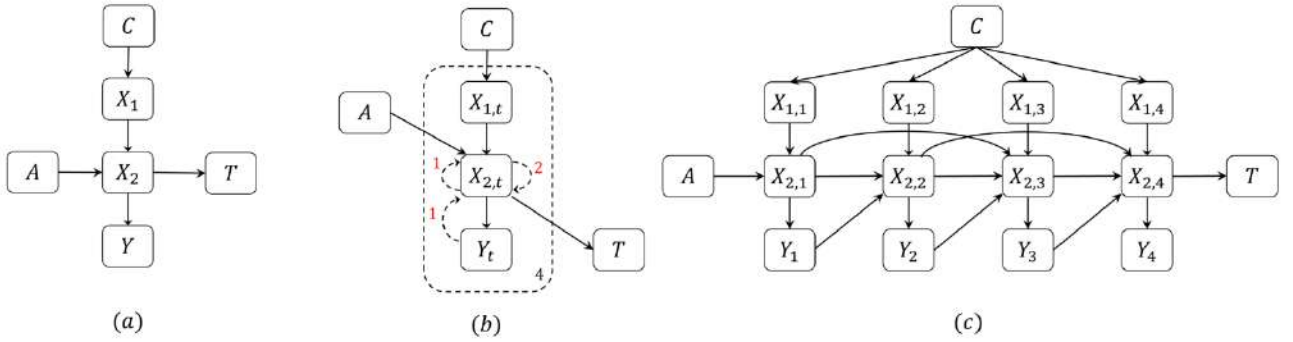

210

211 Figure 1 (a) The initial network of a DBN, (b) the 2TBN or a second order DBN, (c) the unrolled
 212 DBN model for $T=4$ slices.

213 3. Quantifying Resilience Using Bayesian Network: A Univariate Static 214 Approach

215 3.1 Static resilience model

216 In this work, we adopt a model based on the resilience definition provided by [Bruneau and Reinhorn \(2007\)](#) and
 217 [Bruneau et al. \(2003\)](#), who describe the resilience of a system using the following three indicators (hereafter we
 218 call them the three resilience pillars): reduced failure probability (*reduced vulnerability*); reduced consequences
 219 from failure (*robustness*); and reduced time to recovery (*recoverability*) (Figure 2):

- 220 • Reduced vulnerability: the reduced likelihood of damage & failure to critical infrastructure systems and
 221 components (P_1);

- 222 • Robustness: the damage level, in terms of injuries, lives lost, physical damage, and negative economic
223 and social impacts (P_2);
- 224 • Recoverability: the time required to restore a specific system or a set of systems to normal or pre-
225 disaster level of functionality (P_3).

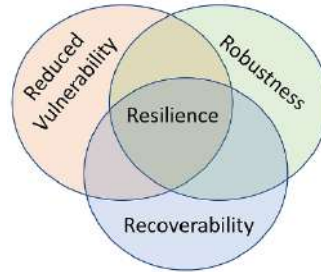

226
227 Figure 2 The three resilience pillars

228 A system with a low probability of failure, high robustness, and high recoverability capacity is considered
229 resilient. The three resilience pillars can be typically described using a set of indicators representing the analyzed
230 system. The choice of indicators can be made by experts in the relevant field. Figure 3 shows a general resilience
231 functionality curve where the three resilience pillars are allocated to three time-spans:

- 232 • The pre-disaster time span, defined by the system's probability of failure;
- 233 • The disaster time span, determined by the robustness level of the system;
- 234 • Post-disaster time span, defined by the recovery capacity of the system.

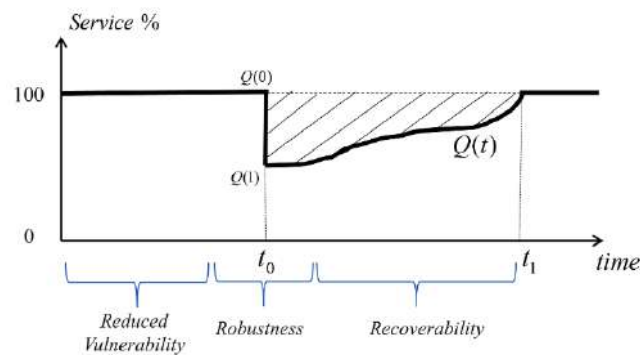

235
236 Figure 3 A general resilience function of a system

237 3.2 Network structure and elements connectivity

238 Assume that we have a system composed of N indicators (X_1, X_2, \dots, X_N). The indicators are connected to the
239 three resilience pillars according to their relevance. Such connections can be obtained from past experience or
240 expert knowledge. One indicator can contribute to multiple pillars, as shown in the Bayesian network in Figure
241 4, where indicator X_4 is connected to R_1 and R_2 while X_7 is connected to R_2 and R_3 . The final output (*resilience*
242 *index*) represents a combination of all factors that contribute towards the resilience pillars.

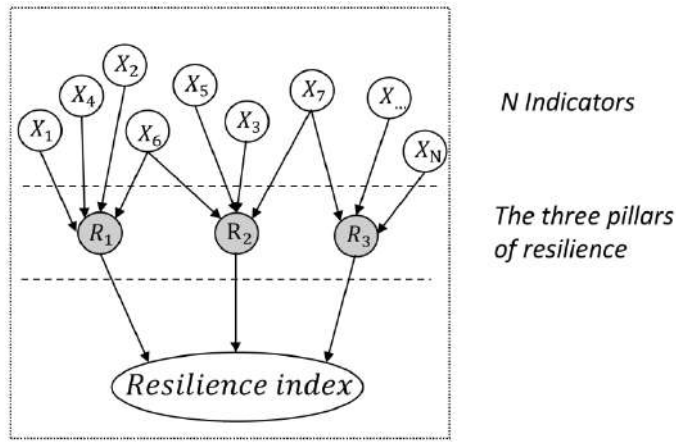

Figure 4 Bayesian network to compute the resilience index of a static system

3.3 Unconditional and Conditional Probability Tables

Once the connections between the son nodes (i.e. resilience pillars) and the father nodes (i.e. indicators) are completed, the CPTs of the resilience pillars given the indicators' states must be defined. The indicators states (or the unconditional probabilities of the basic nodes) are defined using experts knowledge or available data. Only three levels (states) are assigned to each resilience pillar node (High (H), Medium (M), and Low (L)) in order to maintain a low complexity of the network, while five states are assigned to the indicators (High, Good, Medium, Low, and vulnerable), coded as 4, 3, 2, 1, 0 respectively. To obtain a numerical value for the son node, the sum of the numerical values of the father nodes is computed and then divided for the sum of their maximum values, building a global relative value x for the son node ranging between 0 and 1 (Equation 6). Equation **Error!** **Reference source not found.** 6 is indeed a special case of the min-max normalization where the minimum value is zero.

$$x = \frac{\sum_{i=1}^n y_i}{\sum_{i=1}^n \max_i} = \frac{\sum_{i=1}^n y_i}{n \times \max} \quad (6)$$

where x is the global relative value for the analyzed son node, i is the father node index, n is the number of father nodes under a son node, y_i is the value of the father node i , \max_i is the maximum value a father node i can take (fixed for all nodes).

To illustrate this, consider three father nodes [A; B; C], each with a three-level scale High, Medium, and Low, converted to 2, 1, and 0 respectively. Assuming a combination of [Medium, Medium, High] respectively for the three father nodes [A; B; C], which is equivalent to [1; 1; 2], the value x of the son node is computed as follows:

$$x = \frac{1+1+2}{2+2+2} = 0.667 \quad (7)$$

For each combination of father nodes values, the distribution among the three levels (High, Medium and Low) of the son node S is calculated as x^2 , $2x(1-x)$, and $(1-x)^2$ respectively. This distribution ensures the

266 normalization of the distribution and a suitable continuous parametrization, being a binomial distribution were
 267 the probability of success is x (Lewis 2011). In fuzzy theory, those equations are called membership functions.
 268 A membership function (MF) is a curve that defines how each point in the input space is mapped to a
 269 membership value (or degree of membership) between 0 and 1. Transforming the x value into a degree of
 270 membership is called fuzzification. One can choose from several types of membership functions, for instance
 271 triangular membership functions (for $x \in [0, 0.5]$ → the membership functions are $(-2x+1, 2x, 0)$ and for $x \in [0.5,$
 272 $1]$ → the membership functions are $(0, -2x+2, 2x-1)$). The summation of values at any point should always be
 273 equal to one regardless of the membership functions used. In this study, we opted for a set of continuous
 274 membership functions. A portion of the CPT of the son node S is presented in Table 1 where the total number
 275 of combinations is 27 (3^3)**Error! Reference source not found..**

276 Table 1 A CPT of a Son node given the states of the father nodes

Father nodes			Global value	States distribution of the Son Node S		
P1	P2	P3	$x = \frac{\sum_{i=1}^n y_i}{n \times \max}$	High x^2	Medium $2x(1-x)$	Low $(1-x)^2$
2	2	2	1.00	1.0000	0.0000	0.0000
2	2	1	0.83	0.6944	0.2778	0.0278
2	2	0	0.67	0.4444	0.4444	0.1111
2	1	2	0.83	0.6944	0.2778	0.0278
2	1	1	0.67	0.4444	0.4444	0.1111
2	1	0	0.50	0.2500	0.5000	0.2500
2	0	2	0.67	0.4444	0.4444	0.1111
2	0	1	0.50	0.2500	0.5000	0.2500
2	0	0	0.33	0.1111	0.4444	0.4444
1	2	2	0.83	0.6944	0.2778	0.0278
...

277

278 For the final output (resilience node in Figure 4), five states are defined: High, Good, Moderate, Low, and
 279 Vulnerable. In this case, five degrees are preferred for a more accurate understanding of the output level. The
 280 same procedure described in the previous paragraphs applies here with the resilience node being the son node
 281 and the resilience pillars being the father nodes.

282 3.4 Joint probability distribution

283 Each node in a Bayesian network is characterized by a probability distribution. All probabilities together form
 284 the joint probability distribution (JPD) of the BN. The JPD of a BN can be written as follows:

285
$$P(Z) = \prod_{i=1}^N P[Z^i | Pa(Z^i)] \quad (8)$$

286 where Z is the set of all variables, $P(Z)$ is the joint probability of the variables, $Pa(Z^i)$ is the set of variables
 287 that are parents of Z^i , $P(X_i | Pa(X_i))$ is the local probability distribution, N is the number of variables.
 288 Considering the system in Figure 4, the JPD can be calculated using Eq. (9).

289
$$\begin{aligned} P(X, R, Re) = & P(X_1) \cdot P(X_2) \cdot P(X_3) \cdot P(X_4) \cdot P(X_5) \cdot P(X_6) \cdot P(X_7) \cdot \dots \cdot P(X_N) \cdot \\ & P(R_1 | X_1, X_2, X_4, X_6) \cdot P(R_2 | X_3, X_5, X_6, X_7) \cdot P(R_3 | X_7, \dots, X_N) \cdot \\ & P(Re | R_1, R_2, R_3) \end{aligned} \quad (9)$$

290 **4. Example 1: resilience evaluation of the state of Brazil using BN**

291 4.1 Model definition: Hyogo Framework for Action

292 This section illustrates the static resilience framework introduced in Section 3. Given the increase in the number
 293 of natural and man-made disasters, the United Nations (UNISDR) have formulated a structured approach to
 294 help communities cope with unexpected disruptions. The conceived framework, firstly presented in the 2005
 295 UNISDR report ([ISDR 2005](#); [UNISDR 2008](#)), is known as the Hyogo Framework for Action (HFA). It is now
 296 considered a global blueprint for minimizing risk associated with natural hazards through the implementation
 297 of national laws for risk management and control ([Reinhorn et al. 2009](#)). The HFA was originally conceptualized
 298 in Kobe, Japan with the goal of encouraging countries to implement resilient measures in their respective laws.
 299 The lifespan for the implementation was from 2005 to 2015. After that, each of the participating countries was
 300 required to submit a report (a detailed questionnaire) on their own progress. A score was then given by the UN
 301 to each of the submitted reports based on the progress each country had made ([Kammouh et al. 2018c](#); [UNISDR](#)
 302 [2011](#)). The progress recorded by every country is computed on the basis of a five-point scale for each indicator,
 303 where ‘one point’ indicates weak progress while ‘five points’ implies a great endeavor and commitment in that
 304 specific area. The scores of the 22 indicators for 37 countries assessed by the United Nations are reported in
 305 Appendix.

306 The objective of the HFA is the significant reduction in losses after disasters ([Cimellaro et al. 2014a](#)). Following
 307 the resilience model introduced in Section 3.1, the HFA indicators are unfolded under the three resilience pillars:

- 308 a) Reduced Vulnerability: includes consideration of disaster risk that is aimed at preventing and mitigating
 309 disaster as well as reducing vulnerability;
- 310 b) Robustness: Strengthening of institutions and mechanisms at all level aiming at increasing resilience
 311 (P_2);
- 312 c) Adaptive and Recovery capacity: Structural embedding of risk reduction methods for emergency
 313 preparation, response, and recovery (P_3).

314 To increase the level of detail and to convert the strategic goals into operationalizable activities, the UNISDR
 315 introduces five priorities:

- 316 1. Ensure disaster risk reduction;
- 317 2. Identify, assess and monitor disaster risks and enhance early warning;
- 318 3. Use available physical and non-physical resources to build a culture of safety and resilience;
- 319 4. Reduce the underlying risk factors;
- 320 5. Strengthen disaster preparedness for effective response.

321 Each of the five priorities is further disaggregated into four to six indicators, summing up to a total of twenty-
 322 two Table 2). The indicators refer to the implementation of activities, mechanisms, or policies with the aim of
 323 risk reduction, preparation, and recovery.

324 4.2 Network structure and elements connectivity

325 To build the network, linking the indicators with the resilience pillars is necessary. Despite not being introduced
 326 in the UNISDR reports ([ISDR 2005](#); [UNISDR 2008](#)), the assignment of the indicators to one of the resilience
 327 pillars is performed as follows:

- 328 • If the indicator clearly refers to a regulatory requirement or action with proactive intent of risk reduction,
 329 it is assigned to P₁;
- 330 • If the indicator clearly refers to the implementation of institutional mechanisms or the building of
 331 resources for the proactive establishment of resilience capabilities, it is assigned to P₂;
- 332 • If the indicator clearly refers to the implementation of practices, mechanisms, and programs for
 333 emergency response and recovery, it is assigned to P₃. Note that it is possible for an indicator to affect
 334 more than one resilience pillar.

335 Table 2 shows a list of the indicators of the HFA grouped by priority. The BN is built following the procedure
 336 described in Section 3.2 (see Figure 5). It can be seen that P₁ is influenced by seven indicators (Q₁, Q₂, Q₁₃, Q₁₄,
 337 Q₁₅, Q₁₆, and Q₁₉), P₂ is influenced by eleven indicators (Q₃, Q₄, Q₅, Q₆, Q₈, Q₉, Q₁₁, Q₁₂, Q₁₉, Q₂₁, and Q₂₂),
 338 while strategic P₃ is impacted by eight indicators (Q₇, Q₈, Q₁₀, Q₁₁, Q₁₇, Q₁₈, Q₂₀, and Q₂₁). Only four indicators
 339 present an overlap between different resilience pillars: Q₈, Q₁₁, Q₂₁ (between P₂ and P₃) and Q₁₉ (between P₁
 340 and P₂).

341 Table 2 List of indicators of the Hyogo Framework for Action grouped by priority ([UNISDR 2011](#)).

<i>Priority</i>	<i>Indicator</i>	<i>Resilience pillar</i>
(1) Ensure that disaster risk reduction (DRR) is a national and a local priority with a strong institutional basis for implementation	Q1- National policy and legal framework for disaster risk reduction exists with decentralized responsibilities and capacities at all levels.	P1
	Q2- Dedicated and adequate resources are available to implement disaster risk reduction plans and activities at all administrative levels	P1
	Q3- Community Participation and decentralization is ensured through the delegation of authority and resources to local levels	P2
	Q4- A national multi sectoral platform for disaster risk reduction is functioning.	P2
(2) Identify, assess and monitor disaster risks and enhance early warning	Q5- National and local risk assessments based on hazard data and vulnerability information are available and include risk assessments for key sectors.	P2
	Q6- Systems are in place to monitor, archive and disseminate data on key hazards and vulnerabilities	P2
	Q7- Early warning systems are in place for all major hazards, with outreach to communities.	P3

	Q8- National and local risk assessments take account of regional / trans boundary risks, with a view to regional cooperation on risk reduction.	P2-P3
(3) Use knowledge, innovation, and education to build a culture of safety and resilience at all levels	Q9- Relevant information on disasters is available and accessible at all levels, to all stakeholders (through networks, development of information sharing systems etc.)	P2
	Q10- School curricula, education material and relevant trainings include disaster risk reduction and recovery concepts and practices.	P3
	Q11- Research methods and tools for multi-risk assessments and cost benefit analysis are developed and strengthened.	P2-P3
	Q12- Countrywide public awareness strategy exists to stimulate a culture of disaster resilience, with outreach to urban and rural communities.	P2
(4) Reduce the underlying risk factors	Q13- Disaster risk reduction is an integral objective of environment related policies and plans, including for land use natural resource management and adaptation to climate change.	P1
	Q14- Social development policies and plans are being implemented to reduce the vulnerability of populations most at risk.	P1
	Q15- Economic and productive sectorial policies and plans have been implemented to reduce the vulnerability of economic activities	P1
	Q16- Planning and management of human settlements incorporate disaster risk reduction components, including enforcement of building codes.	P1
	Q17- Disaster risk reduction measures are integrated into post disaster recovery and rehabilitation processes	P3
	Q18- Procedures are in place to assess the disaster risk impacts of major development projects, especially infrastructure.	P3
(5) Strengthen disaster preparedness for effective response at all levels	Q19- Strong policy, technical and institutional capacities and mechanisms for disaster risk management, with a disaster risk reduction perspective are in place.	P1-P2
	Q20- Disaster preparedness plans and contingency plans are in place at all administrative levels, and regular training drills and rehearsals are held to test and develop disaster response programs.	P3
	Q21- Financial reserves and contingency mechanisms are in place to support effective response and recovery when required.	P2-P3
	Q22- Procedures are in place to exchange relevant information during hazard events and disasters, and to undertake post-event reviews	P2

342

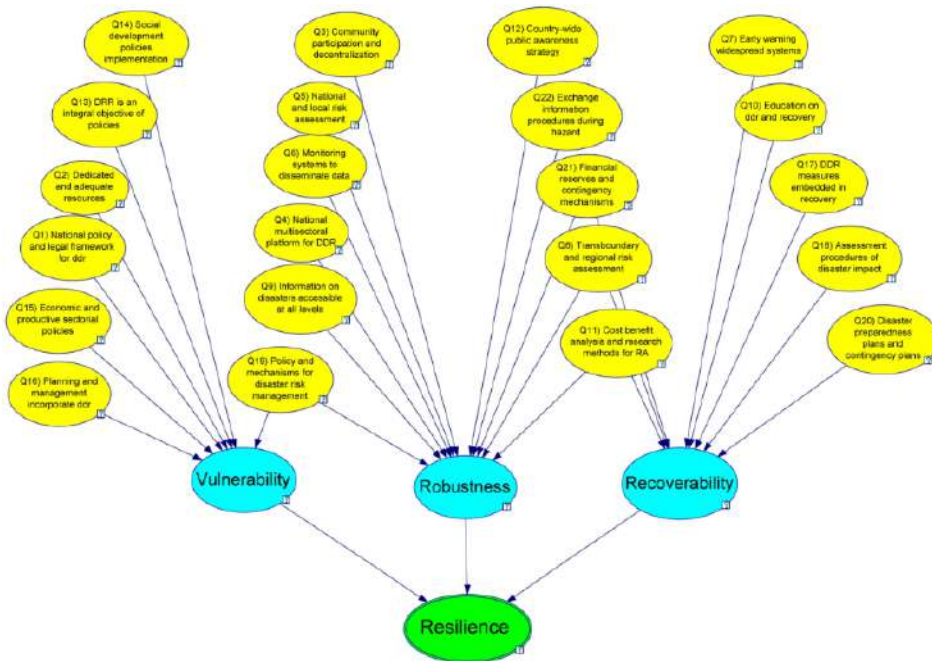

343

344

Figure 5 Bayesian Network of the Hyogo framework indicators

345

346 4.3 Probability tables and inference

347 4.4 Results

348 Figure 6 shows a Bayesian network applied to the data of the country “Brazil” (row 26 in Appendix). The
349 analysis is done using GeNIe modeler, a graphical user interface that allows for interactive model building and
350 learning based on the Bayes’ inference theory ([BayesFusion 2016](#)). The top level of the network presents the
351 main activities to be performed at the national and local levels, the intermediate level includes the three
352 resilience pillars, and the bottom level node is the output of the network (i.e., resilience). As can be noticed in
353 Figure 6, the three resilience pillars have a probability distribution for their different states despite that the
354 indicators are deterministic. This is caused by the CPTs as well as the characteristics of the Bayesian inference
355 adopted in the study. The final output of resilience presents a range of uncertainty (16% High, 28% Good, 31%
356 Moderate, 19% Low, and 7% Vulnerable) (Note: the sum is 101 instead of 100 because the tool used in the
357 analysis rounds the values to the nearest whole number). In the analyzed scenario, the resilience state of the
358 country Brazil is most likely to be “Moderate” given that this state has obtained the highest probability.

359 The Bayesian network can also be employed in a backward analysis. A deterministic resilience state can be set
360 (for instance “Good”) and the output would be the levels of the indicators required to achieve the assumed
361 resilience state. This is rather useful in case of system design or system improvement.

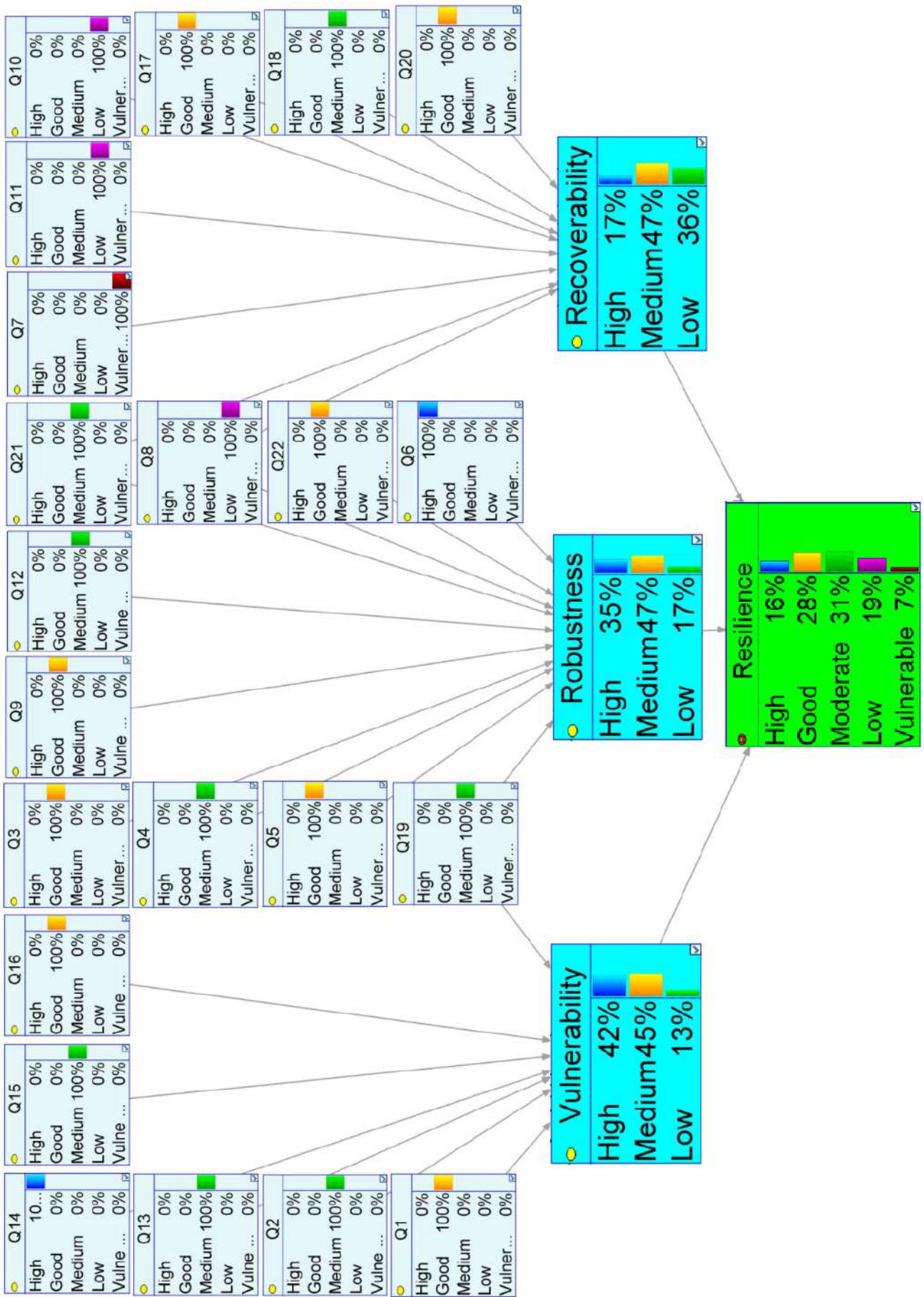

362

363

Figure 6- BN analysis and resilience results of the country “Brazil”

364

4.5 Sensitivity analysis

365 Sensitivity analysis can help validate the probability parameters of a Bayesian network. It is done by
366 investigating the effect of small changes in the values (probabilities) of the input parameters on the output.
367 Identifying highly sensitive parameters allows for a directed allocation of effort in order to obtain accurate
368 results of a Bayesian network model.

369 In this example, an algorithm proposed by ([Kjærulff and van der Gaag 2000](#)) is implemented. Given a set of
370 target nodes, a complete set of the derivatives of the posterior probability distributions over the target nodes
371 over each of the numerical parameters of the Bayesian network are efficiently calculated. These derivatives
372 indicate the importance of precision of network numerical parameters for calculating the posterior probabilities
373 of the targets. A large derivative of a parameter p leads to a large variation in the posteriors of the targets given
374 a variation in the parameter p . If the derivative is small, then even large changes in the parameter make little
375 difference in the posteriors.

376 Each state of the target node is treated individually when performing a sensitivity analysis. Hence, the sensitivity
377 analysis shows the most sensitive parameters for a selected state of the target node. Figure 7-9 show the
378 sensitivity analysis done for the resilience target node states High, Moderate, and Low. The bar shows the range
379 of changes in the target state as the parameter changes in its range. Only the 10 most influential parameters are
380 plotted. The color of the bar shows the direction of the change in the target state, red expresses negative and
381 green expresses positive change. We can clearly see that each parameter state can have a different sensitivity
382 on the target node. For instance, as we can see in Figure 7, the parameter Q19 with a state “High” is the most
383 sensitive parameter to the target node Resilience with state High. This is followed by Q11(High) and Q8(High).
384 In Figure 8, in which the sensitivity analysis for Resilience with state “Moderate” is done, the most sensitive
385 parameter is Q11(High). This is followed by Q8(High) and Q21(High). Figure 9 presents a different order of
386 sensitive parameters where the analysis is for Resilience with state “Vulnerable”. It is worth to note that these
387 sensitivity results are affected by the conditional probabilities given by the user.

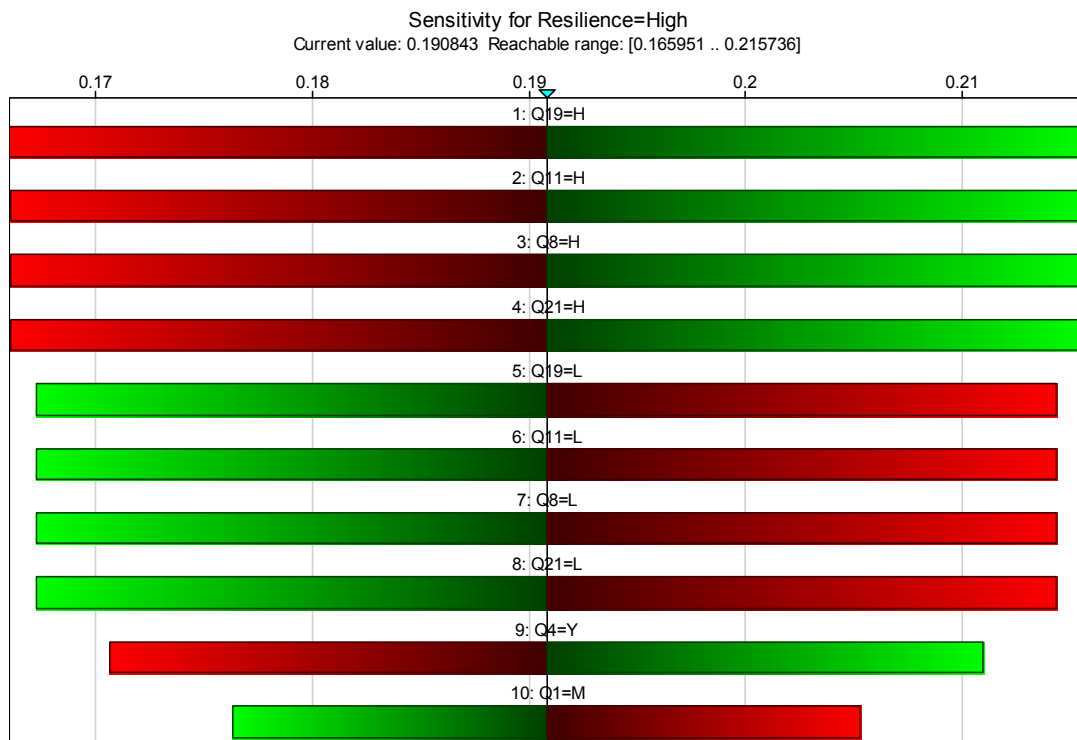

388

389

Figure 7 Sensitivity analysis for *Resilience* with a state *High*

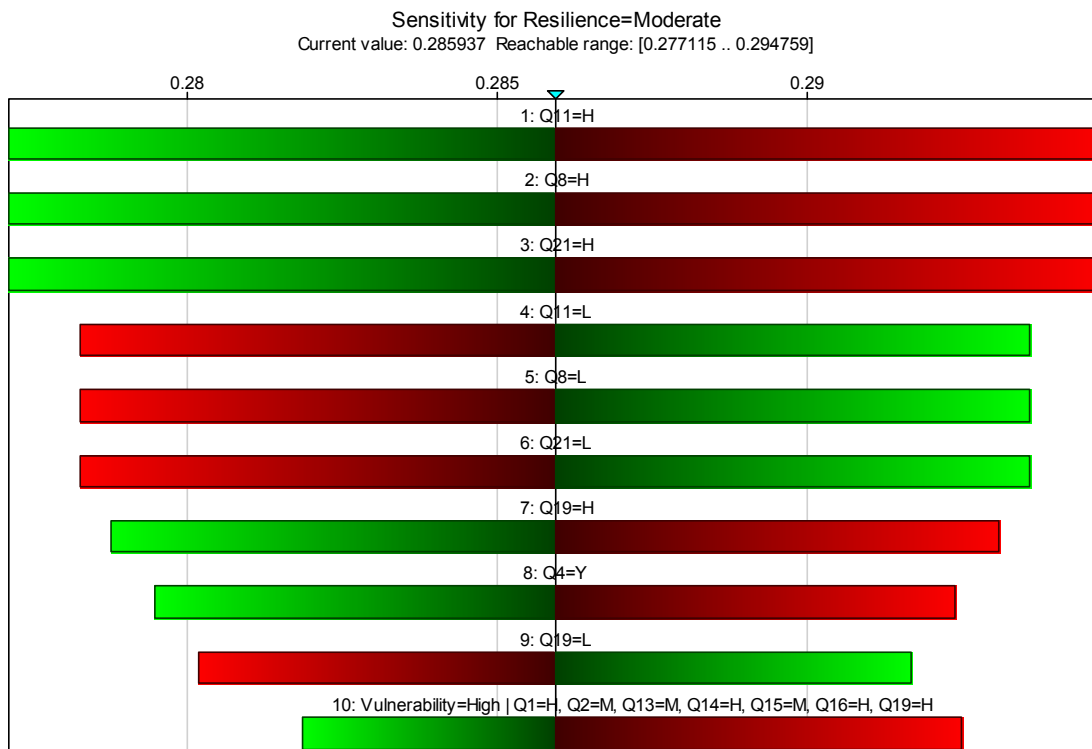

390

391

Figure 8 Sensitivity analysis for *Resilience* with a state *Moderate*

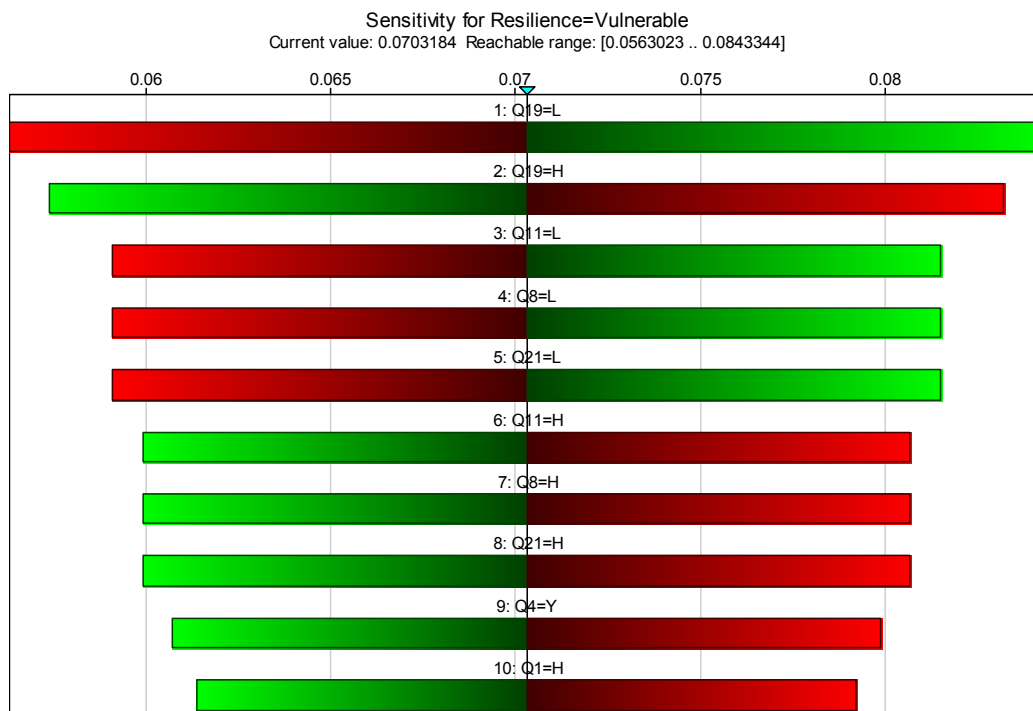

Figure 9 Sensitivity analysis for *Resilience* with a state *Vulnerable*

5. Time-dependent resilience analysis using Dynamic Bayesian Networks

In general, the resilience of a system tends to be a process rather than a state; thus, accounting for the performance variation of a system can be important. Ordinary Bayesian Networks are unable to account for the time dimension in the analysis as they are limited to static systems. In this section, we propose a new methodology to assess the resilience of engineering systems in a dynamic manner.

5.1 Dynamic resilience model

The resilience model used in the dynamic resilience analysis is based on the resilience definition by [Bruneau and Reinhorn \(2007\)](#) who describe the resilience of a system using four components, also called the four R's of resilience (4R's):

- *Robustness* (R_1): refers to the ability of a system to stand a certain level of stress preserving its functionality;
- *Redundancy* (R_2): indicates the alternative resources in the recovery stage when the primary ones are inadequate;
- *Rapidity* (R_3): the capacity to contain losses and avoid future disruption. It represents the slope of the functionality curve during the recovery phase;
- *Resourcefulness* (R_4): considers the human factor and the capacity to move needed resources.

This model is more detailed and more suitable to study dynamic events than the one described in Section 3.1; therefore, this model will be used hereafter. As shown in Figure 10, the first two resilience components (R_1 and

413 R_2) define the damage level the system may encounter if exposed to a certain hazard. Robust and redundant
 414 systems would most likely experience less damage and function almost normally after the disaster. On the other
 415 hand, once damage occurs, the system's recovery starts. The recovery process is defined by the recovery
 416 capacity and resources availability, such as human resources. Thus, the other two components (R_3 and R_4)
 417 interfere during the recovery stage as they are the main drivers of the system's recovery.

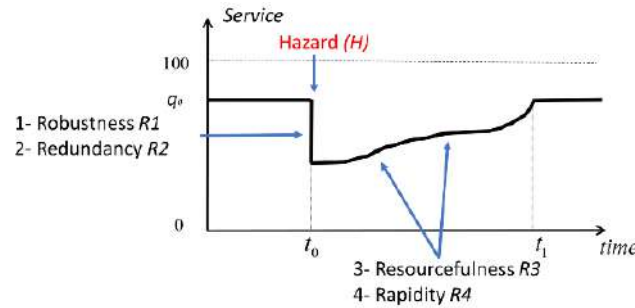

418

419 Figure 10 The four resilience components (4R's) and their interaction with the resilience curve

420 5.2 Network structure and elements connectivity

421 DBN is a series of Bayesian networks with changing conditions. The elements connectivity within a single time
 422 step of a DBN is treated similarly to what introduced before (see Section 3.2 and Figure 4). One main
 423 characteristic of DBN is that elements are connected through different time-steps. For example, element A_t can
 424 be linked to element B_{t+1} using a temporal link if element B_{t+1} has a dependency on A_t , where t is the time step.
 425 The connections between elements at different time steps is done using expert knowledge or from past data.
 426 Figure 11 shows a DBN where the individual networks at the different time steps are connected with one another.
 427 In our methodology, an element in a BN at time-step t can only affect itself at time-step $t+1$ (i.e., A_t affects A_{t+1}
 428 and B_t affects B_{t+1}).

429 Regarding the four resilience components (4R's), they are incorporated in the network at different time-steps.
 430 In Figure 11, the first step ($t=1$) corresponds to the initial state of the system (i.e., before hazard occurrence).
 431 At this stage, none of the 4R's is involved as the aim is to assess the initial performance of the system. The
 432 second step ($t=2$) is dedicated to assessing the damage that would incur if a hazard of a certain magnitude
 433 occurs. The level of damage, or the drop in the functionality, can be determined by acquiring information about
 434 the hazard (H) and the system's characteristics (i.e., R_1 and R_2). The combination of the parameters H, R_1 , and
 435 R_2 can provide valuable information on how a system with a predefined initial state would behave. Thus, the
 436 two resilience components R_1 and R_2 are connected to the DBN at the second time-step ($t=2$).

437 Once the drop in the serviceability is determined, the recovery needs to be evaluated. Since recovery is not an
 438 instantaneous action, several DBN time steps are needed here. Therefore, the recovery period is divided into a
 439 finite number of time-steps. Information about the rapidity and the resourcefulness (R_3 and R_4) of the system is
 440 integrated at all recovery time-steps as they will define how the variables (i.e., the indicators) will evolve from
 441 one step to another. Therefore, the same Bayesian network is copied from time-step $t=3$ until time step $t=T$.

442 The result of each BN is a performance point. The collection of the performance points creates a resilience
 443 function that shows the changes in the system's performance, starting from a stable state (the first uniform part
 444 of the function in Figure 11) and ending with a stable state, when the system is fully recovered (the second
 445 uniform part of the function). Once obtained, the resilience function can be used to obtain a resilience index.
 446 One method uses the area above the resilience curve and links it to the notion "loss of Resilience" (Bruneau and
 447 Reinhorn 2007; Cimellaro et al. 2010a) while other methods consider other metrics to quantify the resilience
 448 (Sharma et al. 2018).

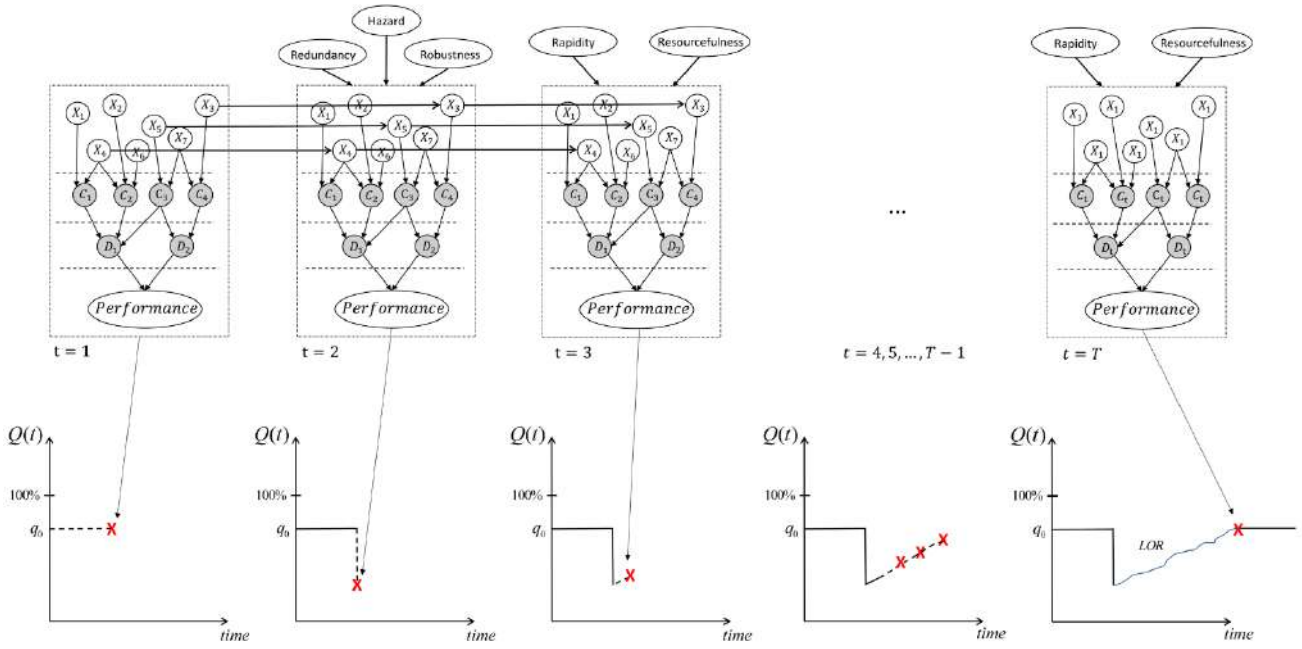

449

450 Figure 11 Dynamic Bayesian network of an engineering system considering external factors such as the
 451 resilience characteristics (4R's) and the Hazard

452

5.3 Joint probability distribution

453 The proposed dynamic resilience analysis using the DBN approach can be mathematically written in
 454 probabilistic terms, as follows:

$$\begin{aligned}
 P(C, Z_{1:T}, H, R_1, R_2, R_3, R_4) &= \left[P(C) \cdot \prod_{i=1}^N P(Z_{t=1}^i | Pa(Z_{t=1}^i), C^i) \right] \\
 &\left[P(H) \cdot P(R_1) \cdot P(R_2) \cdot \prod_{i=1}^N P(Z_{t=2}^i | Pa(Z_{t=2}^i), C^i, H^i, R_1^i, R_2^i) \right] \\
 &\left[P(R_3) \cdot P(R_4) \cdot \prod_{i=3}^T \prod_{i=1}^N P(Z_i^i | Pa(Z_i^i), C^i, R_3^i, R_4^i) \right]
 \end{aligned} \quad (10)$$

456 where C is the set of all static variables (contemporal variables), Z is the set of all dynamic variables (temporal
 457 variables), $P(C)$ is the joint probability of the static variables, $Pa(Z^i)$ is the set of variables that are children of
 458 Z^i , H is the hazard variable, R_1 is the Redundancy variable, R_2 is the Redundancy variable, R_3 is the Rapidity
 459 variable, R_4 is the Resourcefulness variable, N is the number of dynamic indicators, T is the total number of
 460 time steps. The first term on the right-hand side of Equation (10) refers to the joint probability of the variables

461 at the first time-step, the second term refers to the joint probability of the variables at the second time-step,
 462 while the third part of the equation considers the remaining time steps.

463 6. Example 2: resilience evaluation of a transportation network using DBN

464 6.1 Model definition: Modeling the physical aspect of a transportation network

465 To illustrate the dynamic methodology introduced above, an illustrative example of a typical transportation
 466 system is used. The resilience of engineering systems can be systematically described using a layered diagram.
 467 Figure 12 shows a scheme of a general engineering system, being resilience the top level. The resilience node
 468 is defined using a set of dimensions. Each dimension is divided into components, and the components are further
 469 divided into indicators. The lower level of the diagram is the “Measures” layer, which provides descriptions on
 470 how the indicators can be numerically evaluated. Having different layers allows for a detailed description of the
 471 system. A similar approach of modeling a port infrastructure system is introduced in (Balbi et al. 2018).

472 For the sake of this study, a general indicator-based model to describe transportation systems is proposed. The
 473 model consists of Seven dimensions divided into 21 Components. The components are further divided into 78
 474 indicators, which are allocated with measures to provide practical information on the computation of each
 475 indicator. The indicators included in the model have been collected from exclusively renowned literary
 476 publications and then allocated to the proper components. The components themselves have been proposed
 477 ensuring a good coverage of the different aspects of the transportation infrastructure. Much effort has been done
 478 to reduce the overlap among indicators by removing the duplicated ones. For this, expert opinions have been
 479 used. This has led to a condensed list of indicators. The authors have also proposed some indicators when needed
 480 to ensure the exhaustiveness of the model.

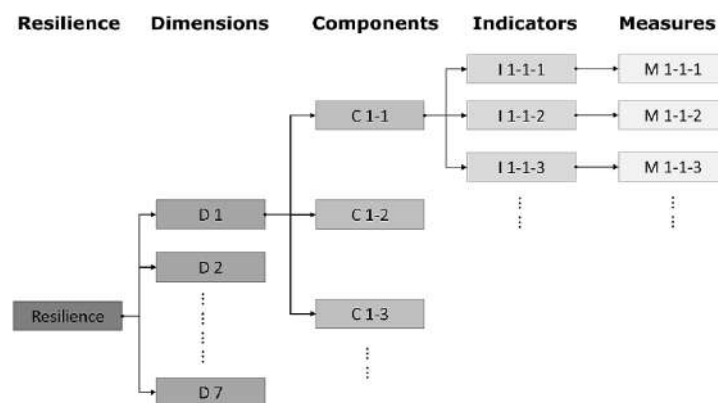

481
 482 Figure 12 An indicator layered-model to systematically describe engineering systems

483 Table 3 presents the seven dimensions of the proposed model: (1) Physical infrastructure, (2) User’s behavior,
 484 (3) Resources, (4) Plan, (5) Organization and management, (6) Social-economic characteristics, and (7)
 485 Environment and climate. To keep it simple, only the first dimension (Physical infrastructure) is used in this
 486 study, and therefore only the first dimension is expanded with the list of components, indicators, and measures
 487 (Table 3). The last two columns in the table represent the importance factor (I) and the Nature (Nat) of the
 488 indicators, respectively. The importance factor provides a tool to weight the variable. Several methods for

489 defining the importance factors exist in the literature. For example, [Kammouh et al. \(2019b\)](#) proposed a matrix-
 490 based methodology to compute the weight of variables based on the level of interdependency with other
 491 variables. That is, if many variables depend on a certain variable, the latter is assigned a high importance factor.
 492 Other methods suggest a subjective assignment of the weighting factors by an expert in the related field. This
 493 process is simpler but can produce inaccurate results. The Nature of the indicator (Nat) divides the indicators
 494 according to their type “static” or “dynamic”.

495 Figure 13 shows a graphical representation of a static and dynamic indicators. For static indicators, the
 496 functionality remains constant with time given that they are not affected by hazards. Dynamic indicators, on the
 497 other hand, are affected by hazards, and consequently their functionality changes with time. Dynamic indicators
 498 are defined using a set of variables (q_0, q_1, T_r, q_f) where q_0 is the normalized serviceability before the event, q_1
 499 is the residual functionality after the disaster, q_f is the functionality after recovery, T_r is the restoration time or
 500 the time needed to finish the recovery process.

501 Each indicator is normalized with respect to a fixed quantity, the target value (TV). The target value is an
 502 essential quantity that provides the baseline to measure the resilience of a system. The system’s existing
 503 functionality at any instance of time is compared to the target value to know how much functionality deficiency
 504 is experienced by the system.

505 Table 3 Variables of the proposed transportation network model with corresponding importance factors (I)
 506 and nature (Nat)

Dimension/ component/ indicator	Measure ($0 \leq \text{value} \leq 1$)	Reference	I	Nat
1- Physical infrastructure			3	
<i>1-1- Links/ Connectors</i>			<u>3</u>	
-Accessibility	Number of links/passageways per destination \div TV	(Ip and Wang 2011)	3	D
-Road density	Number of alternative links between an origin and destination \div TV	(Jenelius 2009)	3	D
-Road width	Average width of road \div TV	(Jenelius 2009)	2	S
-Lanes of road	Number of lanes available \div TV	(Litman 2006)	2	D
-Link (road, track, etc.) condition	% links with full functionality during the event		3	D
<i>1-2- Vehicles</i>			<u>2</u>	
-Mode of transport	Number of multi-mode choices per destination \div TV	(Ip and Wang 2011)	3	D
-Service level	Average speed of vehicles in normal condition \div TV	(Sarkis et al. 2018)	1	S
-Characteristics of vehicles	Degree of preference of specific vehicles (regarding performance, comfort level, etc.) \div TV		1	S
<i>1-3- Other Facilities/ Structures</i>			<u>3</u>	
-Quality of facilities	1-(% deficiency of facilities in past events \div TV)	(Tamvakis and Xenidis 2012)	3	S
-Critical components	Number of roundabout/emergency lanes \div TV	(Kammouh et al. 2017a; Kammouh et al. 2018a)	2	S

-Maintenance of facilities	Number of maintenances during an interval of period \div TV	(Tamvakis and Xenidis 2012)	3	S
-Essential infrastructure robustness	% infrastructures that remained operational during emergencies in past events	(UNISDR 2012)	2	S
-Traffic load capacity	Number of excessive capacity (emergency lanes, tracks, airlines, etc.) \div TV	(Cox et al. 2011)	3	D
-Urban form	Number of city centers per 100,000 people \div TV	(Mishra et al. 2012)	3	S
-Size of network (connectivity)	Number of connectivity of intersection \div TV	(Zhang et al. 2011)	2	D
-Size of network (betweenness)	1-(Number of betweenness of intersections \div TV)	(Zhang et al. 2011)	2	D
1-4- Accessories			<u>1</u>	
-Tool kit inside vehicles	1 (Presence of tool kits, like extinguisher, escape hammer, etc.); 0 (otherwise)		2	S
-Path environment	Number of safety elements (isolation strips, traffic lights, etc.) per km \div TV	(Soltani-Sobh et al. 2016)	2	S
1-5- Serviceability			<u>2</u>	
-Characteristics of traffic lines	Frequency and capacity of each line \div TV	(Dorbritz 2011)	3	D
-Travel time reliability	number of punctual service assisted by control system \div total number of service	(Leu et al. 2010)	2	S
2- User's behavior				
3- Resources				
4- Plan				
5- Organization and management				
6- Social-economic characteristics				
7- Environment and climate				

507

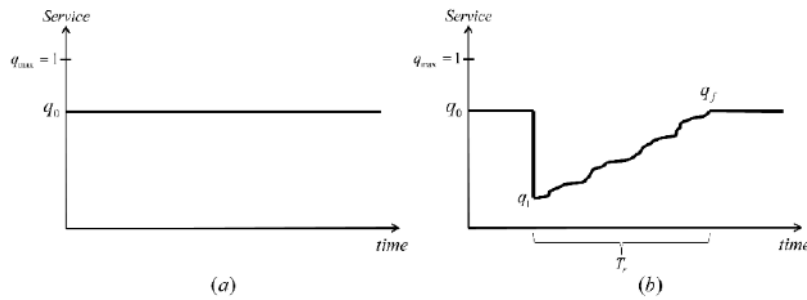

508

509

Figure 13 a) Event-non-sensitive indicator (static) b) event-sensitive indicator (dynamic)

510

6.2 Network structure and elements connectivity

511

512

513

514

515

516

517

Figure 14 presents the network structure and elements connectivity using the software GeNIe ([BayesFusion 2016](#)). The network has been built following Section 5.2. A color code is used to distinguish the variables in the network. Variables that are outside the box are static variables. They are assigned unconditional probability tables (UPTs) that do not change throughout the analysis. Variables inside the green box are dynamic variables. The dynamic indicators (i.e., variables inside the green box and colored in yellow) are assigned UPTs for the first time-step and CPTs for the remaining time steps. The CPTs are used to define the functionality of the indicator at time $(t+1)$ given its functionality at time (t) and given external variables (i.e., damage and recovery

518 variables). The damage variables H , R_1 , and R_2 are used to determine the amount of damage the indicators are
 519 exposed to following the hazard. Therefore, the damage variables interfere only at the second time-step (see
 520 Figure 11) and their effect is reflected in the CPTs of the dynamic indicators at time slice 2. On the other hand,
 521 the recovery variables R_3 and R_4 feed the dynamic indicators from time slice 3 until the last time-slice (see
 522 Figure 11). The effect of these variables is reflected in the CPTs of the dynamic indicators for all time slices
 523 starting from time slice 3. For the first time-slice, the system is assessed for its initial condition. That is, the
 524 effect of the damage and recovery variables is not considered, and so the dynamic indicators have no father
 525 nodes for this time slice. The tool used for the analysis allows determining at what step each variable interferes.

526 Other variables inside the green box are the variables colored in Orange (components) and Blue (dimensions).
 527 such variables are dynamic, and their value is defined using CPTs that consider the values of their father nodes.
 528 The father nodes of the components are the indicators while the father nodes of the dimensions are the
 529 components. The damage and recovery variables do not affect the components or the dimensions directly. Their
 530 effect is transmitted through the indicators to the lower levels of the network. The connectivity between the
 531 indicators and the components or between the components and the dimensions can be defined using expert
 532 knowledge and experience.

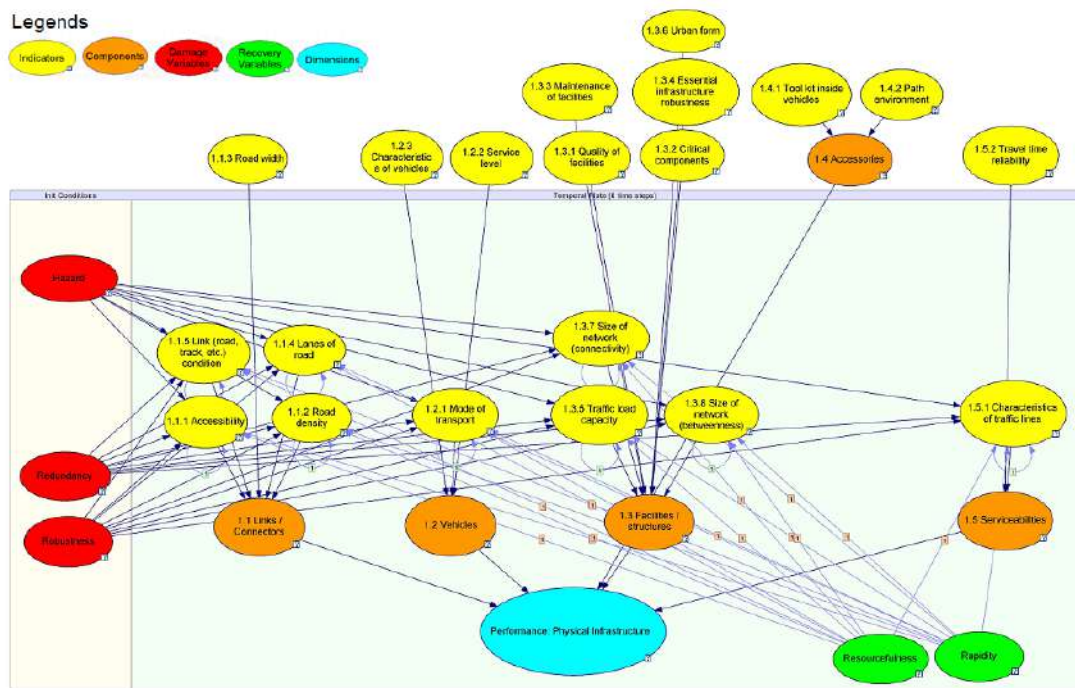

533

534 Figure 14 DBN connectivity of the transportation network model

535

6.3 Probability tables and inference

536

In the dynamic analysis, CPTs are assigned to variables that have father nodes in the same or different time-
 537 slice. For example, “components” are assigned CPTs that consider their father nodes (i.e., indicators), while
 538 each dynamic indicator (i.e., indicator that has a temporal link) is assigned a CPT that considers the indicator
 539 itself at a previous time-slice as well as the damage and recovery variables, depending on the time step. The
 540 same procedure used in Section 3.3 can be used to conclude all CPTs and UPTs of the model’s variables.

541

6.4 Results

542 Five scenarios have been implemented for comparative reasons. Table 4 summarizes the inputs of the damage
 543 and recovery variables for the different scenarios. For the sake of simplicity, each variable is assigned a three-
 544 level scale (High, Medium, and Low). For all scenarios, the states of the static indicators are assigned a uniform
 545 probability distribution. This is usually done when little or no information about the variables is available.
 546 However, when data is available, different probability distribution among the three states can be set. The result
 547 of the analysis is the performance level of the system. Since the analysis is dynamic, the result is a curve showing
 548 the variation of the performance in time. Four time-steps (or time-slices) are assigned to the analysis as a time
 549 interval. In the following, each scenario is tackled separately then a comparison between the scenarios
 550 highlighting the effect of the different variables on the performance level of the system is performed.

551

Table 4 Values for the different input variables

Input	Scenario 1 (Figure 15)	Scenario 2 (Figure 16)	Scenario 3 (Figure 17)	Scenario 4 (Figure 18)	Scenario 5 (Figure 19)
Hazard (H)	High	High	Low	Low	High
Redundancy (R_1)	Low	Low	High	High	Low
Robustness (R_2)	Low	Low	High	High	Low
Resourcefulness (R_3)	High	Low	Low	High	Medium
Rapidity (R_4)	High	Low	Low	High	Medium

552 Note: the red color implies negative impact on the performance, the green color implies a positive impact, and
 553 the orange color implies medium impact.

554

Scenario 1

555 Figure 15 shows the result of the first scenario. The states of the damage and recovery variables are set according
 556 to Table 4: the damage variables are set to negative impact (i.e., H is set to “High” while R_1 and R_2 are set to
 557 “Low”) while the recovery variables are set to positive impact (i.e., R_3 and R_4 are set to “High”). To discuss the
 558 analysis results, we will focus on the node “Performance” (i.e., node in Blue color). The result is presented as a
 559 probability variation for each of the three states of the variable. From Figure 15, we can see that the probability
 560 for the node “Performance” being “High” starts very low then it increases rapidly to reach a stable state. This
 561 result is expected since our initial input for the damage is set to *negative impact*, which caused the probability
 562 for the system’s performance of being “High” to be low in the beginning. On the other hand, the recovery
 563 variables have been set to *positive impact*, and this caused the probability of the system’s performance of being
 564 “High” to increase rapidly over time. The probability does not reach 1 because of the uncertainties introduced
 565 in the static indicators, which have been transmitted throughout the network. As a complementary, the
 566 probability of being “Low” starts relatively high then it reduces over the time with the same rate.

567

Scenario 2

568 In the second scenario (Figure 16), the damage variables are kept as before (high damage or negative impact)
 569 but the recovery variables have been changed from high to low. The effect of setting the recovery variables to
 570 low is reflected in the performance node. We can see that the initial probabilities are exactly like the first

571 scenario, as the damage variables are the same, but the probabilities do not evolve similarly with time. The
572 probability of being “High” starts low and remains low for all time steps, unlike in the first scenario where there
573 was a noticeable increase in this probability. This is due to the recovery variables which have been set to low,
574 where low stands for limited or no recovery activities.

575 ***Scenario 3***

576 As for the third scenario, the damage variables have been switched from negative impact to positive impact.
577 This is done by setting H to “Low” and both R_1 and R_2 to “High” (Figure 17). On the other hand, the recovery
578 variables are kept “Low”. The Performance node appears to start with a high probability of being “High” and
579 remains constant with time. This is because, as the inputs suggest, the damage is low and there is no recovery.
580 No recovery is observed for two reasons: a) there is no damage margin to recover, and b) the recovery variables
581 are set to low.

582 ***Scenario 4***

583 In the fourth scenario, the damage variables are kept as in the third scenario (i.e., positive impact) while the
584 recovery variables are switched back to “High”. The result is shown in Figure 18 where the probability of being
585 “High” starts relatively high and then slightly increases before it becomes stable. The only difference between
586 the result in this scenario and the previous scenario is the slight increase in the performance. This slight increase
587 in the probability is due to the high recovery capacity of the system. However, the high recovery capacity of the
588 system was not needed in this case as there was not a damage margin to recover.

589 ***Scenario 5***

590 Last scenario is similar to the first scenario with the only difference that the recovery variables are set to medium
591 instead of high (Figure 19). As a result, the increase in the probability of being “High” of the performance node
592 in this scenario is less than that in scenario 1. We can see a steady increase in the probability until it reaches a
593 stable state at the end of the curve.

594 In all the cases, we can see that the state “Medium” of the performance node has a certain probability. As
595 mentioned before, this is due to the uncertainty introduced in the static indicators which are propagated in the
596 network. Moreover, the dynamic variables inside the box (i.e., dynamic indicators and dynamic components)
597 are impacted by external variables such as the static indicators and the damage/recovery variables. The dynamic
598 indicators, in particular, are affected by the indicators themselves at previous time steps due to the presence of
599 temporal links (arrow going from the indicator to itself).

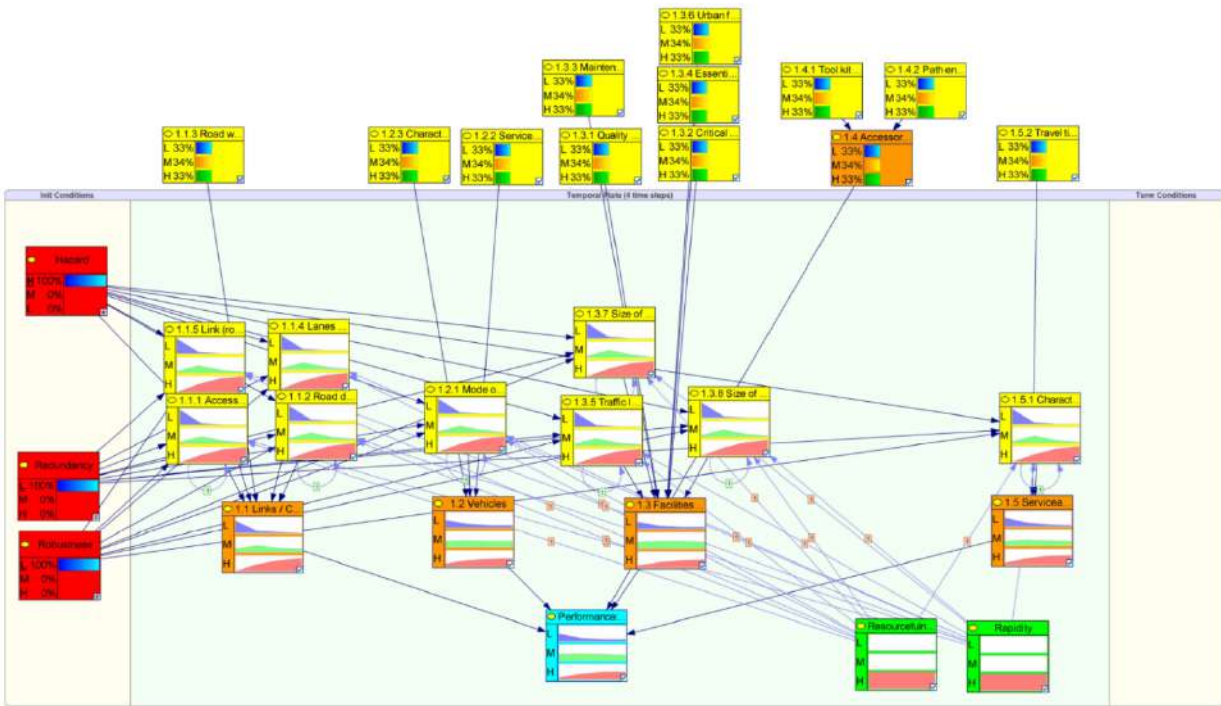

600

601

602

603

Figure 15 System's performance results for the first scenario of the simulation (high damage, high recoverability)

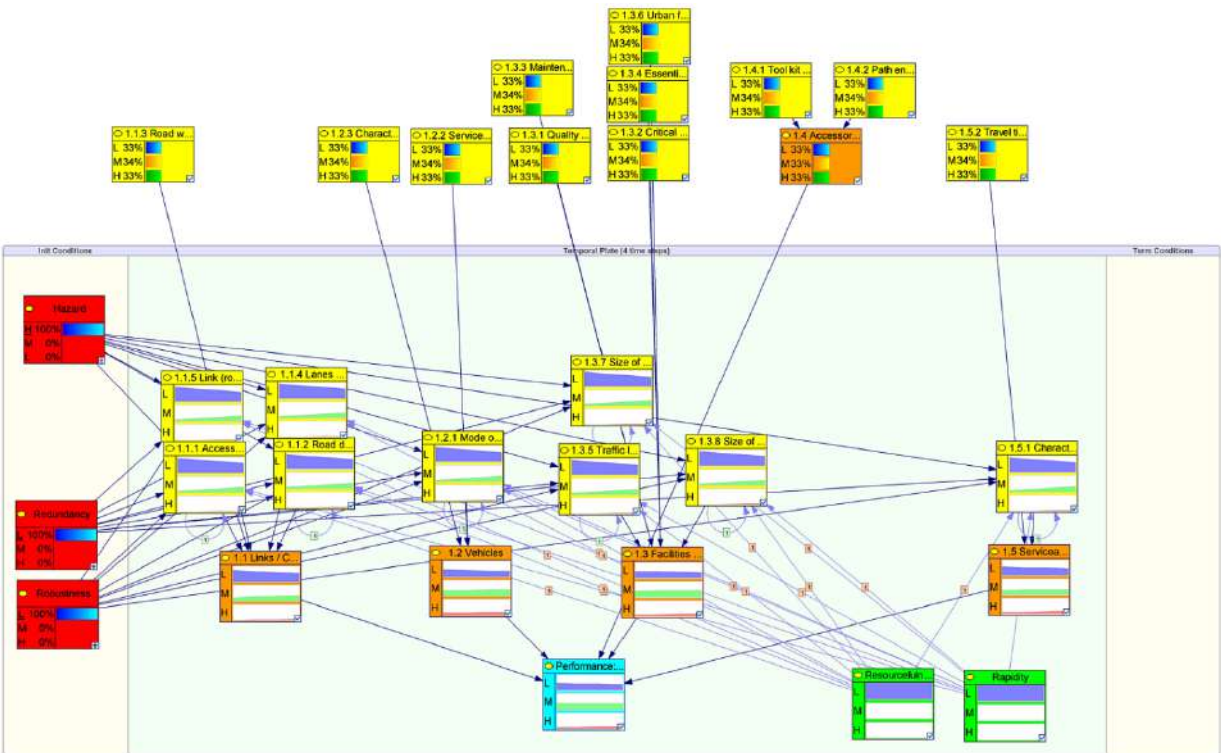

604

605

606

607

Figure 16 System's performance results for the second scenario of the simulation (high damage, low recoverability)

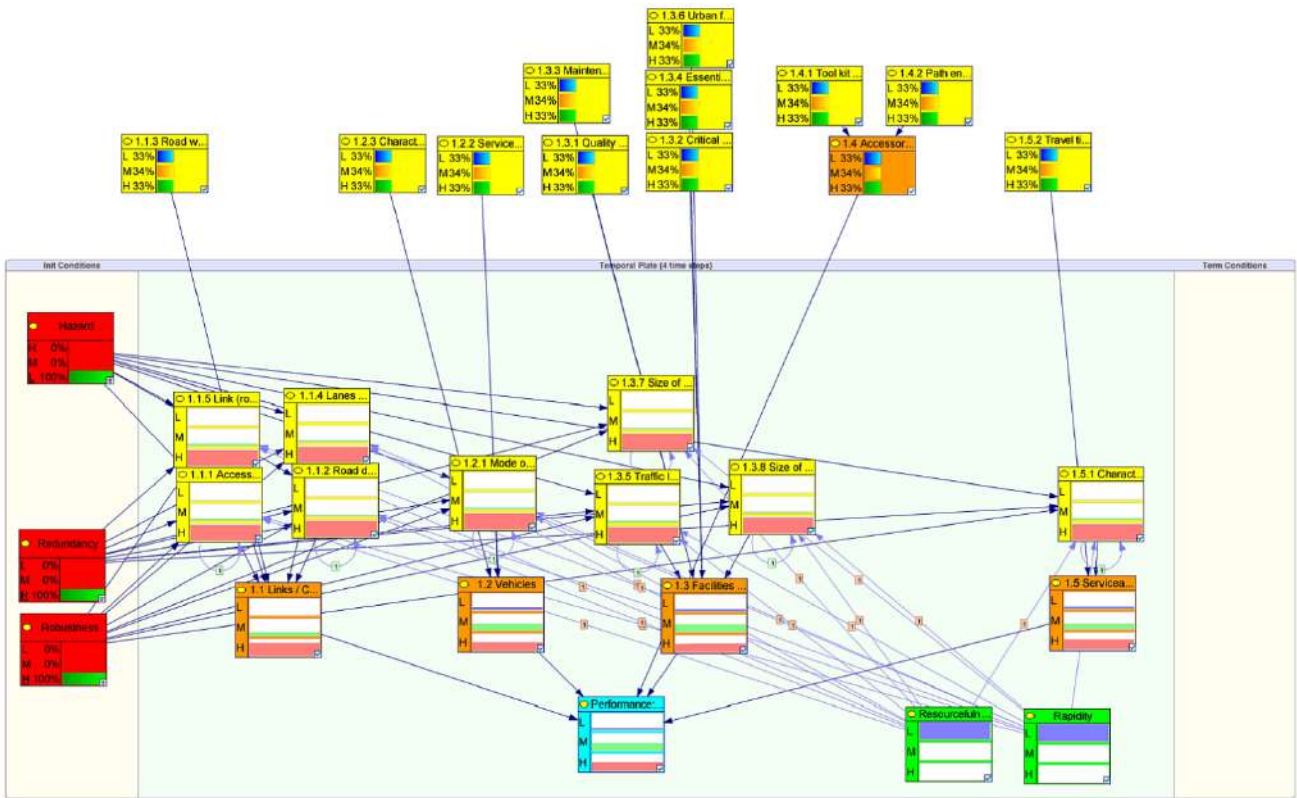

608

609

610

Figure 17 System's performance results for the third scenario of the simulation (low damage, low recoverability)

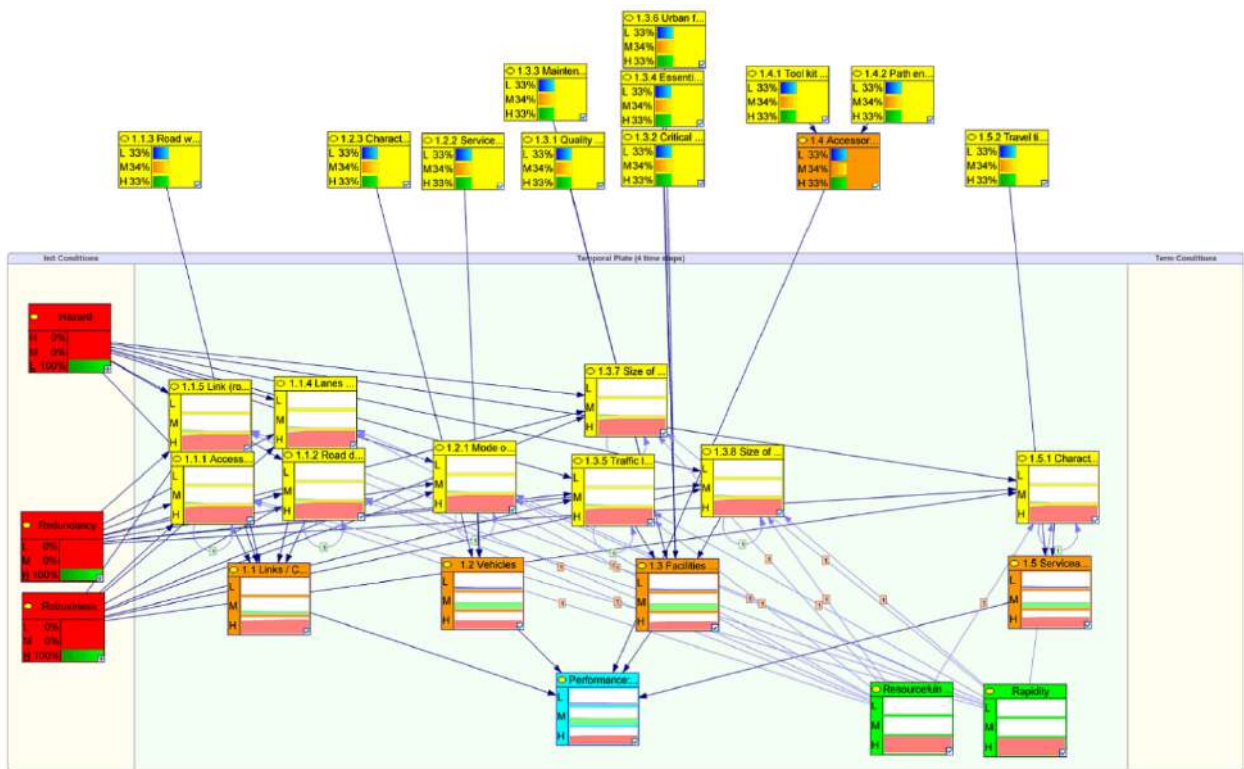

611

612

613

614

Figure 18 System's performance results for the fourth scenario of the simulation (low damage, high recoverability)

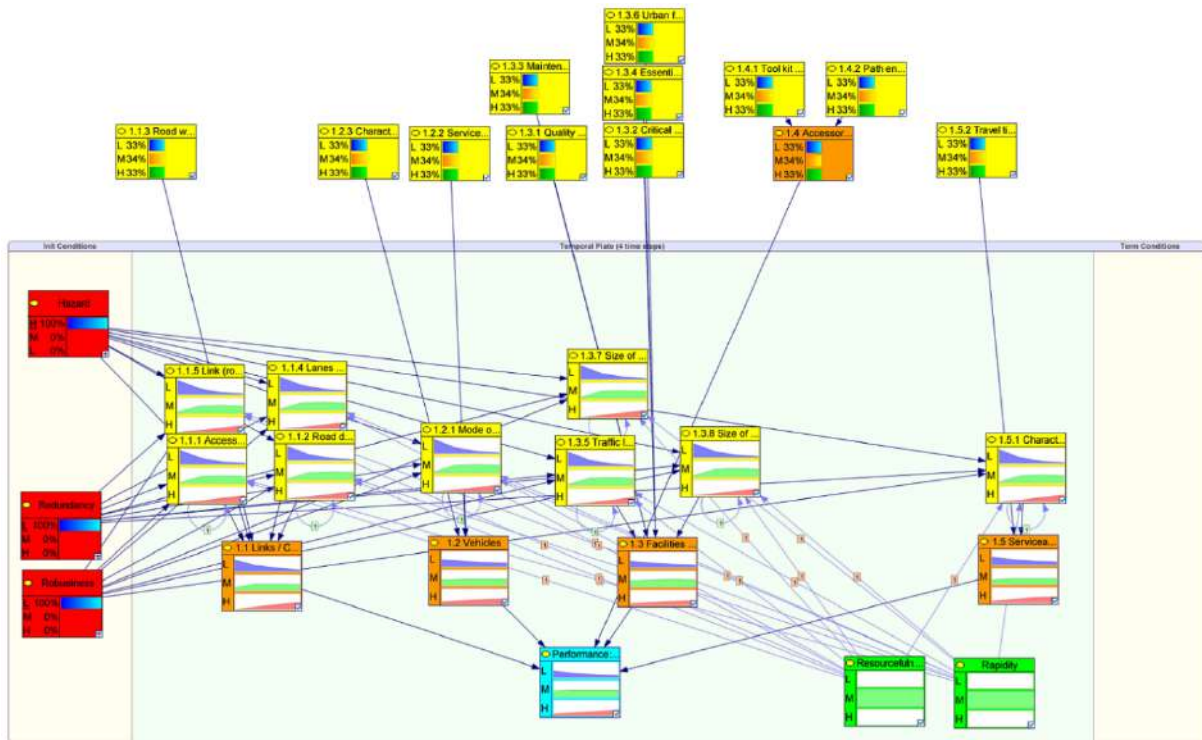

615

616 Figure 19 System's performance results for the fifth scenario of the simulation (high damage, medium
617 recoverability)

618 **7. Further considerations and applications of DBN**

619 In our formulation in Equation (10), we assume that only one hazard event can occur. The work can be extended
620 to include a sequence of multiple hazards (e.g. foreshock and aftershock). In this case, the damage variables (H ,
621 R_1 , and R_2) would appear in other time slices. This is shown in Figure 20 where the resilience function has two
622 drops in functionality instead of one drop due to the presence of two hazards. In such a case, the joint probability
623 formation introduced before in Equation (10) should be rewritten to account for the damage variables at other
624 time slices. There would also be some instances where both damage and recovery variables interfere together.

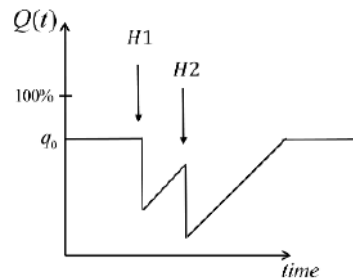

625

626 Figure 20 Resilience function with multiple hazards

627 Moreover, the damage and recovery variables have been expressed using a single variable. However, each of
628 the variables can be described in a separate network that consists of several variables. This allows considering
629 more details that would not be possible to be included if only one variable is considered. Equation (11) presents
630 the damage variables as joint probabilities of other variables.

631

$$\begin{cases} P(H) = P(H^1, H^2, \dots, H^k) \\ P(R_1) = P(R_1^1, R_1^2, \dots, R_1^m) \\ P(R_2) = P(R_2^1, R_2^2, \dots, R_2^m) \end{cases} \quad (11)$$

632 As mentioned in Section 2.2, there is also the possibility of introducing special nodes to the first slice or last
 633 slice of the DBN when needed (Figure 21). This can be done by introducing the nodes A (anchor) and T
 634 (terminal). In this case, Equation (10) must be adjusted accordingly to include the additional variables.

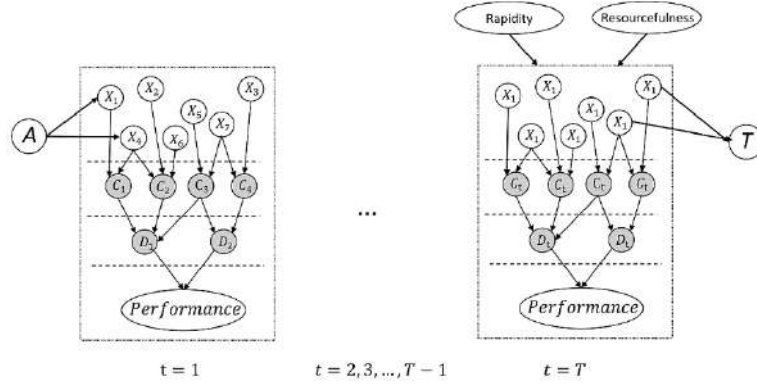

635

636

Figure 21 Bayesian network with additional variables in the first and last slices

637 The use of DBN to model and analyze engineering systems has been very limited in literature. DBN adds to the
 638 conventional BN the ability to consider time as a parameter in the analysis. All engineering systems are
 639 becoming strongly interdependent and this results in increased dynamic behavior of the systems. The DBN
 640 solves the challenge of dynamic modeling of engineering systems while it preserves all features of BN. While
 641 in this study we employ DBN to model and analyze the resilience of transportation infrastructure, the proposed
 642 model can be used to study the resilience of other infrastructure types as well as other engineering (and non-
 643 engineering) phenomenon that requires consideration of time. To give some examples of future applications,
 644 the proposed DBN formulation can be used to model, analyze, and improve the intervention activities of
 645 infrastructure in terms of scheduling and cost. This type of analysis cannot be performed with a static tool like
 646 BN. This, however, entails a detailed model of infrastructure intervention strategy. Another example can be
 647 structural degradation modeling and analysis. Degradation is a time-dependent process that cannot be studied
 648 at an instance of time, and this provides a good medium for DBN to be utilized. It should be noted that the use
 649 of DBN in such applications should be limited to cases where more complex tools cannot be used either due to
 650 modeling complexity of data availability.

651 8. Conclusions

652 Unlike the static resilience analysis which assumes a constant state of a system and measures the resilience by
 653 a static quantity, the dynamic resilience analysis additionally models the evolvement of the system with time.
 654 This paper introduced a probabilistic resilience assessment and prediction framework using the Bayesian and
 655 Dynamic Bayesian Networks (BN and DBNs). The framework employed resilience indicators for its
 656 implementation to make it more usable by decision makers in the industry. The methodology can handle both

657 static and dynamic engineering systems using quantitative and/or qualitative data. The uncertainty in the inputs
658 and in the variables relationships is accounted for and propagated throughout the model; hence, the output is
659 probabilistic in nature. Two illustrative examples were presented in the paper. The first is a static system that
660 uses the indicators of Hyogo Framework for Action (HFA) to assess the resilience of a country, while the second
661 is a transportation network modelled as a dynamic system. The examples demonstrate the applicability of the
662 framework for both static and dynamic systems.

663 In the static analysis, the indicators are the main determinant of the resilience output. Highly uncertain state of
664 the indicator (i.e., uniform probability distribution among the indicator's states) would result in a high standard
665 deviation in the probability distribution of the resilience's states. For the dynamic analysis, results show a
666 nonlinear behavior of resilience as a function of time. The recovery variables play a significant role in the
667 resilience assessment, where the resilience function shows an increasing trend whose slope depends on the
668 recovery capacity of the system. The damage variables also contribute to the overall resilience output as they
669 are the primary determinant of the system's functionality drop following the disaster event. A large functionality
670 drop would result in a longer recovery time under the same recovery characteristics of a system. In both static
671 and dynamic analyses, the uncertainty is introduced in the indicators' initial conditions. This is rather useful
672 when deterministic numbers are not available to initiate the analysis.

673 The quantitative resilience analysis tools that can be readily available to system designers to model and quantify
674 engineering resilience are still underdeveloped. This paper aims at motivating the resilience community to agree
675 on the proposed universal resilience framework. The presented framework provides a tool for decision makers
676 to systematically learn about the state of their systems given a specific event. It allows them to improve the
677 systems' performance using the backward analysis feature of BN. This is done by setting a desirable state of the
678 resilience and getting the variables inputs that lead to the predefined resilience state.

679 There is a number of limitations in the proposed BN and DBN approaches. First, the need to include subjectivity
680 during the different phases of model development and analysis. This is unavoidable because the main feature
681 of BN is to substitute missing data with expert judgment, which is subjective. This can be partially addressed
682 by using multiple experts. Another limitation is the increased complexity of the model as the analyzed system
683 increases in size and detail. When the system is complex, the mission of classifying the variables and connecting
684 them to one another becomes sophisticated and involves more subjectivity. In addition, BN is a directed acyclic
685 graph, which means that if a variable depends on another variable the reverse is not true. This limits the
686 possibility of modeling some real life situations where two variables can be dependent on each other. This can
687 be artificially solved by introducing the same variable twice in the network, one time as a dependent variable
688 and another time as a leading variable. However, this can also cause some consequences on the final output and
689 on the dynamics of the system. Finally, DBN presents an additional limitation, which is the complexity in
690 connecting variables at different temporal states. It can be challenging to identify which variables can affect
691 other variables at another time step.

692 Future work will be oriented towards building detailed networks for the damage and recovery variables as this
693 would allow expressing the system in more details. In addition, a procedure to evaluate the interdependency
694 among the variables as well as their weighting factors will be further addressed. Particularly, weighting the
695 indicators can be crucial in determining the conditional probabilities of the father nodes. Future studies can
696 address this aspect using the Analytic hierarchy process (AHP), which has been extensively used in similar
697 problems for organizing and analyzing complex decisions.

698 Acknowledgements

699 The research leading to these results has received funding from the European Research Council under the Grant
700 Agreement n° ERC_IDEAL RESCUE_637842 of the project IDEAL RESCUE—Integrated Design and Control
701 of Sustainable Communities during Emergencies. The research presented in this paper was also supported by
702 the MAE Center: Creating a Multi-hazard Approach to Engineering at the University of Illinois at Urbana-
703 Champaign. The views expressed are those of the authors, and may not represent the official position of the
704 sponsors.

705 Appendix

706 The scores of the resilience indicators of 37 countries as assessed by the United Nations

Indicators	Q 1	Q 2	Q 3	Q 4	Q 5	Q 6	Q 7	Q 8	Q 9	Q 10	Q 11	Q 12	Q 13	Q 14	Q 15	Q 16	Q 17	Q 18	Q 19	Q 20	Q 21	Q 22	
Countries																							
1-Fiji	5	4	5	5	5	5	5	5	5	5	5	5	5	5	5	5	5	5	5	5	5	5	5
2-Costa Rica	5	4	4	5	3	4	5	4	4	4	5	4	4	4	3	5	5	5	5	5	5	5	5
3-Singapore	5	5	5	2	5	5	5	5	5	5	5	5	2	5	5	4	1	1	5	5	4	5	5
4-Japan	5	4	4	5	4	4	4	4	5	4	3	5	4	4	4	4	4	5	5	4	4	4	4
5-UAE	5	4	5	4	4	4	3	3	3	4	4	5	5	5	5	5	5	5	4	4	3	4	4
6-Austria	4	5	5	3	4	4	5	5	4	4	3	4	4	4	4	4	4	5	5	4	4	4	4
7-UK	4	4	5	4	4	4	5	4	4	4	4	4	4	4	4	4	4	4	4	4	4	4	5
8-Greece	4	4	4	4	4	4	5	4	4	4	4	4	4	4	4	5	4	4	4	4	4	4	4
9-Australia	4	4	4	4	4	4	5	4	4	4	4	4	4	4	4	4	4	4	4	4	4	4	4
10-Italy	2	4	4	4	4	5	4	5	4	4	4	4	4	3	3	3	5	4	5	5	4	4	4
11-Cameroon	4	4	4	5	4	4	4	4	4	4	4	4	4	3	4	4	4	4	4	3	4	4	4
12-New Zealand	4	4	4	3	4	4	4	4	4	4	4	4	4	4	4	4	4	4	4	4	4	4	4
13-Germany	5	4	4	4	4	4	4	4	4	3	4	4	4	5	3	4	3	3	4	4	4	4	4
14-Nigeria	4	4	2	4	4	4	4	4	4	4	4	4	4	4	4	4	4	4	4	4	4	4	4
15-Canada	4	4	5	4	3	4	4	4	4	3	3	4	3	3	4	4	5	4	5	5	3	3	3
16-France	4	4	4	4	3	4	5	4	4	3	3	3	4	4	3	4	4	3	4	3	5	5	5
17-Ecuador	4	4	4	4	3	4	3	4	4	4	4	4	4	4	4	4	4	3	4	4	3	4	4
18-Ethiopia	4	3	4	4	4	4	4	4	4	4	4	4	4	4	3	3	3	4	4	4	4	4	4
19-USA	4	4	4	3	4	4	4	4	3	4	4	4	3	3	3	4	4	4	4	4	4	4	4
20-Chile	4	3	3	4	4	3	4	3	4	2	4	3	4	4	4	4	4	4	4	4	4	5	4
21-Ghana	4	2	2	4	4	4	4	4	5	1	4	4	4	4	3	3	4	4	4	4	4	4	4
22-Argentina	3	3	4	4	4	3	4	4	3	3	3	4	3	3	3	4	4	4	4	4	2	4	4
23-South Africa	4	4	4	4	3	3	3	3	3	3	3	3	4	3	3	3	4	4	3	4	4	4	4
24-Cook Island	4	3	4	4	3	4	4	4	3	3	3	4	4	3	3	3	4	3	4	3	3	3	3
25-Pakistan	4	4	4	4	3	3	3	4	3	3	3	3	3	3	3	3	4	3	3	4	4	4	3
26-Brazil	4	3	4	3	4	5	1	2	4	2	2	3	3	5	3	4	4	3	3	4	3	4	4
27-Egypt	4	2	4	4	4	3	3	3	3	3	2	4	4	3	4	3	3	3	4	4	3	3	3
28-Iran	4	3	4	4	3	3	2	2	3	4	3	3	3	3	3	4	3	3	4	3	4	3	4
29-Qatar	3	4	3	3	4	3	3	3	3	2	3	3	4	3	3	3	3	3	3	4	3	3	3
30-Samua	4	3	3	4	4	2	3	4	3	3	3	4	4	3	3	2	2	1	4	3	3	3	3
31-Thailand	4	2	4	4	2	2	4	3	3	3	2	4	3	4	2	3	2	3	4	4	4	4	2
32-Madagascar	4	3	4	4	4	2	2	2	4	5	4	2	2	1	2	2	4	2	4	4	2	4	4
33-Mexico	4	3	3	4	2	3	4	3	3	2	3	2	3	3	3	2	3	3	3	2	4	3	3
34-Morocco	2	3	3	3	3	3	3	3	3	3	3	3	3	3	3	3	3	1	1	3	3	3	3
35-Palestine	3	2	3	4	3	2	4	4	4	3	2	4	3	2	1	2	2	2	3	3	1	2	2
36-Monaco	3	2	1	3	3	1	3	3	4	4	1	2	3	1	1	1	1	1	3	4	1	1	1
37-Armenia	2	2	2	2	2	2	2	2	2	2	2	2	2	2	2	2	2	2	2	2	2	2	2

- 709 Balbi, A., Kammouh, O., Pia Repetto, M., and Cimellaro, G. P. (2018). "Resilience framework for seaport infrastructure:
710 theory and application." *9th International Conference on Bridge Maintenance, Safety (IABMAS 2018)*, Nigel
711 Powers, Dan M. Frangopol, Riadh Al-Mahaidi, and C. Caprani, eds., CRC Press, Melbourne, Australia, 588.
- 712 Balbi, S., Villa, F., Mojtahed, V., and Giupponi, C. (2014). "Estimating the benefits of early warning systems in reducing
713 urban flood risk to people: a spatially explicit Bayesian model."
- 714 BayesFusion, L. (2016). "GeNIe Modeler." *User Manual, Version, 2(1)*.
- 715 Bruneau, M., Chang, S. E., Eguchi, R. T., Lee, G. C., O'Rourke, T. D., Reinhorn, A. M., Shinozuka, M., Tierney, K.,
716 Wallace, W. A., and Von Winterfeldt, D. J. E. s. (2003). "A framework to quantitatively assess and enhance the
717 seismic resilience of communities." 19(4), 733-752.
- 718 Bruneau, M., and Reinhorn, A. (2007). "Exploring the concept of seismic resilience for acute care facilities." *Earthquake
719 Spectra*, 23(1), 41-62.
- 720 Cai, B., Xie, M., Liu, Y., Liu, Y., Ji, R., and Feng, Q. "A novel critical infrastructure resilience assessment approach using
721 dynamic Bayesian networks." *Proc., AIP Conference Proceedings*, AIP Publishing, 040043.
- 722 Cimellaro, G. P. (2016). *Urban Resilience for Emergency Response and Recovery*, Springer.
- 723 Cimellaro, G. P., Reinhorn, A. M., and Bruneau, M. (2010a). "Framework for analytical quantification of disaster
724 resilience." *Engineering Structures*, 32(11), 3639-3649.
- 725 Cimellaro, G. P., Reinhorn, A. M., and Bruneau, M. (2010b). "Seismic resilience of a hospital system." *Structure and
726 Infrastructure Engineering*, 6(1-2), 127-144.
- 727 Cimellaro, G. P., Renschler, C., Reinhorn, A. M., and Arendt, L. (2016a). "PEOPLES: a framework for evaluating
728 resilience." *Journal of Structural Engineering, ASCE*, 142(10), 1-13 DOI: 10.1061/(ASCE)ST.1943-
729 1541X.0001514.
- 730 Cimellaro, G. P., Scura, G., Renschler, C., Reinhorn, A. M., and Kim, H. (2014a). "Rapid building damage assessment
731 system using mobile phone technology " *Earthquake Engineering and Engineering Vibration*, 13(3), 519-533
- 732 Cimellaro, G. P., Solari, D., and Bruneau, M. (2014b). "Physical infrastructure interdependency and regional resilience
733 index after the 2011 Tohoku earthquake in Japan." *Earthquake Engineering & Structural Dynamics*, 43(12), 1763-
734 1784.
- 735 Cimellaro, G. P., Tinebra, A., Renschler, C., and Fragiadakis, M. (2016b). "New Resilience Index for Urban Water
736 Distribution Networks." *Journal of Structural Engineering, ASCE*, 142(8), C4015014.
- 737 Cimellaro, G. P., Villa, O., and Bruneau, M. (2015). "Resilience-Based Design of Natural gas distribution networks."
738 *Journal of Infrastructure Systems, ASCE*, 21(1), 05014005.
- 739 Cockburn, G., and Tesfamariam, S. (2012). "Earthquake disaster risk index for Canadian cities using Bayesian belief
740 networks." *Georisk: Assessment and Management of Risk for Engineered Systems and Geohazards*, 6(2), 128-
741 140.
- 742 Cox, A., Prager, F., and Rose, A. (2011). "Transportation security and the role of resilience: A foundation for operational
743 metrics." *Transport Policy*, 18(2), 307-317.
- 744 Cutter, S. L., Ash, K. D., and Emrich, C. T. (2014). "The geographies of community disaster resilience." *Global
745 Environmental Change*, 29, 65-77.
- 746 Cutter, S. L., Barnes, L., Berry, M., Burton, C., Evans, E., Tate, E., and Webb, J. (2008). "A place-based model for
747 understanding community resilience to natural disasters." *Global environmental change*, 18(4), 598-606.
- 748 De Iuliis, M., Kammouh, O., Cimellaro, G., and Tesfamariam, S. (2019a). "Resilience of the Built Environment: A
749 Methodology to Estimate the Downtime of Building Structures Using Fuzzy Logic." *Resilient Structures and
750 Infrastructure*, Springer, 47-76.
- 751 De Iuliis, M., Kammouh, O., Cimellaro, G. P., and Tesfamariam, S. (2019b). "Downtime estimation of building structures
752 using fuzzy logic." *International Journal of Disaster Risk Reduction*, 34, 196-208.
- 753 De Iuliis, M., Kammouh, O., Cimellaro, G. P., and Tesfamariam, S. (under review). "Quantifying restoration time of
754 pipelines after earthquakes: Comparison of Bayesian belief network and fuzzy models." *Sustainable and Resilient
755 Infrastructure*.
- 756 Doorn, N., Gardoni, P., and Murphy, C. (2018). "A multidisciplinary definition and evaluation of resilience: the role of
757 social justice in defining resilience." *Sustainable and Resilient Infrastructure*, 1-12.
- 758 Dorbritz, R. "Assessing the resilience of transportation systems in case of large-scale disastrous events." *Proc., Proceedings
759 of the 8th International Conference on Environmental Engineering, Vilnius, Lithuania*, 1070-1076.
- 760 Eldosouky, A., Saad, W., and Mandayam, N. (2017). "Resilient Critical Infrastructure: Bayesian Network Analysis and
761 Contract-Based Optimization."
- 762 Gardoni, P. (2018). "Routledge Handbook of Sustainable and Resilient Infrastructure."
- 763 Grover, J. (2013). "Bayesian Belief Networks (BBN) Experimental Protocol." *Strategic Economic Decision-Making*,
764 Springer, 43-48.
- 765 Henry, D., and Ramirez-Marquez, J. E. (2012). "Generic metrics and quantitative approaches for system resilience as a
766 function of time." *Reliability Engineering & System Safety*, 99, 114-122.

767 Hossain, N. U. I., Jaradat, R., Hosseini, S., Marufuzzaman, M., and Buchanan, R. K. (2019a). "A framework for modeling
768 and assessing system resilience using a Bayesian network: A case study of an interdependent electrical
769 infrastructure system." *International Journal of Critical Infrastructure Protection*, 25, 62-83.

770 Hossain, N. U. I., Nur, F., Jaradat, R., Hosseini, S., Marufuzzaman, M., Puryear, S. M., and Buchanan, R. K. J. C. (2019b).
771 "Metrics for assessing overall performance of inland waterway ports: A bayesian network based approach." 2019.

772 Hosseini, S., Al Khaled, A., and Sarder, M. (2016a). "A general framework for assessing system resilience using Bayesian
773 networks: A case study of sulfuric acid manufacturer." *Journal of Manufacturing System*, 41, 211-227.

774 Hosseini, S., and Barker, K. (2016). "Modeling infrastructure resilience using Bayesian networks: A case study of inland
775 waterway ports." *Computers & Industrial Engineering*, 93, 252-266.

776 Hosseini, S., Barker, K., and Ramirez-Marquez, J. E. (2016b). "A review of definitions and measures of system resilience."
777 *Reliability Engineering & System Safety*, 145, 47-61.

778 Hulst, J. (2006). "Modeling physiological processes with dynamic Bayesian networks." *Faculty of Electrical Engineering,
779 Mathematics, and Computer Science, University of Pittsburgh*.

780 Ip, W. H., and Wang, D. (2011). "Resilience and friability of transportation networks: evaluation, analysis and
781 optimization." *IEEE Systems Journal*, 5(2), 189-198.

782 ISDR, U. "Hyogo framework for action 2005-2015: building the resilience of nations and communities to disasters." *Proc.,
783 Extract from the final report of the World Conference on Disaster Reduction (A/CONF. 206/6)*.

784 Ismail, M. A., Sadiq, R., Soleymani, H. R., and Tesfamariam, S. (2011). "Developing a road performance index using a
785 Bayesian belief network model." *Journal of the Franklin Institute*, 348(9), 2539-2555.

786 Jenelius, E. (2009). "Network structure and travel patterns: explaining the geographical disparities of road network
787 vulnerability." *Journal of Transport Geography*, 17(3), 234-244.

788 Johansen, C., and Tien, I. (2018). "Probabilistic multi-scale modeling of interdependencies between critical infrastructure
789 systems for resilience." *Sustainable and Resilient Infrastructure*, 3(1), 1-15.

790 Kabir, G., Sadiq, R., and Tesfamariam, S. (2016). "A fuzzy Bayesian belief network for safety assessment of oil and gas
791 pipelines." *Structure and Infrastructure Engineering*, 12(8), 874-889.

792 Kabir, G., Tesfamariam, S., Francisque, A., and Sadiq, R. (2015). "Evaluating risk of water mains failure using a Bayesian
793 belief network model." *European Journal of Operational Research*, 240(1), 220-234.

794 Kammouh, O., Cardoni, A., Kim, H., and Cimellaro, G. P. (2017a). "Reliability and component vulnerability analysis of
795 city-scale network: Application to the transportation system of a virtual city." *International Workshop on
796 Performance-Based Seismic Design of Structures (PESDES 2017)* Shanghai, China.

797 Kammouh, O., Cardoni, A., Marasco, S., Cimellaro, G. P., and Mahin, S. (2018a). "Resilience assessment of city-scale
798 transportation networks subject to earthquakes using the Monte Carlo approach." *9th International Conference on
799 Bridge Maintenance, Safety (IABMAS 2018)*, Nigel Powers, Dan M. Frangopol, Riyadh Al-Mahaidi, and C.
800 Caprani, eds., CRC Press, Melbourne, Australia, 588.

801 Kammouh, O., and Cimellaro, G. (2018a). "Cyber Threat on Critical Infrastructure: A Growing Concern for Decision
802 Makers." *Routledge Handbook of Sustainable and Resilient Infrastructure*, P. Gardoni, ed., Routledge, London,
803 359-374.

804 Kammouh, O., and Cimellaro, G. P. (2018b). "PEOPLES: a tool to measure community resilience." *Proceedings of 2018
805 Structures Congress (SEI2018)*, J. G. Soules, ed., ASCE- American Society of Civil Engineering, Fort Worth,
806 Texas. April 19–21, 2018, 161 - 171, doi:110.1061/9780784481349.9780784481015.

807 Kammouh, O., Cimellaro, G. P., and Mahin, S. A. (2018b). "Downtime estimation and analysis of lifelines after an
808 earthquake." *Engineering Structures*, 173, 393-403.

809 Kammouh, O., Dervishaj, G., and Cimellaro, G. P. (2017b). "A New Resilience Rating System for Countries and States."
810 *Procedia Engineering*, 198(Supplement C), 985-998.

811 Kammouh, O., Dervishaj, G., and Cimellaro, G. P. (2018c). "Quantitative Framework to Assess Resilience and Risk at the
812 Country Level." *Asce-Asme J Ris Unce*, 4(1), 04017033.

813 Kammouh, O., Gardoni, P., and Cimellaro, G. P. (2019a). "Resilience assessment of dynamic engineering systems."
814 *MATEC Web Conf.*, 281, 01008.

815 Kammouh, O., Noori, A. Z., Taurino, V., Mahin, S. A., and Cimellaro, G. P. (2018d). "Deterministic and fuzzy-based
816 methods to evaluate community resilience." *Earthquake Engineering and Engineering Vibration*, 17(2), 261-275.

817 Kammouh, O., Zamani-Noori, A., Cimellaro, G. P., and Mahin, S. A. (2019b). "Resilience Assessment of Urban
818 Communities." *ASCE-ASME Journal of Risk and Uncertainty in Engineering Systems, Part A: Civil Engineering*,
819 5(1), 04019002.

820 Kammouh, O., Zamani Noori, A., Domaneschi, M., Cimellaro, G. P., and Mahin, S. (2018e). "A fuzzy based tool to
821 measure the resilience of communities." *9th International Conference on Bridge Maintenance, Safety (IABMAS
822 2018)*, Nigel Powers, Dan M. Frangopol, Riyadh Al-Mahaidi, and C. Caprani, eds., CRC Press, Melbourne,
823 Australia, 588.

824 Kjærulff, U., and van der Gaag, L. C. "Making sensitivity analysis computationally efficient." *Proc., Proceedings of the
825 Sixteenth conference on Uncertainty in artificial intelligence*, Morgan Kaufmann Publishers Inc., 317-325.

826 Laskey, K. B. (1995). "Sensitivity analysis for probability assessments in Bayesian networks." *IEEE Transactions on
827 Systems, Man, and Cybernetics*, 25(6), 901-909.

828 Leu, G., Abbass, H., and Curtis, N. (2010). "Resilience of ground transportation networks: a case study on Melbourne."

829 Lewis, T. G. (2011). *Network science: Theory and applications*, John Wiley & Sons.

830 Litman, T. (2006). "Lessons from Katrina and Rita: What major disasters can teach transportation planners." *Journal of*
831 *Transportation Engineering*, 132(1), 11-18.

832 Liu, X., Ferrario, E., and Zio, E. (2017). "Resilience Analysis Framework for Interconnected Critical Infrastructures." *ASCE-ASME Journal of Risk and Uncertainty in Engineering Systems, Part B: Mechanical Engineering*, 3(2),
833 021001-021001-021010.

834

835 Manyena, S. B. (2006). "The concept of resilience revisited." *Disasters*, 30(4), 434-450.

836 Mishra, S., Welch, T. F., and Jha, M. K. (2012). "Performance indicators for public transit connectivity in multi-modal
837 transportation networks." *Transportation Research Part A: Policy and Practice*, 46(7), 1066-1085.

838 Murphy, K. P., and Russell, S. (2002). "Dynamic bayesian networks: representation, inference and learning."

839 Pourret, O., Naïm, P., and Marcot, B. (2008). *Bayesian networks: a practical guide to applications*, John Wiley & Sons.

840 Reinhorn, A. M., Lavan, O., and Cimellaro, G. P. (2009). "Design of controlled elastic and inelastic structures." *Earthquake*
841 *Engineering and Engineering Vibration*, 8(4), 469-479.

842 Sarkis, A. I., Palermo, A., Kammouh, O., and Cimellaro, G. P. (2018). "Seismic resilience of road bridges: lessons learned
843 from the 14 November 2016 Kaikoura Earthquake." *9th International Conference on Bridge Maintenance, Safety*
844 *(IABMAS 2018)*, Nigel Powers, Dan M. Frangopol, Riadh Al-Mahaidi, and C. Caprani, eds., CRC Press,
845 Melbourne, Australia, 588.

846 Schultz, M. T., and Smith, E. R. (2016). "Assessing the resilience of coastal systems: A probabilistic approach." *Journal*
847 *of Coastal Research*, 32(5), 1032-1050.

848 Shahriar, A., Sadiq, R., and Tesfamariam, S. (2012). "Risk analysis for oil & gas pipelines: A sustainability assessment
849 approach using fuzzy based bow-tie analysis." *Journal of Loss Prevention in the Process Industries*, 25(3), 505-
850 523.

851 Sharma, N., Tabandeh, A., and Gardoni, P. (2018). "Resilience analysis: A mathematical formulation to model resilience
852 of engineering systems." *Sustainable and Resilient Infrastructure*, 3(2), 49-67.

853 Siraj, T., Tesfamariam, S., and Duenas-Osorio, L. (2015). "Seismic risk assessment of high-voltage transformers using
854 Bayesian belief networks." *Structure and Infrastructure Engineering*, 11(7), 929-943.

855 Soltani-Sobh, A., Heaslip, K., Stevanovic, A., El Khoury, J., and Song, Z. (2016). "Evaluation of transportation network
856 reliability during unexpected events with multiple uncertainties." *International journal of disaster risk reduction*,
857 17, 128-136.

858 Tabandeh, A., Gardoni, P., Murphy, C., and Myers, N. (2018). "Societal Risk and Resilience Analysis: Dynamic Bayesian
859 Network Formulation of a Capability Approach." *ASCE-ASME Journal of Risk and Uncertainty in Engineering*
860 *Systems, Part A: Civil Engineering*, 5(1), 04018046.

861 Tamvakis, P., and Xenidis, Y. (2012). "Resilience in transportation systems." *Procedia-Social and Behavioral Sciences*,
862 48, 3441-3450.

863 UNISDR (2008). "Indicators of progress: guidance on measuring the reduction of disaster risks and the implementation of
864 the Hyogo Framework for Action." <http://www.unisdr.org/files/2259_IndicatorsofProgressHFAannexes.pdf>.

865 UNISDR (2011). "Hyogo Framework for Action 2005-2015 mid-term review." <http://www.preventionweb.net/files/18197_midterm.pdf>.

866

867 UNISDR (2012). *How to Make Cities More Resilient: A Handbook for Local Government Leaders: a Contribution to the*
868 *Global Campaign 2010-2015: Making Cities Resilient-My City is Getting Ready!*, United Nations Office for
869 Disaster Risk Reduction.

870 Zhang, J., Xu, X., Hong, L., Wang, S., and Fei, Q. (2011). "Networked analysis of the Shanghai subway network, in China." *Physica A: Statistical Mechanics and its Applications*, 390(23), 4562-4570.

871

872

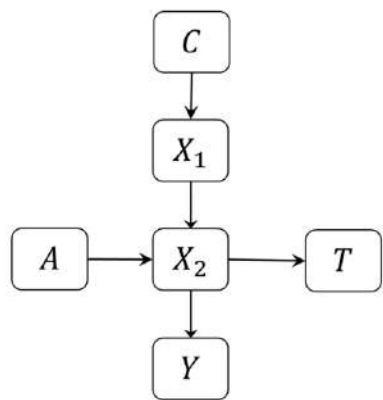

(a)

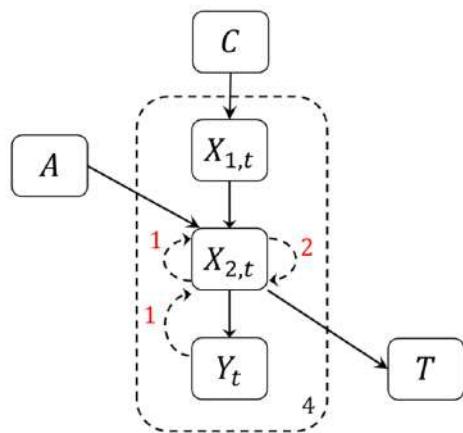

(b)

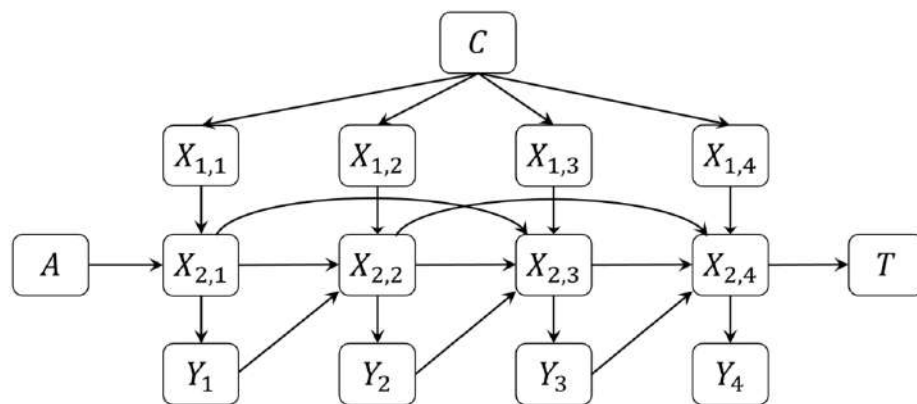

(c)

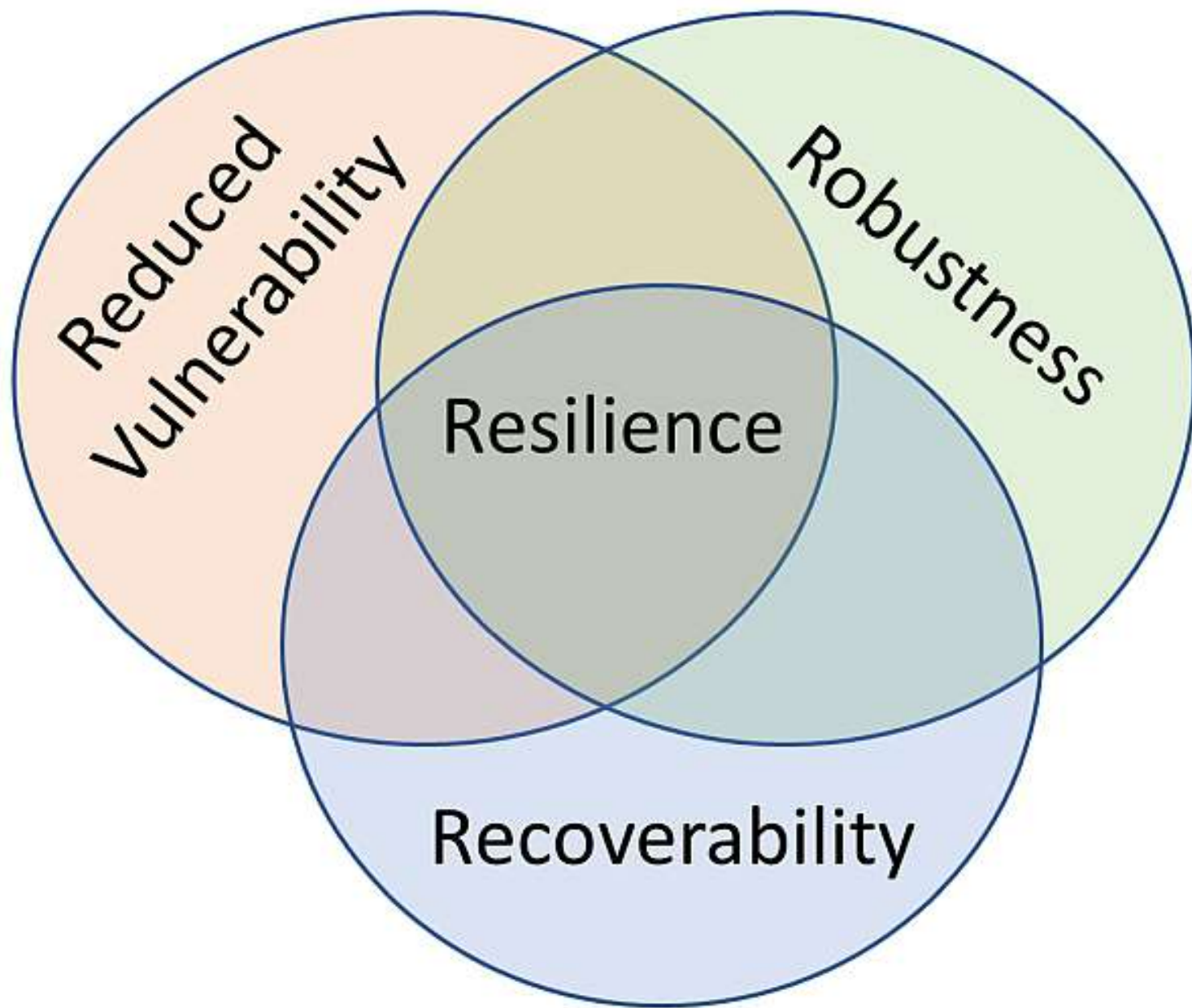

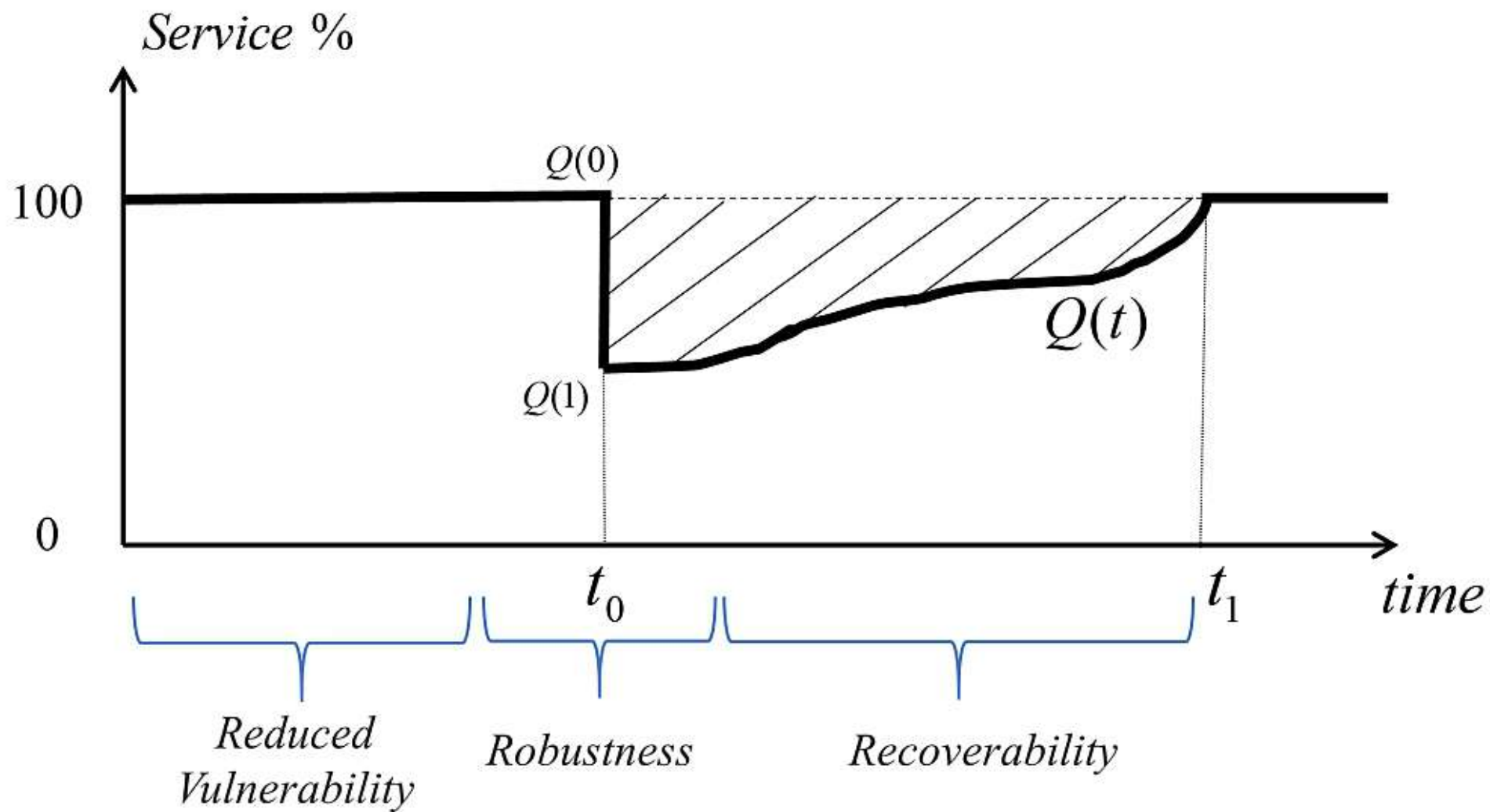

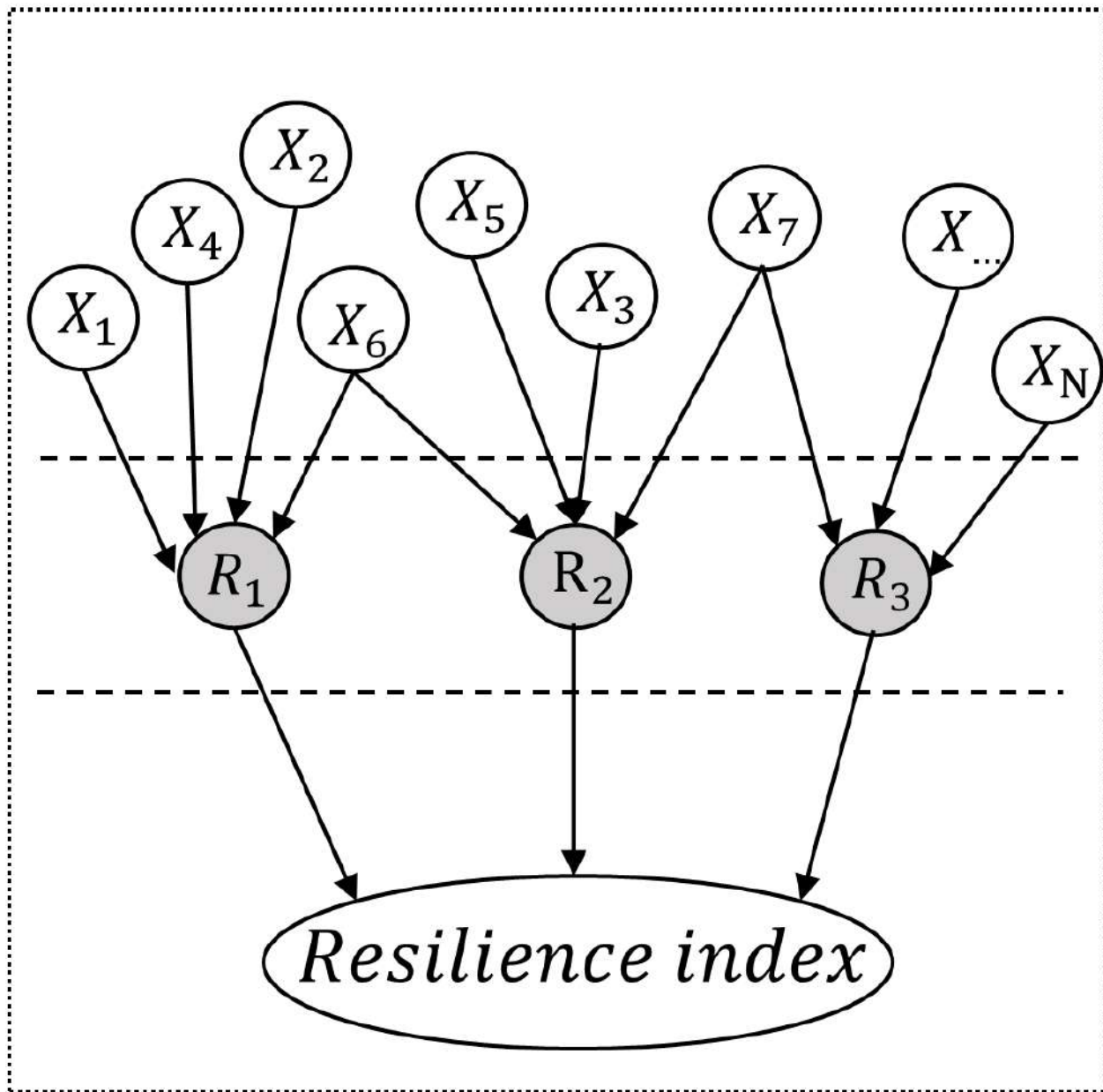

N Indicators

*The three pillars
of resilience*

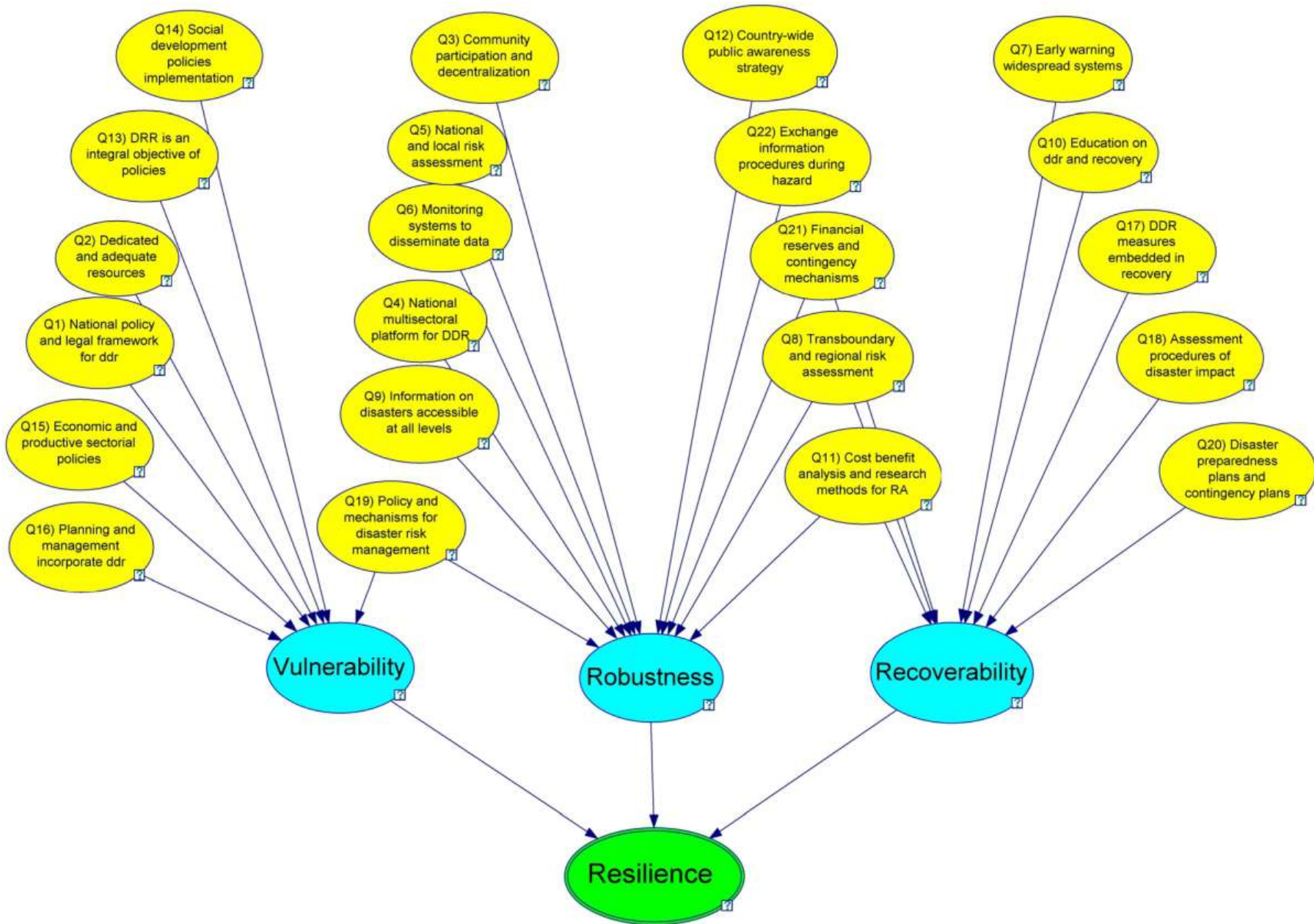

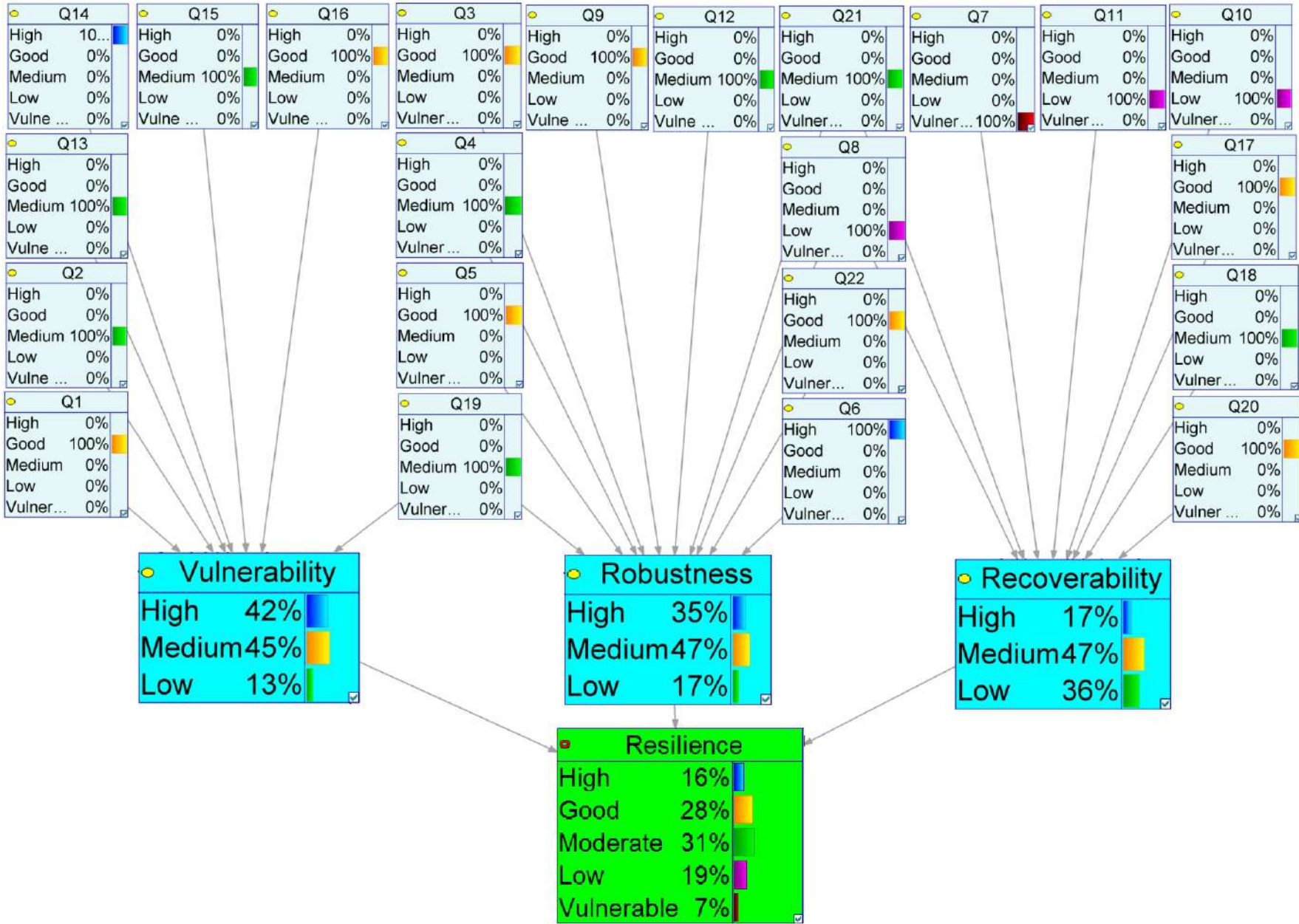

Sensitivity for Resilience=High

Current value: 0.190843 Reachable range: [0.165951 .. 0.215736]

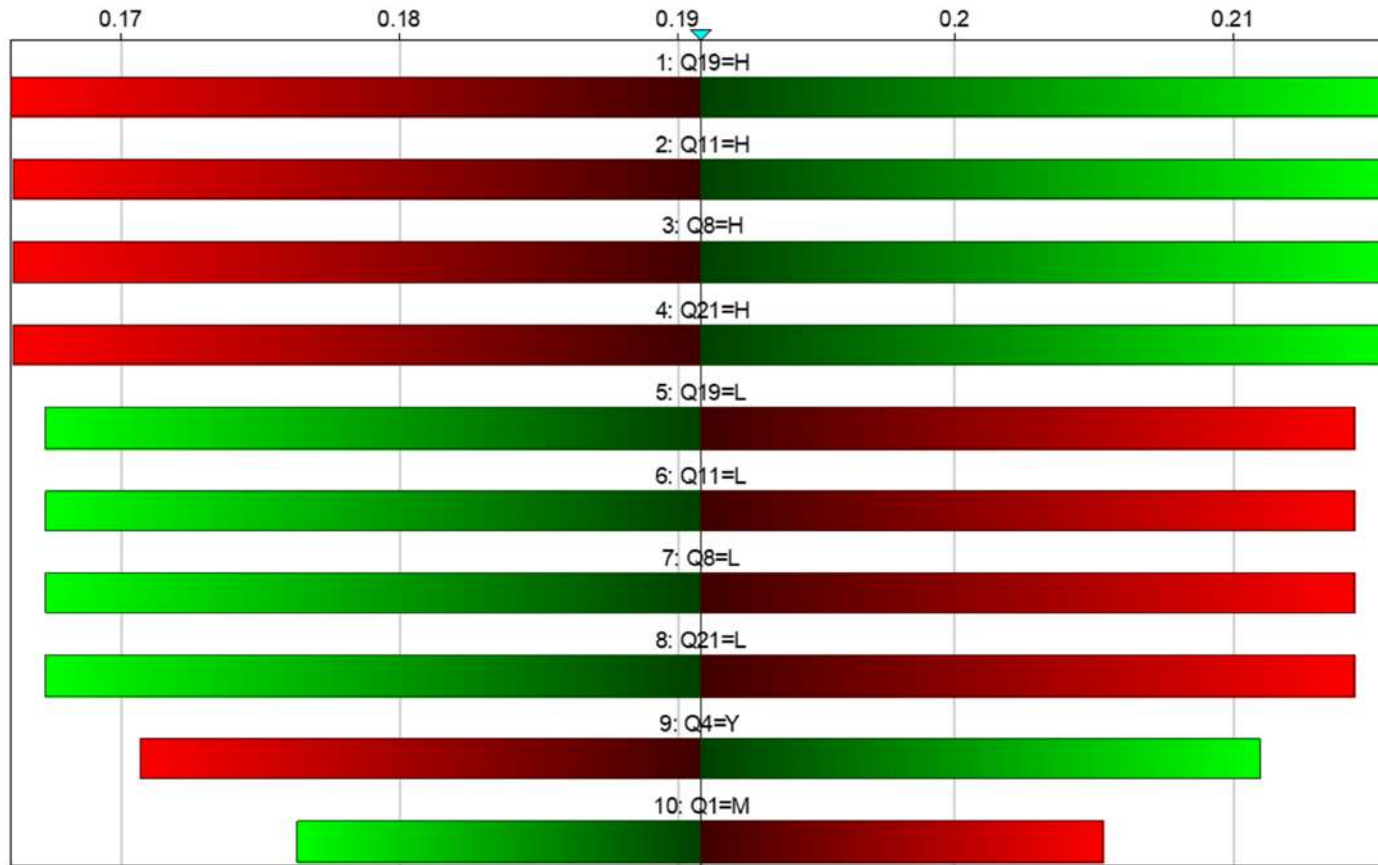

Sensitivity for Resilience=Moderate

Current value: 0.285937 Reachable range: [0.277115 .. 0.294759]

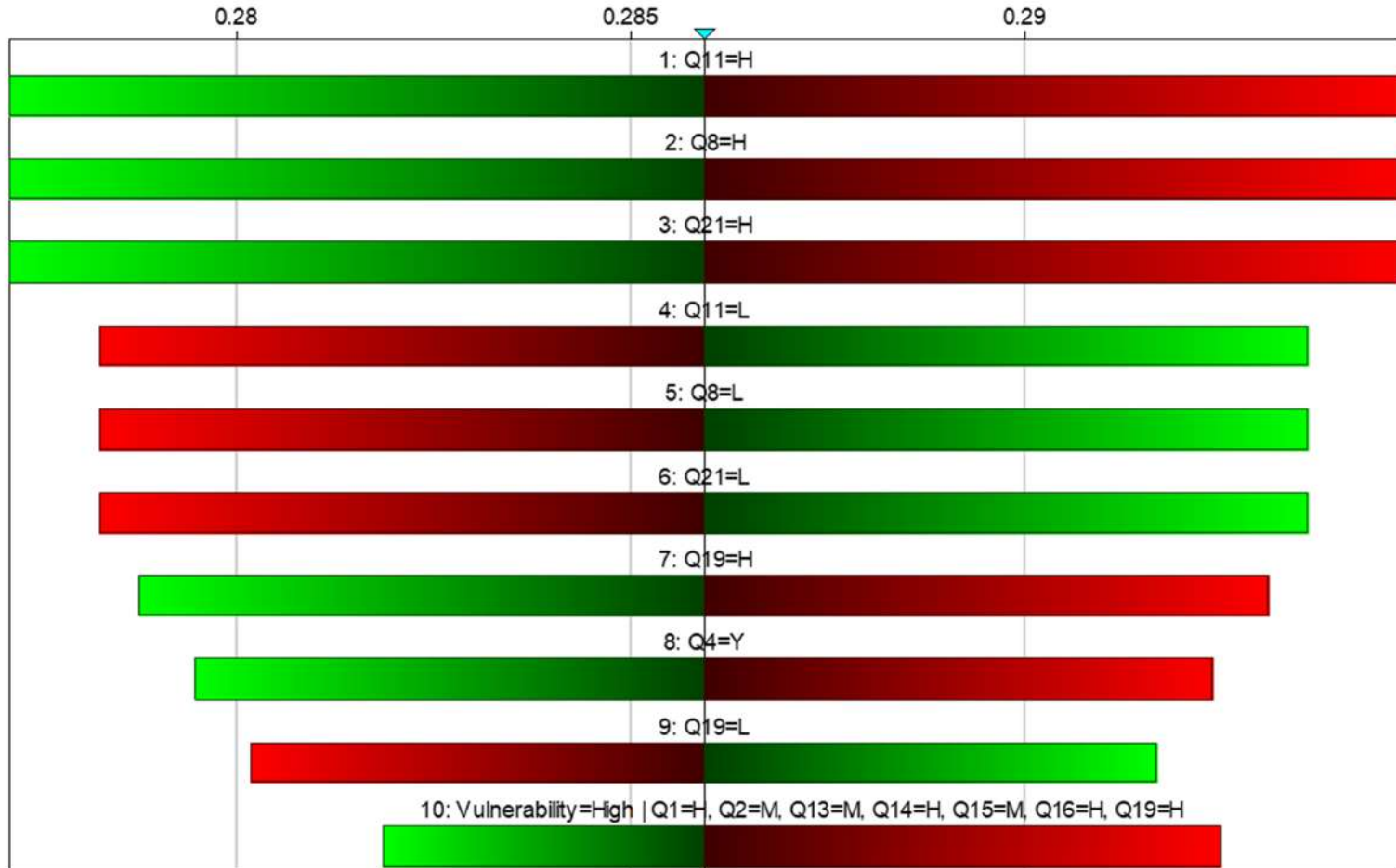

Sensitivity for Resilience=Vulnerable

Current value: 0.0703184 Reachable range: [0.0563023 .. 0.0843344]

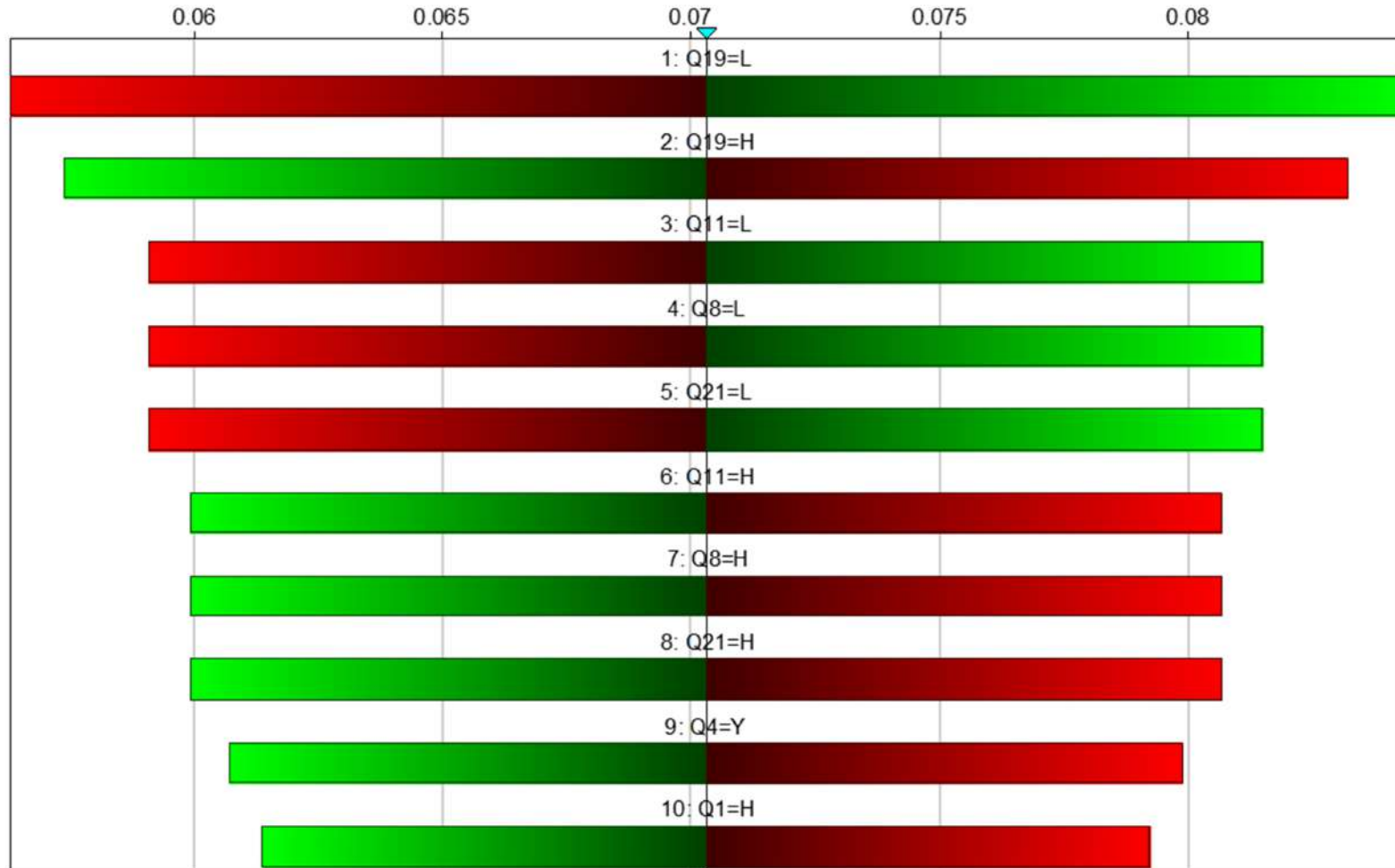

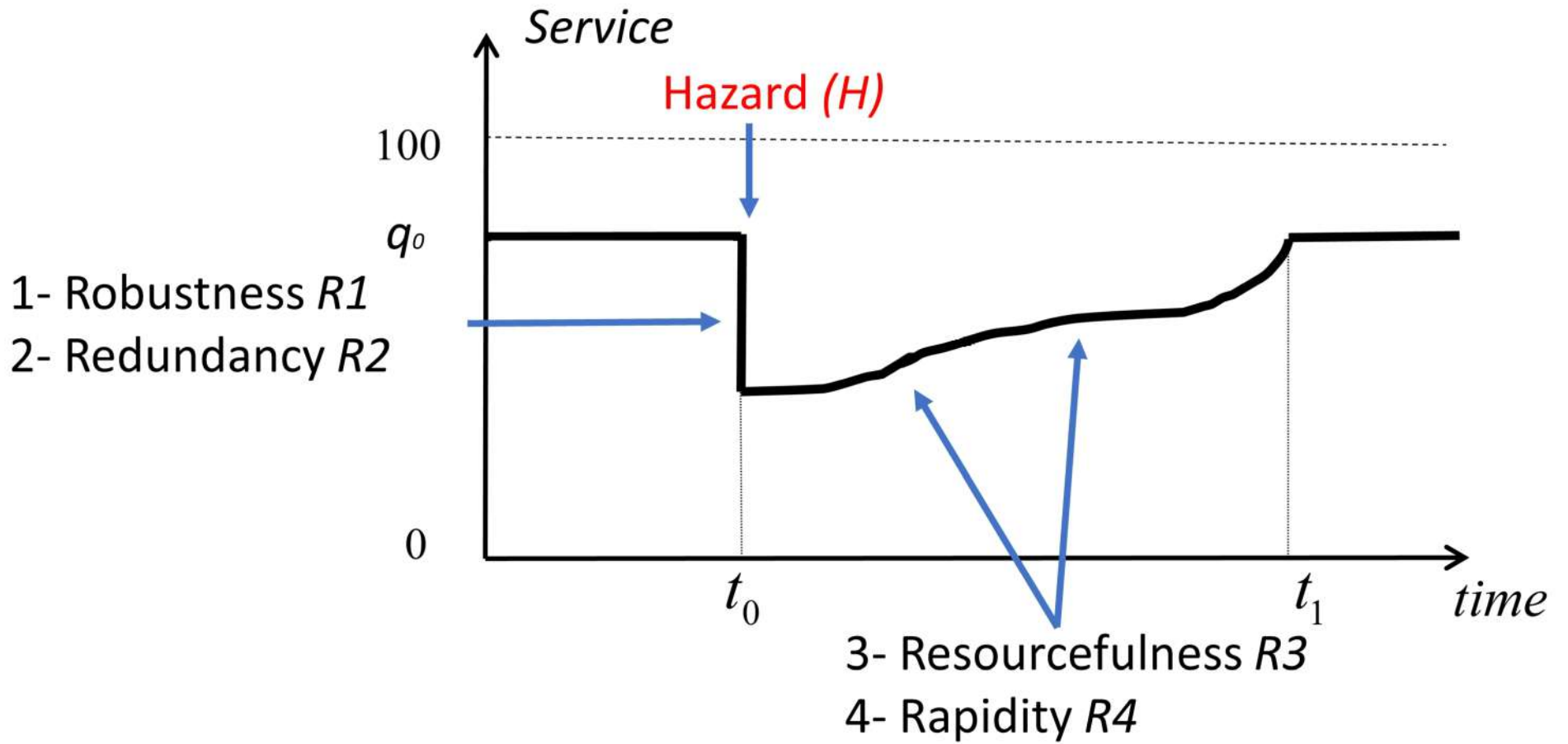

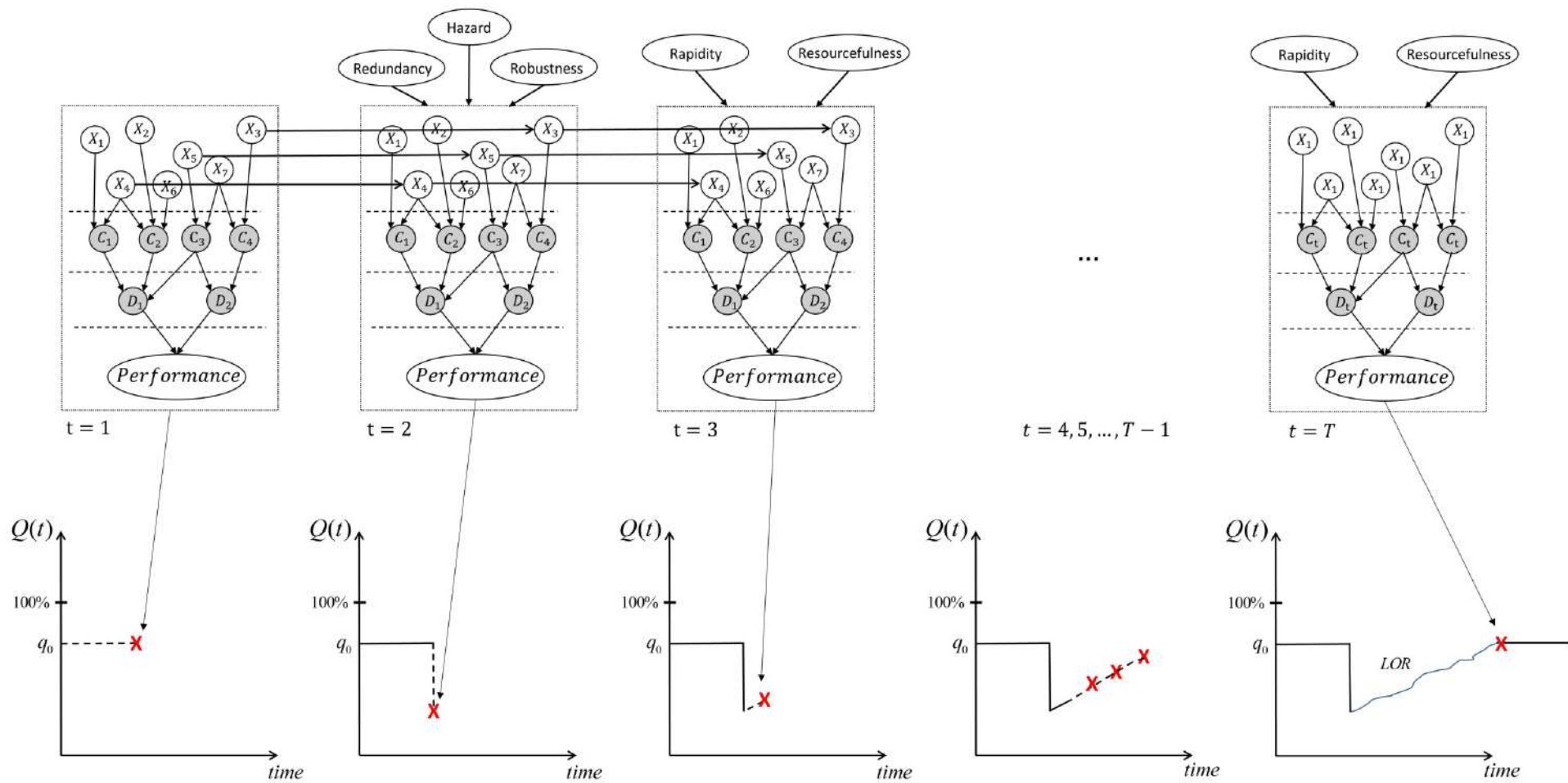

Resilience

Dimensions

Components

Indicators

Measures

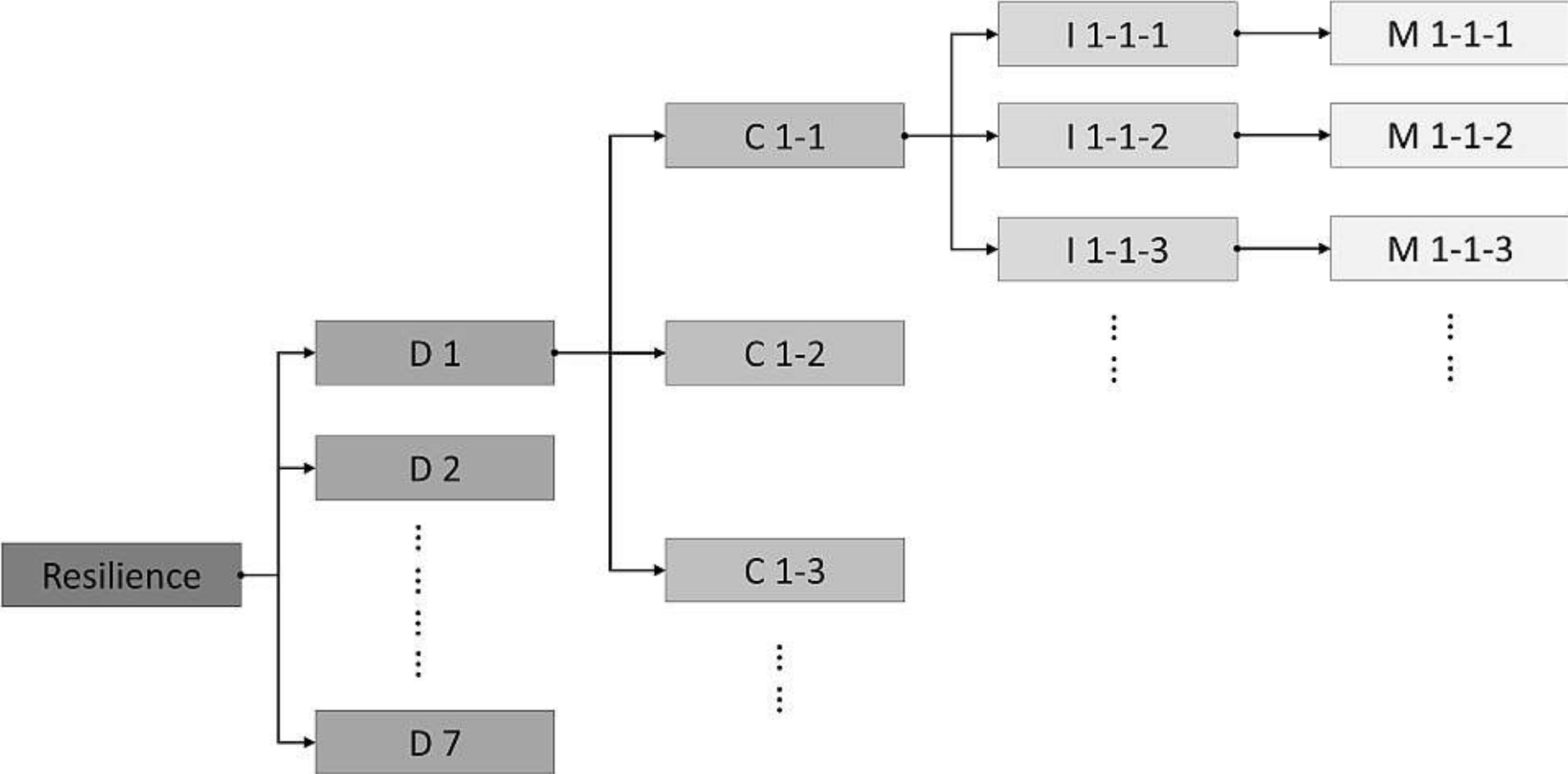

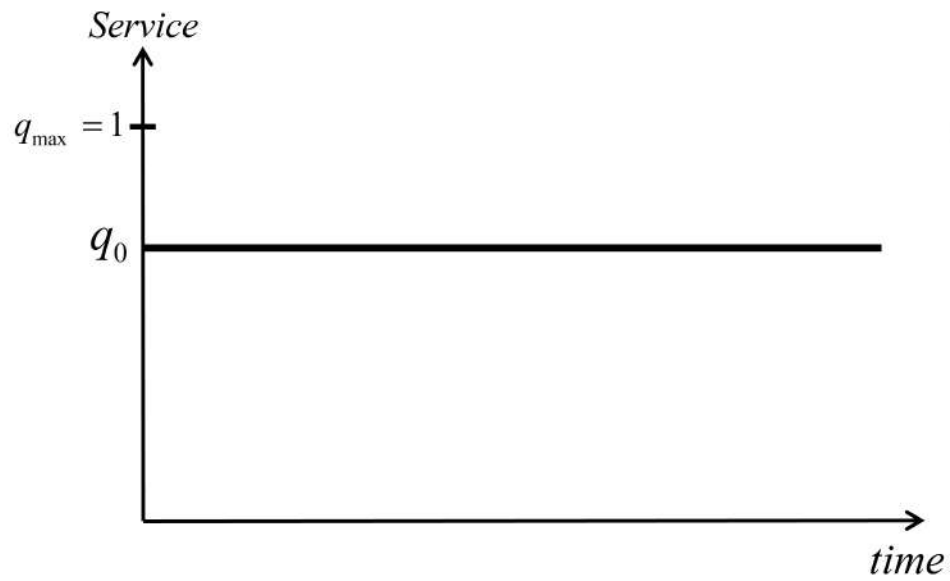

(a)

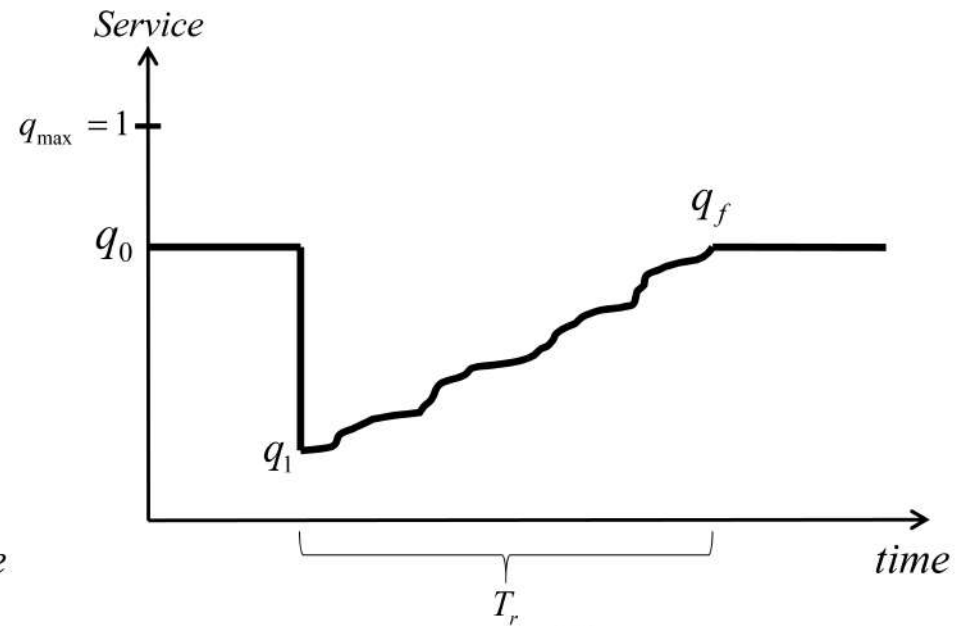

(b)

Legends

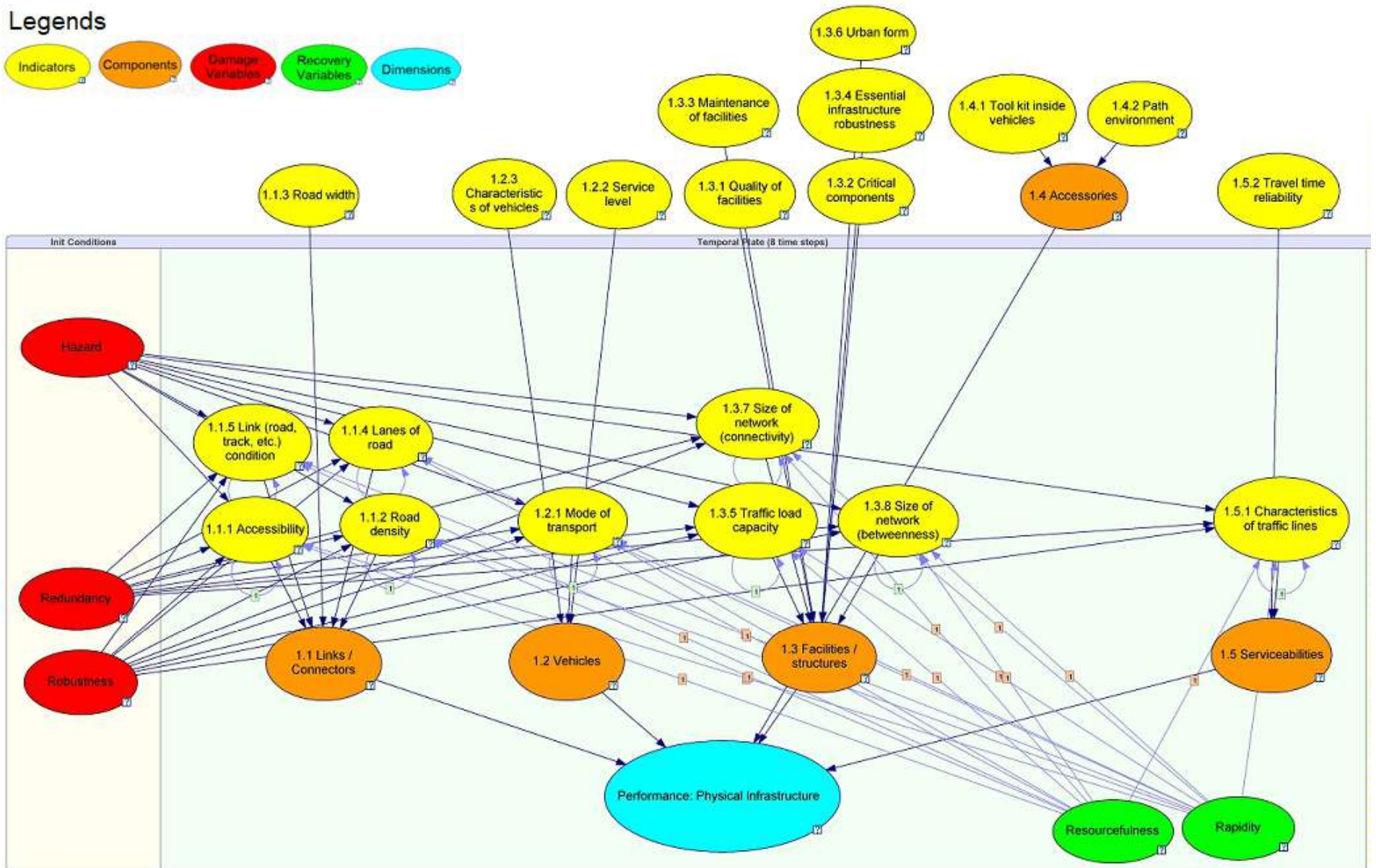

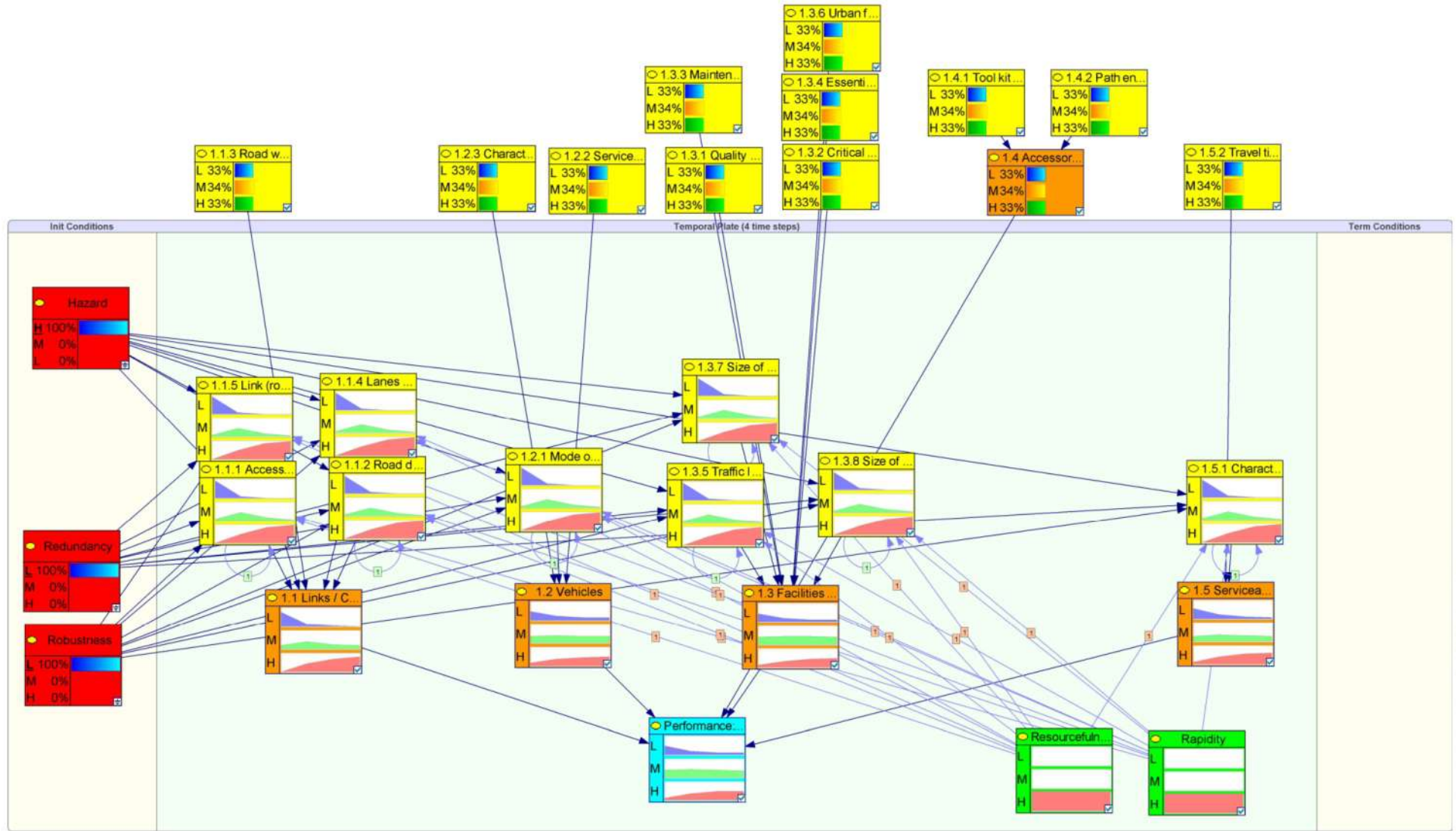

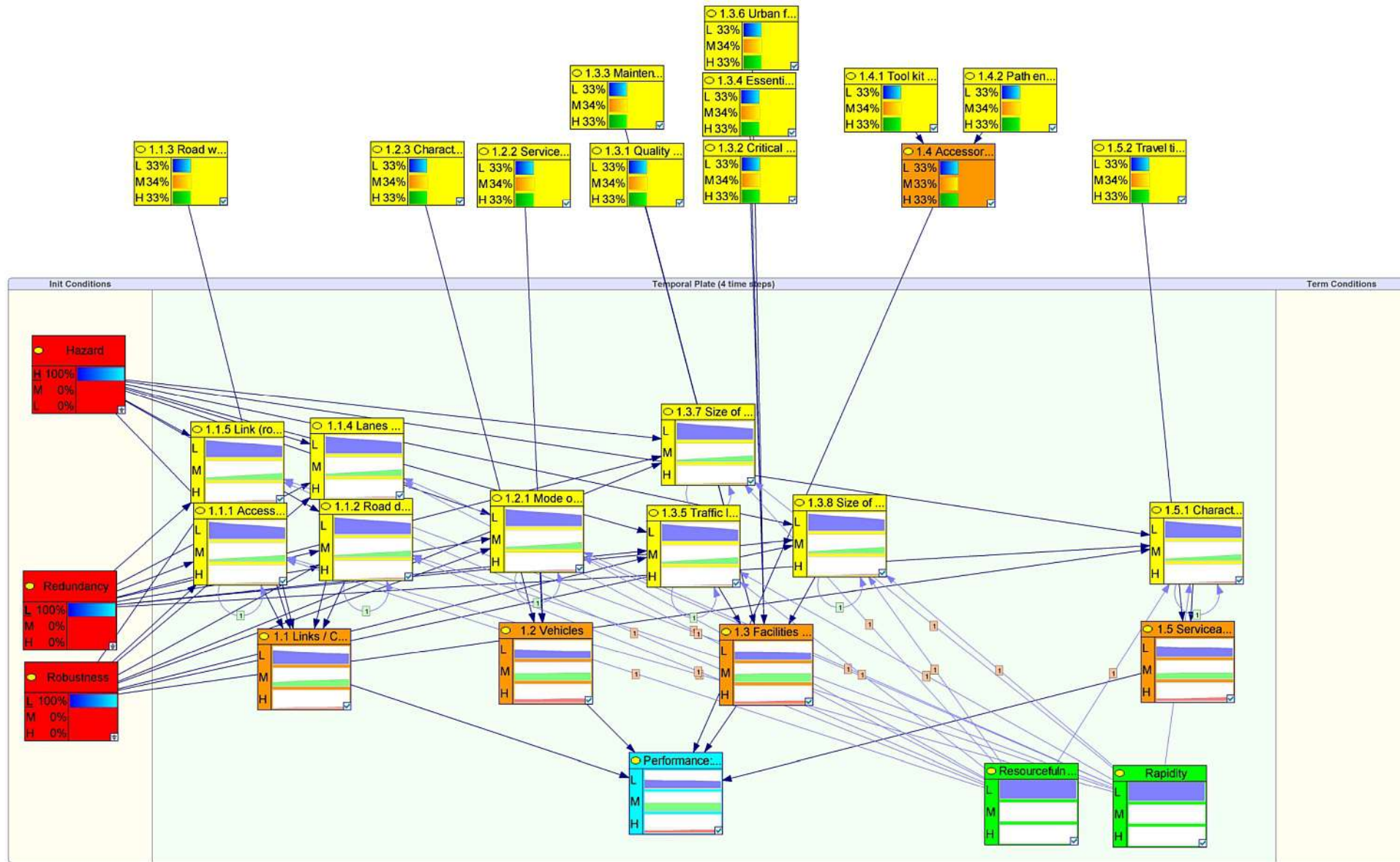

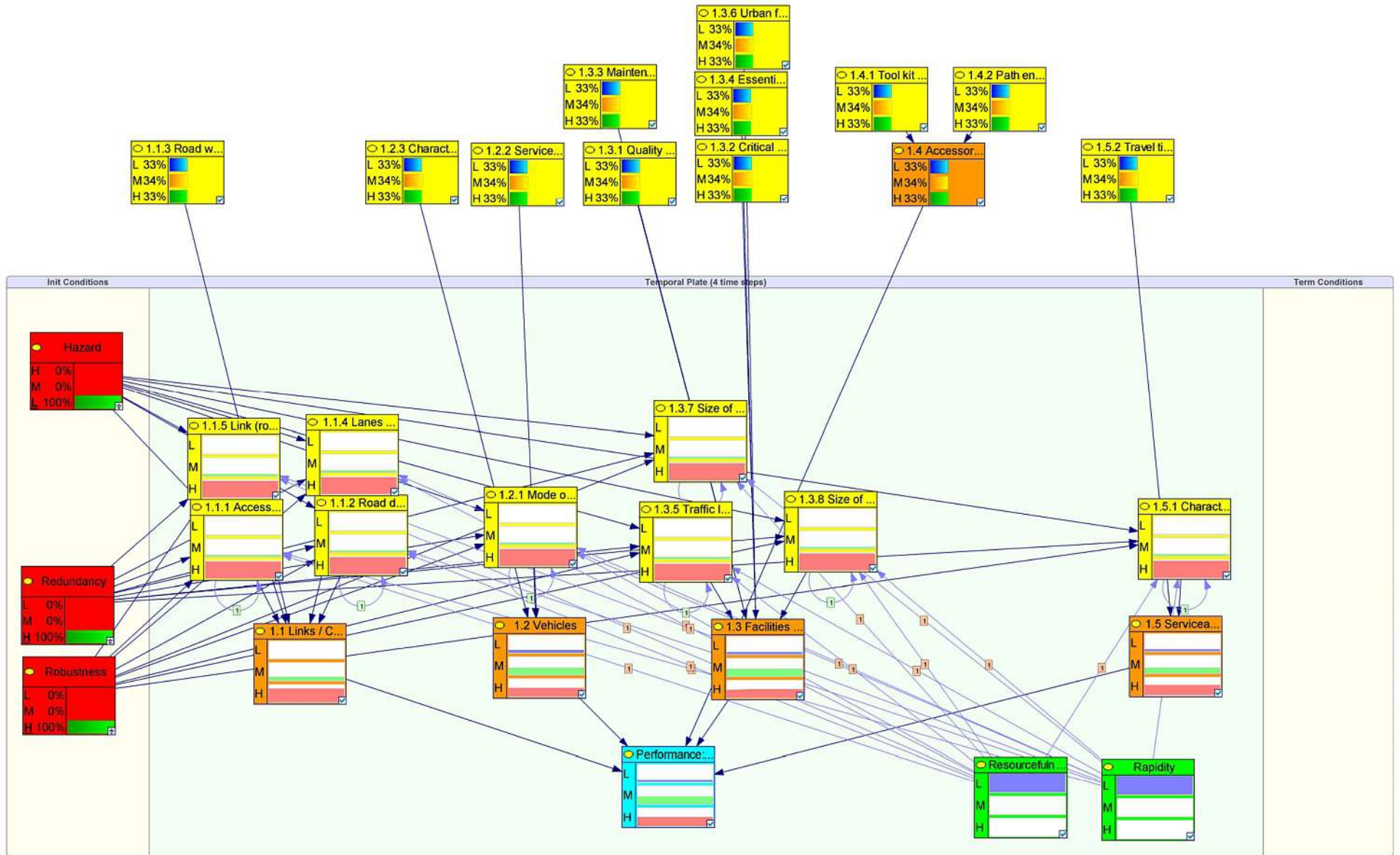

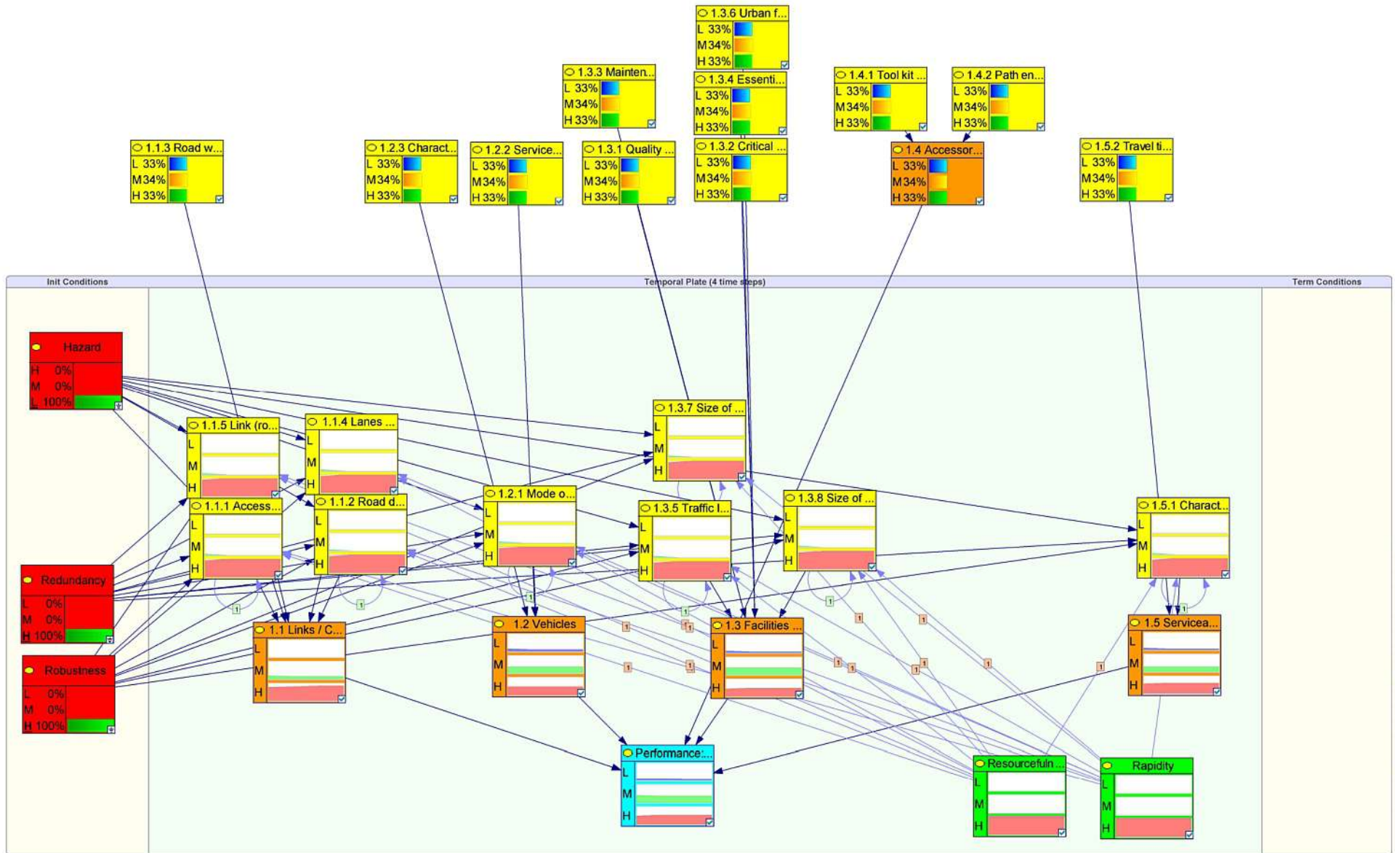

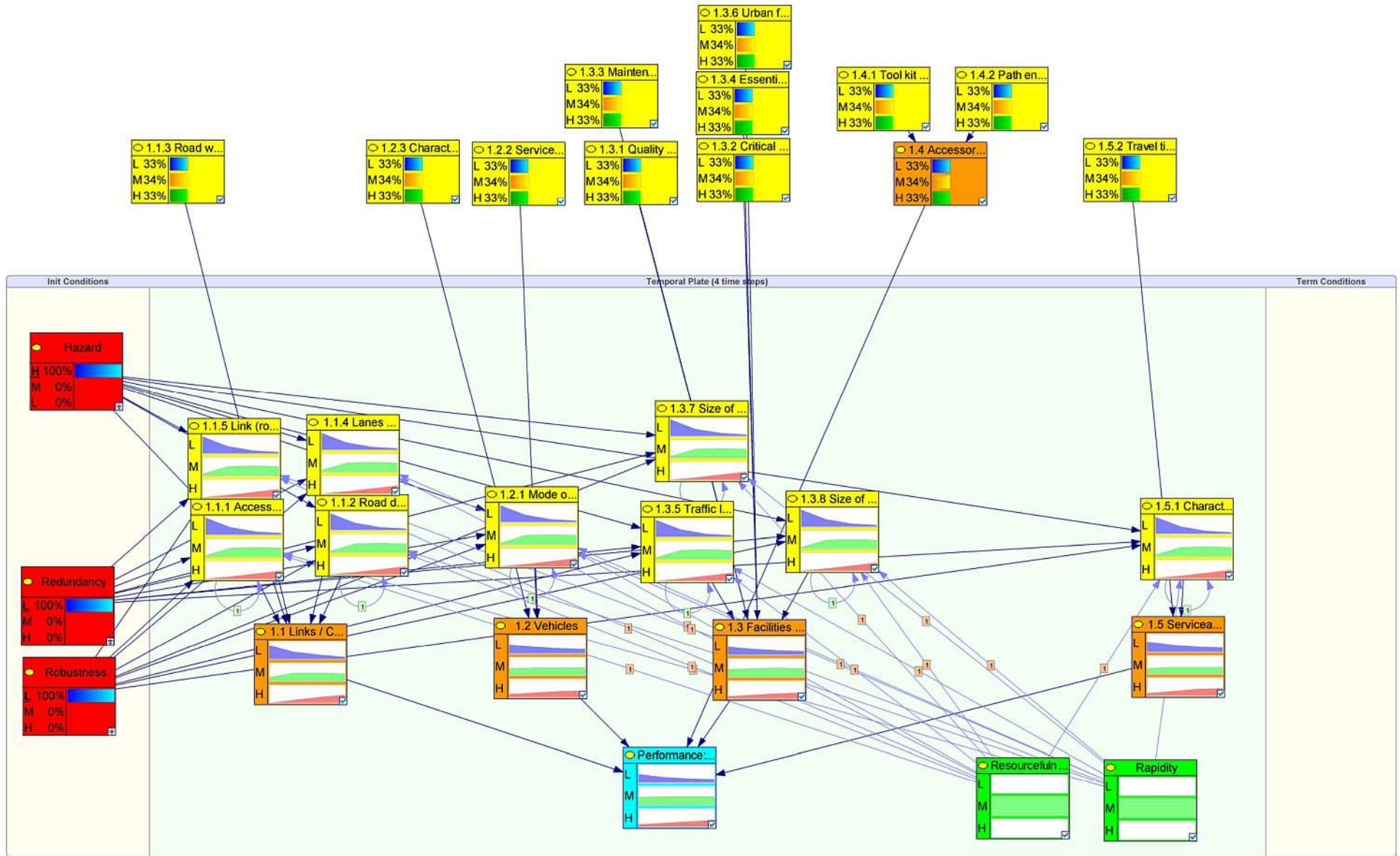

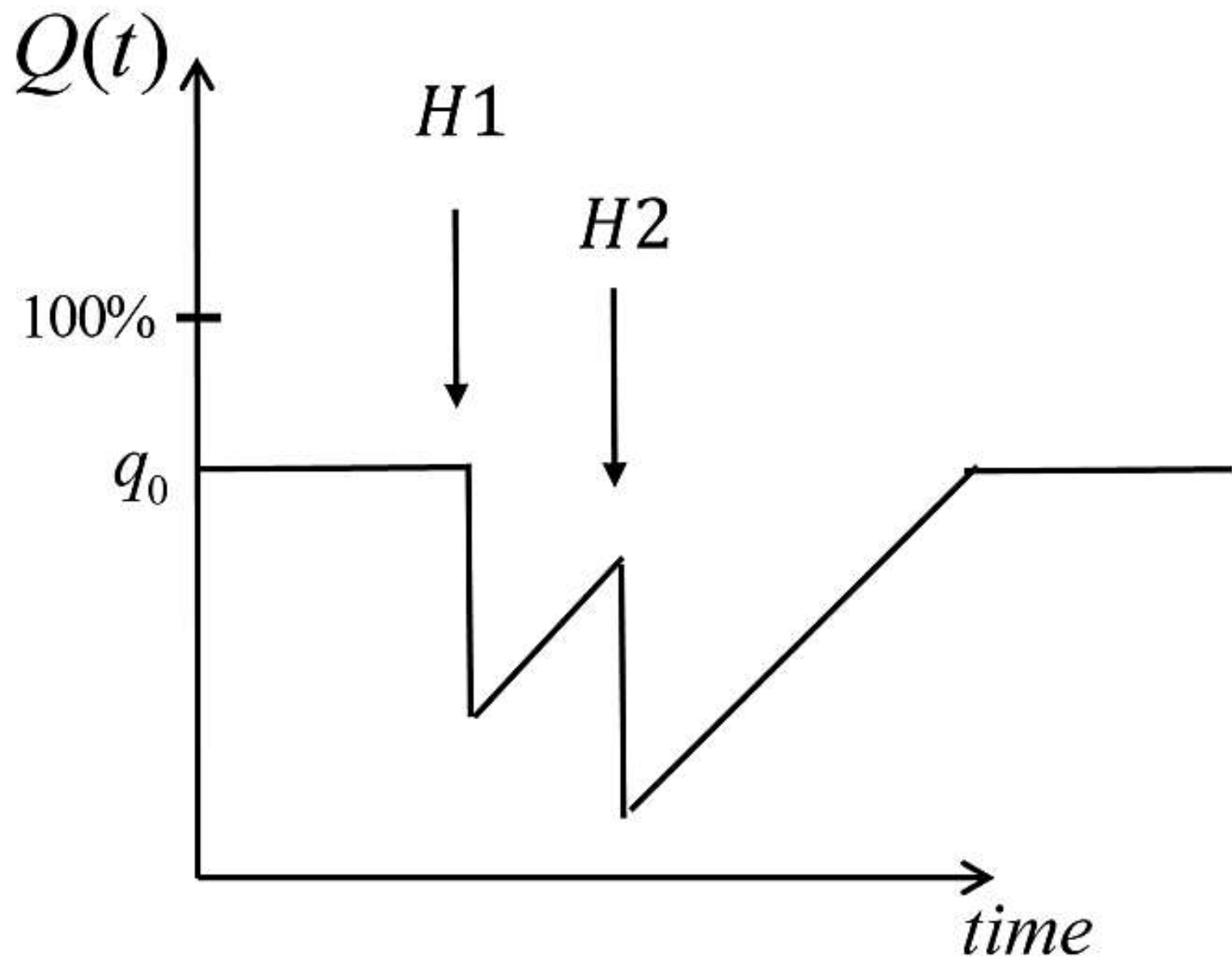

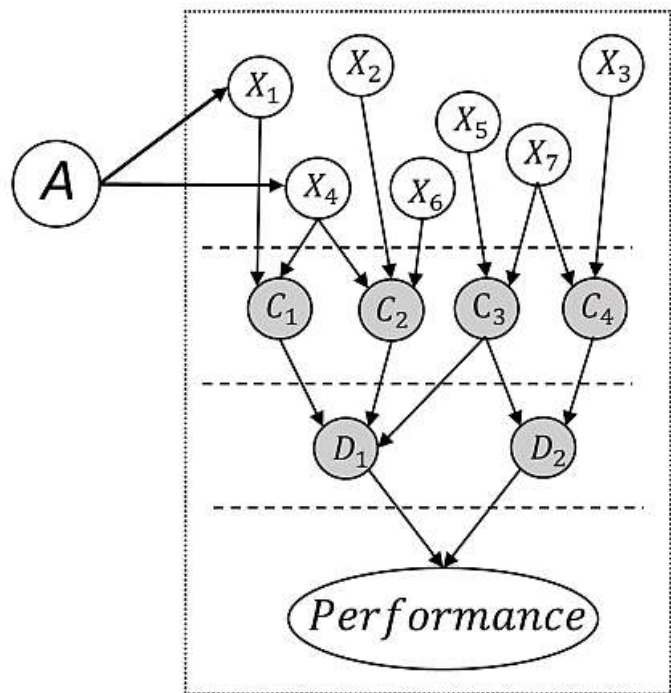

$t = 1$

...

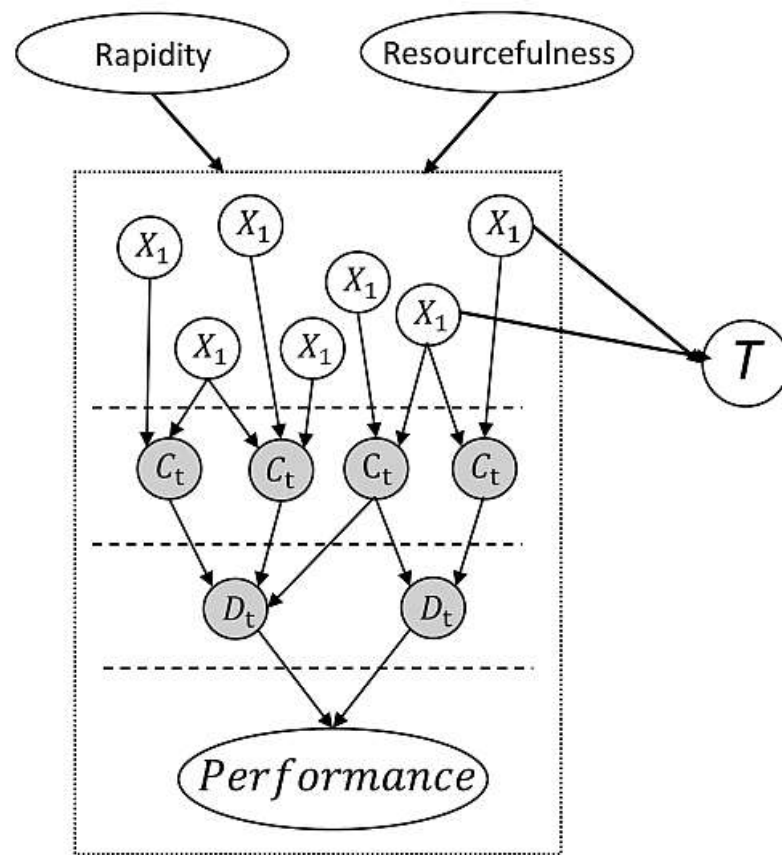

$t = T$

$t = 2, 3, \dots, T - 1$