

A new real-time approach for the load forecasting in the operation of sub-transmission systems

Original

A new real-time approach for the load forecasting in the operation of sub-transmission systems / Mosca, Carmelo; Marin, Enrico; Huang, Tao; Bompard, ETTORE FRANCESCO; Paolo, Cuccia; Laura, Campisano; Stefano, Neri. - (2019). (Intervento presentato al convegno AEIT International Annual Conference 2019).

Availability:

This version is available at: 11583/2758352 since: 2020-04-28T14:45:45Z

Publisher:

IEEE

Published

DOI:

Terms of use:

This article is made available under terms and conditions as specified in the corresponding bibliographic description in the repository

Publisher copyright

(Article begins on next page)

A new real-time approach for the load forecasting in the operation of sub-transmission systems

C. Mosca, E. Marin, T. Huang,
E. Bompard
Dipartimento Energia “Galileo
Ferraris”
Politecnico di Torino
Turin, Italy
carmelo.mosca@polito.it

P. Cuccia
Department of Dispatching
Terna Rete Italia S.p.A.
Turin, Italy
paolo.cuccia@terna.it

L. Campisano, S. Neri
Department of Dispatching
Terna Rete Italia S.p.A.
Roma, Italy
laura.campisano@terna.it

Abstract—The Transmission System Operators (TSOs) need to know exactly the main real-time electrical network parameters in order to operate the power system in a secure and efficient way. This is made using field measurements and signals whose redundancy in the high voltage transmission system allows the State Estimation algorithm to verify the coherence of the available measurements and to detect possible bad data. Nevertheless, in the lower voltage sub-transmission systems, the needed redundancy is not available, due to different reasons. It is important therefore to find alternative solutions to estimate and define pseudo-measurements in the sub-transmission systems in order to have a coherent State Estimation. In this paper, a new approach for the load forecasting in the high voltage sub-transmission system is proposed and implemented, aiming at obtaining “pseudo-measurements”. The proposed approach starts from the load estimation through Multiple Linear Regression, Artificial Neural Network (ANN) and a combination of them. The methodology is used to learn the relationship among past variables related to the loads. The results are compared to find the most suitable technique for the TSO, with a compromise between complexity and reliability and demonstrated on a real 132 kV sub-transmission system operated by the Italian TSO.

Keywords—short term load forecasting, artificial neural network, linear regression, clustering

I. INTRODUCTION

The increasing size and complexity of the electrical power system combined to the new challenges in terms of increase of renewables and evolution of new technologies for generation and utilization, is arising important needs for all the actors involved in the electrical system, in particular for the Transmission System Operators (TSOs). The non-predictability of new generation sources and the well-known volatile behaviour of load imposes further needs for the TSOs in order to safely and effectively operate the electrical transmission and sub-transmission networks. TSOs need to know the status of the grid accurately, in terms of static network parameters (impedance, resistance, current and voltage limits, etc.) and need to have reliable information, in terms of variables of interest, as voltages in all the nodes, active and reactive power flows in all the branches. State Estimation (SE) algorithms have been designed to ease the management and operation of the system, playing a key role in contingency analysis, operational planning and devising corrective/protective actions [1]. The SE is an overdetermined algorithm that allows the calculation of these variables of interest with high confidence despite bad data, i.e. measurements corrupted by noise, missing or grossly

inaccurate, given the availability of enough redundancy in the measurements. While in the conventional operation of a high voltage (HV) transmission system there is a redundant real-time information available to monitor the system, in the lower HV sub-transmission grid there is very little redundancy, due to the lack of measurements coming from private industrial loads and typically from the Distribution System Operators (DSOs). Currently, the addition of real-time monitoring and control devices is often quite expensive or not practicable for private industrial customers (where the measurement system are located), as it is not possible to measure every quantity in real time and telemeter it to the control centre [2]. In this context, the possibility of obtaining pseudo-measurements using load forecasting techniques and historical load data becomes an interesting and economic alternative, waiting for further technological improvements and solutions. Short-term load forecasting (STLF) has been used since long in the power system operation, and it is becoming increasingly important with the rise of the competitive energy markets [3]. Nevertheless, STLF is not an easy task, as the load depends on important exogenous variables, as the weather or the temperature. Many effective methods have been presented and discussed on STLF, with different degree of success. For example, [4, 5, 6] focus on the forecast of aggregated loads (e.g. a whole region electrical demand), but these kinds of loads have a much stronger autoregressive component than a single industrial load. In [7], the forecast of a single industrial plant absorption has been effectively dealt, but the proposed solution needs a deep knowledge of the internal dynamics (e.g. work shifts) of the industry considered. The application of such method in an entire HV grid would be infeasible. Furthermore, the statistical character of the load forecasting problem well fits the inner nature of most Artificial Neural Networks ANNs, which are mainly non-linear and non-parametric regression model [8].

In this paper, a new approach for estimating such loads is proposed and implemented, aiming at obtaining pseudo-measurements of the unknown loads in a HV sub-transmission system, which can be used as input for the SE algorithm. The proposed approach starts from the identification of the portion of the network to be analysed, followed by load estimation through a combination of multiple linear regression and artificial neural network techniques.

This paper is organised as follows. In Section II, we give a short overview to the power system control and security practise with particular reference to the Italian TSO. In Section III we develop an effective methodology for

estimating unknown loads. Section IV reports the implementation on a real case study of the North-West Italian HV sub-transmission grid, using a test machine running with real time data and comparing the results with those obtained from the techniques currently used by the Italian TSO. Section V reports the concluding remarks and future research ideas.

II. POWER SYSTEM CONTROL AND SECURITY

A. Control system and data management

The transmission electric grid control could be described in three main phases: ① *Scheduling*, where the demand forecast and generation plans are made ② *Real-time operation*, where the system operation and plants performance are monitored, optimizing and recovering the service in case of emergency ③ *Operation analysis*, where the operation is evaluated, failures and disservices are reconstructed and analysed.

For each phase, modern power systems include a large amount of IT devices finalized to monitor, control and protect the network. In particular the most important systems for the activities of control and operation are the remote-control system and its architecture in terms of central platform and field devices (remote terminal units) and the complex energy and market management systems (EMS and MMS). EMS include regulations and all the calculations finalized to support the decision-making layer, where the operators take the decisions for a correct system management (i.e. N-1 calculation, state estimation, optimal power flow). MMS include the day ahead scheduling and the market management.

The TSOs remote control and remote operation system (SCCT) collects grid information in terms of measurements and signals (ON/OFF status), shows data to operators and monitors the frequency/power and voltage regulations. The SCCT is used by the National Control Centre and by the Regional Control Centres, respectively with different functionalities.

B. State Estimation (SE)

The State Estimation (SE) is one of the main tools in the power system real-time operation and control. It is a statistical approach to calculate the unknown variables of a power system, to obtain the real-time model of the system, using a set of real-time measurements and signals as bus power injections, power flows and bus voltages. In general, in the SE, the number of measurements is higher than the number of input data of a conventional power flow. This redundancy is needed as the measurements can miss or be affected by errors. The SE can be formulated analytically using the following optimization problem:

$$\begin{aligned} \min f(\mathbf{z} - \mathbf{h}(\mathbf{x})) \\ \text{s. t. } g(\mathbf{x}) = 0 \\ c(\mathbf{x}) \leq 0 \end{aligned} \quad (1)$$

Where \mathbf{x} is the state vector of the estimation variables, \mathbf{z} is the measurements vector, \mathbf{h} is a vector function, which relates the state variables to the measurements, f is the objective function, g and c are the vector functions representing power flow quantities. In the weighted least-squares method, the following quadratic objective function is used:

$$f(\mathbf{z} - \mathbf{h}(\mathbf{x})) = (\mathbf{z} - \mathbf{h}(\mathbf{x}))' \mathbf{W} (\mathbf{z} - \mathbf{h}(\mathbf{x})) \quad (2)$$

Where the apostrophe denotes vector transposition and \mathbf{W} is a diagonal matrix of weights (in general, the inverse of measurements variances is used). Equality and inequality constraints are used to represent target values and limits in the unobservable parts of the network.

III. PSEUDO REAL-TIME METER (PRTM)

Considering the measurements and signals coming from the Control System, a Missing Information Estimator (MIE) algorithm provide the missing information for the SE. In particular, it consists in a pre-processing tool based on Python language that covers the missing information using easy automatic logics: mathematical operators, logic operators and management of quality codes of the information. The pre-process receives in input the subset of measurements and rebuild the missing information for example using Kirchhoff equations or in general exploiting the grid parameters in order to pre-calculate the measurements. Also logic about the status of the grid elements based on the combination between measurements and signals are implemented. This tool provides to the SE a coherent snapshot of the grid with the minimum requirements in terms of redundancy and topological congruency. Currently, the MIE works only with a deterministic approach and the validation is based on a static snapshot of the grid, the challenge consists in adding modern support algorithms based on statistical and training approaches. This paper focuses on integrating the MIE with a support algorithm, which is the pseudo real-time meter (PRTM), i.e. the proposed methodology to help the MIE to obtain an effective and correct SE. In this Section, the process to realize the PRTM is given, starting from the description of the investigated techniques and the actual implemented methodology. In Fig. 1, a schematic view of the data flow from the field to the real-time model is given.

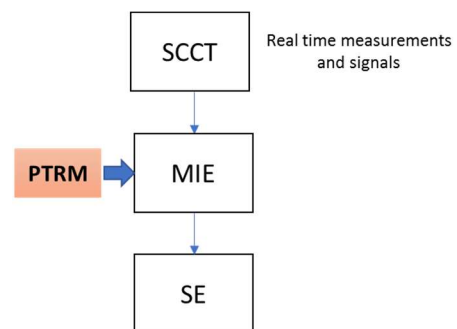

Fig. 1. Data flow in the State Estimation process, .

A. Multiple-linear regression (MLR)

The linear regression is a statistical approach used to describe and model the causal algebraic relationship between a dependent variable with one or more independent variables. If the relations use only an independent variable, it is a linear regression, otherwise multiple-linear regression. First, a correlation analysis needs to be carried out to verify whether a relation between the unknown loads and the power flows on the lines departing from the "electrically" nearest stations exists. Intuitively, the load value should be linked to the power flow at the beginning of the feeding line, deducting the

absorption of the HV/MV substations and summing the generations located between the measurement points and load connection points. Fig. 2 represents a conceptual scheme of the possible regression that could be used in a HV sub-transmission grid. Nevertheless, finding an easy solution in this way in a large system is not possible, as the total industrial load would be obtained instead of the single one, which is the target of our work. Consequently, the idea is to predict the loads by means of a regression using many independent variables to exploit the similarities between load patterns. The first approach of our methodology is based then on the use of a multiple-linear regression (MLR), using as regressors the power data acquired in real time, and the loads to be forecasted as dependent variables.

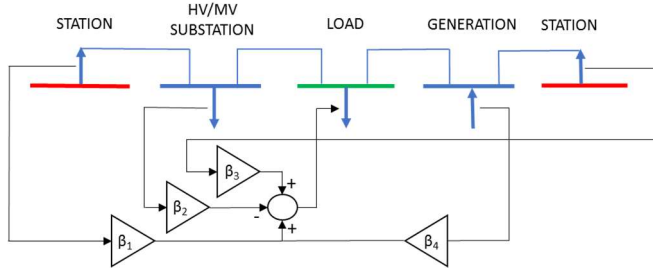

Fig. 2. Conceptual scheme of a possible regression method to be used in a HV sub-transmission system.

The regression analysis is carried out considering as complex regressors (in terms of real and imaginary part):

- the power flows at the beginning of the lines departing from the stations;
- the production of the generation plants;
- the absorptions of the HV/MV substations.

The target of this method is to find a relation, for each load to forecast, as follows:

$$y_p = \beta_{p0} + \beta_{p1}x_{p1} + \beta_{p2}x_{p2} + \dots \quad (3)$$

where β_p are the coefficient of the regression for the p -th load, y_p is the dependent variable and x_p are the independent variables. In this study, the regressors are the available real-time measurements, while the dependent variable is the load to forecast.

B. Artificial Neural Networks (ANNs)

The MLR is a forecasting analysis based on a relationship between the real-time measurements and the variables to forecast. Nevertheless, industrial consumptions are stochastic phenomena with a strong autoregressive component. This feature makes artificial neural networks (ANNs) suitable tools for the estimating processes, using the historical past data. The ANN used in this paper is inspired by the one proposed in [8], with historical absorptions and day indexes as inputs [9, 10]. It is a Radial Basis Function [11] neural network composed of two hidden layers with ten neurons each (Fig. 3). The input layer is fed by the input vectors, while the hidden layers are composed by units called bases, which transform by a non-linear activation function (a sigmoid function) the signals received from the previous layer. The output layer produces the forecasts using the non-linear weighted relationship of the process. The ANN computes the load to be forecasted using the historical values of the past week and day as follows:

$$L(t) = f \left(\begin{matrix} L(t-673), L(t-672), L(t-671), \\ L(t-97), L(t-96), q(t), d(t), i(t) \end{matrix} \right) \quad (1)$$

Where t is the time (quarter of an hour), $L(t)$ is the load at time t , $q(t)$ is the quarter of an hour (of day) number (1 to 96), $d(t)$ is the day (of week) number (1 to 7), $i(t)$ is the index indicating whether the load to forecast is in a midweek holiday (1 or 0). Two ANNs are trained, to predict both the active and reactive power of the unknown loads $L(t)$.

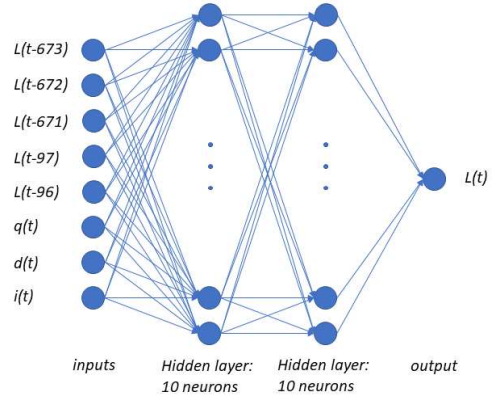

Fig. 3. Scheme of the structure of the ANN used.

C. PRTM as combination of MLR and ANN

Both the MLR and the ANN can provide good results, but they sometimes produce abnormal values, peaks and notches. For example, the ANNs are accurate in case of a recursive load profiles [11], but they can have difficulties in forecasting the load during midweek holidays or in case of anomalous absorptions, e.g. for internal company reasons (technical failures, strikes etc.). On the contrary, the MLR is in general less precise and it shows occasionally some incorrect peaks and notches [12]. Nevertheless, the MLR is more reliable in such midweek holidays, as it strongly depends on the real-time measurements, mitigating large errors. Thus, in this paper we investigate a combination of the two methods as a simple but effective solution to exploit the benefits of both techniques, obtaining the Pseudo Real-Time Meter (PRTM) [10]. With an arithmetic average between the results obtained from the MLR and the ANN, the forecasted load has still a good precision and it is less prone to abnormal values, with a reduction in the forecasting error in case of peaks or notches. Another way for improving the forecasting method is to divide the training dataset into groups composed by days with similar absorption profiles, using a cluster analysis [13]. For each category, it is possible then to develop a specific forecasting method. For example, an ANN trained specifically to forecast loads during holidays is more effective than a network trained to forecast loads in each kind of day. The drawback of this method is the need to recognize a priori the kind of cluster to assign to the day to forecast. As first instance, two clusters can be considered (working and not-working days) to ease the identification of the day, while the task would be very complex with several clusters. In this paper, a two-cluster method has been inspected to analyse the possible improvements and benefits over the unique ANN method.

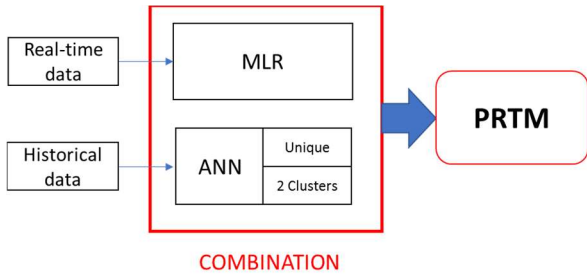

Fig. 4. Process scheme of the PRTM.

IV. CASE STUDY

A. Sub-transmission system description

The studies are carried out over a part of the North-Western Italian HV sub-transmission grid that is fed by 4 stations and composed by 12 industrial loads, 30 HV/MV substations and 7 power plants (Fig. 5). Real-time measures (each quarter of an hour) of active and reactive powers are taken at the beginning of the lines departing from the stations, on the transformers of the HV/MV substations and on the transformers of the generation plants. For industrial loads, consumption data is usually available with high precision but only the day after. All the historical data of the whole grid part is available.

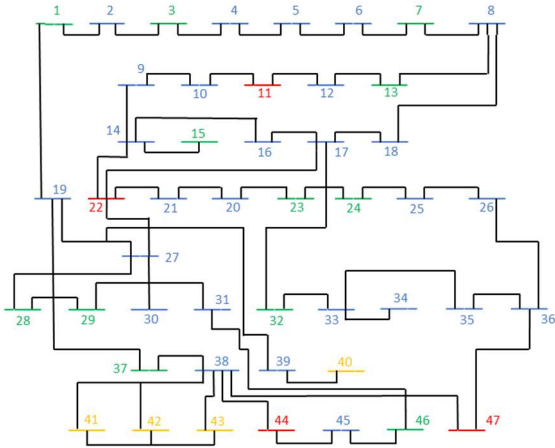

Fig. 5. One-line graph of the grid portion studied. The nodes in green are buses connected at least to one load. The nodes in yellow are buses connected at least to one generating unit. The red nodes represents the HV substations. The other nodes are HV/MV substations.

B. Application and results

Before applying the methodology described in the previous Section, a correlation analysis has been conducted.

The analysis showed the poor correlation between a load and the power flows on the lines departing from the "electrically" nearest stations (rarely over 0.5). This is because the profile of those power flows depends more on the absorption of the HV/MV substations than on the industrial loads. Inspection of Fig. 6 highlights this dependence, while the load behaviour can be denoted as a small noise which slightly modify the general relationship. Considering also the accuracy errors of the real time measurements, that sometimes are of the same order of the load adsorption, it is not possible to describe the loads' behaviour by means of a

causal relationship in large HV sub-transmission grids, as outlined in the previous Section.

It has been decided to use the MLR with 47 regressors:

- 10 power flows at the beginning of the lines departing from the stations;
- 7 production of generation plants;
- 30 absorptions of the HV/MV substations.

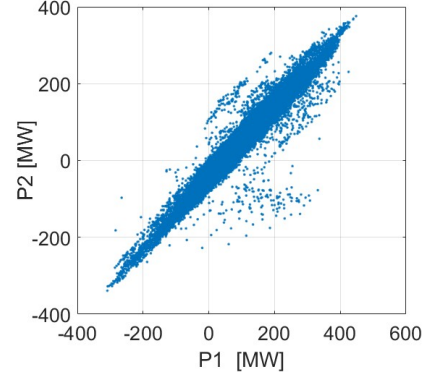

Fig. 6. Plot of P1 as a function of P2, with P1 active power injected into the HV sub-transmission grid from the HV stations and P2 sum of the active power absorbed by HV/MV substations and generation plants.

The ANN has been trained on the historical consumption of the industrial loads to forecast. Both methods are "trained" on the first 11 months of 2018 and tested on December of the same year, obtaining the coefficients for the MLR and the ANN. The methods have been tested in December as it is a critical month to forecast due to a high number of holidays. The performance of the different methods is compared using the following errors:

- Mean Absolute Errors (MAE) for each load normalized by the corresponding yearly peak absorption:

$$MAE = \frac{\sum_1^n |x_i - \tilde{x}_i|}{n} \frac{1}{L_p} \quad (3)$$

- Root Mean Square Error (RMSE)

$$RMSE = \sqrt{\frac{\sum_1^n (x_i - \tilde{x}_i)^2}{n}} \frac{1}{L_p} \quad (3)$$

- Mean Absolute Relative Percentage Error (MARPE)

$$MARPE = \frac{\sum_1^n \left| \frac{x_i - \tilde{x}_i}{x_i} \right|}{n} \frac{100}{L_p} \quad (3)$$

Where x_i and \tilde{x}_i are the actual and forecasted value respectively, n is the number of forecasted values and L_p is the yearly peak absorption.

Fig. 7 and 8 show respectively the result of the load connected in the bus n°7 of the examined sub-transmission system obtained using the MLR and the ANN fitted over the first 11 months of the 2018. In this case, the ANN is the one trained without considering clustering. As it can be seen, the ANN is more reliable than the MLR when the load behaviour is recursive, but it fails in correspondence of the midweek holiday of the 8th December, with a false peak. On the contrary, the MLR is able to contain the error during the same day. Fig. 9 describes the behaviour of the proposed forecasting, obtained by the combination of the MLR and ANN results.

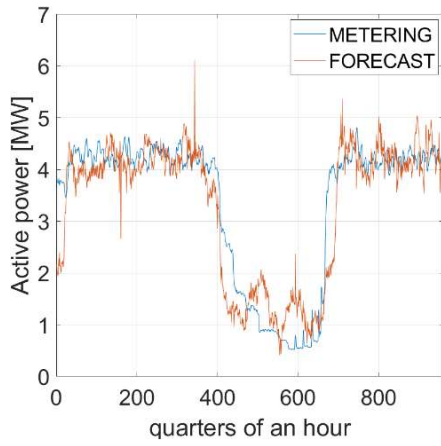

Fig. 7. Results of the load (connected in bus n°7) estimation obtained by means of the MLR fitted over the first 11 months of 2018. The results refer to the period from 4th to 13th of December 2018.

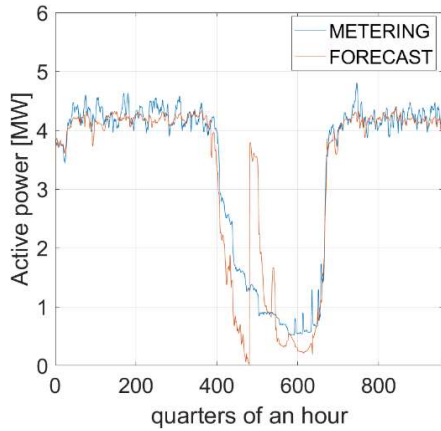

Fig. 8. Results of the load (connected in bus n°7) estimation obtained by means of the ANN trained over the first 11 months of 2018. The results refer to the period from 4th to 13th of December 2018.

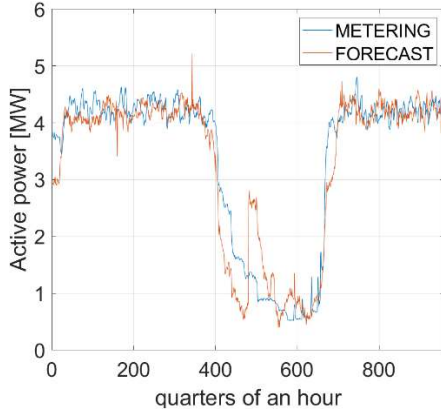

Fig. 9. Results of the load (connected in bus n°7) estimation obtained by means of the combination of the MLR and ANN. The results refer to the period from 4th to 13th of December 2018.

The different techniques are compared in Table I, using the errors described above (MAE, RMSE and MARPE) for both the active and reactive power estimation for load in bus n°7 in the period from 4th to 13th of December 2018. The MLR is evaluated for the cases of 10, 17 and 47 regressors.

TABLE I. ACTIVE AND REACTIVE POWER ESTIMATION - MAE, RMSE, MARPE – LOAD BUS 7

Method	Active power			Reactive power		
	MAE	RMSE	MARPE	MAE	RMSE	MARPE
MLR 10 regressors	0.24	0.279	104.9	0.234	0.274	199.7
MLR 17 regressors	0.226	0.26	95.2	0.223	0.262	140.3
MLR 47 regressors	0.152	0.201	48.5	0.184	0.243	105.8
ANN	0.086	0.149	41.4	0.083	0.132	99.1
PRTM	0.106	0.137	41.6	0.115	0.15	76.2

The same procedure has been applied to all the loads to forecast in the HV sub-transmission system, and the errors have been calculated as an average for all of them. Thus, a total view of the forecasting error is given. These errors are computed as an average for all the loads in the grid part analysed, to have an overall idea of the total benefits of the approaches and reported in Table II.

TABLE II. ACTIVE AND REACTIVE POWER ESTIMATION – MAE, RMSE, MARPE – TOTAL LOAD

Method	Active power			Reactive power		
	MAE	RMSE	MARPE	MAE	RMSE	MARPE
MLR 10 regressors	0.195	0.241	135.8	0.198	0.238	269.9
MLR 17 regressors	0.198	0.246	135.8	0.180	0.218	217.1
MLR 47 regressors	0.166	0.206	130.5	0.156	0.195	162.7
ANN	0.103	0.159	88.8	0.118	0.117	117
PRTM	0.122	0.159	94.7	0.116	0.155	107

To investigate possible improvements in the results, two different ANN are trained, using the historical data clustered in two groups, for working days and holidays. Fig. 10 presents the population of the two clusters for the months of January and February, using the k-means method. In the working days, the patterns are quite homogeneous, resulting in more precise forecasts. On the contrary, the cluster composed of holidays is strongly heterogeneous and there are at least three sub-clusters that could be easily identified. Because of this heterogeneity, the forecast of the holidays is still inaccurate. Given the accuracy of the before described methods, the deep investigation of more clusters has not been investigated, considered out of the scope of this paper.

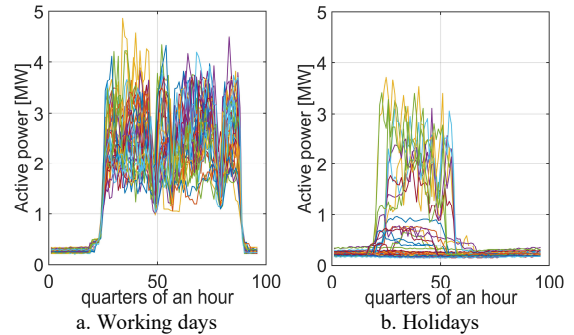

Fig. 10. Clusters of the historical data for the load in bus n°15 for the months of January and February.

The values of MAE are reported in Table III, for the case of a unique and two clusters ANNs. As it can be seen, at present the use of two ANN does not imply substantial

improvements in the results to justify the complexity of the approach.

TABLE III. ACTIVE AND REACTIVE POWER ESTIMATION – MAE – TOTAL LOAD

Method	Active power MAE	Reactive power MAE
Unique	0.09	0.111
Two clusters	0.084	0.110

C. Implementation and validation

To validate the behaviour in real-time, the proposed approach has been implemented using a TSO's testing machine that works in parallel to the computers currently operating the SE. As a first attempt, the MLR is chosen because of its simplicity of implementation and its stability. The MLR is less effected by the possibility that real-time measurements are missing or affected by errors while an ANN is more sensible to these problems.

The proposed and current forecasts work with the same inputs but produce different estimates that are compared graphically and quantitatively, as depicted in Fig. 11.

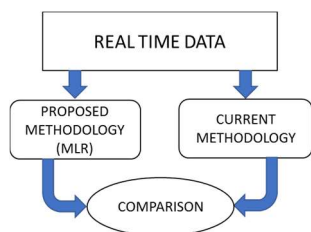

Fig. 11. Scheme of the comparison procedure.

The results for the loads in bus n°15 and n°46 between the proposed and current forecasts are shown in Fig. 12, comparing them with the actual measurements. It is evident that the proposed methodology, even if considering only the MLR part of the PRTM, improves the performance of the load forecasting. The MAE for the current and proposed methodology is reported in Table IV, in terms of active and reactive power forecasts.

TABLE IV. ACTIVE AND REACTIVE POWER ESTIMATION – MAE – TOTAL LOAD

Method	Active power MAE	Reactive power MAE
Current methodology	0.609	0.772
Proposed methodology (MLR)	0.186	0.259

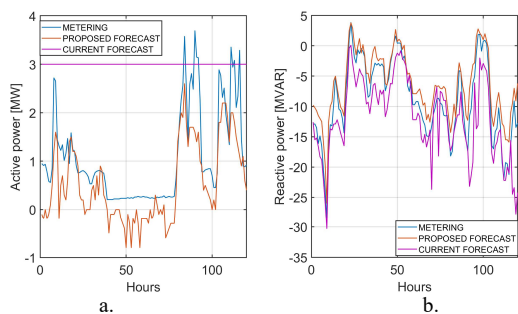

Fig. 12. Comparison between the proposed forecast, the current forecast and the actual consumption for: a. active power of the load in bus n°15 over the

period from 18th to 22th of January, b. reactive power of the load in bus n°46 over the period from 18th to 22th of January.

V. CONCLUSIONS

Different techniques for forecasting industrial loads connected to the HV sub-transmission system have been presented and investigated. Among them, the best theoretical results, in terms of a compromise between precision and reliability, have been obtained from a combination of a MLR and an ANN, defining the PRTM. Anyway, for the application in the TSO systems, the MLR is considered as more suitable method for the manageable implementation and its robustness. It is easy to implement and to debug, no deep IT knowledge is needed.

The results obtained from the comparison between the proposed methodology and the currently employed show already remarkable improvements of the forecasts using only the MLR. It is expected that the implementation of the PRTM in future developments of the work will improve further the results.

REFERENCES

- [1] A. Monticelli, State Estimation in Electric Power System. Springer Science & Business Media, New York, 1999.
- [2] M.E. Baran, A.W. Kelley, "State Estimation for real-time monitoring of distribution systems", IEEE Transactions on Power Systems, vol. 9, pp. 1601-1609, 1994.
- [3] H.S. Hippert, C.E. Pedreira, and R.C. Souza, "Neural Networks for Short-Term Load Forecasting: A review and Evaluation", IEEE Transactions on Power Systems, vol. 16, pp. 44-55, February 2001.
- [4] A. Guerini, G. De Nicolao, "Long and short-term electric load forecasting on quarter-hour data: a 3-torus approach", 2016 IEEE 16th International Conference on Environment and Electrical Engineering (E3E), June 2016.
- [5] D.X. Niu, Q., Wanq, and J.C. Li, "Short term load forecasting model using support vector machine based on artificial neural network", 2005 International Conference on Machine Learning and Cybernetics, vol. 7, pp. 4260-4265, August 2005.
- [6] S. Singh, S. Hussain, and M.A. Bazaz, "Short term load forecasting using artificial neural network", 2017 Fourth International Conference on Image Information Processing (ICIIP), pp. 1-5.
- [7] A. Bracale, G. Carpinelli, P. De Falco, and T. Hong, "Short-term industrial load forecasting: a case study in an Italian factory", 2017 IEEE PES Innovative Smart Grid Technologies Conference Europe (ISGT Europe), pp. 1-6, 2017.
- [8] E. Bompard, E. Carpaneto, G. Chicco, R. Napoli, F. Piglion, "Short-term load forecasting of a small electric utility by fast learning RBF neural network", Proc. PMAPS 2000, 2, 2000.
- [9] A.G. Bakirtzis, V. Petridis, S.J. Kiartzis, M.C. Alexiadis, "A Neural Network Short Term Load Forecasting Model for the Greek Power System", IEEE Transactions on Power Systems, vol. 11, n. 2, pp. 858-864, May 1996.
- [10] P. Xiuyan, B. Zhang, and C. Yanqing, "The short-term load forecasting of electric power system based on combination forecast model", The 27th Chinese Control and Decision Conference (2015 CCDC), IEEE, pp. 6509-6512, 2015.
- [11] P. Ray, D.P. Mishra, and R.K. Lenka, "Short term load forecasting by artificial neural network", 2016 International Conference on Next Generation Intelligent Systems (ICNGIS), IEEE, pp. 1-6, 2016.
- [12] A.Y. Saber, A.R. Alam, "Short term load forecasting using multiple linear regression for big data", 2017 IEEE Symposium Series on Computational Intelligence (SSCI), IEEE, pp. 1-6, 2017.
- [13] J. Moody, C.J. Darken, "Fast learning in network of locally-tuned processing units", Neural Computation, vol. 1, pp. 281-284, 1989.
- [14] G. Chicco, "Overview and performance assessment of the clustering methods for electrical load pattern grouping", Energy, vol. 42, pp. 68-80, Jan. 2012.