



**ScuDo**  
Scuola di Dottorato ~ Doctoral School  
WHAT YOU ARE, TAKES YOU FAR



Doctoral Dissertation  
Doctoral Program in Architecture and Landscape Heritage (32<sup>nd</sup> Cycle)

**Experimental workflow for the creation of a  
non-conventional open source HBIM platform  
integrating metric data and stratigraphic  
analysis: the case study of the refectory of  
Santa Maria di Staffarda Abbey**

**Filippo Diara**  
\*\*\*\*\*

**Supervisors**

Prof. Fulvio Rinaudo, Supervisor  
Prof.ssa Silvia Beltramo, Co-Supervisor

**Doctoral Examination Committee:**

Prof.ssa Caterina Balletti, Università IUAV di Venezia, *Referee*  
Prof.ssa Raffaella Brumana, Politecnico di Milano  
Prof. Pierre Grussenmeyer, INSA Strasbourg  
Prof.ssa Antonia Spanò, Politecnico di Torino  
Prof. Efstratios Stylianidis, Aristotle University of Thessalonikki, *Referee*

Politecnico di Torino  
April 22, 2020



# Abstract

The decision to carry out this research was moved from particular needs and questions affecting the actual architectural heritage and building archaeology panorama, especially as far as the documentation and preservation of Cultural Heritage assets are concerned. In this regard, a particular methodology called Building Information Modelling (BIM) is changing and revolutionising the way to produce and preserve documentation and in general information. BIM methodology has been developed especially for AEC industry (Architecture Engineering Construction), then for architectural design and technical installations and it allows to collect and include information inside 3D models also establishing relations (such as geometric and semantic) and between objects and related information. Despite BIM advantages, this methodology is not widely used for Cultural Heritage assets and it could be considered still an ongoing research field, also due to the limitations resulting of commercial BIM solutions, developed and designed to support AEC industry management and for this reason they could rarely adapt their workflows (from modelling tools to semantic dimension) and methods to Heritage assets.

Analysing its peculiarities, BIM, and in particular HBIM (Historic Building Information Modelling) could become the proper methodology as far as the Cultural Heritage assets documentation and preservation, providing the integration of different kind of information through semantic relations. Indeed, the inclusion of historical information on HBIM platform produces and involves advantages for managing, monitoring and valorisation processes, as well as benefits for the purpose of investigating historical evolution of historic architecture. Through the BIM methodology becomes possible to increase the documentation phase and to comprehend information stored inside the model in order to have a complete panorama of the analysed context by establishing and managing custom datasheet, database and ad-hoc queries, ensuring in this way the quality and preservation of data.

In this regard, stratigraphic information are particular features to be included inside an HBIM platform especially since stratigraphy is a unique historical information that rarely can be found on archives or other resources. In this sense, stratigraphy and its analysis, widely used and implemented in archaeological excavations has become a fundamental tool also for historical buildings and then for *building*

*archaeology* purposes. By using this analysis on the stratification, a complete identification map of *layers* or *units* can be extracted for the purpose of understanding the transformation and evolution of the stratification. As far as building archaeology is concerned, this *reading map* is a fundamental analysis not only for comprehending the historical evolution of the construction site (analysing constructive and destructive actions on wall surfaces) as well as for the comparison operations between the structure of an historical building with its mechanical behaviours taking into account the specific events that have changed the building static asset.

For these reasons, stratigraphy is a type of information to be preserved and documented in the best way possible and BIM methodology could be the right solution, because stratigraphic units, as well as pathologies and surface features can be modelled as wall components and connected to the parametric model of the surveyed building.

Acting in this way it is also possible to obtain a complete framework as far as the historical evolution of the analysed historic architecture through stratigraphic analysis (if visible) is concerned, collecting and increasing the amount of knowledge concerning the evolution of the building inside the HBIM platform. Moreover, the inclusion of stratigraphy involves benefits for risk and vulnerability comprehension, attaching to the parametric model constructive and destructive actions concerning historical buildings.

Performing this kind of integration, the resulted limitations of traditional stratigraphic studies (in general paper-based analysis often disconnected from the architectural context and from other resources) can be avoided, ensuring a good data collection and protection. For this reason, BIM methodology could be the right solution for building archaeology and architecture history studies.

Despite these advantages, this type of historic implementation could be considered an ongoing research field, especially since the HBIM operative steps differs from a classical BIM workflow and the integration of not common information inside a BIM platform depends also on testing experimental and not conventional procedures and workflows as well as not common software: in fact, inside this project, the decision to carry out an HBIM platform by using a particular scan-to-BIM process via NURBS modelling by also using an open source BIM solution (and this workflow could be named *scan-to-openBIM via NURBS*) has followed exactly this thought. The decision of NURBS modelling – by using Rhinoceros software – has been adopted in order to reach a high LOD (level of detail) as well as high GOG (Grade Of Generation) as far as the 3D model is concerned, avoiding the objective modelling limitations of BIM software. In this regard, actual BIM

solutions offer modelling tools based on predefined and limited architectural libraries editable parametrically, but in this sense, Cultural Heritage assets requires to be comprehended, simplified and modelled manually depending on specific needs as well as their features and peculiarities are concerned.

Moreover, the decision to develop a custom HBIM platform by using open source solutions – by compiling and customizing FreeCAD software – it has been taken for the purpose of having the complete access and control to the source code, libraries, tools and then to the entire software, adapting and modifying the software workflow and in general the instrument analysis to specific Cultural Heritage assets and research needs. Then, this work is essentially based on analysis and experimentations of not common commercial (Rhinoceros) and open source (FreeCAD) software applied to a custom HBIM workflow for the purpose of verifying their flexibility, stability and reliability, creating a dynamic open source HBIM platform focusing on the integration of stratigraphic analysis as historical information.



# Index

**List of figures**

**List of tables**

**Attachments list**

**Abbreviations and acronyms**

|  |     |
|--|-----|
| <b>1. Introduction and objectives</b> .....                  | p.1 |
| <b>2. Methodology</b> .....                                  | 9   |
| 2.1 Introduction to BIM .....                                | 10  |
| 2.2 HBIM state of art .....                                  | 14  |
| <b>3. Case study: the refectory of Staffarda abbey</b> ..... | 19  |
| 3.1 Historical framework .....                               | 19  |
| 3.2 Santa Maria di Staffarda abbey .....                     | 24  |
| 3.3 The refectory .....                                      | 34  |
| <b>4. Stratification and stratigraphy</b> .....              | 51  |
| 4.1 Introduction to stratigraphy.....                        | 51  |
| 4.2 Buildings archaeology.....                               | 54  |
| 4.3 Documenting stratigraphy.....                            | 65  |
| 4.4 Interpretation: relations, phases and periods.....       | 69  |
| 4.5 Stratigraphy as historical information.....              | 72  |
| <b>5. Metric survey of Staffarda refectory</b> .....         | 75  |
| 5.1 Metric survey background .....                           | 75  |

|  |            |
|--|------------|
| 5.2 Topographic framework of the refectory .....           | 80         |
| 5.3 LiDAR acquisition of the refectory .....               | 89         |
| <b>6. Data processing and management.....</b>              | <b>97</b>  |
| 6.1 Point clouds registration and alignment.....           | 97         |
| 6.2 Reality-based model creation.....                      | 103        |
| 6.2.1 Point clouds management.....                         | 104        |
| 6.2.2 3D mesh generation.....                              | 107        |
| 6.3 Sections and best fitting planes.....                  | 111        |
| <b>7. Stratigraphic survey and analysis .....</b>          | <b>117</b> |
| 7.1 Stratigraphic survey of the refectory .....            | 117        |
| 7.2 Orthophotos generation.....                            | 117        |
| 7.3 Stratigraphic analysis of the refectory .....          | 124        |
| <b>8. Historical interpretation of the refectory .....</b> | <b>143</b> |
| 8.1 Matrix generation.....                                 | 143        |
| 8.2 Matrix interpretation: phases .....                    | 153        |
| 8.3 Chronological periods .....                            | 164        |
| 8.4 Chronological interpretation of the refectory .....    | 188        |
| <b>9. Refectory NURBS modelling .....</b>                  | <b>193</b> |
| 9.1 Introduction to NURBS models.....                      | 194        |
| 9.2 Rhinoceros as NURBS free form modeller.....            | 196        |
| 9.2.1 Main features of Rhinoceros .....                    | 196        |
| 9.3 Geometric primitives extraction.....                   | 200        |
| 9.3.1 Introduction to geometric primitives.....            | 200        |
| 9.3.2 Refectory geometric primitives .....                 | 201        |
| 9.4 Modelling the refectory.....                           | 204        |
| 9.4.1 3D modelling of architectural elements .....         | 204        |
| 9.4.2 Grade Of Generation analysis .....                   | 216        |



|            |  |            |
|------------|--|------------|
| 9.4.3      | Grade Of Accuracy of vaulted ceiling.....                      | 218        |
| 9.5        | Stratigraphic units modelling and mapping .....                | 223        |
| 9.6        | Analysis and hypothetical reconstruction of the refectory..... | 235        |
| 9.6.1      | Analysis on old ceiling supporting elements.....               | 235        |
| 9.6.2      | Hypothetical reconstruction of the refectory.....              | 238        |
| <b>10.</b> | <b>A non-conventional HBIM platform.....</b>                   | <b>245</b> |
| 10.1       | Open source thought inside BIM .....                           | 245        |
| 10.2       | FreeCAD .....  | 247        |
| 10.2.1     | Main features of FreeCAD.....                                  | 249        |
| 10.3       | Compiling FreeCAD .....  | 251        |
| 10.3.1     | FreeCAD on MacOS .....   | 252        |
| 10.3.2     | FreeCAD on Windows .....                                       | 254        |
| 10.4       | FreeCAD customization and implementation.....                  | 255        |
| 10.4.1     | Libraries, macros and workbenches .....                        | 255        |
| 10.4.2     | Material database.....   | 258        |
| 10.4.3     | Custom roles for FreeCAD.....                                  | 260        |
| 10.4.4     | IFC schema proposal for Cultural Heritage assets .....         | 261        |
| 10.5       | Refectory HBIM platform.....                                   | 264        |
| 10.5.1     | NURBS managing process.....                                    | 264        |
| 10.5.2     | IFC entities and roles.....                                    | 268        |
| 10.5.3     | Description of IFC entities .....                              | 273        |
| 10.5.4     | Materials of IFC entities .....                                | 273        |
| 10.5.5     | Standard Code for IFC entities .....                           | 276        |
| 10.5.6     | Tags for IFC entities .....                                    | 276        |
| <b>11.</b> | <b>Semantic dimension and knowledge sharing.....</b>           | <b>287</b> |
| 11.1       | Semantic data .....  | 288        |
| 11.1.1     | Architectural entities and materials.....                      | 289        |
| 11.1.2     | Stratigraphic units and analysis.....                          | 292        |
| 11.1.3     | Historical interpretation.....                                 | 296        |
| 11.2       | Data querying .....  | 304        |

|   |            |
|---|------------|
| 11.2.1 Structured Query Language (SQL) .....            | 304        |
| 11.2.2 JavaScript Object Notation (JSON) .....          | 306        |
| 11.2.3 Querying the refectory: SQL and FreeCAD.....     | 307        |
| 11.2.4 Querying the refectory: JSON and BIMServer ..... | 334        |
| 11.2.5 BIM Vision analyses .....                        | 342        |
| 11.3 Knowledge sharing .....                            | 347        |
| <b>12. Results</b> .....                                | <b>357</b> |
| <b>Conclusions</b> .....                                | <b>365</b> |
| <b>References</b> .....                                 | <b>367</b> |
| <b>Web references</b> .....                             | <b>383</b> |
| <b>Hardware and software appendix</b> .....             | <b>385</b> |
| <b>Acknowledgments</b>                                  |            |



# List of figures

|  |     |
|--|-----|
| <b>Figure 1.</b> Main workflow designed and experimented for this project.....                                 | p.8 |
| <b>Figure 2.</b> Main processes throughout BIM applications .....  | 11  |
| <b>Figure 3.</b> Main processes and advantages throughout HBIM applications.....                               | 15  |
| <b>Figure 4.</b> Scan-to-BIM main operative steps: from LiDAR data to BIM.....                                 | 16  |
| <b>Figure 5.</b> Scan-to-openBIM via NURBS main operative steps .....  | 18  |
| <b>Figure 6.</b> Construction schema (square module) for the choir and transept .....                          | 23  |
| <b>Figure 7.</b> Staffarda Abbey view form APR .....   | 25  |
| <b>Figure 8.</b> Staffarda Abbey ground plan.....  | 25  |
| <b>Figure 9.</b> Staffarda church ground plan and inner view of the central aisle of the church .....          | 26  |
| <b>Figure 10.</b> Ground plans of Casanova church and Rivalta Scrivia church .....                             | 27  |
| <b>Figure 11.</b> Ground plans of San Teodoro and Santa Maria in Betlem churches in Pavia.....                 | 29  |
| <b>Figure 12.</b> Cloister detail of Staffarda Abbey view form APR.....  | 31  |
| <b>Figure 13.</b> Point of view of Staffarda Abbey from the cloister.....                                      | 32  |
| <b>Figure 14.</b> Detailed Staffarda Abbey ground plan .....   | 35  |
| <b>Figure 15.</b> South front of the cloister of Staffarda Abbey .....   | 36  |
| <b>Figure 16.</b> South front of the cloister of Staffarda Abbey, red area related to the refectory .....      | 36  |
| <b>Figure 17.</b> Ground plan of the Cistercian abbey of Fontenay.....   | 37  |
| <b>Figure 18.</b> APR image of the external south front of the refectory .....                                 | 38  |
| <b>Figure 19.</b> Protruding suspended arches on the external south front of the cloister .....                | 39  |
| <b>Figure 20.</b> Evidences of protruding arches on the backyard side of the refectory.....                    | 39  |
| <b>Figure 21.</b> Casanova abbey: protruding medieval arches .....   | 40  |
| <b>Figure 22.</b> Panoramic image from LiDAR acquisition of the inside of the refectory (1):.....              | 41  |
| <b>Figure 23.</b> Panoramic image from LiDAR acquisition of the inside of the refectory (2):.....              | 41  |
| <b>Figure 24.</b> Detail of north wall of the refectory with a suspended semi column.....                      | 42  |
| <b>Figure 25.</b> East wall of the refectory: detail of the <i>Ultima Cena</i> fresco .....                    | 43  |
| <b>Figure 26.</b> East wall of the refectory: detail of the earlier plaster.....                               | 44  |
| <b>Figure 27.</b> South wall of the refectory: detail of the removed pulpit.....                               | 45  |
| <b>Figure 28.</b> Fossanova refectory and its ceiling .....  | 47  |
| <b>Figure 29.</b> LiDAR point cloud of Staffarda refectory: detail of the extrados of the vaulted system.....  | 48  |
| <b>Figure 30.</b> LiDAR point cloud of Staffarda refectory: detail of the intrados of the vaulted system ..... | 48  |
| <b>Figure 31.</b> Staffarda refectory: drawing of Cesare Berteà .....  | 49  |

|   |    |
|---|----|
| <b>Figure 32.</b> From archaeological section to diagram.....   | 52 |
| <b>Figure 33.</b> Three kind of physical and graphical relations between two stratigraphic units.....         | 53 |
| <b>Figure 34.</b> Stratigraphic relations between walls .....   | 55 |
| <b>Figure 35.</b> Detection of stratigraphic units and their edges and interfaces .....                       | 56 |
| <b>Figure 36.</b> Not-directly equality typological relations (a) and functionality relations (b).....        | 57 |
| <b>Figure 37.</b> Stratigraphic analysis of the B Tower of Montarrenti - Siena.....                           | 59 |
| <b>Figure 38.</b> Graphic disassembly of construction phases of the B Tower of Montarrenti - Siena .....      | 60 |
| <b>Figure 39.</b> Axonometric reconstruction of the B Tower of Montarrenti - Siena .....                      | 61 |
| <b>Figure 40.</b> From reference units to USM .....   | 63 |
| <b>Figure 41.</b> Example of Stratigraphic Units Data Sheet.....  | 66 |
| <b>Figure 42.</b> Base equipment for a stratigraphic survey .....   | 67 |
| <b>Figure 43.</b> Example of edges drawing of stratigraphic analysis on 2D CAD.....                           | 68 |
| <b>Figure 44.</b> Stratigraphic sequence following the Harris method .....                                    | 70 |
| <b>Figure 45.</b> Archaeological section and its periods through the realization of matrix .....              | 71 |
| <b>Figure 46.</b> Laser Scanner Faro Focus 3D S120 .....  | 77 |
| <b>Figure 47.</b> Geomax Zoom 30 Pro total station hardware information (1) .....                             | 78 |
| <b>Figure 48.</b> Geomax Zoom 30 Pro total station hardware information (2) .....                             | 79 |
| <b>Figure 49.</b> Geomax Zoom 30 Pro total station hardware information (3) .....                             | 79 |
| <b>Figure 50.</b> Geomax Zoom 30 Pro technical information concerning angles measurements .....               | 80 |
| <b>Figure 51.</b> Geomax Zoom 30 Pro technical information concerning distances.....                          | 80 |
| <b>Figure 52.</b> Topographic network of Staffarda abbey – 2011 .....   | 82 |
| <b>Figure 53.</b> Topographic vertex on cloister – 2011 .....   | 83 |
| <b>Figure 54.</b> Topographic framework of the refectory (2018).....  | 83 |
| <b>Figure 55.</b> Natural points (red circle) registered on the cloister (1).....                             | 84 |
| <b>Figure 56.</b> Natural points (red circle) registered on the cloister (2).....                             | 84 |
| <b>Figure 57.</b> Natural points (red circle) registered on the cloister (3).....                             | 85 |
| <b>Figure 58.</b> Topographic survey: natural points placement, from 1 to 10, inside the cloister.....        | 85 |
| <b>Figure 59.</b> Topographic survey: targets from T1 to T10 on the south front of the cloister .....         | 86 |
| <b>Figure 60.</b> Topographic survey: targets placement, from 11 to 23, inside the refectory .....            | 86 |
| <b>Figure 61.</b> Topographic survey: lower target from 24 to 29, on the southern external front.....         | 87 |
| <b>Figure 62.</b> Topographic survey: natural upper points from 31 to 38, on the southern external front..... | 87 |
| <b>Figure 63.</b> Cartesian coordinates (X-Y-Z) of natural points registered on the cloister .....            | 88 |
| <b>Figure 64.</b> Cartesian coordinates, azimuth angle and distances of target and natural points.....        | 88 |
| <b>Figure 65.</b> Faro Focus 3D S120 survey detail on Scene software .....                                    | 90 |
| <b>Figure 66.</b> Image of north-east corner of the inner part of the refectory .....                         | 90 |
| <b>Figure 67.</b> LiDAR survey in 2017: laser scanner placement inside the refectory .....                    | 91 |
| <b>Figure 68.</b> LiDAR survey in 2017: laser scanner placement inside the refectory .....                    | 91 |

|   |     |
|---|-----|
| <b>Figure 69.</b> Laser scanner Faro Focus 3D S120 inside the refectory .....                                 | 92  |
| <b>Figure 70.</b> Panoramic image from laser scanner: Staffarda cloister .....                                | 94  |
| <b>Figure 71.</b> Panoramic image from laser scanner (2018 survey): inside the refectory .....                | 94  |
| <b>Figure 72.</b> Panoramic image from laser scanner (2017 survey): inside the refectory .....                | 94  |
| <b>Figure 73.</b> Panoramic image from laser scanner (2018 survey): inside the refectory .....                | 95  |
| <b>Figure 74.</b> Panoramic image from laser scanner (2018 survey): inside the dark chamber .....             | 95  |
| <b>Figure 75.</b> Panoramic image from laser scanner (2018 survey): south front of the refectory .....        | 95  |
| <b>Figure 76.</b> Point clouds generated by two scans on the cloister .....                                   | 98  |
| <b>Figure 77.</b> Raw point clouds of the refectory (in the middle) and its external front.....               | 100 |
| <b>Figure 78.</b> Point clouds of the refectory and its external front including radiometric information..... | 100 |
| <b>Figure 79.</b> Point clouds of the refectory referred to 2017 survey .....                                 | 101 |
| <b>Figure 80.</b> Merged and aligned point clouds of the refectory referred to 2017 and 2018 .....            | 101 |
| <b>Figure 81.</b> Calculation of target angle and distance error inside FARO Scene software .....             | 102 |
| <b>Figure 82.</b> Cleaned point clouds related to the ground, pillars and vaults .....                        | 104 |
| <b>Figure 83.</b> Cleaned point clouds related to the ground, pillars and vaults .....                        | 104 |
| <b>Figure 84.</b> Cleaned point clouds related to the whole refectory (perspective view).....                 | 105 |
| <b>Figure 85.</b> Cleaned point clouds related to the whole refectory (upper view).....                       | 105 |
| <b>Figure 86.</b> Point cloud of the refectory and its properties and coordinates .....                       | 106 |
| <b>Figure 87.</b> Meshing two phases options inside 3D Reshaper .....   | 107 |
| <b>Figure 88.</b> Polygonal mesh related to the whole refectory (perspective view).....                       | 108 |
| <b>Figure 89.</b> Polygonal mesh related to the whole refectory (upper view).....                             | 108 |
| <b>Figure 90.</b> Detail of the polygonal mesh related to the refectory (south and east walls).....           | 109 |
| <b>Figure 91.</b> Detail of the polygonal mesh related to the refectory (north and east walls).....           | 109 |
| <b>Figure 92.</b> Detail of the polygonal mesh related to the pillars and vaulted ceiling (intrados).....     | 110 |
| <b>Figure 93.</b> Radiometric values applied to the polygonal mesh .....                                      | 110 |
| <b>Figure 94.</b> Planar sections options and preview related to the pillars .....                            | 111 |
| <b>Figure 95.</b> Polygonal mesh of the vaults.....   | 112 |
| <b>Figure 96.</b> Planar sections extracted from the vaults .....   | 112 |
| <b>Figure 97.</b> Polygonal mesh and planar sections preview of pillars.....                                  | 113 |
| <b>Figure 98.</b> Planar section (X plane) extracted from pillars .....                                       | 113 |
| <b>Figure 99.</b> Detail of planar sections related to vaults and pillars .....                               | 114 |
| <b>Figure 100.</b> Planar sections (X-Y-Z planes) related to ground, pillars and north and east walls .....   | 114 |
| <b>Figure 101.</b> Polygonal mesh of the clay ground .....  | 115 |
| <b>Figure 102.</b> Best fit plane extracted from the ground .....   | 115 |
| <b>Figure 103.</b> South front of the cloister and the stratigraphic analysis.....                            | 119 |
| <b>Figure 104.</b> North wall of the refectory and the stratigraphic analysis.....                            | 120 |
| <b>Figure 105.</b> East wall of the refectory and the stratigraphic analysis .....                            | 121 |

|  |     |
|--|-----|
| <b>Figure 106.</b> South wall of the refectory and the stratigraphic analysis.....                             | 122 |
| <b>Figure 107.</b> West wall of the refectory and the stratigraphic analysis.....                              | 123 |
| <b>Figure 108.</b> Vaults identification numbers (NURBS model).....  | 125 |
| <b>Figure 109.</b> Pillars identification numbers (NURBS model).....   | 125 |
| <b>Figure 110.</b> The considered area for the HBIM platform .....   | 126 |
| <b>Figure 111.</b> Matrix connection layout.....   | 144 |
| <b>Figure 112.</b> Example of square bridge and way of reading .....   | 144 |
| <b>Figure 113.</b> Matrix related to the south front of the cloister .....                                     | 148 |
| <b>Figure 114.</b> Matrix related to the north wall of the refectory .....                                     | 149 |
| <b>Figure 115.</b> Matrix related to the east wall of the refectory.....                                       | 150 |
| <b>Figure 116.</b> Matrix related to the south wall of the refectory .....                                     | 151 |
| <b>Figure 117.</b> Matrix related to the west wall of the refectory.....                                       | 152 |
| <b>Figure 118.</b> Matrix related to pillars and vaults .....  | 153 |
| <b>Figure 119.</b> Matrix and phases related to the south front of the cloister.....                           | 159 |
| <b>Figure 120.</b> Matrix and phases related to the north wall of the refectory .....                          | 160 |
| <b>Figure 121.</b> Matrix and phases related to the east wall of the refectory .....                           | 161 |
| <b>Figure 122.</b> Matrix and phases related to the south wall of the refectory.....                           | 162 |
| <b>Figure 123.</b> Matrix and phases related to the west wall of the refectory .....                           | 163 |
| <b>Figure 124.</b> Matrix and phase related to the pillars and vaults .....                                    | 164 |
| <b>Figure 125.</b> Chronological periods related to the south front of the cloister .....                      | 168 |
| <b>Figure 126.</b> Chronological periods related to the north wall of the refectory.....                       | 170 |
| <b>Figure 127.</b> Chronological periods related to the east wall of the refectory .....                       | 172 |
| <b>Figure 128.</b> Chronological periods related to the south wall of the refectory .....                      | 175 |
| <b>Figure 129.</b> Chronological periods related to the west wall of the refectory.....                        | 176 |
| <b>Figure 130.</b> Chronological periods related to the pillars and vaults of the refectory.....               | 177 |
| <b>Figure 131.</b> Chronological periods and units of the south front of the cloister (see also TAV.4).....    | 178 |
| <b>Figure 132.</b> Chronological periods and units of the north wall of the refectory (see also TAV.8) .....   | 179 |
| <b>Figure 133.</b> Chronological periods and units of the east wall of the refectory (see also TAV.12).....    | 180 |
| <b>Figure 134.</b> Chronological periods and units of the south wall of the refectory (see also TAV.16) ....   | 181 |
| <b>Figure 135.</b> Chronological periods and units of the west wall of the refectory (see also TAV.20) .....   | 182 |
| <b>Figure 136.</b> Suspended arches on the transept of the church .....  | 183 |
| <b>Figure 137.</b> Suspended arches on the south front of the cloister .....                                   | 183 |
| <b>Figure 138.</b> Suspended crossed arches on the south front of the cloister .....                           | 184 |
| <b>Figure 139.</b> Detail of plaster and brick masonry with thin mortar joint .....                            | 184 |
| <b>Figure 140.</b> Detail of the removed pulpit on the south internal wall of the refectory.....               | 185 |
| <b>Figure 141.</b> South wall of the refectory .....   | 185 |
| <b>Figure 142.</b> Detail of the semi-column related to the old ceiling on the north wall of the refectory.... | 186 |

|   |     |
|---|-----|
| <b>Figure 143.</b> Detail of the stone shelves related to the old ceiling on the south wall of the refectory..... | 186 |
| <b>Figure 144.</b> West wall of the refectory and detail on the walled pillar and the new vaulted system....      | 187 |
| <b>Figure 145.</b> Detail of the walled pillar of the west wall.....  | 187 |
| <b>Figure 146.</b> Buttresses marks on the south front of the cloister.....                                       | 190 |
| <b>Figure 147.</b> Entire buttresses on the backyard of the refectory .....                                       | 191 |
| <b>Figure 148.</b> Staffarda refectory: drawing of Cesare Bertea .....  | 191 |
| <b>Figure 149.</b> Differences between an approximated segmented line and a NURBS curve.....                      | 195 |
| <b>Figure 150.</b> Rhinoceros interface .....   | 197 |
| <b>Figure 151.</b> Modelling options concerning LOFT and PATCH command .....                                      | 198 |
| <b>Figure 152.</b> Three different 3D visualization of Rhinoceros .....   | 199 |
| <b>Figure 153.</b> Planar sections (X plane) related to pillars .....   | 201 |
| <b>Figure 154.</b> Geometries interpretation .....  | 201 |
| <b>Figure 155.</b> Simplified creation via extrusion of the pillar's shape .....                                  | 202 |
| <b>Figure 156.</b> Detection of the semi-column geometry and simplified creation via extrusion.....               | 202 |
| <b>Figure 157.</b> Interpretation of wooden centring of a vault .....   | 203 |
| <b>Figure 158.</b> NURBS model of the vault.....  | 203 |
| <b>Figure 159.</b> NURBS models of the refectory (1).....   | 205 |
| <b>Figure 160.</b> NURBS models of the refectory (2):.....  | 207 |
| <b>Figure 161.</b> NURBS models of the refectory (3):.....  | 209 |
| <b>Figure 162.</b> Rendering view of NURBS modelling of buttresses on the backyard side.....                      | 211 |
| <b>Figure 163.</b> Rendered NURBS model related to groined vaults and related arches .....                        | 211 |
| <b>Figure 164.</b> Detail on macro NURBS models created: the ground and the five pillars.....                     | 212 |
| <b>Figure 165.</b> Detail on macro NURBS models created: arches related to the ceiling .....                      | 213 |
| <b>Figure 166.</b> Detail on macro NURBS models created: groined vaults .....                                     | 213 |
| <b>Figure 167.</b> Rendered NURBS model of the refectory (perspective view) .....                                 | 214 |
| <b>Figure 168.</b> Rendered NURBS model of the refectory (upper view) .....                                       | 214 |
| <b>Figure 169.</b> Exploded NURBS model of the refectory (cloister side) .....                                    | 215 |
| <b>Figure 170.</b> Exploded NURBS model of the refectory (backyard side).....                                     | 215 |
| <b>Figure 171.</b> Schematic classification of Grades of Generation.....  | 217 |
| <b>Figure 172.</b> Polygonal mesh creation starting from NURBS model of the vaults.....                           | 219 |
| <b>Figure 173.</b> Polygonal mesh inside CloudCompare software.....   | 220 |
| <b>Figure 174.</b> Sparse LiDAR point clouds of the vaults inside CloudCompare .....                              | 220 |
| <b>Figure 175.</b> Polygonal mesh and LiDAR point clouds overlapped in order to compare distances .....           | 221 |
| <b>Figure 176.</b> Distances (the higher and the smaller) between the model and the point cloud .....             | 221 |
| <b>Figure 177.</b> Graphic of standard deviation computed between point clouds and the model .....                | 222 |
| <b>Figure 178.</b> Cropped orthophoto referred to the refectory area mapped on the model.....                     | 223 |
| <b>Figure 179.</b> Detail of external and internal orthophoto mapped on the model .....                           | 223 |



|  |     |
|--|-----|
| <b>Figure 180.</b> Drawing and modelling steps starting from the mapped orthophoto .....                         | 224 |
| <b>Figure 181.</b> Detail of subdivisions on unit surface modelled using PATCH tool .....                        | 225 |
| <b>Figure 182.</b> Mapped orthophotos related to the south and west fronts of the refectory .....                | 226 |
| <b>Figure 183.</b> Modelled stratigraphic units related to the south and west fronts of the refectory .....      | 226 |
| <b>Figure 184.</b> Mapped orthophotos related to the north and east fronts of the refectory.....                 | 227 |
| <b>Figure 185.</b> Modelled stratigraphic units related to the north and east fronts of the refectory.....       | 227 |
| <b>Figure 186.</b> Complete NURBS model of the refectory including stratigraphic units - 1 .....                 | 228 |
| <b>Figure 187.</b> Complete NURBS model of the refectory including stratigraphic units - 2 .....                 | 228 |
| <b>Figure 188.</b> Texturized NURBS model of the refectory. South front of the cloister.....                     | 229 |
| <b>Figure 189.</b> Texturized NURBS model of the refectory including stratigraphic units (cloister side)..       | 230 |
| <b>Figure 190.</b> Texturized NURBS model of the refectory including stratigraphic units (backyard side)         | 230 |
| <b>Figure 191.</b> Texturized NURBS model of the refectory. Pillars and arches (cloister side).....              | 231 |
| <b>Figure 192.</b> Texturized NURBS model of the refectory. Pillars and arches (backyard side).....              | 231 |
| <b>Figure 193.</b> Texturized NURBS model of the refectory. South wall (isometric view) .....                    | 232 |
| <b>Figure 194.</b> Texturized NURBS model of the refectory. North wall (isometric view) .....                    | 232 |
| <b>Figure 195.</b> Texturized NURBS model of the refectory. East wall and arches (isometric view).....           | 233 |
| <b>Figure 196.</b> Texturized NURBS model of the refectory. East wall and <i>Ultima Cena</i> fresco detail ..... | 233 |
| <b>Figure 197.</b> Texturized NURBS model of the vaulted system of the refectory.....                            | 234 |
| <b>Figure 198.</b> Texturized NURBS models of architectural elements .....                                       | 234 |
| <b>Figure 199.</b> Buttresses evidences on the south front of the cloister related to the refectory area.....    | 236 |
| <b>Figure 200.</b> Buttresses reconstruction on the south front of the cloister – NURBS model .....              | 236 |
| <b>Figure 201.</b> Buttresses, semi-columns and shelves supporting elements .....                                | 237 |
| <b>Figure 202.</b> In the foreground buttresses of the backyard and original ceiling supporting element.....     | 237 |
| <b>Figure 203.</b> Hypothetical reconstruction of the refectory from 1180 to 1690 (render model) .....           | 239 |
| <b>Figure 204.</b> Hypothetical reconstruction of the refectory from 1180 to 1690 (texturized model) .....       | 240 |
| <b>Figure 205.</b> Original ceiling hypothesis details (render NURBS model) .....                                | 241 |
| <b>Figure 206.</b> Hypothetical interior reconstruction of the refectory, arches and pulpit detail.....          | 242 |
| <b>Figure 207.</b> Hypothetical interior reconstruction of the refectory, with windows and the pulpit.....       | 242 |
| <b>Figure 208.</b> Chronological interpretation and changes of the refectory (cloister side).....                | 243 |
| <b>Figure 209.</b> Chronological interpretation and changes of the refectory (backyard side).....                | 244 |
| <b>Figure 210.</b> FreeCAD homepage and direct download link .....   | 248 |
| <b>Figure 211.</b> Quick access to big community on FreeCAD homepage to get involved.....                        | 248 |
| <b>Figure 212.</b> FreeCAD general overview.....   | 249 |
| <b>Figure 213.</b> ARCH workbench and DRAFT command tools.....   | 250 |
| <b>Figure 214.</b> PART workbench command tools.....   | 251 |
| <b>Figure 215.</b> FreeCAD 0.18 downloadable versions .....  | 251 |
| <b>Figure 216.</b> PIP installation on MacOS terminal .....  | 253 |

|  |     |
|--|-----|
| <b>Figure 217.</b> FreeCAD source code download on Windows .....                                       | 254 |
| <b>Figure 218.</b> FreeCAD addon manager .....   | 257 |
| <b>Figure 219.</b> FreeCAD default material database and material editor .....                         | 259 |
| <b>Figure 220.</b> FreeCAD IFC Role on left data menu .....  | 261 |
| <b>Figure 221.</b> FreeCAD extrude command tool and its parameters .....                               | 265 |
| <b>Figure 222.</b> Extruding operation (on Z positive plane) concerning vaults .....                   | 266 |
| <b>Figure 223.</b> Extruding operation concerning a stratigraphic plaster unit .....                   | 267 |
| <b>Figure 224.</b> Dynamic Data property type drop-down menu .....                                     | 267 |
| <b>Figure 225.</b> Dynamic Data options and tools .....  | 268 |
| <b>Figure 226.</b> FreeCAD predefined IFC2X3 schema containing the 161 IFC standard roles .....        | 270 |
| <b>Figure 227.</b> FreeCAD predefined IFC2X3 schema implemented with other definitions .....           | 272 |
| <b>Figure 228.</b> FreeCAD drop-down menu concerning IFC roles after the modifying process .....       | 272 |
| <b>Figure 229.</b> FreeCAD left data menu component .....  | 273 |
| <b>Figure 230.</b> FreeCAD custom list referred to materials .....                                     | 274 |
| <b>Figure 231.</b> FreeCAD left data menu component: in red the material classification .....          | 275 |
| <b>Figure 232.</b> FreeCAD left data menu component: in red the Standard Code description .....        | 275 |
| <b>Figure 233.</b> FreeCAD left data menu component: in red the tag description .....                  | 277 |
| <b>Figure 234.</b> Dependencies graphic concerning IFC entities creation from STEP objects .....       | 278 |
| <b>Figure 235.</b> IFC entities creation and properties starting from STEP objects .....               | 278 |
| <b>Figure 236.</b> Overview on final BIM model of the refectory (cloister side) .....                  | 279 |
| <b>Figure 237.</b> Refectory (cloister side): complex architectural elements - vaults system .....     | 279 |
| <b>Figure 238.</b> Refectory (cloister side): structural elements - pillars .....                      | 280 |
| <b>Figure 239.</b> Refectory (cloister side): stratigraphic units selection .....                      | 280 |
| <b>Figure 240.</b> Overview on final BIM model of the refectory (backyard side) .....                  | 281 |
| <b>Figure 241.</b> Refectory (backyard side): windows selection .....                                  | 281 |
| <b>Figure 242.</b> Refectory (backyard side): buttresses selection .....                               | 282 |
| <b>Figure 243.</b> Refectory (backyard side): reinforcing anchors selection .....                      | 282 |
| <b>Figure 244.</b> Overview on USR 45 fresco unit and data menu on the left .....                      | 283 |
| <b>Figure 245.</b> Overview on EA 54 pillar and its properties on data menu on the left .....          | 283 |
| <b>Figure 246.</b> Detail on a stratigraphic masonry unit and its properties on SimpleProperties ..... | 284 |
| <b>Figure 247.</b> Fresco units and its properties on SimpleProperties Macro .....                     | 284 |
| <b>Figure 248.</b> Overview on render / plaster unit and its properties on FCInfo Macro .....          | 285 |
| <b>Figure 249.</b> Portal height calculated by the measurement tool of FreeCAD .....                   | 285 |
| <b>Figure 250.</b> IFC object properties and parameters inside FreeCAD HBIM platform .....             | 289 |
| <b>Figure 251.</b> IFC Stratigraphic units database inside FreeCAD .....                               | 293 |
| <b>Figure 252.</b> Iconographic sources of the refectory inside FreeCAD platform .....                 | 294 |

|   |     |
|---|-----|
| <b>Figure 253.</b> Image attribution to specific element: semi-column .....                         | 295 |
| <b>Figure 254.</b> Semi-column and its reference image attached to the object .....                 | 295 |
| <b>Figure 255.</b> Bibliographic resources inside the FreeCAD database.....                         | 296 |
| <b>Figure 256.</b> Matrix of east wall inside the FreeCAD archive .....                             | 297 |
| <b>Figure 257.</b> Matrix and phases of east wall inside the FreeCAD archive.....                   | 297 |
| <b>Figure 258.</b> Matrix and chronological periods of east wall inside the FreeCAD archive .....   | 298 |
| <b>Figure 259.</b> Specific Tag attribution through the dynamic data tool: period 2 to USM 145..... | 299 |
| <b>Figure 260.</b> Chronological period into Tag text field: period 5 for groin vaults.....         | 299 |
| <b>Figure 261.</b> Details of chronological periods and units of the refectory (HBIM model) .....   | 301 |
| <b>Figure 262.</b> Details of chronological periods and units of the refectory (HBIM model) .....   | 302 |
| <b>Figure 263.</b> Information concerning the refectory inside the FreeCAD HBIM platform .....      | 303 |
| <b>Figure 264.</b> PIP installation through Windows PowerShell terminal .....                       | 307 |
| <b>Figure 265.</b> Reporting workbench on addon manager .....                                       | 308 |
| <b>Figure 266.</b> Customized IFC role inside the drop-down menu of FreeCAD.....                    | 310 |
| <b>Figure 267.</b> IFC Wall entities query, input and output (in green text).....                   | 311 |
| <b>Figure 268.</b> LABEL and TAG of wall entities query, input and output .....                     | 312 |
| <b>Figure 269.</b> Plaster material query, input and output.....                                    | 313 |
| <b>Figure 270.</b> LABEL and MATERIAL of column entities query, input and output.....               | 314 |
| <b>Figure 271.</b> LABEL and MATERIAL of opening entities query, input and output .....             | 315 |
| <b>Figure 272.</b> Period 2 query, input and output.....  | 316 |
| <b>Figure 273.</b> Standard code query, input and output.....                                       | 317 |
| <b>Figure 274.</b> All objects count query, input and output.....                                   | 318 |
| <b>Figure 275.</b> Groin vault customized query, input and output .....                             | 319 |
| <b>Figure 276.</b> USM customized query, input and output .....                                     | 320 |
| <b>Figure 277.</b> USR customized query, input and output .....                                     | 321 |
| <b>Figure 278.</b> Buttresses customized query, input and output .....                              | 322 |
| <b>Figure 279.</b> Arches customized query, input and output.....                                   | 323 |
| <b>Figure 280.</b> Pillars customized query, input and.....   | 324 |
| <b>Figure 281.</b> Reporting query: statement configuration (select from wall entities) .....       | 325 |
| <b>Figure 282.</b> Reporting query: select label and description from wall entities .....           | 325 |
| <b>Figure 283.</b> Reporting query: statement configuration.....                                    | 326 |
| <b>Figure 284.</b> Reporting query: select label and description from opening entities.....         | 326 |
| <b>Figure 285.</b> Reporting query: statement configuration (select from USM entities).....         | 327 |
| <b>Figure 286.</b> Reporting query: select label and description from USM entities .....            | 327 |
| <b>Figure 287.</b> Reporting query: statement configuration (select from USR entities) .....        | 328 |
| <b>Figure 288.</b> Reporting query: select label and description from USR entities .....            | 328 |

|   |     |
|---|-----|
| <b>Figure 289.</b> Reporting query: statement configuration (select from plaster entities) .....    | 329 |
| <b>Figure 290.</b> Reporting query: select label and description from plaster entities .....        | 329 |
| <b>Figure 291.</b> Reporting query: statement configuration (select from stone entities).....       | 330 |
| <b>Figure 292.</b> Reporting query: select label and description from stone entities .....          | 330 |
| <b>Figure 293.</b> Reporting query: select objects of Period 2 .....                                | 331 |
| <b>Figure 294.</b> Reporting query: select objects of Period 4 .....                                | 331 |
| <b>Figure 295.</b> Reporting query: select objects of Period 5 .....                                | 332 |
| <b>Figure 296.</b> Reporting query: select objects of Period 6 .....                                | 332 |
| <b>Figure 297.</b> Reporting query: select objects of Period 7 .....                                | 333 |
| <b>Figure 298.</b> Exported data from IFC wall query to Google document .....                       | 333 |
| <b>Figure 299.</b> Model check-in inside the BIMServer platform.....                                | 334 |
| <b>Figure 300.</b> Render Engines inside BIMServer .....  | 335 |
| <b>Figure 301.</b> Wall entities query inside BIMServer .....                                       | 336 |
| <b>Figure 302.</b> Roof entities query inside BIMServer.....  | 337 |
| <b>Figure 303.</b> Building storey entities query inside BIMServer .....                            | 338 |
| <b>Figure 304.</b> Query based on selection of wall, door, window, building elements .....          | 339 |
| <b>Figure 305.</b> Query based on selection of building storey, column, roof.....                   | 340 |
| <b>Figure 306.</b> Query based on selection of window and door type inside BIMServer .....          | 341 |
| <b>Figure 307.</b> Main claimed benefits of BIM Vision.....   | 342 |
| <b>Figure 308.</b> Main interface of BIM Vision.....  | 343 |
| <b>Figure 309.</b> Windows analysis of the refectory and their properties below .....               | 343 |
| <b>Figure 310.</b> Section of the refectory with BIM Vision: Z plane at 1.50m of height.....        | 344 |
| <b>Figure 311.</b> Section of the refectory with BIM Vision: X plane section .....                  | 344 |
| <b>Figure 312.</b> Section of the refectory with BIM Vision: Y plane section .....                  | 345 |
| <b>Figure 313.</b> Section on Z plane and area analysis of the refectory with BIM Vision.....       | 345 |
| <b>Figure 314.</b> Distances analysis of the refectory with BIM Vision .....                        | 346 |
| <b>Figure 315.</b> Areas analysis of the refectory with BIM Vision.....                             | 346 |
| <b>Figure 316.</b> IFC file reading inside IFC File Analyzer .....                                  | 348 |
| <b>Figure 317.</b> Datasheet generation options inside IFC File Analyzer.....                       | 348 |
| <b>Figure 318.</b> XLSX datasheet generation option inside IFC File Analyzer .....                  | 349 |
| <b>Figure 319.</b> Generated CSV from IFC file with IFC File Analyzer.....                          | 349 |
| <b>Figure 320.</b> “BuildingElementProxy” entity detection inside an IFC file by using XCode.....   | 350 |
| <b>Figure 321.</b> “BuildingElementProxy” entity replacement with “Element” by using XCode.....     | 350 |
| <b>Figure 322.</b> Staffarda refectory simplified and conceptual NURBS model inside Sketchfab ..... | 352 |
| <b>Figure 323.</b> Staffarda refectory annotative point concerning the vaulted system .....         | 352 |
| <b>Figure 324.</b> Staffarda refectory annotative point concerning pillars .....                    | 353 |

|   |     |
|---|-----|
| <b>Figure 325.</b> Staffarda refectory simplified NURBS proposal model inside Sketchfab .....     | 353 |
| <b>Figure 326.</b> Staffarda refectory proposal model: annotation point for buttresses .....      | 354 |
| <b>Figure 327.</b> Staffarda refectory proposal model: annotation point for the pulpit.....       | 354 |
| <b>Figure 328.</b> Staffarda refectory proposal model: annotation point for diaphragm arches..... | 355 |
| <b>Figure 329.</b> Staffarda refectory proposal model: VR settings inside Sketchfab .....         | 355 |
| <b>Figure 330.</b> Staffarda refectory model on Sketchfab iPad platform.....                      | 356 |
| <b>Figure 331.</b> QR code link to Sketchfab models .....   | 356 |
| <b>Figure 332.</b> From point clouds to HBIM model via NURBS .....                                | 363 |
| <b>Figure 333.</b> Refectory HBIM model main features .....                                       | 364 |

# List of tables

|  |      |
|--|------|
| <b>Table 1.</b> Acronyms and definitions of reference units .....  | p.64 |
| <b>Table 2.</b> Topographic survey: natural points and their position.....                                   | 81   |
| <b>Table 3.</b> Topographic survey: targets and their position.....  | 82   |
| <b>Table 4.</b> Name and identification of 2017 and 2018 scans inside Scene software .....                   | 93   |
| <b>Table 5.</b> Identification name and position of 2017 and 2018 scans inside Scene software .....          | 99   |
| <b>Table 6.</b> Target angle and distance error concerning the refectory scans .....                         | 102  |
| <b>Table 7.</b> Vaults and pillars classification .....  | 124  |
| <b>Table 8.</b> South front of the cloister stratigraphic units and description .....                        | 129  |
| <b>Table 9.</b> Stratigraphic units and description related to the north wall of the refectory .....         | 135  |
| <b>Table 10.</b> Stratigraphic units and description related to the east wall of the refectory .....         | 137  |
| <b>Table 11.</b> Stratigraphic units and description related to the south wall of the refectory.....         | 139  |
| <b>Table 12.</b> Stratigraphic units and description related to the west wall of the refectory .....         | 140  |
| <b>Table 13.</b> Chronological periods detected as regard the refectory.....                                 | 165  |
| <b>Table 14.</b> Chronological periods detected on the external front of the refectory.....                  | 167  |
| <b>Table 15.</b> Chronological periods detected on the north wall of the refectory .....                     | 169  |
| <b>Table 16.</b> Chronological periods detected as regard the east wall of the refectory.....                | 171  |
| <b>Table 17.</b> Chronological periods detected on the south wall of the refectory.....                      | 174  |
| <b>Table 18.</b> Chronological period detected on the west wall of the refectory.....                        | 174  |
| <b>Table 19.</b> IFC ROLE classification referred to the first attribution (ISO normative and standards).... | 269  |
| <b>Table 20.</b> IFC ROLE classification referred to the second custom attribution .....                     | 271  |
| <b>Table 21.</b> FreeCAD data menu and the compilation strategy .....  | 277  |
| <b>Table 22.</b> IFC ROLE classification referred to the first attribution (ISO normative and standards).... | 290  |
| <b>Table 23.</b> IFC ROLE classification referred to the second custom attribution .....                     | 290  |
| <b>Table 24.</b> Stratigraphic units and analysis on FreeCAD and the integration methodology .....           | 300  |



# Attachments list

## **South front of the cloister**

TAV.1: Orthophoto

TAV.2: Stratigraphic units

TAV.3: Material analysis

TAV.4: Chronological periods

## **North wall of the refectory**

TAV.5: Orthophoto

TAV.6: Stratigraphic units

TAV.7: Material analysis

TAV.8: Chronological periods

## **East wall of the refectory**

TAV.9: Orthophoto

TAV.10: Stratigraphic units

TAV.11: Material analysis

TAV.12: Chronological periods

## **South wall of the refectory**

TAV.13: Orthophoto

TAV.14: Stratigraphic units

TAV.15: Material analysis

TAV.16: Chronological periods

## **West wall of the refectory**

TAV.17: Orthophoto

TAV.18: Stratigraphic units

TAV.19: Material analysis

TAV.20: Chronological periods





# Abbreviations and acronyms

**AEC:** Architecture, Engineering and Construction

**AR:** Augmented Reality

**BIM:** Building Information Modelling

**CA:** Architectural Complex\*

**CAD:** Computer Aided Drafting

**CF:** *Corpo di fabbrica* (Block of the Building) \*

**CIPA:** International Committee of Architectural Photogrammetry

**DB:** Database

**DBMS:** Database Management System

**EA:** Architectural Element

**GAMHER:** Geomatics data Acquisition and Management for Heritage

**GIS:** Geographic Information System

**GOA:** Grade of Accuracy

**GOG:** Grade of Generation

**GUI:** Graphic user interface

**HBIM:** Historic Building Information Modelling

**ICOMOS:** The International Council on Monuments and Sites

**IDE:** Integrated Development Environment

**IFC:** Industry Foundation Classes

**JSON:** JavaScript Object Notation

**LIDAR:** Light Detection and Raging

**LOA:** Level of Accuracy

**LOD:** Level of Detail or Development

**NURBS:** Non Uniform Rational Basis-Splines

**PCRE:** Perl Compatible Regular Expression

**PG:** *Prospetto generale* (General Elevation) \*

**PP:** *Prospetto Particolare* (Particular Elevation) \*

**RDBMS:** Relational Database Management System

**SO:** *Struttura orizzontale* (Horizontal structure) \*

**SQL:** Structured Query Language

**UE:** *Unità Edilizia* (Building Unit) \*

**UF:** Functional Unit\*

**UN:** *Unità Nascosta* (Hidden Unit) \*

**US:** Stratigraphic Unit\*

**USM:** Masonry Stratigraphic Unit\*

**USR:** Render Stratigraphic Unit\*

**UST:** Territory stratigraphic unit\*

**VR:** Virtual Reality

\* Original acronym is in Italian language

# Chapter 1

## Introduction and objectives

The increasing growth and development of technologies, concerning both hardware and software, is pushing the Cultural Heritage research ever forward on its methods. In this sense, in the Geomatics field – the discipline which is involved in the surveying of territory through different techniques, such as Computer Science, Topography, Cartography, Geodesy, Photogrammetry, Laser scanning systems, GPS Systems (Global Positioning Systems), Remote sensing, GIS analysis (Geographic information systems) – actual and future technologies are changing and will ever change the Cultural Heritage analysis, conservation and enhancement ways, allowing new innovative documentation and analysis methods from archaeology to historical buildings (Rinaudo F., 2011b; Lo Turco et a., 2017b).

All the mentioned Geomatics techniques become a fundamental step of knowledge and analysis for Cultural Heritage assets. For example, metric survey, that could be carried out by a photogrammetric approach or by using LiDAR techniques (Light Detection and Ranging), is nowadays a mandatory step as far as the existing Heritage assets are concerned, especially because it allows to collect and register metric, volumetric and radiometric information in order to represent (in a three-dimensional way), analyse, communicate and preserve the surveyed object or building. But, first of all metric survey and, as well as all the Geomatics techniques, produce **documentation**, documentation concerning archaeological remains, historical buildings, small art objects, small cities and villages, historical landscapes and so on. Nowadays documenting is everything, because documentation assumes, in addition to being a fashionable social value, memory importance through the years. However, a spree accumulation of data can bring researches towards an information bulimia: we produce a lot of data and archive everything but we could have potentially nothing due to the digital data and storage methods instability, and for this reason every day we have to do important choices about our scientific and sensitive data (Diara F., 2020). So, the point is always minding the goal of the research, avoiding the utilization of specific innovative

technologies just for fashion and thinking responsible depending on economic resources we spend, time spent for the research analysis, data we produce (often redundant data). As far as the Cultural heritage documentation is concerned, how can be important the digital documentation of the Notre Dame Cathedral in the present days? What is the value of its metric data acquisition after the ceiling fire? In this way, documentation can and should become a sort of three-dimensional digital back-up of a missing, damaged or destroyed Heritage asset and the metric survey should be the essential step of documentation and knowledge.

So, **knowledge** is fundamental. Restorative and conservative operations planned for the purpose of preserving and managing Cultural Heritage assets and historical buildings involve the historical and critic knowledge of a specific context (Balletti et al., 2019; Beltramo et al., 2019a). Moreover, meaning the knowledge is intended as the objective geometrical comprehension and diachronic consciousness of the history of a specific context should help management and safeguard processes of Heritage assets. In this sense, regarding the Cultural Heritage field, the **information** role has to be considered as the basement for present and future analyses (Balletti et al., 2019).

Talking about the importance of the information dimension, as far as the Cultural Heritage assets documentation and management are concerned, **Building Information Modelling** (BIM) improves the possibilities of a traditional two-dimensional CAD ability, allowing to increase the information dimension inside models by establishing geometric and semantic relations between 3D objects and ad-hoc information (Van Leeuwen et al., 1996; Garba et al., 2004; Tse et al., 2005). Moreover, this methodology generates a collaborative approach between different professional figures and then allows multidisciplinary research processes, and this is one of the advantages of BIM approach. In particular, BIM and HBIM (Historic Building Information Modelling), that will be introduced deeper in the next chapter, allows to combine metric and geometric data, obtained from different methodologies, with information concerning other kinds of semantic information. In this sense, BIM models are not only volumetric representations of buildings but real 3D database on an architectural scale able to collect and produce information as well as able to preserve information on the buildings itself for further analyses and monitoring processes (Oreni et al., 2017).

Despite BIM has become a standard and a mandatory solution as far as the architectural design, industry and engineering projects are concerned, this kind of approach is recently combined with existing buildings especially historical ones (Murphy et al., 2009). However, this solution is not widely adopted as regards Cultural Heritage assets and it could be considered still an ongoing research field,

due to the problems resulting from the use of commercial BIM solutions, mainly designed and conceived to support building design or industry management and rarely important and essential software like Autodesk Revit or Graphisoft Archicad could adapt their workflows and methods to Heritage assets, for different reasons, such as modelling tools and the integration of information (Murphy et al., 2013; Barazzetti L., 2016; Diara et al., 2018).

As far as the modelling techniques are concerned, actual commercial BIM software such as Autodesk Revit or Graphisoft Archicad allow limited 3D modelling possibilities, based principally on predefined parametric architectural families (theoretical architectural elements) or very simplified models. Then, the realization of complex and high detailed models concerning Cultural Heritage assets directly on BIM software is, as experienced by other researchers, a critical point to solve (Murphy et al., 2013; Barazzetti L., 2016; Banfi F., 2017; Adami et al., 2017; Diara et al., 2019). For these reasons, BIM of existing facilities and buildings called also *as-built* BIM, is still a challenge especially for the complexity of geometric and not geometric data and its interpretation inside the principal BIM platforms, Heritage assets features not included on the main BIM thought, workflow, modelling processes and computations (Barazzetti L., 2016).

Another important point is the **integration of information** concerning Cultural Heritage assets inside an HBIM platform. Indeed, information that could be included into a BIM and HBIM platform can be several, from structural analyses to acoustic and comfort analyses, from mechanical to thermal information (Macher et al., 2019). In this regard, the integration of historical information inside an HBIM platform involves huge advantages concerning the management and monitoring operations processes for example of a historical building, and furthermore, the historical data and evolution is correctly considered (Beltramo et al., 2019a).

The wall **stratigraphy**, and then stratigraphic units (as we will see on *Stratification and stratigraphy* chapter, related to information that we can find directly on buildings surfaces), has great importance as far as historical buildings comprehension and interpretation. Stratification is itself a knowledge process because includes information that could not be found in any archives but directly on the field. Like in archaeological contexts do not exist artefacts and findings more important than others, as regards the data searching should not exist historical information more significant than others, and stratigraphy should have the same relevance of other sources, even if it concerns different kinds of information. This kind of historical information would be an innovative feature to be included and managed inside a HBIM project, especially because every stratigraphic unit, as well as pathologies or wall paintings, and then historical phase related to them could be

digitally connected to parametric models, thus collecting in a single environment different kinds of information and increasing the amount of knowledge concerning the evolution of the building (Reina Ortiz et al., 2019; Beltramo et al., 2019a).

The application of stratigraphic analysis, and then the identification of all interventions happened on a historical building, on a HBIM platform makes a great contribution for risk and vulnerability comprehension, because constructive and destructive actions would be connected as architectural components to parametric model: in this sense, could be relevant to think about masonries units and render / plaster units as building entities because in architectural terms these kinds of information regard masonry, cuts for openings, render/plaster layers, decoration and other features. For this reason, BIM methodologies can **improve the traditional historians and buildings archaeology studies** (often studies disconnected from the architectural context), allowing to work in a collaborative environment able to collect and produce information. However, the integration of this kind of data is referred to surfaces not designed for a direct connection with BIM environment, and for this reason without a specific architectural or structural classification could be defined as a difficult task as well as an ongoing research field (Chiabrando et al, 2017; Lo Turco et al., 2017b).

All these limitations concerning the HBIM platform creation have led the researchers to think about the need to ideate and develop a custom-made solution, able to include geometric information and another kind of data for the purpose of collecting them inside a 3D environment, or in some cases 4D depending on time dimension included. In fact, BIM limitations on industry and engineering standards have involved the integration of Cultural Heritage assets peculiarities. In this sense, the creation of a customized and ad-hoc HBIM platform, including Heritage assets peculiarities and integrating stratigraphic evidence from a geometric to a semantic point of view to the model could be defined as a real challenge nowadays, also because actually there aren't BIM software developed just for Cultural Heritage (Diara et al, 2018). These considerations bring the reasoning on the **objectives and purposes** of this project thesis, considerations that have led me to asking different questions:

- Is it possible to create a custom HBIM platform for building archaeology purposes?
- Is it possible to create a custom HBIM platform that collects, manages and produces information at the same time?
- Is it possible to integrate stratigraphic information inside a HBIM platform?

As already mentioned before, the principal aim would be to create a dynamic **custom-made solution**, resulting of ad-hoc workflows, able to collect and manage Cultural Heritage data allowing a correct comprehension, a secure back-up storage system and for inquiring data coming from different external analyses and researches. This ad-hoc system should **collect and produce at the same time metric and historical information**, with the possibility of interacting and querying data for deeper investigations, such as the historical evolution of buildings through the analysis of walls **stratigraphy** by using semantic relations.

When we talk about a custom and ad-hoc solution, different issues came up concerning commercial BIM platforms, especially due to their closed source code and the limited possibilities of including custom tools and properties of Heritage assets. Moreover, some compromises involve the modelling phase inside the most common BIM solutions due to the presence of predefined parametric architectural families based on theoretical architectural elements and simplified models. For this reason, the creation of complex models referred to Heritage assets is an important issue to solve for the purpose of creating an HBIM of a highly detailed historical architecture (Lo Turco et al., 2017b; Beltramo et al., 2019a). In this sense, the possibilities of exploring new methods of modelling the architectural complexity have been tested in these years. As proposed by Oreni et al. (2014) and Banfi F. (2017) the utilization of a pure modeller could ease the BIM modelling step. Free form modelling includes also NURBS (Non-Uniform Rational Basis-Splines) mathematical representation of curves and shapes, and by using this solution could be possible to represent complex elements instead of parametric modelling based on predefined theoretical families. So, other questions came up:

- Is it possible to create a custom HBIM platform by using open source solutions?
- Is it possible to create a custom HBIM platform starting from NURBS models?

In this sense, limitations concerning commercial solutions described before brings me to investigate the possibilities of **free and open source software** (FOSS) trying to understand whether and how these solutions fit for the purpose of creating an operative open source HBIM platform. In this regard, the utilization of FOSS software could be considered a fitting choice due to the flexibility and customization of source code and file formats (Myers et al., 2016), allowing also new possibilities of features integration normally not directly connected into a common BIM solution. So, innovative open source solutions, such as the tested **FreeCAD** software, could allow overcoming the drawbacks and compromises of commercial solutions.



However, commercial and open source BIM software show both objective limitations on modelling phase and for this reason for the purpose of modelling Heritage assets the best fitting choice could be guaranteed by a pure free form modeller such as **Rhinoceros**. This commercial software allows to create NURBS curves and surfaces that could fit with the Heritage peculiarities. Going deeper, this software adoption follows the Oreni et al. (2014) proposed method focused on possibilities of integration of NURBS models inside on BIM platform, after the required step of parametrization: thus, this type of NURBS models can't be used directly on BIM platforms because they need to be parametrized and converted into BIM models. Noting this method (Oreni et al., 2014), this thesis project is also based on the **possibilities of integration** of NURBS models created using Rhinoceros inside the open source software FreeCAD, trying to comprehend in which ways these different solutions (an open solution and a commercial solution) could cooperate for the purpose of integrating a modelling phase into a BIM platform, avoiding limitations described before.

These reflections, hypothesis, purposes have been applied into a particular case study: the refectory of the **Santa Maria di Staffarda abbey** (CN, Italy). Going deeper, this project and the experimented workflow has been focused on the refectory of Staffarda abbey. This building has been chosen, in addition to test and verify the mentioned purposes, especially because it needs to be analysed from the stratigraphic and historical point of view. Moreover, this historical analysis of the refectory could be relevant, thanks to the other stratigraphic studies and analyses on Staffarda abbey (especially related to studies led by Beltramo S.), for the future comprehension of the historical evolution of the abbey, through the comparison of stratigraphic analysis maps.

Then, the main **workflow** (Fig. 1) applied for this project is based on different methodologies and analyses. First of all, the necessary documentation and knowledge step has been performed by Staffarda refectory surveys: first of all, the metric survey has been carried out by LiDAR technique for the purpose of having a volumetric and 3D documentation of the refectory; next survey operation has been the walls stratigraphic analysis on the field in order to document and collect all the stratigraphic units of external and internal walls of the Staffarda refectory. These different and mandatory surveys produce data to be post-processed and managed.

Data derived from the metric survey has been processed in order to obtain clean point clouds and a high definition polygonal mesh, concerning the creation of the reality-based model, and it has been created especially for the purpose of extracting metric information and planar sections, on which has been performed the NURBS

modelling of the refectory. By contrast, the stratigraphic survey and the following analysis produced a list of units, layers, pathologies, features and relations of masonries useful in order to comprehend a relative and absolute chronology of the refectory, and then its interpretation through historical periods detection.

This information, metric and three-dimensional data and the historical interpretation of the refectory, has been included on the customized FreeCAD platform: NURBS models have been parametrized in order to become BIM objects and the stratigraphic units and their interpretation have been incorporated on BIM objects related to right surface units and also by using the internal database of FreeCAD, whereby has been possible to perform queries concerning information like materials, typology of units, historical interpretation. So, metric and semantic information in a unique BIM platform, an **open source non-conventional HBIM platform**.

After this brief introduction, can be argued some **novelties** inside this research project and they can be summarized as follows:

- The **integration of stratigraphy**, and the historical information derived from its analysis, inside a dynamic 3D database represented by BIM solutions.
- The utilization of **open source BIM** solutions and the creation of a custom-made platform for building archaeology purposes.
- The integration of **NURBS modelling** and then the adoption of pure modeller inside a HBIM workflow, due to the modelling limitations of BIM software.

These novelties and innovations points that can be extracted from the applied workflow can be identify as the willingness to solve the already mentioned **research issues**, that can be therefore summarized as follows:

- **Data fragmentation:** this is a common research issue affecting principally historical and archaeological studies, because they are based on different methodologies, analyses and outputs (from paper-based to digital data). These analyses, that are principally based on stratigraphic information combined to external data in order to refine the chronology of the analysed context, is strongly affected by a subjective component, despite it could be considered a stricter methodology.

- **BIM software:** in this sense, as mentioned before, most adopted and used BIM software are principally developed for AEC industry (Architecture Engineering Construction) and software' tools and libraries (as well as standard classifications) are designed in order to support this research field and hardly the Cultural Heritage peculiarities.
- **3D Modelling:** actual BIM solutions, commercial and open source software, are affected by objective limitations concerning modelling tools and predefined libraries: parametric modelling tools, despite they are accurate for AEC industry, hardly fit with Cultural Heritage peculiarities as well as predefined libraries and standard classifications of architectural elements.

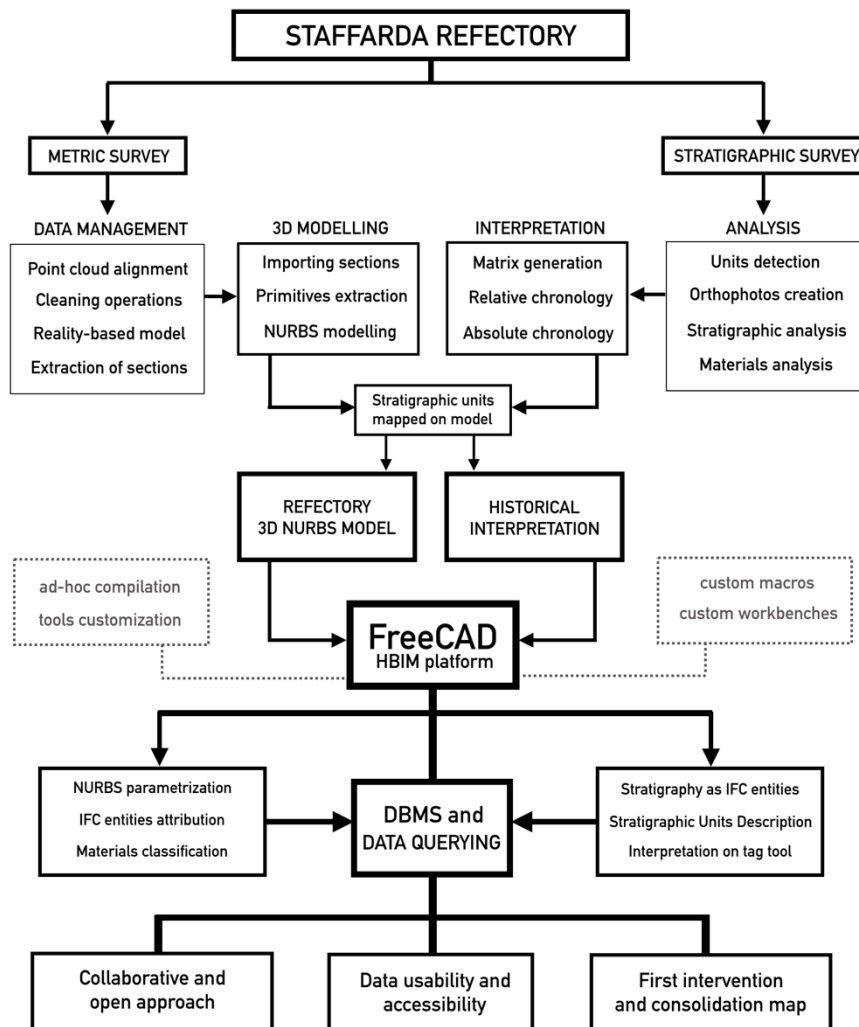

Figure 1. Main workflow designed and experimented for this project

# Chapter 2

## Methodology

In the Geomatics field, methodological choices should be affected by the final utilization of data produced and by the goal of the research. However, this thought is not always taken especially due to the constant increasing and innovation of technologies and methodology leading researchers to be impressed and fascinated, making the utilization of specific innovative technologies and methodology just for fashion and benchmarking. However, not every Geomatics solution could be reliable for all disciplines.

In this sense, as regard historian disciplines, in the Archaeology and Buildings Archaeology field the dislocation of different kinds of information (paper-based as well as digital) concerning an excavated site or a surveyed historical building affected for many years the data publication, exchange and knowledge-sharing steps. Geomatics technologies and methodologies have been lifelong employed by the archaeologists (Rinaudo F., 2011b; Balletti et al., 2015), but, despite the proper use and the reliability and quality of the carried out metric surveys, the three-dimensional and metric data obtained is hardly strictly linked to the related information and semantic data, often performed by historians relying on paper-based supports or on digital platforms that cannot communicate in the proper way with the three-dimensional environment of the surveyed object.

Then, the application of GIS solutions (Geographic Information System), and more in general **informative systems** referred to a geographic or spatial basis, has proved to remedy the issues mentioned before. Used as an instrument for the data storage concerning a specific context, GIS solution has proved to be a good technology for the purpose of obtaining a right record-keeping and management through to the utilization of integrated databases (Rinaudo F., 2011a).

Indeed, GIS platforms allow to collect and manage a different kind of information and combine them with geographic data, for the purpose of interpreting data through the analysis of spatial relations (Rinaudo F., 2016). For this reason, GIS as well as WebGIS solutions have proved in last year, growing in its methods,

to have a natural inclination for archaeological studies, especially for the need of collecting and querying a different kind of spatial-based data, and this is can be easily proved by several studies (Bonfanti et al., 2007; Scianna et al., 2011; Scianna et al., 2015; Colucci et al., 2017). Then, good storage and management of the Cultural Heritage asset spatial data can be also performed through the utilisation of GIS, 3D GIS, WebGIS solutions and DBMS (DataBase Management System), for the purpose of integrating different kinds of sources (Rinaudo F., 2013).

Moreover, as far as buildings archaeology is concerned, analyses occurred on the Staffarda abbey through the utilization of GIS solutions have also proved to achieve satisfying results in order to investigate the wall stratigraphy of the north side of the Santa Maria church, marking a crucial step of knowledge for the purpose of obtaining a complete historical interpretation of the church and in general of the abbey integrating the stratigraphic analysis and GIS technologies (Beltramo et al., 2019b). However, these GIS-based analyses, although have produced good and innovative results, experienced the absence of a complete three-dimensional architectural informative platform, able to keep in the same environment information to the 3D model (for the scale of the building).

However, from a long time building archaeologists and architecture historians have tried to combine three-dimensional documentation (high quality 3D model) with the semantic dimension of historical buildings (historical information and other resources) as far as the architectural scale is concerned, in addition to the already mentioned territorial and spatial scale, trying to obtaining a complete informative system for historical architecture. In this sense, the Building Information Modelling methodology is properly introduced and the methodological choice for this thesis project relies on these reasons.

## **2.1 Introduction to BIM**

Building Information Modelling (BIM) is basically considered the natural heir of the 2D CAD way of thinking architectures. In fact, BIM increases the functionalities of CAD architectural software, allowing to establish semantic relations between the 3D model and its functional and structural information (Van Leeuwen et al., 1996; Garba et al., 2004; Tse et al., 2005). Moreover, the BIM workflow allows to include the parametric model attributes and functional characteristics and then to design architectural and technical components of a building, such as walls, windows, roofs and so on (Fassi et al., 2013). Indeed,

according to the National Building Information Model Standard<sup>1</sup> definition, BIM is referred to a digital and complete representation of a **building** or architecture, thought as a shared knowledge platform, in order to ease construction and maintenance in its life-cycle.

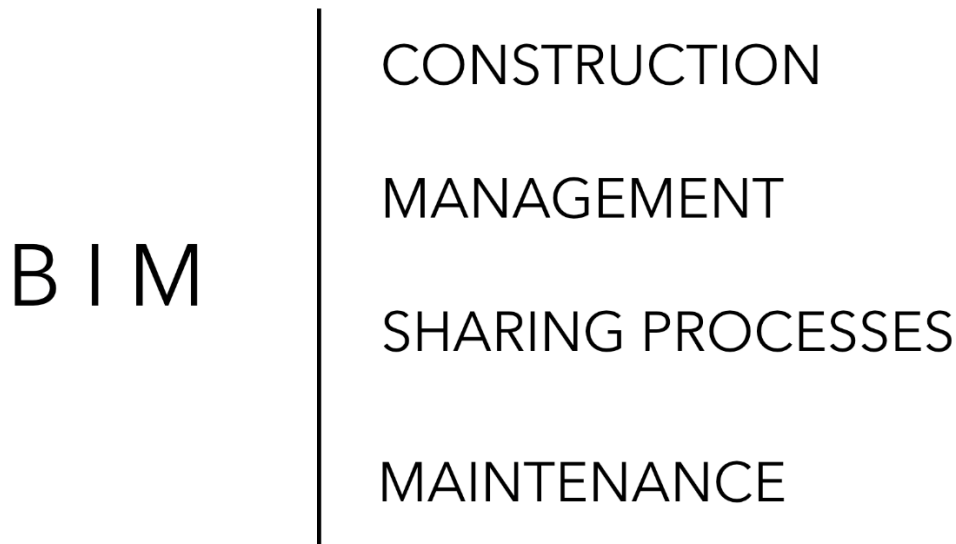

Figure 2. Main processes throughout BIM applications

As mentioned, BIM has been developed for architectural design, technical installations, engineering projects, and then for the AEC industry. Then, buildings and new constructions are at the centre of this thought. Going deeper, the entire monitoring of the life-cycle of buildings becomes a mandatory solution for architecture design and in general as far as new constructions and installations are concerned, and these required standards can be guaranteed by BIM solutions<sup>2</sup>. Then, BIM cannot and it is not a simple bare three-dimensional representation of buildings, but, as stressed before, it consists of a dynamic 3D database, focusing on buildings information. For this reason, **information** is and has to be the main actor in BIM projects. Information consists first of all in the semantic identification and classification of 3D objects as architectural elements and components, such as

---

<sup>1</sup> <https://www.nationalbimstandard.org/>

<sup>2</sup> For example, in Italy has been introduced the normative concerning BIM for public constructions through the D. Lgs. n.50/2016, although it specifies the *possibility* and not the *obligation*.

walls, roofs, columns, windows and so on. Moreover, inside the models can be collected and managed metric information through the utilization of interchangeable dynamic parameters, materials properties and then structural behaviours and mechanical properties (e.g. Ultimate Tensile Strength, Compressive Strength and so on), architectural features (e.g. Sound Transmission Class, Thermal Conductivity).

Through the utilization of internal databases, BIM platforms can also collect and manage another kind of information concerning buildings and for then query processes become fundamental in order to investigate and integrate the data dimension. Then, as can be argued, BIM has been developed thinking about the collaboration between different professional figures working on the same project, and this is the reason why BIM information has to be easily comprehensible and manageable, focusing on open standards with a multidisciplinary approach. In this regard the IFC standard is naturally introduced.

IFC (Industry Foundation Classes) is referred to an open format, developed by buildingSMART<sup>3</sup> and widely adopted in the AEC industry and BIM applications and for this reason it becomes a standard format regularised by the International Organization for Standardization (ISO). In fact, IFC main features are defined with the EXPRESS language determined by the normative ISO/TC 184/SC 4.1994<sup>4</sup> and furthermore the normative ISO 16739<sup>5</sup> establish the dictionary terms and the IFC schema is based on: header section, types, entities, functions, and rules concerning architectural elements and technical installations. Going deeper, information about the schema is given by the header section, types and entities are referred to data definitions, functions and rules concerning the constraints regularised on data definitions (Lee et al., 2014).

For these reasons, the IFC open format could be considered a dynamic database, because it allows to include on its schema different information, and then it is also related to relational semantic objects including layers and different classes. Including information and being light-weight format, IFC standard could be compared with another open format including data exchangeable, the GIS *shape file* format. In this sense, BIM informative models differ in a methodological as well as in a conceptual point of view from “classic” 3D reality-based models, approaching more and more to the GIS concept a methodology, even if BIM approach maintains the modelling and representation scale peculiarities. In fact,

---

<sup>3</sup> <https://www.buildingsmart.org>

<sup>4</sup> <https://www.iso.org>

<sup>5</sup> <https://www.iso.org/standard/51622.html>

BIM platforms require dynamic, simplified and light-weight models and formats, because the main actor and the real *big data* should be information inside every object (Diara et al., 2019).

As mentioned before, BIM models are different from 3D reality-based models, because they are planned for another kind of projects and goals. First of all, they are defined as parametric objects, which, in addition to basing on real measurements, could be thought as dynamic objects that are **modelling** through the real-time modification of geometrical and metrical parameters, especially the thickness value. In this sense, parametric objects concerning architectural elements shall be interpreted and simplified depending on the objective and subjective view, depending on levels of details (LODs) and last but not least on the research goal. In addition to being dynamic models, the other advantage of parametric BIM models is being a three-dimensional interactive database of metric, structural and semantic information.

Then, parametric modelling is widely used for BIM models for different reasons, especially due to their versatility and their dynamicity. In fact, despite they consist in conceptual models due to the mandatory interpretation and simplification step, these models allow to modify in real-time their parameters and include inside their structure different kind of information, and these features are required and fundamental characteristics for BIM models.

By contrast, reality-based models cannot offer all these features mentioned before. They guarantee great quality and precision as far as the representation scale is concerned, allowing us to visualize and manage a scaled digital / virtual model of a surveyed object as it appears in the reality, including all geometric features and peculiarities and radiometric information (RGB colour information). Moreover, these models allow to perform a different kind of analyses and managing processes, such as filtering operations, shape analyses, structural analyses, curvature analyses, and so on. However, despite these advantages and possibilities, reality-based models could be considered anonymous models. In this sense, heavy 3D point clouds and complexes triangulated meshes do not provide important information from a semantic point of view and they are not defined as three-dimensional databases with the possibility of being managed and increased from different professional figures.

Although BIM solutions become an important requirement regarding the AEC industry, these approaches and methodologies, due to their possibilities, are recently tested and involved in existing buildings as well as historical buildings and Cultural Heritage assets.



## 2.2 HBIM state of art

BIM solutions can be applied to Cultural Heritage assets, changing the name in **Historic Building Information Modelling** (Murphy et al., 2009) as well as modifying purposes and methodologies. By using the expression Historic BIM, Maurice Murphy meant: *“a novel solution whereby interactive objects representing architectural elements are constructed from historic data, these elements (including detail behind the scan surface) are accurately mapped onto a point cloud or image based survey”* (Murphy et al., 2009; Murphy et al., 2013).

In this sense, BIM differs from HBIM from a conceptual point of view: in fact BIM is especially referred to new constructions and the referred to new projects, at the beginning of the life-cycle of the building; by contrast, HBIM should be intended as the knowledge of the historical building and then it takes place in a specific life-cycle moment (Fassi et al., 2013; Tommasi et al., 2016).

However, talking about HBIM it is not so easy because BIM for Cultural Heritage is considered an ongoing research field for many reasons. Indeed, the complexities and peculiarities of existing buildings and Cultural Heritage assets (e.g. historical buildings, and archaeological sites) involve a great level of details as far as the geometric data and its interpretation is concerned, and for this reason it is nowadays a challenge especially due to the methodological and modelling issues arising from the use of commercial BIM solutions (Autodesk Revit, Graphisoft Archicad), mainly developed to support building design and in general AEC industry (Barazzetti L., 2016; Diara et al., 2018). In this sense, Cultural Heritage assets have to be aided through the utilization of simplified and conceptual levels of details, for the purpose of representing and analysing the Heritage assets visible and invisible stratified peculiarities (Georgopoulos et al., 2013; Spallone et al., 2016).

HBIM is also a difficult task especially since historical buildings are not referred to a unique construction site in both chronological terms and architectural stratification ones, because historical architectures experienced expansions or demolition works as well as the changing of the original designated use of the building. These changes involve important knowledge operations, in fact the metric survey is and must be the first step for HBIM projects as well as the historical and objective knowledge of the context, in order to achieve a diachronic awareness of the historical moments and then in order to ease the safeguarding processes of Heritage assets (Beltramo et al., 2019a). In this sense, HBIM projects workflows

starting from metric survey and then mostly LiDAR data are generally named scan-to-BIM or in this case scan-to-HBIM workflows: the first step is the survey, then the point clouds management, then the parametric modelling of architectural elements, their semantic classification and database management.



Figure 3. Main processes and advantages through HBIM applications

In the last years, different researches have made great contributions to HBIM field and analysis, in fact, BIM developers and specialists, architects and engineers always got a sensitivity to historical buildings and Cultural Heritage assets. Early HBIM experimentations and analyses have been developed and carried out for the purpose of integrating the historical architectures parametric modelling, starting from knowledge processes as metric surveys, into BIM environment (Chevrier et al., 2010; Fai et al., 2011). In this sense, the development of scan-to-HBIM projects suffers more issues and troubles especially as far as the modelling phase is concerned, because the creation of BIM objects has to be designed starting from real measurements and then operating by interpretation and simplification processes, differently from BIM developing steps in AEC industry because Heritage assets are characterized by decorations, ornaments and other kinds of peculiarities that experience and increased effort in survey and modelling steps (Fassi et al., 2013).

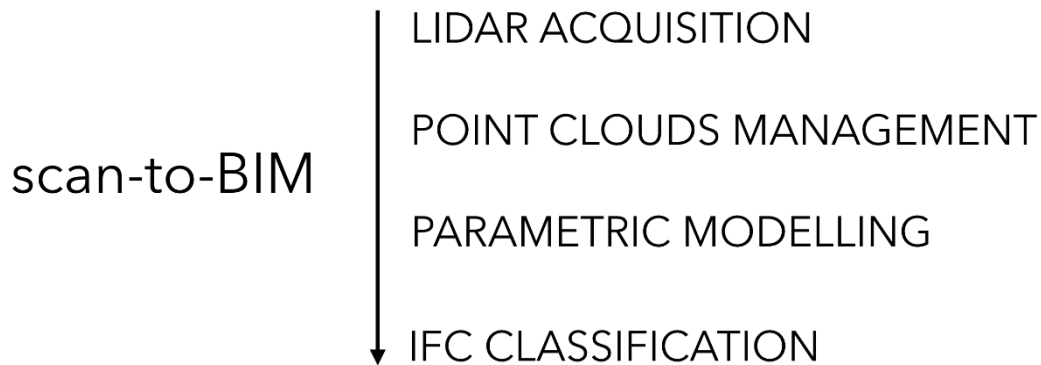

Figure 4. Scan-to-BIM main operative steps: from LiDAR data to BIM

Modelling phase has to be performed correctly and planned in order to achieve the right representation also established on the level of detail to get to, and it strongly influences the complexity of the model (Diara et al., 2019). Then, whether the first phase should be the metric survey in order to document a historic architecture as it is, the second phase has to be the comprehension and representation of geometric primitives (basis geometrical shapes composing an architectural element) surfaces and shapes, and it can be performed in different ways, as we will see in chapter 9 (Barazzetti L., 2016; Chiabrando et al, 2017; Lo Turco et al., 2017a):

- **Automatic** extraction of geometric primitives from laser or image-based survey data;
- **Semi-automatic** extraction of geometric primitives, able to ease the creation of parametric objects;
- **Manual** interpretation and modelling of geometric primitives, surfaces and shapes, through metric surveys post-processing data (such as point clouds segmentation).

As can be argued, the manual approach, even if a time-consuming method, could provide to overcome the BIM modelling limitations, allowing to comprehend and manage directly the complexity of shapes and geometries. However, the creation of parametric objects of Heritage assets experience another kind of issues,

for example concerning the semantic and typological classification of objects. In this sense, a parametric modelled object has to be assigned to an architectural typological sub-division in order to be classified as *wall* or another kind of elements (Macher et al., 2017). However, these typological classifications, included into IFC schemas, have been thought especially for the AEC industry, and the possibility of integrating predefined architectural families could require too much time (Adami et al., 2017).

In the modelling phase the level of detail of modelling (LOD) is a fundamental classification system, especially for BIM projects for the AEC industry. Briefly, LODs become standard for BIM projects and they are concerning different scales of representation: they are ranging from LOD100 (simple 2D representation) and LOD500 (detailed 3D representation including objects attributes). However, as mentioned before, this classification has been developed for the AEC projects and in case of historical architecture and existing building LODs it has to be related to the precision and quality of metric survey as well as the modelling software used and the modeller capabilities (Fai et al., 2014). Moreover, a novel and interesting research field is focusing on the developing of new modelling classification systems and this choice has been influenced by the not properly flexibility of BIM modelling standards and protocols, and, as we will see in the next chapters, researches introduced Grade Of Generation (GOG) classification system in order to define not the models details but in order to enhance single object LOD and in order to classify methods and quality of modelling carried out by using free form modellers such as Rhinoceros (Banfi F., 2017; Brumana et al., 2018; Banfi F., 2019).

Lately, groups of researchers and developers have begun to think about the possibilities to develop and rely on custom-made solutions avoiding proprietary software, able to include metric information and historical information collecting and managing them onto an open source platform (Logothetis et al., 2016; Historic England 2017). This choice is affected by several reasons, such as economic and methodological reasons: in fact, nowadays the utilization of commercial BIM solutions could involve making economic and methodological compromises. Moreover, the developing process of BIM platforms could be affected by the same process of GIS solutions, where, despite the initial years of GIS commercial software utilization, nowadays the most used and regularly developed and updated is referred to an open source solution, QGIS<sup>6</sup>. In this sense, for the purpose of achieving data transparency and accessibility, a proper solution could be guarantee

---

<sup>6</sup> <https://www.qgis.org/it/site/>

by open source protocols, as we will see in chapter 10, especially concerning libraries and exchange formats, according to the IFC open format thought (Logothetis et al., 2016; 2017a).

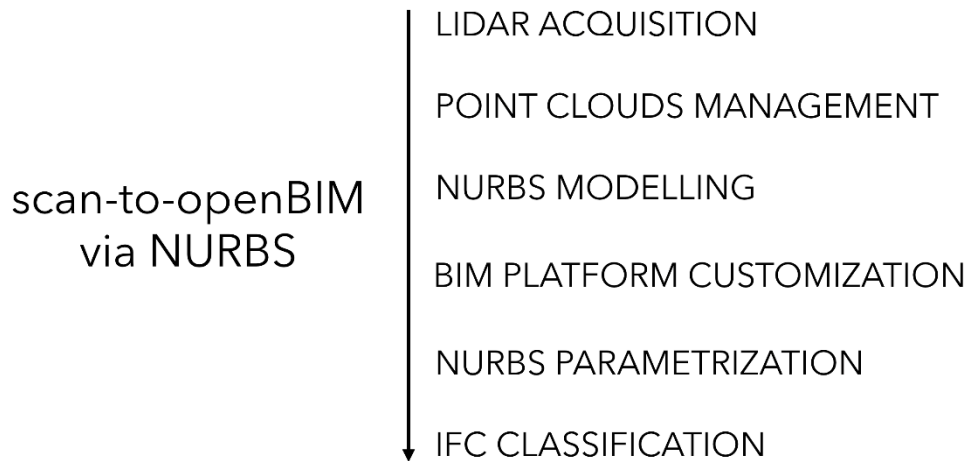

Figure 5. Scan-to-openBIM via NURBS main operative steps

Then, this thesis project is intended to be included in the last two groups, through the experimentation of the open source software FreeCAD and its integration with a pure 3D modeller as Rhinoceros, trying to develop a custom experimental scan-to-BIM workflow for building archaeology purposes, that could be named *scan-to-openBIM via NURBS* due to the used modelling algorithm. This kind of application has been also inspired and supported by GAMHER project purposes (Bitelli et al., 2017). Moreover, other studies inspired this project idea, such as the research carried out by Chiabrando F., Lo Turco M., Rinaudo F., concerning the decay surface modelling and integration into HBIM platform (Chiabrando et al., 2017); the researches concerning the integration of 3D NURBS modelling into HBIM platform (Oreni et al., 2014; Banfi F., 2019) and the grades of generation and accuracy analyses regarding BIM models (Banfi F., 2017).

# Chapter 3

## Case study:

## The refectory of Staffarda abbey

### 3.1 Historical and architectural framework

Before describing Staffarda abbey, the historical framework about monastic orders and their buildings composition should be introduced in order to better understand the events and the architecture guidelines that occurred in this architectural context that we are going to analyse.

Churches, monasteries, abbeys, are the Christianity establishment outcome. From X and XI centuries a large part of religious buildings was rebuilt using new techniques, more space, finest materials, due to, as Jacques Le Goff said (Le Goff J., 1964), prestige and devotion reasons. Moreover, **medieval monasteries** were the result of buildings aggregation (based on a specific architectural design) in order to ease the religious and spiritual life of monks, which cohabit praying and working together with the monastery land. The reason of including rural lands inside abbeys and monasteries lies in the great importance of land on Middle Ages, especially between the second half of the X and XIII centuries. By farming the land, that was the main working source, self-livelihood and then food independence could be reached; in addition to this reason, this kind of isolation (economic isolation) should be the basic condition to reach the spiritual purity.

Furthermore, from an economic and political point of view, between XI and XIII centuries, one of the main purposes of religious foundations was to keep stable and inalienable land properties of local noble families and for this reason at least an heir of the main branch of the family should become abbot until the management of properties was under control.

Although monasteries permit the slow circulation of Christianity on the countryside (far from the Christian urban society), on the other hand these religious

buildings are the proof of being isolated points in the middle of forests and lands, and, in this sense, monks desired to stay in solitude in order to reach and discover true moral values, lost for a long time. Within rural lands and uncontaminated forests stood out impressive religious architectures, built also for the purpose of astonishing pilgrims and faithful people.

The **architectural composition of monasteries**, buildings connected to the abbatial church and their placement, has been regularized in the IX century, during the Carolingian age (Augenti A., 2016). However, between X and XII centuries architectural choices concerning religious constructions are strongly influenced by the monastic orders, especially Cluniac and Cistercian orders (Tosco C., 2016).

This regulation reaches a well-established schema only on the XII and XIII centuries, and it involved the cloister as the hearth of the monasteries, and around the main buildings were placed. The cloister, in addition to permitting the outdoor prayer, reflections and thoughts (overlooking nature), made the comprehensive view of the entire architectural structures, including the church (the south side of the church). Around the cloister are located main monastery buildings: the chapter hall (*capitulum*), probably the most important hall of the monastery, was broadly placed on the east side of the cloister; the refectory (*refectorium*), where the monks ate and prayed alternately on the pulpit, was generally situated on the south side of the cloister; the west side of monasteries was typically used for supplies and/or for lay monks (Augenti A., 2016).

After the XII century Romanesque architecture changed and reached new shapes and ornaments that will create the Gothic, described by Jacques Le Goff as urban art (Le Goff J., 1964). Despite this architectural changing, the countryside churches and monasteries buildings are less influenced by this stylistic trending, also due to the different economic resources, materials supply but especially for the simplicity chosen by monks (Le Goff J., 1964).

These religious architectural structures have been thought, in addition to the divine service, in order to infuse tranquillity, serenity and safety to monks as well as lay people, because some monastic orders allowed to lay people to live with monks practicing religious life inside monasteries as much as they were excluded from the liturgical service.

This kind of thought was under consideration for the other monastic orders, which, as expectable, hardly coexisted without moral confrontations and oppositions, and this happened between the Cluniac<sup>7</sup> and Cistercian orders.

---

<sup>7</sup> The Cluniac order, briefly, gets its name from the Cluny abbey, that was founded on the Mâcon shire (France) at the beginning of the X century for the purpose of renovate the Saint Benedict rule. Of course, Cluniac monks caused the increase of the number of monasteries, permeated by

The **Cistercian order** was born by a rigor and penitence life of monks of Cîteaux abbey (founded in the last years of XI century in Bourgogne, France), and this movement grew up enough to includes Morimond, Pontigny, La Ferté and Clairvaux, that played a fundamental role for the raise of Saint Bernard and its rule, the main personality who made possible the dissemination of Cistercian order in Europe (Le Goff J., 1964).

Indeed, during the XII century were built in the Piedmont and Ligurian area different Cistercian abbeys derived from La Ferté, which is one of the *mothers* abbeys along with Cîteaux, Morimond, Pontigny and Clairvaux: in Piedmont these are located in Lucedio (VC), Staffarda (CN), Casanova (TO) and Rivalta Scrivia (AL)<sup>8</sup>, while the first construction was in Tiglieto (GE).

The moral and spiritual collision (started from Pierre de Montboissier abbot of Cluny, 1122-56, and Saint Bernard Abbot of Clairvaux, 1115-54) happened regarding daily life in monasteries as well as on architecture style: indeed, Cluniac monks (which practiced just the divine service) inside their monasteries were surrounded by servants used for common works, while Cistercian monks were characterized by a perfect combination of divine service and manual works (especially as regards converses monks); in addition to this reason, existed the architectural ornaments dispute, because the first monastic order lived in buildings and prayed in churches full of ornaments and opulence elements, while the Cistercian buildings were distinguished by simplicity with basic architectural elements (Le Goff J., 1964). Consequently, Saint Bernard changed not only the monastic life and liturgy but also become a promoter of a new conception of art and architecture, different from others.

The earliest **Cistercian constructions** in the French area followed architecturally and stylistic rules in order to have right framework for the liturgy of the order. As far as the schema of the Cistercian church is concerned, the Benedictine rule describes the ideal church: the church had to be honoured to Maria; was not supposed to have sculptures and paintings; was supposed to have white stained glass windows; was not supposed to have a bell tower (Carità G., 1999).

The architectural schema of Cistercian churches (XII century) provided for a cruciform plan characterized by the square module and this solution has been carried out by Saint Bernard, also because it appeared in many churches close to Clairvaux (Tosco C., 2016). However, the Cistercian construction schema has to be

---

magnificent Romanesque architecture, but especially the strength of the order (related to new foundations).

<sup>8</sup> The Rivalta Scrivia and Casanova constructions show the stricter Cistercian model among the abbeys in Piedmont.



defined as a square design methodology more than a simple schema (Tosco C., 1999).

Furthermore, in the Cistercian construction site the square module<sup>9</sup>, the *Bernardine plan*, was determined from the measure between the bottom wall of the apse and the connection of the aisle and the transept (Fig.6). This range should be the same also for the sides of the choir; in addition, the half measure of this distance produces the dimension of the transept hands length, the choir depth and the chapel' width (Beltramo et al., 2006).

Semi columns in the choir are other particular elements of the Cistercian style that can be noticed in the first churches of the order, and these elements have been introduced for transept space and liturgical reason, in addition to becoming structural support for the ceiling (Leroux-Dhuys et al., 1998).

The articulation of buildings inside monasteries appears clear and schematic, with a regular disposition of rooms and buildings around the square cloister, that is the heart of the monastery, located to the south side of the church oriented to the east. As far as the other exact position of buildings is concerned, on the east side are placed the sacristy (generally connected to the transept), the chapter hall, the *auditorium* and the monks' hall; on the south side are located the *calefactorium*, the refectory and the kitchen; on the west side there were the buildings for the converses monk, such as the refectory, the pantry and the access to the cloister.

Moreover, following the rule, the monastery connected to the church shall include (outside the borders) a farm with animals managed by converses monks and, finally, the monastery shall include a mill, a water system and other laboratories (Carità G., 1999). This regular disposition derived directly from the Cîteaux and Clairvaux simplified models.

Despite these rules and architectural habits, there were exceptions in the architectural schema especially for the Cistercian abbeys of second and third filiation, such as Staffarda abbey (Kinder N.T., 1997).

---

<sup>9</sup> Generally, the square module was designed directly on the soil in accordance with a designed model provided by the abbey that promoted the construction.

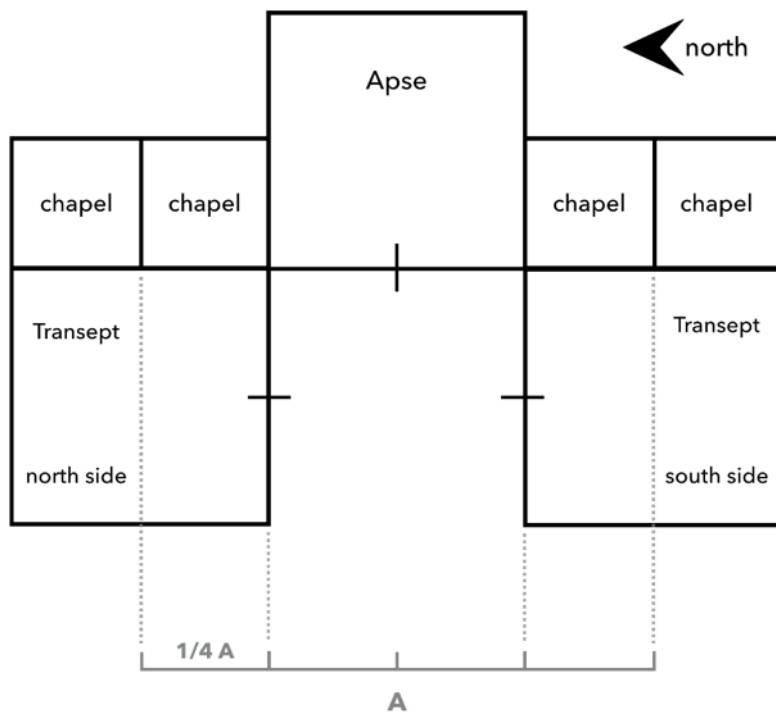

Figure 6. Construction schema (square module) for the choir and transept (Edited schema from S. Beltramo et al., 2006)

### 3.2 Santa Maria di Staffarda abbey

Travelling towards Staffarda abbey it is clear the pronounced rural inclination in the Saluzzo rural countryside. Observing it from a distance from the south-east, the tower bell and the three apses mark the monumental abbey; on the contrary travelling to Staffarda from the north-west the first impression is that we are getting close to a rural farm. These views combined exactly the duality of the abbey as well as other monasteries, because in the middle years of the XII century, the Staffarda abbey experienced different roles, from religious (and then liturgical) to economic (and then rural) positions.

The Cistercian abbey of **Santa Maria of Staffarda** (CN, Italy), shall be considered one of the earliest Cistercian abbeys in Italy, founded around 1135. Staffarda descends directly from Tiglieto abbey, the first abbey built in Italy around 1120 that has the origin from La Ferté. Briefly, the abbey is composed by the Santa Maria church and the monasteries buildings located regularly around the square cloister.

Staffarda abbey becomes the third of religious buildings founded by the Aleramic lineage, after Tiglieto e Lucedio, in fact the foundation has been favoured, as reported by a papal edict of 1144, by Manfredo marquis of Saluzzo (Comba R., 1999). Moreover, this choice can be read as a desire of Saluzzo Marquisate of imposing their cultural and political identity in this region. Indeed, the Staffarda abbey, as well as Casanova abbey, has been the focus of earlier historical events of the local aristocrats, which originate from Vasto marquis that invested economically and politically into Saluzzo territory (Provero L., 1999).

The close connection between the ecclesiastic and laic power, and then the double-sided of authority, occurs also inside the Staffarda abbey. In fact, in addition to becoming the first mausoleum of the noble family of Saluzzo, during the XIII century members of an important family of Saluzzo are documented inside the abbey (Provero L., 1999). Furthermore, connections between laic power and churchmen happened through land concessions, that didn't have only an economical significance, but most of all they become a way to establish relations.

The **Santa Maria church** was the first construction of the abbey at the wish of the Saluzzo Marquise (Beltramo S., 2010). In this regard, as we noticed, the aristocracy of Saluzzo played a fundamental role for the purpose of giving a solid framework on this land. Moreover, the foundation of Staffarda abbey occurred in the same years (first half of XII century) of other Cistercian establishments in Piedmont and Italy, such as Lucedio, Rivalta Scrivia and Casanova (Bellerio M., 1985).



Figure 7. Staffarda abbey view from APR (image from M. Roggero APR survey)

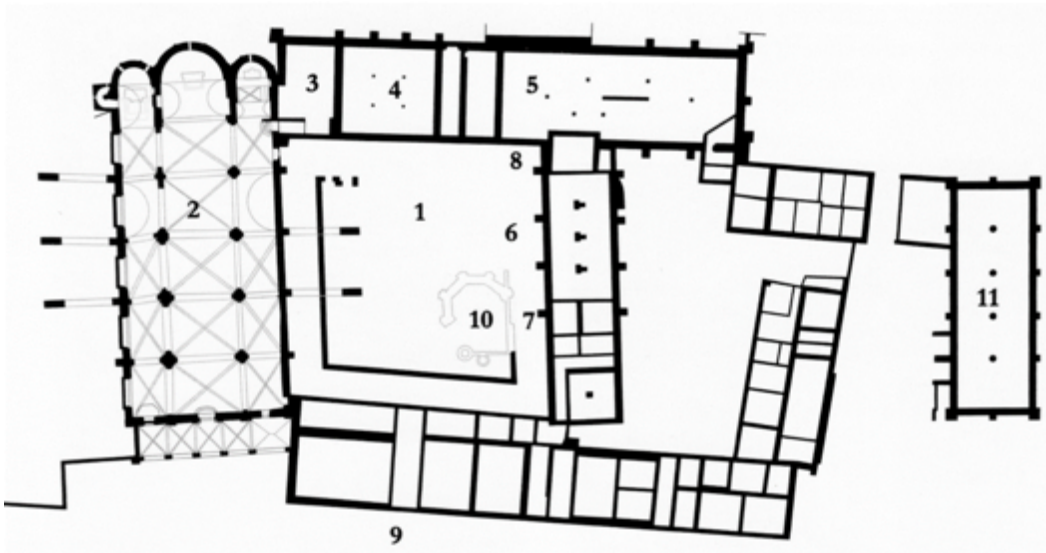

Figure 8. Staffarda abbey ground plan: 1. Cloister; 2. Church; 3. Sacristy; 4. Chapter hall; 5. Monks hall; 6. Monks refectory; 7. Kitchen; 8. *Calefactorium*; 9. Converses side; 10. Fountain; 11. Guesthouse (from S. Beltramo, 2010)

Different studies are focusing on the earlier origin of the church and the abbey in general. This reflection and hypothesis could be helped by the analysis carried out by G. Coccoluto regarding an epigraph of the VII century discovered in 1811 below the floor of a barn of Staffarda abbey, which is related to a funeral inscription of *Honorata* (Coccoluto G., 1999). This discovery has great importance because it could be referred to a previous settlement, probably a rural early medieval church (Coccoluto G., 1999). This hypothesis, although hasty and careless, could be compared to the already mentioned organization of rural countryside from Christian authorities. In fact, churches and monasteries permit the circulation of Christianity in the rural countryside.

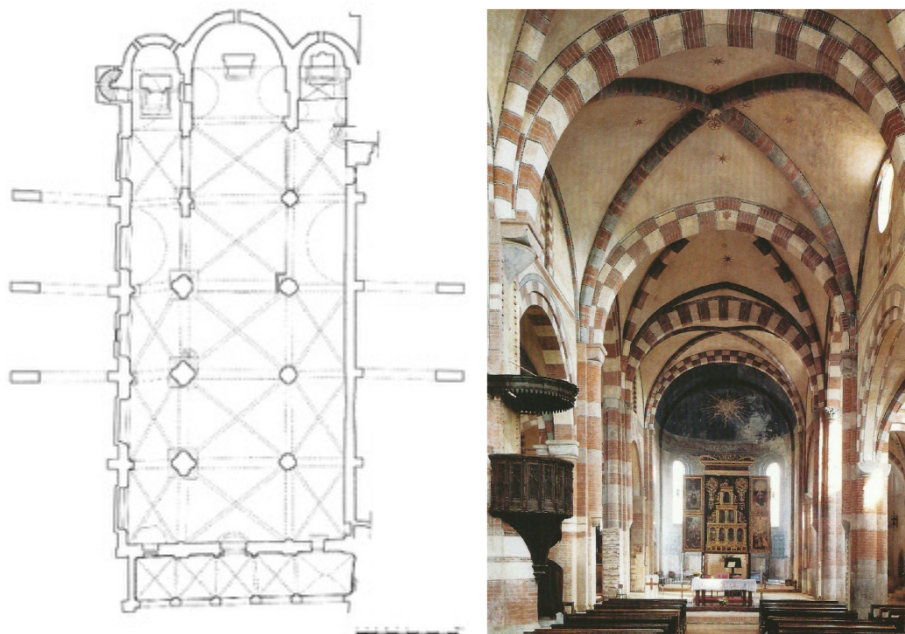

Figure 9. Staffarda church ground plan (from C. Tosco, 1999) and inner view of the central aisle of the church

Despite several interventions, the original framework of the church has never changed: as can be seen in a plant (Fig.9), the church has three aisles that merge with three oriented apses through a not-protruding transept that unifies and connects the entire inner space, without the aligned chapels on sides typical of the Plan Bernardin constructions.

As far as the foundation of the church is concerned, the absence of pointed arches in the Staffarda church is a crucial element for the chronological collocation, in fact the first usage in Piedmont of pointed arches occurred in 1180-1190, such as in

Vezzolano rectory (1189) and in the Rivalta Scrivia abbey in the same years, so, probably the main construction phase of the church should not get through 1160, apart from the vaults, built after the conclusion of the main construction site (Tosco C., 1999; Beltramo S., 2018c).

In addition to being a complex building it can be defined as an unusual construction, especially because it shows local architectural elements related to local Piedmont and Lombard Romanesque tradition; these elements, that will be analysed, merge their components with Cistercian features of the Santa Maria church, such as ribs with thoric section and the suspended semi columns in the choir (Tosco C., 1999). In this sense, the Santa Maria church can be compared with the first Cistercian church in Piedmont (1123), still honoured to Santa Maria and built in Lucedio, close to Vercelli. Both churches, that have a similar ground plan and construction techniques, can be referred to the same architecture style that merges Cistercian principles with a local tradition (Tosco C., 1999). The mature diffusion of the Cistercian schema takes place a few years later, in fact, the adoption of the complete Cistercian Burgundian model, for instance, the rectangular apses and the chapels aligned with the transept can be observed in the churches of Casanova e Rivalta Scrivia (Tosco C., 1999).

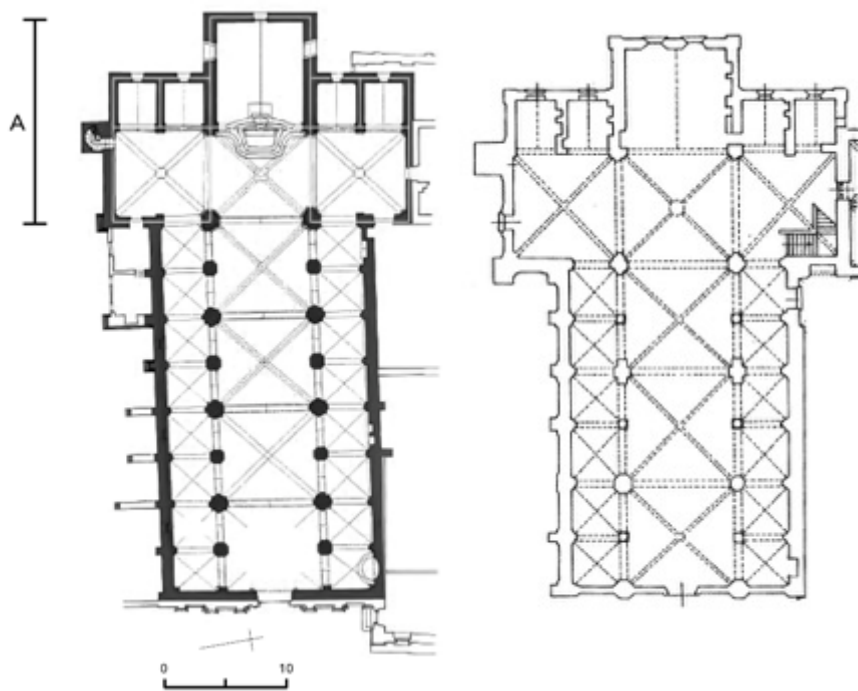

Figure 10. Ground plans of Casanova church (from S. Beltramo, C. Tosco, 2006) and Rivalta Scrivia church (from Beltramo S., 1999)

Indeed, the Casanova church (Fig.10) was built following strictly the Cistercian schema, named Bernardine plan: orthogonal ground plan having a protruding transept and chapels on sides, and also a square apse. However, in Santa Maria of Casanova despite the construction of the first east block by using the rigid square module, the construction site continued easily and quickly relying on local architectural tradition (Beltramo S., 2009b). Moreover, the design of the church in Rivalta Scrivia (Fig.10) can be compared to the Casanova system: the church shows a regular square apse and chapels. Become clear the similarities between the square module and dimensions adopted in Casanova and Rivalta Scrivia and the success of the Cistercian model in Piedmont (Beltramo S., 2009b).

The Santa Maria church, that has the original spatial organization, oriented on the east and characterized by the presence of the alternation of bricks, stones and plaster, has three aisles that end with three semi-circular apses that show different dimensions due to restoration actions during modern times (Tosco C., 1999). Regarding this, modern interventions in the church have been planned in order to restore the original aspect of the medieval church. Indeed, Cesare Berteà, Superintendent of Monuments of Piedmont in 1916 after Alfredo D'Andrade, designed and managed the restoration interventions for the Santa Maria church.

Through these operations, started in 1922, Berteà tried to restore the medieval aspect of the church, in fact, the original decoration of the wall, covered by white post medieval plasters, has been revealed and in some cases integrated (Momo M., 1999). Berteà operated by removing modern plasters, re-opening and also rebuilding the covered windows, removing the floorcovering of the XIX century and also the altar of the XVIII century (built by Antonio Bertola) (Momo M., 1999). Furthermore, he decided to remove the choir and other buildings placed leaned against the transept (Beltramo S., 2010; Beltramo S., 2018a).

However, in post medieval time, have been performed different structural interventions, in fact, through the construction of rampant arches, probably during the first years of the XVI century (Tosco C., 1999), it has been tried to reduce the overload from the ceiling and also the first installation of buttresses. Moreover, in the same years the Santa Maria church received new liturgical furniture: the wooden choir (1520-1530), the new pulpit, the altarpiece, the wooden cross and the altar at the end of the left aisle (Tosco C., 1999; Beltramo et al., 2019).

As far as Cistercian elements of the church are concerned, in addition to the already mentioned Cistercian square module (not properly regular such as the Rivalta Scrivia abbey module), inside the Santa Maria church there are others Cistercian elements such as the square or thoric groin ribs and also the suspended semi columns of the choir (Tosco C., 2017). Thoric ribs, as mentioned before, are

French imported elements that are spreading in the Lombard architecture as the result of Cistercian mediation, and this is the case of Staffarda, because its ribs with toric section are the first of Piedmont, while the suspended semi columns related to pillars of monastic choir show a strict relation with the liturgical Cistercian needs (Tosco C., 1999).

However, looking at the Santa Maria church, it could be considered an unusual Cistercian construction, because it shows different exceptions related to the Cistercian style, revealing, for example, a bell tower. Moreover, unlike the other Piedmont abbeys of the same order, Staffarda was supposed to have a fortified system around the perimeter (Carità G., 1999).

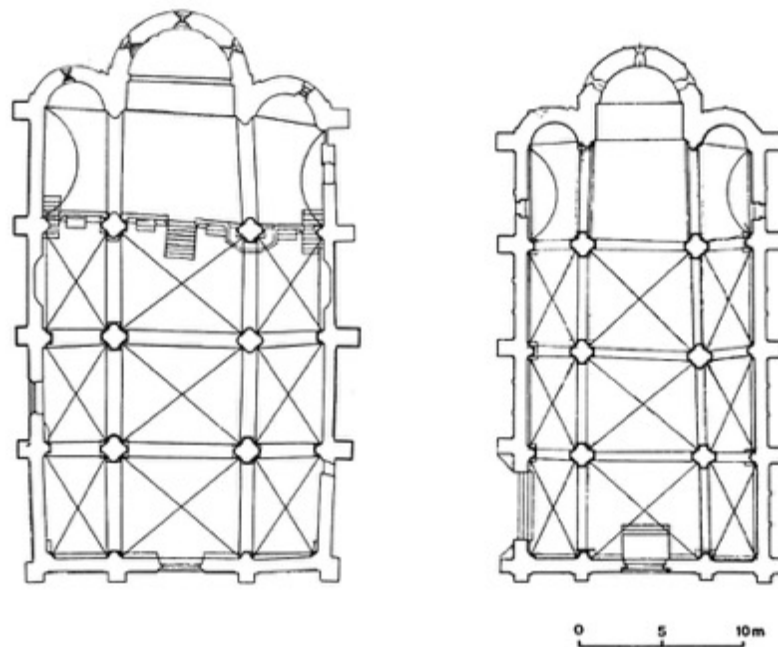

Figure 11. Ground plans of San Teodoro (left) and Santa Maria in Betlem (right) churches in Pavia (from C. Tosco, 1999)

Moreover, the Staffarda church shows architectural elements of the Lombard Romanesque, that could be referred to the construction style of San Teodoro and Santa Maria in Betlem churches in Pavia (Fig.11): these buildings show the same construction design (ground plan) of Staffarda church, especially as regards the uniform vaulted system, the disposition of rectangular bays, the section of pillars, the presence of cubic capitals and the not protruding transept (Tosco C., 1999). However, between Santa Maria di Staffarda church and the other churches in Pavia there are some architectural and differences: in fact, the Staffarda church has one



more bay between the transept and the main apse and as Carlo Tosco has pointed out, this difference is referred to liturgical needs, because in the Staffarda church an area for the monastic choir was required (Tosco C., 1999). Furthermore, another difference is concerning dimensions, because the Santa Maria church of Staffarda exceeds in height and ground plan more than Lombard models.

In this sense, it is also interesting to try to understand the origins of this kind of cultural and stylistic relations between Piedmont and Lombard areas. Regarding this, medieval workers related to the construction context were itinerant workers, and then they allowed the circulation of architectural schemas and stylistic elements in different areas, especially in surrounding areas, and for this reason the area of Vercelli played a fundamental role, not only for the San Bernardo church in Vercelli but also the Cistercian abbey of Lucedio (Bellerio M., 1985).

The choice of using different construction styles in the Staffarda church could be read as the desire and ambitions of the noble military family of Saluzzo, and, in addition to having played a fundamental role for the foundation of the abbey (especially for lands concessions), they probably traded with the aristocracy of Pavia and for this reason the reference models could only be significant, as the churches of the capital of reign (Tosco C., 1999).

Staffarda abbey was not just populated by monks. Lay people settled the first concentration of spaces around the monastery and many of them become Converses monks (who belonged to Cistercian order except for the liturgy activities) that handled the rural settlements (Beltramo S., 2010). Inside monasteries rural life was very important, indeed, the Saint Benedict rule advised the complete economic insulation, preventing relations outside monasteries, and, following his thought, they should produce food and water (Le Goff J., 1964). However, inside the Staffarda abbey, although the Saint Benedict rule<sup>10</sup> deserves it (Le Goff J., 1964), there was a granary (market lodge) that still exist outside the monastery. The main reason for this prohibition is a moral prejudice because this building (and others such as mills) was considered as an aggregation centre as much as unethical relations concentration.

As said before, Cistercian monasteries were usually built without any decorative elements and magnificent ornaments, and the buildings of Staffarda abbey follows exactly this rule: decoration and sculptures are concerned just for the few stone capitals – dated between the XII and XIII centuries (Beltramo S., 2010) – on the cloister and inside the church and they are referred to herbal decoration. This style, characterized by simplicity and moderation where architectural components

---

<sup>10</sup> LXVI chapter

become decorative elements, was in contrast with the Cluniac style<sup>11</sup> as G. De Valous said<sup>12</sup> referred to Cluny: «About glorifying God, the splendour is never enough» (Le Goff J., 1964).

After the conclusion of the construction site of the church, workers continued to build the **monastery buildings**, such as the sacristy and the portico. The monastery buildings, despite the relations between the church and other Lombard models, show clean Cistercian elements. This difference among buildings of the abbey is marked also as regards construction materials: for example, bricks of the church are arranged often with irregularities and show coarse mixture, by contrast in the monastery buildings, such as in the chapter hall, there are refined solutions, in fact can be noticed a regular disposition of bricks with a finest mixture and thinner joints.



Figure 12. Cloister detail of Staffarda abbey view from APR: can be noticed east and south front partially without gallery (image from M. Roggero survey)

---

<sup>11</sup> As G. De Valous said (in *Le monachisme clunisien des origines au XV<sup>e</sup> siècle. Vie intérieure des monastères et organisation de l'ordre*) referred to Cluny: «About glorifying God, the splendour is never enough» (Le Goff J., 1964).

It is on the monastery buildings (built around the first years of the XIII century) that could be more noticeable in the Cistercian square module. From the cloister, the great complexity of buildings and of its stratifications is observed and the architectural sequences can figure out (Fig.12). As mentioned before, the monastery buildings are built especially by using bricks as main material; on the contrary, stone (limestone and/or schist) and marble are materials principally dedicated to columns (for example the chapter hall), capitals and other decorative elements (such as the shelves and reused elements).



Figure 13. Point of view of Staffarda abbey from the cloister: can be noticed the church, the tower bell and the portal of the chapter hall (photo F. Diara)

Around the cloister, that could be considered the real heart of the entire monastery, are located the monastery buildings following the Cistercian schema. The church occupies the entire north side of the cloister. On the east side is placed the sacristy, the chapter hall, the monks' hall and a stair for the upper floor where the dormitory was<sup>13</sup>. The chapter hall played a fundamental role in the Cistercian abbey, especially for reunions and communications. The Staffarda chapter hall is characterized by a regular square ground plan with nine aisles covered by groin rib

---

<sup>13</sup> The dormitory has experienced in the XVIII century different modification, such as the separations in rooms despite the original single room for all monks.

vaults leaning on four columns and stone shelves. Columns are helped by the construction (in modern times) of wooden spars in order to lighten the weight of the ceiling. The *calefactorium*, the refectory and the kitchen are located on the south side. The *calefactorium* is referred to a warm hall due to the presence of a heat source, in this way the monks could spend some comfortable time during coldest days. In addition to the monastery buildings, on the south side of the cloister there are pieces of evidences of the octagonal fountain, which highlights the importance of water on Cistercian abbeys. The converses side was on the west side of the cloister (that is slightly oblique) where furthermore there was access to the cloister.

The main buildings of the abbey have experienced different stylistic changes in years. Indeed, in the XV century, the abbey was given as a *commendam* for the purpose of restoring the original Cistercian standards and a few years later (in the beginning of the XVI century) a stylistic and decorative renovation took place in the abbey took (wanted by the Saluzzo Marquise), especially inside the Santa Maria church (Beltramo S., 2010).

Other constructions and structural sudden changes happened especially since the end of XVII century, due to French armies that destroyed and burnt many areas and chambers (Beltramo S., 2010): indeed, these centuries are characterized by a progressive decline of the monks, especially during the **Staffarda Battle** characterized by the attacks on behalf of the French armies on 1690, that as said before, destroyed and burnt many areas of the monastery throughout the Staffarda battle in the middle of the Nine Years War, where the kingdom of France (with Luis XIV), that included as confederate also the Duchy of Savoy headed by Vittorio Amedeo II, who ordered to restore all the damaged monastery buildings, around 1716 (Beltramo S., 2010).

The XIX and XX centuries are marked principally by seismic events (for example in 1814 and 1828) that influenced the buildings of the abbey with significant damages, and for this reason have been planned different **restorations construction sites** especially for the monastery buildings. Indeed, Cesare Berteà worked for the purpose of restoring the church and the cloister, especially the north-east side with the intention to uniform these areas (Momo M., 1999). In particular, Berteà operates in order to re-establish the first construction phase of the building putting aside the wall stratigraphy, however, this choice didn't happen on the south side of the cloister, where the refectory is (Beltramo S., 2018a).

Moreover, Staffarda abbey has been modified in modern time by including rural factories, and then buildings and stalls for animals, aligned with the original Cistercian granges and farmhouses.

For all events that have suddenly changed the morphology of the Cistercian complex and consequently different restoration projects, Staffarda abbey has been the focus of recent studies and researches performed for the purpose of investigating the historical evolution of the monastery buildings related to the church (La Torre A., 2015; Beltramo et al., 2019b).

In the end, as far as the owners of the Staffarda abbey are concerned, during the XVIII century, by the order of Duchy of Savoy and then by Pope Benedict XIV, the monastery was handed over to the Mauritian Order (Beltramo S., 2018b) and still nowadays it is officially managed by the Mauritian Order Foundation, even if who visited the abbey knows that the real owners are the numberless cats.

### 3.3 The refectory

As mentioned in the *Introduction and objectives* chapter, this project is focusing on the **refectory of Staffarda abbey**. Why the decision to analyse it? Generally, case studies are selected just to test and explore new methodologies of research and new or actual technologies and hardly are chosen in order to study it especially from the historical point of view. Many times, case studies are thought like test subjects for evaluating and benchmarking experimental technologies. The refectory has been chosen because it needs to be analysed from the historical point of view and of course because it shows the entire readable internal and external stratigraphy of the walls. Moreover, this deep historical analysis on it could be relevant, thanks to the just mentioned studies on Staffarda, for the complete **comprehension of the historical evolution** of the abbey regarding the construction evidences, connecting these analyses with the archive studies conducted by Silvia Beltramo.

The topic of refectories (Benedictine and Cistercian) has experienced great success during the last years through new architectural and historical analyses that allowed the enrichment of knowledge of this particular building.

The refectory assumes a fundamental role as a common space for the monks' life. In medieval abbeys, during the construction sites of monasteries, the refectory, where monks ate, was one of the first buildings to be built, furthermore, depending on topography the refectory can be built in parallel or in perpendicular to the south

side of the cloister. This disposition could be related to the rising number of monks as well due to having a brighter hall.

The Staffarda refectory and the kitchen are located in parallel to the **south side of the cloister**, and, despite the parallel disposition the external front does not show evidence of single lancet windows (just only two small circular windows), that might be useful in order to enlighten better the inner part of the refectory (Fig.14).

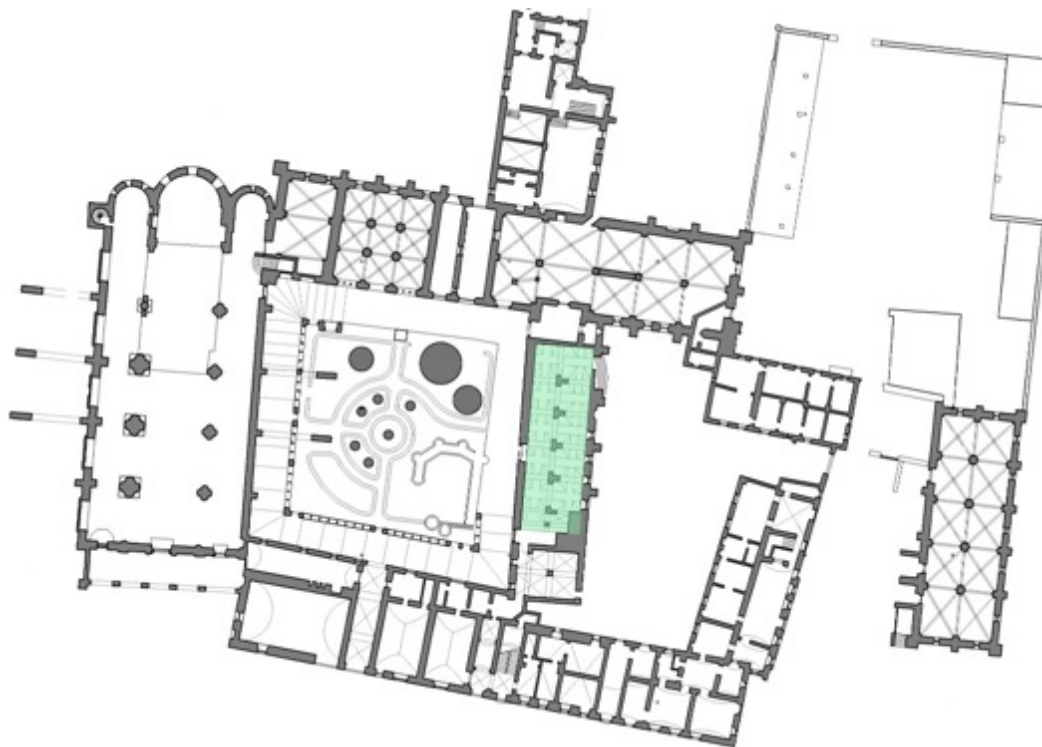

Figure 14. Detailed Staffarda abbey ground plan. In green colour the refectory placement (from S. Beltramo, 2010)

This disposition and choice can be compared with what happened in Europe in the same years: refectories built along the south side of the cloister can be referred to English abbeys of Merevale (Warwickshire) and Sibton (Suffolk) as well German abbeys of Haina (Assia Kassel) and Zehdenick (Brandenburg); the Silvacane Cistercian abbey (Provence, France) has the first refectory and its reconstruction (during the XIV century) in parallel along the side of the cloister; by contrast the Cistercian refectory of Fountains (Yorkshire, England) shows a discontinuity of disposition among different phases, from a parallel disposition to a

perpendicular placement; in Bourgogne (France) the Cistercian abbey of Fontenay (Fig.17), founded by Bernard of Clairvaux in 1118, has a regular disposition of buildings with a perpendicular refectory; in Italy the Chiaravalle Milanese and Chiaravalle della Colomba abbeys have perpendicular refectories in contrast with the disposition of Staffarda refectory (Beltramo S., 2018b).

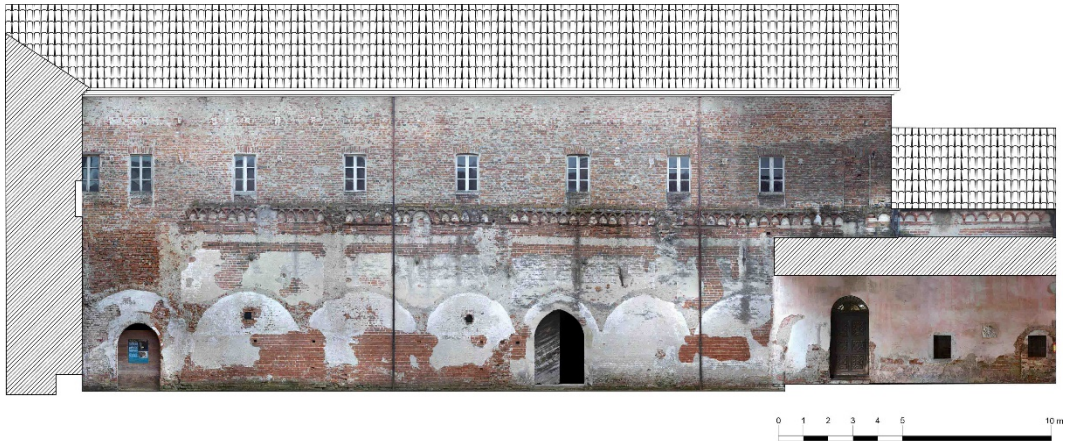

Figure 15. South front of the cloister of Staffarda abbey. Entrance portal of refectory with pointed arch (elaboration F. Diara).

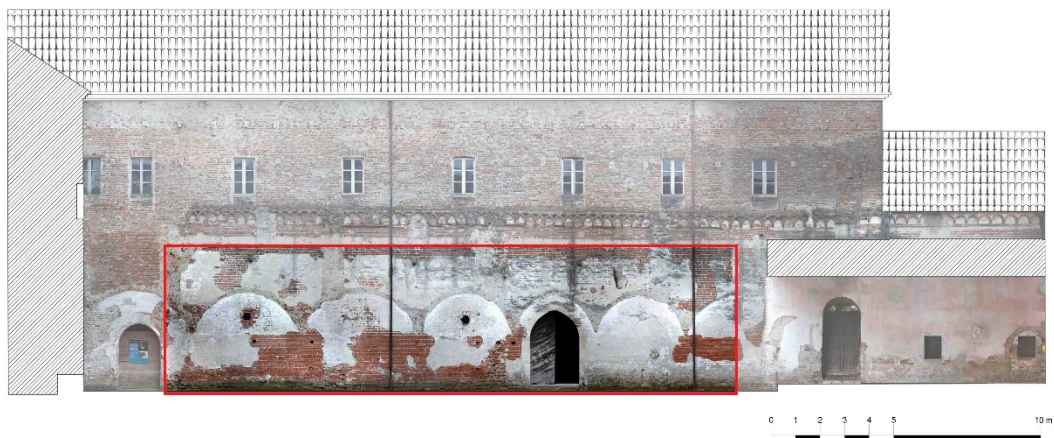

Figure 16. South front of the cloister of Staffarda abbey, red area related to the refectory (elaboration F. Diara).

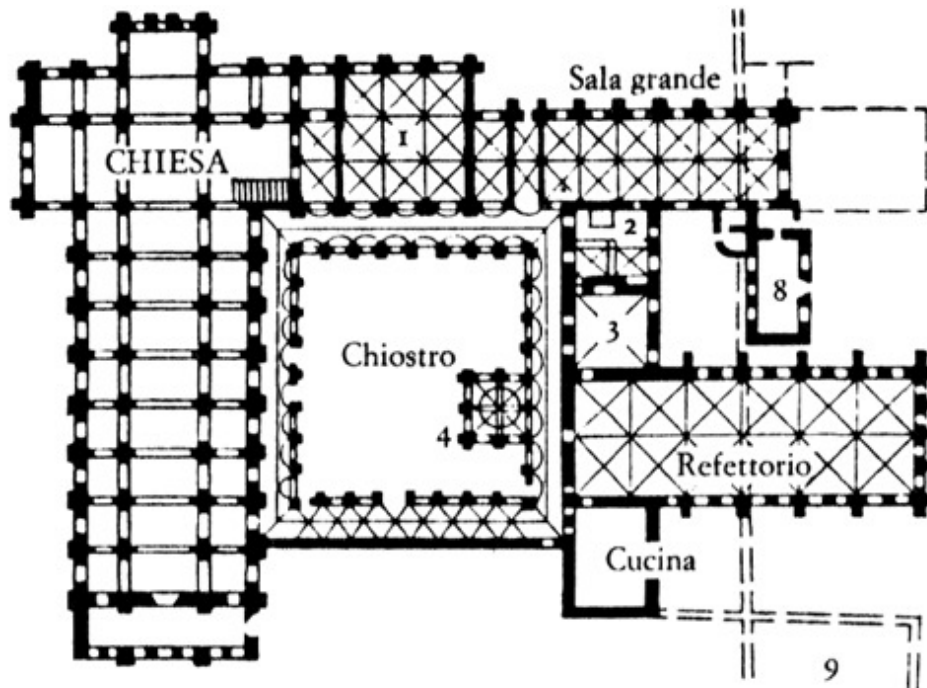

Figure 17. Ground plan of the Cistercian abbey of Fontenay (from J. Le Goff, 1964)

The Staffarda refectory is marked by several **morphological changes**, which could be noticed both in the external fronts and in the inside. An important modification is concerning the covering of the cloister gallery (*porticus*) and the internal vaulted system, rebuilt in modern times (XVIII century) by using four pillars with cross or T shape. Furthermore, different buildings of the abbey (also unused buildings), including the refectory, have been the focus of new restoration carried out between the XX and XXI centuries in order to integrate the central part of the monastery, including main chambers, for renovation and touristic purposes (Bovo P., 1999).

From the cloister the **complexity of stratigraphy** and then of chronological sequences can be perceived, in fact from a first impression different layers of masonry, plasters and lack of materials where we have to think about several historical phases.





Figure 18. APR image of the external south front of the refectory. In red rectangle the refectory area (image from M. Roggero survey)

Regarding macro architectural elements, this front shows, starting to the corner with the east side of the cloister, the old access to the *calefactorium*, two small circular windows linked to the north inner wall, the access to the refectory. Under the modern existing partial gallery can be noticed two small square windows and the wooden door related to the presence of stairs that lead to the upper floor, characterized by eight square windows. Medieval architectural elements concern also small protruding arches, which are related to the separation line among two floors, and three raw stone shelves, referred to the wooden ceiling of the gallery.



Figure 19. Protruding suspended arches on the external south front of the cloister, above the ceiling of gallery (photo F. Diara)



Figure 20. Evidences of protruding arches on the backyard side of the refectory (photo F. Diara)

The arches can be inscribed into two chronological phases: first and earlier group (Fig.19-20) is concerning protruding arches above the ceiling of the partial gallery and also arches (evidence) on the other external side of the refectory (south external front); the second later group is related to the separation line between the refectory and kitchen floor and the second floor (built during XVIII century). Moreover, the earlier protruding arches can be compared with the similar ones in the Casanova abbey as well as Romanesque religious constructions (Fig.21).



Figure 21. Casanova abbey: protruding medieval arches on the north side of the church (photo F. Diara)

The great stratigraphic complexity of the external front reverberates also internally. Going inside the refectory the architectural changes during the years become clear as well the stratification unicity, because the refectory shows the complete stratigraphy and then the presence of all architectural components of the previous phases.

As mentioned before, on the external front of the refectory there had to be a vaulted covering of the gallery which remains macro evidence (in the shape of arches) on the wall stratigraphy. Furthermore, other macro stratigraphic evidence is related to the removed buttresses and this evidence, as we will see, can be

compared and connected with the other buttresses on the external south front of the refectory.

Once inside the refectory, in addition to coming across in a clay ground (the original was supposed to be composed by bricks), can be noticed that the homogenous presence of medieval bricks on the walls is interrupted by the west wall (modern brick masonry) on the right and by new pillars and vaults (Fig.22).



Figure 22. Panoramic image from LiDAR acquisition of the inside of the refectory (1): on left the entrance portal and north wall; on right the west wall (image from M. Roggero survey)



Figure 23. Panoramic image from LiDAR acquisition of the inside of the refectory (2): on left the north wall and partially the east wall with the covered opening; on right still the north wall and partially the west wall; in the middle part of the south wall (image from M. Roggero survey)

In fact, the **west wall** is concerning the two small walls leaning on the partially covered pillar and, moreover, the west wall is leaning on south and north walls. This wall divides the original unique space of the refectory in two parts (breaking up the wall continuity), and the obtained area is itself divided in other two small chambers, accessible by a wooden door and small stairs. In addition, the dividing wall has a window with a wooden frame and a window with metal bars, on which can be noticed wooden beams. Moreover, the beam above the door and window shows an inscription “XV”, that anyway shouldn’t be considered as chronological evidence.

The **north wall** (Fig.24) shows, in addition to the entrance portal, two small square windows that correspond to the two small circular openings on the external front (the side of the cloister). In this wall there is a semi brick column with stone capital related to the other one on the south wall, and there is also, but on the small hidden chamber, a stone shelf referred to the original ceiling (Beltramo S., 2010).



Figure 24. Detail of north wall of the refectory with a suspended semi column referred to the previous ceiling and the actual vaulted system (photo F. Diara)

The **east wall** shows covered access with a curtain wall and, on the corner with the south wall, a column that probably is related to the original ceiling of the refectory. Apart from these elements, there is a ruined polychrome fresco representing the *Ultima Cena* (Fig.25), related to the first years of the XVI century (Gabrielli N., 1973) that, due to its dimension, probably stretched over the entire

wall surface. The fresco shows Jesus Christ and the evidence of apostles seated at the table on which it can be noticed food (bread) and evidence of a knife. This fresco has been covered and ruined especially due to architectural modifications inside the refectory, such as the new vaults system leaning on central pillars and on walls. Therefore, although the renovation of the ceiling the *Ultima Cena* fresco is still visible, and between 2018 and 2019 was under restoration.

From the stratigraphic point of view, under the fresco representation can be noticed the preliminary plaster (*arriccio*) related to the first preparation before applying the painting. Moreover, below of the preliminary plaster, and then below of fresco, can be noticed an earlier plaster that shows an imitation of bricks representation (Fig.26). Thus, this plaster can be referred to a previous phase of the refectory, and then before the *Ultima Cena* phase, and it might prove the simplicity in the decorations and paintings from monks.



Figure 25. East wall of the refectory: detail of the *Ultima Cena* fresco, its preliminary plaster and on the left of picture evidence of the earlier plaster that shows an imitation of bricks (photo F. Diara)



Figure 26. East wall of the refectory: detail of the earlier plaster that shows an imitation of bricks (photo F. Diara after a preliminary fresco restoration in 2019)

The **south wall** shows great stratigraphic and architectural complexity. Starting from the corner column with the east wall, can be noticed the original entrance of the pulpit with bricks stairs interrupted by a curtain wall. Then, the first phase of the refectory is visible observing the portal (with two colours triangular decorative elements) and its stairs. In modern times the pulpit has been removed and its original shape, probably funnel shape, can be observed by removing evidence on the wall; furthermore, the original opening of the pulpit has been reused in order to create a single lancet, irregular, window. In this wall, there are different evidences from the original ceiling, such as the semi brick column with stone capital (similar and specular to the one on the north wall) and also the two stone shelves, one visible in the main chamber while the other is located into the small hidden chamber just after the stairs of the west wall.

The south wall differs from the other walls for the windows density. In fact, it shows four original single lancet windows (decorated with rhomboidal lozenges) in the main chamber and one single lancet window in the separated chamber. Amongst them, just only two show the original structure and it is still opened (the hidden chamber window is included), while the others are covered or cut (in order to open

access to the south courtyard). This kind of organization of the single-lancet windows is comparable with other refectories for their placement: on longer sides of the building in order to have more external brightness (Beltramo S., 2018b). Moreover, there are three more square windows on top of previous windows, and two of them are partially cut by the new groin vault system and also filled by a curtain wall.



Figure 27. South wall of the refectory: detail of the removed pulpit and the window opened on its place; detail of the suspended semi column and a covered single lancet window (photo F. Diara)

Analysing these walls can be noticed furthermore the variety of plasters, such as the on top plasters referred to the new vaulted system, but also the original plasters especially on south and north walls.

As mentioned before, the actual ceiling of the refectory has been rebuilt in modern times (at the beginning of the XVIII century) by adopting a groin **vault system** leaning on pillars with cross or T shape (Fig.29-30). In this regard, to know the original ceiling of the refectory is a challenging thought, but analysing other coverage systems and the evidence of the refectory we could get closer to the original phase.

In fact, an interesting research topic is concerned about the ceiling and space organization of refectories. Refectories of large dimensions could have two or more



aisles space subdivision, due to the presence of columns or pillars that had to hold and dump the ceiling weight, and in this case, the ceiling solution was the adoption of groined rib vaults or with six partitions (Beltramo S., 2018b).

By contrast, refectories of small dimensions could have a single aisle, and for this reason the solution for the ceiling could be different, from the barrel vault supported by pointed arches (such as the dorm and refectory of the Real Monasterio de Santa María de Poblet, Catalogna) to wooden ceiling supported by cross arches (the dorm of Monasterio de Santa Maria de Santes Creus, Tarragona) (Beltramo S., 2018b).

Furthermore, the inner space of refectories, organized by a single (like Fossanova) or more aisles was characterized by the presence of wooden tables and seats, in order to receive monks during mealtimes, which were marked by prayers acted from the pulpit. For this reason, the pulpit was a fundamental element inside the refectories: normally, the construction of pulpit, accessible by stairs, followed the techniques used for walls (stone or brick) even if in some cases it could be built by using wood.

Regarding the **original ceiling** of Staffarda refectory, as we have seen, on the walls remain shelves and semi-columns that supported it. The actual ceiling of the refectory, as mentioned, is referred to the groined vaulted system of the XVIII century.

Moreover, the first ceiling coverage of the Staffarda refectory, thanks to recent studies, could be probably compared to the coverage of the refectory of the already mentioned Fossanova abbey: the refectory of Fossanova has the ceiling with wooden trussed roof (Fig.28) supported by diaphragm stone arches that lean on semi-columns and this solution was frequently used in refectories and nurses of monasteries in order to obtain higher and brighter spaces and for the purpose of having a steadiest ceiling (Gallotta E., 2018). Moreover, this hypothesis for the Staffarda refectory is supported by an old drawing of Cesare Bertea (between 1915 and 1925) recently discovered (Fig.31), which shows a transversal arches solution for the refectory ceiling (Beltramo S., 2018b).

As far as materials are concerned, could be briefly noticed, in addition to the bricks masonries, different layers of plasters; the *Ultima Cena* fresco and its preparation plaster; layers of render; wooden elements are referred to beams of the west internal wall, doors and a window carpentry of west internal wall; metal of the anchors and window carpentry of the west wall (close to the wooden door); stone elements of shelves and capitals and tours of column and semi columns. The material analysis of the refectory is reported on TAV.3-7-11-15-19.

The south external front of the refectory, composed by bricks masonry, is marked by the presence of the bricked up single-lancet windows and the coverage of the access to the pulpit that includes inside its wall one of the four entire buttresses. Moreover, these structural and support elements there were on the north external front, removed in later times as the covering of the cloister gallery, and some marks remain of it.

Reflecting upon analysed elements could be assumed an ever changing and slowly construction site, not only for the refectory but also for the entire Staffarda abbey establishment, because a not properly Cistercian style and different stylistic influences (such as the Lombard Romanesque) are observed.



Figure 28. Fossanova refectory and its ceiling (From E. Gallotta, 2018, photo A. Grella)

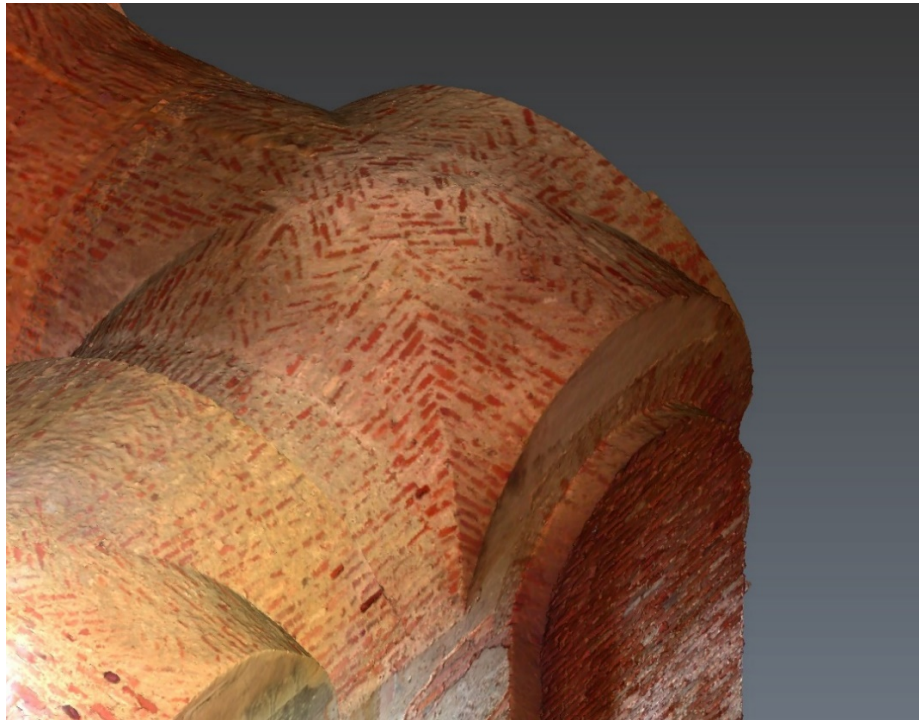

Figure 29. LiDAR point cloud of Staffarda refectory: detail of the extrados of the vaulted system (point cloud management by F. Diara)



Figure 30. LiDAR point cloud of Staffarda refectory: detail of the intrados of the vaulted system (point cloud management by F. Diara)

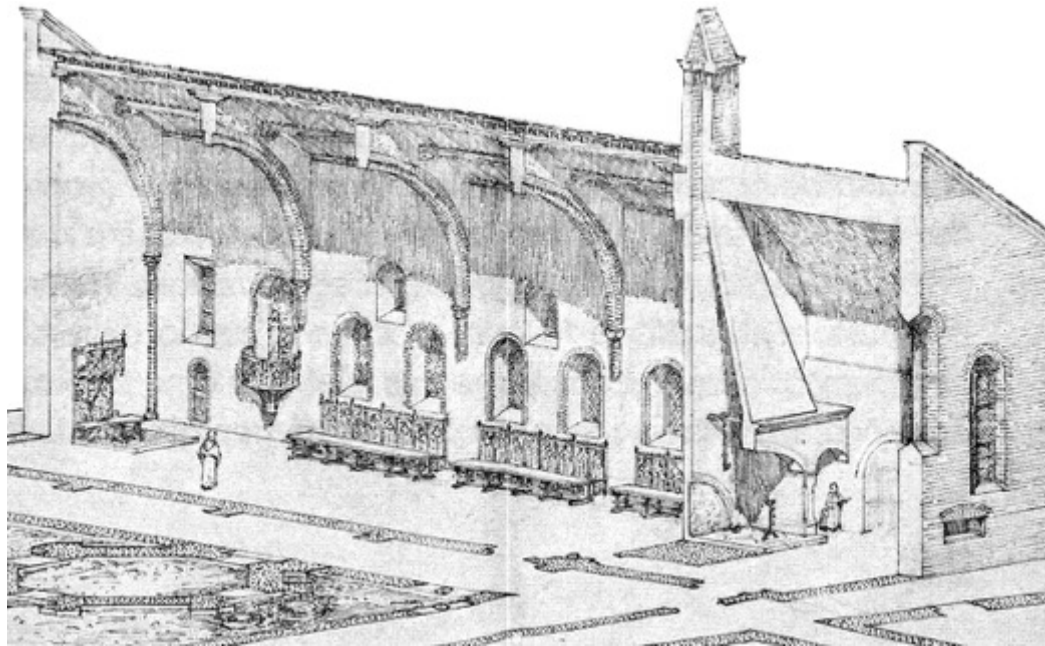

Figure 31. Staffarda refectory: drawing of Cesare Bertea (around 1920) - Cesare Bertea private archive, Pinerolo, binder 6, Miscellaneous, Restorations, Staffarda (Beltramo S., 2018a).



# Chapter 4

## Stratification and stratigraphy

### 4.1 Introduction to stratification

Stratifications are originally referred to geologic and archaeological layers, even if, as we shall see, stratifications regard also largest situations, such as historical buildings, cities, landscapes. Obviously, there are some differences between different stratifications. Indeed, unlike the geologic natural stratification, **archaeological layers** are generally the result of natural and anthropological actions as well as voluntary and involuntary actions.

These stratifications are related to specific actions: deposits or accumulation actions, erosion or destruction actions, movement or transportation actions. Given this, the stratification activity can be generated by limited or long-winded times and furthermore it could be defined as a cyclic process.

As far as the first group of actions is concerned, a deposit or accumulation action involves the presence of a layer and its interface. By contrast erosion or destruction actions have not layers but only an interface referred to this lack of material.

But what is a *layer*? It may refer to natural and / or anthropological activities and it can relate to voluntary and involuntary actions. Thus, a layer has a surface or interface (horizontal, vertical or sloping) defined by edges, it has a volume, it has a topographic position and a stratigraphic position that produces a relative position over the time (Carandini A., 1981).

The stratigraphic method, or *stratigraphy*, has its origin in geology and not in the archaeological field. However, between 70's and 80's the archaeologist **E.C. Harris** set the theoretical stages for innovative analysis, theorizing the principles based on stratigraphy and especially graphical relations among layers<sup>14</sup>.

Through his research, Harris formulated the main aspects of stratigraphy: *initial continuity, initial horizontality, overlap, stratigraphic sequence*. Moreover,

---

<sup>14</sup> Harris carried out his doctoral thesis through the book *Principles of archaeological stratigraphy* on 1979, published in Italy in 1983. During the years this book and Harris himself have experienced a great success on the international panorama of archaeology.

Harris separates three moments on the archaeological stratification: the first is the theoretical aspect of archaeological stratification; the second is referred to the documentation; the third is the interpretation and then the identification of phases.

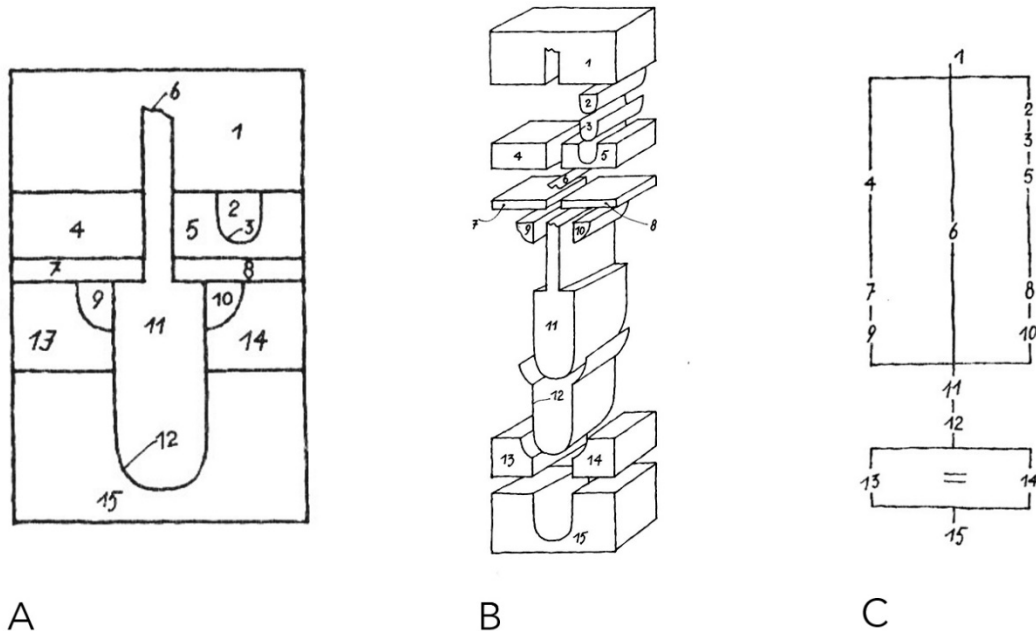

Figure 32. From archaeological section to diagram A) Archaeological section; B) disassembled axonometric projection; C) relational stratigraphic diagram (From A. Carandini 1981)

During the first moment, the application of the archaeological sequence is fundamental in order to detect stratification features like layers and interfaces. In fact, the archaeological stratigraphy is characterized by a combination of layers and interfaces. These units or layers, natural or anthropic, can be horizontal, referred to field archaeology, and vertical as concerned walls and then historical buildings. Natural and anthropic actions, corresponding to every stratigraphic unit, are referred to accumulation (positive unit), erosion or cut (negative unit), transformation (neutral unit).

Undoubtedly, the largest part of surfaces and layers undergo natural and / or artificial changes, even if it is often impossible to recognize this modification. In addition to this, these layers are generally referred to the *time* spent between their setting up and the archaeological survey (Wood J., 1994; Harris E.C., 2002).

The archaeological stratification needs to be converted into a **stratigraphic sequence**. For the purpose of understanding this sequence, and then the *time* element, the stratigraphic method allows the archaeologists to detect the relative chronological order referred to stratigraphic units. This method is based essentially

on relations between stratigraphic units: contemporary relations, such as *similar to* and *bind itself to*; sequence relations, such as *cover* and *is covered by*, *cut* and *is cut by*, *fill* and *is filled by*, *is above of* and *is below of*; no relation. In this case of no relations between stratigraphic units, the stratigrapher runs into an interpretative connection. Therefore, each stratigraphic unit can be understood and interpreted only if it is included in the relations system with other units, in order to understand if a stratigraphic unit is *earlier*, *later* or *contemporary* with another unit (Carandini A., 1981).

For the purpose of managing the physical relations of stratigraphic units, Harris in 1973 designed a stratigraphic diagram, the **matrix**, that it can be classified as a schematic diagram where is given complete details about stratigraphy. In this diagram (as we will see in the next few paragraphs) the stratigraphic relations of stratigraphic units are given by connection lines on their identification numbers. Despite all kind of relations, inside the matrix there are just three graphical and **physical relations** (Fig.33): no relation (no connection line); overlap relation (a vertical line connecting two units); equality relation (horizontal line or equal mark connecting two units) (Harris E.C., 2002).

Although the stratigraphic analysis can be defined as a schematic and a stricter method, the subjective component is strongly present and affect the historical lecture and then the chronology of the analysed context.

Stratigraphic analysis can be applied also on the multi-layered historical territory, defining, for example, territory stratigraphic units (UST), characterized by the presence of macro architectural units related to the surrounding environment. Depending on contexts (archaeology as well as historical buildings), the stratigraphic approach might change, but the necessity of detecting and analysing modifications during the time remains unchanged.

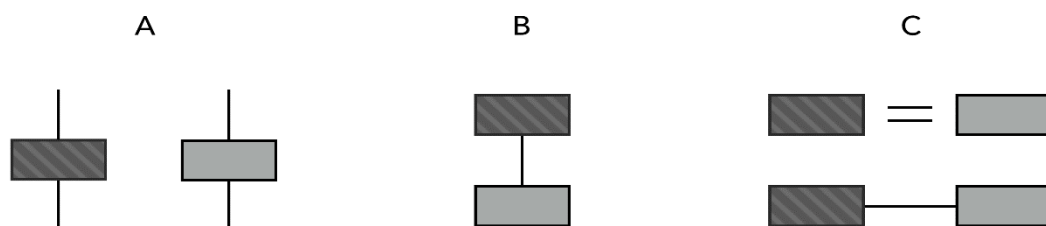

Figure 33. Three kind of physical and graphical relations between two stratigraphic units: A) No relation; B) Overlapping relation; C) units from the same deposit (edited schema From E.C. Harris 2002)



## 4.2 Buildings Archaeology

The history of buildings (buildings heritage multi-layered on space and time) influences and this impact must be increased more and more for architectural design and restoration projects. Architectural Heritage, as well as archaeological sites or landscape heritage are left-over (voluntary or involuntary) of a particular past moment that it is necessary to preserve and understand in the best way possible for their witnessing of a specific historical period, and all these heritages culturally belong to their period and represent their unique aspects. Their comprehension is especially useful to understand their social role in that period, from the smallest finds to bigger historical buildings.

The analysis of an architectural context cannot overlook the importance of the *time* element. This one is the unique element allowing buildings to change their aspects or not (for example changing shape due to styles or needs). Indeed, the *time* element established continuity or not-continuity relations, between Cultural Heritage and their historical context. For this reason, historical buildings have to be considered as a living body, which goes through modifications and suffers changing processes.

During the '70s and '80s in Italy new methodologies were applied to the knowledge of ancient buildings. This kind of analysis at the beginning has been named *stratigraphic analysis of buildings* but during the years it has been defined as **buildings archaeology**, especially because it developed its techniques inside the archaeological medieval excavations (Parenti R., 2000).

During the first experimentation of this analysis on medieval buildings remains (on archaeological sites) the complexity of stratification has been reported by the researchers (archaeologists and architects) also as usual reuse of ancient structures and buildings, and for this reason, stratigraphy has been the most suitable method in order to identify a relative chronology of construction phases (Mannoni et al., 1974).

In 1996 was born "Archeologia dell'Architettura" (Buildings Archaeology) journal and from this point have been developed the basis for the creation of an independent discipline separated from medieval archaeology. The origin of this discipline is therefore in the archaeological field, but it has been carried out, tested, performed and, as we will see, increased both from archaeologists and architects as well, especially from the Italian academic circle.

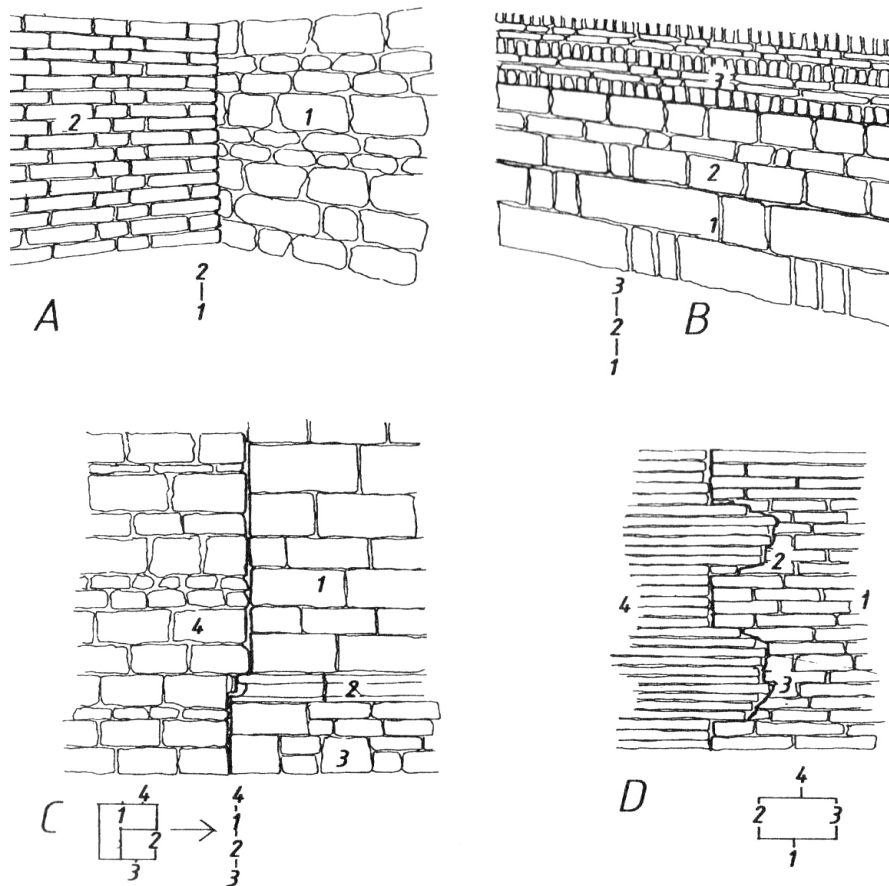

Figure 34. Stratigraphic relations between walls (From R. Parenti 1987). This image has been used as front cover of *Archeologia e restauro dei monumenti. I Ciclo di Lezioni sulla Ricerca applicata in Archeologia (Certosa di Pontignano 1987)*.

Buildings archaeology bases its methodologies on the *lecture* and analysis of the information inside walls and masonries (direct sources) and then applies the stratigraphy in order to know construction techniques and material typological classes (Gelichi S., 2002). So, the discipline base its analysis on direct sources, that are related to information that we can find directly on buildings surfaces (stratigraphy), and also on indirect sources, referred to documents not directly connected with the architectural complex, such as historical sources, iconographic sources, land registers, cartographic data (Parenti R., 1988).

Historical buildings are not generally considered as the result of a single constructive phase, quite the opposite, indeed: expansion or demolition works, reconstructions of smaller cases and also the changing of the original designated use of the building. The stratigraphic sequence of historical buildings can be extremely complex. This complexity is given by the numbers of *positive* and

*negative* units and then the number of activities on walls and fronts. Furthermore, the quantity of layers is affected by the different workers inside the construction site as well as the construction speed of a single group of workers.

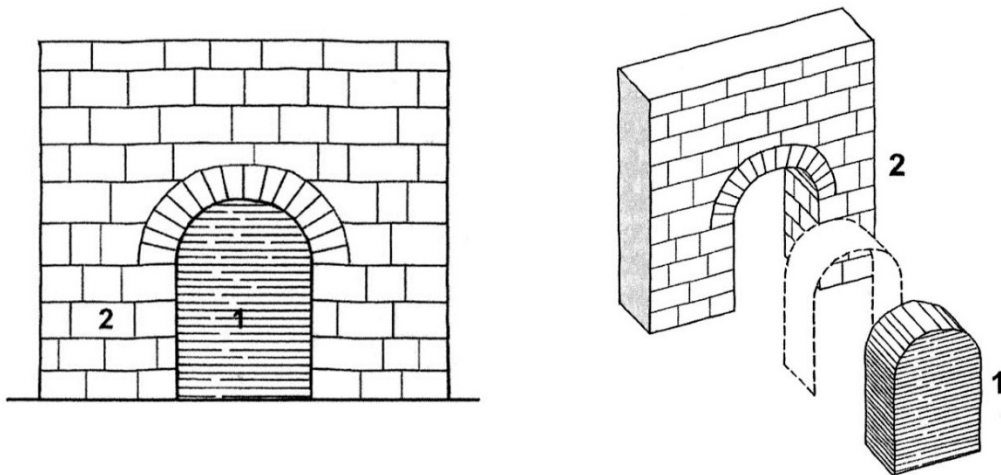

Figure 35. Detection of stratigraphic units and their edges and interfaces (From A. Boato 2008).

The stratigraphic method can be therefore applied in historical buildings or in buildings where a large part of construction phases and other interventions (such as restorations) are visible and stratigraphic units can be analysed and documented through the delimitation edges. However, building archaeology surveys include not destructive interventions otherwise from field archaeology surveys, and base its principles therefore on surface analysis, without removing stratigraphic units. It is clear that some surfaces remain hidden below other layers, for example covered by renders and plasters layers, and they cannot be investigated (Boato A., 2008).

Exactly as happens in the archaeological field, the stratigraphic units detected in a historical building have to be related to each other by using stratigraphic relations: *similar to* and *bind itself to*; sequence relations, such as *cover* and *is covered by*, *cut* and *is cut by*, *fill* and *is filled by*, *is above of* and *is below of*; no relation (Carandini A., 1981; Wood J., 1994; Harris E.C., 2002).

Using this procedure, the architectural components could be analysed for example as architecture element and the stratigraphic unit that, referred to historical buildings, could be also related to render/plaster and restoration actions; furthermore, masonry stratigraphic units should be classified as positive, negative or hidden, depending on constructive or destructive actions (Beltramo S., 2009a).

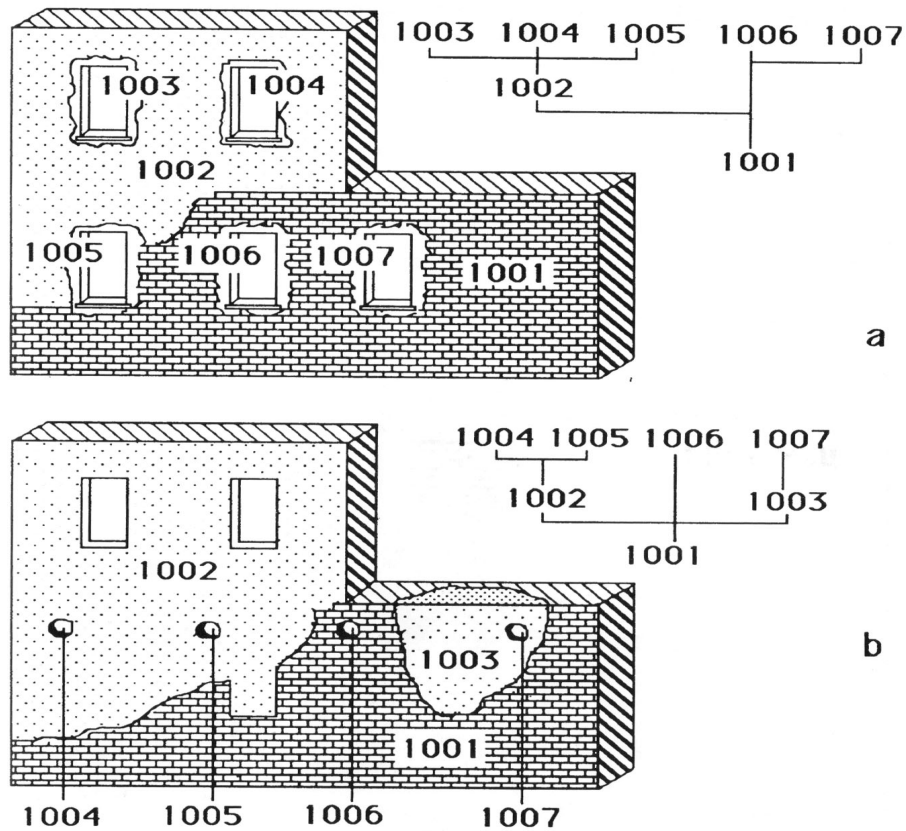

Figure 36. Not-directly equality typological relations (a) and functionality relations (b). In the first case windows experienced contemporaneity relation while in the second the contemporaneity occurred on scaffold holes (From G.P. Brogiolo 2013).

The Harris matrix has great importance in order to give graphically physical connections among units of a building: no relation (no connection line); overlap relation (a vertical line connecting two units); equality relation (horizontal line or *equal mark* connecting two units). In this sense, equality relation has to include units that have the same features: materials, production, measurements, disposition, excepting the physical continuity (Boato A., 2008). Moreover, through the matrix analysis can be defined as **historical phases and periods** related to the construction site of the building.

In this viewpoint stratigraphic analysis is a fundamental tool allowing the experts not only to create a surface map for the identification of the different chronological sequences of construction but also the progressing processes of materials transformation and degradation. This kind of reading map (or critic survey) is an important step for the comparison operation of historical building

structure with its mechanical behaviours taking into account the specific events that have changed the building static asset (Doglioni F., 1988).

Of course, the act of transferring an archaeological method to architectural fields brings with itself several comparative dynamics (relative chronology) to detect chronological phases which must be supported and refined by further accurate analyses in order to reach a specified chronology, the absolute chronology.

In this regard, the absolute chronology of a historical building has to be implemented by other analysis, such as the chronology of bricks and stone elements based on dimensions (in Italian is *mensiocronologia*), the typological chronology of openings<sup>15</sup>, the material of construction (Parenti R., 1988), material supplying<sup>16</sup> and also the workers' circulation. For these reasons, this kind of global analysis can be also defined as the archaeology of architectural production, including all the aspects and the product range (from things to human, from a committee to particular choices) that occurred in a construction site. Moreover, part of the building archaeology research is based on the analysis and detection of the building type on territory during different historical phases and the analysis of construction techniques (masonries, mortars, dimensions, coverings) (Parenti R., 1988; 1992).

An existing trend is inclined to consider individually the different aspects of the history, such as environment, ethnography, anthropology and architecture, and without communication and reference links among them. This is related to the separation of knowledge, and this separation causes a communicative gap also among different ways of thinking. However, the complete and uniform analysis of a Cultural Heritage context is given by combining this unique knowledge.

In these terms, the analysis of the entire spatial organization, where a historical building is placed is fundamental as a single investigation of architectures, in order to perform a complete analysis of construction techniques and their typological distribution in a territory (Francovich et al., 2002).

The amount of information concerning a historical building is a crucial problem: not always the stratigrapher has enough resources, such as written documentation, archives, construction and restorations reports (Brogiolo G.P., 2013). The documentation resources can be also referred to land registers, valuation registers, private documents. These data, when possible, have to be merged and

---

<sup>15</sup> In this regard, an example of typological chronology is given for pointed arches of openings of Public palace of Siena by: Gabrielli, F. (1996). *La "Cronotipologia relativa come metodo di analisi degli elevati: la facciata del palazzo Pubblico di Siena*. In *Archeologia dell'Architettura*, I, p.20-21

<sup>16</sup> In this sense, materials can be analysed in a wider geographic framework: for example, bricks can be related to reused pieces or can be referred to a kiln presence on the territory or can be referred to imported materials.

compared with another kind of information derived from above-mentioned analyses.

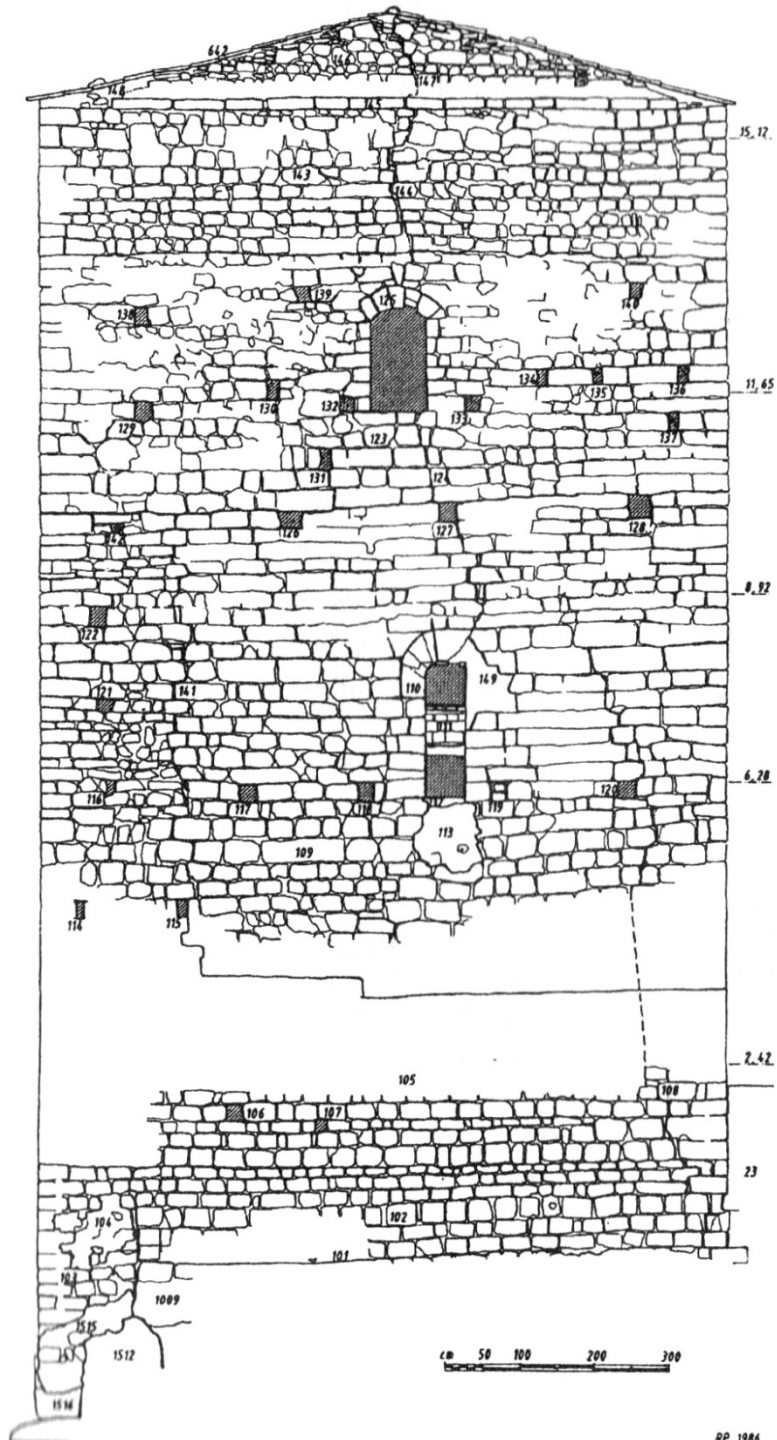
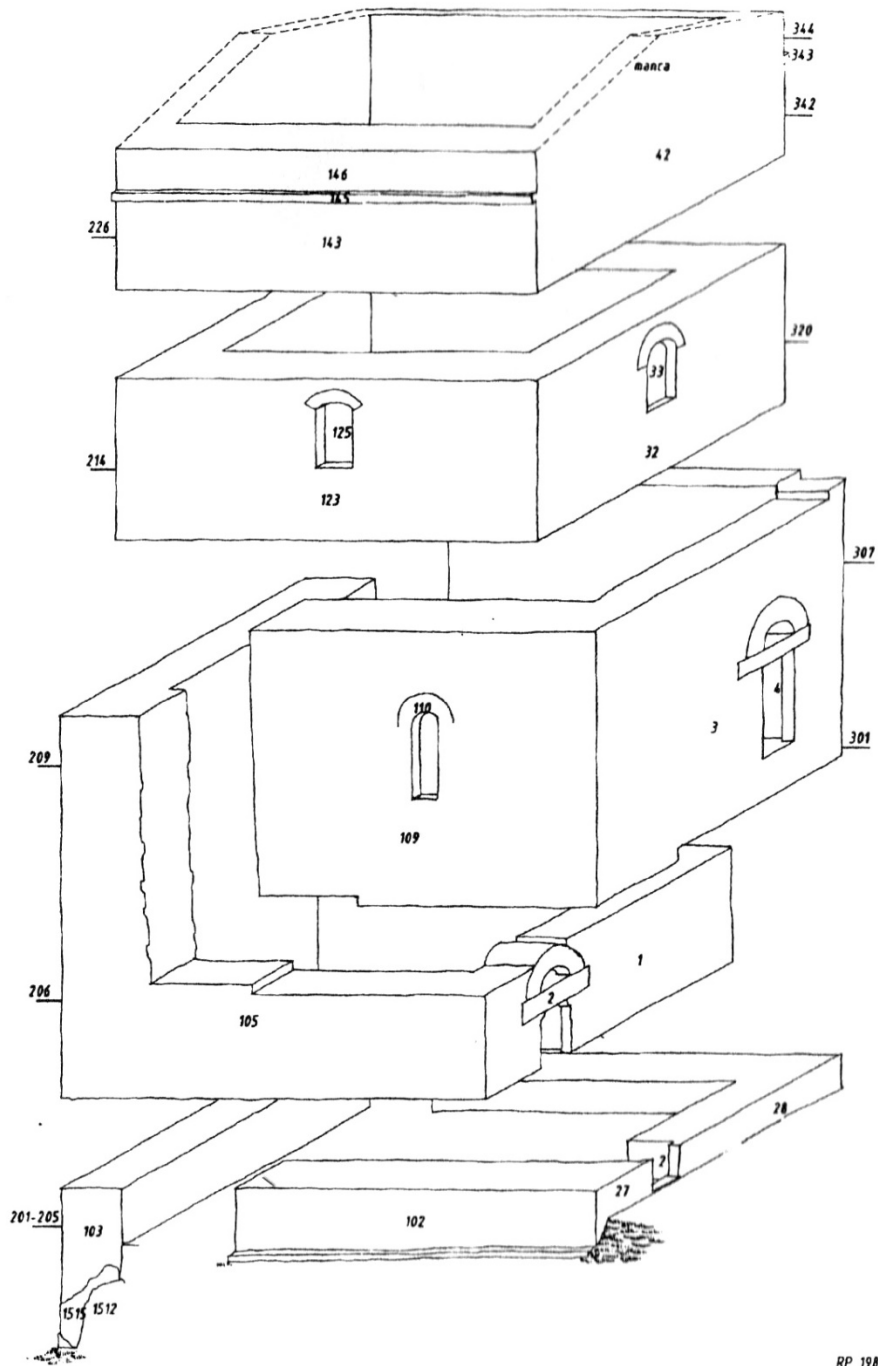
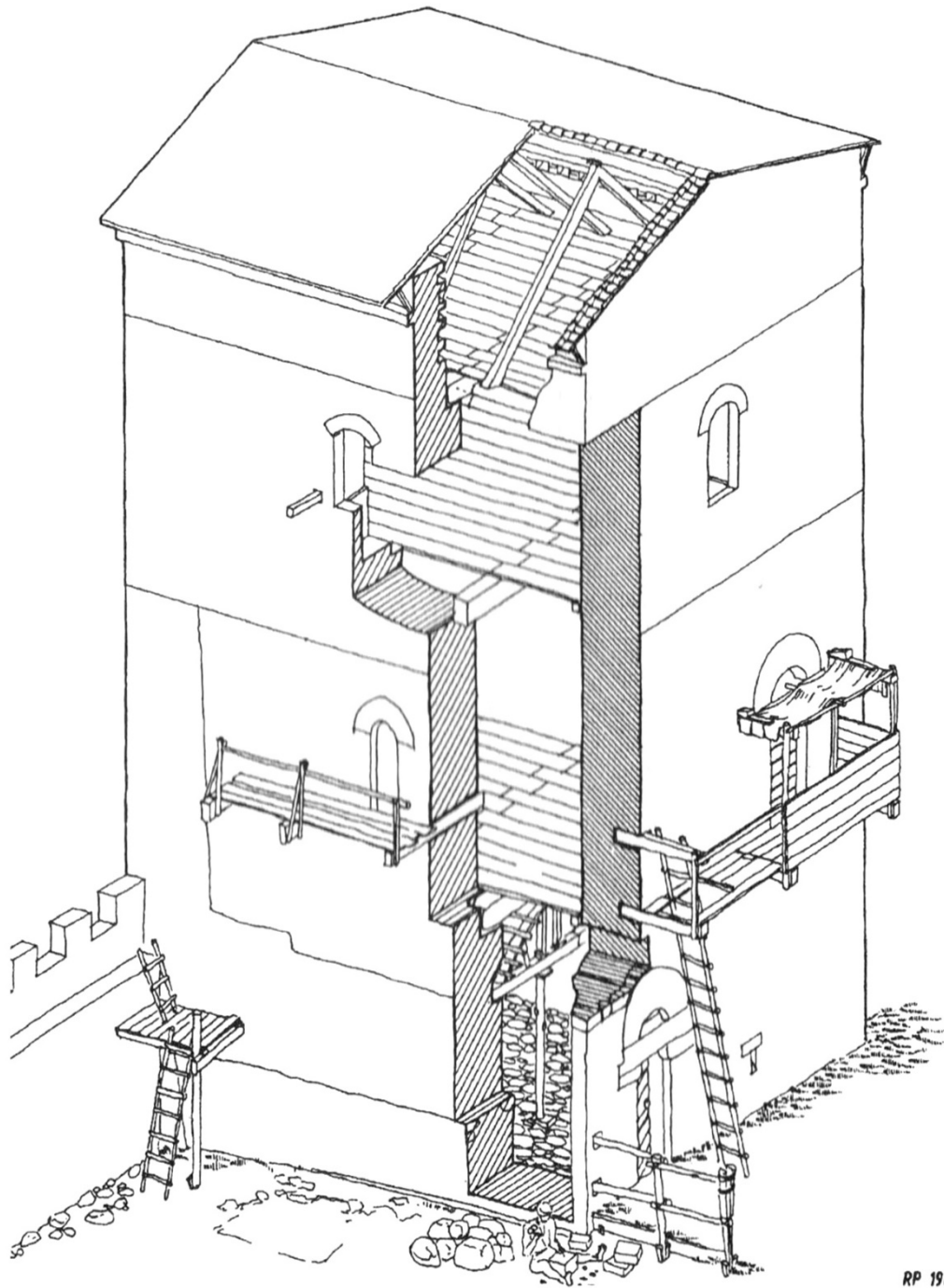

Figure 37. Stratigraphic analysis of the B Tower of Montarrenti - Siena (From R. Parenti 1986).



RP 1986

Figure 38. Graphic disassembly of construction phases of the B Tower of Montarrenti - Siena (From R. Parenti 1986).



RP 1986

Figure 39. Axonometric reconstruction of the B Tower of Montarrenti - Siena (From R. Parenti 1986).



However, the **standard classification of stratigraphic units (US)** applied to field archaeology began having limitations as regards ancient walls and masonries. For this reason, during the first years of the '80s have been developed (by R. Parenti) new instruments for the purpose of registering and document stratigraphic units related to walls and masonries, such as the classification of *masonry stratigraphic unit / unità stratigrafica muraria* (USM) and the dedicated data sheet with the stratigraphic relations<sup>17</sup>.

During the same years of buildings archaeology experiences, become also evident the necessity to define all details of a building and architectural complex for the purpose of investigating architecture history. Indeed, regarding classification, stratigraphic units related to walls and masonries aren't enough for the purpose of describing all the features of a historical building, characterized by the presence of architectural components, elevations and structures. For this reason, have been introduced other classifications and units (reference units – UR) which grant more flexibility for the documentation<sup>18</sup>.

Reference units (UR), in addition to the masonry stratigraphic unit (USM), which is one of the most detailed element of stratification, include: *architectural element* (EA); *architectural complex* (CA); *block of the building* (CF); *general elevation* (PG); *particular elevation* (PP); *horizontal structure* (SO); *functional unit* (UF)<sup>19</sup>. In this sense, the smallest component of reference units is referred to architectural element, which could be related to structural components, such as pillars, openings, arches, decorative elements. The biggest reference unit is the architectural complex, and it can be made of more blocks of buildings, which themselves can be placed leaning against other blocks or can be isolated. In addition, blocks of buildings could have general external elevations, while inside buildings might be vertical divisions (particular elevations) and horizontal divisions (horizontal structures) that might create rooms and chambers (or functional units) (Brogiolo G.P., 2013).

---

<sup>17</sup> This new kind of application has been carried out by Roberto Parenti on the stratigraphic analysis of Montarrenti (SI) tower. Parenti R., *La lettura stratigrafica delle murature in contesti archeologici e di restauro architettonico*. In: *Restauro & Città*, I, 2, 1985, pp.62-65 (Fig. 5-6-7)

<sup>18</sup> This classification (based on reference units) has been introduced in 1988 by the archaeologist Brogiolo G.P. in the first print edition of *Archeologia dell'edilizia storica*; Brogiolo G.P., *Archeologia dell'edilizia storica*, cit. p.14

<sup>19</sup> As we have seen, this panorama of classification of architectural components and stratification has been introduced in Italian language from Italian researchers and then acronyms and definitions are in Italian, even if it can be easily translated in English in order to increase the circulation and comprehension, especially because the acronyms often do not fit exactly with the English language.

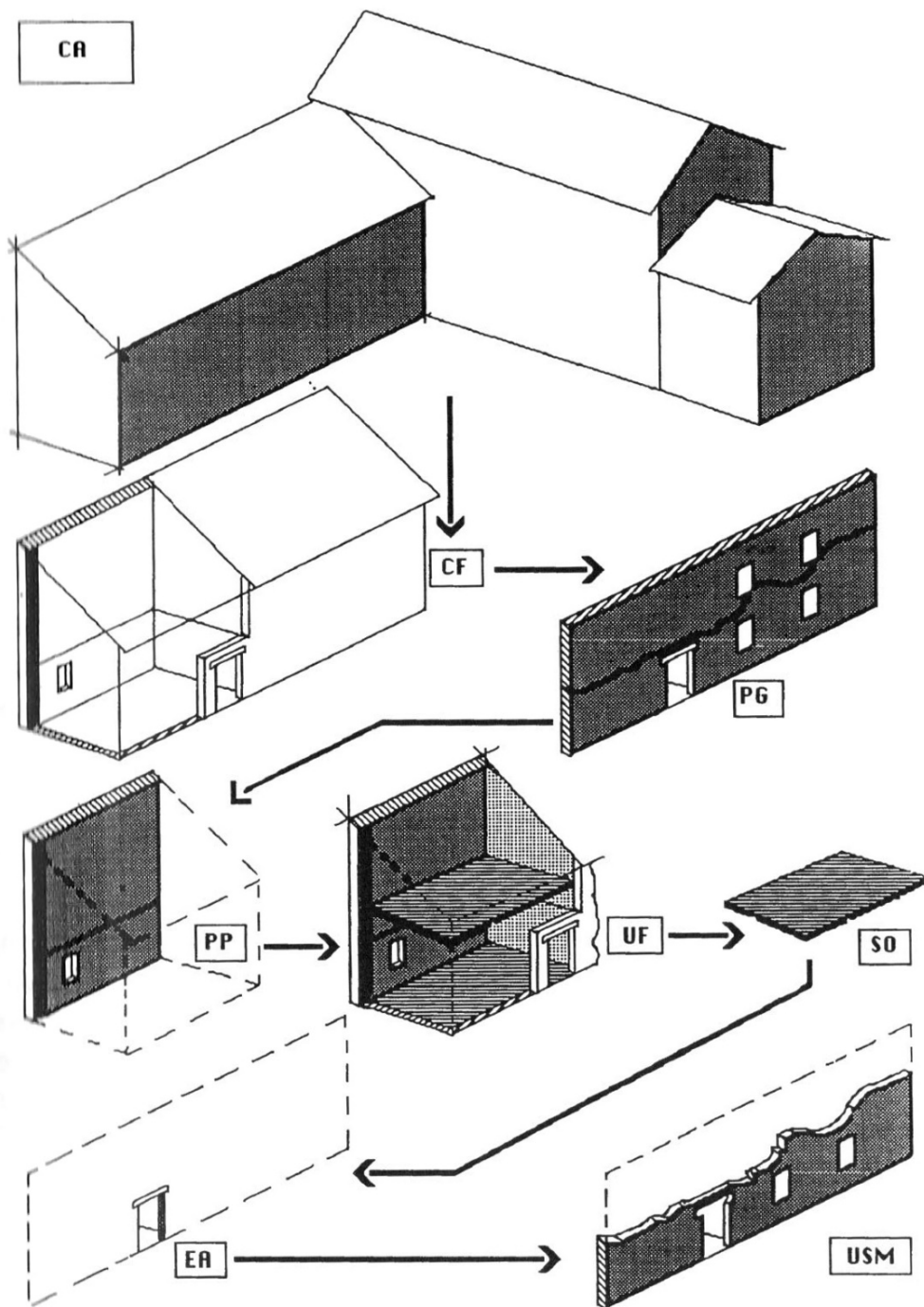

Figure 40. From reference units (CA-CF-PG-PP-UF-SO-EA) to USM (From G.P. Brogiolo 2013).

However, in addition to these reference units, it has become also evident the necessity to define renders and plasters layers of a building: in fact, another particular unit can be inscribed inside this panorama of classification and it is referred to *render / plaster stratigraphic unit* (USR) (Boato A., 2008). Renders and plasters units, that may have different thicknesses, generally cover other positive layers that become *hidden elements* (or *hidden units*) when they are totally covered.

Obviously, the choice of this classification, is depending on the level of detail of the research and on what we are interested in, from macro details (*macro-stratigraphy*) to micro details (*micro-stratigraphy*). In this sense, every research have its peculiarities and for this reasons the interpretation of stratigraphic analysis is always an ongoing topic: from the architectural point of view, *building unit* (*unità edilizia* - UE) has been introduced by C. Tosco in 2003 in order to classify the macro-stratigraphy of a building, because it identifies a homogenous part of a building made in a single construction moment. In this case too, the *building unit* may include *hidden units* or *uncertain surfaces* (Tosco C., 2003; Beltramo S., 2009).

Table 1. Acronyms and definitions of reference units

| <b>Italian ID</b> | <b>Italian definition</b>                  | <b>English meaning</b>                     |
|-------------------|--|--|
| USM               | <i>unità stratigrafica muraria</i>         | <i>masonry stratigraphic unit</i>          |
| EA                | <i>elemento architettonico</i>             | <i>architectural element</i>               |
| CA                | <i>complesso architettonico</i>            | <i>architectural complex</i>               |
| CF                | <i>corpo di fabbrica</i>                   | <i>block of the building</i>               |
| PG                | <i>prospetto generale</i>                  | <i>general elevation</i>                   |
| PP                | <i>prospetto particolare</i>               | <i>particular elevation</i>                |
| SO                | <i>struttura orizzontale</i>               | <i>horizontal structure</i>                |
| UF                | <i>unità funzionale</i>                    | <i>functional unit</i>                     |
| USR               | <i>unità stratigrafica di rivestimento</i> | <i>render / plaster stratigraphic unit</i> |
| UN                | <i>unità nascosta</i>                      | <i>hidden unit</i>                         |
| UE                | <i>unità edilizia</i>                      | <i>building unit</i>                       |

The analysis of historical architectures and buildings archaeological remains, therefore, needs a global and multidisciplinary approach for a complete consideration of architectural components and features for a wider knowledge and enhancement, preserving the past and actual positive discussion among different professional figures.

### 4.3 Documenting stratigraphy

The complexity of stratigraphic sequences involves the necessity to register, collect, manage and process a large amount of information related to different deposits, both horizontal and vertical layers. The registration and documentation (the second moment) of data shall include the collecting of numerical, alphanumeric and graphical data.

In fact, the **documentation phase** includes the numbering of each stratigraphic unit, and this numeric, or in some cases alpha-numeric, identification provides an easier classification and diversification of units during the relative chronological sequence step.

During the on-site survey or excavation, a preliminary survey report is necessary to draft-up. In this document, the archaeologist should describe how the archaeological excavation or survey is going on, perform a detailed overview of the stratigraphic units and make other particular annotations. Moreover, this information will be useful for the purpose of producing data sheets and digital database. For this purpose, stratigraphic analysis can be investigated through custom-made relational query processes, allowing the investigation and comparison between stratigraphic units. In this sense, layers and then historical evolution of sites or buildings are observed and questioned thinking about the customizable needs of the research and taking care also of final distribution data and their relationships. Moreover, the complete analysis of a Cultural Heritage context could be carried out by interacting the stratigraphic analysis with another kind of information, such as bibliographic resources, archives data, past restorations, images, and so on.

As far as graphical data is concerned, horizontal layers, after the archaeological excavation and then the identification of stratigraphic units, are generally surveyed and documented by drawing their boundaries on oriented plans and sections that show the entire archaeological section as well. By contrast, vertical layers, such as referred to the masonry of a historical building, after the detection are documented defining boundaries of each unit on architectural elevation drawings.

# Stratigraphic Units Data Sheet

Santa Maria di Staffarda Abbey – Refectory

## Information

| USM                               | USR      | USM (-)   |
|-----------------------------------|----------|---|
| /                                 | USR 45   | /   |
| Location                          | Material | Description   |
| East inner front of the refectory | Fresco   | Ultima Cena Fresco, referred to the XVI-XVII renovation |

## Stratigraphic relations

| Is above of           | Binds itself to | Fill         | Cut       | Cover                 |
|-----------------------|-----------------|--------------|-----------|-----------------------|
| 141 – 142 –<br>USR 44 |                 |              |           | 141 – 142 –<br>USR 44 |
| Is below of           | Similar to      | Is filled by | Is cut by | Is covered by         |
| USR 42 – USR 43       |                 |              |           | USR 42 – USR 43       |

## Chronological relations

| Is earlier than | Is later than   | Is contemporary with |
|-----------------|---|----------------------|
| 143 – USR 43    | USR 44 – EA 38 – 142 – 141 – 140 –<br>138 – 139 – EA 37 |                      |

## Details

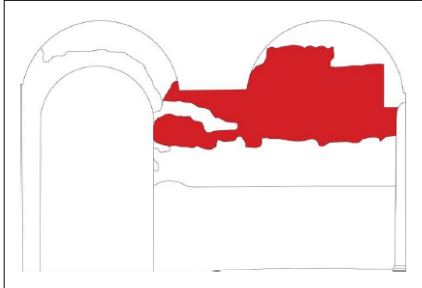
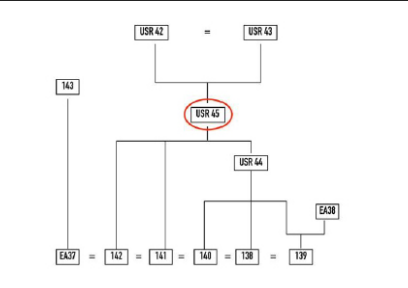
|   |  |
|---|--|
| Location map  | Matrix   |
|  |  |

Date: 17/04/2019

Compiled by: Filippo Diara

Figure 41. Example of Stratigraphic Units Data Sheet, including information, stratigraphic relations, chronological relations, details as location map and matrix (elaboration F. Diara).



Figure 42. Base equipment for a stratigraphic survey: camera, meter and notebook are fundamental

The graphical documentation should include a photographic survey for the purpose of collecting a graphic report of each stratigraphic unit and particular details and feedback concerning the sketches and notes drafted at the moment of the survey. In addition to photographic documentation must be performed a full photographic survey of layers in order to generate oriented orthophotos of the preliminary archaeological excavation / section or historical building' fronts. These orthophotos are raster images on which it is possible to read, draw up and numerate stratigraphic units and their own edges on CAD software for the purpose of having a complete 2D map of stratigraphy (Fig.43).

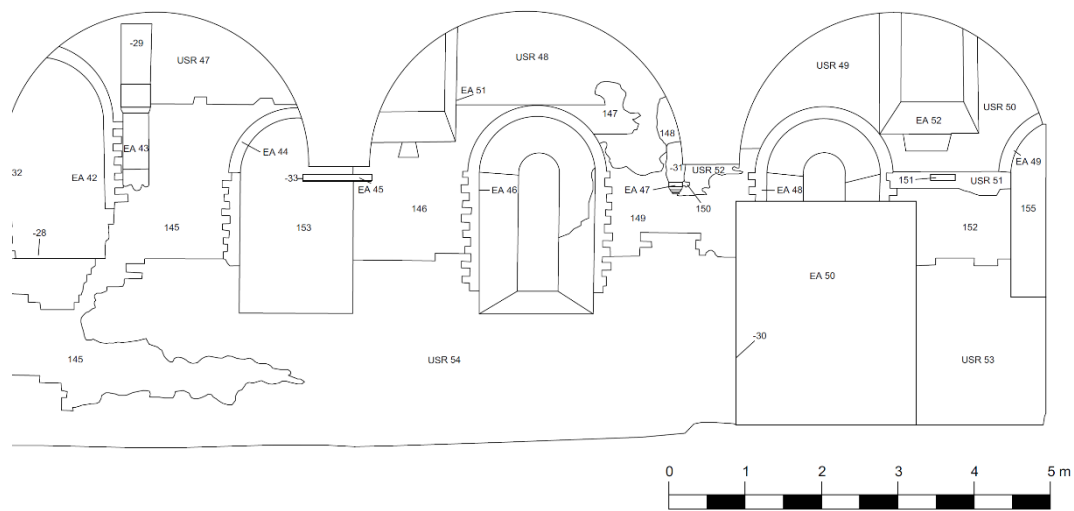

Figure 43. Example of edges drawing of stratigraphic analysis on 2D CAD (elaboration F. Diara).

In addition to 2D documentation, a three-dimensional become fundamental in the Cultural Heritage field in order to collect metric information of case studies for the purpose of reconstructing accurately the geometry of every object or building, to study it, for example, gradually in a laboratory. This kind of survey, which can be carried out by using LiDAR and photogrammetric techniques, makes it possible to transform archaeological excavations from destructive operations to ordinary non-destructive actions, because it allows to turning archaeological sites into dynamic virtual sites with high detailed stratigraphic units in 3D. In the case of walls or historical buildings damaged, for example, damaged due to an earthquake, a 3D metric survey allows to have, in addition to high resolution 3D models, all geometric and volumetric data for possible restoration and real reconstruction, allowing to map all stratifications and decay' layers.

The documentation of stratigraphy should, therefore, run in parallel with **innovative methodologies** and technologies, increasing the research possibilities. Despite the possibility of performing different analyses through these high quality reality-based models, they still remain anonymous models. Indeed, heavy 3D classical models do not contribute important information from a semantic point of view, and in th, creating a dynamic ontological model could be considered as a good methodology to operate by a multi-disciplinary critic analysis. Overcoming anonymous 3D models, stratigraphy and historical information increase their own semantic perspective in three-dimensional informative systems.

In this regards, recently has been proved that the stratigraphic method and then the information concerned stratigraphy experienced a significant application into

GIS (Geographic Information System) implementation, in fact, by using this solution, graphical and alphanumeric information (historical building stratigraphy) can be managed and compared inside a georeferenced and relational platform (Beltramo et al., 2019b). GIS solution offers fundamental sources as regards the archaeological field, allowing the spatial and geographical analysis of excavated sites, in addition to match and compare them with other contexts.

It comes natural thinking stratigraphic units of a historical architecture would be therefore innovative elements to be managed inside a BIM (Building Information Modelling) platform, where each one could be digitally linked to its architectural components and historical phases and enriched by new kind of information, such as materials, descriptions and static behaviours (Beltramo et al., 2019a).

The application of stratigraphic analysis, and then the detection of all interventions carried out on a historical building in a specific period, on HBIM (Historic BIM) project moreover makes a significant contribution to the evaluation of risk and vulnerability elements, because constructive and destructive actions would be connected as architectural components to the parametric 3D model. In fact, it is relevant to think about wall layers (USM) and plaster layers (USR) as building entities because in architectural terms these kinds of information regard masonry, wall cavity, render/plaster, decoration and other features.

#### **4.4 Interpretation: relations, phases and periods**

The third moment of archaeological stratigraphy is the **analysis and interpretation** through the identification of relations, phases and periods.

Before the introduction of Harris' Matrix (designed in 1973), generic diagrams and tables / charts have been the main method for the correlation phase. By contrast, the matrix invented by Harris allows producing a schematic diagram where is given complete details about stratigraphy.

As mentioned before, in this diagram the **stratigraphic relations** of stratigraphic units are given by connection lines on their identification numbers. Relations among units are: contemporary relations, such as *similar to* and *bind itself to*; sequence relations, such as *cover* and *is covered by*, *cut* and *is cut by*, *fill* and *is filled by*, *is above of* and *is below of*; no relation. However, relations represented inside the matrix are referred to connections among two units and these relations are three: no relation (no connection line); overlap relation (a vertical line



connecting two units); equality relation (horizontal line or *equal mark* connecting two units) (Harris E.C., 2002).

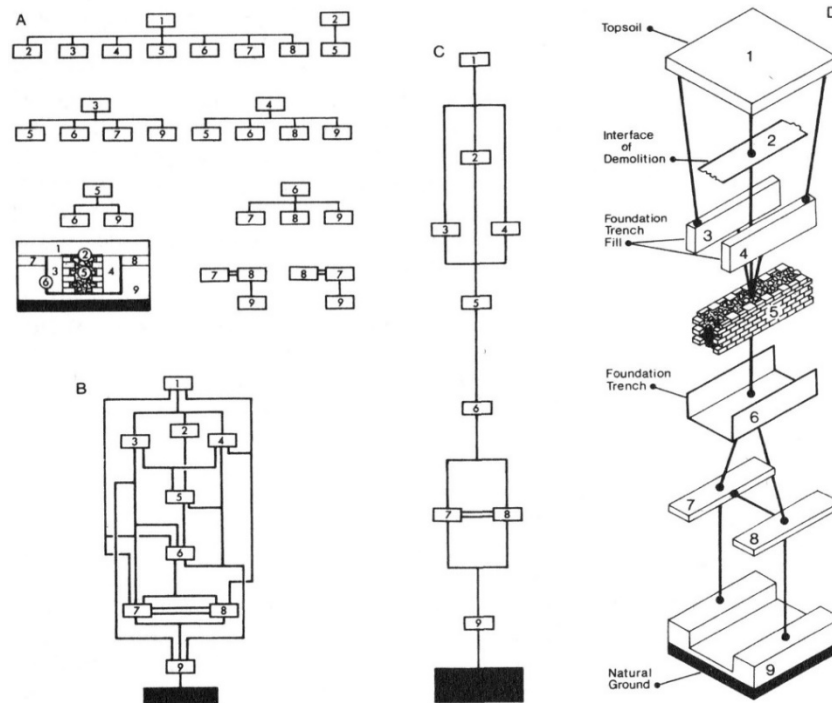

Figure 44. Stratigraphic sequence following the Harris method: a) overlapping relations; b) relations on diagram; c) stratigraphic sequence without redundant lines; d) graphical restitution (from E.C. Harris 2002)

In other words, two or more stratigraphic units can be disposed on top of each other or in a horizontal way because derived from the same deposit. These relations inside the matrix lead the stratigrapher to define the *relative chronology* of the stratigraphic sequence.

This solution is very easy to manage as far as small archaeological sites or simple walls with few units are concerned, however, it is necessary to plan accurately the entire disposition of lines (called also branches) and units, especially when the stratigrapher runs into complex archaeological sites or historical buildings, because in these cases inevitably the lines of matrix intersecting each other. For the purpose of preventing this, the stratigrapher can apply a semi-circular or rectangular *bridge* as an expedient for the readable continuity of lines. Moreover, in this phase simplification is a fundamental step as regards complex matrix and it can be carried out by collecting equal units and / or remove redundant lines.

After the analysis and construction of the archaeological sequence (relations) through the drawing up of Harris' Matrix, the stratigrapher has to run to the

identification of **phases** (or activities) and **chronological periods**. In fact, phases and periods are given by archaeological relations and then from the archaeological sequence. However, the interpretation step should be supported by the feedback on another kind of information about the excavated site or the surveyed building for the purpose of defining the *absolute chronology* of stratigraphic sequence<sup>20</sup>: this information is generally referred to known historical data, archive documents, information derived from chemical analysis of findings, comparisons with others contexts and materials. For example, as mentioned before, the absolute chronology of a historical building has to be implemented by the chronology of bricks and stone elements based on dimensions (*mensiocronologia*), the typological chronology elements and material.

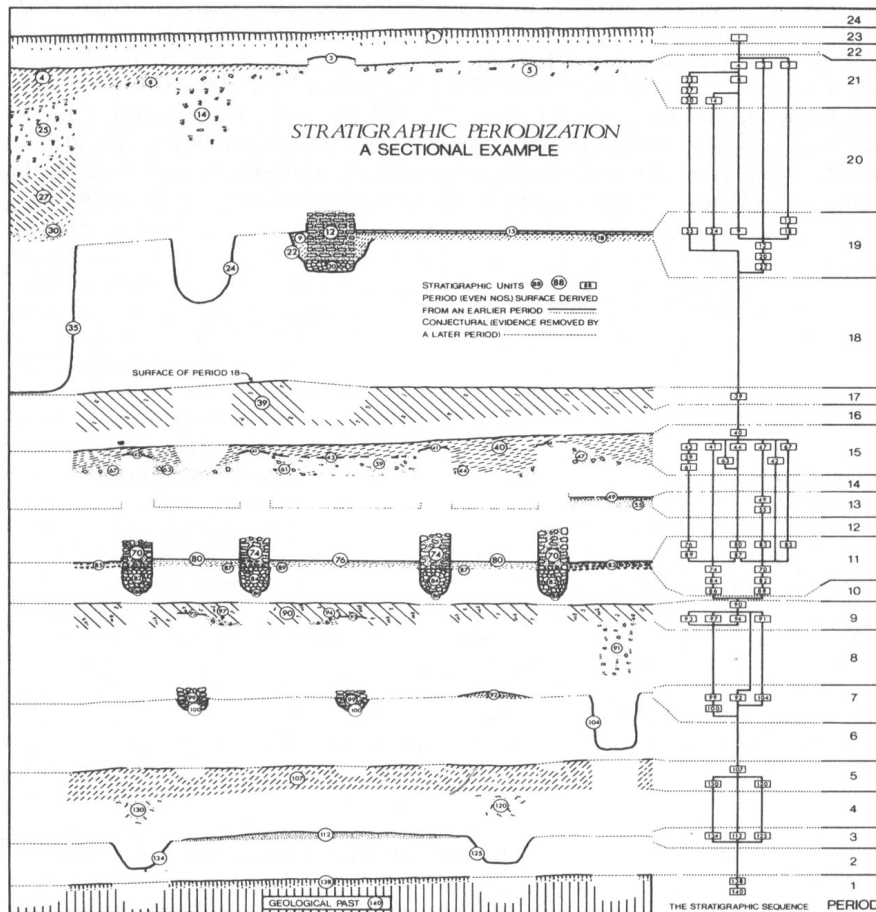

Figure 45. Archaeological section and its periods through the realization of matrix (from E.C. Harris 2002)

<sup>20</sup> Archaeological sequence can be defined as a series of materials actions, overlapped, during a relative time and for this reason it is impossible to give an absolute chronology to any actions.

## 4.5 Stratigraphy as historical information

Time element makes it possible for sites and historical buildings to not change, modify its structure due to tendencies and especially due to necessity. The time element establishes continuity and discontinuity relations between material culture and historical context, and relations can be physical and functional. Due to these relations, historical buildings cannot be analysed as a unique construction site or project, but as a sign of a long changing process, from the construction phase to modifications and reuse processes.

Every changing process should be included inside the knowledge thought. Knowledge, referred to diachronic knowledge, might be an instrument to preserve the material culture and should be considered as the sense of belonging to a particular historical moment. Stratigraphy could be therefore considered as a connection that makes more comprehensive the **knowledge process between past and present** (Carandini A., 1981; Wood J., 1994).

The analysis, as well as design and enhancement projects, should be carried out and managed through a mixture of knowledge and historical connections, in order to perform the conservation and renovation of Cultural Heritage assets, ensuring also the communication among different professional figures. Moreover, during the architectural restorations of a historical building archaeologist, architects and in general stratigrapher have to match with different problems affecting the interventions, taking care of the knowledge of the building. Architects and archaeologists have compared their own ideas and methods the first time just into the restoration research field.

In this sense, restorative and conservative operations of Cultural Heritage buildings involve the historical and objective knowledge of the context from the archaeological and architectural point of view. Meaning the knowledge as a diachronic awareness of the history of buildings should help the safeguarding processes of heritage assets.

The *architectural knowledge* or *archaeological knowledge* of a building should not depend only on the feeling of the architect who manages the restoration construction site or the archaeologist who oversee an urban excavation or a buildings archaeology survey, but should be a required approach in order to know, collect and analyse the stratification and then the construction phases and in general all the modifications occurred in a building, because they are fundamental processes of knowledge for future consolidation, conservative and restoration projects (Manacorda A., 2004). In other words, the stratification is itself a knowledge process because includes historical information that could not be found in any

archives. Like in the archaeological field do not exist artefacts and findings more important than others, as regards the data searching should not exist historical information more significant than others, and stratigraphy should have the same relevance of other sources, even if it concerns a different kind of information.

As mentioned before, building archaeology methods include not destructive interventions otherwise from field archaeology surveys. In fact, the need to know and document the historical phases, through stratigraphy, of a building shouldn't be a destructive moment and the application of the stratigraphic method to historical buildings that need consolidation, conservative and restoration projects is and should remain a common point for architects and archaeologists (Beltramo S., 2009a). Moreover, despite different methodological approaches, in addition to stratigraphic analysis, buildings archaeology and architecture history should have a common intention, investigate the history of societies that have built and used historical buildings (Pierotti et al., 2001).

In this sense, historical buildings and wall stratification have to be analysed as it appears (also evidences and remains), without removing actions, even if may conduct chemical analyses on micro sample of materials, such as mortars, plasters, stone and bricks.

The stratigraphic survey has been included into restoration preliminary analyses, in order to investigate visible surfaces and stratigraphy, as well as decay and instability events, has become part of knowledge thought of restoration projects and therefore stratigraphy should be considered a useful element for the purpose of controlling modifications affecting the authentication of a historical building (Doglioni F., 2002).

Moreover, stratigraphy as a historical information collection, and then historical memory, has to be preserved and enhanced during the **consolidation and restoration projects**, especially since every restoration intervention, even if limited and little invasive, involves physical and readability modifications (Doglioni F., 2002). Is the preservation of stratigraphy really important? Restoration projects and processes have to be cohesive with their own terminology. The restoration modern term could be compared with the *renovare* Latin word, and it was related to renovation actions, restoration actions and also to recall memories and this thought, and then the *renovation* choice principle has often been intended, arbitrarily, for the antiquity value of an artefact (Romeo E., 2016).

Stratigraphy, as well as every past evidence, has the capacity to recall human memories, because what the stratigrapher analyses are past human choices, social behaviours, techniques, art and architectural style, and in general *stories from walls*. In this sense, as regards reuse and restoration dynamics, experts should move into

conservative and critic thought in order to analyse carefully Cultural Heritage assets and also to communicate and preserve it, keeping its value, for the next generations.

Having analysed all these features, we can argue that stratigraphy could be considered also **a way of thinking**, in order to trace, analyse and preserve past information, and it can be applied to several topics and disciplines, from field archaeology to buildings archaeology, from architecture history to restoration field.

# Chapter 5

## Metric survey of Staffarda refectory

### 5.1 Metric survey background

Metric survey is a fundamental process of objective knowledge for Cultural Heritage assets, allowing the documentation of complex geometries and radiometric information (detecting reality as it is) in order to represent, communicate and to support monitoring and restoration operations, because it increases the awareness of historical buildings.

The right **knowledge** of the site framework is necessary for the purpose of planning in the best way possible the metric survey and consequently in order to organize and manage the needed instruments (Rinaudo F., 2011a). In this sense, the preliminary organization is fundamental for the optimization of the on-field work and for the project in general (quality of data). Furthermore, Cultural Heritage assets require to be surveyed with a sufficient level of accuracy depending on specific predetermined needs.

Metric survey includes operations, analysis and of course measurements for the purpose of increasing documentation and awareness of a Cultural Heritage context, for instance structural and constructive features, allowing to detect reality as it is. Managing metric data is a key element to pass to the next step: investigations towards the purpose of creating a model (reality-based model) from a point cloud recorded about a real object.

This kind of survey could be carried out using different approaches, such as **LiDAR** (Light Detection and Ranging or Laser Imaging Detection and Ranging, then survey technique based on terrestrial or aerial laser scanner) and **photogrammetry** (close-range and/or UAV), in addition to the topographic survey. These surveys are considered reality-based techniques, which are concerned with passive and active sensors methods.

Passive sensors are based on captured ambient light and then based on *images* (Remondino et al., 2006). So, passive sensors are generally referred to photogrammetric techniques. The photogrammetric method applied to Cultural Heritage has experienced in the last years an enormous growth. Photogrammetry

(close-range and UAV) is a technique that allows to obtain metric information, and then the geometric reconstruction of objects, starting from images and for this reason is based on photographic sensors (Remondino F., 2011). Photogrammetry is therefore a method that allows the stereoscopic reconstruction of objects using a couple of pictures or more (taken from different points of view).

The quality of a photogrammetric survey depends on the images (pictures quality in terms of resolution), and also many subjective and objective factors affect it, like the technical capabilities of the operator, shadows, reflexions, reverb and others issues, unlike the laser scanner that has optimum performance both day and night (ambient light), then without illumination. Innovation in computer science and photographic field has encouraged the development of technologies applied to photogrammetry, allowing the software development for different aims (low cost and high cost) (Remondino F., 2011; Diara F., 2013; 2014).

Active sensors are based on electromagnetic signals (infrared, X rays) captured by the instrument in order to detect metric information (Remondino F., 2011). For these characteristics, laser scanner is a *range-based* technique. Laser scanner survey, included in the LiDAR technique, has performed a great success in the last years, especially because it represents a versatile solution concerning big data acquisition, such as information of complex architectures. Actually, there are three kinds of terrestrial laser scanner (TLS): triangulation based (for terrestrial application); time of flight (terrestrial and aerial); phase comparison (Remondino F., 2011).

The scanner has the laser that, with a light beam (radiation beam) formed by photons: touching materials, the radiation beam could perform different behaviours: it is partly absorbed by the same material and partly reflected and relayed, moreover, the single point, touching the intercepted surface, is defined in a reference system where its origin is at the machine heart, with specific x, y, z, coordinates (Bornaz L., 2006; Bartolucci D., 2009).

In this way a scan provides to collect the necessary metric information to document and reconstruct objects and environments. Despite the principal quality of the laser scanner is the acquisition speed, the ability to manage a large amount of information derived from a laser scanner survey is still an outstanding problem and the ability to reproduce high quality 3D models depends directly on software and processor power development.



Figure 46. Laser Scanner Faro Focus 3D S120 (from Faro web site)

In fact, the result of the laser scanner is a **point clouds** or DSM (Dense Surface Model), and for each point of the model the X, Y, Z coordinates, reflectivity and radiometric values are known (Bornaz et al., 2004; Rinaudo F., 2007). In other words, point clouds are referred to a dense union of points in a 3D spatial distribution, and, after a 3D metric survey, the obtained point clouds of the object, with associated these important values, can be used to create the “as-built” 3D model (reality-based) (Rinaudo F., 2007). However, this kind of data has to be managed carefully, especially because point clouds are arbitrary acquisition and then a critical and interpretation thought is required (Bornaz et al., 2004).

Then, these surveying techniques have specific features, advantages and disadvantages depending on what we need to measure and reconstruct, but especially depending on the research needs. Nevertheless, a 3D survey can be performed by integrating and combining two or more methods, especially for the purpose of taking advantages of a specific method and also try to overcome disadvantages of other techniques (Remondino F., 2011). These integrations are referred to interesting combinations of range based and image-based techniques, such as TLS and photogrammetry approach, but also image-based UAV survey and TLS (Chiabrando et al., 2013; Spanò et al., 2018).

The **topographic survey**, in combination with laser scanner or photogrammetry, is fundamental because it provides to have a unique reference



system for the entire surveying mission, acquiring and processing measures from vertices picked on site by the surveyor (Rinaudo F., 2007). The topographic survey is generally performed by using the total station. The total station (*range-based techniques*) is an electronic instrument designed for precision metric surveys: it allows to collect (in digital data sheets) measurements of angles (azimuth and zenith) and distances of surveyed site. This instrument is the result of the improvement and refinement of mechanical-optic theodolites with distances meters. The use of target points (placed on site to be surveying) combined with the usage of a total station provides additional checks on the geometric quality of the following scan data, and these targets could lead to data voids. In addition to target points, natural points, such as of architectural details, could be used as control points.

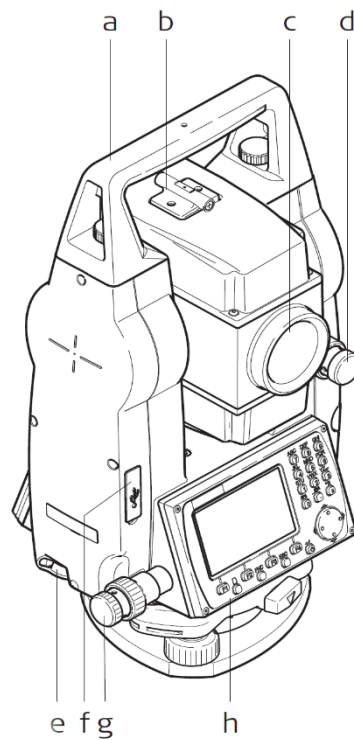

Figure 47. Geomax Zoom 30 Pro total station hardware information (1): a) handle; b) optical sight; c) lens with distances meter; d) vertical drive; e) serial interface; f) USB host port; g) horizontal drive; h) second keyboard

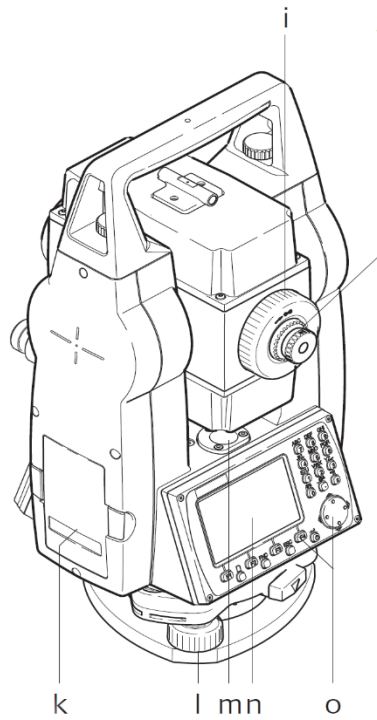

Figure 48. Geomax Zoom 30 Pro total station hardware information (2): i) focusing telescope image; j) eyepiece – focusing graticule; k) battery cover; l) foot screw; m) circular level; n) display; o) keyboard

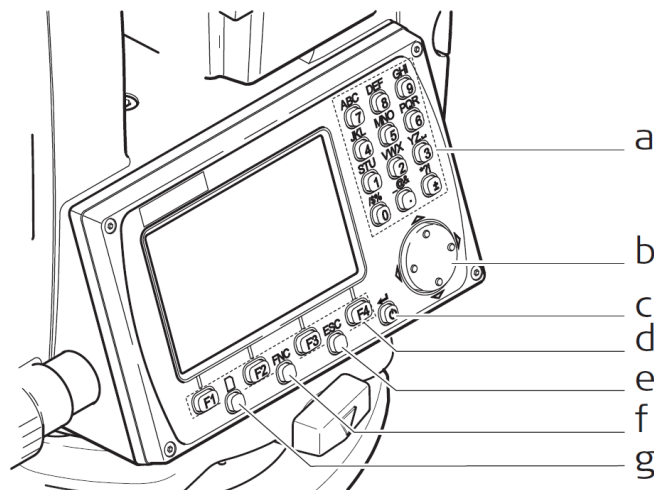

Figure 49. Geomax Zoom 30 Pro total station hardware information (3): a) alphanumerical keyboard; b) navigation key; c) ENTER key; d) Function keys; e) ESC key; f) FNC key; g) PAGE key

## 5.2 Topographic framework of the refectory

The topographic framework of the Staffarda refectory has been performed using total station **Geomax Zoom 30 Pro** and it started by acquiring natural point (P) inside the cloister in order to connect these registered points with other topographic surveys carried out on Staffarda abbey in previous years (2011).

| GEOMAX                      |   | Dati tecnici                                     |                                       | Zoom   222    |            |            |
|-----------------------------|---|--|---------------------------------------|---------------|------------|------------|
| <b>14 Dati tecnici</b>      |   |  |                                       |               |            |            |
| <b>14.1 Misura angolare</b> |   |  |                                       |               |            |            |
| <b>Precisione</b>           | <b>Precisioni angolari disponibili</b>                          | <b>S Deviazione Standard Hz, VA, ISO 17123-3</b> | <b>Risoluzione di visualizzazione</b> |               |            |            |
|                             |   |  | <b>["]</b>                            | <b>[mgon]</b> | <b>["]</b> | <b>[°]</b> |
|                             | 2   | 0.6  | 1                                     | 0.0001        | 0.1        | 0.01       |
|                             | 3   | 1.0  | 1                                     | 0.0001        | 0.1        | 0.01       |
|                             | 5   | 1.5  | 1                                     | 0.0001        | 0.1        | 0.01       |
| 7                           | 2   | 1  | 0.0001                                | 0.1           | 0.01       |            |
| <b>Caratteristiche</b>      | Assoluta, continua, diametrale. Aggiornamento ogni 0.1 - 0.3 s. |  |                                       |               |            |            |

Figure 50. Geomax Zoom 30 Pro technical information concerning angles measurements

| GEOMAX  |                                 | Dati tecnici   |             | Zoom   228   |             |   |             |
|---|---------------------------------|--|-------------|--|-------------|---|-------------|
| <b>14.4 Misura di Distanza con Prisma (Lunga Portata)</b> |                                 |  |             |  |             |   |             |
| <b>Portata</b>  | <b>A2, A4, A6, (con prisma)</b> | <b>Portata A</b>   |             | <b>Portata B</b>   |             | <b>Portata C</b>  |             |
|   |                                 | <b>[m]</b>   | <b>[ft]</b> | <b>[m]</b>   | <b>[ft]</b> | <b>[m]</b>  | <b>[ft]</b> |
|   | Prisma Standard                 | 2200   | 7300        | 7500   | 24600       | >10000  | >33000      |
| R Foglio Riflettente 60 mm x 60 mm                        | 600                             | 2000   | 1000        | 3300   | 1300        | 4200  |             |
| <b>Condizioni atmosferiche</b>                            |                                 | Portata A: Densa foschia, visibilità 5 km; o intensa luce solare, grande riverbero |             | Portata B: Leggera foschia, visibilità di circa 20 km; o moderata luce solare, lieve riverbero |             | Portata C: Coperto, assenza di foschia, visibilità di circa 40 km; assenza di riverbero |             |
|   |                                 | Campo di misura: Da 1000 m a 12000 m   |             | Visualizzazione senza ambiguità: Fino a 12 km  |             |   |             |

Figure 51. Geomax Zoom 30 Pro technical information concerning distances

Then, the 2018 topographic survey has been prefigured as an update topographic framework but focusing on the refectory.

The first step was placing the total station on a previous vertex on a corner of the fountain of the cloister, where the same vertex was on the 2011 survey. Then V\_A was the total station spike position name and the instrumental height was 1.627 m and have been surveyed 10 natural points around the external sides of the cloister excluding the south side (the refectory front): these points are referred to architectural components and elements corner, easy to detect (Tab.2 and Fig.55-56-57-58).

The second step, performed not modifying the total station spike position and height, was the points acquisition on the south side of the cloister (the refectory front) using printed black and white target (T) from 1 to 10.

Table 2. Topographic survey: natural points and their position

| <b>NATURAL POINTS</b> | <b>PLACEMENT</b>                   |
|-----------------------|------------------------------------|
| from 1 to 3           | west side of the cloister          |
| from 4 to 6           | north side of the cloister         |
| from 7 to 10          | east side of the cloister          |
| from 30 to 38         | upper south front of the refectory |

The next step was the total station shifting towards the internal part of the refectory. Indeed, has been surveyed a point inside the refectory, named R\_100, by using a prism with 1.682 m of height. After this operation total station was moved and putted into this referred point (R\_100) and then was registered the external point on the cloister by using a prism (V\_A1).

After this operation the total station, now inside the refectory was ready to register target placed into internal walls (target from 11 to 19). However, the internal topographic survey effected limitations due to the restoration scaffolding for the *Ultima Cena* fresco (Fig.60). Moreover, were registered four topographic points (target from 20 to 23) also in the first dark chamber, just after the stairs.

As the final step, moving the total station to the external courtyard (south front of the refectory) have been acquired target points on the south front (target from 24

to 29) and also natural points on the corner of upper windows (from 30 to 38) in order to have a complete coverage of topographic points (Tab.3 and Fig.59).

After the topographic survey, the registered points using total station have been converted in Cartesian coordinates by using Star-Net software<sup>21</sup>.

Table 3. Topographic survey: targets and their position

| TARGETS       | PLACEMENT                          |
|---------------|------------------------------------|
| from 1 to 10  | south front of the cloister        |
| from 11 to 23 | inside the refectory               |
| from 24 to 29 | lower south front of the refectory |

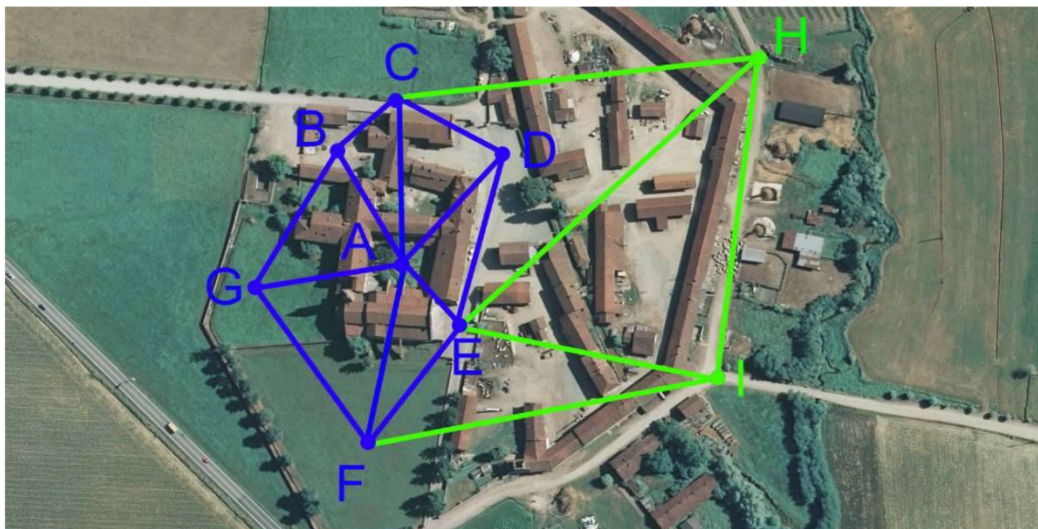

Figure 52. Topographic network of Staffarda abbey – 2011 (from Chiabrando F., Spanò A. 2011)

<sup>21</sup> <http://www.surveysoft.it/Starnet.html>



Figure 53. Topographic vertex on cloister – 2011 (from Chiambrando F., Spanò A. 2011)

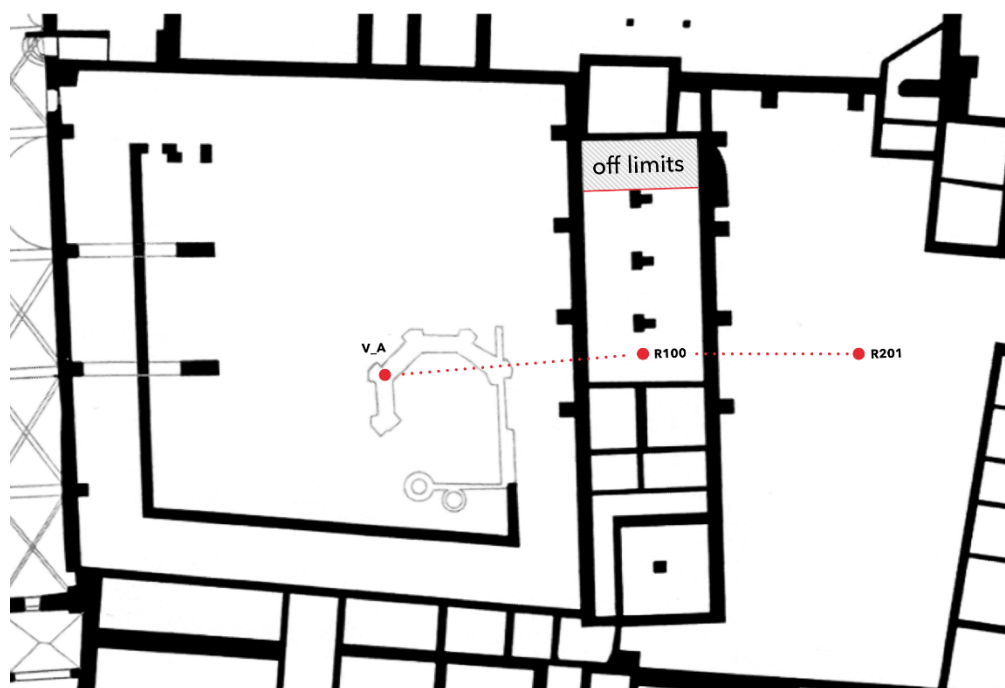

Figure 54. Topographic framework of the refectory (2018)

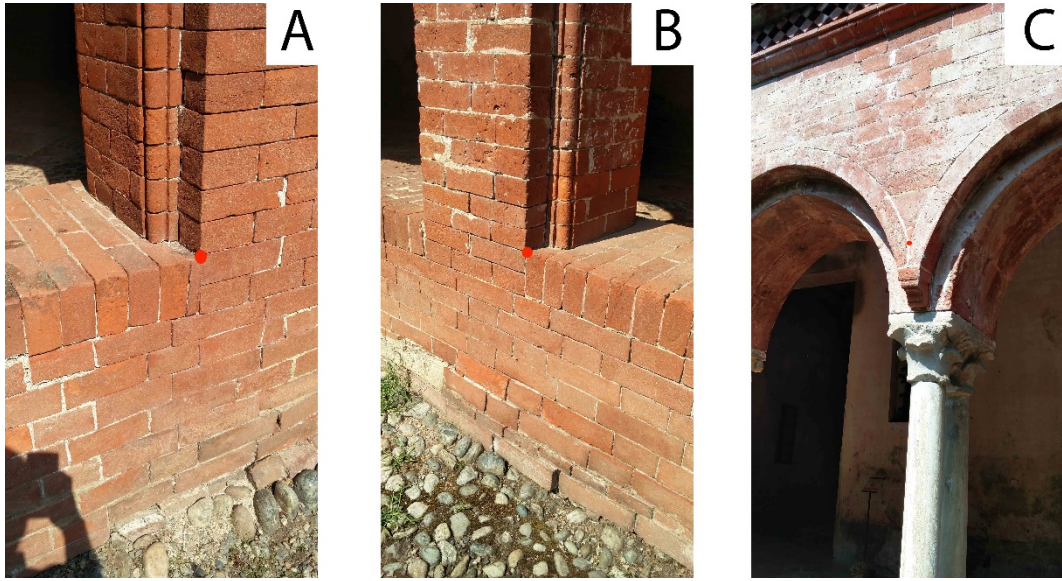

Figure 55. Natural points (red circle) registered on the cloister (1): A) point 1; B) point 2; C) point 3



Figure 56. Natural points (red circle) registered on the cloister (2): D) point 4; E) point 5; F) point 6



Figure 57. Natural points (red circle) registered on the cloister (3): G) point 7; H) point 8; I) point 9; L) point 10

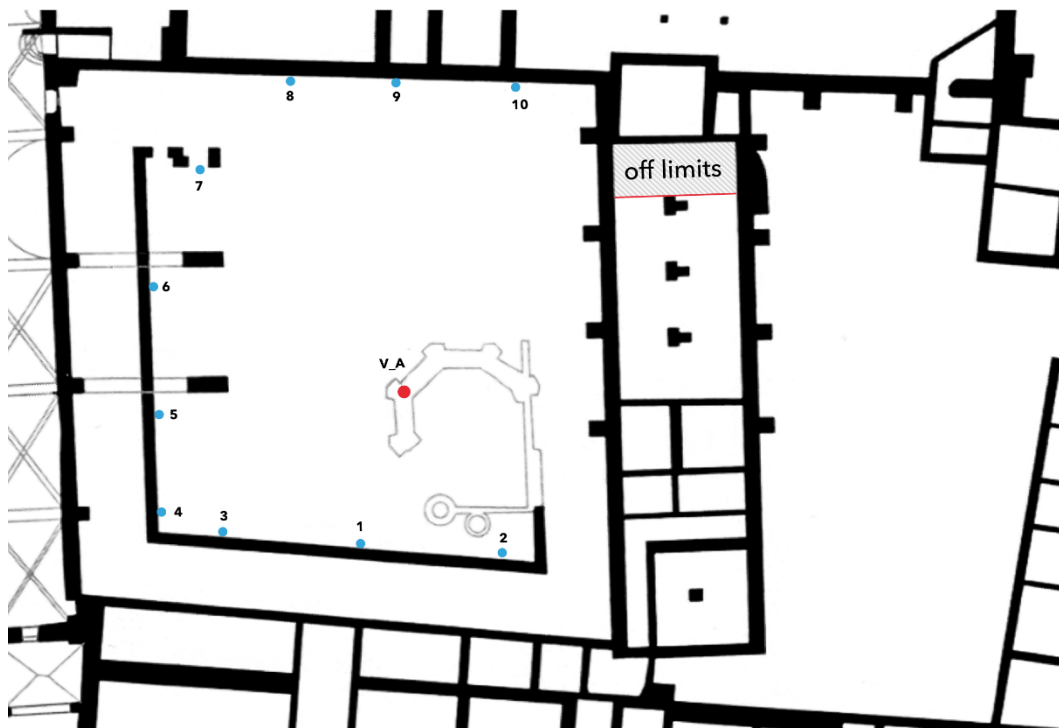

Figure 58. Topographic survey: natural points placement, from 1 to 10, inside the cloister





Figure 59. Topographic survey: targets from T1 to T10 on the south front of the cloister



Figure 60. Topographic survey: targets placement, from 11 to 23, inside the refectory

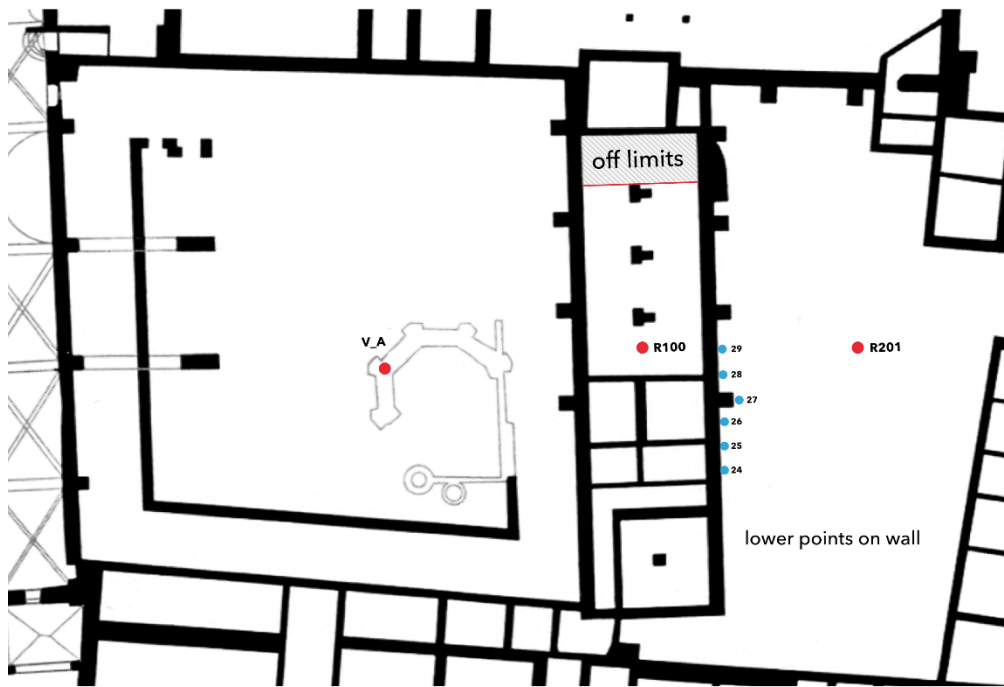

Figure 61. Topographic survey: lower target from 24 to 29, on the southern external front

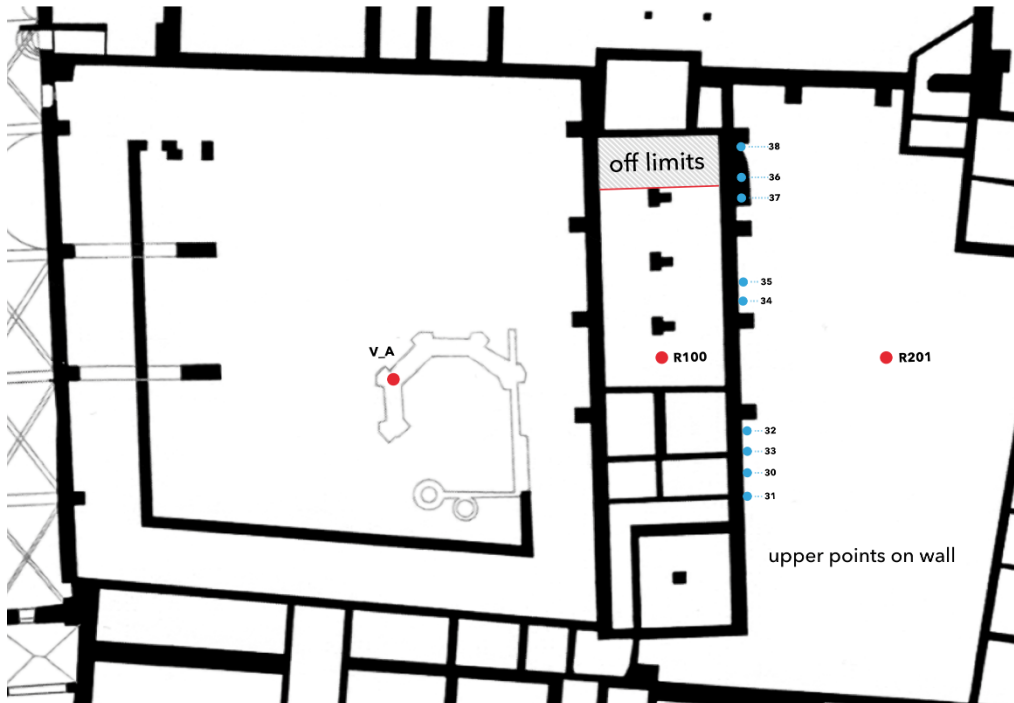

Figure 62. Topographic survey: natural upper points from 31 to 38, on the southern external front

|      |             |             |         |
|------|-------------|-------------|---------|
| PV_A | 1376253.883 | 4953172.384 | 265.774 |
| PP1  | 1376243.580 | 4953176.556 | 266.756 |
| PP2  | 1376241.981 | 4953168.478 | 266.741 |
| PP3  | 1376244.643 | 4953182.094 | 268.415 |
| PP4  | 1376246.390 | 4953189.827 | 266.768 |
| PP5  | 1376251.073 | 4953189.324 | 268.404 |
| PP6  | 1376261.147 | 4953188.371 | 268.453 |
| PP8  | 1376275.646 | 4953176.284 | 268.462 |
| PP9  | 1376274.523 | 4953167.394 | 268.079 |
| PP10 | 1376273.449 | 4953159.564 | 267.770 |

Figure 63. Cartesian coordinates (X-Y-Z) of natural points registered on the cloister

| Punto | Azimut    | Distanza | DX      | DY      | X           | Y           | Q       |
|-------|-----------|----------|---------|---------|-------------|-------------|---------|
| DV_A  | 324.48152 |          |         |         | 1376253.883 | 4953172.384 | 265.774 |
| T1    | 148.86071 | 21.247   | 15.290  | -14.753 | 1376269.173 | 4953157.631 | 268.345 |
| T2    | 158.02827 | 18.284   | 11.200  | -14.452 | 1376265.083 | 4953157.932 | 266.771 |
| T3    | 169.37689 | 15.940   | 7.375   | -14.131 | 1376261.258 | 4953158.253 | 268.188 |
| T4    | 178.29684 | 14.821   | 4.955   | -13.968 | 1376258.838 | 4953158.416 | 266.634 |
| T5    | 185.45817 | 14.179   | 3.211   | -13.811 | 1376257.094 | 4953158.573 | 268.270 |
| T6    | 205.23299 | 13.528   | -1.111  | -13.483 | 1376252.772 | 4953158.901 | 267.888 |
| T7    | 215.35599 | 13.715   | -3.276  | -13.318 | 1376250.607 | 4953159.066 | 268.530 |
| T8    | 230.07187 | 14.701   | -6.689  | -13.091 | 1376247.194 | 4953159.293 | 267.469 |
| T9    | 242.92561 | 16.409   | -10.245 | -12.818 | 1376243.638 | 4953159.566 | 268.146 |
| T10   | 258.44367 | 20.409   | -16.213 | -12.396 | 1376237.670 | 4953159.988 | 267.732 |
| DR100 | 201.15319 | 20.952   | -0.380  | -20.949 | 1376253.503 | 4953151.435 | 266.390 |
| DR201 | 11.53811  |          |         |         | 1376251.015 | 4953137.858 | 266.642 |
| T24   | 343.85142 | 18.995   | -14.664 | 12.073  | 1376236.351 | 4953149.931 | 268.378 |
| T25   | 359.70071 | 14.443   | -8.544  | 11.645  | 1376242.471 | 4953149.503 | 268.493 |
| T26   | 364.70709 | 13.594   | -7.156  | 11.558  | 1376243.859 | 4953149.416 | 267.519 |
| T27   | 387.38866 | 10.315   | -2.030  | 10.113  | 1376248.985 | 4953147.971 | 267.887 |
| T28   | 8.45548   | 11.011   | 1.458   | 10.914  | 1376252.473 | 4953148.772 | 268.043 |
| T29   | 14.05505  | 11.101   | 2.431   | 10.832  | 1376253.446 | 4953148.690 | 269.193 |
| T30   | 356.34066 | 15.101   | -9.563  | 11.687  | 1376241.452 | 4953149.545 | 274.612 |
| T31   | 359.27232 | 14.467   | -8.637  | 11.606  | 1376242.378 | 4953149.464 | 272.862 |
| T32   | 367.34990 | 13.163   | -6.459  | 11.469  | 1376244.556 | 4953149.327 | 274.598 |
| T33   | 371.14316 | 12.659   | -5.544  | 11.380  | 1376245.471 | 4953149.238 | 272.834 |
| T34   | 48.31576  | 14.113   | 9.712   | 10.240  | 1376260.727 | 4953148.098 | 275.434 |
| T35   | 53.29372  | 15.113   | 11.225  | 10.120  | 1376262.240 | 4953147.978 | 272.927 |
| T36   | 61.25473  | 17.316   | 14.207  | 9.900   | 1376265.222 | 4953147.758 | 275.436 |
| T37   | 64.52110  | 18.512   | 15.711  | 9.791   | 1376266.726 | 4953147.649 | 275.438 |
| T38   | 69.06526  | 20.572   | 18.191  | 9.608   | 1376269.206 | 4953147.466 | 275.453 |

Figure 64. Cartesian coordinates, azimuth angle and distances of target and natural points (from 30 to 38) registered inside the refectory and on the south external front

### 5.3 LiDAR acquisition of the refectory

The laser scanner methodology has been chosen for this survey because it represents a versatile solution for big data acquisition, for example a large amount of metric and geometric information of complex architectures, and this solution was the most appropriate for the Staffarda refectory.

The Staffarda refectory was surveyed using a terrestrial laser scanner (TLS) **Faro Focus 3D S120**. Faro Focus 3D S120 is one of the most compact and lightest in circulation, and it thought for indoor and outdoor applications. It can register up to 976.000 points per second and radiometric (RGB) values as well, due to the presence of 70 megapixels camera. Furthermore, this scanner detects points up to 120 meters.

LiDAR acquisitions, performed on the 24 of July of 2018, were planned for the purpose of covering the entire refectory, including the external fronts: the north front that overlooks the cloister and the south front looking out onto the backyard of the Staffarda restaurant. In total were performed twelve scans, of which three of them were executed for each external front, so in total six external scans (Tab.4 and Fig.68).

The laser scanner Focus 3D resolution has been set up to high (1/4) with 4x speed, which permits to acquire 122 kpt (kilo points) per second.

A couple of internal scans have experienced some disturbs elements, such as the restoration scaffolding for the *Ultima Cena* fresco (Fig.66 and 68), light reflections and reverbs from the openings.

Moreover, two scans were carried out into dark chambers of the refectory and were acquired points cloud without radiometric information; this detail has not compromised metric survey, because the main goal was to acquire metric information and geometric shapes and surfaces in order to create the parametric model. However, a future LiDAR survey in these chambers could be relevant for the orthophoto generation (with radiometric information) for the stratigraphic analysis, merging this historical analysis with the main one performed inside the Refectory.

In addition to these issues, some trees in the south external front have caused the loss of scan information regarding the building, even as these metric gaps have been integrated by terrestrial and aerial photographs.

All these scans have been integrated with others eight LiDAR acquisitions made inside the refectory in 2017 (Tab.4 and Fig.67), and in that period the restoration scaffolding wasn't there so the east wall was acquired without any disturb elements. Indeed, these scans have proved fundamental for their integrity

and coverage inside the refectory, as much as the light reflections and reverbs from the openings remains.

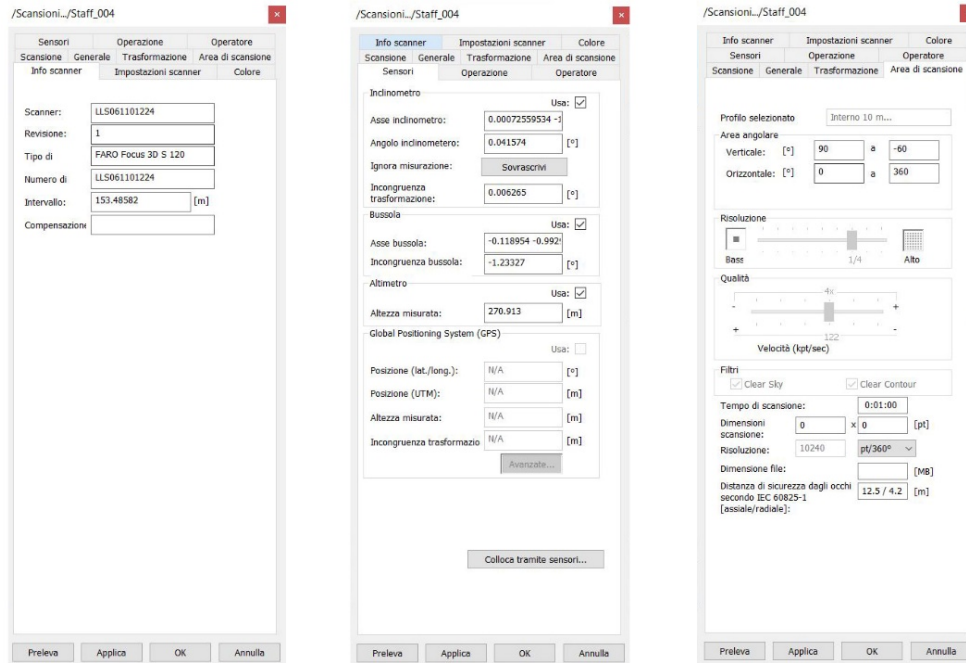

Figure 65. Faro Focus 3D S120 survey detail on Scene software



Figure 66. Image of north-east corner of the inner part of the refectory. On the right (east wall) can be noticed the restoration scaffolding (photo F. Diara)

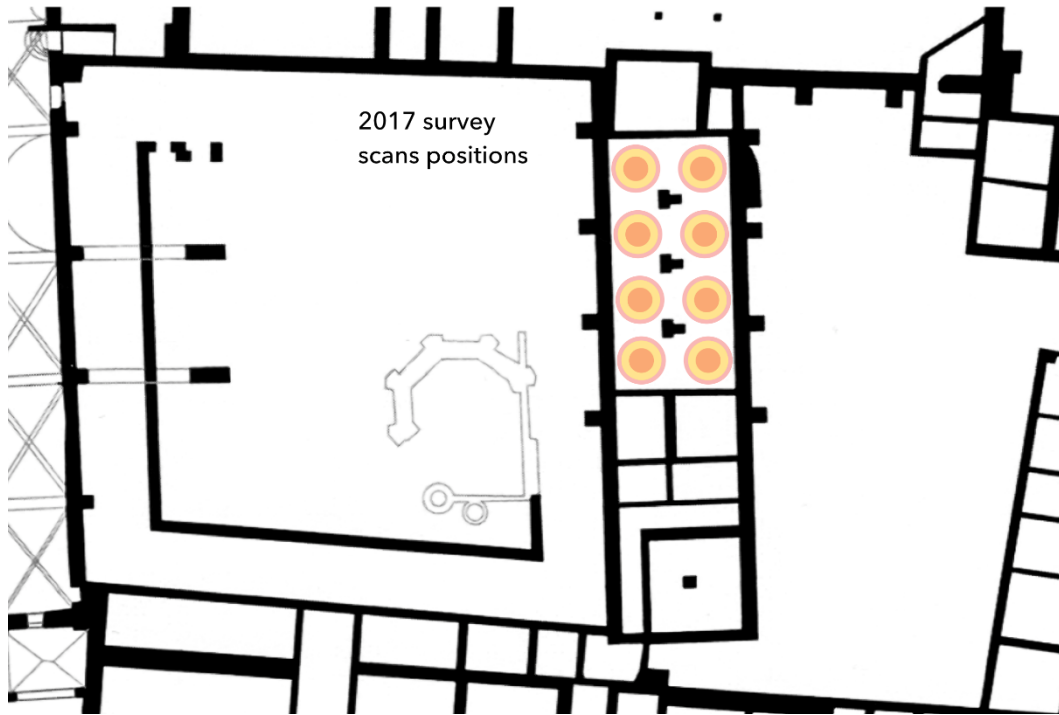

Figure 67. LiDAR survey in 2017: laser scanner placement inside the refectory



Figure 68. LiDAR survey in 2017: laser scanner placement inside the refectory



Figure 69. Laser scanner Faro Focus 3D S120 inside the refectory (photo F. Diara)

In addition to register and document metric information, this kind of survey of Staffarda refectory has allowed identifying and understand particular structure and dynamics didn't appeared at the time of the survey. For example, in the south external area a big tree covered a brick buttress, related to the others on the same front and also on the north front (but just for the marks on stratigraphy). In fact, metric data could help the complete analysis of the historical evolution of the refectory, trying to understand how this construction and evolution are placing inside the Staffarda complex.

Table 4. Name and identification of 2017 and 2018 scans inside Scene software

| <b>2017 scans</b> | <b>2018 scans</b> |
|-------------------|-------------------|
| Ref_scan_018      | Staff_000         |
| Ref_scan_019      | Staff_001         |
| Ref_scan_022      | Staff_002         |
| Ref_scan_023      | Staff_003         |
| Ref_scan_024      | Staff_004         |
| Ref_scan_025      | Staff_005         |
| Ref_scan_026      | Staff_006         |
| Ref_scan_027      | Staff_007         |
|                   | Staff_008         |
|                   | Staff_009         |
|                   | Staff_010         |
|                   | Staff_011         |

Managing metric data (point clouds), by using Faro Scene software, is the first point to pass to the next analysis: the creation of the reality-based model and also the parametric model of the refectory. In this regard, only the modelling and segmentation of shapes, geometries, and the other building components, by considering the previously acquired metric data, allow the creation of the 3D model. For this reason, the level of detail that it is necessary to generate by considering the goal of the work (e.g. quantity and quality of the data to be connected, kind of analysis to be performed, etc.), strongly influences the complexity of the model.





Figure 70. Panoramic image from laser scanner: Staffarda cloister



Figure 71. Panoramic image from laser scanner (2018 survey): inside the refectory



Figure 72. Panoramic image from laser scanner (2017 survey): inside the refectory



Figure 73. Panoramic image from laser scanner (2018 survey): inside the refectory



Figure 74. Panoramic image from laser scanner (2018 survey): inside the dark chamber



Figure 75. Panoramic image from laser scanner (2018 survey): south front of the refectory



# Chapter 6

## Data processing and management

The 3D metric survey has produced metric and three-dimensional data that have to be managed in order to extract the needed information derived from a critical interpretation (Bornaz et al., 2004), mind also the levels of detail that influence the research analysis.

As has been mentioned in the previous chapter, the result of the laser recording phase is a point cloud having X, Y, Z coordinates and radiometric values. So, point clouds are referred to a dense union of 3D points in a 3D spatial distribution. In this sense, point clouds are the real *bones framework* (raw data) and they are fundamental to build reality-based models, NURBS models and parametric models as well.

LiDAR acquisitions of the Staffarda refectory, 8 scans from the 2017 survey and 12 scans from the 2018 survey, were managed using different software for different steps of **data processing**. For this project, these are the used software for data processing step:

- *Faro Scene*<sup>22</sup> for points clouds registration and alignment;
- *3D Reshaper*<sup>23</sup> for points clouds cleaning, filtering operations, mesh generation for reality-based model and planar sections extraction.

### 6.1 Point clouds registration and alignment

**FARO Scene** software has been thought and designed for the purpose of managing Faro laser scanner data. It includes automatic objects detecting, point clouds registration and alignment.

Moreover, FARO Scene software, in addition to process and manage scan data by using registration and positioning, permits to perform simple measurements, to

---

<sup>22</sup> <https://www.faro.com/products/construction-bim-cim/faro-scene/features/>

<sup>23</sup> <https://www.3dreshaper.com/en/>

incorporate radiometric information into point clouds, permit to export point clouds and CAD objects and, moreover, it allows users to experience and evaluate captured data in the VR environment.

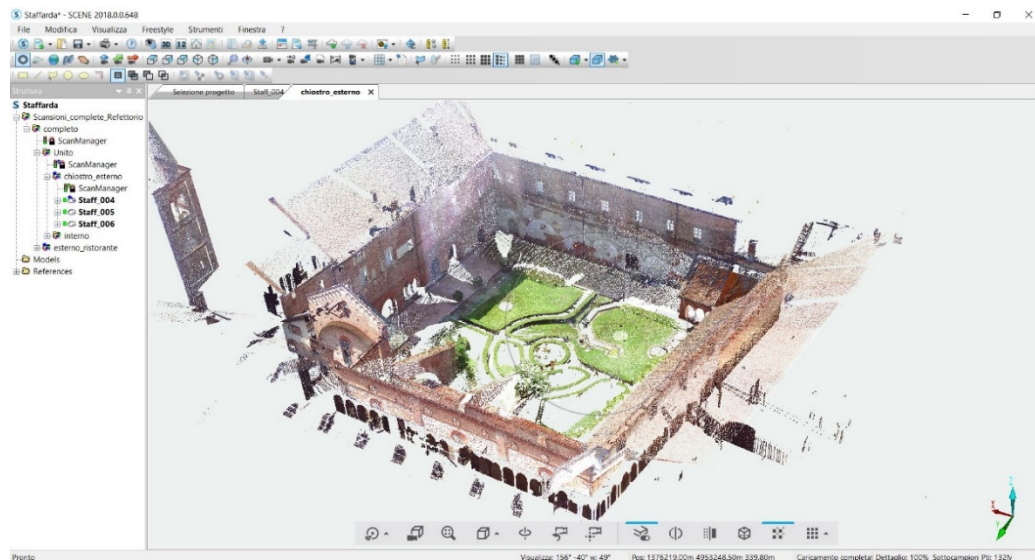

Figure 76. Point clouds generated by two scans on the cloister: in the upper part the refectory front (elaboration F. Diara).

By using Scene, the first step was the *raw data* management. Indeed, in this phase raw LiDAR data (in total 12 scans) were imported (*scan.flr*) and registered as point clouds in the *structure tree* inside Scene software. As mentioned in the *Metric survey of Staffarda refectory* chapter, the 12 scans have been integrated with others 8 LiDAR acquisitions performed in the indoor space of the refectory in 2017, and this acquisition was imported inside Scene software in order to align the older clouds with the latest ones and to create a unique and **complete 3D point clouds**. After the import and registration step, images, and then radiometric information, were included into original monochromatic point clouds, because the laser scanner has an integrated camera which takes a picture during the scanning operation for extracting information about colours of each 3D point. This kind of information was implemented into every scans and point clouds except for the two spaces placed on the west side of the refectory (*Staff\_007*, *Staff\_008*) that had bad indoor visibility because of the lack of natural or artificial light sources to light up the spaces. Summarising, inside the FARO Scene software the 2017 internal scans are referred to *Ref\_scan\_018*, *Ref\_scan\_019*, *Ref\_scan\_022*, *Ref\_scan\_023*, *Ref\_scan\_024*, *Ref\_scan\_025*, *Ref\_scan\_026*, *Ref\_scan\_026*. By contrast the 2018 internal scans are related to *Staff\_000*, *Staff\_001*, *Staff\_002*, *Staff\_003*, *Staff\_007*, *Staff\_008*,

while the scans *Staff\_004*, *Staff\_005*, *Staff\_006*, are referred to the north front of the refectory (cloister side) and *Staff\_009*, *Staff\_010*, *Staff\_011* are concerned the south front of the refectory (restaurant side).

The following operation inside Scene was the positioning of point clouds. The alignment was performed in two different phases: the first one was the “cloud to cloud alignment” based on shapes affinity of clouds; the second was the “target alignment” (with an average target error distance of 5.56 mm – Tab.6) and then the georeferencing process based on topographic points.

In this way, all scans concerning the refectory have been aligned by using cloud to cloud method and the target alignment checked and helped the final accuracy of the clouds positioning.

Table 5. Identification name and position of 2017 and 2018 scans inside Scene software

| <b>2017 scans</b> |                      | <b>2018 scans</b> |                       |
|-------------------|----------------------|-------------------|-----------------------|
| Ref_scan_018      | Inside the refectory | Staff_000         | Inside the refectory  |
| Ref_scan_019      | Inside the refectory | Staff_001         | Inside the refectory  |
| Ref_scan_022      | Inside the refectory | Staff_002         | Inside the refectory  |
| Ref_scan_023      | Inside the refectory | Staff_003         | Inside the refectory  |
| Ref_scan_024      | Inside the refectory | Staff_004         | Outside the refectory |
| Ref_scan_025      | Inside the refectory | Staff_005         | Outside the refectory |
| Ref_scan_026      | Inside the refectory | Staff_006         | Outside the refectory |
| Ref_scan_027      | Inside the refectory | Staff_007         | Inside the refectory  |
|                   |                      | Staff_008         | Inside the refectory  |
|                   |                      | Staff_009         | Outside the refectory |
|                   |                      | Staff_010         | Outside the refectory |
|                   |                      | Staff_011         | Outside the refectory |

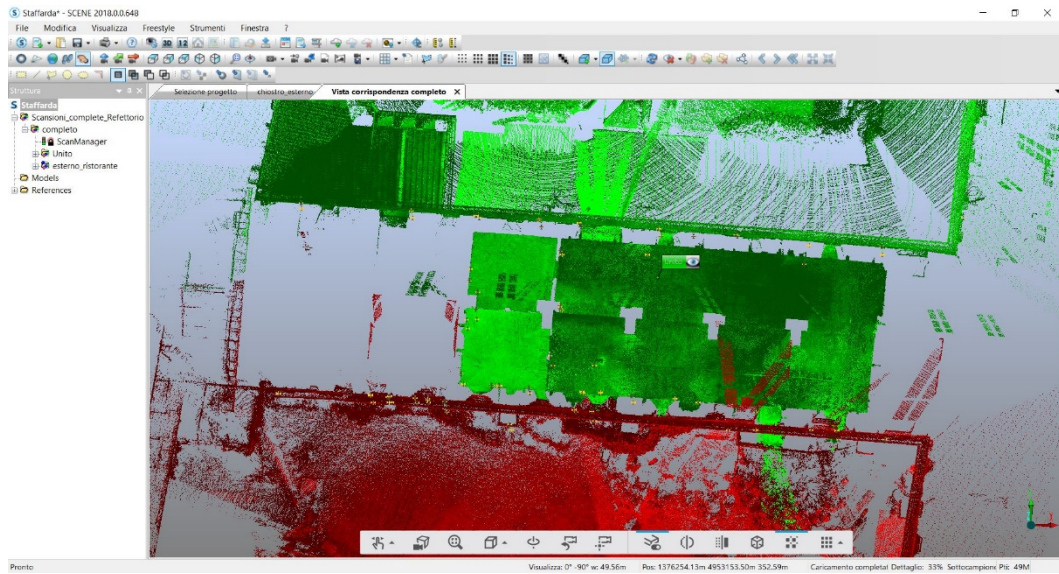

Figure 77. Raw point clouds of the refectory (in the middle) and its external front, in green the cloister side and in red the south side (restaurant courtyard) - (elaboration F. Diara).

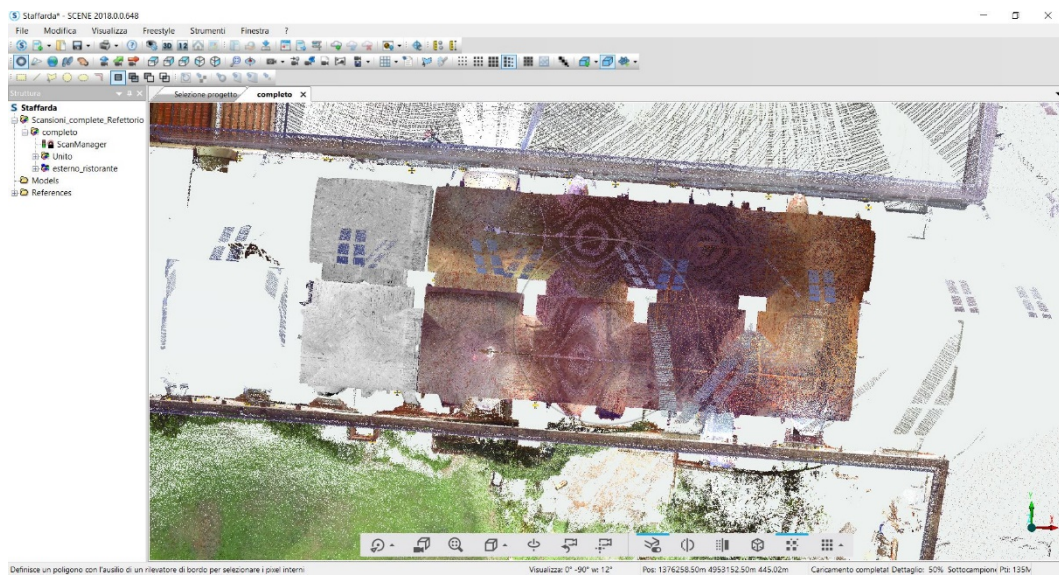

Figure 78. Point clouds of the refectory and its external front including radiometric information - (elaboration F. Diara).

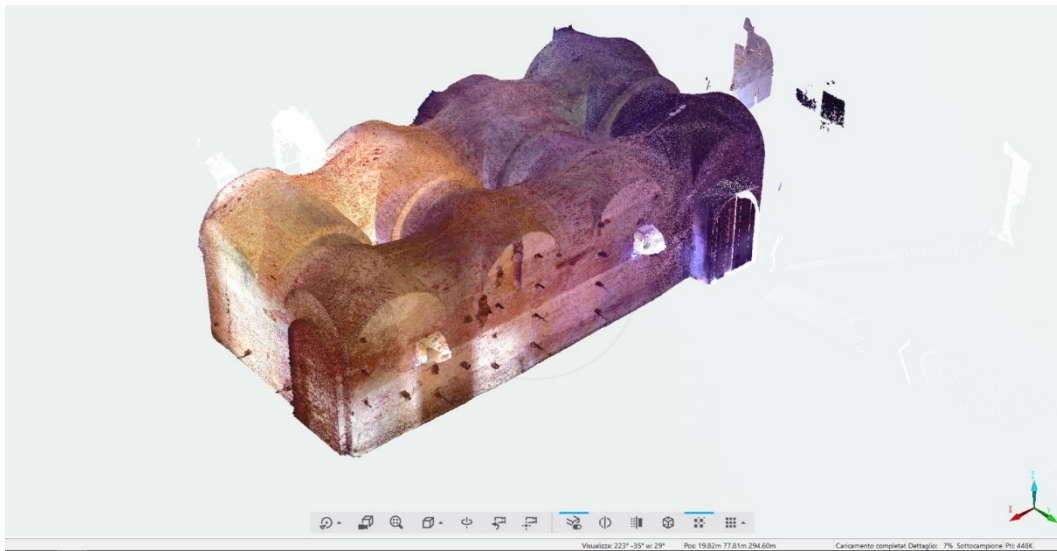

Figure 79. Point clouds of the refectory referred to 2017 survey (elaboration F. Diara).

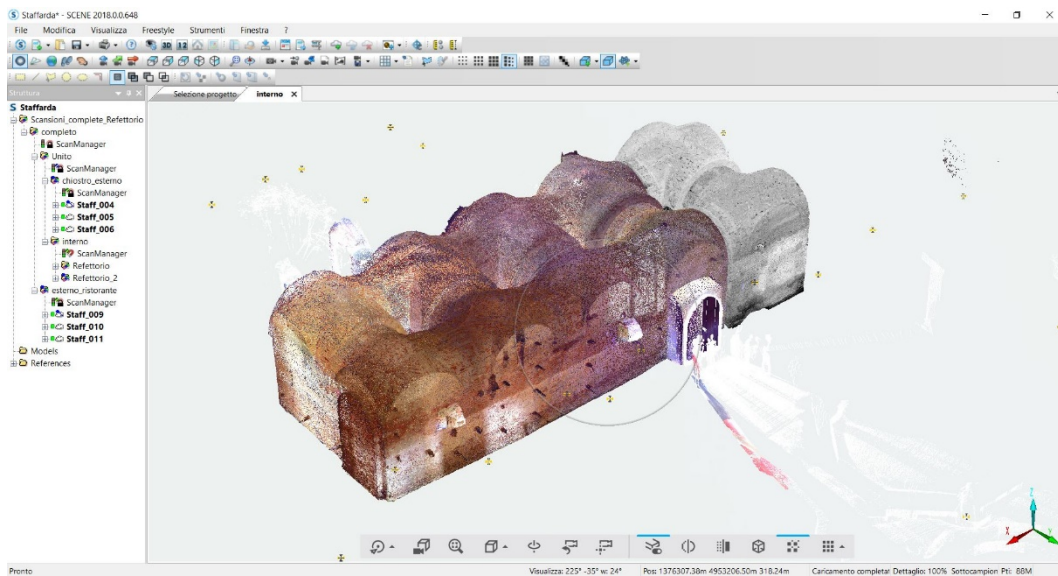

Figure 80. Merged and aligned point clouds of the refectory referred to 2017 and 2018, in grey scale the dark chambers (elaboration F. Diara).



The final operation inside the software was the exportation of final point clouds for each scan, so, in total 20 point clouds have been exported using E57 format that includes radiometric information. This file format has been chosen for the purpose of managing point clouds inside 3D Reshaper software for speeding up the cleaning and segmentation operations, as well as to create the final reality-based triangulated model.

Table 6. Target angle and distance error concerning the refectory scans

| Scans                       | Target error distance | Target angle error |
|-----------------------------|-----------------------|--------------------|
| Main refectory scans        | 4.71 mm               | 0.011 mm           |
| External scans (south side) | 6.40 mm               | 0.012 mm           |
| Total error distance        | 5.56 mm (average)     |                    |

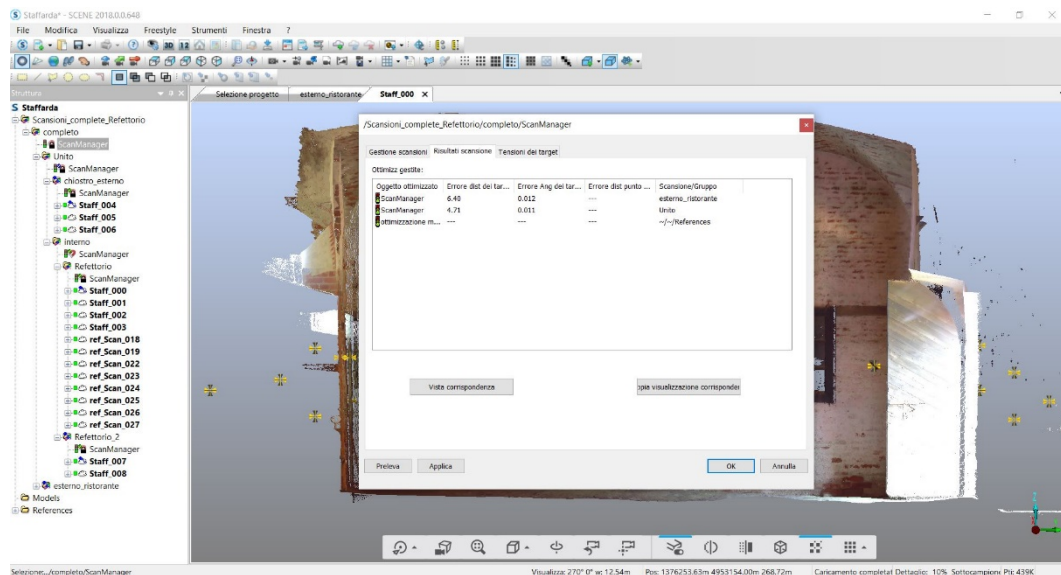

Figure 81. Calculation of target angle and distance error inside FARO Scene software

## 6.2 Reality-based model creation

Point clouds and the following triangulated model have been managed principally for the purpose of extracting measurements and geometric information of the refectory. Indeed, the creation of reality-based model was not the main goal of this project, however, a complete 3D triangulated model has been also generated in order to obtain a full comparison among different models (reality-based model, NURBS model, parametric model).

Indeed, point clouds data resulted from the LiDAR survey have to be performed and managed thinking about the research goal and levels of details to achieve, and these parameters influence the research analysis in all the workflow phases. In this regard, point clouds are the real *backbone* and raw data required to build a different kind of 3D models, principally reality-based triangulated models, NURBS (Non-Uniform Rational Basis-Splines) models and parametric models as well.

Reality-based models are characterized by **triangulated meshes** and by high resolution textures (photographic texture or RGB value from point clouds). The triangulation process, generally based on Delaunay triangulation algorithms, can be carried out by dedicated software but mostly inside a point cloud management software and they can be built by operating different levels of creation parameters, obviously depending on details to achieve.

Once established this, the point clouds management of the refectory has been carried out using **3D Reshaper**<sup>24</sup>, which is a software dedicated to point clouds processing and post-processing operations, also including modelling possibilities. Point clouds referred to the external fronts of the refectory have been managed in order to create a unique model (including past scans in Staffarda) in the same reference system and especially in order to have a complete view of the refectory as regards the internal area and the external front.

On 3D Reshaper software has been performed the following workflow:

- Point clouds importing phase;
- Point clouds cleaning step;
- 3D mesh generation;
- Planar sections extraction;
- Best fitting plans and surfaces generation.

---

<sup>24</sup> <https://www.3dreshaper.com>

### 6.2.1 Point clouds management

Point clouds registered and aligned in FARO Scene environment, as it has been said before, have been exported by using E57 file format and then they are imported (by single scans) in 3D Reshaper software.

After the importing step, point clouds have been aligned automatically following the previous alignment (cloud to cloud and target alignment) and then radiometric values (RGB colours coordinates) have been applied to each point cloud.



Figure 82. Cleaned point clouds related to the ground, pillars and vaults (perspective view) - (elaboration F. Diara).

The first operation has been focused on the subsampling of the heaviest point clouds, because LiDAR scans have generated noisy point cloud with millions of redundant points, and for the purpose of achieving the project goal, heaviest point clouds, although high detailed, haven't played a fundamental role. This operation has been performed by using the *filtering tool* and managing manually the average distance (minimum and maximum) of points setting the minimum distance in 3 mm and the maximum by default.



Figure 83. Cleaned point clouds related to the ground, pillars and vaults (X plane view) - (elaboration F. Diara).



Figure 84. Cleaned point clouds related to the whole refectory (perspective view) - (elaboration F. Diara).

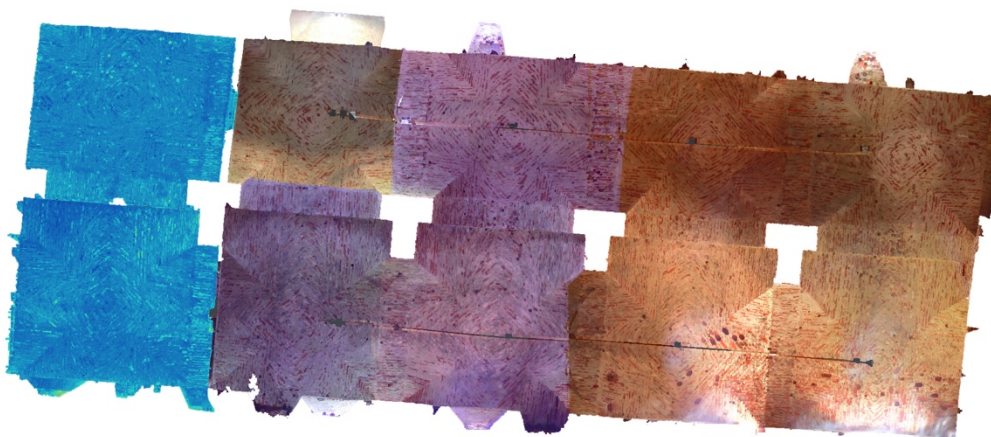

Figure 85. Cleaned point clouds related to the whole refectory (upper view) - (elaboration F. Diara).

This phase is fundamental in order to obtain a clear geometric point cloud without noisy or redundant elements, a really lightweight cloud to be easily managed in terms of hardware supply and as well as for the purpose of generating high quality triangulated meshes.

As mentioned in the *Metric survey of Staffarda refectory* chapter, the internal scans related to the 2018 acquisition have experienced some topological and disturbs issues, especially as concerning the restoration scaffolding for the *Ultima Cena* fresco, and light reflections to materials, reverbs and backlight from the openings. Moreover, the two scans of the additional chambers resulted without radiometric information due to poor lighting conditions. The problem of the scaffolding did not exist on the scans related to the 2017 survey. These issues have generated different lacks of metric information and noisy elements on the point clouds and of course as regards the reality-based model generation.

|  |
|--|
| <p><b><u>NUVOLA UNICA (CONTEGGIO) : NUVOLA</u></b><br/> 141.858.125 punti<br/> <b>Dimensione max:</b> 23.199461<br/> <b>Casella di delimitazione min:</b> 1376246.229914 4953146.509167 265.99731<br/> <b>Casella di delimitazione max:</b> 1376269.429375 4953158.912997 271.97455<br/> <b>Dimensione:</b> DX23.199461 DY12.40383 DZ5.977237<br/> <b>Punto più basso:</b> 1376246.435638 4953151.062008 265.997317<br/> <b>Punto più alto:</b> 1376266.874968 4953147.647228 271.974555<br/> <b>Centro:</b> 1376259.003650 4953153.340165 268.655571<br/> <b>Colore:</b> si<br/> <b>Ispezione:</b> si<br/> <b>Direzione di scansione su tutti i punti:</b> si</p> |
|--|

Figure 86. Point cloud of the refectory and its properties and coordinates

In every single scan, the cleaning action has been performed by using the *filtering tool* and *point clouds noise reduction* sub-tool and more deeply point clouds of the refectory have been cleaned removing manually the overlapped redundancy of scans and the additional noise in order to obtain a clean and precise cloud of the refectory. This operation has been carried out decomposing point clouds by macro architectural entities and components, such as the clay ground, the vaulted ceiling, pillars, and walls and so on.

Subsampled and cleaned point clouds have been finally merged with each other in order to create a unique cloud of the refectory, which is about **140 million points** (Fig. 84-85-86).

After the point cloud cleaning and filtering processes, the next step was the triangulated mesh generation for the purpose of creating the reality-based model.

### 6.2.2 3D mesh generation

The creation of 3D mesh has been managed by using *two phases meshing option*: the first phase of this command allows to set the average distance among points as a noise reduction tool and allows to manage the holes detection by setting triangles measurements. As far as the mesh generation of the refectory is concerned, the *average distance among points* has been set to 2 mm and the *triangles measurements* of holes detection have been set to 20 cm (Fig.87).

The image shows a software interface with four distinct panels for configuring meshing options. The first panel, titled 'Proprietà della nuvola di punti', contains a label 'Quantità di punti' and a text box with the value '3006875'. The second panel, 'Riduzione di rumore', features two radio buttons: 'Meshing in due fasi' (which is selected) and 'Campionamento normale'. Below these is a label 'Distanza media tra i punti' and a text box containing '0.002'. The third panel, 'Gestione fori', has three radio buttons: 'Rilevazione fori' (selected), 'Prova a tenere solo il bordo esterno', and 'Prova a creare una mesh watertight'. It also includes a label 'Misura triangoli:' and a text box with '0.2'. The final panel, 'Proprietà meshing', contains a single checkbox labeled 'Ignora direzioni di scansione' which is currently unchecked.

Figure 87. Meshing two phases options inside 3D Reshaper

The second phase of this command, related to *refining meshing tools*, has been managed by setting the error deviation to  $1\mu$ , setting the minimum triangles measurement to  $1\mu$  and configuring the abnormal points distance to 1 mm. Moreover, the maximum numbers of triangles have been set by the default value.

By using these tools and these setting, the creation of the high quality 3D mesh has been possible, and it counts, after a mandatory cleaning action, around **175 millions of triangles** (Fig.88 and 89). Finally, on the triangulated mesh has been

matched and mapped the radiometric information (RGB colours) derived from LiDAR data (Fig.93).

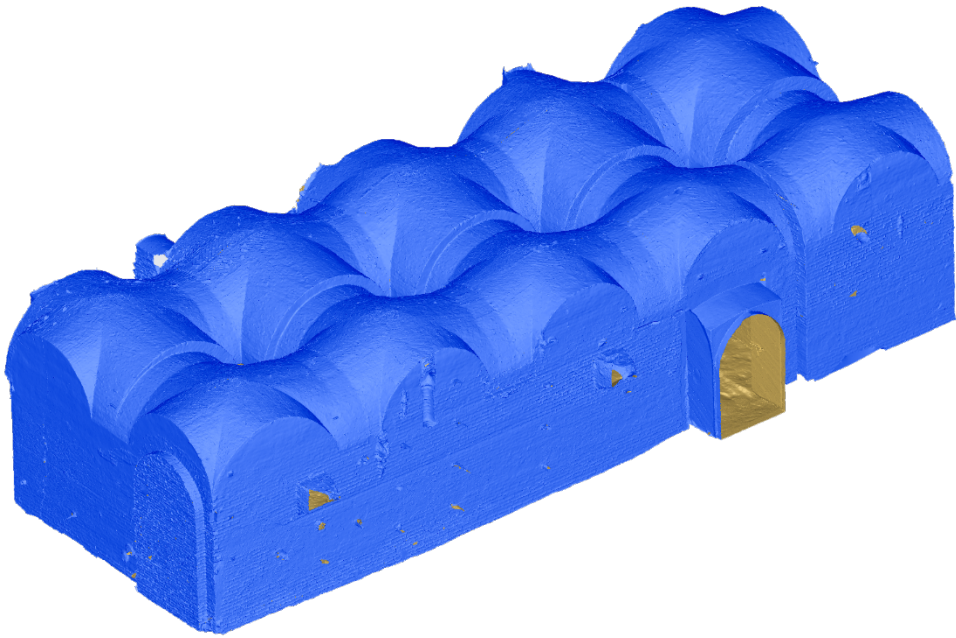

Figure 88. Polygonal mesh related to the whole refectory (perspective view) - (elaboration F. Diara).

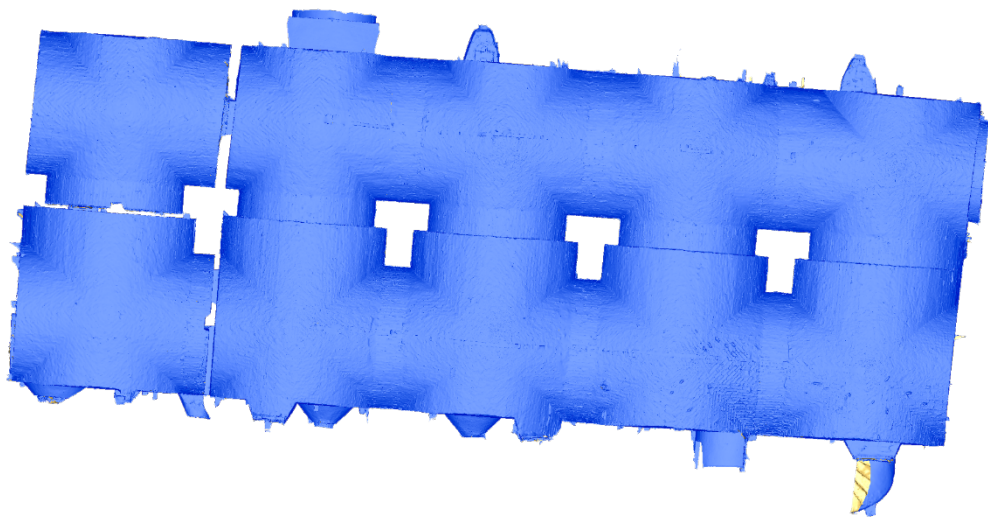

Figure 89. Polygonal mesh related to the whole refectory (upper view) - (elaboration F. Diara).

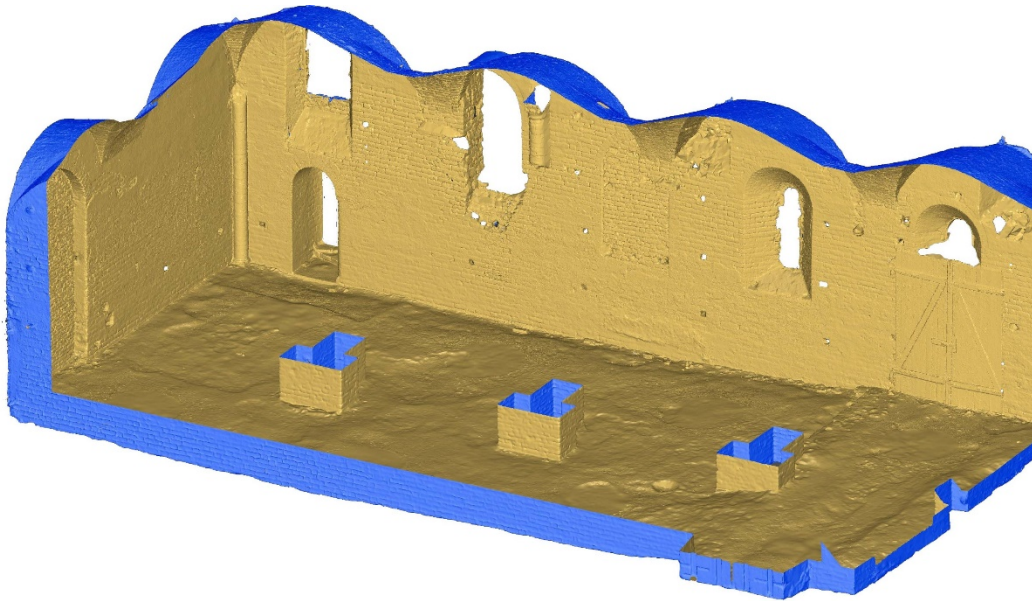

Figure 90. Detail of the polygonal mesh related to the refectory (south and east walls) - (elaboration F. Diara).

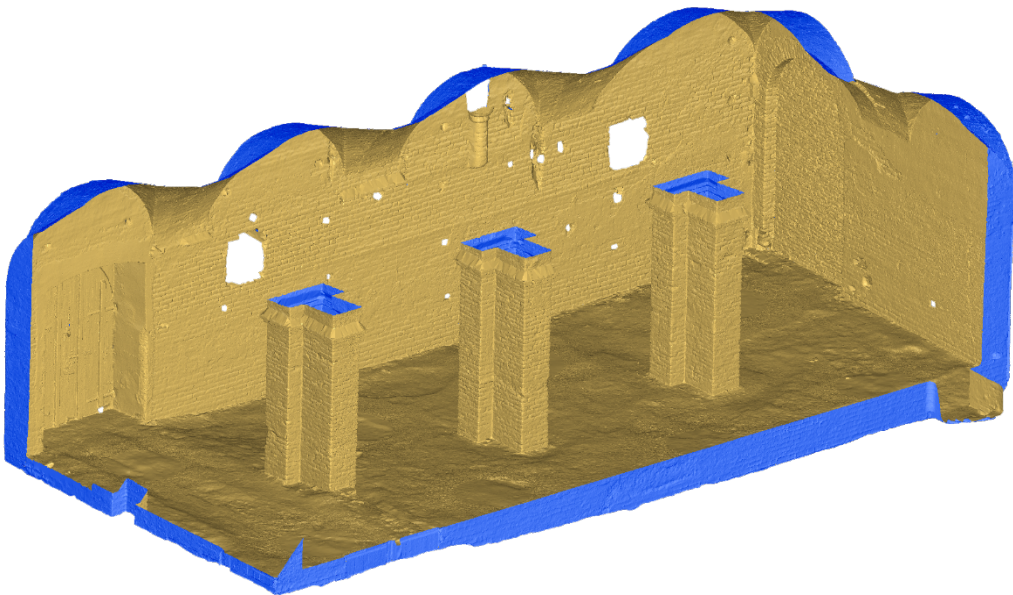

Figure 91. Detail of the polygonal mesh related to the refectory (north and east walls) - (elaboration F. Diara).



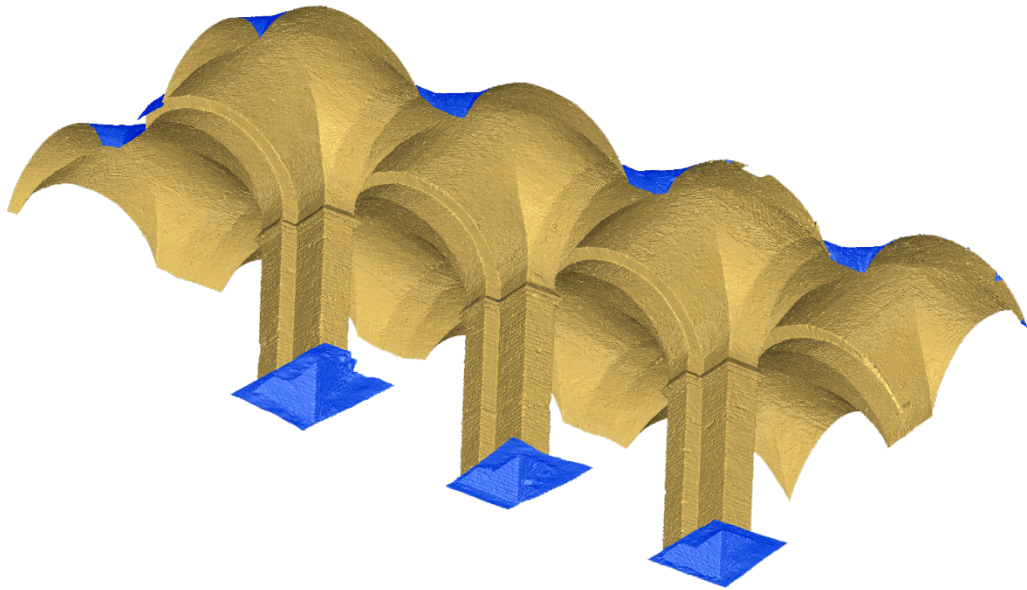

Figure 92. Detail of the polygonal mesh related to the pillars and vaulted ceiling (intrados) - (elaboration F. Diara).



Figure 93. Radiometric values applied to the polygonal mesh (detail of south and east walls) - (elaboration F. Diara).

## 6.3 Sections and best fitting planes

The BIM modelling thought, as mentioned in the previous chapters, requires the geometry simplification of planes, surfaces and by modelling primitive geometries forming architectural elements. In this sense, the extraction of **planar sections** and generations of **best fitting planes**, starting from the reality-based model, played a fundamental role in this project phase for the purpose of creating high detailed 3D free form models as also underlined in other studies (Tommasi et al., 2016; Banfi F., 2017).

Indeed, the extraction of planar sections has been planned for the purpose of generating profiles of the geometry of the refectory and in order to have a metrically correct framework for the next 3D NURBS modelling on Rhinoceros and then in order to perform the following parametric modelling on BIM platform. This step has been characterized by an important and time-consuming interpretation phase of geometries. Inside 3D Reshaper, planar sections have been performed on X, Y, Z planes on reality-based model and have been generated with different distances and thickness, depending on architectural elements: for example, 10 cm of distance and a planes thickness of 2 mm for vaults and walls, smaller values for smaller and detailed elements.

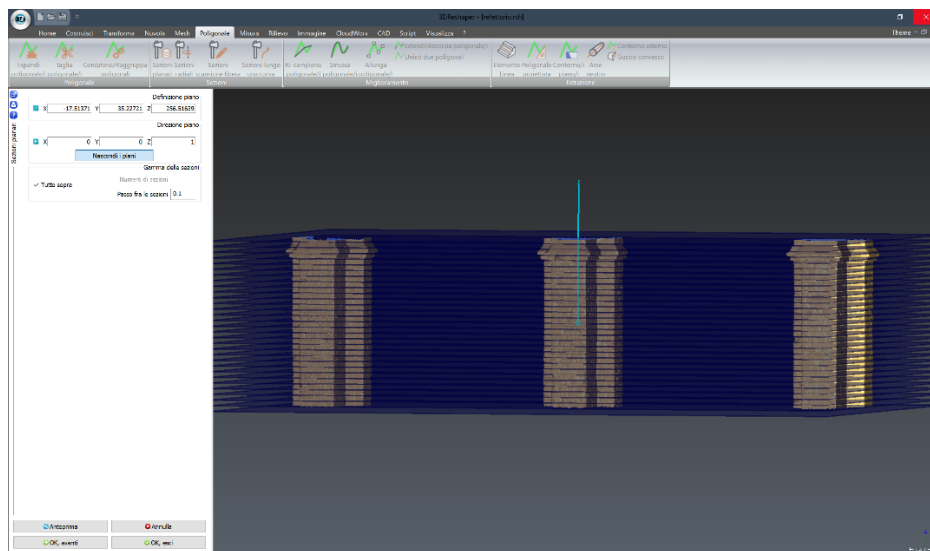

Figure 94. Planar sections options and preview related to the pillars (elaboration F. Diara).

This operation would have results in more detailed managing sections on point clouds, but has been pursued this choice for two reasons: first of all due to the sections course, because the sectioning method directly on the point clouds, even if

a very dense point cloud, would have generated small gaps and lack of profile sections; on the second hand, this procedure has been performed also because of density and quality of the triangulated mesh and, even if the mesh is a boundary interpretation of surfaces (an approximation of geometry), this procedure has allowed keeping the metrical precision. In fact, this sectioning phase is strongly affected by the level of detail resulted during the mesh generation phase, and in this case has been carried out a high quality mesh creation. The sectioning operation has generated regular profiles of the entire volumetric geometry of the refectory and, in the end, these profiles of planar sections have been exported as CAD element (IGES format) and imported, keeping the right coordinate system, into the Rhinoceros environment.

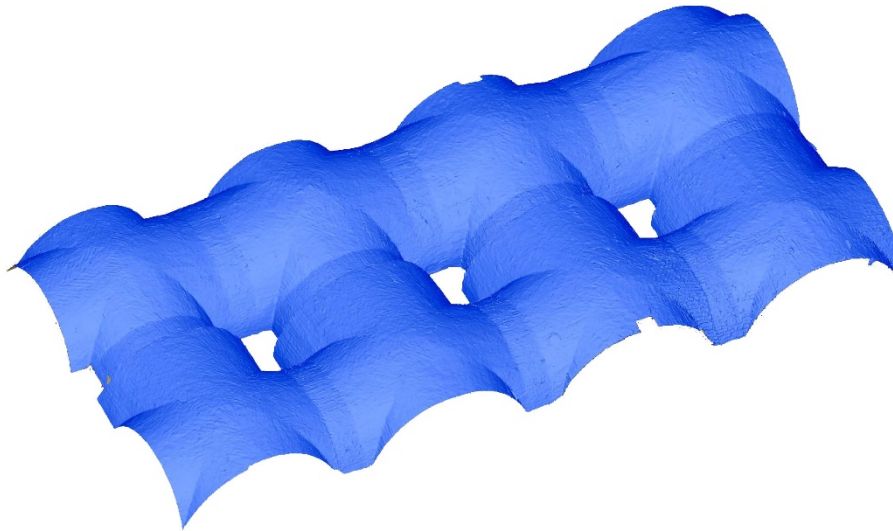

Figure 95. Polygonal mesh of the vaults (elaboration F. Diara).

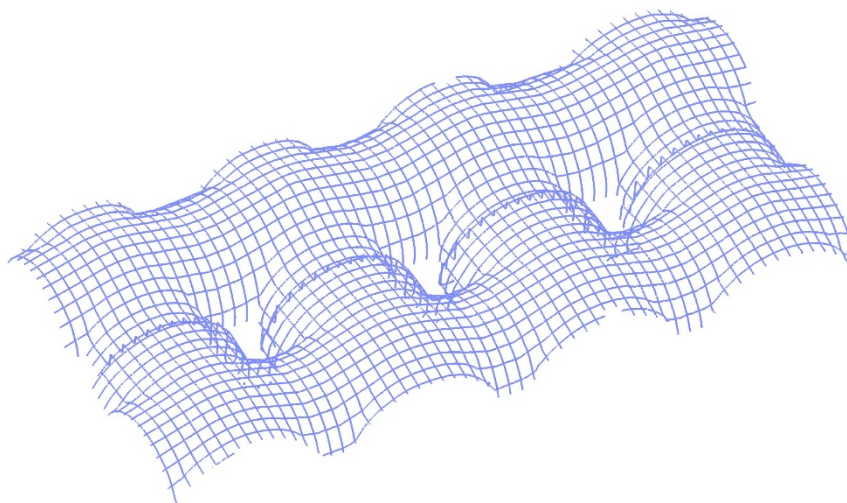

Figure 96. Planar sections extracted from the vaults (elaboration F. Diara).

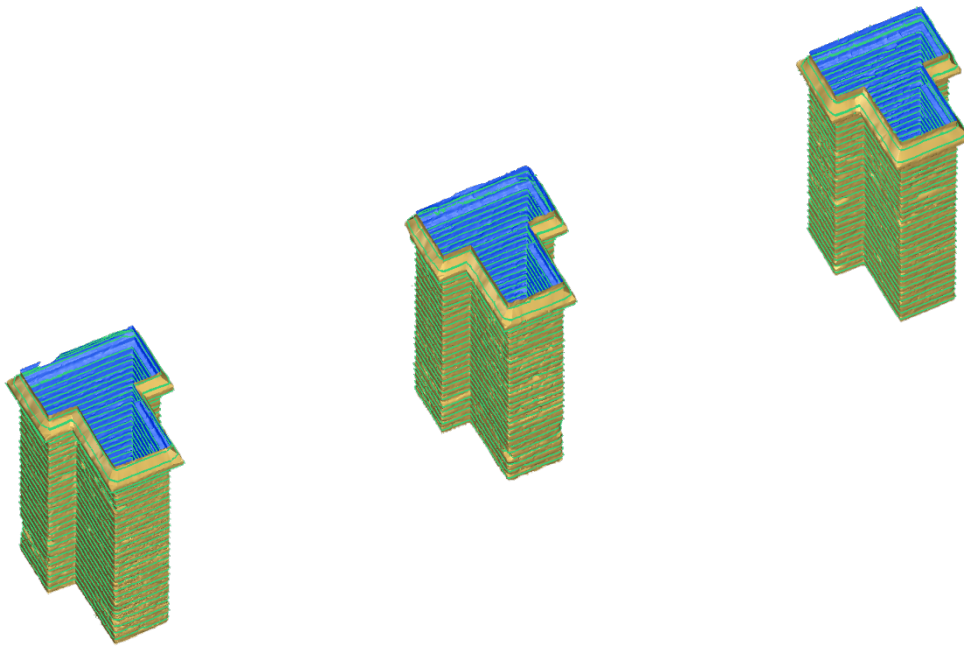

Figure 97. Polygonal mesh and planar sections preview of pillars (elaboration F. Diara).

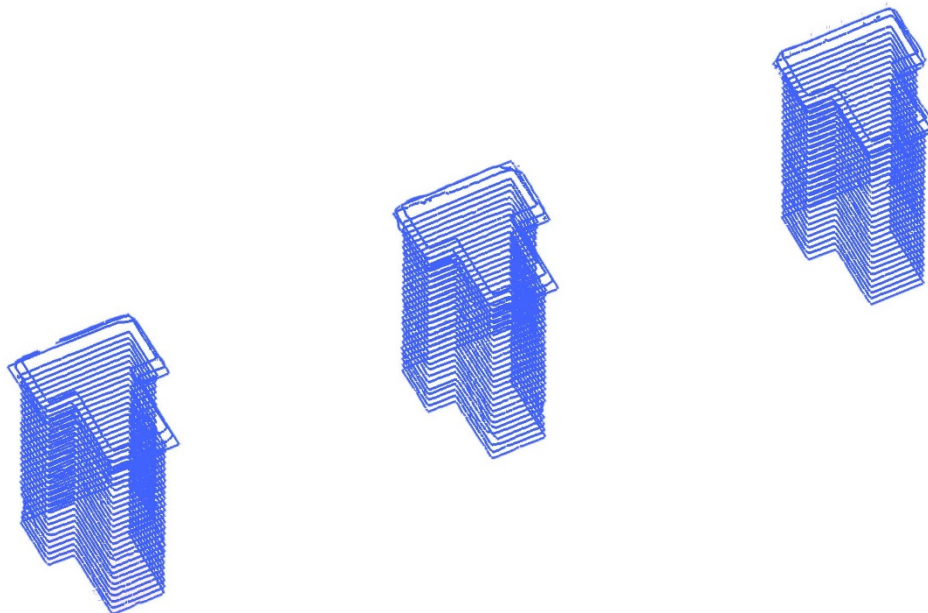

Figure 98. Planar section (X plane) extracted from pillars (elaboration F. Diara).

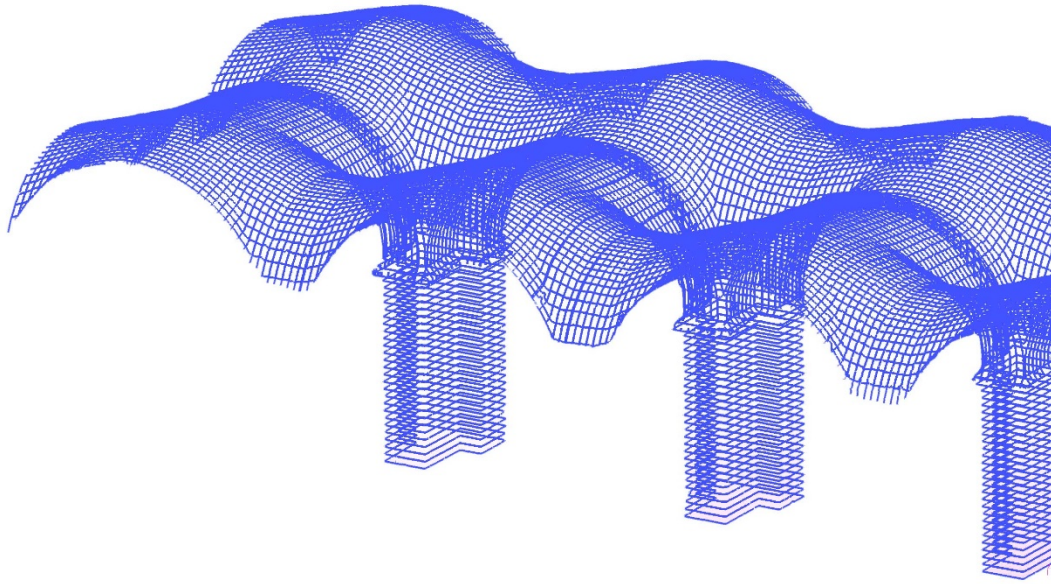

Figure 99. Detail of planar sections related to vaults and pillars (elaboration F. Diara).

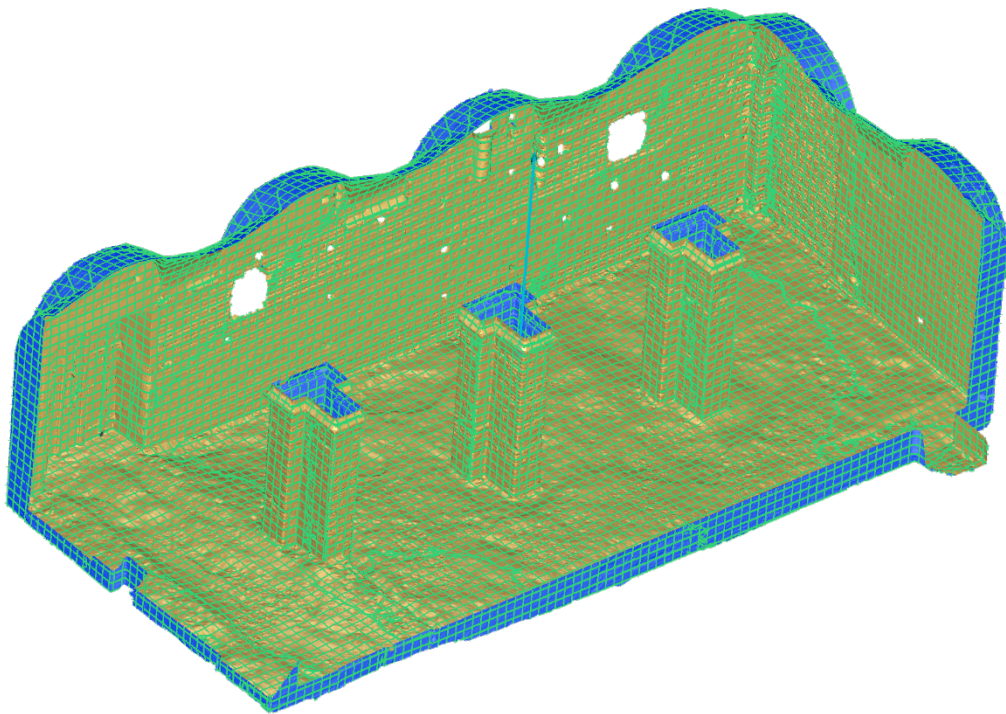

Figure 100. Planar sections (X-Y-Z planes) related to ground, pillars and north and east walls (elaboration F. Diara).

The creation of best fitting planes has played the same importance as planar sections extraction. In fact, best fitting planes have been generated for the purpose of having flat and planar surfaces regarding the clay ground of the refectory, because it shows, due to the clay material, a lot of irregularities and light differences in height (Fig.101). For this reason, the creation of flat CAD surfaces that fit to the ground (Fig.102) has been the better choice for the purpose of having simplified surfaces of the ground, suitable for the creation of the parametric model.

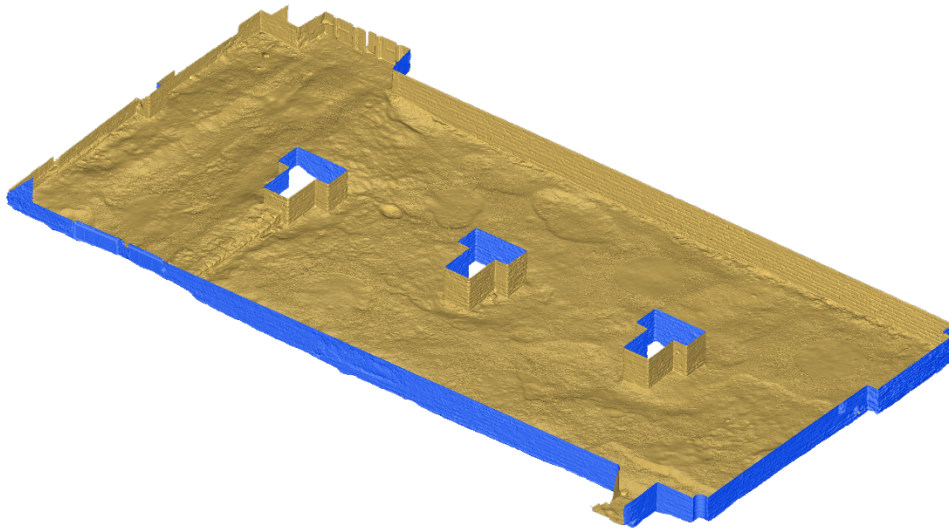

Figure 101. Polygonal mesh of the clay ground (elaboration F. Diara).

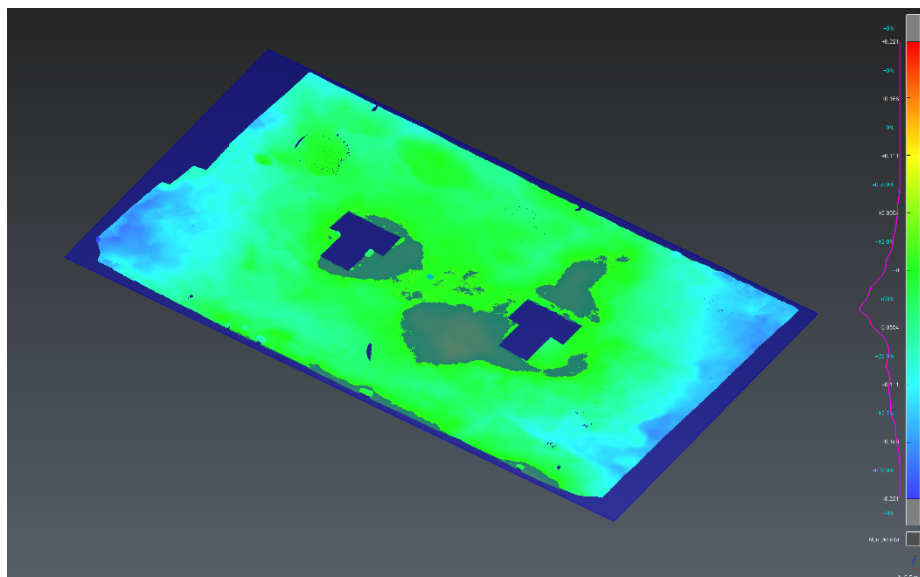

Figure 102. Best fit plane extracted from the ground (elaboration F. Diara).

Concluding this chapter, the creation of reality-based model has been carried out for different reasons: the complete high quality model of the Staffarda refectory assumes great importance for the purpose of managing different metric and structural analyses and plays also a fundamental role in the communication step. However, despite these analyses and possibilities, these kinds of models still remain anonymous models. In this sense, heavy 3D point cloud and triangulated meshes do not contribute significant information concerning a semantic dimension, for example in order to operate by a multi-disciplinary critic analysis (De Luca et al., 2011; Messaoudi et al., 2018). In fact, BIM projects and also HBIM projects require dynamic simplified and light-weight models, which include information inside every object and then the semantic dimension (De Luca et al., 2011; Diara et al., 2018).

For this reason, it is really important to manage and to simplify point clouds in order to create “as-built” HBIM models, applying of course a critic and objective view depending on the final aim of the research and on the sensibility of the researchers as well.

# Chapter 7

## Stratigraphic survey and analysis

### 7.1 Stratigraphic survey of the refectory

Although it is a manual and *analogical* survey (and also slow), the stratigraphic survey is fundamental, allowing the surveyors to observe and analyse directly and on a short distance (also micro stratigraphy) all the **stratigraphic units**, layers, pathologies and features of masonries. Indeed, this on-field survey is carried out for identifying and sketching units and drawing up a preliminary survey report. Of course, photographic documentation must be done for the purpose of collecting a graphic report and feedback concerning the sketches and notes we have done at the moment of the survey.

The stratigraphic survey of the refectory has been performed in order to document and register all the stratigraphic units of external (cloister side) and internal fronts of the Staffarda refectory. These on-field missions have been useful principally to detect some micro stratigraphic evidence such as the different plaster and render stratification, and other small relations and cuts on masonries.

Another important step is the stratigraphic analysis of these units on rectified images of masonries, in order to perform a complete detailed map of units and their edges, and for this reason the creation of orthophotos assumes its importance.

### 7.2 Orthophoto generation

In addition to photographic detailed documentation of peculiarities, a full photographic and photogrammetric survey of walls and masonries has been performed in order to generate oriented orthophotos: these are oriented and plane raster images on which it is possible to read, draw up and numerate stratigraphic units on CAD software for the purpose of having a complete **2D map of walls stratification**.



For this thesis project, orthophotos of the internal fronts of the refectory have been generated starting from LiDAR acquisitions and then radiometric point clouds (Fig.103-107), and these rectified images are required elements to be included into HBIM project, especially for extracting surfaces information (Karachaliou et al., 2019). As mentioned on *Metric survey of Staffarda refectory* chapter, radiometric information of the internal front has been collected just for the main and biggest chamber of the refectory, because on two west small chambers the laser scanner was unable to collect radiometric information due to the extremely low brightness, and for this reason orthophotos haven't been generated. Furthermore, another issue affected the south external front of the refectory (restaurant garden side): although it has been surveyed with the laser scanner in order to register metric and geometric information, this front has not been considered for the stratigraphic analysis and then for the orthophoto generation because, in addition to being in the least accessible area, it resulted covered by vegetation and high trees, and, due to these issues stratigraphic units were not readable at all.

Otherwise from this front, the external north front of the refectory (cloister side) has been surveyed, in addition to the laser scanner, with a complete free-hand photogrammetric survey in order to produce a high quality detailed orthophoto able to makes all units (also micro units) visible. This oriented raster image has been produced by using the photogrammetric software Photoscan Pro, and the result has been exported using TIFF format.

As far as the internal fronts of the refectory are concerned, these have been surveyed correctly by the laser scanner (both acquisitions of 2017 and 2018) that produced radiometric information useful for the post-surveying stratigraphic analysis. However, the internal part of the refectory was affected by different issues like the light reflections and reverbs entering from the openings (square windows and single-lancet windows), and they could not close. This kind of issue also affected the correct and uniform detection of radiometric information of the surroundings of these openings. For this reason, final orthophotos have been produced by matching parts of LiDAR data of 2017 with the 2018 LiDAR data also because of the presence of the restoration scaffolding in the 2018 data.

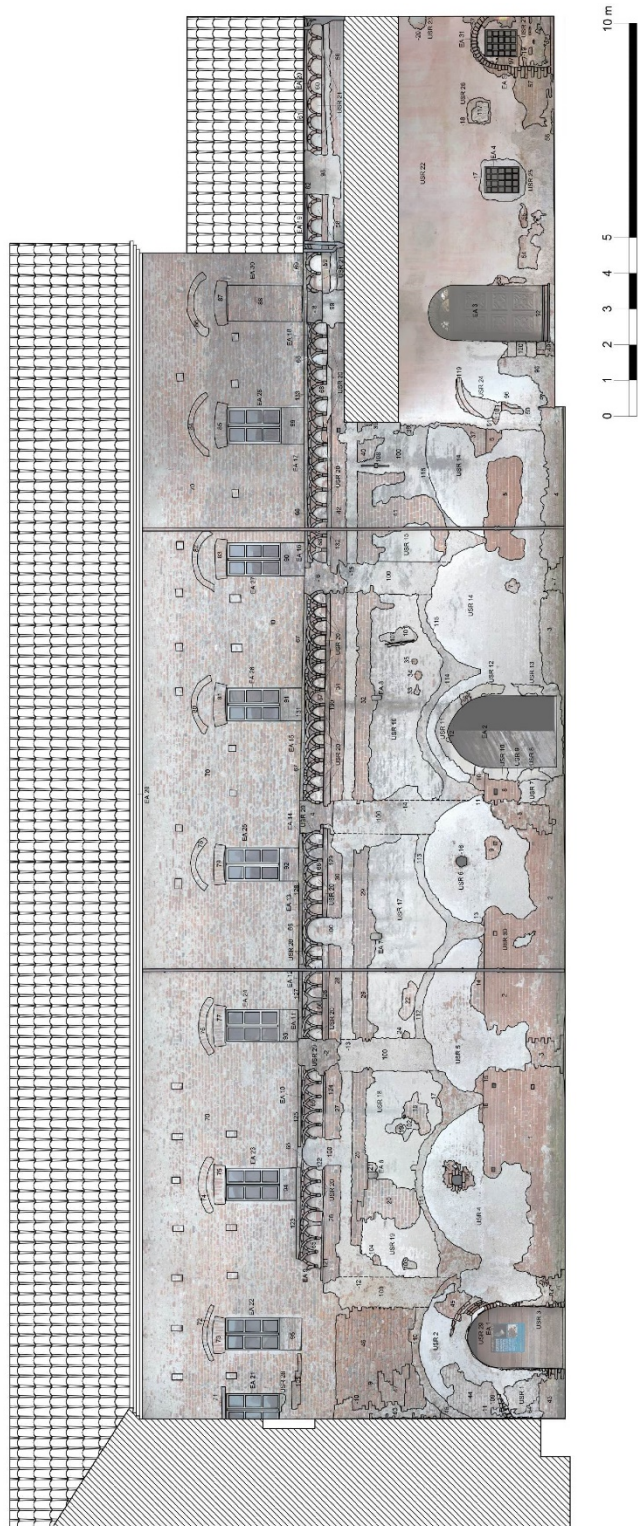

Figure 103. South front of the cloister and the stratigraphic analysis (elaboration F. Diara).

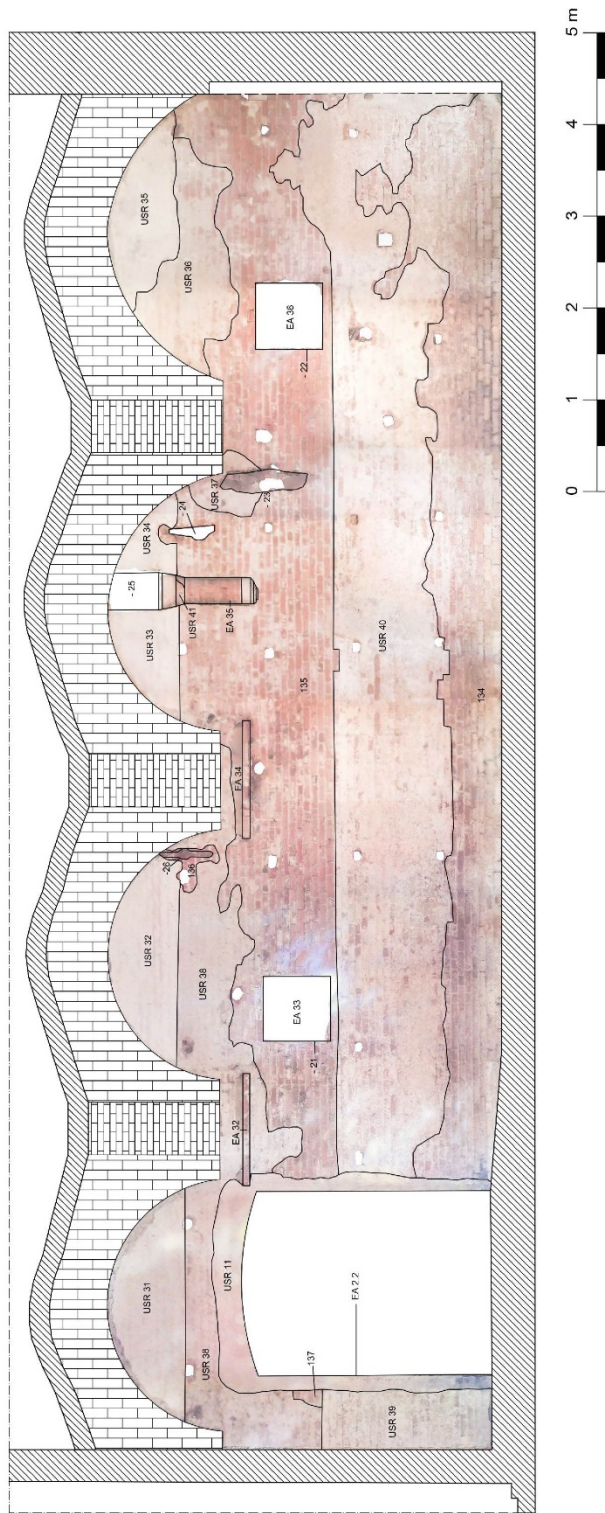

Figure 104. North wall of the refectory and the stratigraphic analysis (elaboration F. Diara).

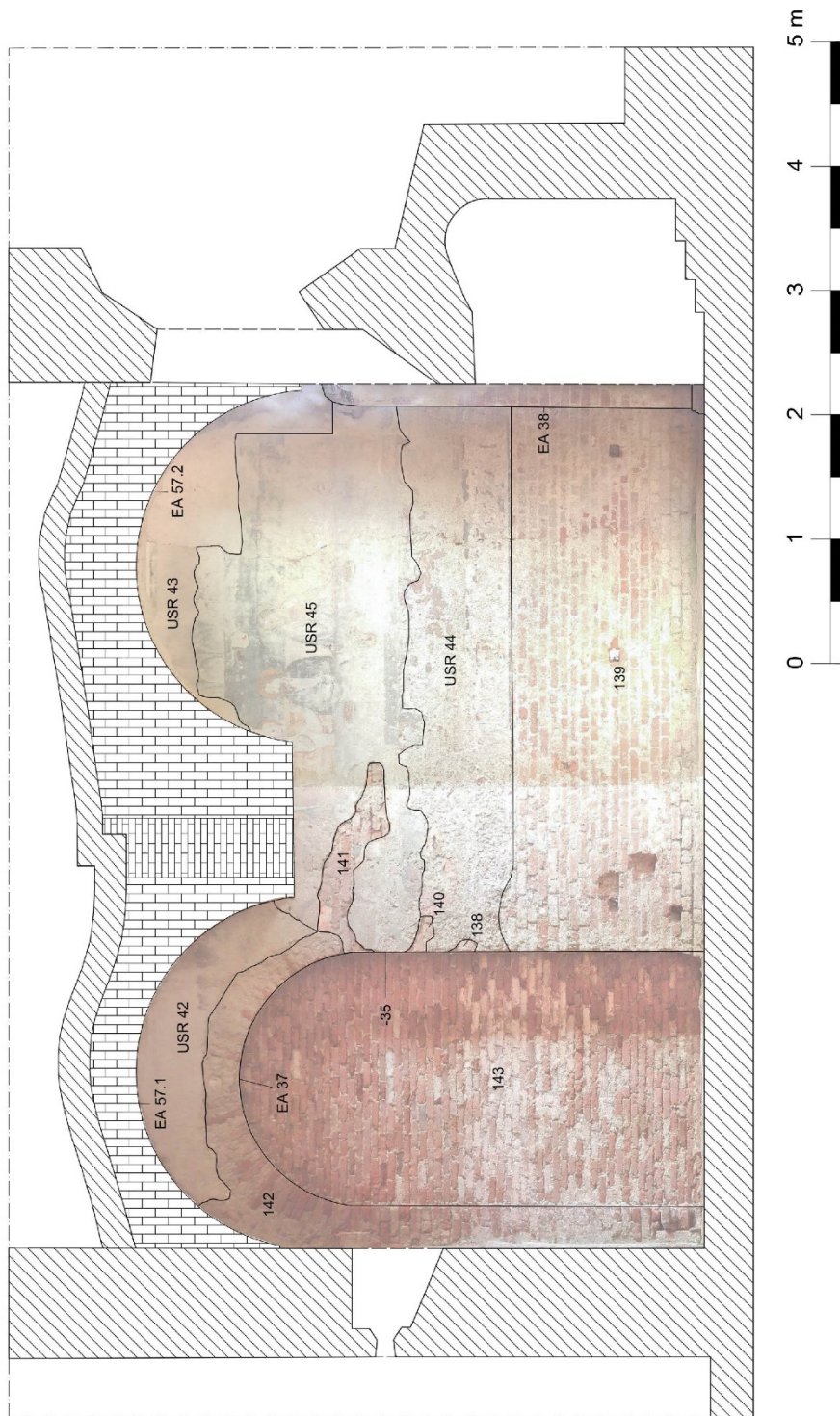

Figure 105. East wall of the refectory and the stratigraphic analysis (elaboration F. Diara).

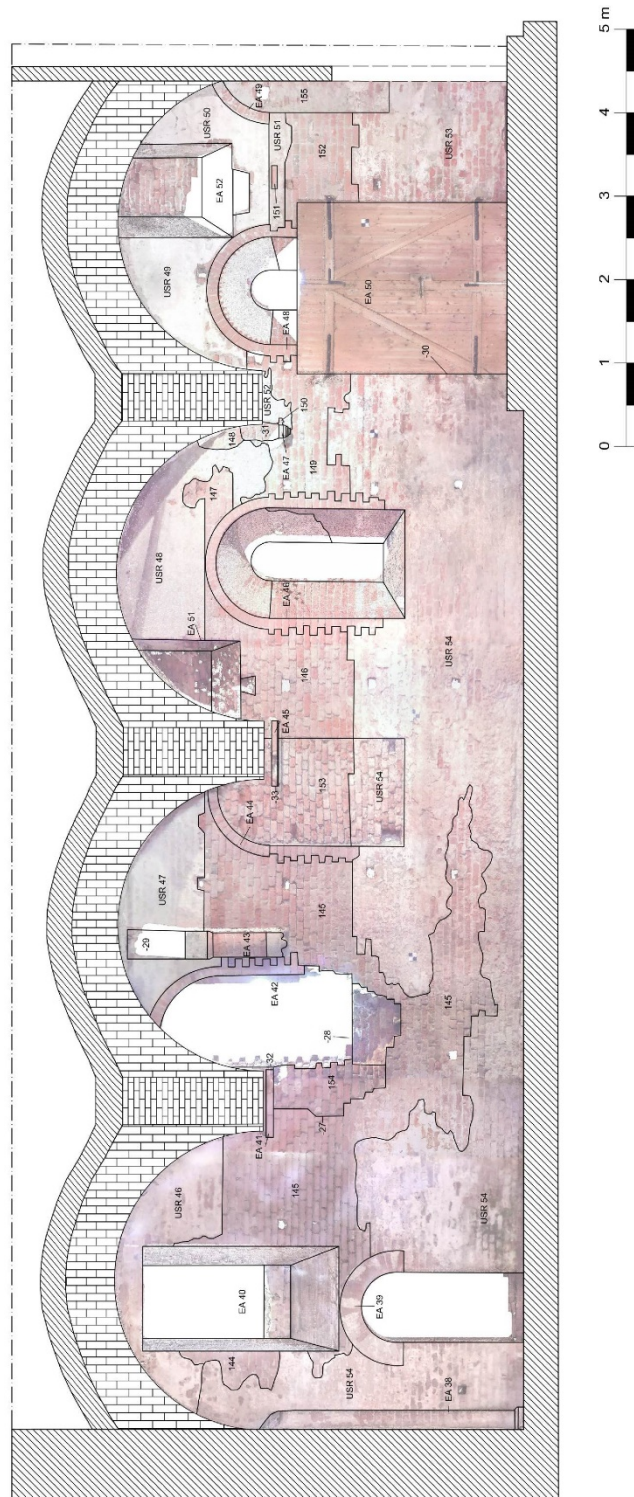

Figure 106. South wall of the refectory and the stratigraphic analysis (elaboration F. Diara).

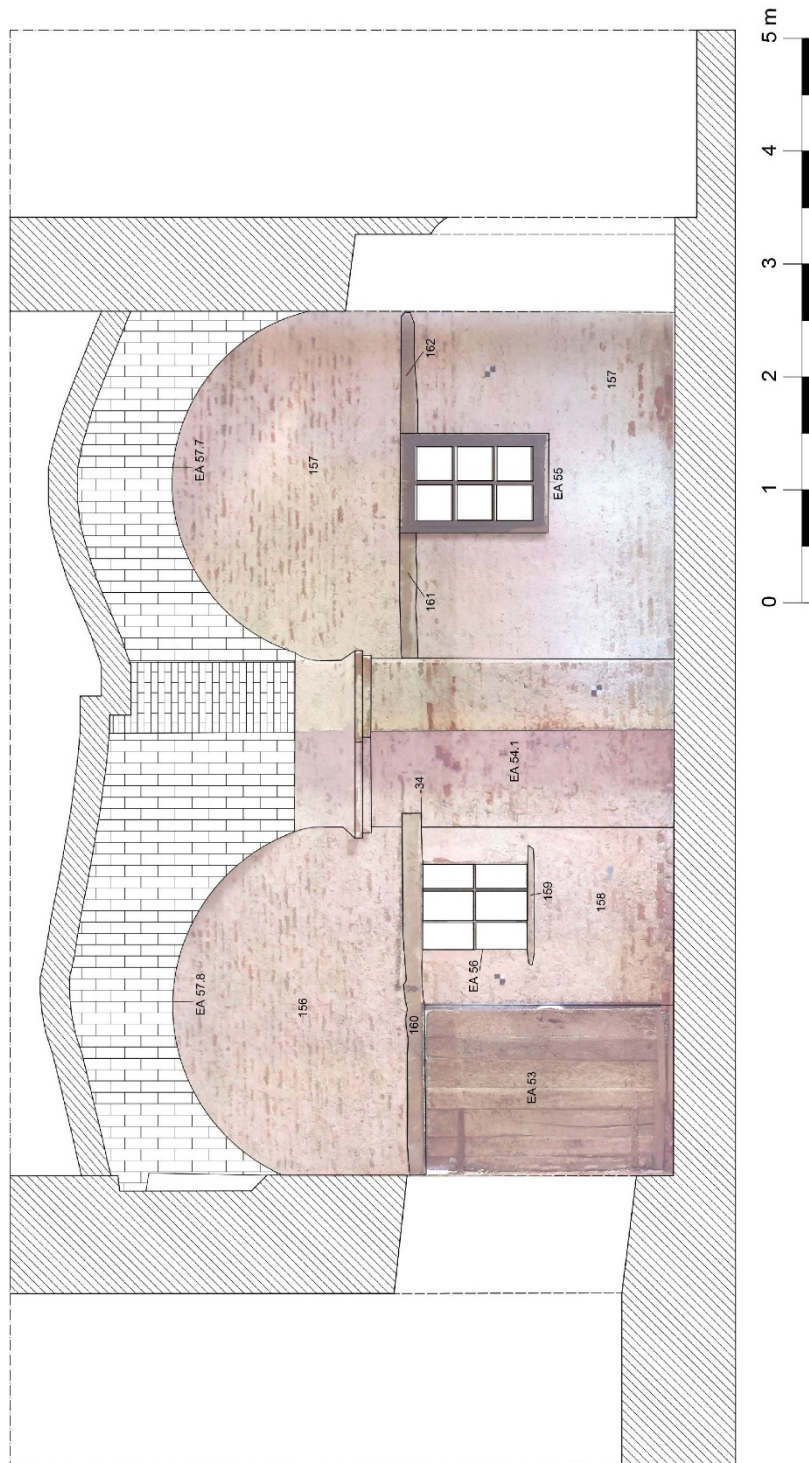

Figure 107. West wall of the refectory and the stratigraphic analysis (elaboration F. Diara).

### 7.3 Stratigraphic analysis of the refectory

Stratigraphic analysis of the refectory has been carried out applying the **edges detection** of stratigraphic units and classifying units by using **identification numbers** based on reference units (UR). In fact, as described on the *Stratigraphy and stratification* chapter, for the classification of the refectory units has been used these reference units: masonry stratigraphic unit (USM), architectural element (EA), render / plaster stratigraphic unit (USR). Moreover, negative units have been identified and catalogued by using negative numeration (-1, -2, -3, and so on). However, in order to have a comprehensible map of stratification, the reference classification USM has not been used on orthophotos with unit edges. In other words, for example, the stratigraphic unit “USM 30” has been described on the stratification map as “30”.

Another classification occurred for the purpose of subdividing the vaulted system and the pillars (Fig.108 and 109). From a stratigraphic point of view, pillars have been classified as architectural elements EA 54. Moreover, has been carried out a numerical subdivision, in fact, starting from the walled pillar on the west side to the whole pillar on the east side a decimal numeration has been applied: EA 54.0 - EA 54.1 - EA 54.2 - EA 54.3 - EA 54.4. The zero decimal numeration has been chosen because it is referred to the walled pillar between the two small chambers. In the same way, vaults have been defined as architectural element EA 57, by using also a decimal subdivision depending on the ten bays of the complex. This numeration has been carried out starting from the east wall to the west side, including the vaults into small hidden chambers: EA 57.1 - EA 57.2 - EA 57.3 - EA 57.4 - EA 57.5 - EA 57.6 - EA 57.7 - EA 57.8 - EA 57.9 - EA 57.10.

Table 7. Vaults and pillars classification

| UNITS NUMBER | MATERIAL          | DESCRIPTION  |
|--------------|-------------------|--|
| EA 54.0      | Brick and plaster | Walled pillar referred to the new vaulted ceiling              |
| EA 54.1      | Brick and plaster | Walled pillar on west wall referred to the new vaulted ceiling |
| EA 54.2      | Brick and plaster | pillar referred to the new vaulted ceiling                     |
| EA 54.3      | Brick and plaster | pillar referred to the new vaulted ceiling                     |
| EA 54.4      | Brick and plaster | pillar referred to the new vaulted ceiling                     |
| EA 57.1      | Brick and plaster | groin vaults and arches related to the new ceiling             |
| EA 57.2      | Brick and plaster | groin vaults and arches related to the new ceiling             |
| EA 57.3      | Brick and plaster | groin vaults and arches related to the new ceiling             |
| EA 57.4      | Brick and plaster | groin vaults and arches related to the new ceiling             |

|          |                   |  |
|----------|-------------------|--|
| EA 57.5  | Brick and plaster | groin vaults and arches related to the new ceiling |
| EA 57.6  | Brick and plaster | groin vaults and arches related to the new ceiling |
| EA 57.7  | Brick and plaster | groin vaults and arches related to the new ceiling |
| EA 57.8  | Brick and plaster | groin vaults and arches related to the new ceiling |
| EA 57.9  | Brick and plaster | groin vaults and arches related to the new ceiling |
| EA 57.10 | Brick and plaster | groin vaults and arches related to the new ceiling |

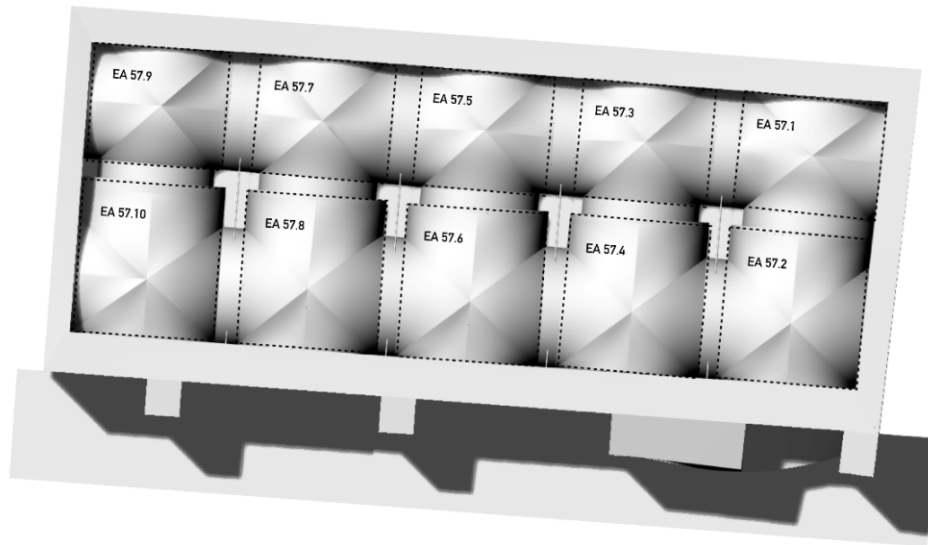

Figure 108. Vaults identification numbers (NURBS model) (elaboration F. Diara).

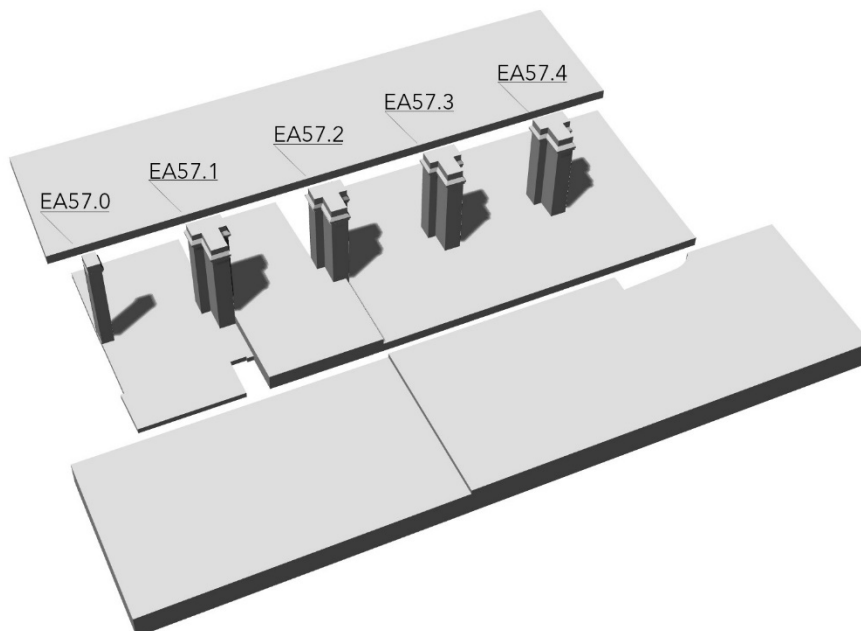

Figure 109. Pillars identification numbers (NURBS model) - (elaboration F. Diara).



Despite the stratigraphic analysis of the external front of the refectory, referred to the south cloister side, has been carried out for the entire front, included also the first floor above the refectory, inside the HBIM platform and inside Rhinoceros modeller have been imported and included on the model just the units referred to the edges and the area related to the refectory (Fig.110). However, the complete analysis of the external front helped the comprehension of all units and then their interpretation phase. Lately, as mentioned in chapter 3, the material analysis of the refectory is reported on TAV.3-7-11-15-19.

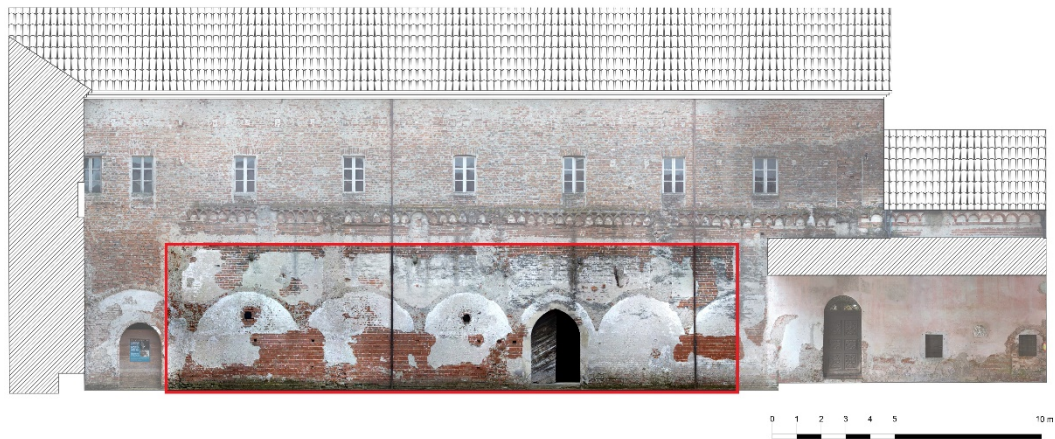

Figure 110. The considered area for the HBIM platform (elaboration F. Diara).

### **South front of the cloister (external front of the refectory)**

Despite the refectory is the focus of this thesis project, the stratigraphic analysis of the south front of the cloister has been performed entirely. In this front, the refectory is located on the central lower part and it shows a great complexity of stratigraphic units that suggest several morphological changes during the years.

As far as the external masonry composition is concerned, the refectory shows principally three kinds of masonry:

- A lower level brick masonry with thin mortar joint related to USM 1-2-9-8-6-7-4-3-5-50-118-119-120-49-51-44-45-1-43-109-55-56-57-52-53-54;
- A medium level brick masonry with large mortar joint related to USM 12-36-37-10-11-13-14-23-16-15-46-48;
- An upper level modern brick masonry referred to USM 70.

The lower level of the brick masonry is composed of several units and the larger units among them are USM 1, USM 2 and USM 5. From a stratigraphic point of view this brick masonry is covered by the principal layers of plaster (USR 14 – USR 9 – USR 7 – USR 6 – USR 30 – USR 4 – USR 5) referred to original plaster located externally and internally the removed gallery.

The medium level brick masonry is above the lower brick masonry and this relation is marked and evidenced observing the edges among these units, for example between USM 2 and USM 14. Moreover, this brick layer is also below plaster layers mentioned before.

These three principal layers, the two brick masonries and the plaster layer, are cut by the removal of buttresses, and these cutting actions are referred to stratigraphic negative units -7; -5; -1; -3; -12; -13; -14; -15; -2; -4; -6; -8. Through these evidences the original profile of five external buttresses can be defined and noticed. This removing operation has been covered by a modern grey mortar referred to USM 99, USM 100, USM 101, USM 102, USM 103.

The original height of the refectory is evidenced by the presence of two kinds of suspended round arches: the first group (EA 19 and EA 20) is located on the right side of the front and it concerning the oldest typology of medieval protruding arches while the second group (EA9-EA14-EA10-EA11-EA12-EA13-132-EA15-EA16-EA17-EA18) is referred to medieval cross round arches into the central part of the front. Both groups of arches have suffered the removal of buttresses and a consequent loss of material.

As far as the opening elements are concerning, this front has several elements classified as windows and entrance portal: EA 1 is referred to the original round arch access to the *calefactorium*, and it has a fine plaster (USR 29); EA 2 is the original and actual pointed arch access to the refectory having a modern plaster layer (USR 8, USR 10, USR 11, USR 12, USR 13); EA 3 is related to the access to the second floor (USM 70). Two more portals can be detected on the right side of the front, under the actual partial gallery: the ancient profile of the entrance to the kitchen can be noticed by stone units USM 118, USM 120 as well as USM 119 (classification as an architectural element has not to be done due to its undefined profile) and now it is covered by a curtain wall USM 96 and also by the main plaster under the actual gallery (USR 22). Another portal (EA 31) can be noticed on the same side of the front, on the corner to the west side of the cloister, and it has been filled by a curtain wall USM 97 and successively by the USR 27 plaster.

Lower level windows are referred to four openings: two small circular openings (USM 106 and -16) related to the square internal windows of the refectory; two more windows (EA 4 and EA 5) are referred to rectangular windows

under the actual gallery and they are characterized by the presence of cuts on masonry (-17 and -19) and also a covering plaster (USR 25 and USR 27). Moreover, the EA 5 windows have been opened on the curtain wall USM 97 that fills the EA 31 portal.

Higher level windows are related to the newest brick masonry construction of the first floor (USM70 and EA 29). These contemporary windows have been classified as architectural elements (EA 25 – EA 23 – EA 26 – EA 21 – EA 30 – EA 22 – EA 28 – EA 27 – EA 24) and also by identifying single profiles of each window (71-72-73-74-75-76-77-78-79-80-81-82-83-84-85-86-87). These opening elements experienced a partial reduction of their height by covering operations with curtain walls (USM 88 - USM 89 - USM 90 - USM 91 - USM 92 - USM 93 - USM 94 - USM 95). Among them, only the EA 30 window has been entirely covered by USM 88.

Furthermore, in this front can be noticed other particular evidence referred to maintenance operations and in a single case to a decorative inclusion. Maintenance operations could be related to -10 and -11 cuts on masonry (lower and medium level of brick masonry) and the following covering USM 63 and USM 64. In this group could be included the negative unit -20 and its filling unit USR 23, that is above the USR 22 plaster layer, and also the USM 96 that is above the brick masonry related to the first group of suspended arches.

Particular evidence is concerning the USM 117 related to a decorative stone element, and its cut on masonry and filling unit (-18 and USR 26). Moreover, on the medium level brick masonry can be found three stone shelves (EA 6, EA 7, EA 8), probably referred to the wooden ceiling of the gallery, and from this latest remain only seven marks on the plaster (USM 110 – USM 111 - USM 112 - USM 113 - USM 114 - USM 115 - USM 116).

Covered by USR 2 plaster layer and by 11 cuts on masonry and the following covering USM 64, the USM 109 is referred probably to a round arch, even if it is hard to define.

Stratigraphic units and elements that allow to connect the internal (north front) and external stratigraphy of the refectory can be noticed on two small circular openings (USM 106 and -16), the entrance portal (EA 2) and its plaster layer (USR 11). Moreover, another element can be found: this is the case of the bolted-end plate USM 108 and its relative reinforcing anchor that passes through the internal part of the refectory (inside the two small chambers) and let out of the external front related to the backyard of the restaurant. This reinforcing bar could be related to the new vaulted ceiling, differently from the other bolted-end plate USM 107 that haven't internal matches.

Table 8. South front of the cloister stratigraphic units and description

| UNITS NUMBER | MATERIAL        | DESCRIPTION  |
|--------------|-----------------|--|
| EA 1         | brick           | profile of the entrance portal of the <i>calefactorium</i>   |
| EA 2         | brick           | profile of the entrance portal of the refectory              |
| EA 3         | wood            | portal for the upper floor access                            |
| EA 4         | brick and metal | square window with metal bars                                |
| EA 5         | brick and metal | square window with metal bars                                |
| EA 6         | stone           | stone shelf supporting the old wooden ceiling of the gallery |
| EA 7         | stone           | stone shelf supporting the old wooden ceiling of the gallery |
| EA 8         | stone           | stone shelf supporting the old wooden ceiling of the gallery |
| EA 9         | brick           | Second type medieval suspended arches                        |
| EA 10        | brick           | Second type medieval suspended arches                        |
| EA 11        | brick           | Second type medieval suspended arches                        |
| EA 12        | brick           | Second type medieval suspended arches                        |
| EA 13        | brick           | Second type medieval suspended arches                        |
| EA 14        | brick           | Second type medieval suspended arches                        |
| EA 15        | brick           | Second type medieval suspended arches                        |
| EA 16        | brick           | Second type medieval suspended arches                        |
| EA 17        | brick           | Second type medieval suspended arches                        |
| EA 18        | brick           | Second type medieval suspended arches                        |
| EA 19        | brick           | First type medieval suspended arches                         |
| EA 20        | brick           | First type medieval suspended arches                         |
| EA 21        | wood            | square modern window of the second floor                     |
| EA 22        | wood            | square modern window of the second floor                     |
| EA 23        | wood            | square modern window of the second floor                     |
| EA 24        | wood            | square modern window of the second floor                     |
| EA 25        | wood            | square modern window of the second floor                     |
| EA 26        | wood            | square modern window of the second floor                     |
| EA 27        | wood            | square modern window of the second floor                     |
| EA 28        | wood            | square modern window of the second floor                     |
| EA 29        | brick           | ledge of the wall  |
| EA 30        | brick           | walled square modern window of the second floor              |
| EA 31        | brick           | profile of a walled entrance                                 |
| USM 1        | brick           | Brick masonry with thin mortar joint                         |
| USM 2        | brick           | Brick masonry with thin mortar joint                         |
| USM 3        | brick           | Brick masonry with thin mortar joint                         |
| USM 4        | brick           | Brick masonry with thin mortar joint                         |
| USM 5        | brick           | Brick masonry with thin mortar joint                         |
| USM 6        | brick           | Brick masonry with thin mortar joint                         |
| USM 7        | brick           | Brick masonry with thin mortar joint                         |
| USM 8        | brick           | Brick masonry with thin mortar joint                         |

|        |       |  |
|--------|-------|--|
| USM 9  | brick | Brick masonry with thin mortar joint                                 |
| USM 10 | brick | Brick masonry with large mortar joint                                |
| USM 11 | brick | Brick masonry with large mortar joint                                |
| USM 12 | brick | Brick masonry with large mortar joint                                |
| USM 13 | brick | Brick masonry with large mortar joint                                |
| USM 14 | brick | Brick masonry with large mortar joint                                |
| USM 15 | brick | Brick masonry with large mortar joint                                |
| USM 16 | brick | Brick masonry with large mortar joint                                |
| USM 17 | brick | Brick masonry with large mortar joint                                |
| USM 18 | brick | Brick masonry with large mortar joint                                |
| USM 19 | brick | Brick masonry with large mortar joint                                |
| USM 20 | brick | Brick masonry with large mortar joint                                |
| USM 21 | brick | Brick masonry with large mortar joint                                |
| USM 22 | brick | Brick masonry with large mortar joint                                |
| USM 23 | brick | Brick masonry with large mortar joint                                |
| USM 24 | brick | Brick masonry with large mortar joint                                |
| USM 25 | brick | Brick masonry with large mortar joint                                |
| USM 26 | brick | Brick masonry with large mortar joint                                |
| USM 27 | brick | Brick masonry with large mortar joint                                |
| USM 28 | brick | Brick masonry with large mortar joint                                |
| USM 29 | brick | Brick masonry with large mortar joint                                |
| USM 30 | brick | Brick masonry with large mortar joint                                |
| USM 31 | brick | Brick masonry with large mortar joint                                |
| USM 32 | brick | Brick masonry with large mortar joint                                |
| USM 33 | brick | Brick masonry with large mortar joint                                |
| USM 34 | brick | Brick masonry with large mortar joint                                |
| USM 35 | brick | Brick masonry with large mortar joint                                |
| USM 36 | brick | Brick masonry with large mortar joint                                |
| USM 37 | brick | Brick masonry with large mortar joint                                |
| USM 38 | brick | Brick masonry with large mortar joint                                |
| USM 39 | brick | Brick masonry with large mortar joint                                |
| USM 40 | brick | Brick masonry with large mortar joint                                |
| USM 41 | brick | Brick masonry with large mortar joint                                |
| USM 42 | brick | Brick masonry with large mortar joint                                |
| USM 43 | brick | Brick masonry with thin mortar joint                                 |
| USM 44 | brick | Brick masonry with thin mortar joint (bricks with dissolved plaster) |
| USM 45 | brick | Brick masonry with thin mortar joint                                 |
| USM 46 | brick | Brick masonry with consumed mortar joint                             |
| USM 47 | brick | Brick masonry with thin mortar joint                                 |
| USM 48 | brick | Brick masonry with thin mortar joint                                 |
| USM 49 | brick | Brick masonry with thin mortar joint                                 |

|        |                   |   |
|--------|-------------------|---|
| USM 50 | brick             | Brick masonry with thin mortar joint                      |
| USM 51 | brick             | Brick masonry with thin mortar joint                      |
| USM 52 | brick             | Brick masonry with thin mortar joint                      |
| USM 53 | brick             | Brick masonry with thin mortar joint                      |
| USM 54 | brick             | Brick masonry with thin mortar joint                      |
| USM 55 | brick             | Brick masonry with thin mortar joint                      |
| USM 56 | brick             | Brick masonry with thin mortar joint                      |
| USM 57 | brick             | Brick masonry with thin mortar joint                      |
| USM 58 | brick             | Brick masonry with thin mortar joint                      |
| USM 59 | brick             | Brick masonry with thin mortar joint                      |
| USM 60 | brick             | Brick masonry with thin mortar joint                      |
| USM 61 | brick             | brick frame related to the first type of suspended arches |
| USM 62 | brick             | brick frame related to the first type of suspended arches |
| USM 63 | brick and plaster | coverage brick layer                                      |
| USM 64 | brick and plaster | coverage brick and plaster layer                          |
| USM 65 | brick             | brick masonry below the suspended arches                  |
| USM 66 | brick             | brick masonry below the second type of suspended arches   |
| USM 67 | brick             | brick masonry below the second type of suspended arches   |
| USM 68 | brick             | brick masonry below the second type of suspended arches   |
| USM 69 | brick             | brick masonry below the first type of suspended arches    |
| USM 70 | brick             | modern brick masonry related to the second floor          |
| USM 71 | wood              | wooden beam (frame)                                       |
| USM 72 | brick             | brick profile of square window                            |
| USM 73 | brick             | brick profile of square window                            |
| USM 74 | brick             | brick profile of square window                            |
| USM 75 | brick             | brick profile of square window                            |
| USM 76 | brick             | brick profile of square window                            |
| USM 77 | brick             | brick profile of square window                            |
| USM 78 | brick             | brick profile of square window                            |
| USM 79 | brick             | brick profile of square window                            |
| USM 80 | brick             | brick profile of square window                            |
| USM 81 | brick             | brick profile of square window                            |
| USM 82 | brick             | brick profile of square window                            |
| USM 83 | brick             | brick profile of square window                            |
| USM 84 | brick             | brick profile of square window                            |
| USM 85 | brick             | brick profile of square window                            |
| USM 86 | brick             | brick profile of square window                            |
| USM 87 | brick             | brick profile of square window                            |
| USM 88 | brick             | curtain wall referred to the walled window                |
| USM 89 | brick             | curtain wall referred to the partially walled window      |
| USM 90 | brick             | curtain wall referred to the partially walled window      |

|         |                   |  |
|---------|-------------------|--|
| USM 91  | brick             | curtain wall referred to the partially walled window       |
| USM 92  | brick             | curtain wall referred to the partially walled window       |
| USM 93  | brick             | curtain wall referred to the partially walled window       |
| USM 94  | brick             | curtain wall referred to the partially walled window       |
| USM 95  | brick             | curtain wall referred to the partially walled window       |
| USM 96  | brick             | curtain wall referred to the portal of the kitchen         |
| USM 97  | brick             | curtain wall referred to the portal                        |
| USM 98  | plaster           | plaster layer  |
| USM 99  | render / plaster  | render layer referred to the removed buttresses            |
| USM 100 | render / plaster  | render layer referred to the removed buttresses            |
| USM 101 | render / plaster  | render layer referred to the removed buttresses            |
| USM 102 | render / plaster  | render layer referred to the removed buttresses            |
| USM 103 | render / plaster  | render layer referred to the removed buttresses            |
| USM 104 | brick             | Brick masonry with large mortar joint                      |
| USM 105 | brick             | Brick masonry with thin mortar joint                       |
| USM 106 | brick             | brick profile of the circular window                       |
| USM 107 | metal             | bolted end plate of metal anchor (head)                    |
| USM 108 | metal             | bolted end plate of metal anchor (head)                    |
| USM 109 | brick             | evidence of brick profile of an arch                       |
| USM 110 | /                 | profile of arches related to the removed gallery ceiling   |
| USM 111 | /                 | profile of arches related to the removed gallery ceiling   |
| USM 112 | /                 | profile of arches related to the removed gallery ceiling   |
| USM 113 | /                 | profile of arches related to the removed gallery ceiling   |
| USM 114 | /                 | profile of arches related to the removed gallery ceiling   |
| USM 115 | /                 | profile of arches related to the removed gallery ceiling   |
| USM 116 | /                 | profile of arches related to the removed gallery ceiling   |
| USM 117 | stone             | stone decoration related to Pope symbols                   |
| USM 118 | stone             | stone block referred to the kitchen portal                 |
| USM 119 | brick and plaster | profile referred to the kitchen portal                     |
| USM 120 | stone             | stone blocks referred to the kitchen portal                |
| USM 121 | brick             | brick frame related to the second type of suspended arches |
| USM 122 | brick             | brick frame related to the second type of suspended arches |
| USM 123 | brick             | brick frame related to the second type of suspended arches |
| USM 124 | brick             | brick frame related to the second type of suspended arches |
| USM 125 | brick             | brick frame related to the second type of suspended arches |
| USM 126 | brick             | brick frame related to the second type of suspended arches |
| USM 127 | brick             | brick frame related to the second type of suspended arches |
| USM 128 | brick             | brick frame related to the second type of suspended arches |
| USM 129 | brick             | brick frame related to the second type of suspended arches |
| USM 130 | brick             | brick frame related to the second type of suspended arches |
| USM 131 | brick             | brick frame related to the second type of suspended arches |

|         |                  |   |
|---------|------------------|---|
| USM 132 | brick            | brick frame related to the second type of suspended arches  |
| USM 133 | brick            | brick frame related to the second type of suspended arches  |
| USR 1   | render / plaster | dissolved plaster related to the removed gallery            |
| USR 2   | plaster          | plaster related to the removed gallery                      |
| USR 3   | render / plaster | dissolved plaster related to the removed gallery            |
| USR 4   | plaster          | plaster related to the removed gallery                      |
| USR 5   | plaster          | plaster related to the removed gallery                      |
| USR 6   | plaster          | plaster related to the removed gallery                      |
| USR 7   | plaster          | plaster related to the removed gallery                      |
| USR 8   | plaster          | plaster of the entrance portal of the refectory             |
| USR 9   | plaster          | plaster related to the removed gallery                      |
| USR 10  | plaster          | plaster of the entrance portal of the refectory             |
| USR 11  | plaster          | plaster of the entrance portal of the refectory             |
| USR 12  | plaster          | plaster of the entrance portal of the refectory             |
| USR 13  | plaster          | plaster of the entrance portal of the refectory             |
| USR 14  | plaster          | plaster related to the removed gallery                      |
| USR 15  | plaster          | plaster related to the removed gallery                      |
| USR 16  | plaster          | plaster related to the removed gallery                      |
| USR 17  | plaster          | plaster related to the removed gallery                      |
| USR 18  | plaster          | plaster related to the removed gallery                      |
| USR 19  | plaster          | plaster related to the removed gallery                      |
| USR 20  | plaster          | plaster below the second type of suspended arches           |
| USR 21  | plaster          | plaster below the first type of suspended arches            |
| USR 22  | plaster          | modern plaster of the wall below the actual partial gallery |
| USR 23  | plaster          | modern plaster / render                                     |
| USR 24  | plaster          | plaster related to the curtain wall                         |
| USR 25  | plaster          | modern plaster / render related to the window               |
| USR 26  | plaster          | modern plaster / render related to the stone decoration     |
| USR 27  | plaster          | modern plaster / render related to the curtain wall         |
| USR 28  | plaster          | modern plaster / render below the window                    |
| USR 29  | plaster          | plaster / render related to the portal of the calefactorium |
| USR 30  | plaster          | plaster related to the removed gallery                      |
| USM -1  | / (brick)        | lack of material (brick) related to the removed buttresses  |
| USM -2  | / (brick)        | lack of material (brick) related to the removed buttresses  |
| USM -3  | / (brick)        | lack of material (brick) related to the removed buttresses  |
| USM -4  | / (brick)        | lack of material (brick) related to the removed buttresses  |
| USM -5  | / (brick)        | lack of material (brick) related to the removed buttresses  |
| USM -6  | / (brick)        | lack of material (brick) related to the removed buttresses  |
| USM -7  | / (brick)        | lack of material (brick) related to the removed buttresses  |
| USM -8  | / (brick)        | lack of material (brick) related to the removed buttresses  |
| USM -9  | /                | cut on masonry  |



|         |          |  |
|---------|----------|--|
| USM -10 | /        | cut on masonry                                 |
| USM -11 | /        | cut on masonry                                 |
| USM -12 | /(brick) | profile of the removed buttresses              |
| USM -13 | /(brick) | profile of the removed buttresses              |
| USM -14 | /(brick) | profile of the removed buttresses              |
| USM -15 | /(brick) | profile of the removed buttresses              |
| USM -16 | /        | cut on masonry referred to the circular window |
| USM -17 | /        | cut on masonry referred to the window          |
| USM -18 | /        | cut on masonry referred to the decoration      |
| USM -19 | /        | cut on masonry referred to the window          |
| USM -20 | /        | cut on masonry referred to the render coverage |

### **North wall of the refectory**

The north wall is characterized by the presence of opening elements concerning two small square windows (EA 33 and EA 36) that correspond to the two small circular openings on the external front (USM 106 and -16), and also includes the entrance portal (EA 2.2). These opening elements have different identification numbers for a different reason: the two small square internal windows can be classified as an architectural element because they can be defined as windows elements, differently from the corresponding pieces of evidences visible on the external front because they are characterized by a small circular opening obtained by a cut on masonry (-16) and obtained on the same masonry (USM 106). Moreover, the entrance portal has been classified by using a decimal value by contrast with the external identification (EA 2) because, despite it has the same architectural element role, on the inner part of the refectory it shows a different shape with a different type of arch: externally pointed arch, internally depressed arch. This solution might suggest a partial rebuilt of this architectural element.

The main masonry of the north wall is referred to brick masonry USM 134, USM 135, USM 136, USM 137. From a stratigraphic point of view this masonry is below the brick semi-column with stone capital (EA 35), despite it can be considered contemporary to the masonry because it is concerning the old ceiling. This wall shows a great complexity of plaster layers. In fact, there are five kinds of plaster layers:

- The more evident is referred to USR 39 and USR 40 which have a regular linear pattern and also it has a regular average height of 2.35 m from the ground, despite USR 40 it is more degraded and does not reach the ground, unlike USR 39. This plaster layer has to be compared and related to the lower level external brick

masonry mentioned before, because it shows the same average height from the ground: 2,30 m.

- On the upper part of the wall can be noticed the presence of another plaster layer composed by USR 36, USR 37, USR 38 and this layer is above the brick masonry and one of the two brick brackets (EA 32 and 34) related to the new vaulted system and below the previous plaster layer and below the following two layers;
- Next is referred to the plaster layers of bezels concerning the new vaulted system (USR31, USR 32, USR 33, USR 34, USR 35) that cover the previous plaster layer and it is leaning on the four vaults bays (EA 57.7, EA 57.5, EA 57.3, EA 57.1);
- The other plaster layer is related to the plaster of the entrance portal (USR 11) that is the same layer of the external front. From a stratigraphic point of view, it is above the previous units, including the brick masonry but except the plaster of the bezels because there are no connections among them;
- Last plaster layer is referred to the decorative plaster on the brick semi-column (USR 41), that shows a red / orange brick imitation pattern. This layer has stratigraphic relation just to the semi-column.

This wall shows different cuts and interventions on the masonry. In this regard, the cut related to the old ceiling removal is evidenced by the negative unit -25, moreover, three more cuts on masonry (-23, -24, -26) are probably referred to a material and components removal, and two of them (-26 and -24) are placed at the same height from the ground and have a bolted-end plate shape concerning probably two reinforcing anchors. Finally, two more negative units (-21 and -22) are referred to the cuts on masonry for the square opening elements.

Table 9. Stratigraphic units and description related to the north wall of the refectory

| UNITS NUMBER | MATERIAL              | DESCRIPTION   |
|--------------|-----------------------|---|
| EA 2.2       | Brick and plaster     | Entrance of the refectory   |
| EA 32        | Brick                 | Brick bracket of the new vaulted ceiling  |
| EA 33        | Brick                 | Square window / opening   |
| EA 34        | Brick                 | Brick bracket of the new vaulted ceiling  |
| EA 35        | Brick, stone, plaster | Semi-column of the old ceiling, with stone capital and tours and plaster on capital |

|         |                          |  |
|---------|--------------------------|--|
| EA 36   | Brick                    | Square window / opening                              |
| EA 57.1 | Brick and plaster        | Groin vaults and arches related to the new ceiling   |
| EA 57.3 | Brick and plaster        | Groin vaults and arches related to the new ceiling   |
| EA 57.5 | Brick and plaster        | Groin vaults and arches related to the new ceiling   |
| EA 57.7 | Brick and plaster        | Groin vaults and arches related to the new ceiling   |
| USR 11  | Plaster                  | Plaster of the entrance door of the Refectory        |
| USR 31  | Plaster                  | Plaster on bezel of the new vaulted ceiling          |
| USR 32  | Plaster                  | Plaster on bezel of the new vaulted ceiling          |
| USR 33  | Plaster                  | Plaster on bezel of the new vaulted ceiling          |
| USR 34  | Plaster                  | Plaster on bezel of the new vaulted ceiling          |
| USR 35  | Plaster                  | Plaster on bezel of the new vaulted ceiling          |
| USR 36  | Plaster                  | Plaster, probably of the oldest inside the refectory |
| USR 37  | Plaster                  | Plaster, probably of the oldest inside the refectory |
| USR 38  | Plaster                  | Plaster, probably of the oldest inside the refectory |
| USR 39  | Brick and plaster/render | Brick masonry with plaster and render                |
| USR 40  | Brick and plaster/render | Brick masonry with plaster and render                |
| USR 41  | Plaster                  | Plaster of the capital of the semi-column            |
| USM -21 | /                        | Cut of the square window                             |
| USM -22 | /                        | Cut of the square window                             |
| USM -23 | /                        | Lack of material                                     |
| USM -24 | /                        | Lack of material: probably a bolted end-plate        |
| USM -25 | /                        | Cut of a support for the old ceiling                 |
| USM -26 | /                        | Lack of material: probably a bolted end-plate        |
| USM 134 | Brick                    | Brick masonry  |
| USM 135 | Brick                    | Brick masonry  |
| USM 136 | Brick                    | Brick masonry  |
| USM 137 | Brick                    | Brick masonry  |

### East wall of the refectory

The east wall of the refectory is characterized especially by the presence of the *Ultima Cena* fresco (USR 45) dated at the first years of the XV century and by covered access (EA 37) filled with a curtain wall (USM 143). The portal, which has been probably opened successively the fresco realization due to the cut (-35) on it and on the preparatory plaster below the fresco units (USR 44), led to the *calefactorium* chamber.

The ruined polychrome fresco representing the *Ultima Cena* scene, analysing its dimension and the relative cut, probably stretched over the entire wall surface and, as described into the *Case study: the refectory of Staffarda abbey* chapter, it shows Jesus Christ and the evidence of apostles seated at the table on which it can

be noticed food (bread) and evidence of a knife. Fresco and its preparatory plaster are above the principal brick masonry, related to USM 138 - USM 139 - USM 140 - USM 141 - USM 142. However, the fresco unit is below the two plaster units referred to the new vaulted ceiling (USR 42 and USR 43).

Moreover, the east wall shows also the presence of the cornering column without capital (EA 38) shared with the south wall and referred to the old ceiling. Lately, from the stratigraphic point of view the bays of the vaults referred to EA 57.1 and EA 57.2 are respectively above USM 142 and USR 45 (fresco), and furthermore they are below from plaster referred to USR 42 and USR 43.

Table 10. Stratigraphic units and description related to the east wall of the refectory

| UNITS NUMBER | MATERIAL                 | DESCRIPTION   |
|--------------|--------------------------|---|
| EA 37        | Brick                    | walled entrance   |
| EA 38        | Brick and plaster, stone | Corner Column with stone torus, referred to the old ceiling |
| EA 57.1      | Brick and plaster        | Groin vaults and arches related to the new ceiling          |
| EA 57.2      | Brick and plaster        | Groin vaults and arches related to the new ceiling          |
| USR 42       | Plaster                  | Plaster on bezel of the new vaulted ceiling                 |
| USR 43       | Plaster                  | Plaster on bezel of the new vaulted ceiling                 |
| USR 44       | Plasterwork              | Groundwork layer for Ultima Cena Fresco                     |
| USR 45       | Fresco                   | Ultima Cena Fresco  |
| USM -35      | /                        | Cut on plaster and fresco probably for the portal           |
| USM 138      | Brick                    | Brick masonry   |
| USM 139      | Brick                    | Brick masonry   |
| USM 140      | Brick                    | Brick masonry   |
| USM 141      | Brick                    | Brick masonry   |
| USM 142      | Brick and plaster        | Brick masonry with plaster                                  |
| USM 143      | Brick                    | Curtain Wall of the entrance                                |

### South wall of the refectory

The south wall shows has a great complexity into stratification evidence, and this density is especially due to the number of openings elements: indeed, it is characterized by the presence of four original single lancet windows (EA 44 - EA 46 - EA 48 - EA 49), which have rhomboidal lozenges decoration. Amongst these architectural elements, the EA 46 is the only one preserved in its entirety and

functionality, because two of them are filled (USM 153 and USM 155) and another one is cut (-30) for the purpose of opening access (EA 50) to the south courtyard.

The other opening elements are referred to the original entrance (EA 39) of the pulpit (accessible with bricks stairs and now interrupted by a curtain wall), and also to the opening element (similar to a single lancet irregular window) created after the pulpit removal (EA 42). As mentioned in chapter 3, in modern times the pulpit has been removed (-27 and -28) although its original shape can be noticed (probably funnel shape).

As far as the opening elements are concerned, the south wall shows also three more square windows on top of the masonry (EA 40, EA 51, EA 52), and two of them are partially cut by the new groin vault system (EA 57.6 and EA 57.8) and covered by a curtain wall (not included on the stratigraphy).

The main masonry is related to USM 144, USM 145, USM 146, USM 147, USM 148, USM 149, USM 150, USM 151, USM 152. The opening elements mentioned before should be considered contemporary of this masonry, also because they do not show cut on masonry. Other contemporary elements referred to main masonry are concerning the elements that supported the original ceiling, such as the semi brick column with stone capital (EA 43), comparable to the other one on the north wall, the small stone shelf (EA 47) and of course the cornering column (EA 38) shared with the east wall.

The wall shows a great complexity also as far as cuts and modern interventions are concerned: these are related to pulpit removal (-27 and -28) and the following curtain wall (154). The evidences regarding the old ceiling removal are related to negative units -29 (on semi brick column) and -31 (on stone shelf). As mentioned in chapter 3, the actual ceiling is concerning into a modern groined vaulted system. Following the proposal bays subdivision, the vaulted system concerning this wall is related to these bays EA 57.2, EA 57.4, EA 57.6, EA 57.8. Only three of them (EA 57.2, EA 57.4, EA 57.6) are leaning on two brick brackets (EA 41 and EA 45) concerning the impost blocks. From a stratigraphic point of view, these bays are below the plaster layer of the bezels (USR 46, USR 47, USR 48, USR 49), created after the construction of the new ceiling.

As far as plaster layers are concerned, the main plaster layer on this wall masonry is meant to USR 51, USR 53, USR 54, which cover the brick masonry and partially also the curtain wall USM 153 related to a single lancet window EA 44 and it has a linear pattern on the central part of the wall and has a regular average height of 2.40 m from the ground. This plaster layer, due to its height from the ground, could be compared to the other plaster layers of the north front (USR 39 and USR 40).

Table 11. Stratigraphic units and description related to the south wall of the refectory

| UNITS NUMBER | MATERIAL                  | DESCRIPTION  |
|--------------|---------------------------|--|
| EA 38        | Brick and plaster, stone  | Corner Column with stone tours, referred to the old ceiling      |
| EA 39        | Brick and plaster         | Brick and plaster arch of the old entrance of pulpit             |
| EA 40        | Brick and plaster, render | Square window / opening  |
| EA 41        | Brick                     | Brick bracket of the new vaulted ceiling                         |
| EA 42        | Brick                     | Profile of the opening of the old pulpit                         |
| EA 43        | Brick and stone           | Semi-column of the old ceiling, with stone capital and tours     |
| EA 44        | Brick                     | Profile of the walled single lancet window                       |
| EA 45        | Brick and stone           | Brick and stone bracket of the new vaulted ceiling               |
| EA 46        | Brick, plaster and render | Brick single lancet window, with plaster and render              |
| EA 47        | Stone                     | Stone bracket of the old ceiling                                 |
| EA 48        | Brick                     | Partially walled single lancet window                            |
| EA 49        | Brick                     | Profile of the walled single lancet window                       |
| EA 50        | Wood                      | Opening / Wooden Door carpentry                                  |
| EA 51        | Brick                     | Walled brick window  |
| EA 52        | Brick and render          | Walled brick window and render                                   |
| EA 57.2      | Brick and plaster         | Groin vaults and arches related to the new ceiling               |
| EA 57.4      | Brick and plaster         | Groin vaults and arches related to the new ceiling               |
| EA 57.6      | Brick and plaster         | Groin vaults and arches related to the new ceiling               |
| EA 57.8      | Brick and plaster         | Groin vaults and arches related to the new ceiling               |
| USR 46       | Plaster                   | Plaster referred to the new vaulted ceiling                      |
| USR 47       | Plaster                   | Plaster referred to the new vaulted ceiling                      |
| USR 48       | Plaster                   | Plaster referred to the new vaulted ceiling                      |
| USR 49       | Plaster                   | Plaster referred to the new vaulted ceiling                      |
| USR 50       | Plaster                   | Plaster referred to the new vaulted ceiling                      |
| USR 51       | Brick and plaster         | Brick masonry with plaster                                       |
| USR 52       | Plaster                   | Plaster referred to the new vaulted ceiling                      |
| USR 53       | Brick and plaster         | Brick masonry with plaster                                       |
| USR 54       | Brick and plaster         | Brick masonry with plaster                                       |
| USM -27      | /                         | Cut / disassembly of the pulpit                                  |
| USM -28      | /                         | Cut / disassembly of the pulpit (lack of material)               |
| USM -29      | /                         | Cut of a support for the old ceiling                             |
| USM -30      | /                         | Cut of the wall and single lancet window for the entrance / door |
| USM -31      | /                         | Cut of a support for the old ceiling                             |
| USM -32      | /                         | Cut for the bracket referred to the new vaulted ceiling          |
| USM -33      | /                         | Cut for the bracket referred to the new vaulted ceiling          |
| USM 144      | Brick                     | Brick masonry  |
| USM 145      | Brick                     | Brick masonry  |
| USM 146      | Brick                     | Brick masonry  |

|         |       |  |
|---------|-------|--|
| USM 147 | Brick | Brick masonry                            |
| USM 148 | Brick | Brick masonry                            |
| USM 149 | Brick | Brick masonry                            |
| USM 150 | Brick | Brick masonry                            |
| USM 151 | Brick | Brick masonry                            |
| USM 152 | Brick | Brick masonry                            |
| USM 153 | Brick | Curtain Wall of the single lancet window |
| USM 154 | Brick | Curtain Wall of part of the pulpit       |
| USM 155 | Brick | Curtain Wall of the single lancet window |

### West wall of the refectory

The west wall of the refectory is consisting of the two curtain walls (USM 156 - USM 157 - USM 158) leaning on the partially covered pillar (EA 54.1), on the vaulted system related to bays EA 57.7 and EA 57.8 and on south and north walls. The units concerning the west wall divide the original entire space of the refectory in two parts (breaking up the south and north wall continuity). The left side of the west wall is characterized by the presence of two openings referred to the access (EA 53) to the small chambers and referred to a window without frames (EA 56) having metal bars, by contrast the other window (EA 55) on the right side of the wall is composed by a wooden frame. Furthermore, the wooden beam on the left side of the wall, shows, in addition to an inscription “XV” that shouldn’t be considered as chronological evidence, a piece of evidence of a cut socket on the pillar (-34). So, in this wall stratigraphic relations are referred principally to the masonries leaning on the pillar, in order to create two separate spaces.

Table 12. Stratigraphic units and description related to the west wall of the refectory

| UNITS NUMBER | MATERIAL          | DESCRIPTION  |
|--------------|-------------------|--|
| EA 53        | wood              | Wooden door  |
| EA 54.1      | Brick and plaster | Walled pillar                                      |
| EA 55        | wood              | Window – wooden carpentry                          |
| EA 56        | metal             | Window – metal carpentry                           |
| EA 57.8      | Brick and plaster | Groin vaults and arches related to the new ceiling |
| EA 57.7      | Brick and plaster | Groin vaults and arches related to the new ceiling |
| USM -34      | /                 | Cut on the pilaster                                |
| USM 156      | Brick and plaster | Brick masonry with plaster                         |

|         |                   |                            |
|---------|-------------------|----------------------------|
| USM 157 | Brick and plaster | Brick masonry with plaster |
| USM 158 | Brick and plaster | Brick masonry with plaster |
| USM 159 | Brick and plaster | Brick masonry with plaster |
| USM 160 | wood              | Wooden beam                |
| USM 161 | wood              | Wooden beam                |
| USM 162 | wood              | Wooden beam                |

As far as the internal stratigraphy of the refectory is concerned, the analysis of the brick semi-columns and stone shelves on the south and north walls has a fundamental importance for the purpose of understanding the right composition of the **old ceiling**. This next interpretation phase should be based on the stratigraphic analysis of these architectural elements and, furthermore, their placement in relation to the evidences of **buttresses** of the external fronts: just marks and evidences on the external south front of the cloister and preserved buttresses of the external front related to the backyard of the restaurant.

The stratigraphic analysis performed and then all the physical relations among units have been managed and processed by using the Harris' Matrix, which, as mentioned on the *Stratification and Stratigraphy* chapter, could be defined as a schematic diagram where the stratigraphic relations of stratigraphic units are given by connection lines on their identification numbers. This step played a fundamental role for the relative chronology (sequential chronology) and also for the absolute chronology (sequential chronology cross-checked with direct and indirect sources).





# Chapter 8

## Historical interpretation of the refectory

### 8.1 Matrix generation

As we have seen in chapter 4, the Harris' Matrix assumes a fundamental role in the interpretation phase, because it allows to establish **physical relations** among stratigraphic units. In fact, in this diagram the stratigraphic relations are managed by using connection lines on their identification numbers. Inside the matrix, relations among units can be three: no relation (no connection line); overlap relation (a vertical line connecting two units); equality relation (horizontal line or *equal mark* connecting two units).

The adoption of this diagram is a mandatory step of **interpretation and knowledge** as far as the archaeological sites are concerned as well as building archaeology studies. By using this solution could be easy managing simple excavation sites or wall masonries, however it required to be plan accurately for the purpose of disposing of connections lines and units, especially when matrix' connections intersecting each other. In this case, on intersections can be applied a semi-circular or rectangular *bridge* for the purpose of reading the continuity of lines. Furthermore, simplification is a required step for complexes matrix and it can be carried out by collecting equal or group of units and / or remove redundant lines. For example, this operation has been carried out for stratigraphic units of the external front of the refectory.

As far as the refectory is concerned, the creation of matrices experienced some issues especially related to the great quantity and complexity of stratigraphic units.

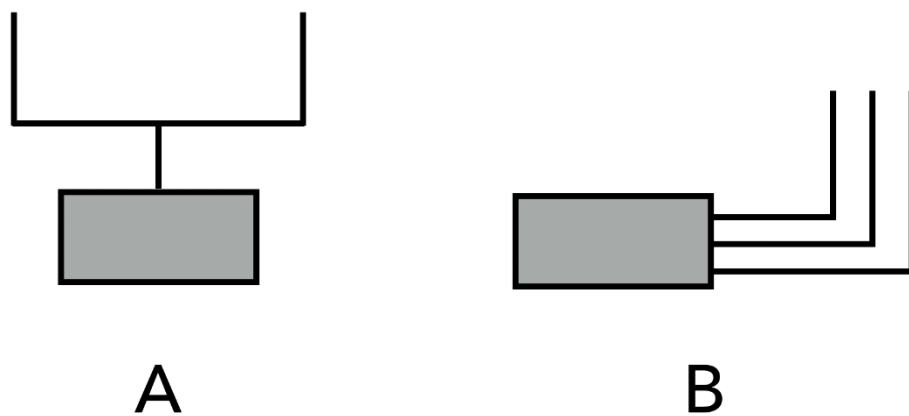

Figure 111. Matrix connection layout: A) classical branched matrix layout B) *transistor* similar matrix layout (elaboration F. Diara).

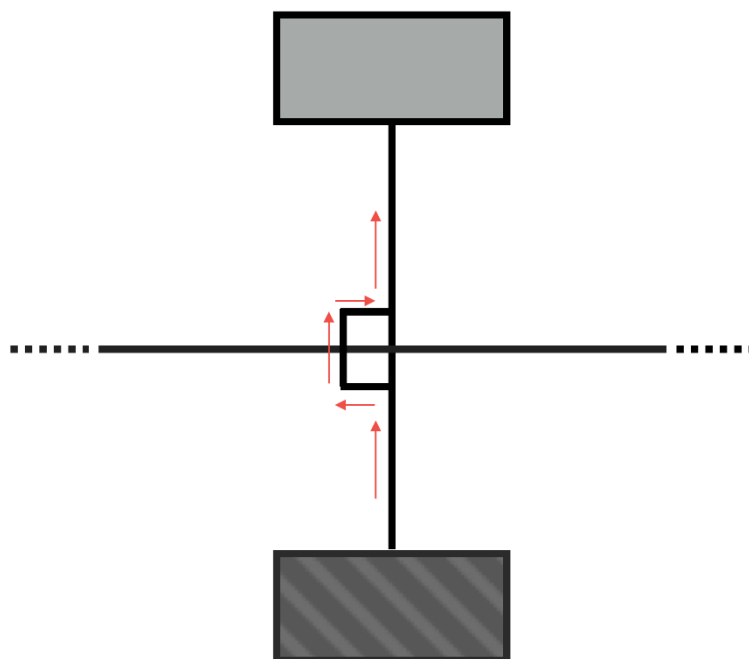

Figure 112. Example of square bridge and way of reading (elaboration F. Diara).

For this reason, in some cases where the complexity of units and relations was pronounced, the matrix' connections have not followed the classical branched layout on behalf of an atypical layout similar to *transistor connections*<sup>25</sup> (Fig.111). This kind of layout helped and eased the realization of complexes relations among units (for example south and north walls). Moreover, the utilization of *square bridges* for the cross intersections eased the readability of relations: for example, a relation line follows the way of the bridge, returning on the initial vertical or horizontal sliding; the relation line that passes through the bridge has no relation with the bridge (Fig.112).

As we will see, another issue affected the number of stratigraphic units, especially as regards the external front. To avoid this issue, overcoming complexes relations and intersections, a clustering operation has been carried out for the purpose of collecting units in a unique macro group. This solution allows a good readability of the external front of the refectory.

As last important notification, the Harris' matrix has to be read from the bottom up as well as the interpretation phases and chronological periods. Moreover, all analyses based on Harry' Matrix are referred to stratigraphic analysis that can be found on related orthophotos and units on attached TAV.1-2 – TAV.5-6 – TAV.9-10 – TAV.13-14 – TAV.17-18. Then, in order to better understand these analyses (for all references to images) we principally refer to the attached **orthophotos** and planar sections.

### **South front of the cloister**

As mentioned before, the matrix creation related to the external front of the refectory, on the south front of the cloister (TAV 1 and 2) has been performed by creating macro groups of some masonry and render / plaster units due to the great complexity of evidences. Moreover, this clustering operation has allowed an early critical interpretation of these units, easing the final interpretation phase.

These units concerning first of all lower brick masonry with a thin mortar joint (Fig.139) collected into three groups, **USM 1.0** – **USM 1.1** – **USM 1.2**; then has been classified as **USM 2.0** the medium level brick masonry with larger mortar joint; the higher modern brick masonry has been classified as **USM 3.0** including the related contemporary square windows, by contrast the curtain walls related to the filled windows have been listed as **USM 4.0**. For the same reason the main plaster referred to the removed gallery has been grouped and named **USR 1.0** and

---

<sup>25</sup> Transistors are semiconductor electronic devices having three parallel connections: emitter, base, collector

the plaster related to the entrance portal (composed by five units) has been grouped as **USR 2.0**. Another clustering operation has been performed for the purpose of collecting the suspended arches: in fact, the classification **EA 1.0** and **EA 2.0** has been used respectively for the oldest block of arches (including the masonry and plaster below) and for the other central block of suspended arches. Moreover, the profile of arches related to the removed ceiling of the gallery has been identified as **EA 3.1**, and in this case the decimal value name has been chosen due to the presence on the stratigraphic units list of an architectural element named EA 3.0. Lately, it was decided to grouped and classified as **USM -1.0** also the negative actions related to the removed buttresses.

This is the clustering operation performed on the external front of the refectory:

Lower level brick masonry (Thin mortar joint):

The lower brick masonry with thin mortar joint (Fig.139) has been grouped into three reference units, USM 1.0 on the central part of the front, USM 1.1 on the left side, USM 1.2 on the right side, and they include:

**USM 1.0:** 1-2-9-8-6-7-4-3-5-EA2-50-118-119-120-49-51

**USM 1.1:** 44-45-EA1-1-43-109

**USM 1.2:** 55-56-EA31-57-52-53-54

Medium level brick masonry (Large mortar joint):

The medium level brick masonry with large mortar joint has been grouped in a single units USM 2.0 and it includes:

**USM 2.0:** 12-36-37-10-11-13-14-23-16-15-46-48

High level modern brick masonry and square windows:

The high level modern brick masonry has been clustered including the contemporary square windows and this group includes:

**USM 3.0:** 70-EA25-EA23-EA26-EA21-EA30-EA22-EA28-EA27-EA24-71-72-73-74 75-76-77-78-79-80-81-82-83-84-85-86-87

Curtain walls related to filled square windows:

Masonry referred to curtain walls of square windows has been grouped in a single unit USM 4.0 and it includes:

**USM 4.0:** 88-89-90-91-92-93-94-95

Plaster referred to the removed gallery:

The original degraded plaster related to the removed gallery has been grouped in a single reference unit USR 1.0 and it includes:

**USR 1.0:** USR14-USR9-USR7-USR6-USR30-USR4-USR5

Plaster referred to the entrance portal:

Plaster concerning the entrance of the refectory has been grouped in a single reference unit USR 2.0 and it includes:

**USR 2.0:** USR8-USR10-USR11-USR12-USR13

Older block of suspended arches:

The first construction of suspended decorative arches has been defined in EA 1.0 and it includes:

**EA 1.0:** EA20-EA19-61-62-58-59-USR21

Central block of suspended arches:

The second construction of suspended decorative crossed arches has been defined in EA 2.0 and it includes:

**EA 2.0:**70-65-66-67-68-123-121-122-125-127-EA9-124-126-128-129-130-EA14  
EA10-EA11-EA12-EA13-132-EA15-EA16-EA17-131-133-EA18-USR20

Profile of arches related to the removed ceiling of the gallery

Profile of arches related to groined vaults of the removed ceiling has been defined in EA 3.1 and it includes:

**EA 3.1:** 110-111-112-113-114-115-116

Negative actions related to the removed buttresses

Negative units referred to the removal operations of buttresses has been defined in USM -1.0 and it includes:

**USM -1.0 (negative):** -7; -5; -1; -3; -12; -13; -14; -15; -2; -4; -6; -8

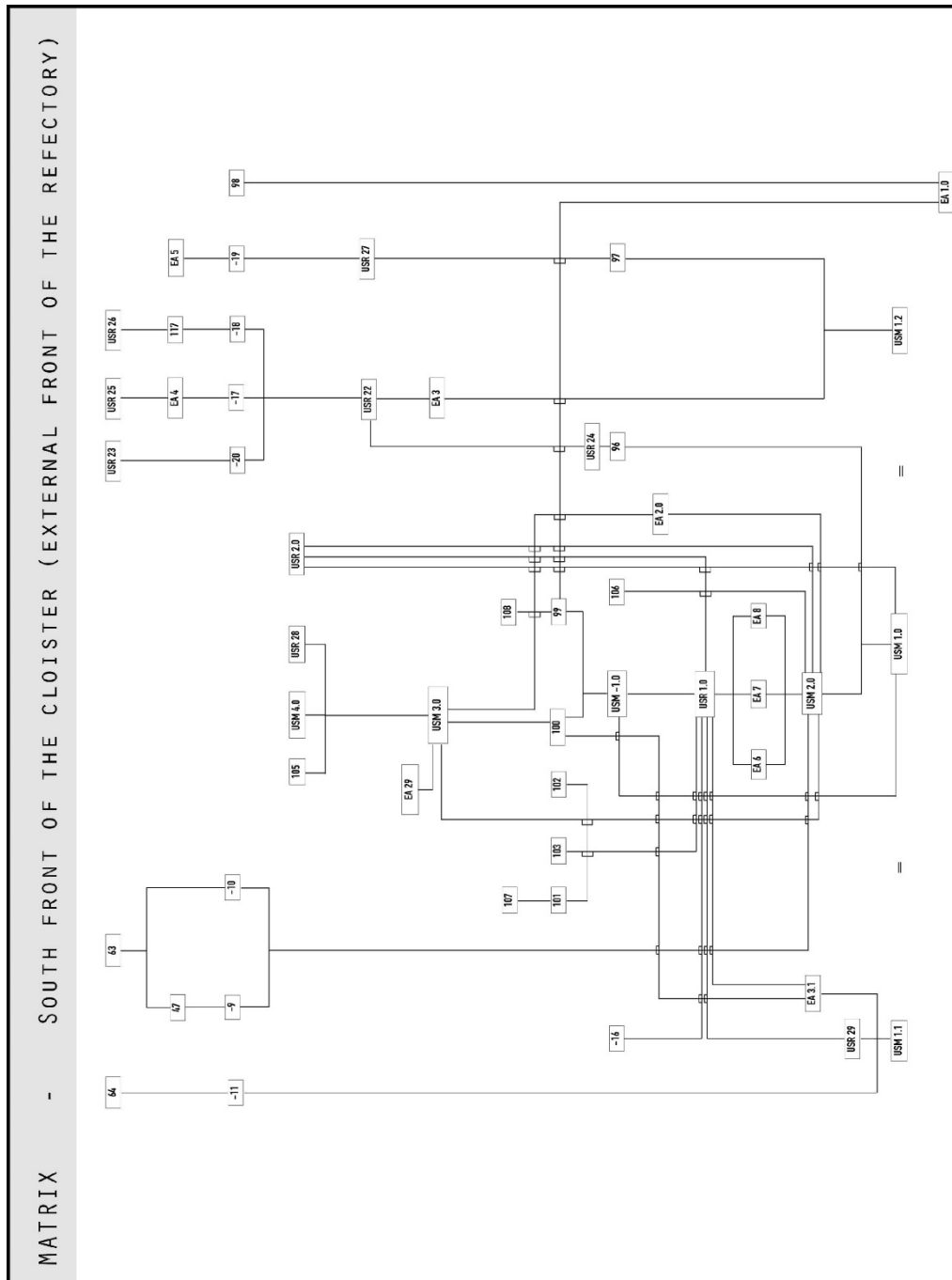

Figure 113. Matrix related to the south front of the cloister (elaboration F. Diara).

**North wall of the refectory:**

The stratigraphic analysis and the matrix generation of the north wall of the refectory is referred to TAV 5 (the orthophoto) and TAV 6 (orthophoto and stratigraphic units).

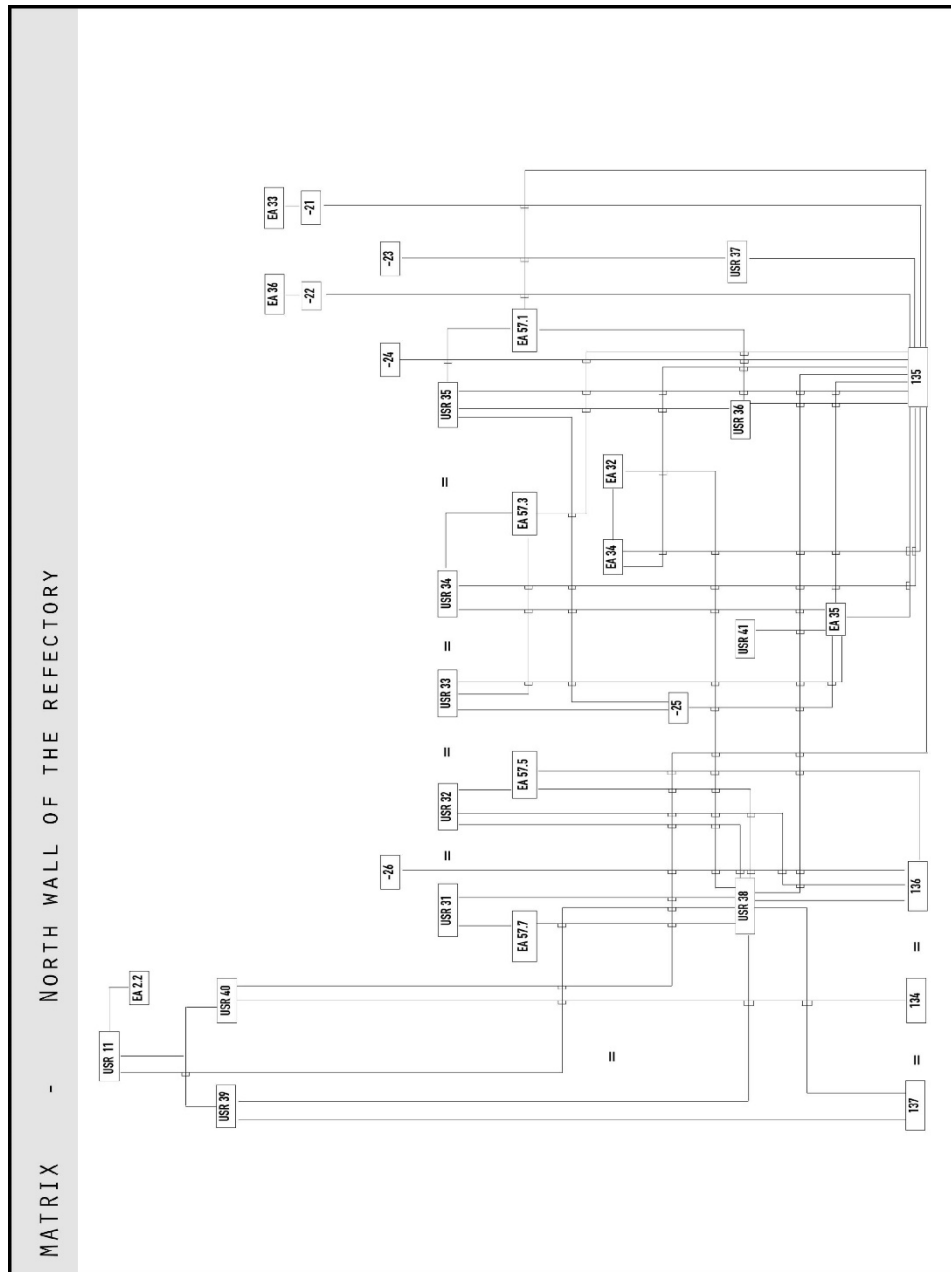

Figure 114. Matrix related to the north wall of the refectory (elaboration F. Diara).



**East wall of the refectory:**

The stratigraphic analysis and the matrix generation of the east wall of the refectory is referred to TAV 9 (the orthophoto) and TAV 10 (orthophoto and stratigraphic units).

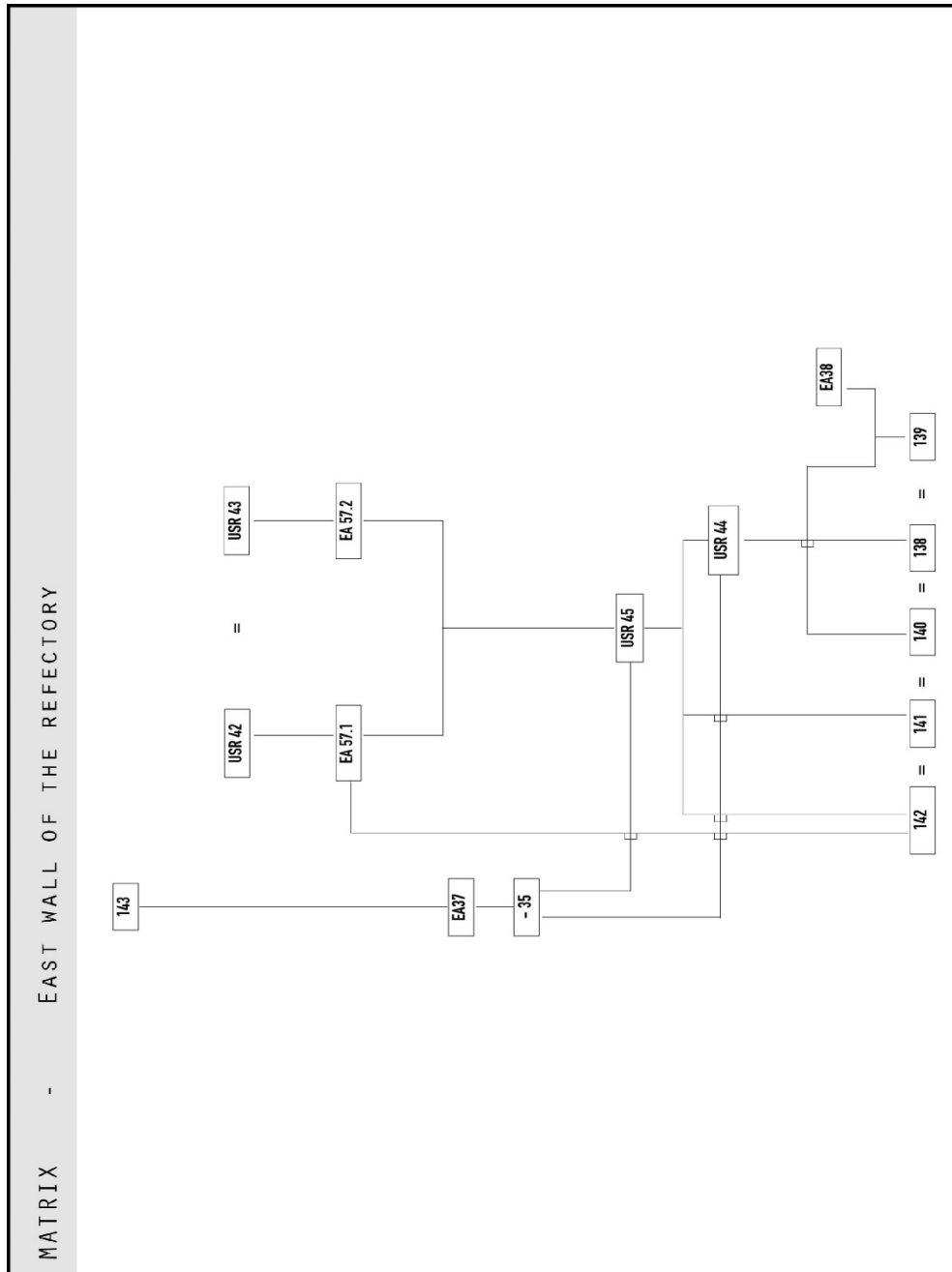

Figure 115. Matrix related to the east wall of the refectory (elaboration F. Diara).

**South wall of the refectory:**

The stratigraphic analysis and the matrix generation of the south wall of the refectory is referred to TAV 13 (the orthophoto) and TAV 14 (orthophoto and stratigraphic units).

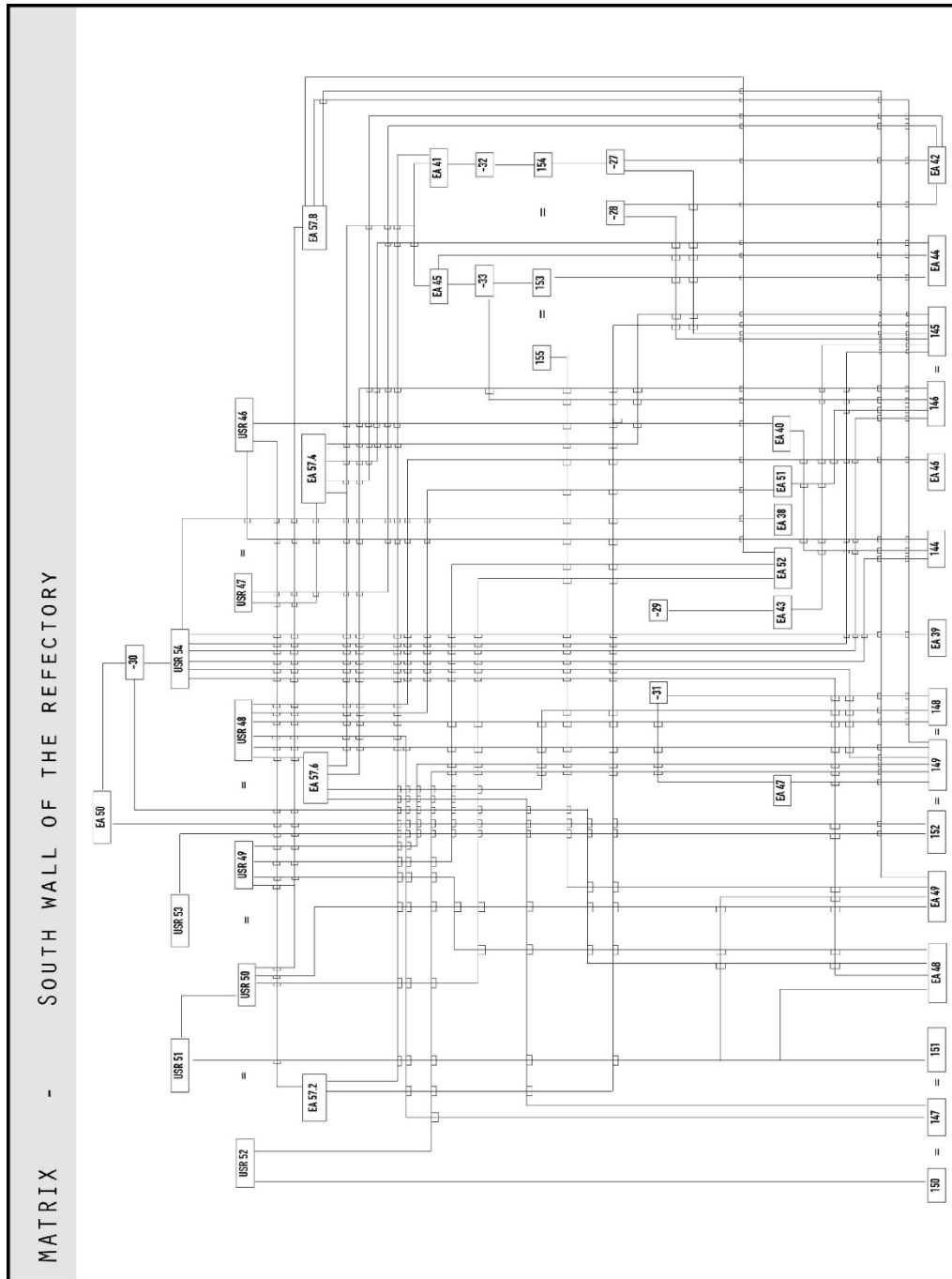

Figure 116. Matrix related to the south wall of the refectory (elaboration F. Diara).

**West wall of the refectory:**

The stratigraphic analysis and the matrix generation of the east wall of the refectory is referred to TAV 17 (the orthophoto) and TAV 18 (orthophoto and stratigraphic units).

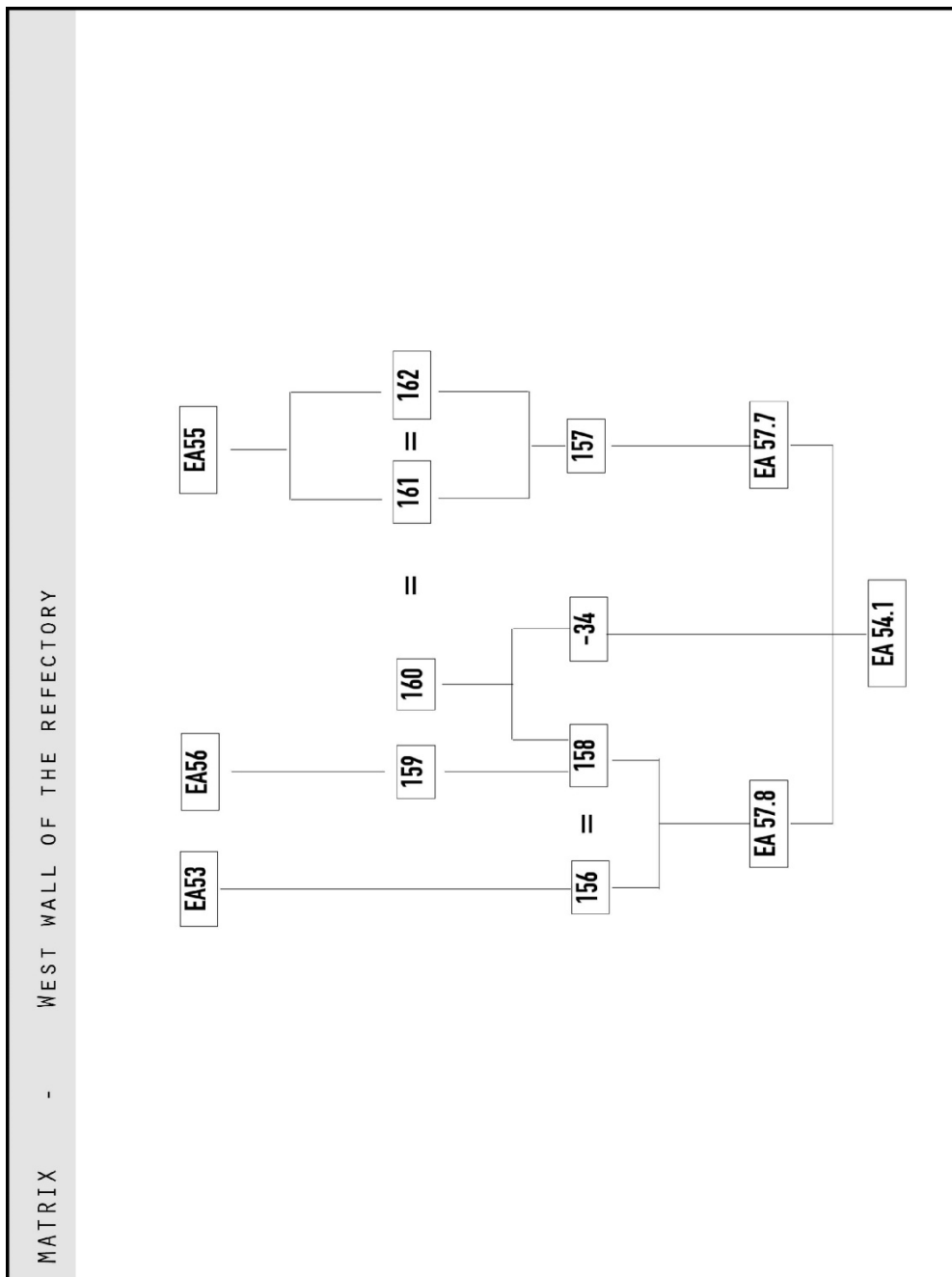

Figure 117. Matrix related to the west wall of the refectory (elaboration F. Diara).

### Pillars and vaults

In addition to the internal walls of the refectory, a stratigraphic diagram has been performed in order to understand relations between pillars and the vaulted system, because, as mentioned before, vaults and pillars have been classified separately by giving different identification numbers and for this reason specific bays leaning on specific pillars.

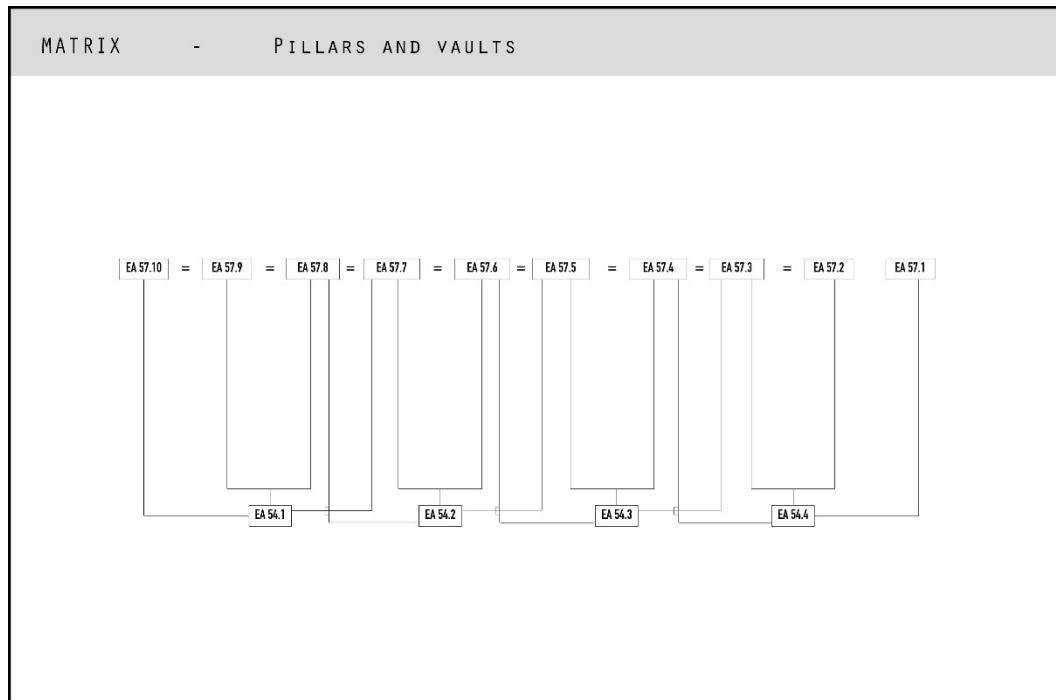

Figure 118. Matrix related to pillars and vaults (elaboration F. Diara).

## 8.2 Matrix interpretation: phases

After the identification of archaeological sequence through the stratigraphic sequence used inside the matrix, the next step is the definition of construction or destruction activities and this can be carried out by performing a conceptual clustering of groups of units in order to define *phases* and then a **relative chronology**. Despite the analysis of the pillars and vaults matrix allow to detect a

single phase, on the remaining walls have been identified 27 phases in which can be found common construction and / or destruction activities among the walls.

### **South front of the cloister**

Through the analysis of the matrix related to the south front of the cloister and then thanks to the relations among units, it has been possible to identify 8 activities phases, and here is the description:

#### **Phase 1**

A first construction phase includes the first block of suspended arches classified as EA 1.0.

#### **Phase 2**

Next construction phase regards the lower level brick masonry with a thin mortar joint with the related portals (EA 1, EA 2, EA 31) and the USR 29. In other words, in this phase are defined the macro group USM 1.0, USM 1.1, USM 1.2 and USR 29.

#### **Phase 3**

This phase includes the medium level brick masonry with a large mortar joint (USM 2.0), the profile of arches related to the removed ceiling of the original gallery (EA 3.1), the three stone shelves probably referred to the wooden ceiling above the gallery (EA 6, EA 7, EA 8), the main degraded plaster layer concerning the removed gallery (macro group USR 1.0).

#### **Phase 4**

The fourth construction phase has been detected into the central block of suspended crossed arches (EA 2.0) related to the oldest edge of the original ceiling of the refectory.

#### **Phase 5**

In this phase have been detected negative units referred to the removal operations of buttresses and gallery arches (macro group USM -1.0) and the related filling plaster / mortar (USM 99, USM 100, USM 101, USM 102, USM 103). Moreover, in this phase have been included the bolted-end plates (USM 107 and USM 108); the two small circular openings shared with the inner side of the refectory (north wall); the curtain walls (USM 96 and USM 97) referred to the filled entrances of portals and the plaster (USR 24) above the USM 96.

### **Phase 6**

Next phase has been identified on the high level modern brick masonry related to the first floor with the contemporary square windows (macro group USM 3.0). Furthermore, in this phase has been included the access to the first floor (EA 3) and the plaster applied on masonry below the remaining gallery and surrounding the access mentioned before.

### **Phase 7**

In this phase are principally included curtain walls related to the partially filled square windows on the first floor (USM 4.0).

### **Phase 8**

Last phase detected is concerning the negative units -9, -10, -11, -17, -18, -19, -20 and all the covering units related to them (USM 98, USM 47, USM 63, USM 64, USM 117), probably referred to maintenance interventions, the square windows opened below the remaining gallery (EA 4 and EA 5) and the covering plasters (USR 23, USR 25, USR 26).

### **North wall of the refectory**

The stratigraphic analysis and the realization of the matrix related to the north wall of the refectory has allowed the identification of 6 activities phases, and here is the description:

#### **Phase 1**

The first construction phase has been detected by including brick masonry (USM 134, USM 135, USM 136, USM 137), the semi-column related to the first ceiling system (EA 35), the faded plaster below the other plaster layers (USR 36, USR, 37, USR 38) and the plaster lying on the capital of the semi-column (USR 41).

#### **Phase 2**

The second phase is related to the first ceiling coverage removing operations (-25), the installation of the brick brackets (EA 34 and EA 32) for the new vaulted system, the vaults concerning bays EA 57.1, EA 57.3 EA 57.5 EA 57.7, and the related plaster applied on bezels (USR 31, USR 32, USR 33, USR 34, USR 35)

#### **Phase 3**

The third phase is referred to negative actions -23, -24, -26 that caused a material loss.

#### **Phase 4**

Next phase is concerning the opening through cuts on masonry (-21, -22) of square windows (EA 36 and EA 33).

#### **Phase 5**

In this phase is included the plaster layers referred to USR 39 and USR 40, placed above the plaster layers concerning the first phase.

#### **Phase 6**

The last phase of the north wall includes the construction of the new typology of the internal arch (round) related to the entrance portal and the related plaster layer (USR 11).

### **East wall of the refectory**

The stratigraphic analysis of the east wall of the refectory has allowed the identification of 5 activities phases, and here are described:

#### **Phase 1**

The first phase is concerning the brick masonry (USM 142, USM 141, USM 140, USM 138, USM 139) and the cornering column without capital EA 38 referred to the first ceiling.

#### **Phase 2**

The second phase is referred to the application of the fresco layer (USR 45) on the masonry, preceded by the preparation plaster (USR 44).

#### **Phase 3**

This phase is characterized by the presence of the negative action -35 related to the cut on fresco, and preparation plaster layer (cutting action not visible on the masonry) for the opening of the portal EA 37.

#### **Phase 4**

In this phase are included the construction activities related to the new vaulted ceiling: the two bays EA 57.1 and EA 57.2 and the related plaster on bezels (USR 42 and USR 43).

## **Phase 5**

The last phase is concerning the curtain wall referred to the covering unit USM 143 above the portal EA 37.

## **South wall of the refectory**

As far as the south wall of the refectory is concerned, 6 activities phases have been detected, and here are described:

### **Phase 1**

In this first phase has been included the brick masonry (USM 144, USM 145, USM 146, USM 147, USM 148, USM 149, USM 150, USM 151, USM 152) and the contemporary single lancet windows (EA 44 - EA 46 - EA 48 - EA 49), the access to the old pulpit and its remaining profile (Fig.140) that now it is an irregular single lancet windows (EA 42), the cornering column (EA 38), the semi-column (EA 43) and the stone shelf (EA 47) referred to the first ceiling (Fig.143). Moreover, in this phase has been included square windows (EA 40, EA 51, EA 52) placed on top of the masonry.

### **Phase 2**

This phase includes the negative actions (-27, -28, -29, -31) related to removing operations concerning the pulpit and the old ceiling.

### **Phase 3**

Phase 3 is concerning the curtain walls related to the covering units on the old pulpit (USM 154) and on two single lancet windows (USM 153 and USM 155).

### **Phase 4**

In this phase are included actions, negative and positive, related to the new vaulted system. In fact, negative actions are concerning the cuts on masonry and on curtain walls mentioned before (-32 and -33) and the related construction of brick brackets (EA 45 and EA 41). Consequently, the four bays (EA 57.2, EA 57.4, EA 57.6, EA 57.8) have been included as well as their plaster applied on bezels (USR 52, USR 50, USR 49, USR 48, USR 47, USR 46).



### **Phase 5**

This phase includes the main plaster above the brick masonry (USR 51, USR 53, USR 54). The USR 53 and USR 54 are above the USM 153 referred to the filled single-lancet window (Fig.141).

### **Phase 6**

The last phase of this wall regards the negative action (-30) related to the opening of the portal leading on the backyard (EA 50).

### **West wall of the refectory**

On the west wall of the refectory (Fig.144), through the analysis of the stratigraphic relations, 2 activities phases have been detected, and here are described:

#### **Phase 1**

A first moment is concerning the construction of the new vaulted system, then including the partially walled pillar EA 54.1 (Fig.145) and the two bays EA 57.7 and EA 57.8.

#### **Phase 2**

Second and last phase is related to the big curtain wall that divides the original refectory space in two separate spaces: in fact, the modern brick masonry (USM 156, USM 157, USM 158) is leaning on the pillar and on the vaults, and it includes two wooden beams and a windowsill (USM 159, USM 160, USM 162, USM 162) as well as two square windows (EA 56 and EA 55) and the access to the new small chambers (EA 53)

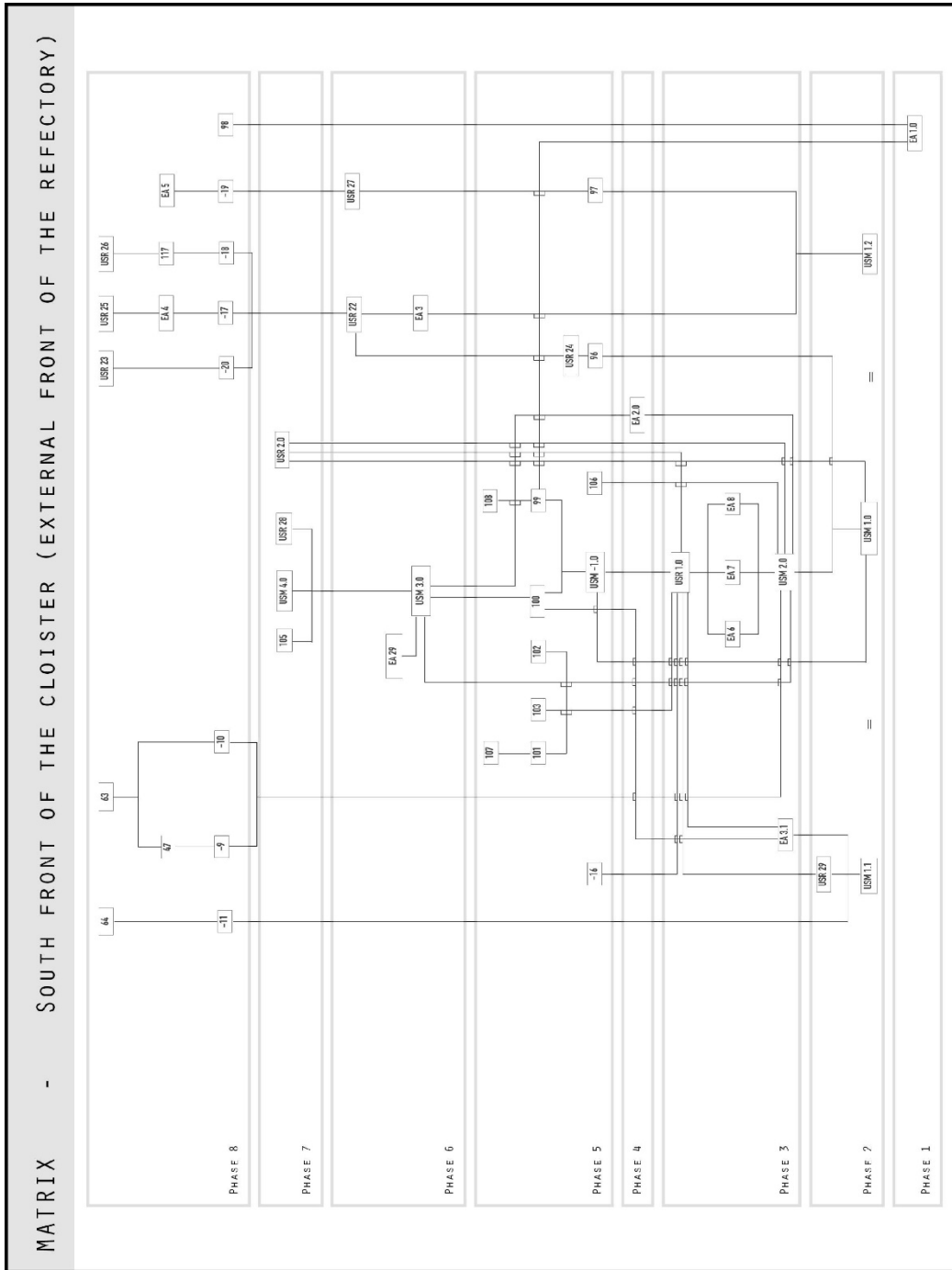

Figure 119. Matrix and phases related to the south front of the cloister (elaboration F. Diara).

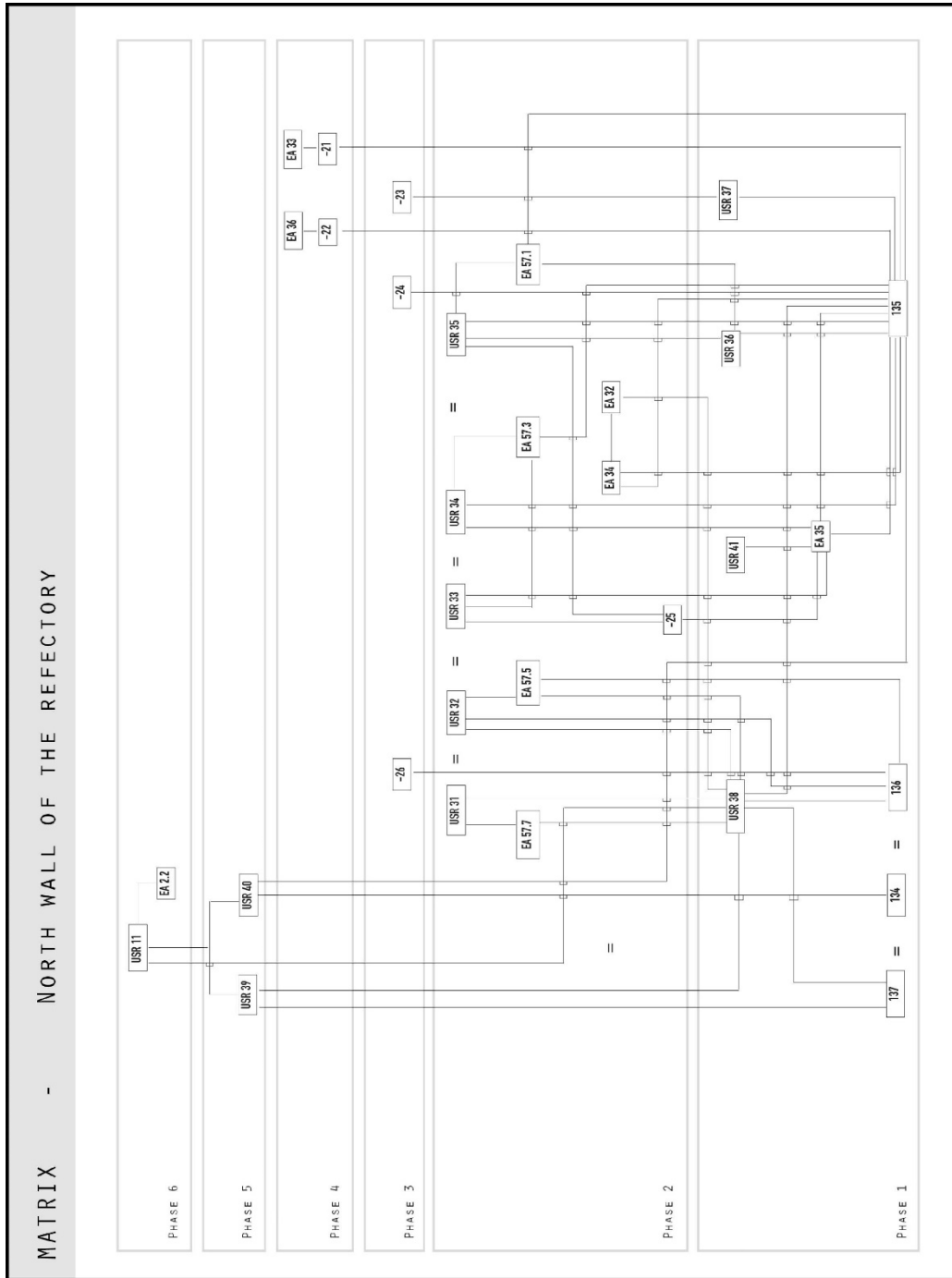

Figure 120. Matrix and phases related to the north wall of the refectory (elaboration F. Diara).

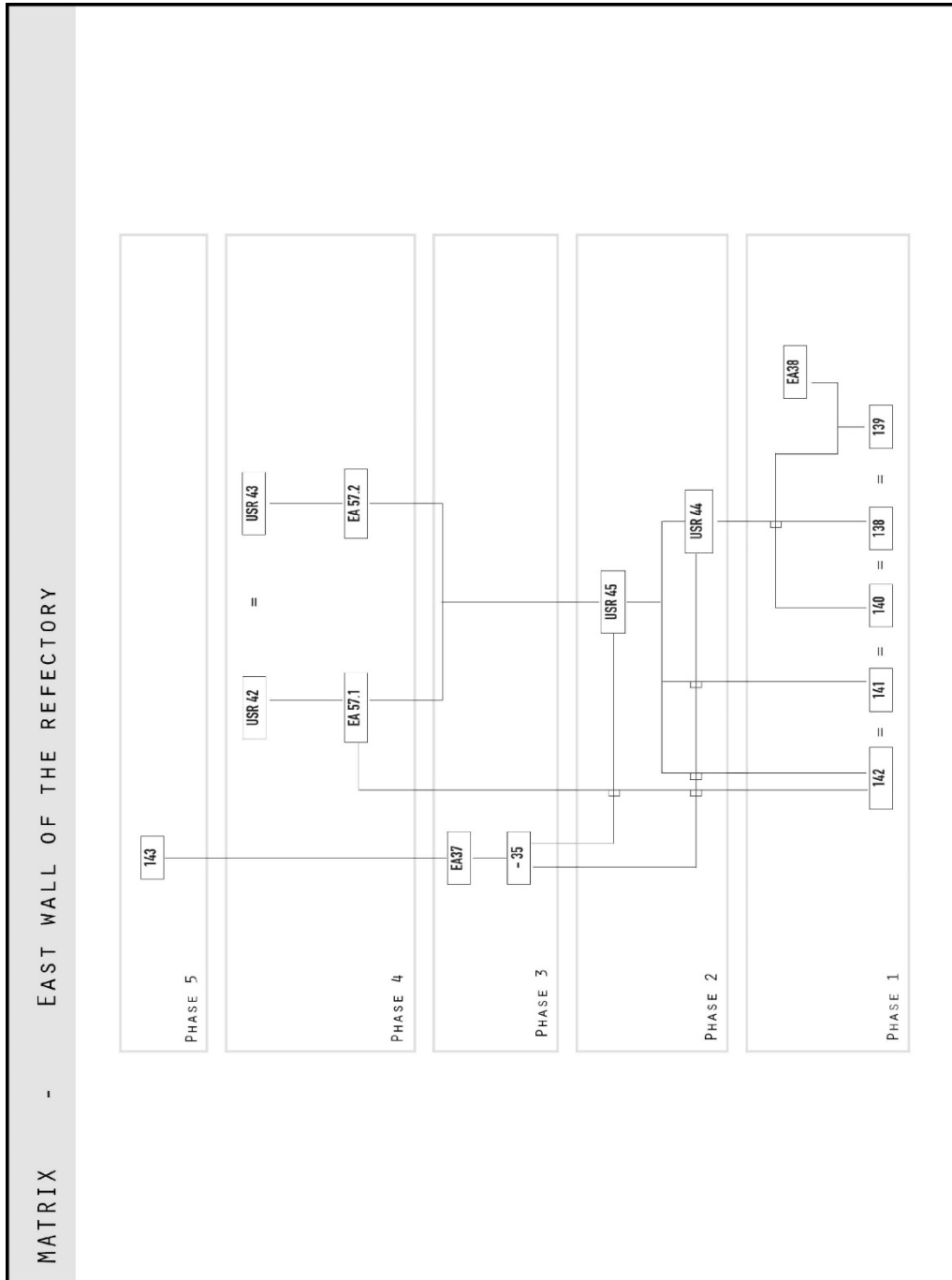

Figure 121. Matrix and phases related to the east wall of the refectory (elaboration F. Diara).

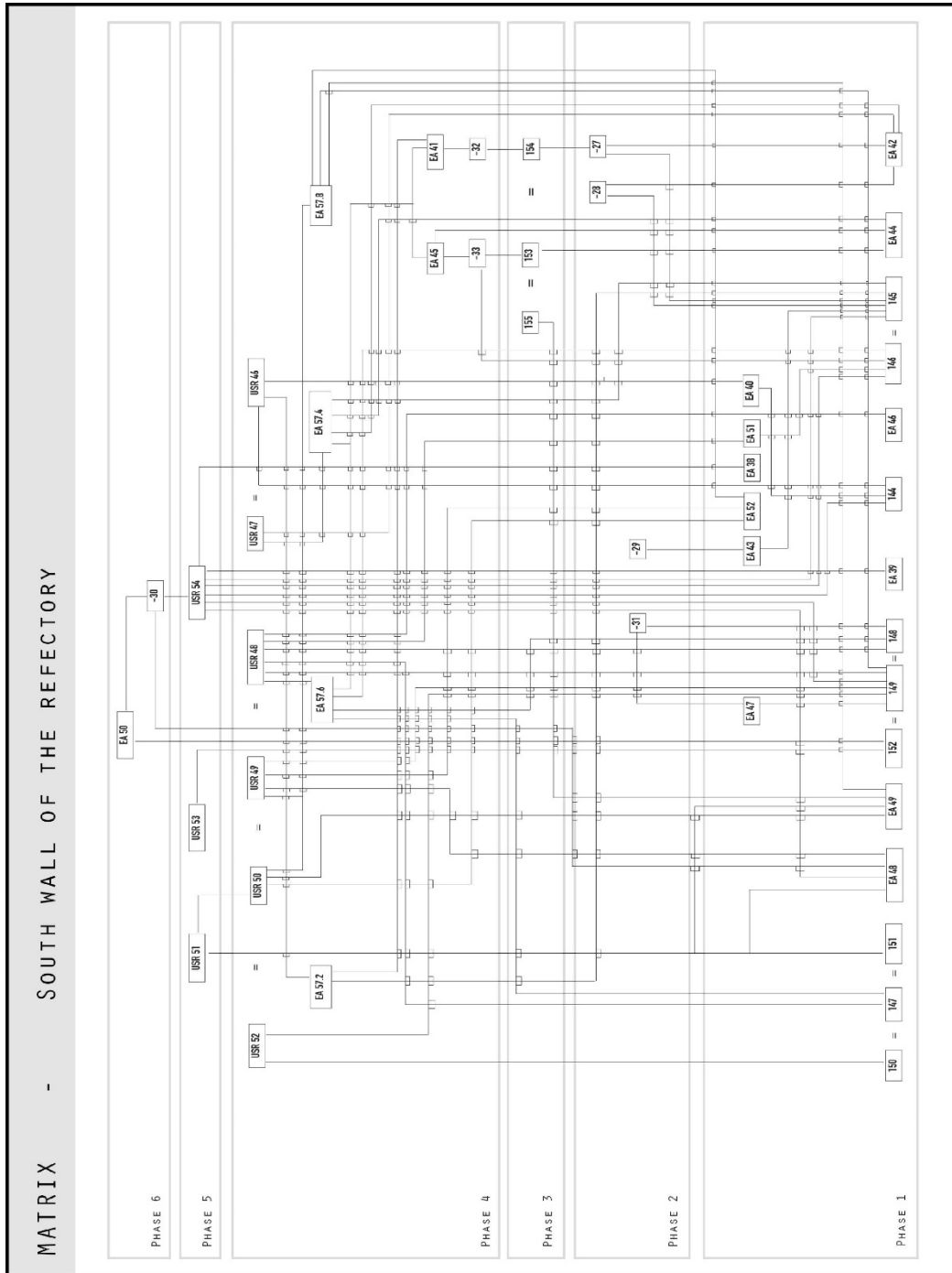

Figure 122. Matrix and phases related to the south wall of the refectory (elaboration F. Diara).

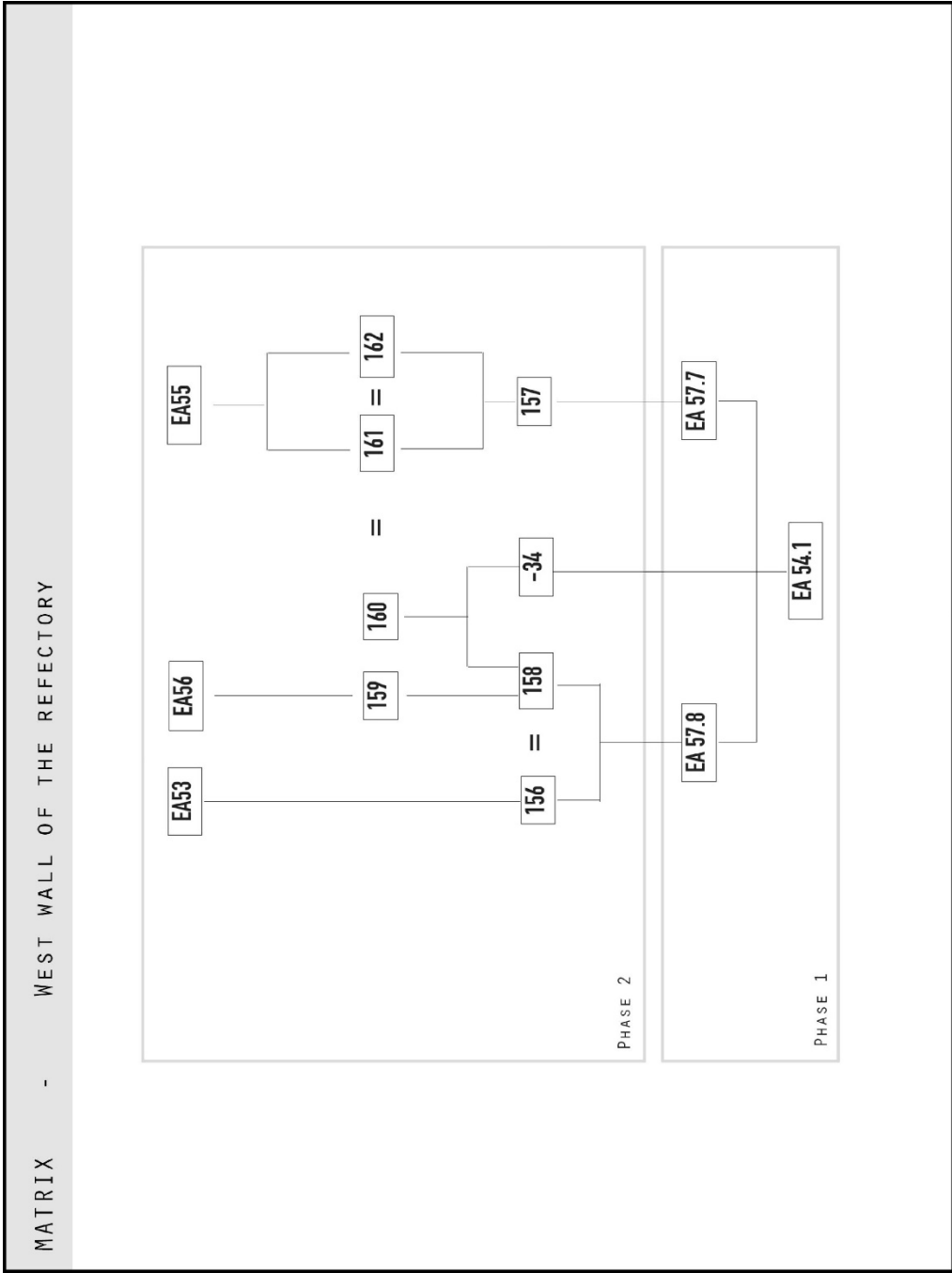

Figure 123. Matrix and phases related to the west wall of the refectory (elaboration F. Diara).

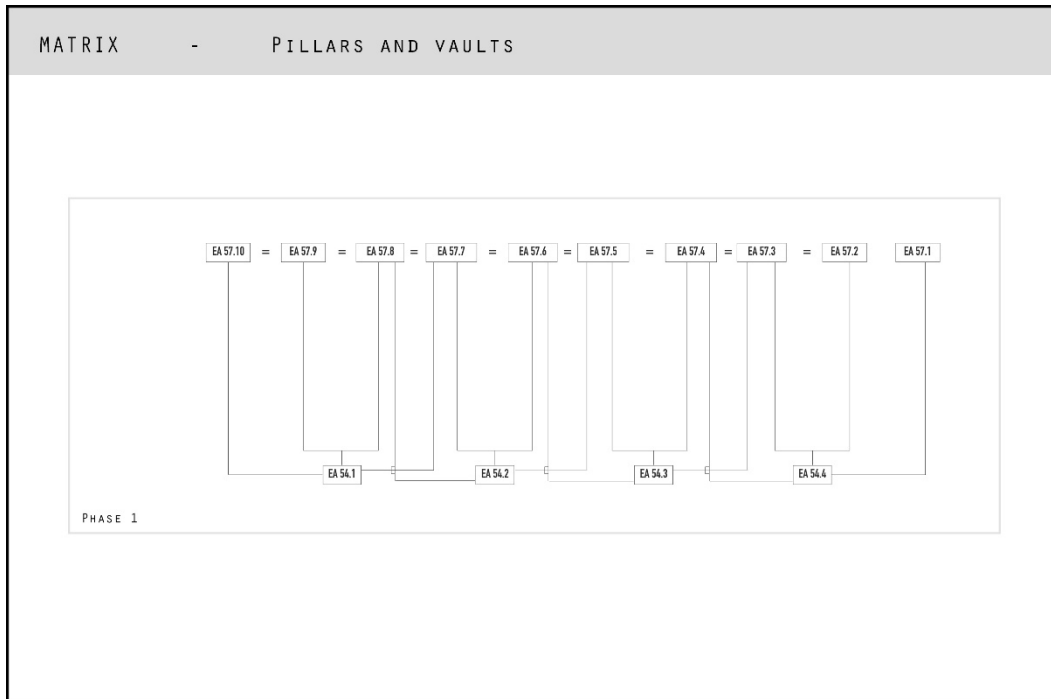

Figure 124. Matrix and phase related to the pillars and vaults (elaboration F. Diara).

### 8.3 Chronological periods

Matrix generation and phases identification are required step in order to understand the stratigraphic evolution of an excavated archaeological site or a surveyed historical building. However, after the *relative chronology* detection should be performed the more accurate and refined identification of **chronological periods**, establishing an *absolute chronology*. This interpretation step should be supported by crossing stratigraphic data to other kinds of information, and this type of information is defined as *direct* and *indirect*. Direct sources are referred to information that can be extracted directly on the analysed object, for example materials analyses (e.g. chemical composition), dimensional analyses (e.g. chronology based on the dimension of bricks and stone elements), typological analyses (based on comparisons and feedbacks with other examples and other cases studies).

The identification of chronological periods of the refectory started from the analysis of construction or destruction activities defined by phases. This analysis

has been helped by the support of direct sources as typological analysis as well as indirect sources, such as archive sources and bibliographic sources.

As we will see, the analysis of the stratigraphic sequence and phases of the refectory, helped by direct and indirect sources, allowed to identify 7 chronological periods. However, all the detected periods cannot be seen on all internal walls, due to particular and non-homogenous interventions on masonries, also concerning the connection between the internal and external sides of the refectory. In this sense, for example, period 4 is noticeable just on the east wall and period 3 and 7 is visible only on the south front of the cloister.

Moreover, for each chronological period has been assigned an identification number and colour for the purpose of remarking periods on matrices.

The detection of chronological periods started from the external front to the internal walls, and, as mentioned before, the chronology has been refined also relying principally on typological sources and bibliographic sources.

Table 13. Chronological periods detected as regard the refectory

| <b>Period</b> | <b>Time</b> | <b>Description</b>   |
|---------------|-------------|--|
| Period 1      | 1160 – 1180 | Refectory early construction site related to first block of suspended arches |
| Period 2      | 1180 – 1220 | External and internal brick masonry and contemporary elements                |
| Period 3      | 1230 - 1280 | Suspended crossed arches of the external front                               |
| Period 4      | 1510 – 1530 | <i>Ultima Cena</i> fresco on the east wall of the refectory                  |
| Period 5      | 1690 – 1750 | Construction site referred to first floor, pillars, vaults and west wall     |
| Period 6      | 1800 – 1900 | Curtain walls of square windows, internal original plaster brush up          |
| Period 7      | 1910 – 1925 | Maintenance interventions on the external front                              |

### **South front of the cloister**

The analysis of the external front of the refectory (Fig.125; Fig.131 and TAV.4) permitted the detection of 6 chronological periods. The initial period should be referred to phase 1, and then to the first construction site related to the first block of suspended arches classified as EA 1.0. Thus, this chronological period corresponds to the end of the construction site of the Santa Maria church and the beginning of the cloister buildings construction, around 1160 and 1180 (Tosco C., 1999; Beltramo S., 2010) and this identification was helped by typological



comparison with the same suspended arches on the transept of the church (Fig. 136 and 137).

Next chronological period should include phase 2 and phase 3: the lower level brick masonry with thin mortar joint (Fig. 139) with the related portals (macro group USM 1.0, USM 1.1, USM 1.2) and the USR 29; the medium level brick masonry with large mortar joint (USM 2.0), the profile of arches related to the removed ceiling of the original gallery (EA 3.1), the three stone shelves probably referred to the wooden ceiling above the gallery (EA 6, EA 7, EA 8), and finally the main degraded plaster layer concerning the removed gallery (macro group USR 1.0). In this regard the differences between two kinds of brick masonries should be owed to USR 1.0 plaster dissolution and the climatic differences inside and outside the old gallery.

In summary, this period should be referred to the main medieval brick masonry of the refectory and the related plaster, including the old gallery (probably with groined vaults) and also a wooden ceiling leaning on stone shelves. This chronological period should be inscribed at the end of the XII century and first years of the XIII century (1180 – 1220).

The third chronological period should be referred to the suspended crossed arches (EA 2.0) on the central part of the front that limited the height among two floors (Fig. 138), and they are probably related to the oldest edge of the original ceiling of the refectory. The chronology should be referred to the next years from the second period, and then around the 1230 – 1280.

Next chronological period (5) presents a great concentration of activities and it is referred to phases 5 and 6 on which have been detected destruction actions referred to the removal operations of buttresses and gallery arches (macro group USM -1.0) and then it includes the related filling plaster / mortar (USM 99, USM 100, USM 101, USM 102, USM 103). In this period are also included the two small circular openings shared with the inner side of the refectory (north wall), probably opened after the removal of the gallery in order to obtain more light inside the refectory. In this time should be included also the curtain walls (USM 96 and USM 97) referred to the filled entrances of portals and the plaster (USR 24) above the USM 96, and this action could suggest disposal of some areas of the south front of the cloister. Moreover, in this moment should be included the bolted-end plates (USM 107 and USM 108) of which only USM 108 is referred to the contemporary vaulted system inside the refectory.

This time includes the high level modern brick masonry related to the first floor construction and the related square windows (macro group USM 3.0).

Consequently, should be included the access to the first floor (EA 3) and the plaster applied on masonry below the remaining gallery.

Concluding, this chronological period is referred to the interventions after the Staffarda battle in 1690, mentioned in chapter 3, when the kingdom of France collided with the Duchy of Savoy headed by Vittorio Amedeo II, and in this regard, Vittorio Amedeo II planned the restoration of all the damaged monastery buildings, around 1716 (Beltramo S., 2010 and 2016). For this reason, the old ceiling of the refectory has been removed and consequently the buttresses that supported it externally on the south front of the cloister. The realization of the first floor is then included in this reasoning, as well as the access to this floor (EA 3) realized probably around the construction site of 1734, information supported also by the floor plan managed by Alessandro Goffi in 1845<sup>26</sup> (Beltramo S., 2010).

Next chronological period is referred to the curtain walls concerning the partially filled square windows on the first floor (USM 4.0) and probably they are related to the changing role of the first floor, probably happened between the '800 and '900.

Last period, first years of the '900, detected should be referred to phase 8 and then to the negative units and all the covering units related to them probably referred to maintenance interventions, including the square windows opened below the remaining gallery and the covering plasters of these interventions.

Table 14. Chronological periods detected on the external front of the refectory

| <b>Period</b> | <b>Time</b> | <b>Description</b>   |
|---------------|-------------|--|
| Period 1      | 1160 – 1180 | Refectory early construction site related to first block of suspended arches |
| Period 2      | 1180 – 1220 | Brick masonry and contemporary elements                                      |
| Period 3      | 1230 - 1280 | Suspended cross arches of the external front                                 |
| Period 5      | 1690 – 1750 | Removed buttresses and construction site referred to first floor             |
| Period 6      | 1800 – 1900 | Curtain walls of square windows  |
| Period 7      | 1910 – 1925 | Maintenance interventions  |

<sup>26</sup> Historic Archive of the Mauritian Order (ASOM), *Cabrei e disegni*, Staffarda, 41 arm. 8.; ASOM, Staffarda, m.15, fasc. 370, 15 maggio 1732.

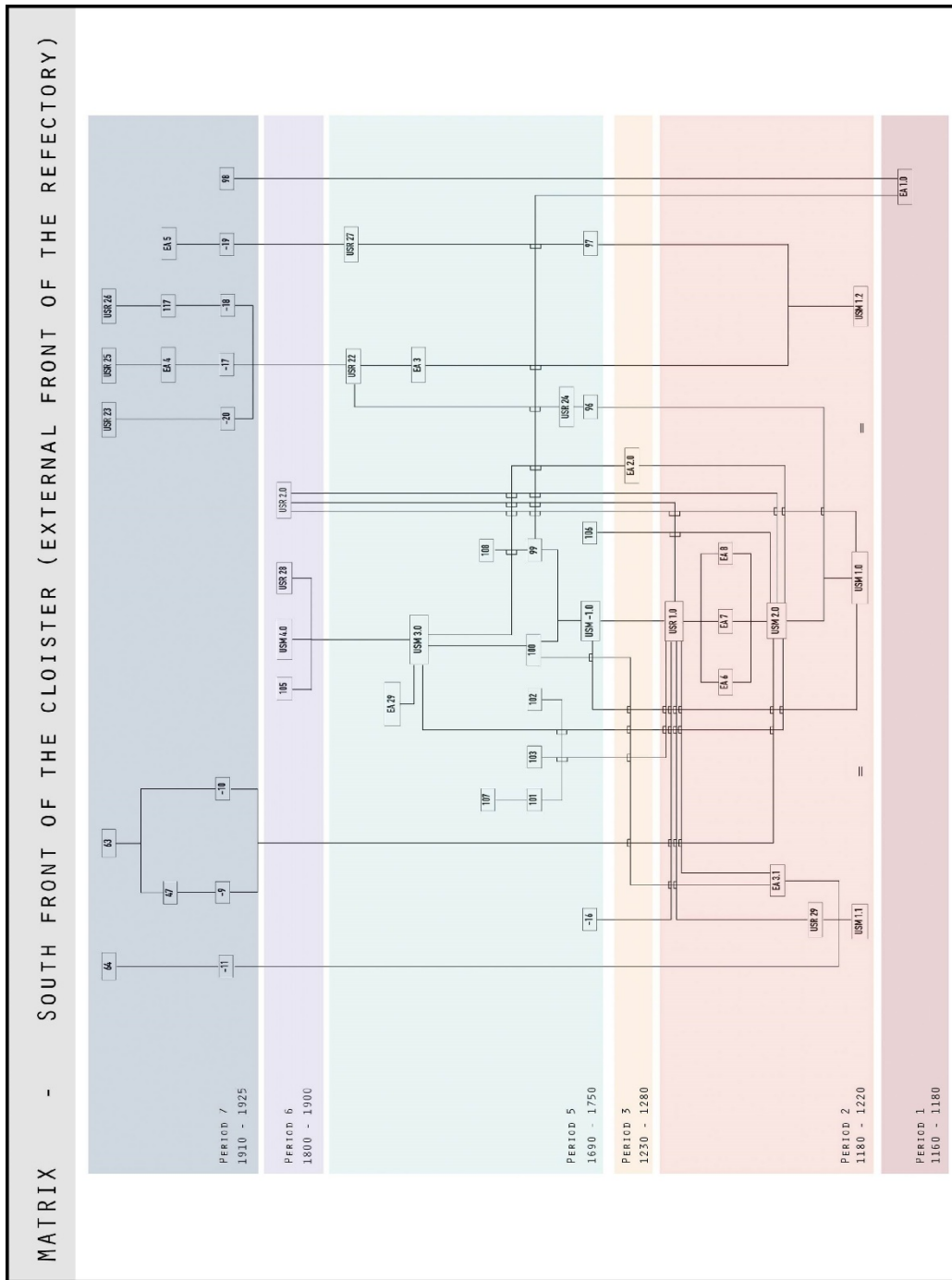

Figure 125. Chronological periods related to the south front of the cloister (elaboration F. Diara).

### **North wall of the refectory**

On the north wall of the refectory three chronological periods have been detected (Fig.126; Fig.132 and TAV.8). The first period, that corresponds to period 2 of the entire complex, includes essentially the first phase detected on this wall: the brick masonry (USM 134, USM 135, USM 136, USM 137), the semi-column and the capital (Fig.142) referred to the first ceiling system (EA 35), the faded plaster USR 36, USR, 37, USR 38 and the plaster lying on the capital of the semi-column (USR 41). This chronological period should be referred to the main construction site of the refectory and should be inscribed at the end of the XII century and first years of the XIII century (1180 – 1220).

Phases 2, 3 and 4 confirm the existence of the removing operations (-25) concerning the old ceiling and the installation of the new vaulted system, in fact these actions have been inscribed into a single chronological period occurred after the Staffarda battle in 1690 and during the construction site concerning the old ceiling and buttresses removal and the following edification of pillars and vaults, probably within 1750. In this period could also include the opening actions of square windows (EA 36 and EA 33).

Last chronological period detected, between '800 and '900, includes phase 5 and 6 that are referred to a mixture of plasters USR 39 and USR 40 that probably retrace and brush up the original linear pattern that has a regular average height of 2.35 m from the ground. This height is significant because it has to be compared and related to the lower level of brick masonry of the external front of the refectory (USM 1.0 – USM 1.1 – USM 1.2), that has the similar height (2.30 m) and for this reason the plaster layer could be referred to the original linear pattern, although it experienced retracing operations. Moreover, this period includes the edification action concerning the new typology of the internal round arch related to the entrance portal and its plaster layer (USR 11).

Table 15. Chronological periods detected on the north wall of the refectory

| <b>Period</b> | <b>Time</b> | <b>Description</b>  |
|---------------|-------------|---|
| Period 2      | 1180 – 1220 | Brick masonry, the semi-column and the faded plaster                  |
| Period 5      | 1690 – 1750 | Removed ceiling and new construction of vaults and square windows     |
| Period 6      | 1800 – 1900 | Retraced original plaster, construction of the internal entrance arch |

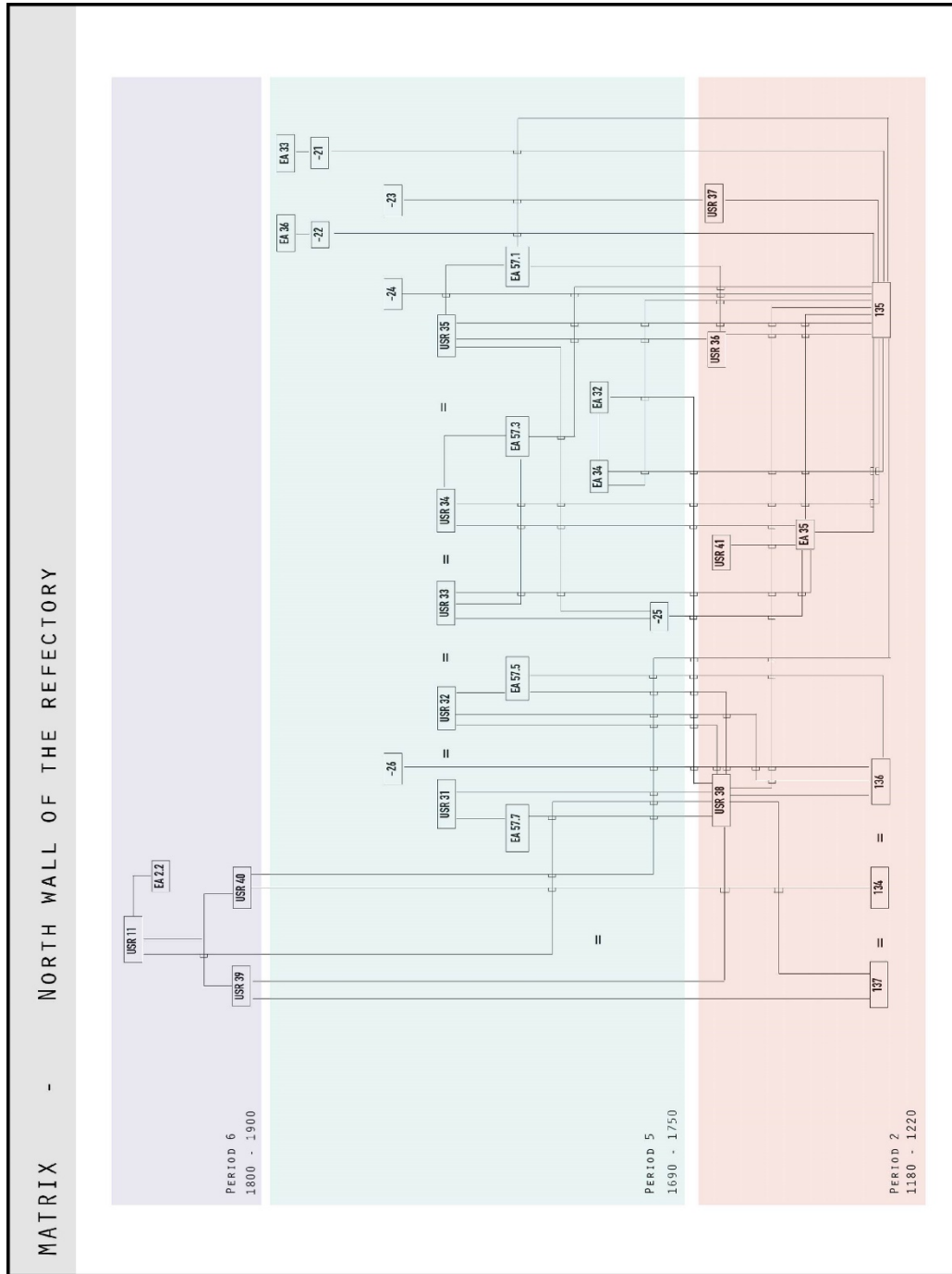

Figure 126. Chronological periods related to the north wall of the refectory (elaboration F. Diara).

### **East wall of the refectory**

The east wall of the refectory shows four chronological periods (Fig.127; Fig.133 and TAV.12). The first chronological period is linked to the main brick masonry of the north wall, in fact, it includes the phase 1: brick masonry related to USM 142, USM 141, USM 140, USM 138, USM 139 and the contemporary cornering column without capital EA 38 referred to the first ceiling. This period, as the previous one, should be inscribed between 1180 and 1220, at the time of the main construction site of the refectory.

The second chronological period is a particularity and can be detected only in this wall, it is referred to the *Ultima Cena* fresco and its preparation layer (USR 44), dated at the beginning of the XVI century (Gabielli N., 1973; Beltramo S., 2010). This punctual chronological reference is not visible and findable on the other walls of the refectory.

Next chronological period is referred to the already mentioned construction site concerning the installation of the vaulted system, and then between 1690 and 1750, and the application of plasters on bezels. Moreover, in this time could be inscribed the negative action -35 related to the cut on fresco, and preparation plaster layer, but unfortunately not visible on the masonry, for the opening of the portal EA 37. Probably this action is referred to this chronological period but hardly attributable to the vaults construction site.

Lately, the curtain wall referred to the covering unit USM 143 above the portal EA 37 could be referred to another chronological period, probably after the construction site of vaulted system, and for this reason inscribed between '800 and '900. However, for these stratigraphic units mentioned before reservations as regard the interpretation remains, due to dubious chronological collocation also due to plaster evidences on the curtain wall.

Table 16. Chronological periods detected as regard the east wall of the refectory

| <b>Period</b> | <b>Time</b> | <b>Description</b>                                  |
|---------------|-------------|---|
| Period 2      | 1180 – 1220 | Brick masonry and the cornering column              |
| Period 4      | 1510 – 1530 | <i>Ultima Cena</i> fresco and its preparation layer |
| Period 5      | 1690 – 1750 | Construction site referred new vaulted system       |
| Period 6      | 1800 – 1900 | Curtain walls of the opened portal                  |

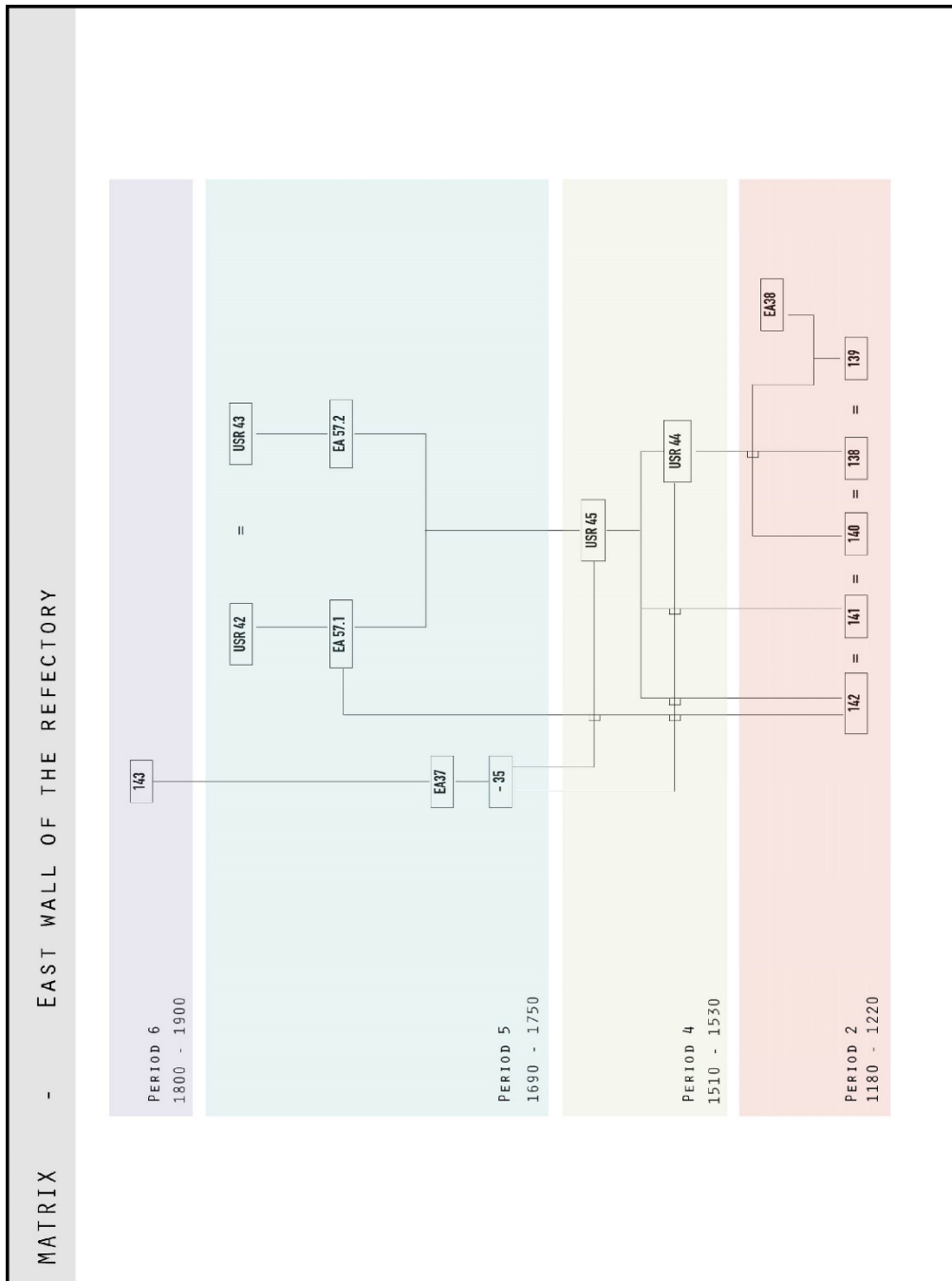

Figure 127. Chronological periods related to the east wall of the refectory (elaboration F. Diara).

### **South wall of the refectory**

The south wall shows principally three chronological periods (Fig. 128; Fig. 134 and TAV.16). First period, the same first period the previous three walls, is referred to the main brick masonry including USM 144, USM 145, USM 146, USM 147, USM 148, USM 149, USM 150, USM 151, USM 152 and the related opening elements as the single lancet windows EA 44 - EA 46 - EA 48 - EA 49, the access to the old pulpit and its remaining profile that nowadays changed role into an irregular single lancet windows (EA 42), the cornering column in common with the east wall (EA 38), the semi-column with the stone capital (EA 43) and the stone shelf (EA 47) referred to the first ceiling (Fig.143). Should be considered contemporary to this period the elements concerning the square windows (EA 40, EA 51, EA 52) placed on top of the masonry. Then this period has the same chronology of first periods of the previous walls, ranging from 1180 and 1220.

The second chronological period should be included the phase 2, 3 and 4, and for this reason should be referred to the construction site who removed the pulpit, the old ceiling and built the new groined vaulted system after the edification of curtain walls related to the covering units on the old pulpit (USM 154) and on two single lancet windows (USM 153 and USM 155) and after the construction of two brick brackets (EA 45 and EA 41). For these reasons this period has to be inscribed after the Staffarda battle in 1690 and during the construction site around 1734-1750.

Last chronological period detectable, between '800 and '900, shows similar evidences with the north wall, because it is referred to a mixture of plasters USR 51, USR 53, USR 54 that, as we have seen on the north front, probably retrace and brush up the original linear pattern that has a regular average height of 2.45 m from the ground, also because USR 53 and USR 54 is above the USM 153 referred to the filled single-lancet window (Fig.141 - curtain wall in period 5). Moreover, this plaster layer has to be compared with the previous one seen on the north wall (2.35 height from the ground and the same linear pattern) and with the brick masonry (USM 1.0 – USM 1.1 – USM 1.2) of the external front that has a similar height from the ground (2.30 m).

Moreover, in this time has been included the negative action (-30) related to the opening of the portal leading on the backyard (EA 50). However, also for these units, reservations concerning the interpretation remains, due to dubious chronological collocation.



Table 17. Chronological periods detected on the south wall of the refectory

| <b>Period</b> | <b>Time</b> | <b>Description</b>  |
|---------------|-------------|---|
| Period 2      | 1180 – 1220 | Brick masonry, semi-column, pulpit, windows, stone brackets, column |
| Period 5      | 1690 – 1750 | Removed pulpit and ceiling, curtain walls, new vaulted system       |
| Period 6      | 1800 – 1900 | Retraced original plaster, new access to the backyard               |

### **West wall of the refectory**

Despite two phases have been detected on the west wall (Fig.144), these have to be clustering into a single chronological period, detectable after the Staffarda battle in 1690 and during the vaults and pillars construction site around the 1734-1750 (Fig 129; Fig.135 and TAV.20). Then, this period includes the new vaulted system (bays EA 57.7 and EA 57.8) and the partially walled pillar EA 54.1 (Fig.145). In the same time, probably during the construction of the vaulted system, has been decided to divide the main internal area of the refectory in two separate areas, and this is the case of the big curtain wall that divides the original refectory space in two separate spaces: in fact, from a stratigraphic point of view the modern brick masonry and the related openings are leaning on the pillar and on the vaults. Moreover, this separation wall breaks up the north and south wall continuity, and the obtained area is itself divided in the other two small chambers, accessible by a wooden door and small stairs.

Table 18. Chronological period detected on the west wall of the refectory

| <b>Period</b> | <b>Time</b> | <b>Description</b>   |
|---------------|-------------|--|
| Period 5      | 1690 – 1750 | Pillar and vaults, modern brick masonry and openings leaning on the pillar |

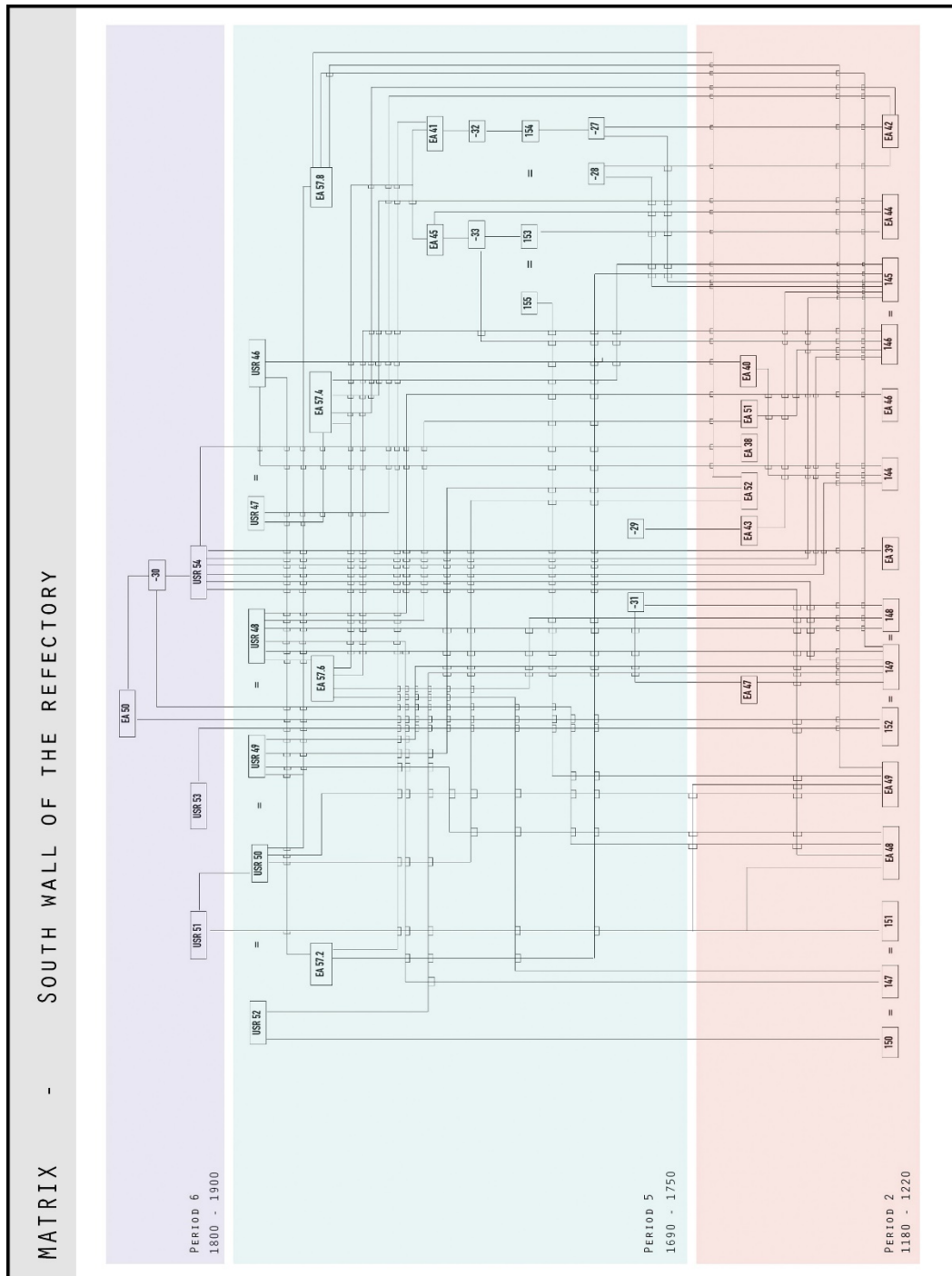

Figure 128. Chronological periods related to the south wall of the refectory (elaboration F. Diara).

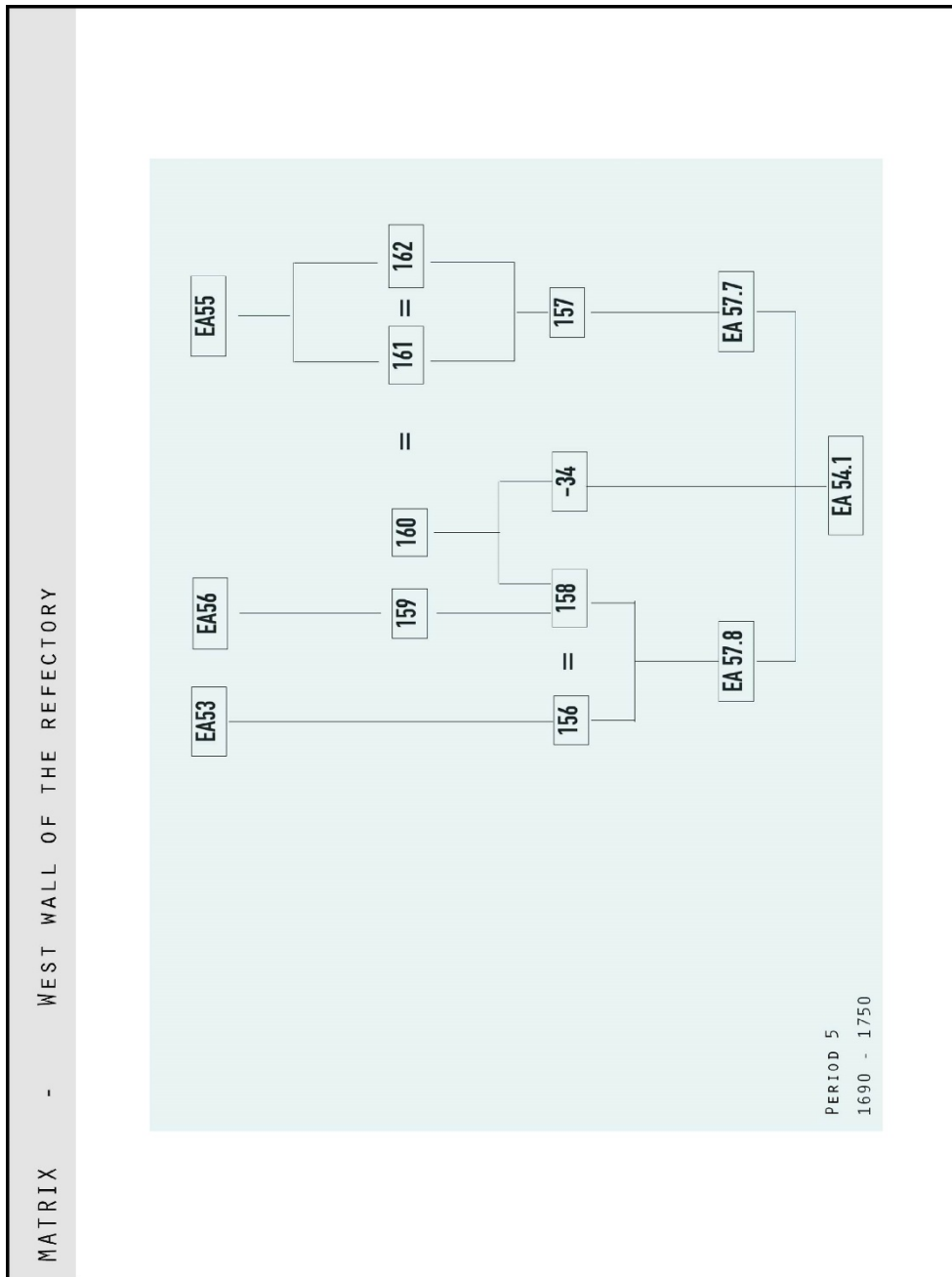

Figure 129. Chronological periods related to the west wall of the refectory (elaboration F. Diara).

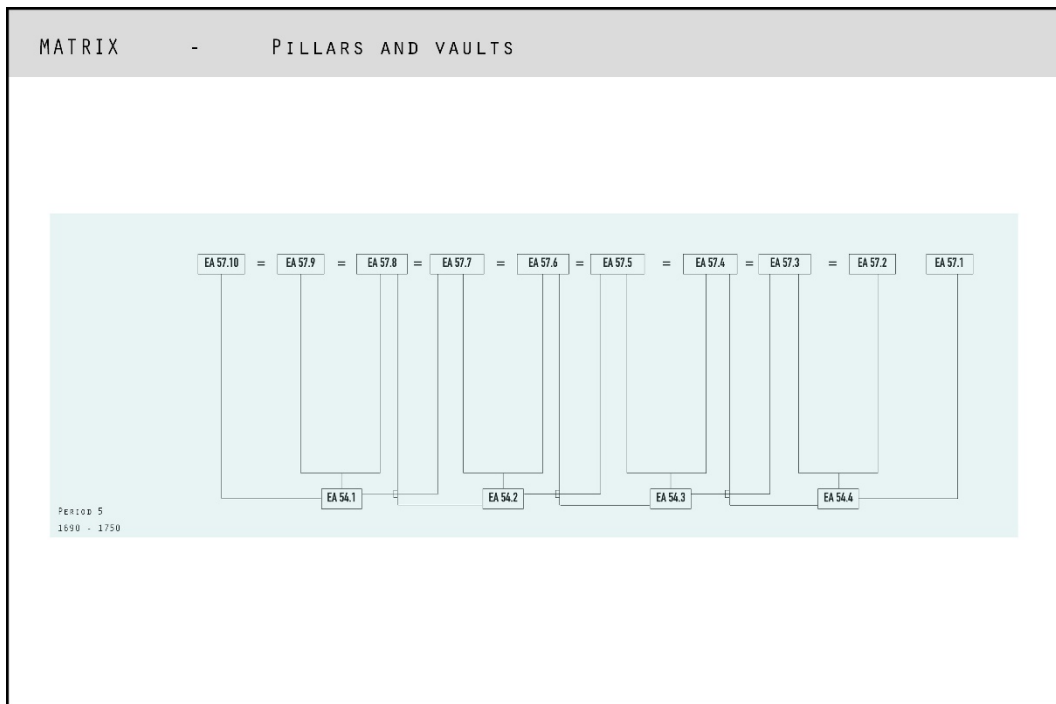

Figure 130. Chronological periods related to the pillars and vaults of the refectory (elaboration F. Diara).

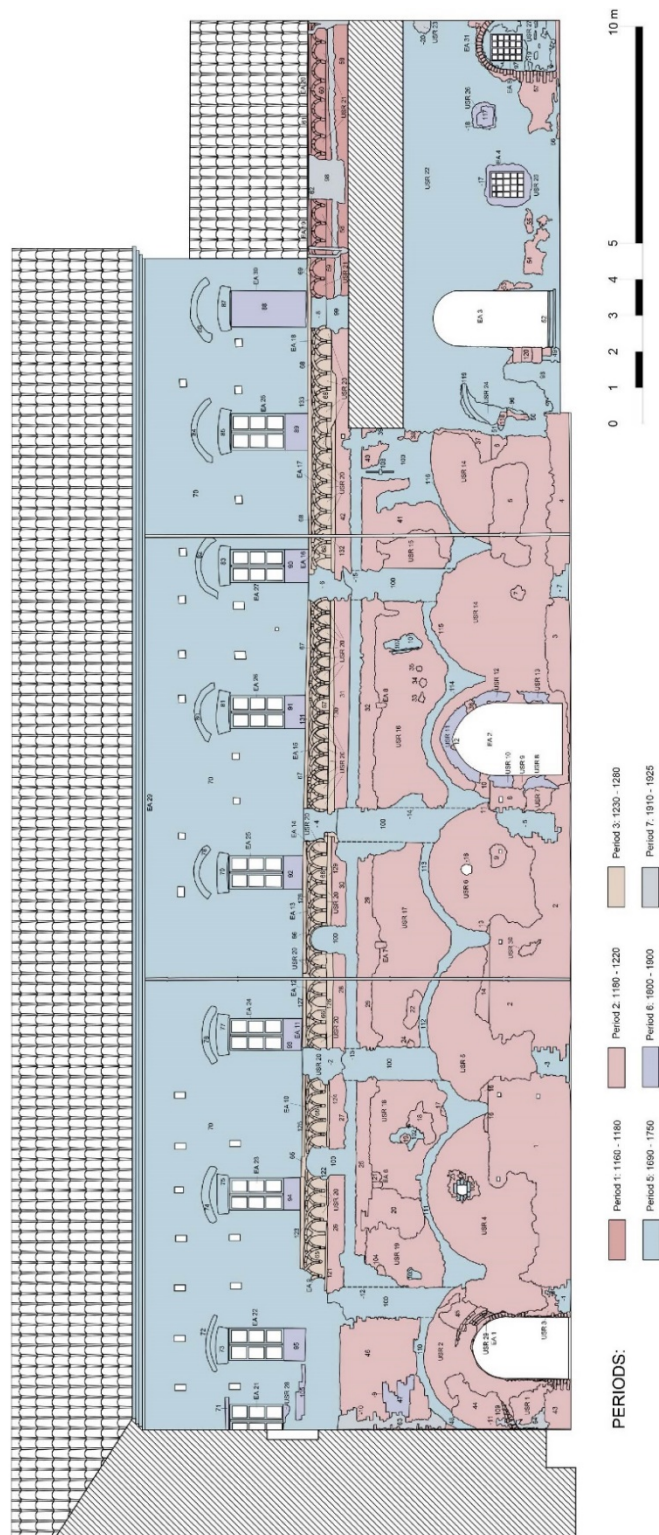

Figure 131. Chronological periods and units of the south front of the cloister (see also TAV.4) - (elaboration F. Diara).

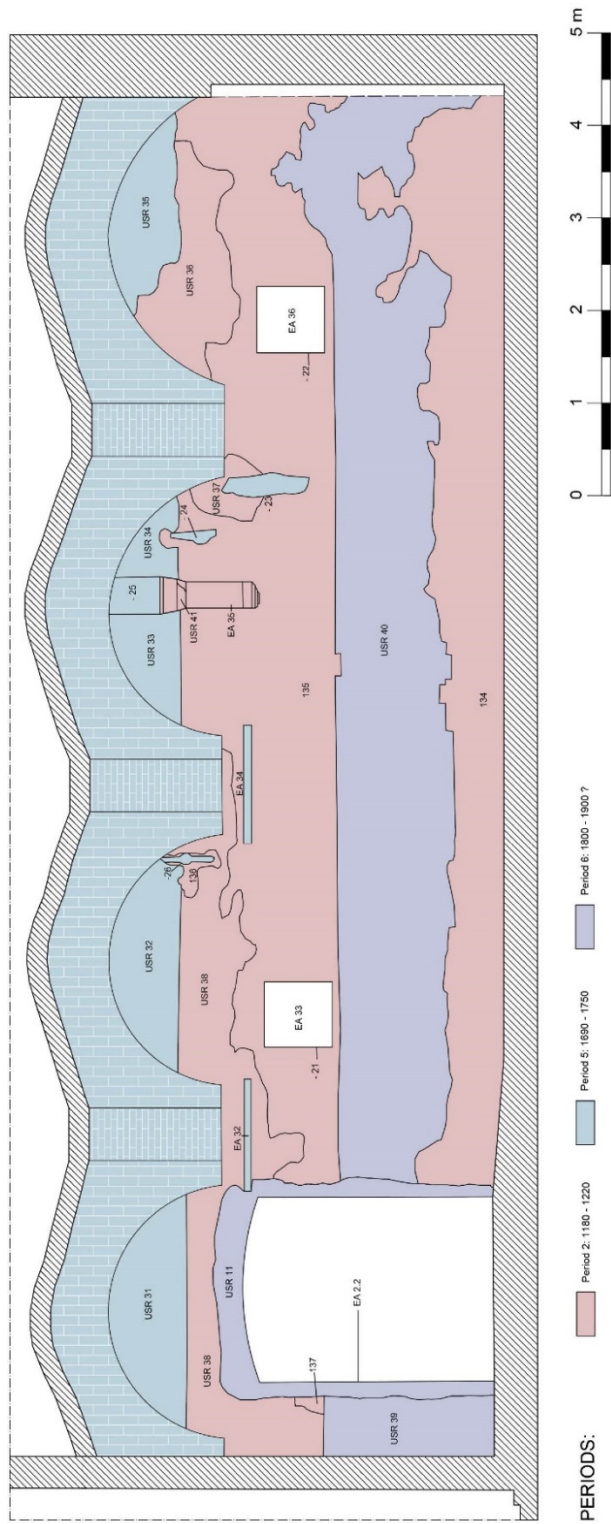

Figure 132. Chronological periods and units of the north wall of the refectory (see also TAV.8) - (elaboration F. Diara).

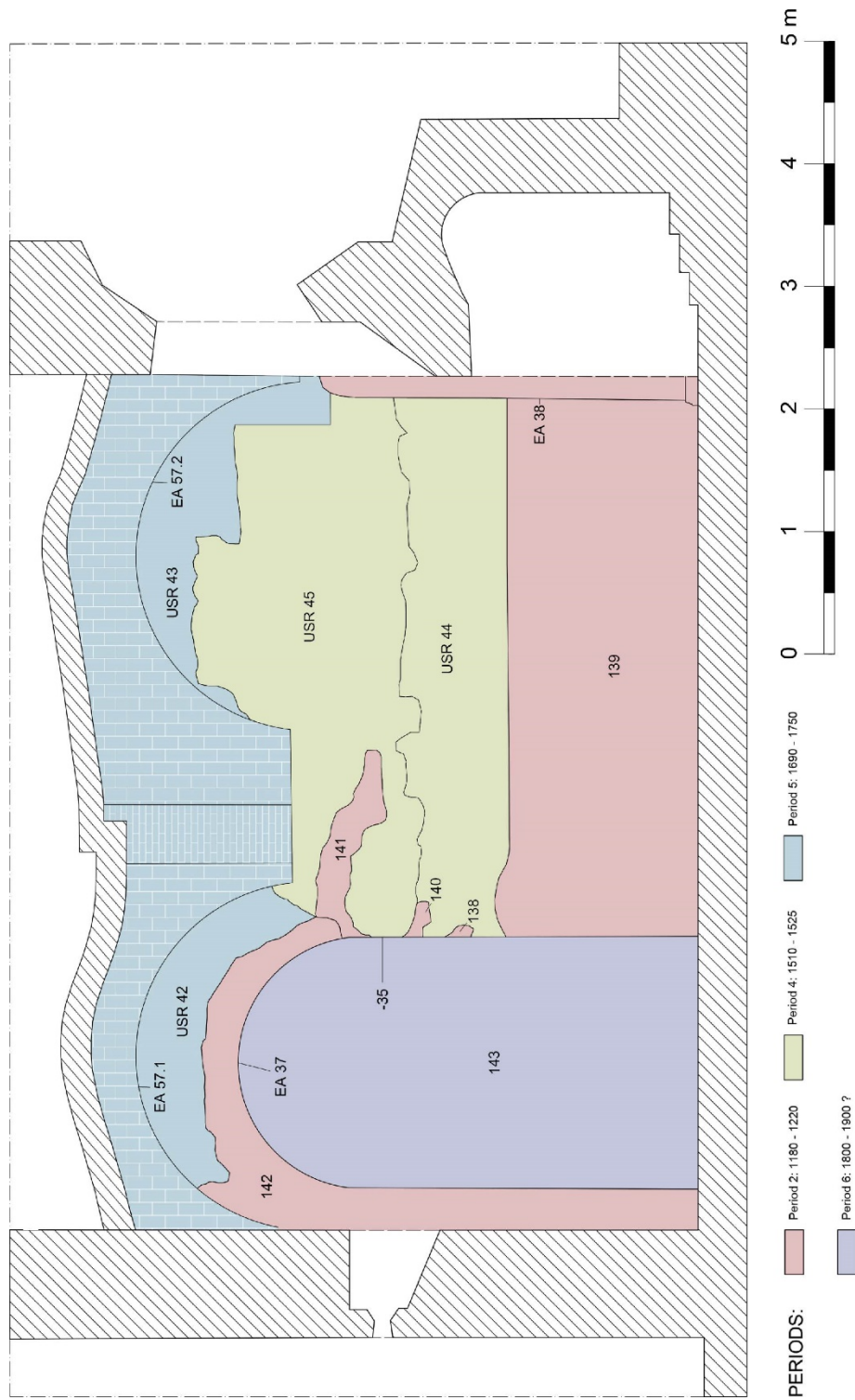

Figure 133. Chronological periods and units of the east wall of the refectory (see also TAV.12) - (elaboration F. Diara).

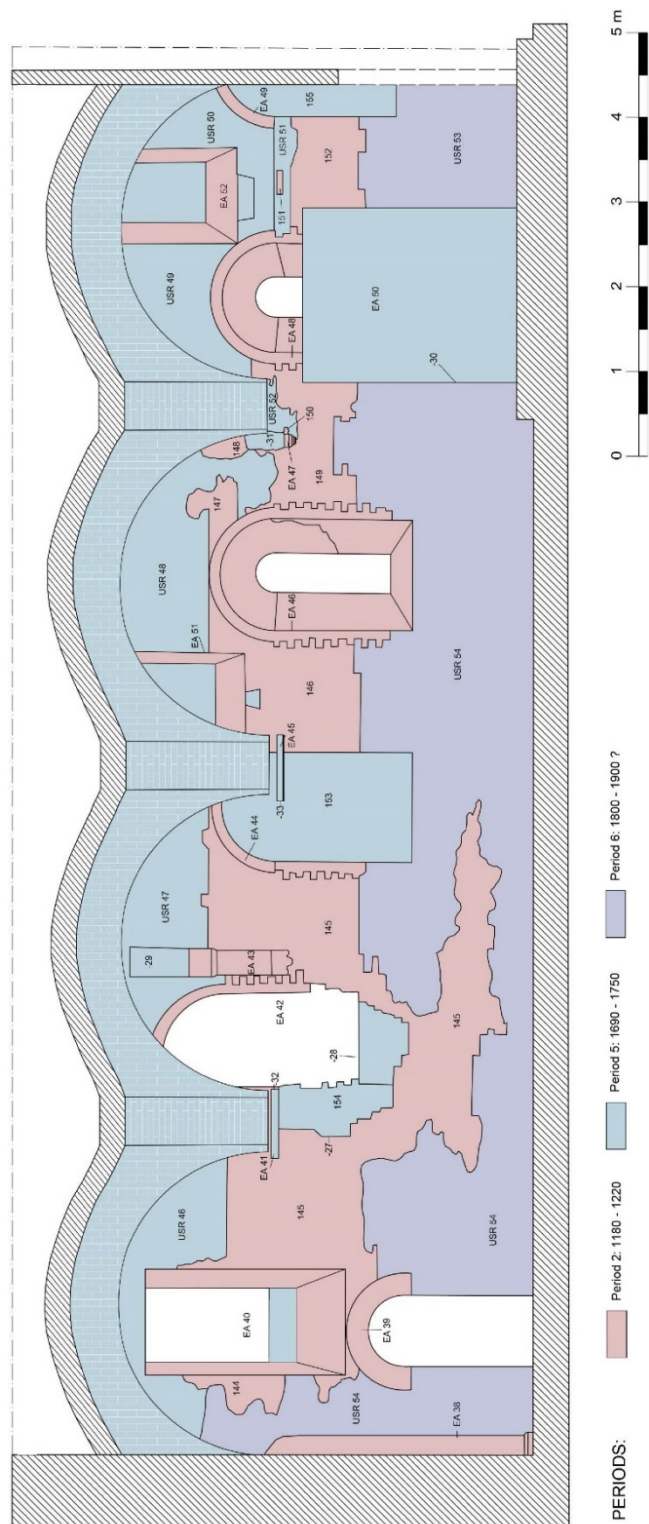

Figure 134. Chronological periods and units of the south wall of the refectory (see also TAV.16) - (elaboration F. Diara).



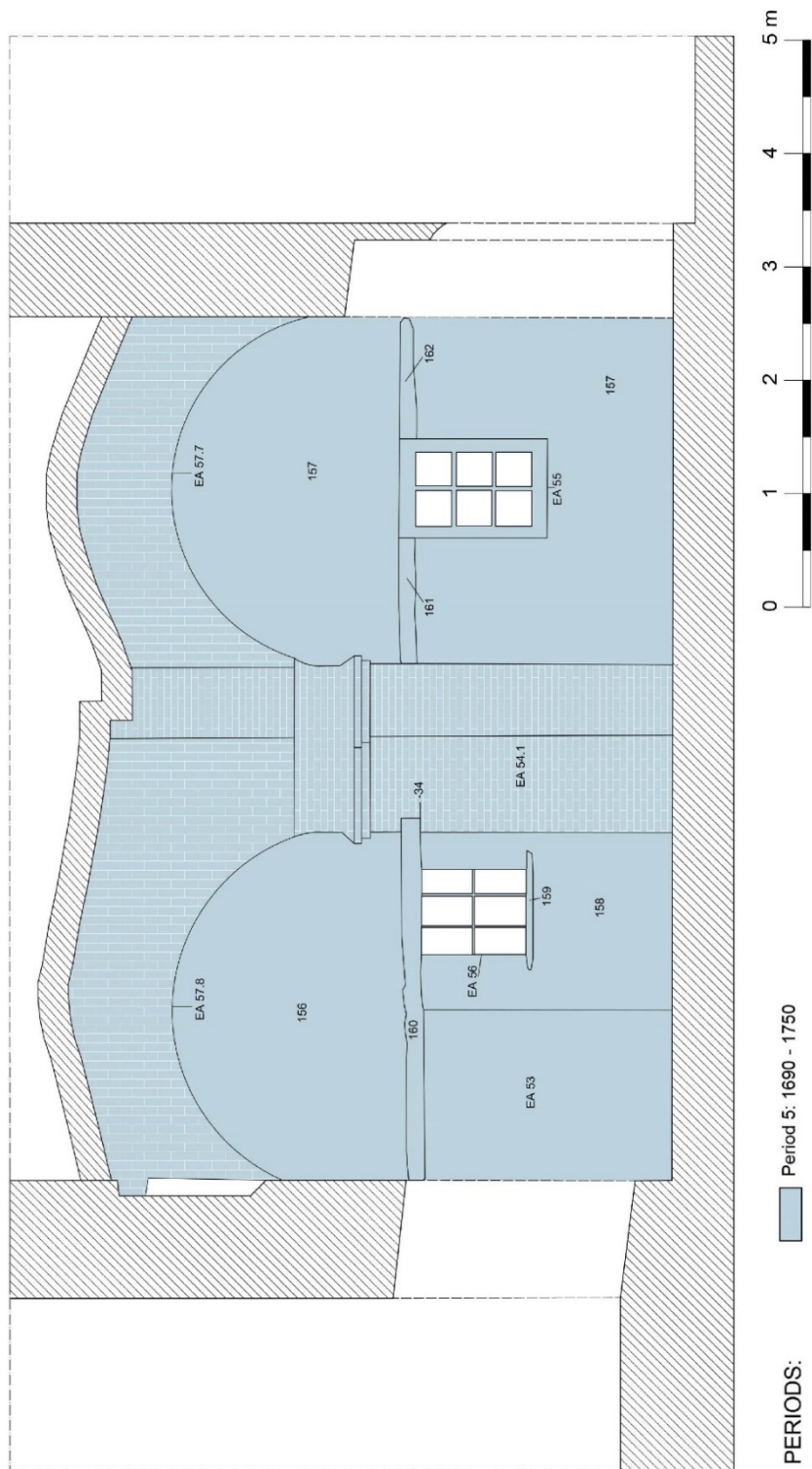

Figure 135. Chronological periods and units of the west wall of the refectory (see also TAV.20) - (elaboration F. Diara).



Figure 136. Suspended arches on the transept of the church (Photo F. Diara)



Figure 137. Suspended arches on the south front of the cloister (Photo F. Diara)



Figure 138. Suspended crossed arches on the south front of the cloister (the older height edge) (Photo F. Diara)



Figure 139. Detail of plaster and brick masonry with thin mortar joint on the south front of the cloister (Photo F. Diara)



Figure 140. Detail of the removed pulpit on the south internal wall of the refectory (Photo F. Diara)



Figure 141. South wall of the refectory: can be noticed the walled single-lancet window (related to the opened one to the right) and the new vaulted system above it (Photo F. Diara)



Figure 142. Detail of the semi-column related to the old ceiling on the north wall of the refectory (Photo F. Diara)



Figure 143. Detail of the stone shelf related to the old ceiling on the south wall of the refectory (Photo F. Diara)



Figure 144. West wall of the refectory and detail on the walled pillar and the new vaulted system (Photo F. Diara)



Figure 145. Detail of the walled pillar of the west wall. Picture taken from the additional camera created from the curtain west wall (Photo F. Diara)

## 8.4 Chronological interpretation of the refectory

The comparison between some stratigraphic units and elements, although they have not stratigraphic relations and matches, have a fundamental importance in order to read the original shape of the refectory and understand chronological matches and periods.

On the external front of the refectory that looks to the backyard there are some stratigraphic evidences and architectural elements that have to compare to other internal elements and evidences visible on the south front of the refectory. In fact, the presence of the four buttresses is crucial in order to comprehend internal matches as well as the original shape of the ceiling. In this sense, buttresses on the backyard (Fig.147), have to be compared with the evidences of the removal of buttresses on the south front of the cloister (Fig.146 - cutting actions covered by a grey plaster / mortar). Through the analysis of these evidences the original profile of five external buttresses (only four on the refectory area) can be noticed and compared to the remaining buttresses on the other external side of the refectory, maintaining the alignment. Moreover, the remaining and lost buttresses analysis have to be related to other architectural elements inside the refectory: the cornering column, the semi-columns and shelves / brackets concerning the old ceiling. Indeed, these supporting elements maintain the same alignment of buttresses, and for this reason the buttresses were supposed to support the column, the semi-columns and shelves / brackets and in general the old ceiling (Fig.142-143).

As we have seen, the actual ceiling of the refectory is referred to a groined vaulted system of the first half of the XVIII century. In this regards the four internal reinforcing anchors, placed on the middle of the arches, are related to this vaulted system, and only one of them (that passes through the small chambers) is complete getting also both bolted-end plates on the external fronts of the refectory.

However, the original ceiling should be different. Indeed, as mentioned before, it needed the support of the column, semi-columns, shelves / brackets as well as of buttresses. For this reason, the first ceiling system of the Staffarda refectory could be composed by a wooden trussed roof supported by diaphragm arches that lean on semi-columns, similar to the ceiling of the refectory of the already mentioned (chapter 3) Fossanova abbey that has this ceiling solution supported by the diaphragm stone arches that lean on stone semi-columns (Fig.28). This hypothesis may be confirmed, in addition to the presence of supporting architectural elements, also reasoning in terms of space solutions, in fact, this ceiling solution was often used in refectories as well as nurses of monasteries for the purpose of obtaining higher and brighter spaces and for the purpose of having a steadiest ceiling (Gallotta

E., 2018). Moreover, this hypothesis for the original ceiling of Staffarda refectory is supported by a drawing of Cesare Bertea of XX century (Fig.148)<sup>27</sup> that shows a transversal arches solution for the first refectory ceiling system (Beltramo S., 2018).

Another important comparison has to be performed as far as the plaster with a regular linear pattern is concerned. As we have seen, on south wall of the refectory there is a presence of a mixture of plasters (USR 51, USR 53, USR 54) that could be referred to the other plaster detected on the north wall (USR 39 and USR 40) at the same height from the ground, in fact, these plasters have an average height of 2.35 – 2.45 m from the ground. Moreover, a similar height could be detected through the analysis of the lower level of brick masonry of the external front of the refectory (USM 1.0 – USM 1.1 – USM 1.2), that has a height of 2.30 m from the ground. Comparing these average heights perhaps might be argued that the original internal plaster could get the same height of the lower level of brick masonry of the external front, at least as far as the central part of the walls is concerned. This hypothesis may be assumed even if the regular linear pattern on the plasters experienced in modern times retracing operations.

Concluding, the stratigraphic analysis of the refectory as well as the external fronts (cloister side and backyard / restaurant side) has been fundamental in order to detect and analyse stratigraphic units and architectural elements and in order to comprehend construction and destruction phases and then chronological periods. The refectory could be inscribed into 7 chronological periods, which passes evenly through the times:

#### **Period 1: 1160 - 1180**

The first period of the refectory is related to the early construction site of a block of suspended round arches after the last construction site of the church

#### **Period 2: 1180 – 1220**

The second period concerning the main external and internal brick masonry and contemporary elements, such as the entrance portal, the arches of the lost gallery, the stone shelves, the external plaster USR 1.0, the internal single lancet and square windows, the access to the pulpit and itself, the column, semi-columns and the stone shelves / brackets. In other words, all the elements related to the first ceiling.

#### **Period 3: 1230 - 1280**

This period is referred just to the suspended cross arches of the external front of the refectory.

---

<sup>27</sup> Cesare Bertea private archive, Pinerolo, binder 6, Miscellaneous, Restorations, Staffarda (Beltramo S., 2018a)



**Period 4: 1510 – 1530**

This is the period regarding the *Ultima Cena* fresco on the east wall of the refectory, and this chronological period can be detected just in this wall.

**Period 5: 1690 - 1750**

This is the chronological period referred to the main changes concerning the removing operations of buttresses and the gallery and the construction site of the first floor, the vaulted system with the related pillars and the west wall.

**Period 6: 1800 – 1900**

This is the most uncertain chronological period and it includes the covering curtain walls of square windows of the first floor and the internal original plaster retracing and re-brushing up, as well as the uncertain curtain wall of the access on the east wall.

**Period 7: 1910 – 1925**

This period is principally related to maintenance interventions on the external front of the refectory.

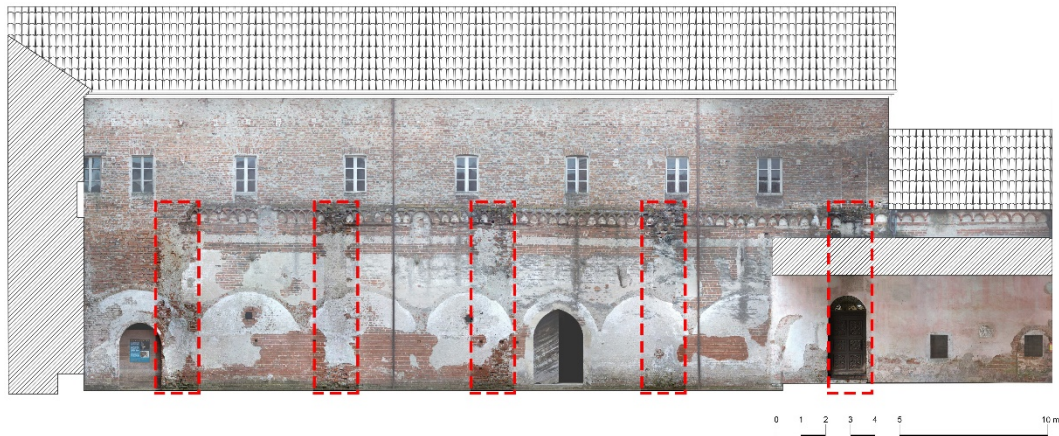

Figure 146. Buttresses marks on the south front of the cloister (Elaboration F. Diara)

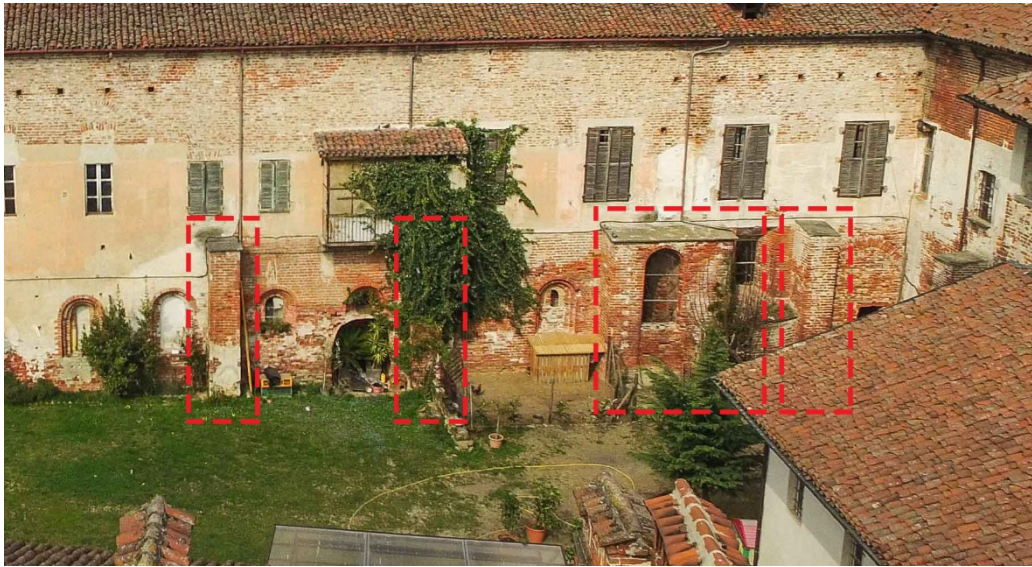

Figure 147. Entire buttresses on the backyard of the refectory (APR photo by M. Roggero; Elaboration F. Diara)

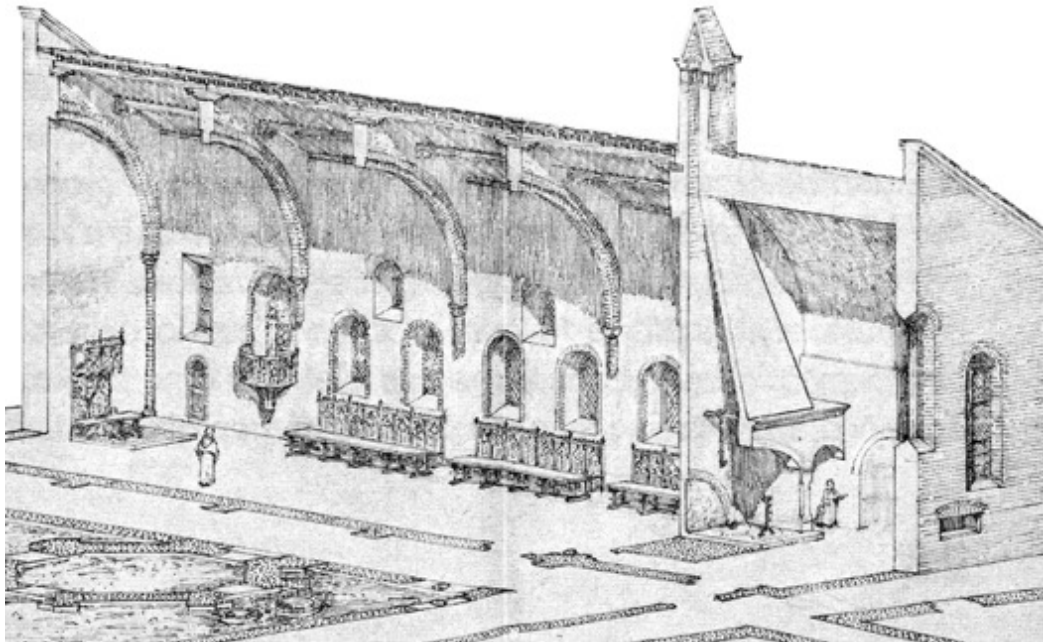

Figure 148. Staffarda refectory: drawing of Cesare Bertea (XX century). Cesare Bertea private archive, Pinerolo, binder 6, Miscellaneous, Restorations, Staffarda (Beltramo S., 2018a).

A further and fundamental interpretative step, as far as the historical evolution of the refectory is concerned, has been carried out by modelling the refectory through Rhinoceros software and then by using NURBS algorithm-based modelling technique. Performing the refectory NURBS 3D modelling, as we will see in the next chapter, the three-dimensional and immersive hypothetical reconstruction of the refectory, based on the interpretation phase here discussed as well as based on iconographic resources will be analysed and compared with the **NURBS 3D model** of the existing refectory. These analyses on 3D models and especially on **HBIM models** (in chapter 10), will help graphically and support the comprehension of the historical evolution of the refectory performed with the traditional stratigraphic units analysis.

# Chapter 9

## Refectory NURBS modelling

Actual BIM platforms include the parametric modelling of objects starting from geometric primitives which compose architectural basic elements, moreover modelling tools of these platforms (such as Autodesk Revit or Graphisoft Archicad) are based on predefined architectural families (walls, windows, columns and so on) or very simplified defined objects. As far as Cultural Heritage assets are concerned, nowadays is still complex and difficult to reconstruct very complex and high detailed architectures and complex elements by using predefined families or parametric modelling from scratch (Murphy et al., 2013; Adami et al., 2017).

The actual architectural elements could be related to parametric objects often introduced into architecture manuals and widely used by constructors and designers during the years, however, behind the theoretical models on the practice architecture there are many errors due to workers, structural loads and stresses and also restoration actions (Diara et al., 2019). In this sense, parametric and geometrically correct objects and elements cannot be used to represent the complexity of constructions. Despite this consideration, the usage of free form modelling software could ease this modelling phase, thanks for example to NURBS solution, whereby could be possible to represent, anyway in a simplified and conceptual way, complex architectural entities for example directly from LiDAR data (point clouds) or from slices and profiles derived from it (Banfi et al., 2017; Diara et al., 2019). However, the modelling phase is strictly affected by the ability of the modeller that uses the software and its commands tools. Moreover, this phase is widely linked to the modelling strategy carried out by the operator.

This reasoning brings us to say that modelling complex existing architectures and buildings is complicated ongoing research field and it still involves professional and elaborated modelling software and then more detailed and accurate modelling tools, including complex computer science algorithms and calculation processes, and in this regards NURBS modelling and Rhinoceros software are introduced.

Going deeper, the main modelling and parametrization workflow of this project is based on the method proposed by Oreni et al. (2014), and it consists in the NURBS modelling of existing buildings and the following parametrization and

conversion into BIM models, where the main parameter (editable) to be managed has to be the objects thickness. So, BIM solution would be a mainstreaming and conversion platform on which complete the geometry, volume and then the parametrization and information of objects concerning architectural elements. Parametric models derived from NURBS modelling could be compared to a kind of *digital integration for shape affinity*, comparing them as a digital reconstruction of a historic building based on interpretation and simplification of shapes, but always observing right geometries and volumes: the *shape affinity* theory has been thought by the architect Antón Capitel as an idea and method for critic and not stylistic integrations, for the purpose of easily distinguishing new parts from the oldest, and this method could be partially compared with BIM conceptual and simplified models (Capitel A., 1998; Carbonara G., 2013).

## 9.1 Introduction to NURBS models

NURBS (Non-Uniform Rational Basis-Splines) curves and surfaces are referred to the mathematical representation of three-dimensional geometries on computer graphic design. In this regard, splines are curves originally developed for naval architecture in order to represent a smooth curve (spline) following a set of points (knots). A basis spline curve is intended as a curve controlled by key points that influence its sliding course, but the placing of these knots, on curves, can be unevenly spaced, and for this reason curves assume the non-uniform mean. However, not all the control points influence in the same way curves, in fact, they could have a custom weight or a ratio (rational).

Then, a NURBS draw, being a smooth representation of a curve, can represent complexes shapes and geometries without approximating lines and segments. For this reason, by using NURBS modelling is therefore possible to modelling and reconstruct any complex and detailed architectural elements thanks to its non-uniform splines, and, for this reason, NURBS solution could be a versatile solution regarding modelling of complexes architectural elements (Oreni et al., 2014).

However, the drawback of this kind of modelling method is the lack of tools (into specific software) that could provide to parameterize the 3D objects created, indeed NURBS models aren't parametric model and for this reason cannot be implemented and used as BIM objects without a parametrization process (Oreni et al., 2014; Banfi et al., 2017; Diara et al., 2019).

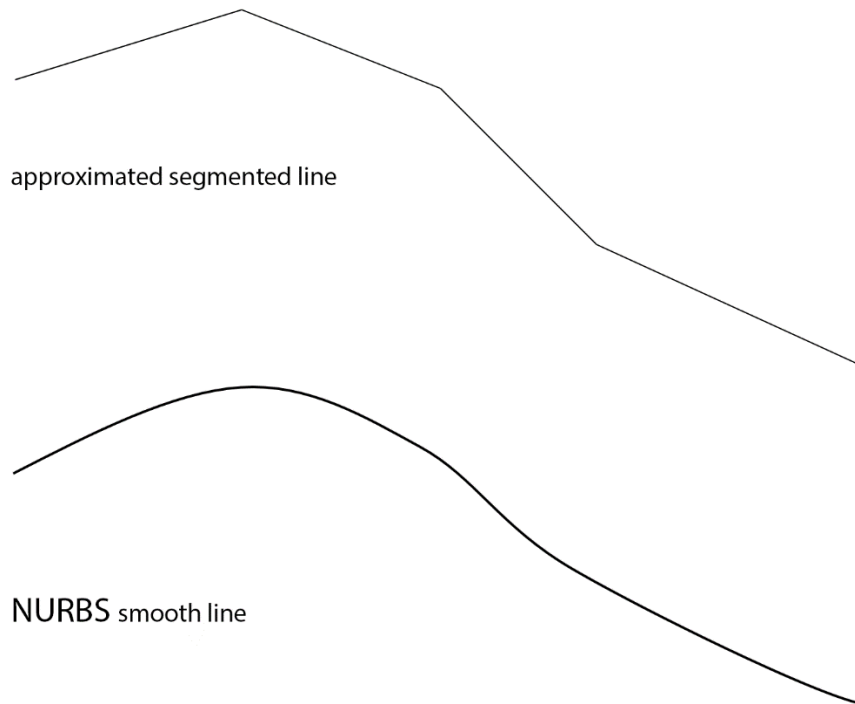

Figure 149. Differences between an approximated segmented line and a NURBS curve (elaboration F. Diara).

Another fundamental annotation to be considered regards differences between NURBS models and BIM exported models: the first group are graphical mathematical functions (smooth and homogenous shapes) while the second group is concerned with triangulated meshes. This difference involves also some cautions and precautions because surfaces natively created in a BIM platform and exported in a NURBS modeller software are divided in triangles and so they result not homogeneous and lightweight. On the other hand, NURBS objects, when imported into a BIM platform appears as meshes, and then triangulated objects (Tommasi et al., 2016).

Going deeper on the method, the modelling of NURBS objects results not a time-consuming method and, thanks to its developed mathematical architecture this method reduces the memory usage and load of computers during creations, separation or union operations (Boolean operations). So, the NURBS modelling method could be a really flexible solution and it could provide to reach, thanks to the usage of smooth curves and non-uniform splines, a global geometric continuity in a particular architectural element and in general in the final model (Oreni et al., 2014). Moreover, this kind of modelling method, that includes, as we will see, is

widely used by other professional figures as animators, designer and graphic artists especially for its resolution, details and rendering possibilities of modelling.

## 9.2 Rhinoceros as NURBS free form modeller

For the purpose of modelling detailed existing architectures, the best fitting choice could be guaranteed by using a pure free form 3D modeller, such as Rhinoceros software, developed by Mc Neel and Associates<sup>28</sup>. Briefly, this commercial – and affordable - 3D modeller allows modelling, starting from the uniform curves and wired profiles of LiDAR data, NURBS surfaces by using different command tools. Moreover, it is able to create and manage surfaces as well as solids, point clouds and meshes, allowing the exportation in different file format, for example 3DS – DWG – DXF – DAE – IGES – OBJ – PDF – PLY – STEP – STL – VRML main modelling formats, in addition to the own format 3DM.

### 9.2.1 Main features of Rhinoceros

Going into the specific layout of the software, Rhinoceros can arrange the projects work in different ways: by **layers**; by **groups**; by **blocks**; by **work-sessions**. As it is known, layers contain created 3D objects, while groups make possible to include different objects into a container. The organization of projects by blocks involves to collect and update a group of objects and work-sessions allows working in a project and in the same time managing other objects as references.

---

<sup>28</sup> [www.rhino3d.com](http://www.rhino3d.com)

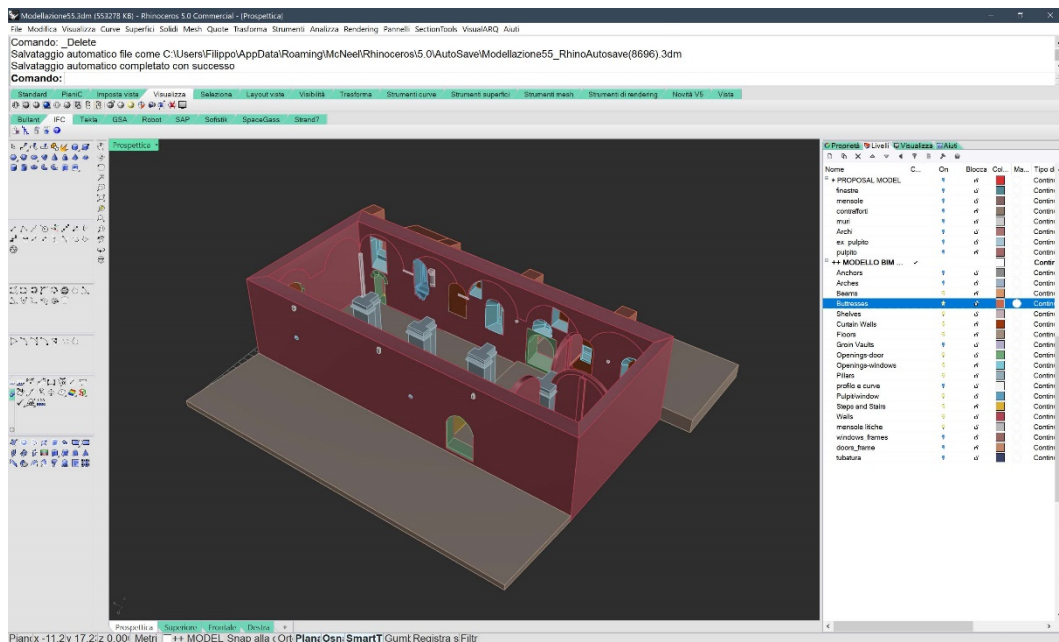

Figure 150. Rhinoceros interface: on top the command line, on left and below the command line the modelling tools placement, on right properties and layers, on foreground the 3D space (elaboration F. Diara).

As mentioned before, objects created with Rhinoceros can be points, curves and surfaces. **Points** are the simplest and easiest objects to be created in Rhinoceros and they can be drawn anywhere in the three-dimensional space. **Curves** (open or closed curves), as we have seen, are the mathematical representation and can be compared to free hands lines, being straight and / or wiggled. Moreover, curve can combine and join each other through control point or knots, then resulting in a segmented poly-curve. This kind of constraint modelling control can be also used to simply draw a curve, for example a curve that has to be slide following specific control points. Furthermore, as regards these kinds of representation, the developers have included a lot of commands concerning the curves modelling methods, such as lines, poly-lines, arcs, circles, helices, ellipses and spirals.

By using commands as **surface from edge curves**, **loft**, **sweep** (with a single or double rail), **patch**, surfaces and poly-surfaces can be created from curves that define the edges of the ideal surface. Moreover, surfaces could be managed and built also by editing U and V subdivision to a numerical value that is referred to the density of curves inside the model, so, the bigger value involves the more accurate geometry. More in detail, **Surface from edge curves** command creates a surface defined from curved edges; **Patch** tool fits a surface through selected curves, meshes, point objects, and point clouds; **Loft** tool fits a smooth surface through the



selected curves that define the surface shape; **Sweep** (two rails) tool fits a surface through a series of profile curves that define the surface shape and two curves that define the surface edges.

Moreover, Rhinoceros allows to manage other different operations after the creation of surfaces: in fact, commands like **Join**, **Explode**, **Trim**, and **Split** permit fusion, cutting off, decomposing operations among curves, surfaces, and poly-surfaces.

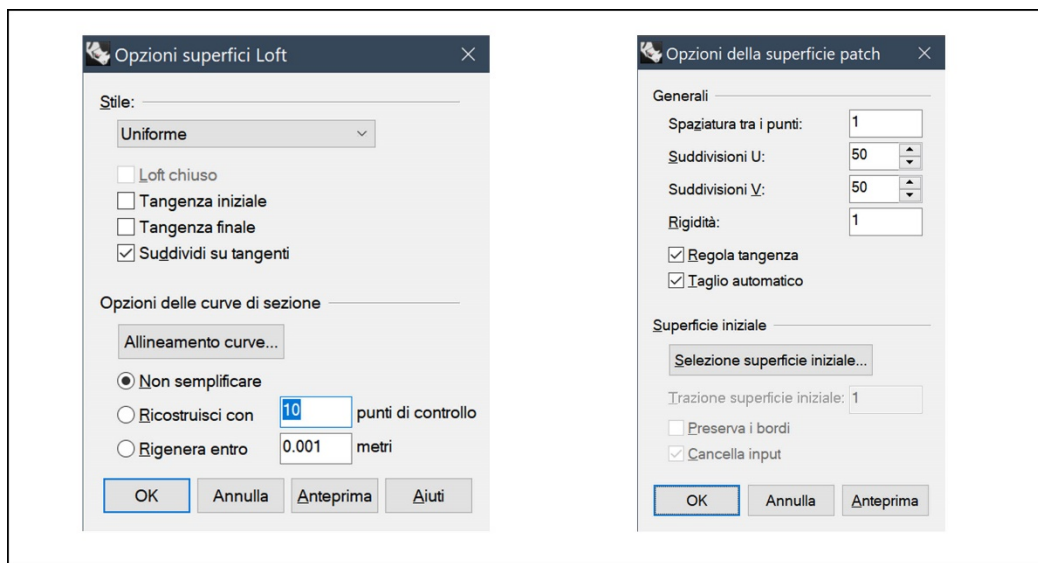

Figure 151. Modelling options concerning LOFT and PATCH command

Inside the 3D modelling software, the **visualization methods** are fundamental in order to visualize and understand objects and models depending on specific needs. In this regard, inside Rhinoceros the 3D space and models within can be represented and visualize in different ways, for example Wired, Shaded, Render, Semi-transparent, Pen, Artistic. As concerning the render view, models will display in grey scale until it will include the colour, texture or material.



Figure 152. Three different 3D visualization of Rhinoceros. From left: wired; shaded with profiles; render textured view (elaboration F. Diara).

In addition to processing operation as regards surfaces, post-processing computations can be performed for example analysing surfaces, solids and other objects: this is the case of the **Curvature Analysis** useful tool, which analyses the surface curvature computing and managing false colours mapping. Going deeper, this command analyses the Gaussian curvature (that is the measurement of a curvature of a specific surface in a particular point) including the minimum radius and the maximum radius of curvature.

Despite all these features and advantages, Rhinoceros is not a parametric modeller, because it not allows modifying and managing the metric parameters regarding a 3D solid object. However, the construction parametric workflow could be included by using different additional tools and **plug-in** for the purpose of adapting its characteristics to the increasing request of BIM modelling and construction methods (Diara et al., 2019). In fact, Rhinoceros can rely on a free plug-in called Grasshopper that allows creating and performing complexes parametric nodes networks, which could be applied to supervise and manage in a parametric way the objects. This solution might look good for the purpose of creating a BIM platform, but it is a time-consuming approach especially managing controlling nodes for complexes architectures and Cultural Heritage assets.

Furthermore, the plug-in Visual ARQ is a designed additional software for Rhinoceros for architectural design that allows adding to the main modelling workflow of the software useful commands in order to set up precompiled modern architectural families (it was not designed for existing buildings), especially for historical buildings such as walls, columns, beams, stairs. In addition, Visual ARQ ensures the IFC compatibility with the BIM standards.

## 9.3 Geometric primitives extraction

### 9.3.1 Introduction to geometric primitives

Geometric primitives, as far as the 3D modelling field is concerned, could be considered as the simplification of basic and theoretical geometrical shapes that compose for example an architectural element. Indeed, a building component could be decomposed into simple parts following the essential geometry, for example by extracting from element cubes, cylinders, cones and reconstruct and modelling the element by using these uniform shapes, performing obviously an interpretation and simplification modelling phase depending on the operator or modeller.

This kind of extraction could occur in several ways and these methods depend on the level of detail to reach and of course depending on the details and the complexity of architectural elements as well as the complexity and accuracy of extractions algorithms (Lo Turco et al., 2017a; Murtyoso A., 2019): in fact, the AUTOMATIC extraction of geometric primitives, by using particular software, plugin and specific algorithms, could be useful as concern simple elements and not to much complexes architecture (modern simple architecture could fit well), because this kind of extraction computes a great discretize and simplify operation; the SEMI-AUTOMATIC method is concerning the extraction and the identification, by using specific tools and algorithms, of geometric shapes from cross section and planar section; the MANUAL approach could be the best fitting choice for Cultural Heritage assets, due to historical buildings combine complex surfaces and shapes, distorted building areas, decorations and details that have to be interpreted, discretized and modelling following good criteria that obviously depends on the modeller. The manual method could be considered not properly extraction of geometries but a mere comprehension and interpretation of shapes related to the building to be modelled.

Then, the automatic classification and segmentation is a critical task as regards Cultural Heritage assets because could simplify too much the peculiarities and details of architectural elements, and it depends on the automatic mathematical functions and algorithms on the basis of the computation (Murtyoso A., 2019). However, also by using the manual approach these historical architectural elements have to be interpreted, represented and approximated according to the researcher needs and to level of detail of the research goal (Lo Turco et al, 2017a).

So, the extraction or comprehension of geometric primitives and shapes needs to be performed carefully depending on different things and this operation requires a critic thought.

### 9.3.2 Refectory geometric primitives

The followed procedure in order to understand and extract geometric primitives of the refectory has been based on the MANUAL approach, and it has been used by interpreting geometrical shapes from planar sections derived from reality-based model. Indeed, by using Rhinoceros software, planar sections concerning the whole refectory has been divided into different parts in order to obtain clean sections (obtained by using different distances between planes depending on architectural elements) for each component, for example for openings, for pillars and so on.

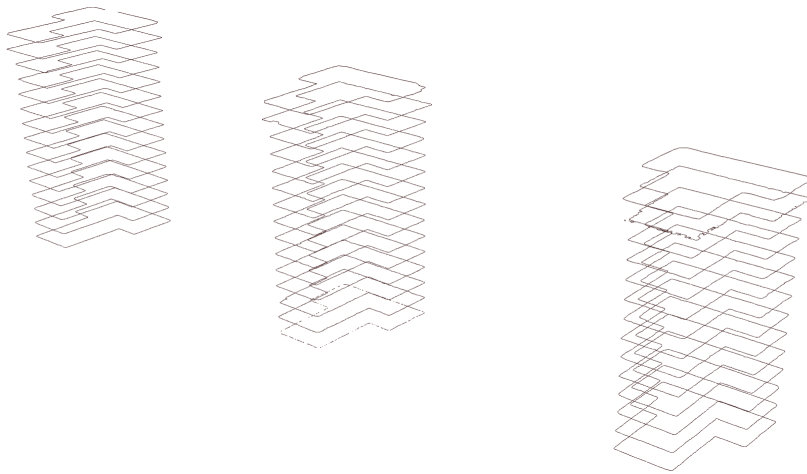

Figure 153. Planar sections (X plane) related to pillars (elaboration F. Diara).

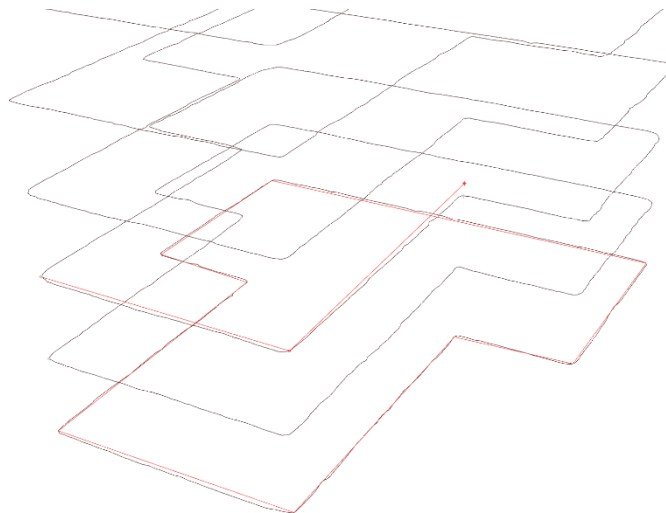

Figure 154. Geometries interpretation: in red the interpretation and simplification of geometrical basis of a pillar (elaboration F. Diara).

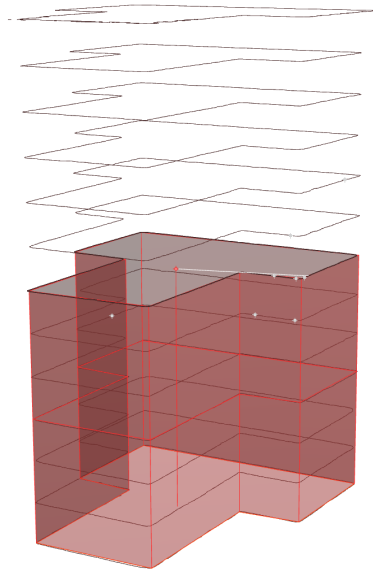

Figure 155. Simplified creation via extrusion of the pillar' shape (elaboration F. Diara).

As mentioned on the *Data processing and management* chapter, this operation hasn't been performed as far as the ground of the refectory is concerned, because, as described in chapter 6, the interpretation and extraction of the geometrical uniform shape of the ground has been carried out by extracting (in this case automatically) best fitting planes by using 3D Reshaper software, and in this way a geometrical regular shape has been matched on the real irregular shape of the refectory, that has different deformities and height level due to the clay material.

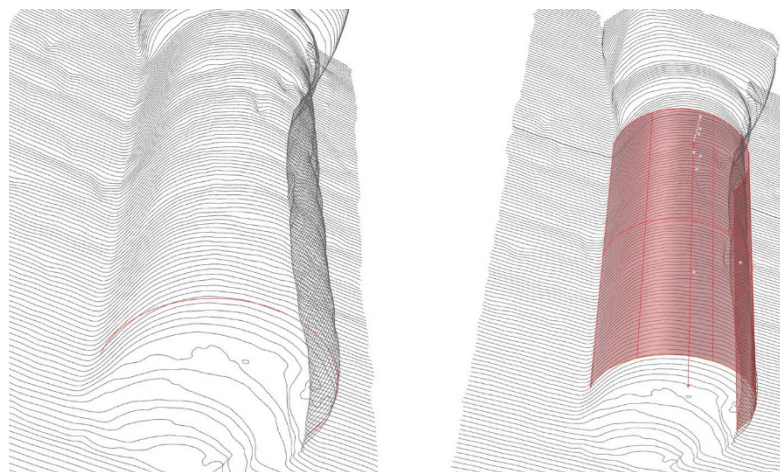

Figure 156. Detection of the semi-column geometry and simplified creation via extrusion (elaboration F. Diara).

Comprehending and extracting manually the essential geometries of the architectural elements (cubes, cylinders, triangles and their volumetric evolution), operations of synthesis, approximations and simplifications have been anyway performed due to the main goal: for the creation of a fitting and conceptual model able to collect and produce information. Indeed, BIM models, due to their information and data complexity, have to be necessary conceptual and simplified model, unlike the reality-based models.

Going deeper and established these constraints, the comprehension and extraction of geometric primitives has been carried out manually by using NURBS geometric and mathematical curves and poly-curves (such as arcs, polylines and so on), in order to represent all geometries and the essential shapes of each architectural element. Indeed, starting from planar sections imported, a simplified wired profile concerning geometries of all elements has been possible to obtain by drawing NURBS curves directly on sections, interpolating NURBS curves on sections and in this way the logic of construction, although interpreted, has been performed. In this way, this method involved the creation of a complete wired profile of the refectory.

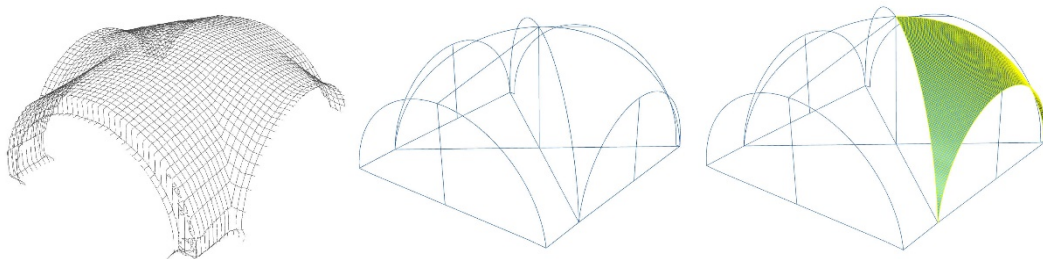

Figure 157. Interpretation of wooden centring of a vault: from reality-based planar section to model (elaboration F. Diara).

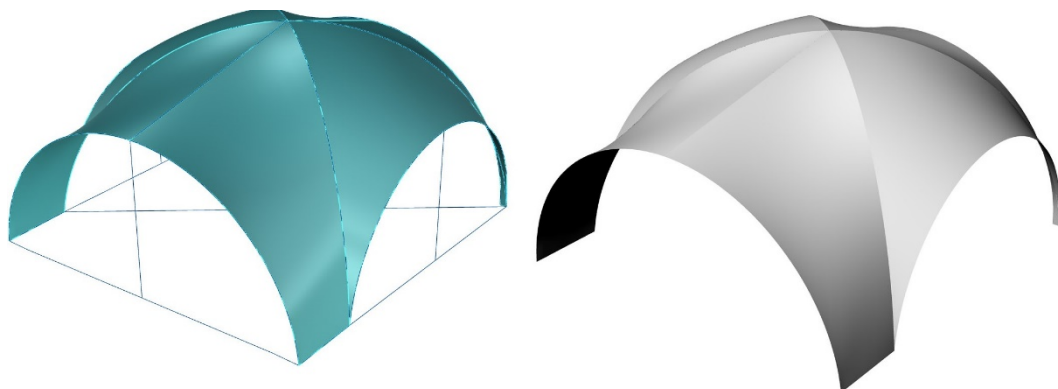

Figure 158. NURBS model of the vault, by using the defined spar profile and PATCH command (elaboration F. Diara).

As far as the comprehension of geometries of vaults is concerned, it has been carried out by interpreting and simplifying the shape of the wooden centring used for the creation of the vaulted system, and then it has been modelled on planar section.

## 9.4 Modelling the refectory

The 3D modelling of the refectory has been carried out by extracting primitive and using NURBS geometric and mathematical curves and surfaces, in order to represent all geometries and features in all their geometrical complexity and avoiding the predefined BIM libraries, even if discretizing and simplifying operations have been required. In this sense, starting from planar sections derived from reality-based model imported, the entire spar profile of the refectory, element by element, has been possible to obtain by drawing lines, polylines and curves directly on sections. Moreover, performing this operation can be possible the simplification of shapes through the comprehension of the main geometry of the building (Attico et al., 2019). Then, the choice of performing the modelling phase by using Rhinoceros has been taken in order to reach a good level of detail as far as the future parametric conversion is concerned: as we will see the obtained result can be referred to LOD 500 (Oreni et al., 2014; Banfi et al., 2017), that is a detailed 3D representation including objects attributes (as mentioned on *Methodology* chapter).

### 9.4.1 3D modelling of architectural elements

#### **The ground**

As mentioned on the *Data processing and management* chapter, due to its irregularities, the ground of the refectory has been modelled starting from the automatic best fitting planes and planar sections extracted during the point cloud management. Indeed, by using planes and sections has been possible to shape NURBS profile (splines curves via polylines) of the ground. Obviously, this operation has been characterized by the simplification of the original planar sections, which had irregular profiles due to the real structure detected by the point clouds.

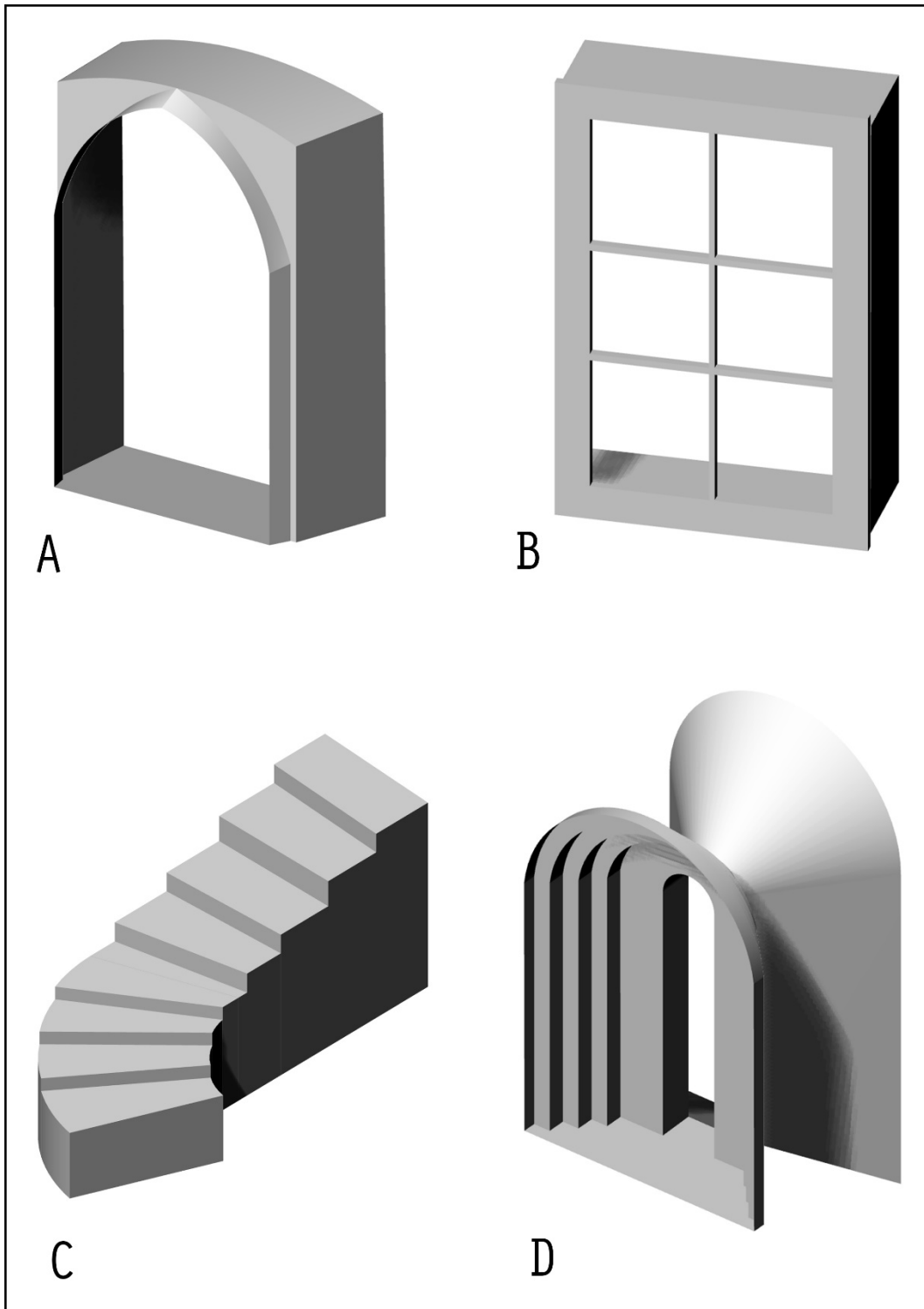

Figure 159. NURBS models of the refectory (1): entrance portal (A), squared modern window (B), pulpit access stairs (C), single-lancet window (D) (elaboration F. Diara).



Defined the spline profile of the ground, which is composed by 6 blocks and levels of height, NURBS surfaces have been created by using PATCH tool, then these surfaces have been extruded depending on right average height of blocks measured on the point clouds.

### **Pillars**

Pillars and their frames have been modelled starting from NURBS curves profile draw on X, Y, Z planar sections extracted from the reality-based model. The height of pillars, about 3.20 meters, has been modelled by extruding the T shape profile until the frames, which have different profile width and they have modelled by using the same extrusion method.

### **Openings - Windows (squared and single lancet)**

Single lancet windows, which have decorative splays with columns or pillars shapes, have modelled by drawing spline basis profile and extruding it until the connection with the arches of windows. This terminal part has been modelled by using SWEEP tool with two rails concerning the inner and outer NURBS profile of the arch. Square windows and frames related to the west side wall have been reproduced drawing NURBS polylines of on X, Y, Z planar sections extracted from reality-based model, then surfaces have been reconstructed by using PATCH and LOFT tool.

### **Openings - Doors**

The 3D modelling of openings related to the doors followed the same method related to the windows. In fact, starting from planar sections have been created splines profiles of accesses to the refectory and the related depth through the walls by using the LOFT tool.

### **Walls**

Walls have been reconstructed by drawing (NURBS polylines) floor plan starting from X, Y, Z planar sections extracted from reality-based model, then walls have been extruded from the profile by following the right height of walls measured on metric LiDAR data. In this case, an important simplifying phase has been planned and performed in order to obtain regular and planar profiles of walls for the future integration on the BIM platform. In fact, the refectory walls are not plane and show different distances and inclination from an ideal vertical plan: to overcome this common issue wall have been modelled simplified into perfect vertical planes, always based on the initial planar section (has been performed a manual best fitting

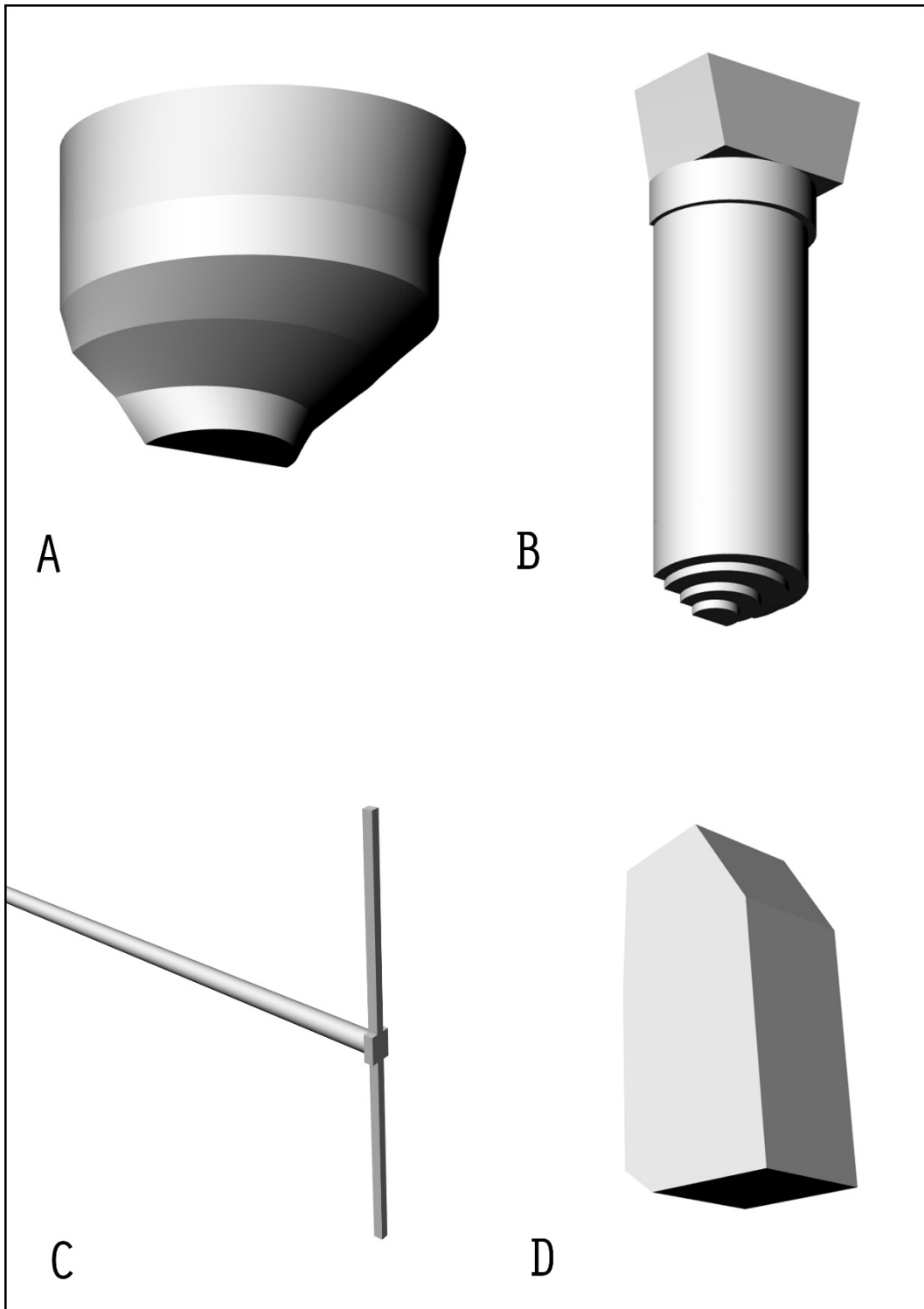

Figure 160. NURBS models of the refectory (2): decorated stone shelf (A), semi-column (B), reinforcing anchor (C), raw stone bracket (D) (elaboration F. Diara).

plane). The solid extrusion of walls has been performed into FreeCAD platform, acting subtractions operations related principally to openings models, and then windows and portals.

### **Anchors**

Reinforcement anchors have been modelled by drawing circular diameters of bars and then reconstructing its entire structure using the LOFT tool. Moreover, the bolted-end plate of the unique whole anchor has been reproduced by drawing its profile following planar sections related to it and then extruding the structure, keeping right measurement.

### **Arches**

Arches referred to the vaulted ceiling have been reconstructed defining their curves profile on real section related to the planar section. Their structure has been modelled by using the LOFT tool that has allowed to obtain their geometry by blending the two edges reconstructing the entire space among them. The arches depth has been modelled inside the BIM platform in order to obtain a parametric extruded object, according to the brick dimension and also including the depth of plasters.

### **Beams**

Beams are related to the wooden structural beams above the windows on the west walls. Beams have been reconstructed by drawing their profile (using curves polylines), then their depth has been modelled by extruding profiles element according with the real measurement.

### **Buttresses**

Buttresses, placed on the south external front of the refectory, have been modelled by drawing first of all the floor profile of them and then extruding it. The wall and the included buttress related to the coverage of the old access to the pulpit has been modelled by using, starting from the spline profile, principal tools as LOFT and PATCH and then applying the right depth.

### **Shelves / brackets**

Stone medieval shelves have been modelled defining first of all the profile from the real section related to planar section and then single (simplified) shapes have been reconstructed by using LOFT command. Moreover, rectangular shelves have been defined by extruding (following the right thickness) the NURBS profile derived

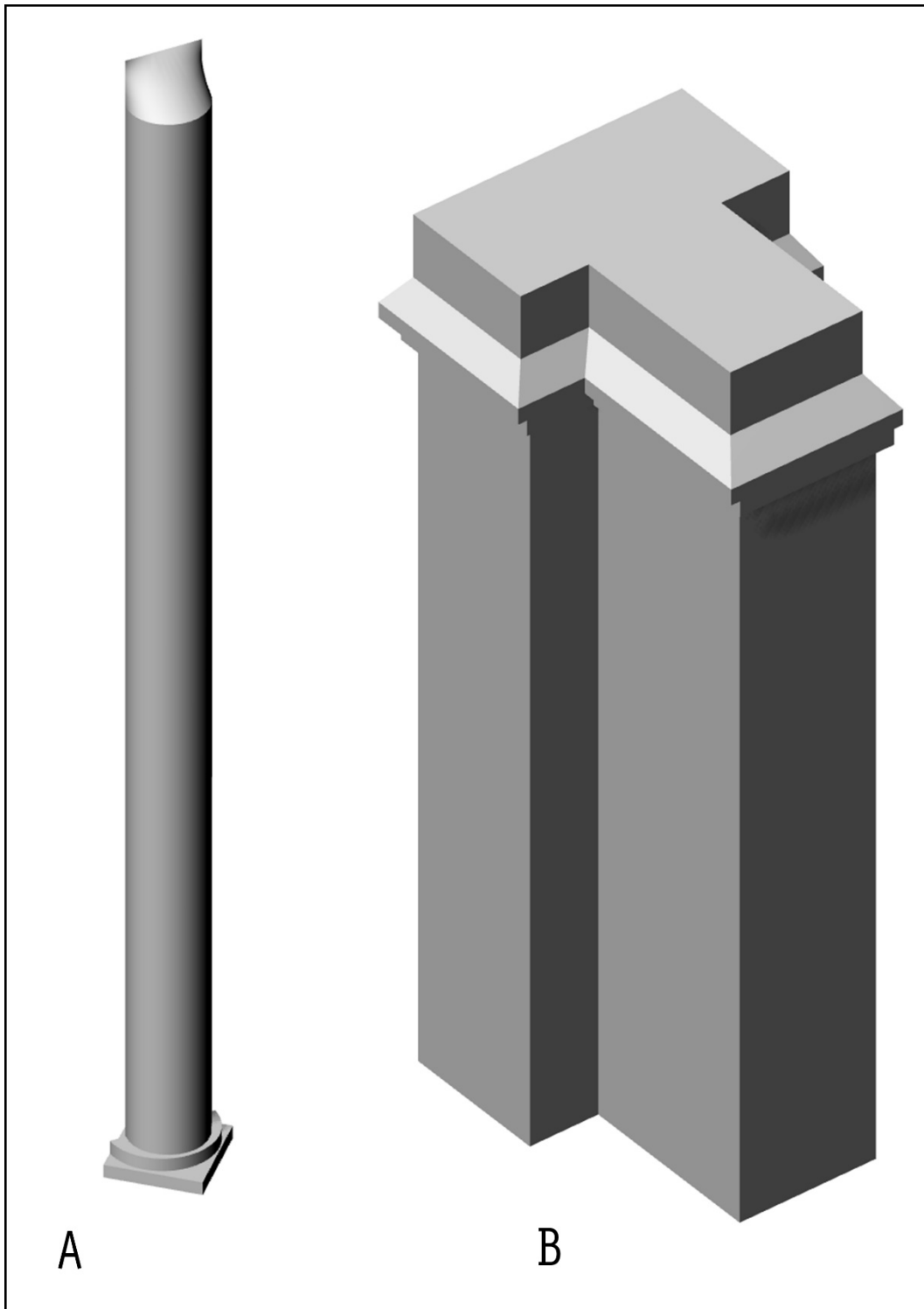

Figure 161. NURBS models of the refectory (3): cornering column – that has a removed capital – (A) and one of the five pillars (B) (elaboration F. Diara).

from planar sections. These elements, especially stone shelves, have been modelled by simplifying the original shape and decoration.

### **Column and semi-columns**

The column related to the corner support of the old ceiling of the refectory has been divided in two components: the stone torus moulding and the column broken on the upper part. Shapes related to the column have been defined by drawing the basis profile of moulding (modelled by using extruding operations) and then by drawing the semi-circular profile of the cornering column and then extruding depending on right measurement. As the previous elements, the column and semi-columns (both related to the original ceiling of the refectory) have been modelled by simplifying shapes and decorations (in a conceptual way), especially as far as the capitals are concerned.

### **Stairs, steps and ramp**

Stairs are referred to the access on down level of the two additional chambers defined by the separation wall and related to the access to the old pulpit.

Both groups of stairs have been modelled by extruding single steps, after the steps and structure definition of the profile from the planar section.

In the same way, the step related to the banking ground of the north additional chamber has been modelled by extruding the profile of it, defined from the planar section.

The difference in height of the clay ground on the main hall of the refectory has been classified and discretized as ramp (natural) element, and it has been reconstructed defining the entire NURBS profile and the modelling by single shapes using the LOFT command.

### **Vaulted ceiling**

Starting from planar sections imported, the spar simplified profile has been possible to obtain by drawing NURBS curves directly on sections. As mentioned before, this operation has been carried out interpreting and simplifying the shape of the wooden centring used for the creation of the vaulted system. After the definition of this “virtual” spar centring, shapes and vaults have been modelled by using the PATCH command in order to reconstruct fitting shapes related to the vaults.

This operation has been carried out by editing U and V subdivision of the PATCH command to 90, and this value is referred especially to the density of curves inside the model, and in general how this shape fits on the edges of the profile (90 value is considered a high quality parameter for big shapes).

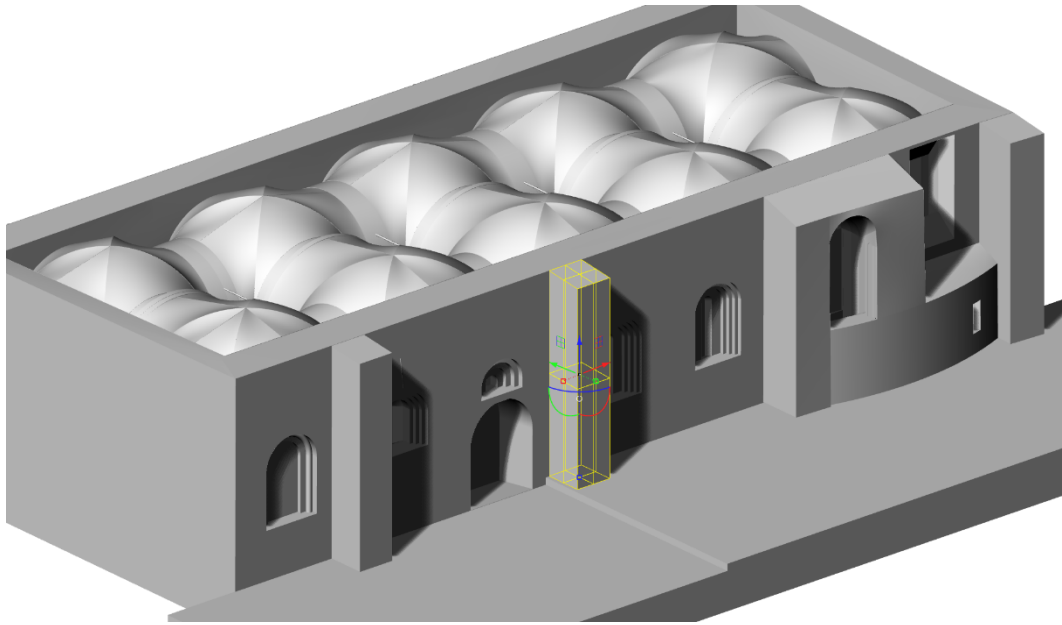

Figure 162. Rendering view of NURBS modelling of buttresses on the backyard side (elaboration F. Diara).

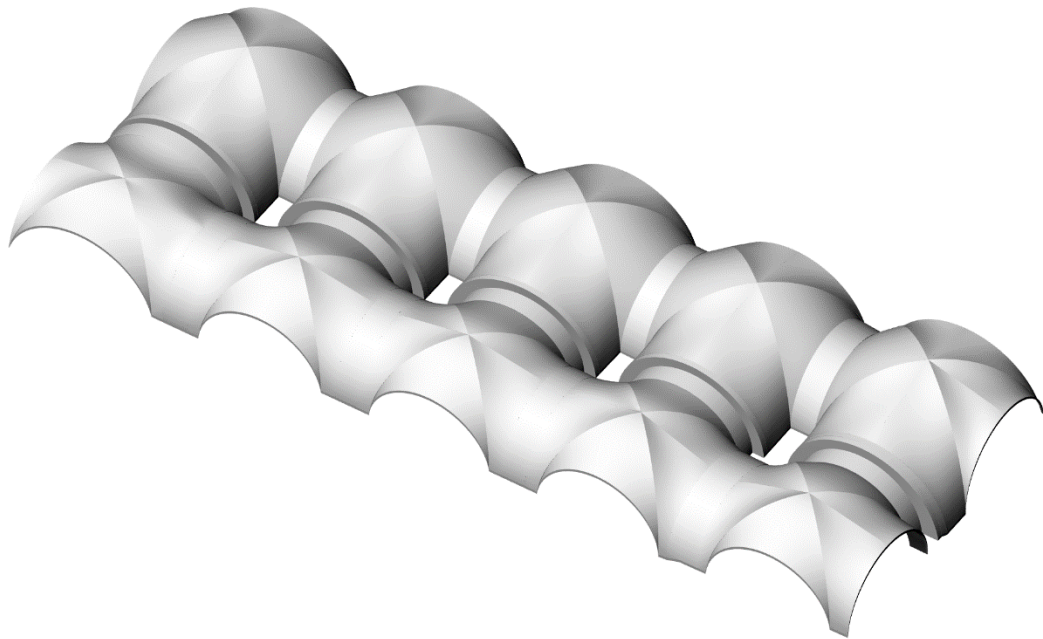

Figure 163. Rendered NURBS model related to groined vaults and related arches (elaboration F. Diara).

The NURBS model of the refectory obtained has high quality details and the high density of shapes and surfaces related to architectural elements, however, it cannot directly be implemented into a BIM platform because it is not a solid parametric dynamic model especially because NURBS surfaces haven't the thickness parameter. In fact, despite the creation and managing of some objects depth and then their thickness (carried out for the purpose of modelling architectural elements in their completeness), this kind of parameter has to be necessary to set-up and parametrize into BIM platform for the correct integration, as demonstrated in other studies (Oreni et al., 2014; Banfi F., 2017). Indeed, this operation has been performed into FreeCAD BIM environment and its additional features and workbenches, after the exportation of models by using the STEP file format (Standard for the Exchange of Product model data), defined by ISO normative 10303-21.

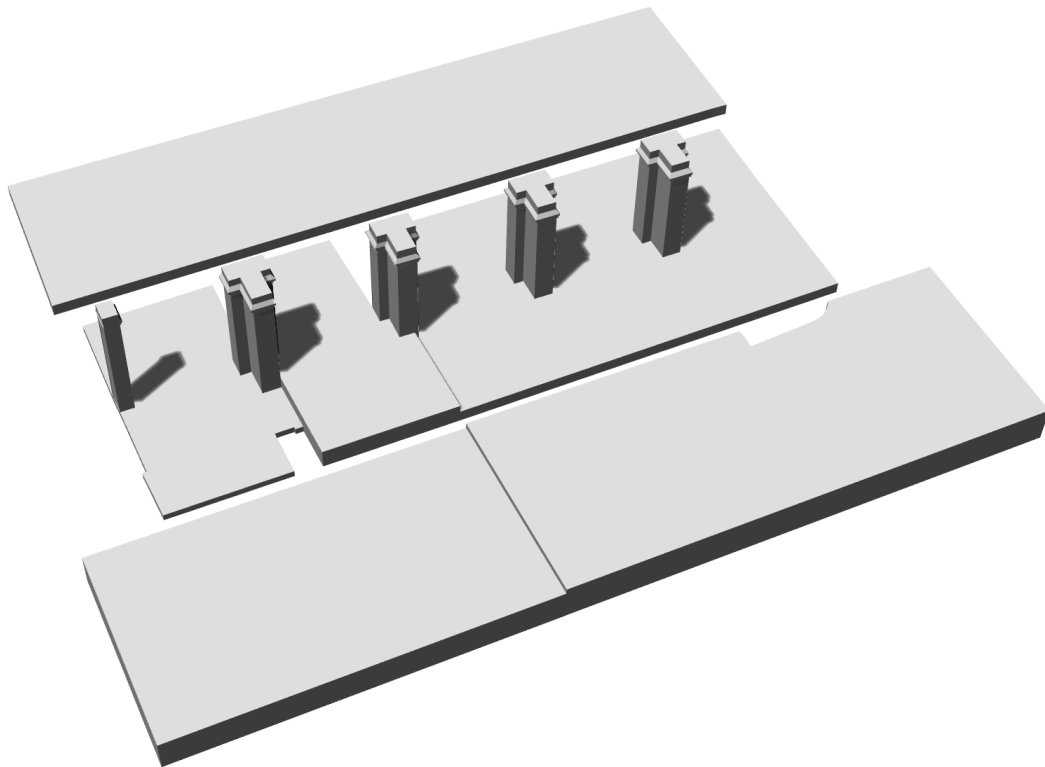

Figure 164. Detail on macro NURBS models created: the ground and the five pillars (elaboration F. Diara).

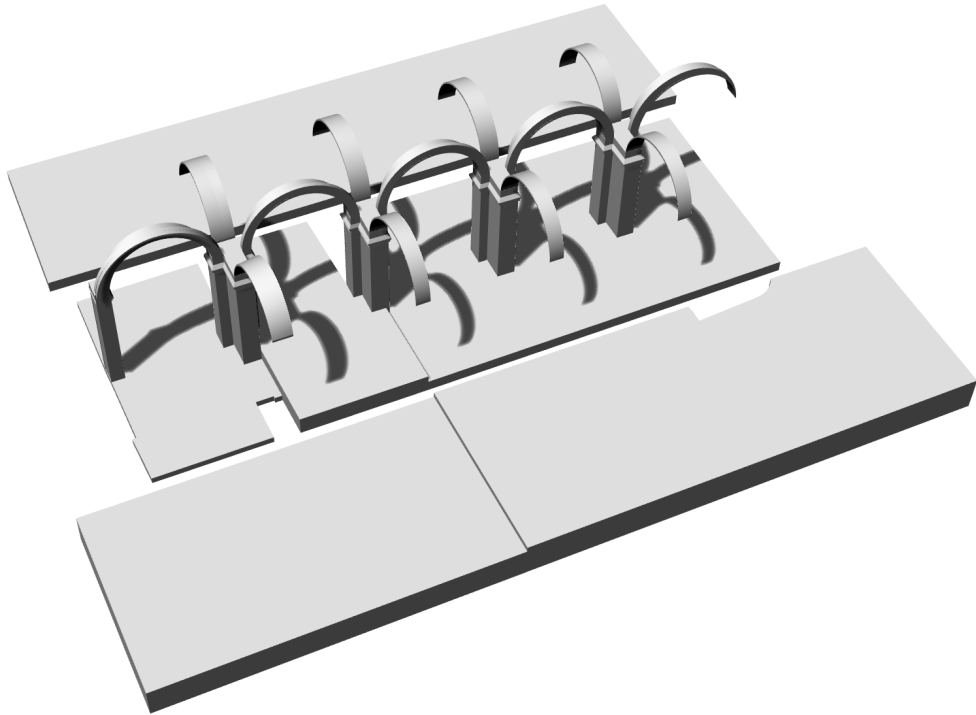

Figure 165. Detail on macro NURBS models created: arches related to the ceiling (elaboration F. Diara).

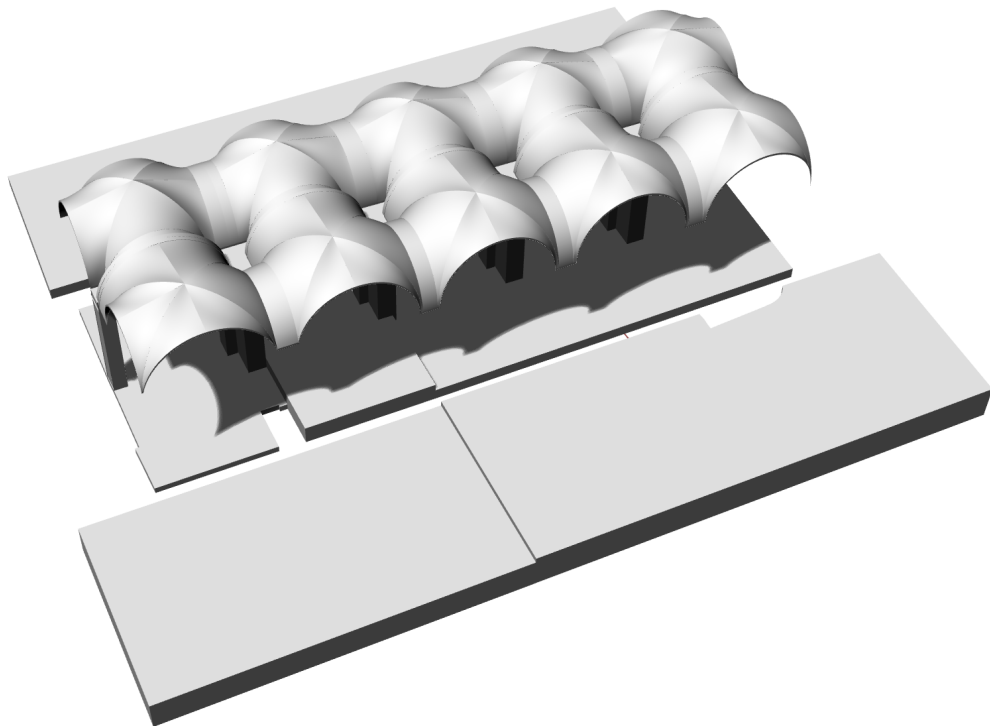

Figure 166. Detail on macro NURBS models created: groined vaults (elaboration F. Diara).



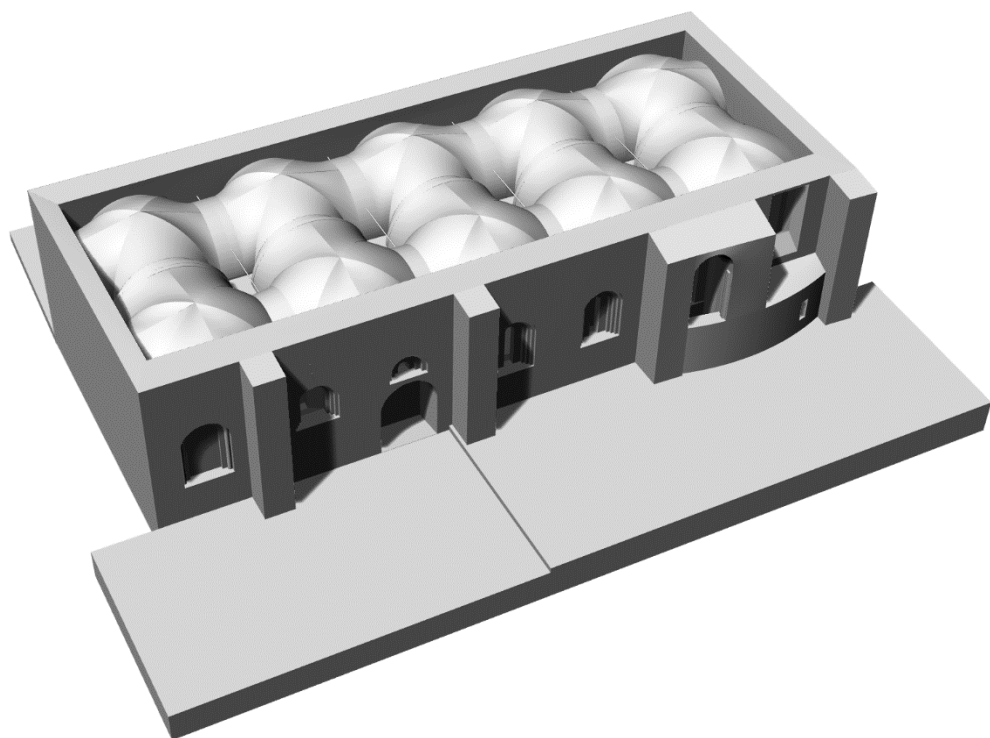

Figure 167. Rendered NURBS model of the refectory (perspective view) - (elaboration F. Diara).

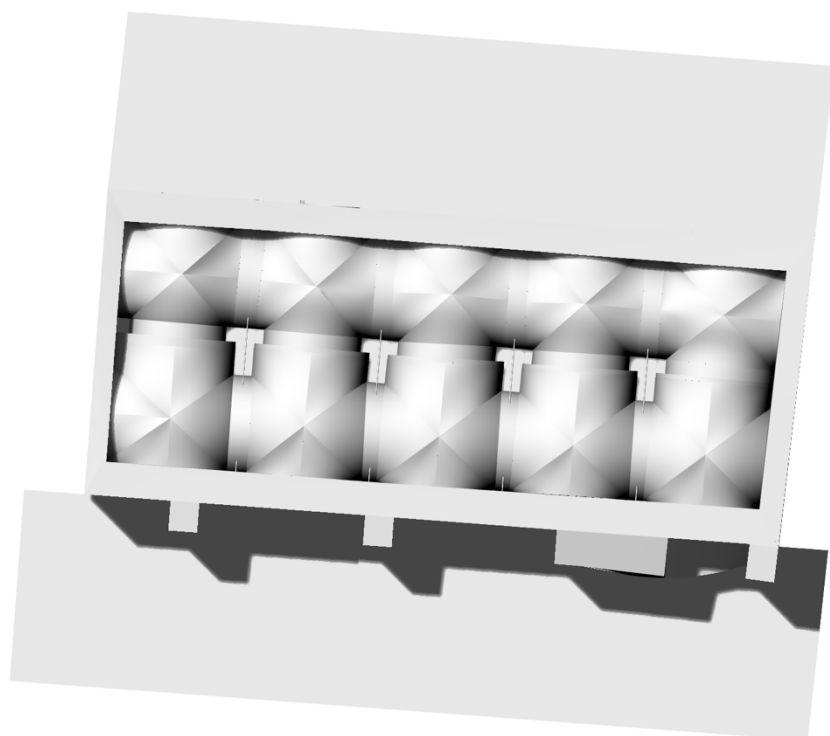

Figure 168. Rendered NURBS model of the refectory (upper view) - (elaboration F. Diara).



Figure 169. Exploded NURBS model of the refectory (cloister side) - (elaboration F. Diara).

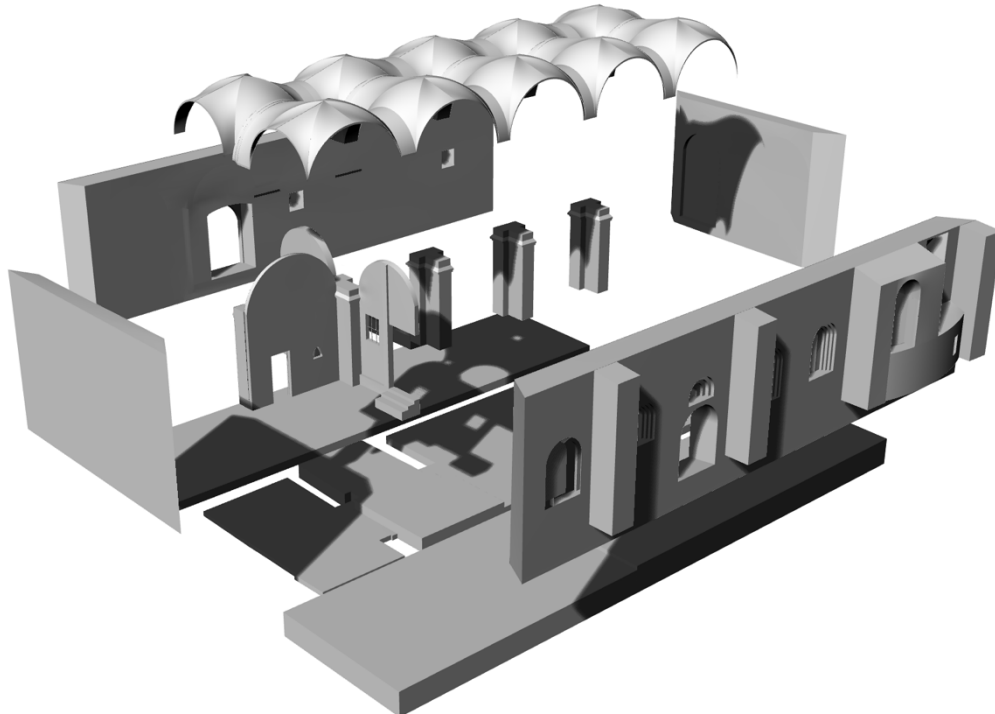

Figure 170. Exploded NURBS model of the refectory (backyard side) - (elaboration F. Diara).

#### 9.4.2 Grade Of Generations analysis

The scale of representation and the modelling complexity have to be a fundamental point in order to correctly manage the modelling phase. This classification scale is based on levels of details (LODs) that, furthermore, has to be fitting with the project goal in terms of quantity and quality of connected data and analysis (Diara et al., 2018; Chow et al., 2019).

As far as the LODs are concerned, they are classified, and it is a BIM standard (Italian normative UNI 11337-4 2017), depending on the modelling details of parametric BIM models: in fact, this range goes from LOD 100 to LOD 500, where LOD 100 is concerning the two-dimensional phase of modelling and by contrast the LOD 500 is referred to the high quality 3D representation, including all the attributes regarding the object<sup>29</sup>. Moreover, as concern Cultural Heritage assets LOD is related to the quality of metric survey (photogrammetry or laser scanner and their metric precision), the data management and last but not the least the modelling ability of the modeller and of the software (Fai et al., 2011; 2014; Chow et al., 2019). In this sense, as mentioned before, the choice of performing the modelling phase by using a free form modeller as Rhinoceros has been taken for the purpose of getting high LOD (500) after the conversion from NURBS to parametric models (Banfi et al., 2017).

However, the limitations of international normative regarding BIM modelling classification as regards especially Cultural Heritage assets, as well as the poor flexibility of HBIM protocols (modelling and data analysis), have recently led the researchers (Banfi F., 2016 and 2017) to introduce new classification systems for the purpose of defining how the model has been modelled and of course the quality of this kind of procedure: indeed, the proposal of Banfi F. (2017) is to introduce a classification regarding the model generation, especially as far as NURBS modelling is concerned. In fact, the here presented methodological process named “scan-to-BIM” (the workflow concerning steps from the LiDAR data to its implementation on BIM platform) requires different levels of detail and generation, especially because current predefined IFC architectural families and libraries do not include complex architectural elements concerning Cultural Heritage assets. (Banfi F., 2016).

In this sense, this classification system has been selected for this project in order to evaluate the model creation phase instead of LOD classification, because of this latter does not fit in a proper way with the modelling method used for this project. So, the current modelling step has been evaluated by using the **Grade Of**

---

<sup>29</sup> For further details see UNI 11337-4 2017 visiting <http://www.uni.com/>

**Generation** classification (Banfi F., 2017) that evaluate the 3D modelling tools and techniques and their computation detail by establishing a 10 points list of modelling accuracy: the EXTRUSION process is referred to the Grade Of Generation 1 (GOG1), while scrolling through the list more complexity of modelling is described by other commands tools, such as SWEEP, LOFT, REVOLVE. Finally, the main complexes GOGs are 9 and 10 which are related to the NURBS surface creation on a wired profile (such as a cross or planar sections from reality-based model or a custom spar wireframe that reproduces geometric primitives) or directly on the point clouds derived from LiDAR data. Of course, this last one results the more accurate method of modelling NURBS surfaces starting from existing building data, because NURBS surface (also depending on U and V subdivision during the creation phase) can fit and interpolate its course on a dense or sparse cloud, reconstructing accurately the plane or surface. This methodological approach is fundamental nowadays, especially for the purpose of adapting the modelling action to the real objects and not the opposite (Diara et al., 2019).

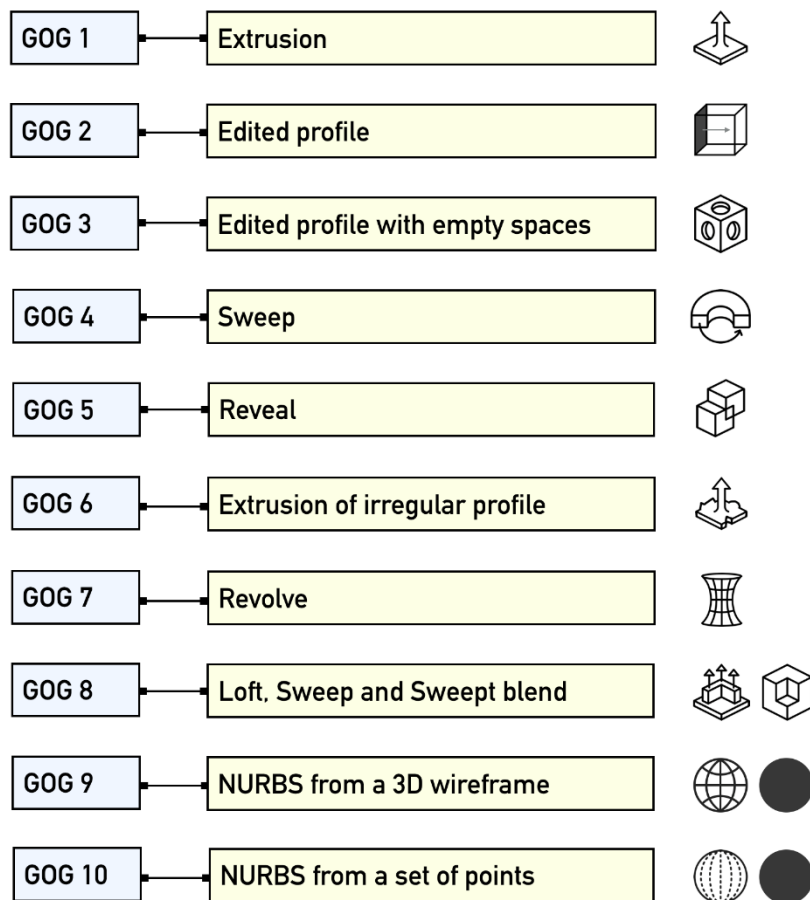

Figure 171. Schematic classification of Grades of Generation (original schema in Banfi F., 2017)

In this regards, architectural elements of the refectory, and then the whole 3D NURB model, have been reproduced and modelled performing principally by creating a spar profile of geometric primitives and then modelling surfaces directly on the wired profile by using the best fitting modelling tools included inside Rhinoceros: LOFT, SWEEP, PATCH. The extrusion tool has been used just for a few architectural elements, also for the purpose of having a volumetric detail of them. From the methodological point of view the 3D modelling phase here presented could be placed between the **Grade Of Generation 8 and 9**, especially for the wide utilization of different command tools according to the peculiarities of simple (such as ground, pillars) and complexes (vaults, single-lancet windows) architectural elements

#### **9.4.3 Grade Of Accuracy of vaulted ceiling**

According to the classification system introduced by Banfi F. (2017) the **Grade Of Accuracy** has been defined in order to evaluate the accuracy level of NURBS modelling in comparison with the reality-based model or the LiDAR point cloud data. Then, this kind of analysis is based on the standard deviation between LiDAR data and the model, in other words it defines how the created model is metrically accurate (metric precision) towards the real object. Of course, this parameter is affected also by the accuracy of the metric survey and the point cloud alignment (Banfi F., 2017; Macher et al., 2019). In this sense, as mentioned on the *Data processing and management* chapter, the internal scan alignment (as concern the vaulted ceiling acquisition) has been performed and managed in order to obtain an average target error distance of 4.71 mm.

This analysis, due to the complexity of the entire NURBS model and LiDAR point cloud, has been performed for the purpose of investigating the accuracy of the vaulted ceiling modelling operations. As mentioned before, starting from planar sections, the simplified wired profile concerning the vaulted ceiling has been reconstructed by using NURBS curves and poly-curves, interpreting and simplifying the shape of the ideal wooden centring. Then, shapes and vaults have been modelled with PATCH by managing U and V subdivisions to high density parameters 90.

For the purpose of comparing metric differences of models, the NURBS model has been converted into a high polygonal mesh inside the Rhinoceros environment, by using the highest options for creating polygons. In this way, the polygonal model of the vaulted ceiling has been imported as STL file in the open source software

CloudCompare<sup>30</sup> as well as the cleaned point clouds of the vaults. As mentioned on the chapters 5 and 6, two blocks of the refectory don't have the radiometric information due to different issues during the survey, and of course this affected also the upper part of the cloud concerning the vaults. For this reason, the entire point clouds of the vaulted system show two blocks without radiometric information.

Once inside CloudCompare software, the cleaned point clouds and the polygonal mesh created from the NURBS surfaces have been compared and analysed for the purpose of understanding metric differences among them through the *Cloud / Mesh Distance* command and the extraction of the **Standard Deviation** optioning the Gaussian distribution of distances. The standard deviation, that defines the average distance between point clouds and the model, resulted in around 7.8 cm. This result, a not desired but anyway comfortable, has to be evaluated related to different factors: first of all the metric precision of the survey and then of the point clouds; the adopted method of modelling and then the Grade Of Generation (between GOG 8 and 9), because NURBS surfaces have been modelled on wired profile from planar sections and by contrast the interpolation of them directly on sparse or dense point clouds of course would have produced a smaller deviation, probably around 5mm – 8mm.

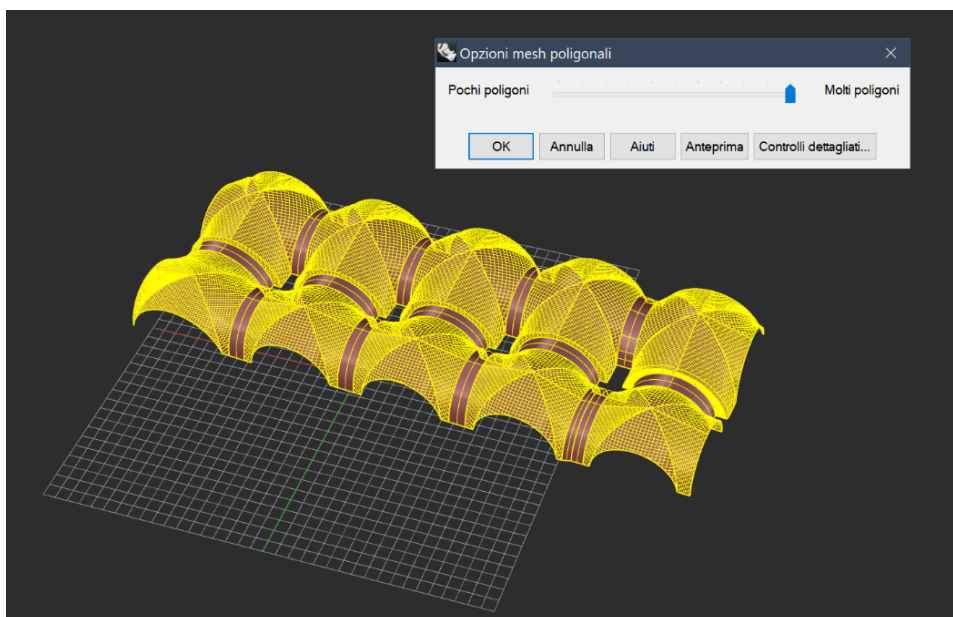

Figure 172. Polygonal mesh creation starting from NURBS model of the vaults (elaboration F. Diara).

---

<sup>30</sup> [www.danielgm.net/cc/](http://www.danielgm.net/cc/)

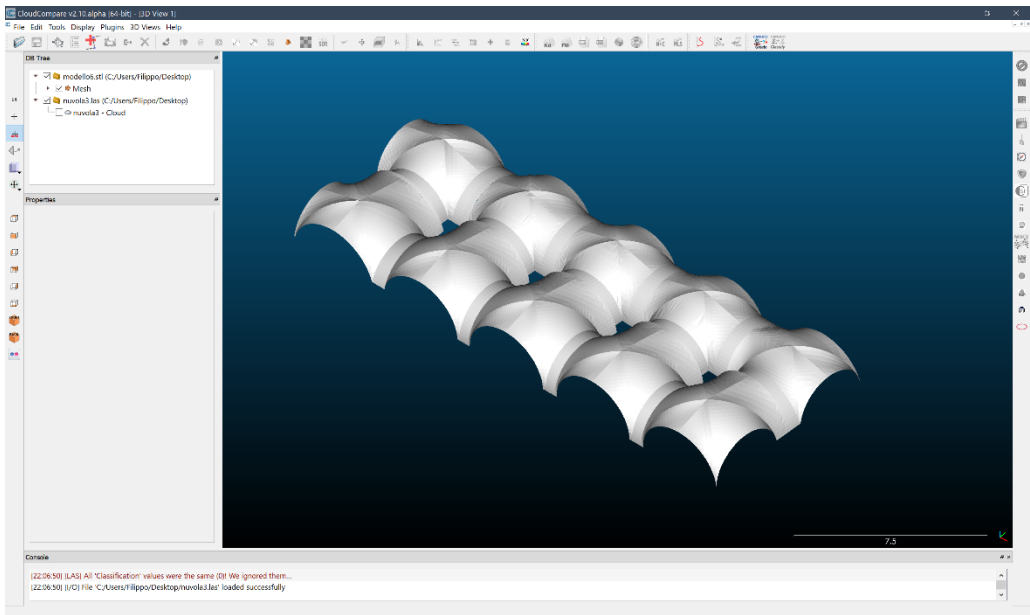

Figure 173. Polygonal mesh inside CloudCompare software (elaboration F. Diara).

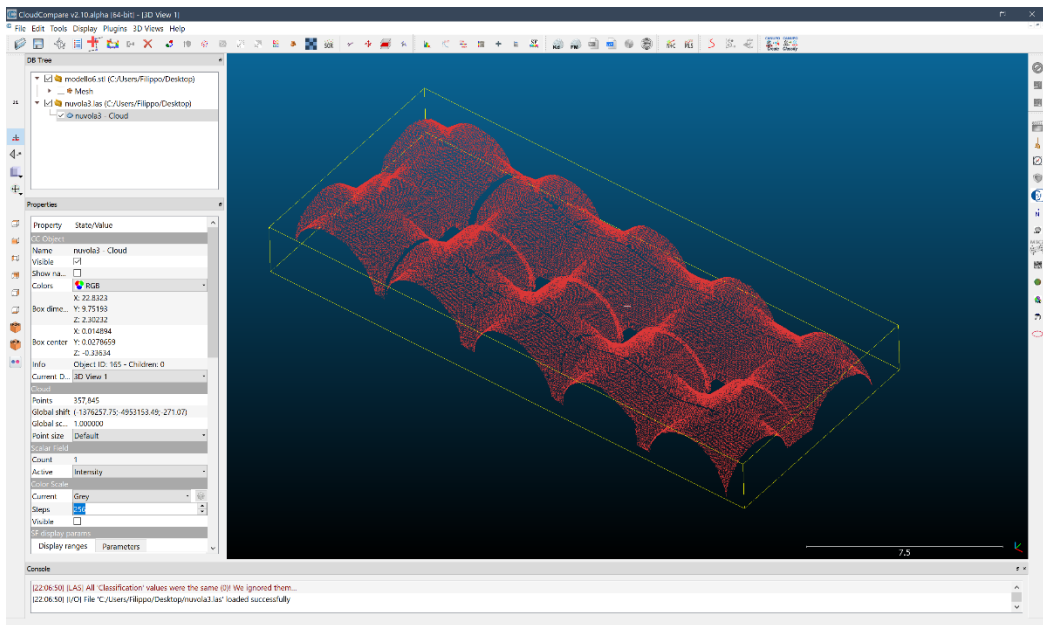

Figure 174. Sparse LiDAR point clouds of the vaults inside CloudCompare (elaboration F. Diara).

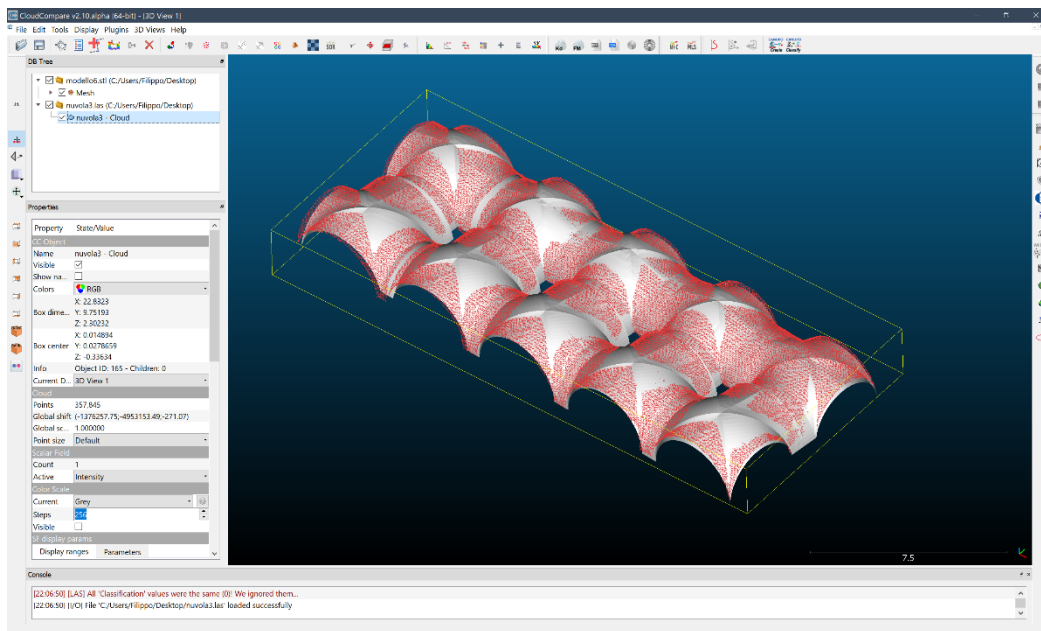

Figure 175. Polygonal mesh and LiDAR point clouds overlapped in order to compare distances (elaboration F. Diara).

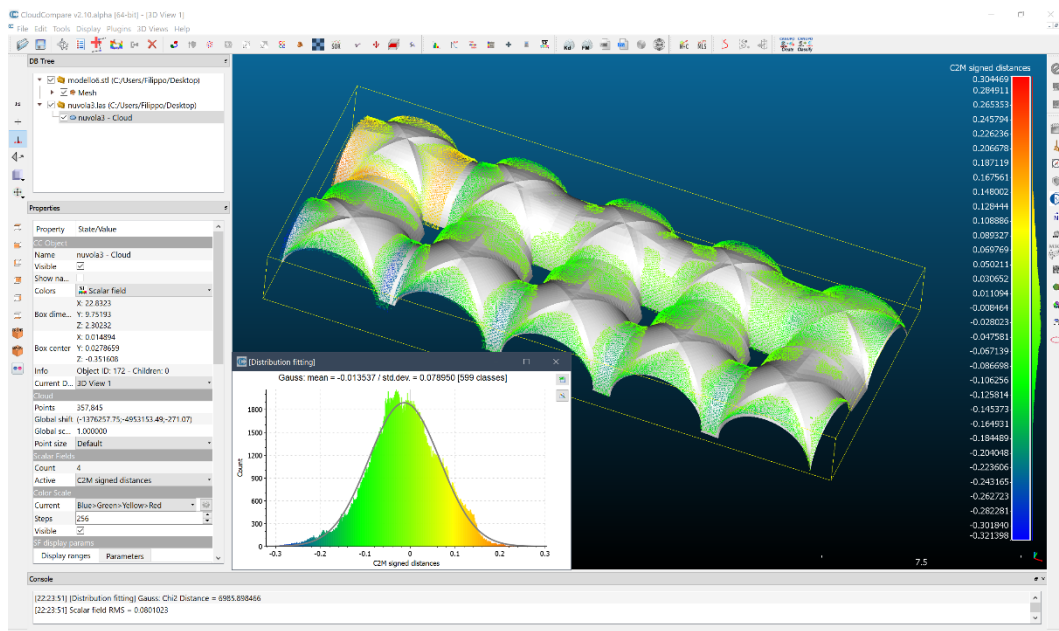

Figure 176. Distances (the higher and the smaller) between the model and the point cloud (elaboration F. Diara)



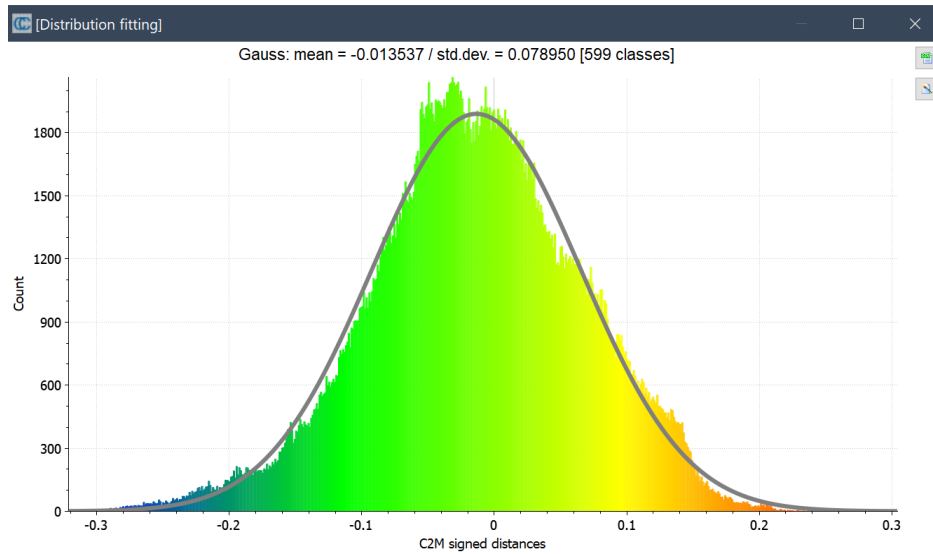

Figure 177. Graphic of standard deviation computed (7.8 cm) between point clouds and the model (elaboration F. Diara).

Concluding, the here conducted Grade Of Accuracy analyses, based on the standard deviation measurements, have been carried out by performing comparison between NURBS model of vault and LiDAR point clouds, then between surfaces (modelled surface and pointed surface). In this sense, this comparison between LiDAR data and the next parametric model generated with FreeCAD software couldn't be conducted because the parametric model of the vaults contain depth, thickness values and then the entire volume of these architectural entities, unlike the LiDAR point clouds.

## 9.5 Stratigraphic units mapping and modelling

By using Rhinoceros software, orthophotos have been imported and mapped on the NURBS model of the refectory. For this purpose, the orthophoto related to the south front of the cloister (refectory side) has been managed and cropped (depending on right internal and external edges) in order to obtain a fitting picture concerning just the external wall of the refectory, setting aside the other parts and units not directly related to the refectory area.

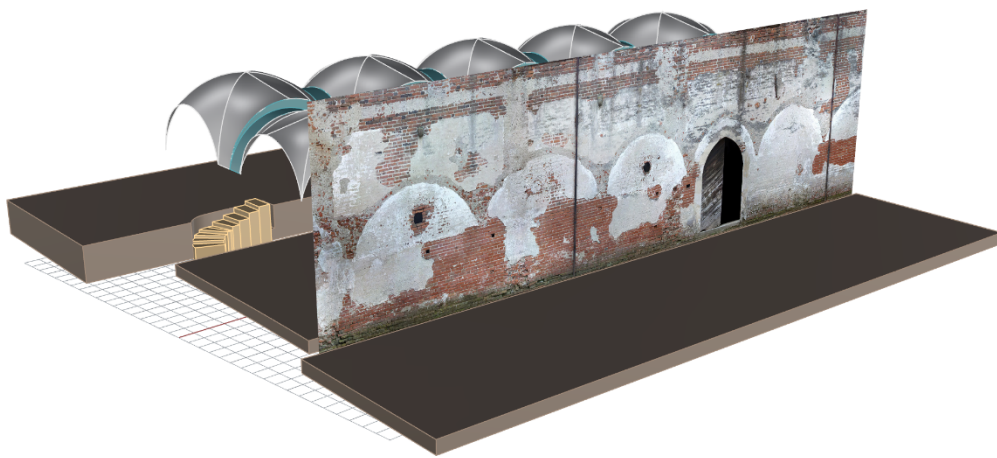

Figure 178. Cropped orthophoto of the south front of the cloister referred to the refectory area and mapped on the model (elaboration F. Diara).

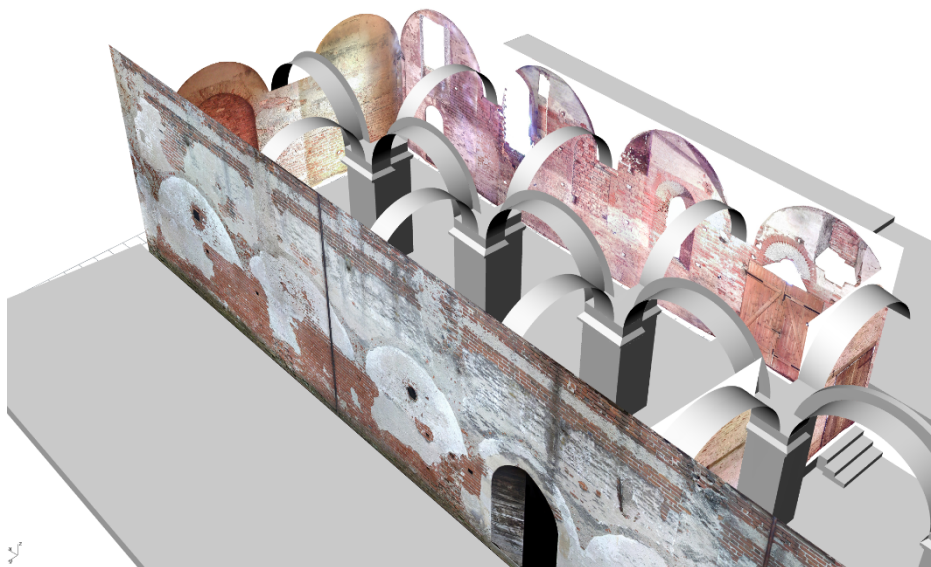

Figure 179. Detail of external and internal orthophoto mapped on the model (elaboration F. Diara).

Going deeper, starting from the imported orthophotos, which have been mapped on right positions by keeping the right coordinates system on XYZ planes, profiles of stratigraphic units have been drawn by using NURBS curves and poly-curves, obtaining a three-dimensional profile concerning the profile of the units.

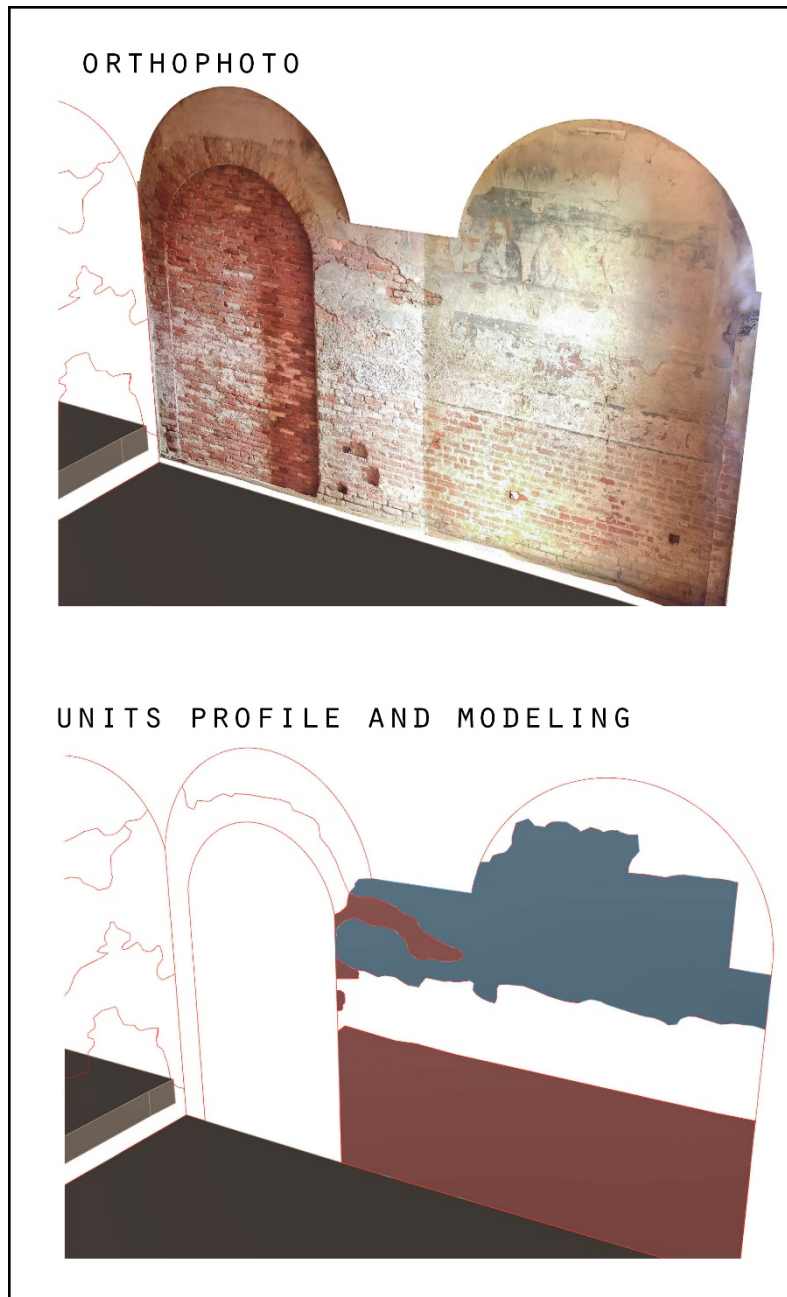

Figure 180. Drawing and modelling steps starting from the mapped orthophoto (elaboration F. Diara).

However, drawing the edges of stratigraphic units different drawback came up, for example concerning the lower part of north and south orthophoto fronts due to the approximation and simplification of the modelled ground (performed by best fit plane). This issue has been solved by approximating the general height of the lower stratigraphic units edges.

Defined the spline profile of each stratigraphic units, the modelling was performed by acting like the architectural elements modelling described before: NURBS surfaces have been created by using PATCH tool and editing U and V subdivisions from 30 to 60 (referred to the density of curves inside the surface), depending on the dimension of the units profile.

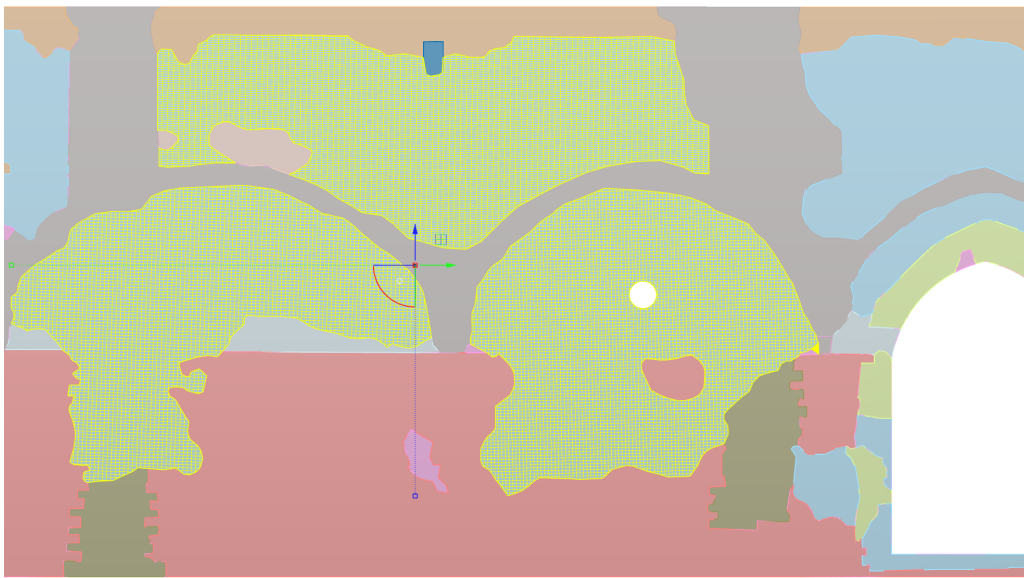

Figure 181. Detail of subdivisions on unit surface modelled using PATCH tool (elaboration F. Diara).

In this way, the complete mapping and modelling of stratigraphic units has been performed and managed starting from orthophotos and the NURBS model.

The final NURBS model of the refectory including the stratigraphic units mapped shows a high density of shapes as well as the level of complexity. Like the architectural elements modelled and described in previous paragraphs, the surfaces related to stratigraphic units cannot become BIM models due to the lack of thickness and volumetric parameters. Moreover, stratigraphic units surfaces have been exported by using STEP file format and then imported into the FreeCAD platform in order to be managed and parametrized.

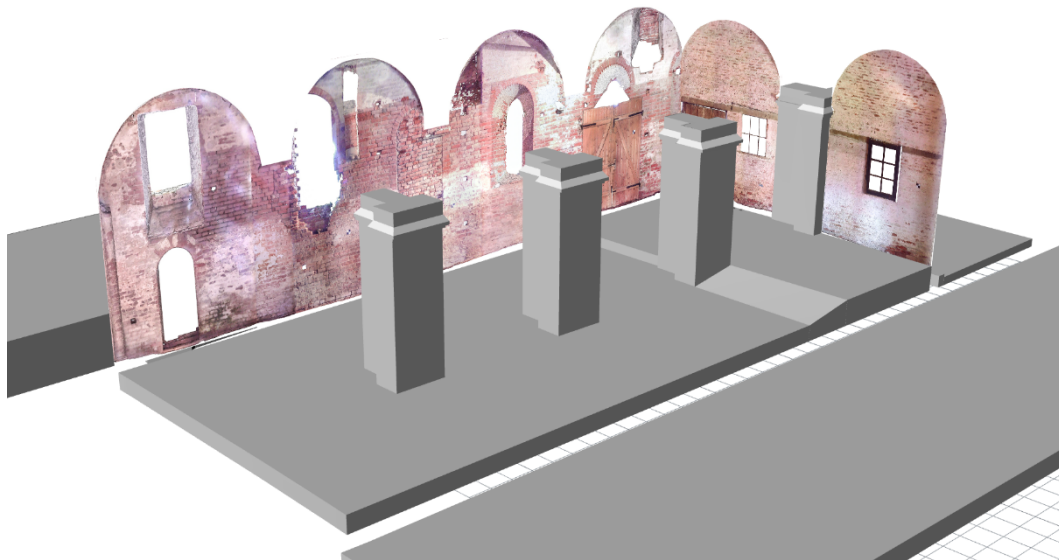

Figure 182. Mapped orthophotos related to the south and west fronts of the refectory (elaboration F. Diara).

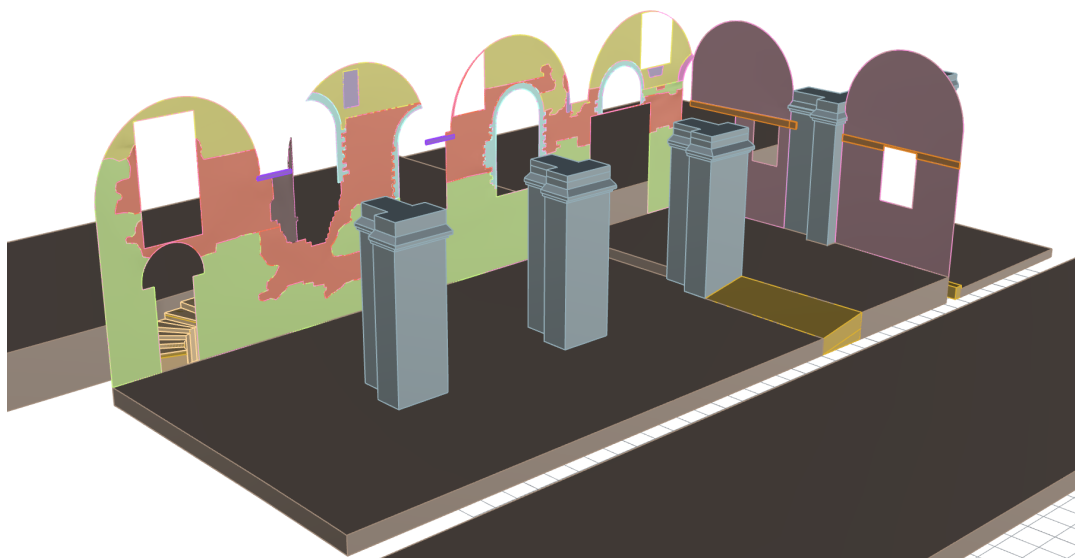

Figure 183. Modelled stratigraphic units related to the south and west fronts of the refectory (elaboration F. Diara).

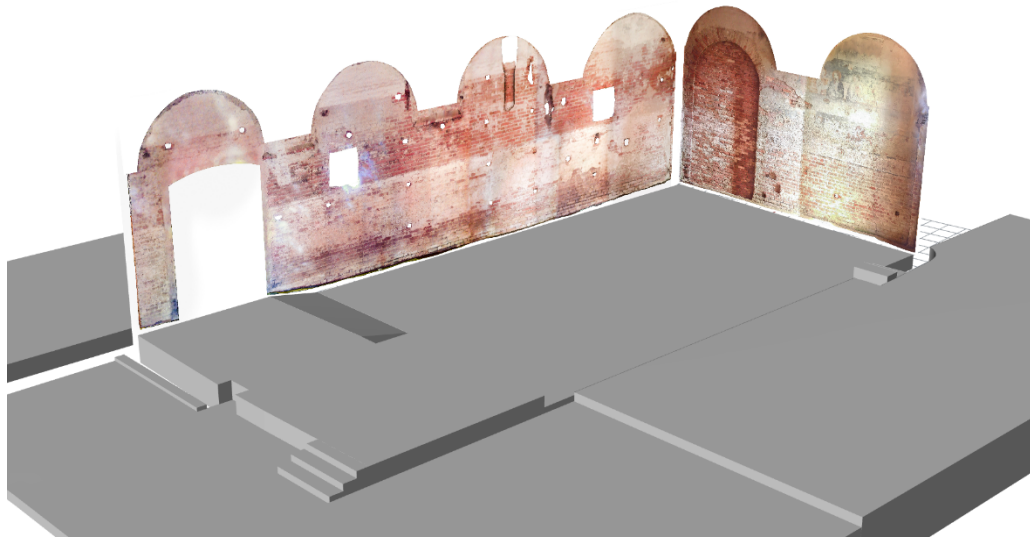

Figure 184. Mapped orthophotos related to the north and east fronts of the refectory (elaboration F. Diara).

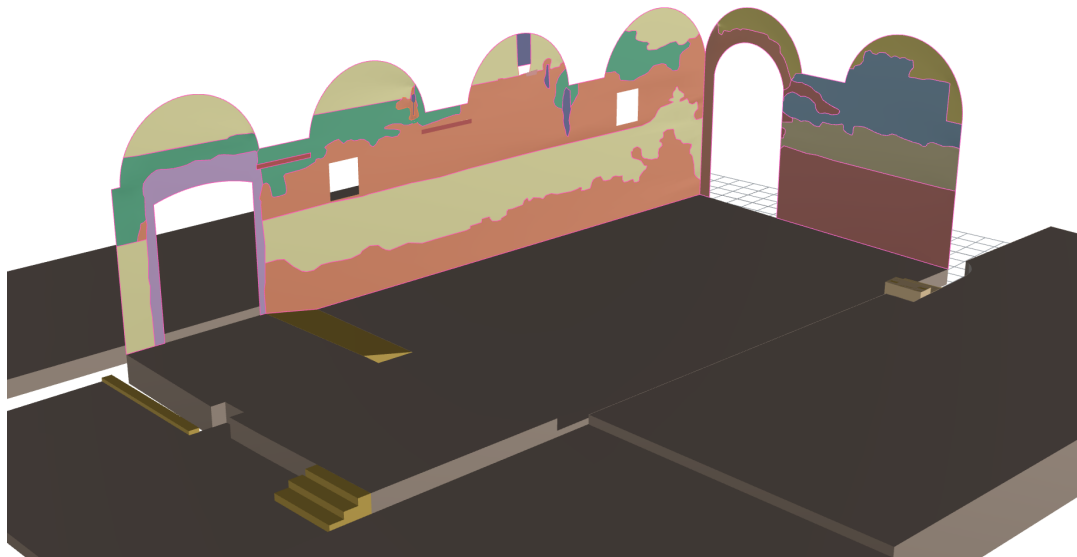

Figure 185. Modelled stratigraphic units related to the north and east fronts of the refectory (elaboration F. Diara).

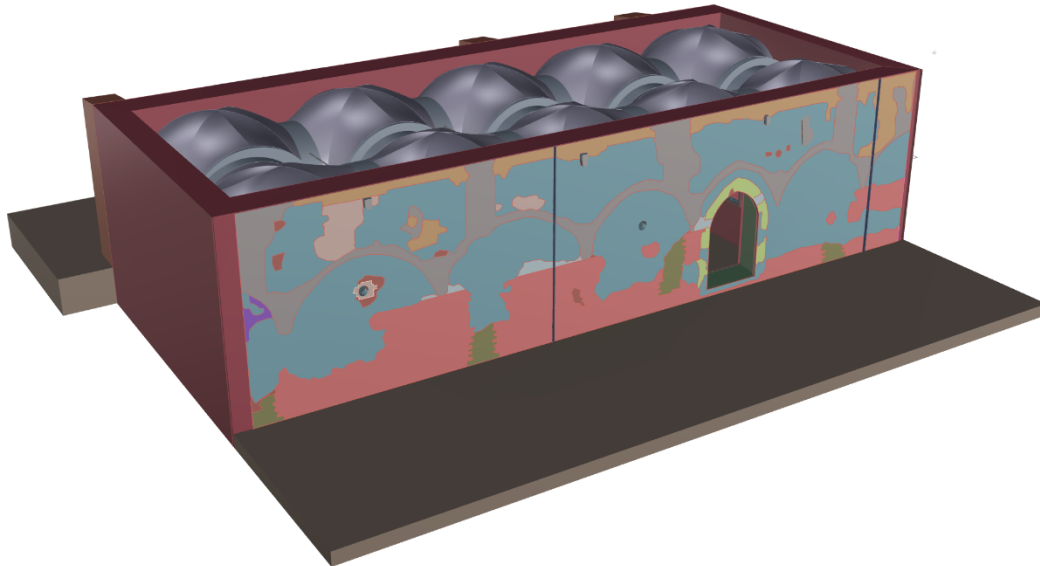

Figure 186. Complete NURBS model of the refectory including stratigraphic units – 1 (external units detail) - (elaboration F. Diara).

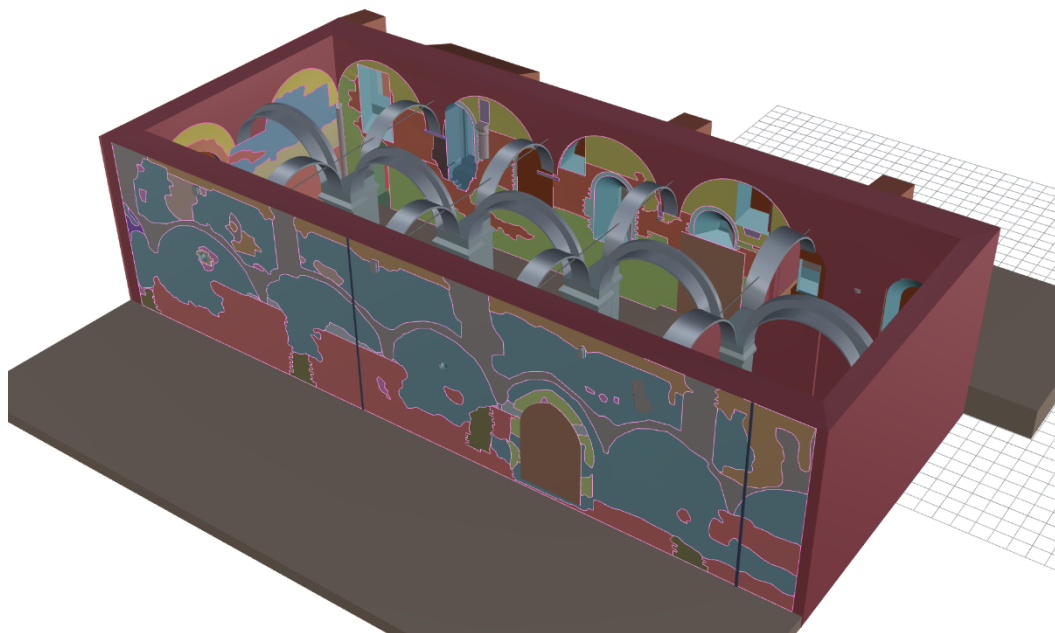

Figure 187. Complete NURBS model of the refectory including stratigraphic units – 2 (internal and external units detail) - (elaboration F. Diara).

After this mapping and modelling phase, the NURBS model resulted complete in all its architectural and stratigraphic peculiarities. Indeed, despite the refectory has been modelled following its architectural and structural elements, layers concerning stratigraphic units have been included (as the main purpose of this project) in order to obtain an exhaustive vision of the actual refectory.

Then, the entire NURBS model was also enriched by photographic textures. This step was carried out especially for the purpose of reaching a high photographic detail concerning stratigraphic units as well as architectural elements for a better communication of the final NURBS model, even if the texture information wasn't implemented inside the forthcoming HBIM model, because the HBIM model of the refectory was designed and managed as a conceptual and ideal operative model, with the photographic attached picture inside the platform (as we will see), following the original BIM thought.

Going deeper, textures were extracted from rectified orthophotos and from detailed photographs taken during the stratigraphic survey, and were applied to each NURBS surface of the model. Moreover, textures concerning plane whole plasters were selected from the default texture database inside Rhinoceros software. Acting in this way, a complete photographic restitution of the refectory has been possible. Then, the texturized NURBS model concerning the actual refectory has been compared with the hypothetical reconstruction of the first architectural phase of the building, as we will see in the following paragraphs.



Figure 188. Texturized rendered NURBS model of the refectory. South front of the cloister, detail on stratigraphic units (elaboration F. Diara).



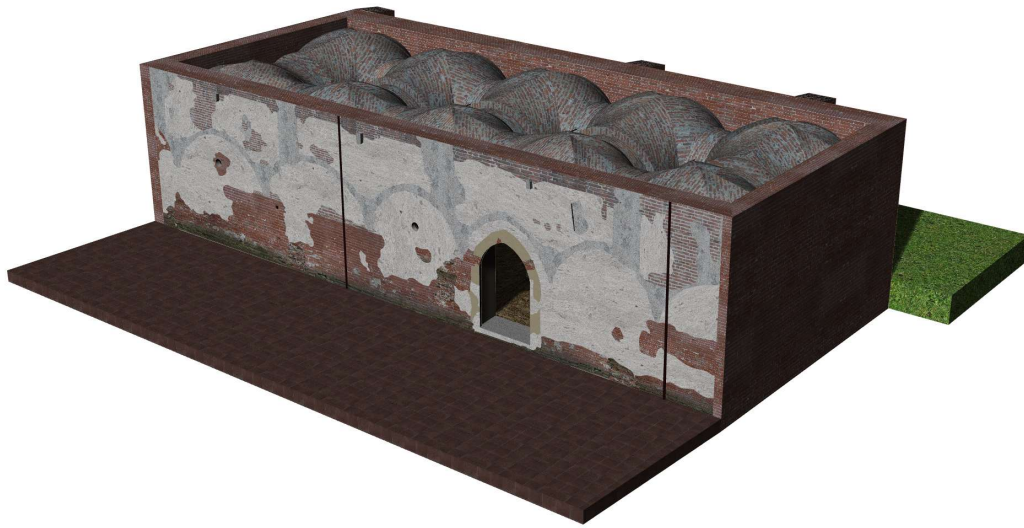

Figure 189. Texturized rendered NURBS model of the refectory including stratigraphic units (cloister side) - (elaboration F. Diara).

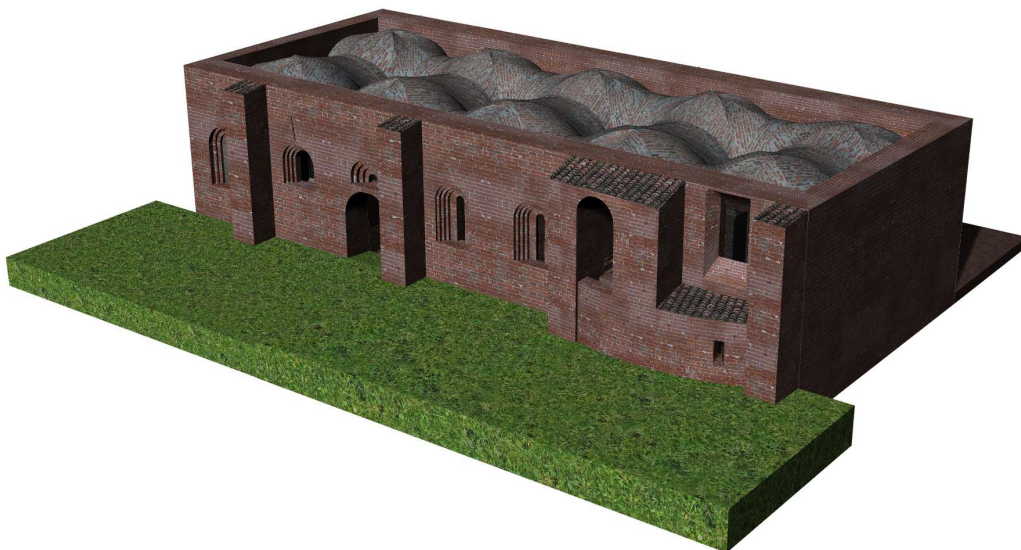

Figure 190. Texturized rendered NURBS model of the refectory including stratigraphic units (backyard side) - (elaboration F. Diara).

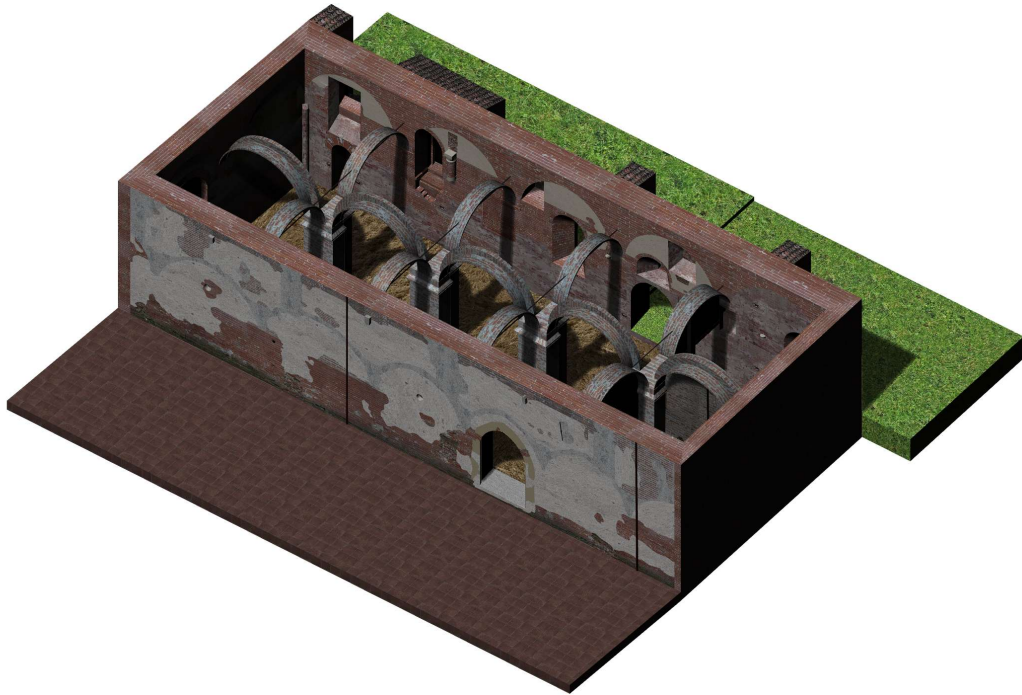

Figure 191. Texturized rendered NURBS model of the refectory. Internal detail with pillars and arches (cloister side) - (elaboration F. Diara).

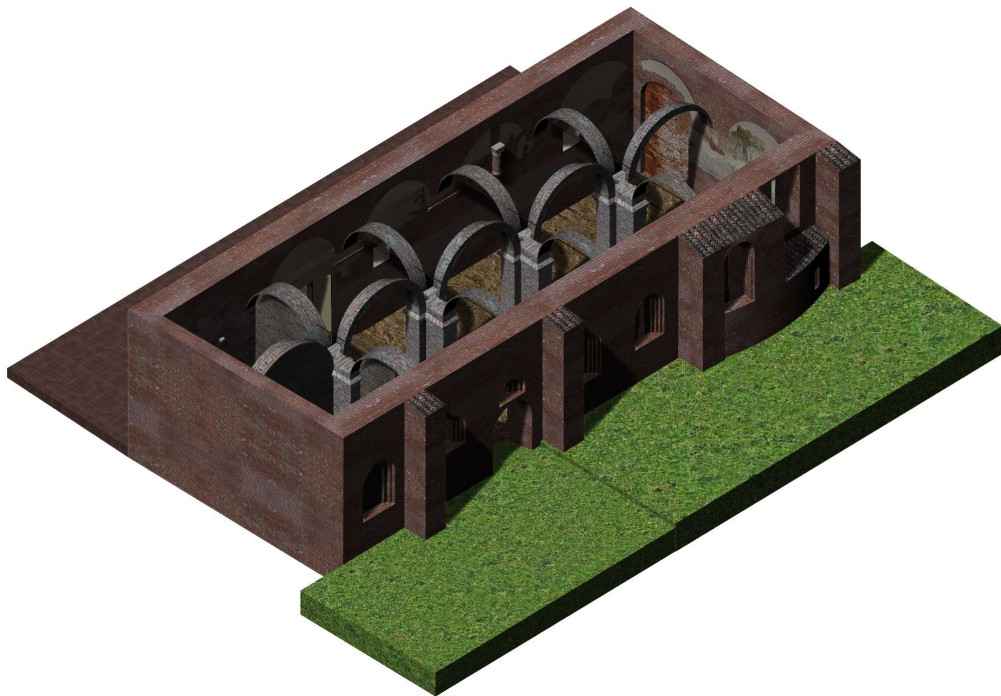

Figure 192. Texturized rendered NURBS model of the refectory. Internal detail with pillars and arches (backyard side) - (elaboration F. Diara).

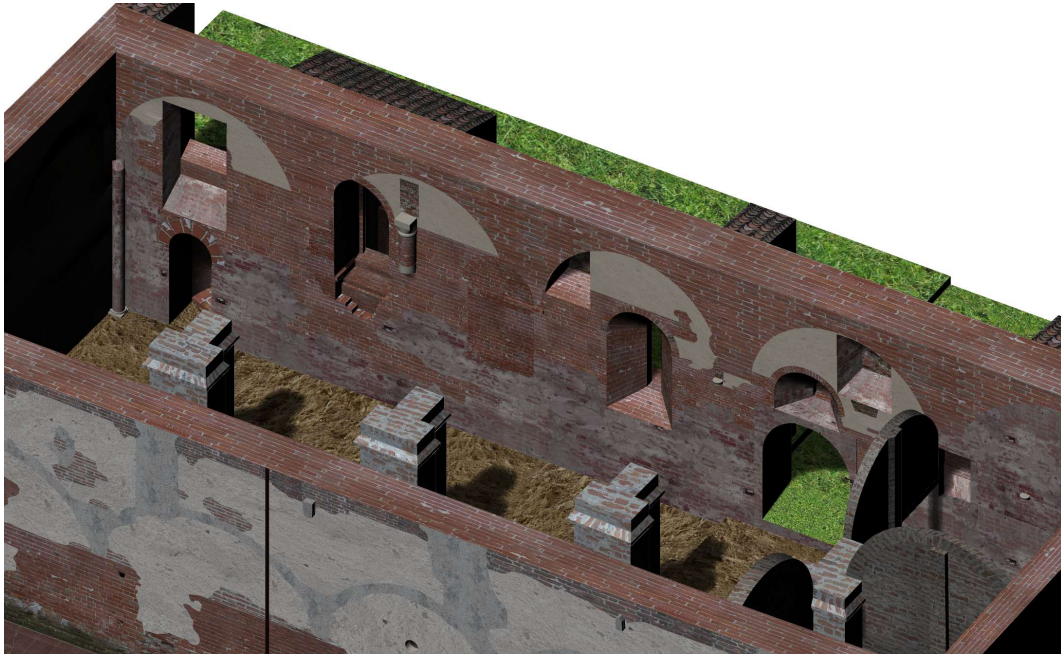

Figure 193. Texturized rendered NURBS model of the refectory. Internal detail of the south wall (isometric view) - (elaboration F. Diara).



Figure 194. Texturized rendered NURBS model of the refectory. Internal detail of the north wall (isometric view) - (elaboration F. Diara).



Figure 195. Texturized rendered NURBS model of the refectory. Internal detail of the east wall and arches (isometric view) - (elaboration F. Diara).



Figure 196. Texturized rendered NURBS model of the refectory. Internal detail of the east wall and *Ultima Cena* fresco detail (elaboration F. Diara).

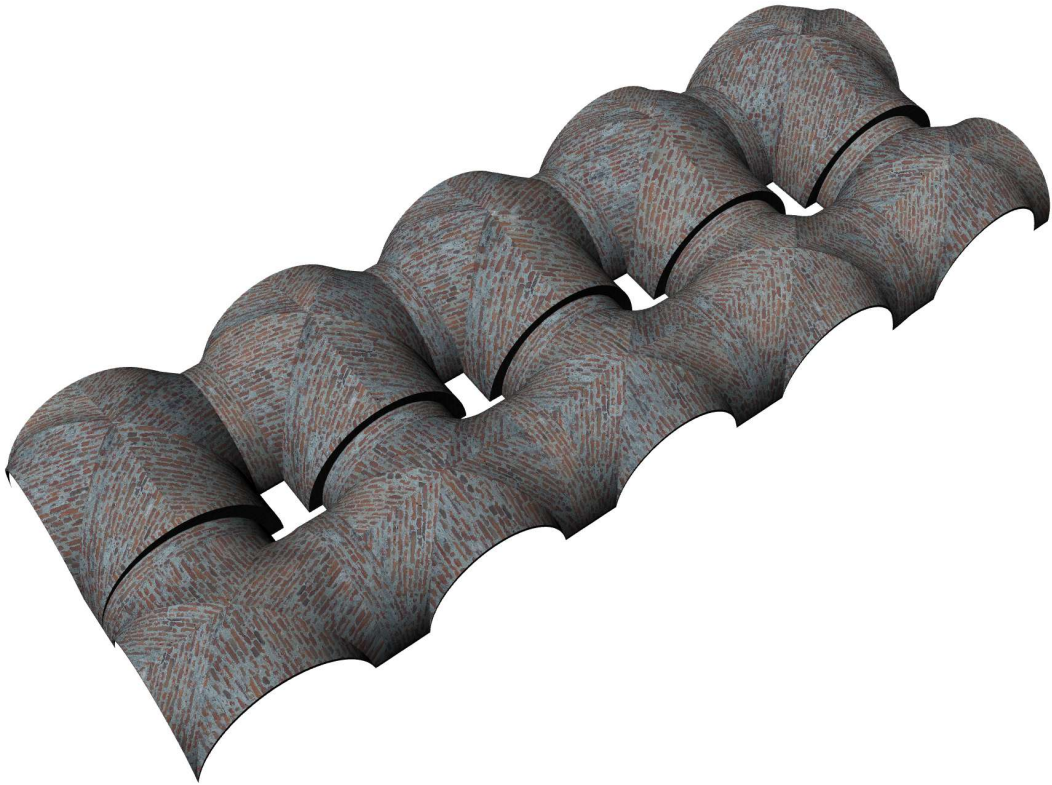

Figure 197. Texturized rendered NURBS model of the vaulted system of the refectory (elaboration F. Diara).

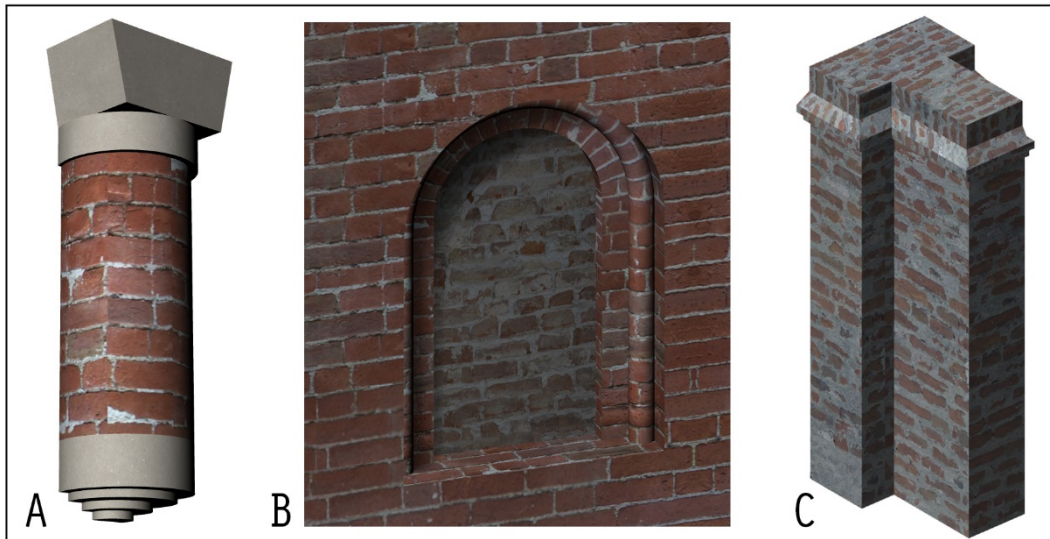

Figure 198. Texturized rendered NURBS models of architectural elements: A) semi-column of the north wall; B) walled single-lancet window; C) Pillar of the new vaulted system (elaboration F. Diara).

## **9.6 Analysis and hypothetical reconstruction of the refectory**

After the NURBS modelling phase, inside Rhinoceros software have been performed different analyses on modelled architectural elements in order to better understand and support the historical evolution initially performed through the stratigraphic analysis and related diagrams (Matrix). Indeed, the interpretation phase of the refectory, approached and analysed on the previous chapter, needed to be validate graphically and in a three-dimensional way by managing dynamic models related to specific architectural elements.

In addition to analyse and verify the historical evolution of the refectory, the great potential of NURBS modelling of Rhinoceros software has been used in order to reconstruct the hypothetical first chronological phase of the refectory argued by performing stratigraphic diagrams and their phases and periods clustering. In this sense, has been performed a graphical comparison between the actual refectory and the hypothetical one, based on stratigraphic analysis and interpretation.

### **9.6.1 Analysis on old ceiling supporting elements**

The performed analysis of the NURBS models was focused on the old ceiling supporting elements, related to buttresses semi-column, cornering column and shelves / brackets. Going deeper, this analysis was based on the remaining buttresses (backyard side) and buttresses evidences (cloister side) correspondence, and whether and how these elements can be compared with the ceiling supporting elements inside the refectory, in order to better understand the original ceiling.

Starting from buttresses marks (stratigraphic evidences) on the south front of the cloister can be argued the edges of the removed buttresses (happened, as we have seen, after 1690); these marks correspond exactly (on axis) with the remaining buttresses placed on the other side, on the backyard side of the refectory. For this reason, four buttresses have been modelled on these stratigraphic evidences on the south front of the cloister, in order to figure out the right match.

Furthermore, the stratigraphic evidences on the south front of the cloister and the remaining buttresses on the backyard are on axis with the semi-columns and shelves / brackets related to the supporting elements inside the refectory. In this sense buttresses played a fundamental role for the purpose of draining the ceiling weight through the supporting internal elements.

Then, this brief correspondences analysis of the NURBS models (that would have resulted harder to perform directly on the field) supported and proved the original ceiling hypothesis: it could be consist of a wooden trussed roof sustained by diaphragm arches leaning on semi-columns and shelves, supported themselves by the buttresses (cloister and backyard side).

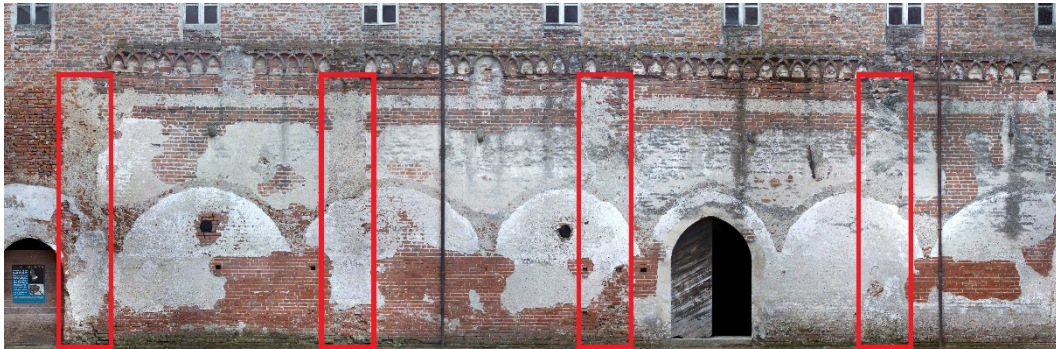

Figure 199. Buttresses evidences on the south front of the cloister related to the refectory area (elaboration F. Diara).

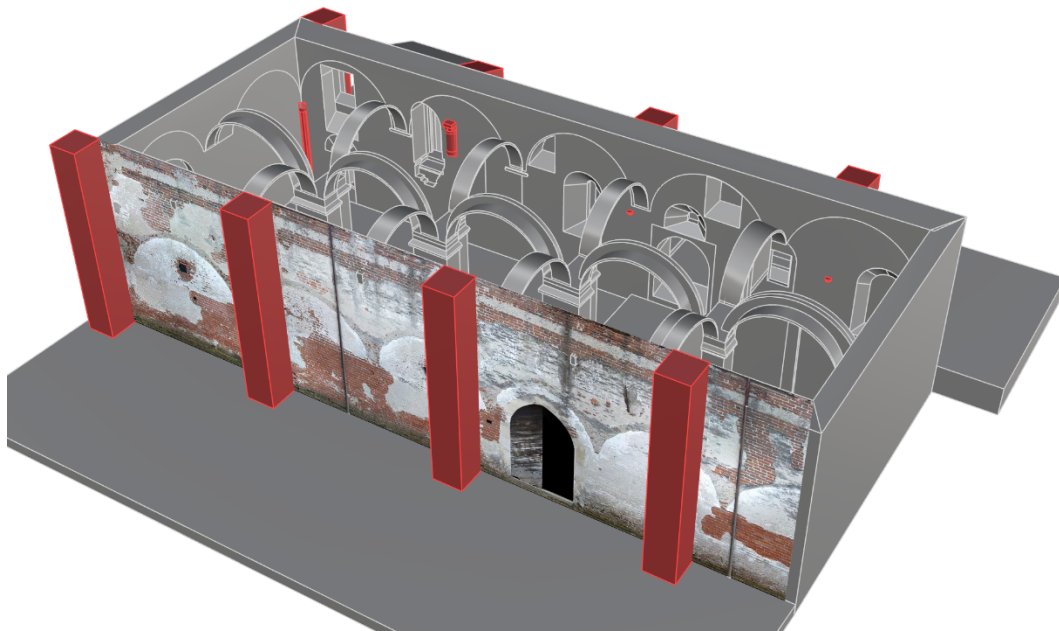

Figure 200. Buttresses reconstruction on the south front of the cloister – NURBS model (elaboration F. Diara).



Figure 201. Buttresses, semi-columns and shelves (in red) related to the original ceiling supporting elements. From this reconstruction can be argued correspondences – NURBS model (elaboration F. Diara).

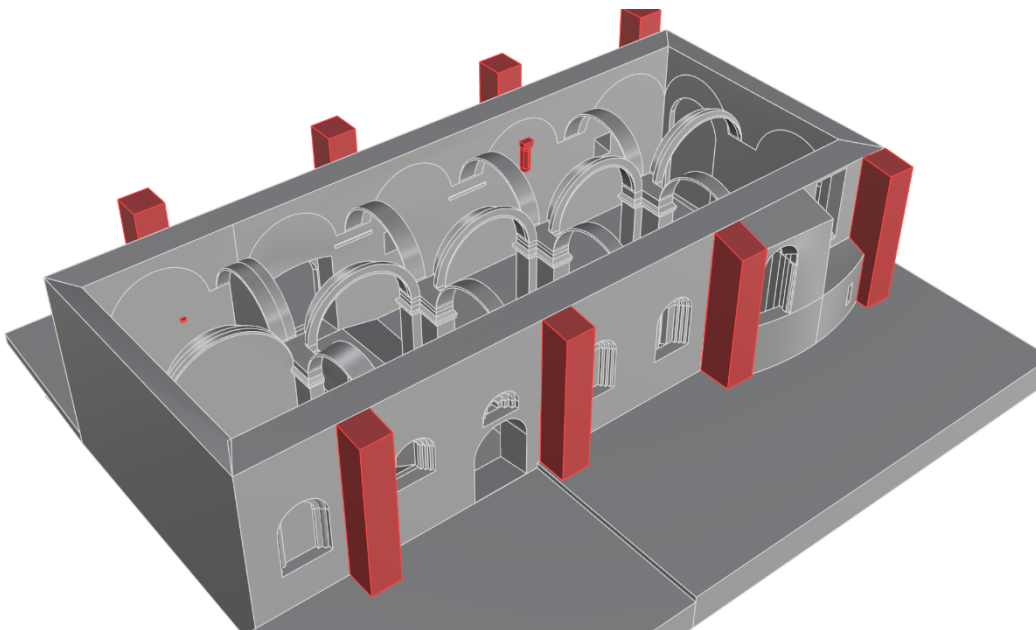

Figure 202. In the foreground buttresses of the backyard and original ceiling supporting element (in red). From this reconstruction can be argued correspondences – NURBS model (elaboration F. Diara).



## 9.6.2 Hypothetical reconstruction of the refectory

The hypothetical reconstruction of the refectory was based on the previous analyses on stratigraphy and its interpretation through the Matrix analysis. Moreover, it was based on the iconographic resource related to the Cesare Bertea drawing as well as on previous analysis on old ceiling supporting elements through the NURBS modelling inside Rhinoceros software.

All these analyses helped the three-dimensional reconstruction of the refectory from the first chronological period detected to 1690, when the refectory and the abbey experienced different morphological changes (especially related to the new vaulted system and the first floor addition). By contrast, from the XVIII century the refectory maintained (in general terms) the actual architectural composition, except for some inner additional and modified elements. Then, through these analyses and resources the hypothetical reconstruction of the refectory was carried out by modelling via NURBS these elements:

- The buttresses on the south front of the cloister
- The suspended arches referred to the original edge of the ceiling
- The original ceiling with a wooden trussed roof sustained by diaphragm arches
- The semi-columns related to the ceiling support
- The original pulpit and the related access stairs
- The original single-lancet windows
- The original inner space

Obviously, the hypothetical reconstruction has been performed by simplifying architectural elements, in order to obtain a conceptual historical reconstruction of the refectory. At the end of the modelling phase, the resulted 3D model has been enriched by adding photographic texture for each architectural element, also texturizing the hypothetical plaster outside and inside the refectory.

As mentioned before, the hypothetical reconstruction of the refectory has been compared with the texturized NURBS model concerning the actual architectural situation of the building, especially for the purpose of comparing graphically the macro changes during the years, creating an ideal timeline concerning the refectory modifications (based on previous analyses).

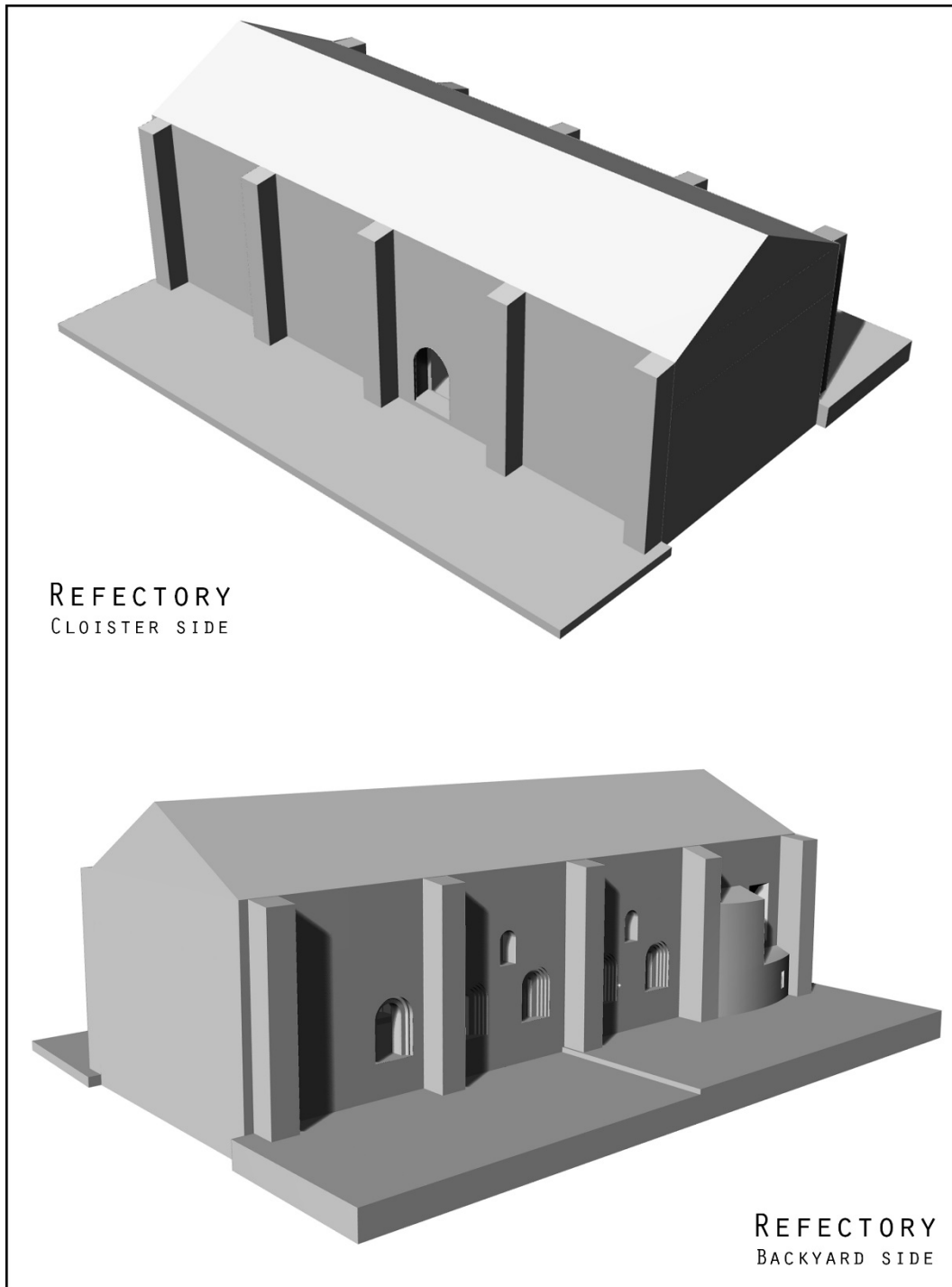

Figure 203. Hypothetical reconstruction of the refectory from 1180 to 1690 (render NURBS model)  
- (elaboration F. Diara).

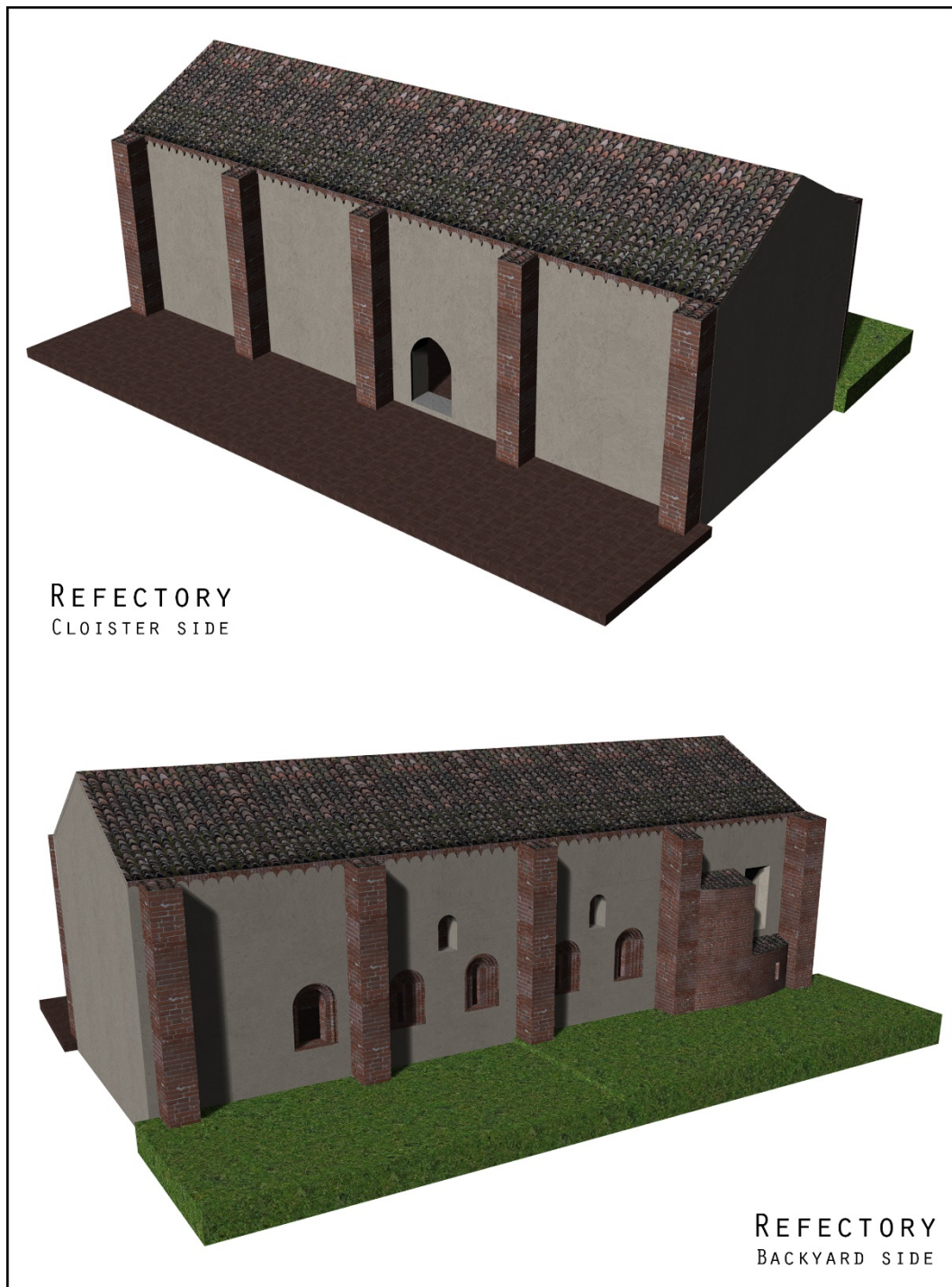

Figure 204. Hypothetical reconstruction of the refectory from 1180 to 1690 (texturized NURBS model) - (elaboration F. Diara).

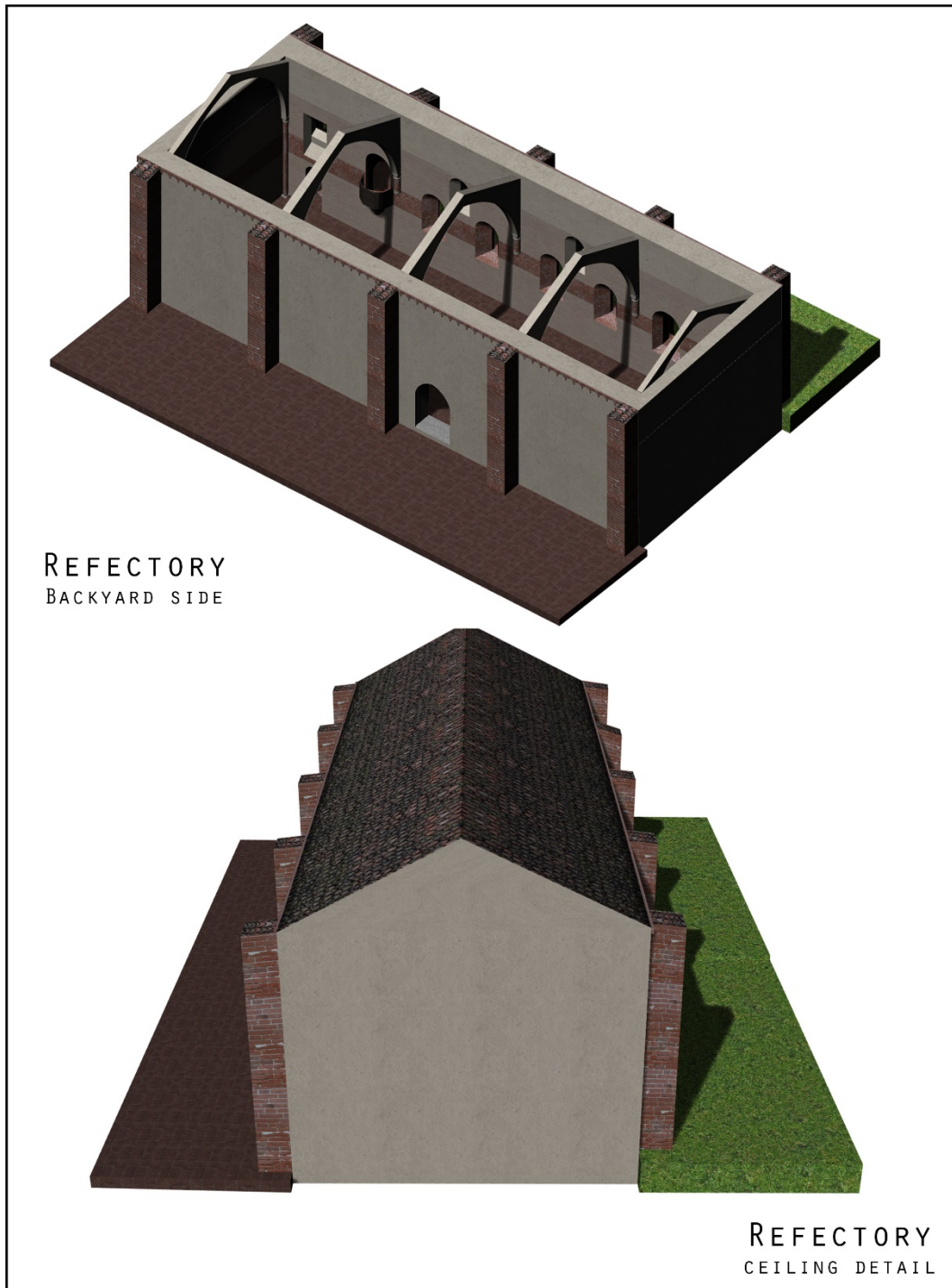

Figure 205. Original ceiling hypothesis details (render NURBS model) - (elaboration F. Diara).

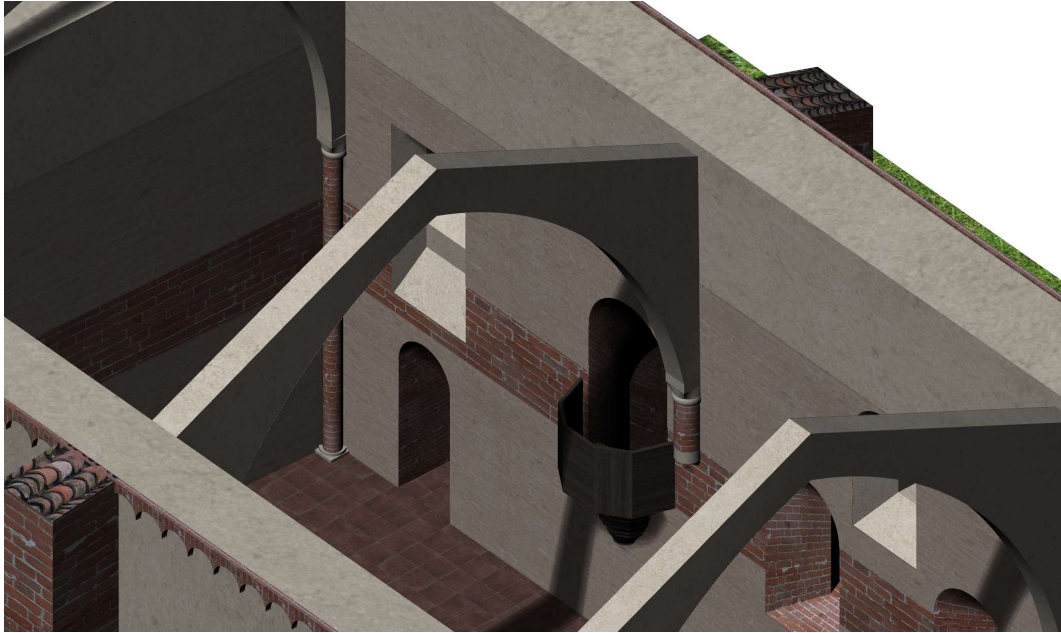

Figure 206. Hypothetical interior reconstruction of the refectory, arches and pulpit detail (rendered NURBS model) - (elaboration F. Diara).

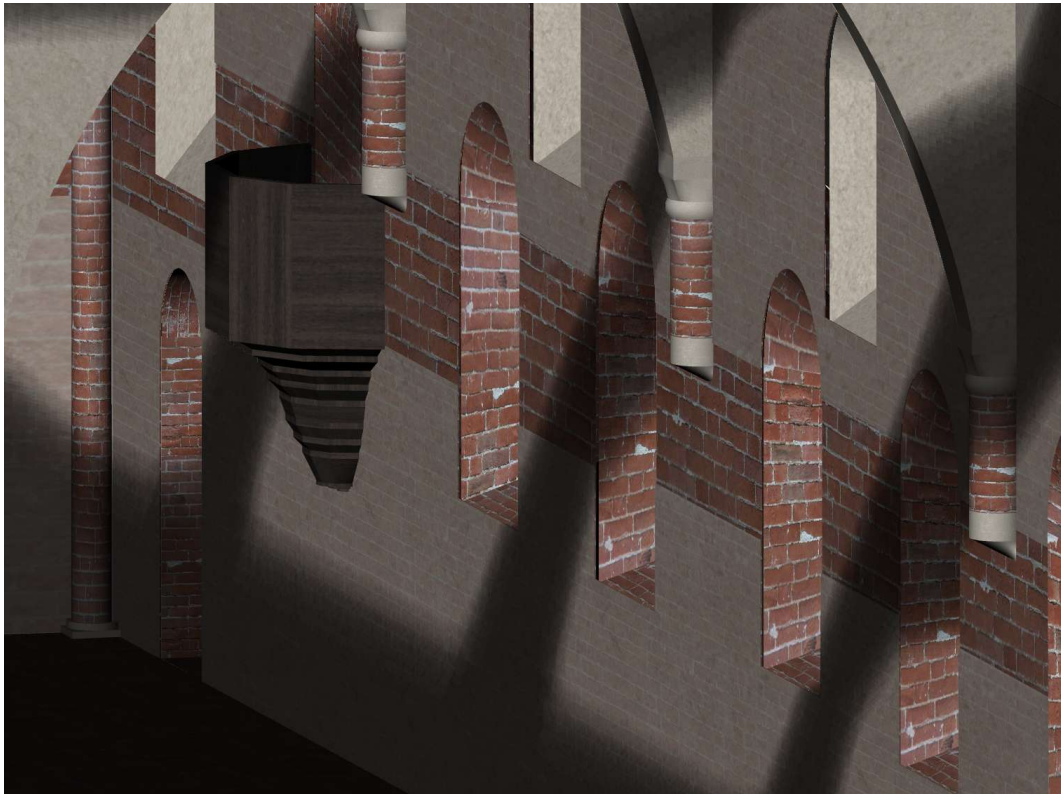

Figure 207. Hypothetical interior reconstruction of the refectory, with the original single-lancet windows and the pulpit (rendered NURBS model) - (elaboration F. Diara).

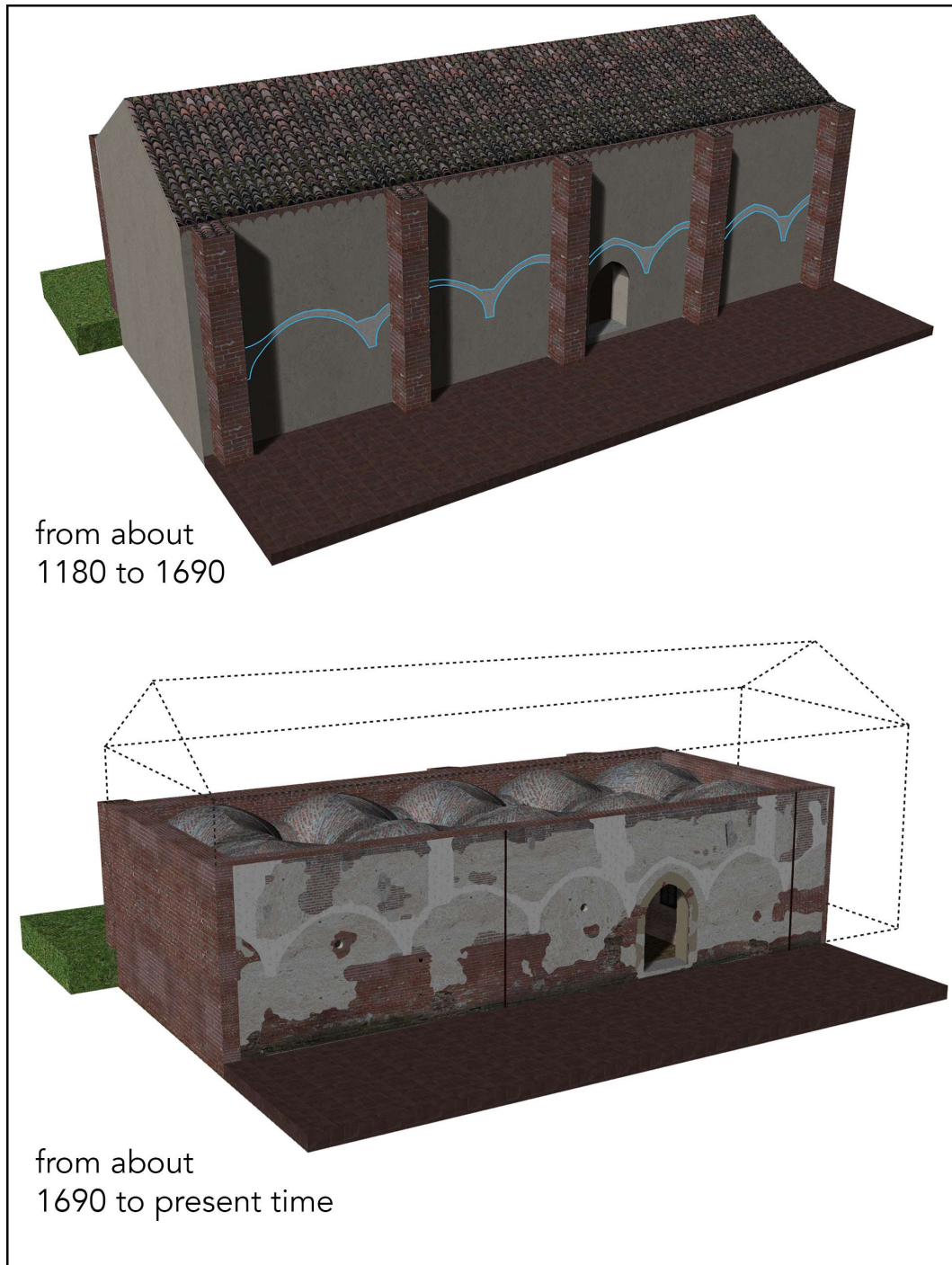

Figure 208. Chronological interpretation and changes of the refectory (cloister side) from about 1180 to present time. The vaulted gallery facing the cloister was certainly built about 1180 and 1220 (as reported in the previous chapter) but removed within 1690 (arches evidences on the model above). The second model below shows how the refectory was transformed and reduced in volume, after structural interventions and the construction of the upper floor since 1690 - (elaboration F. Diara).

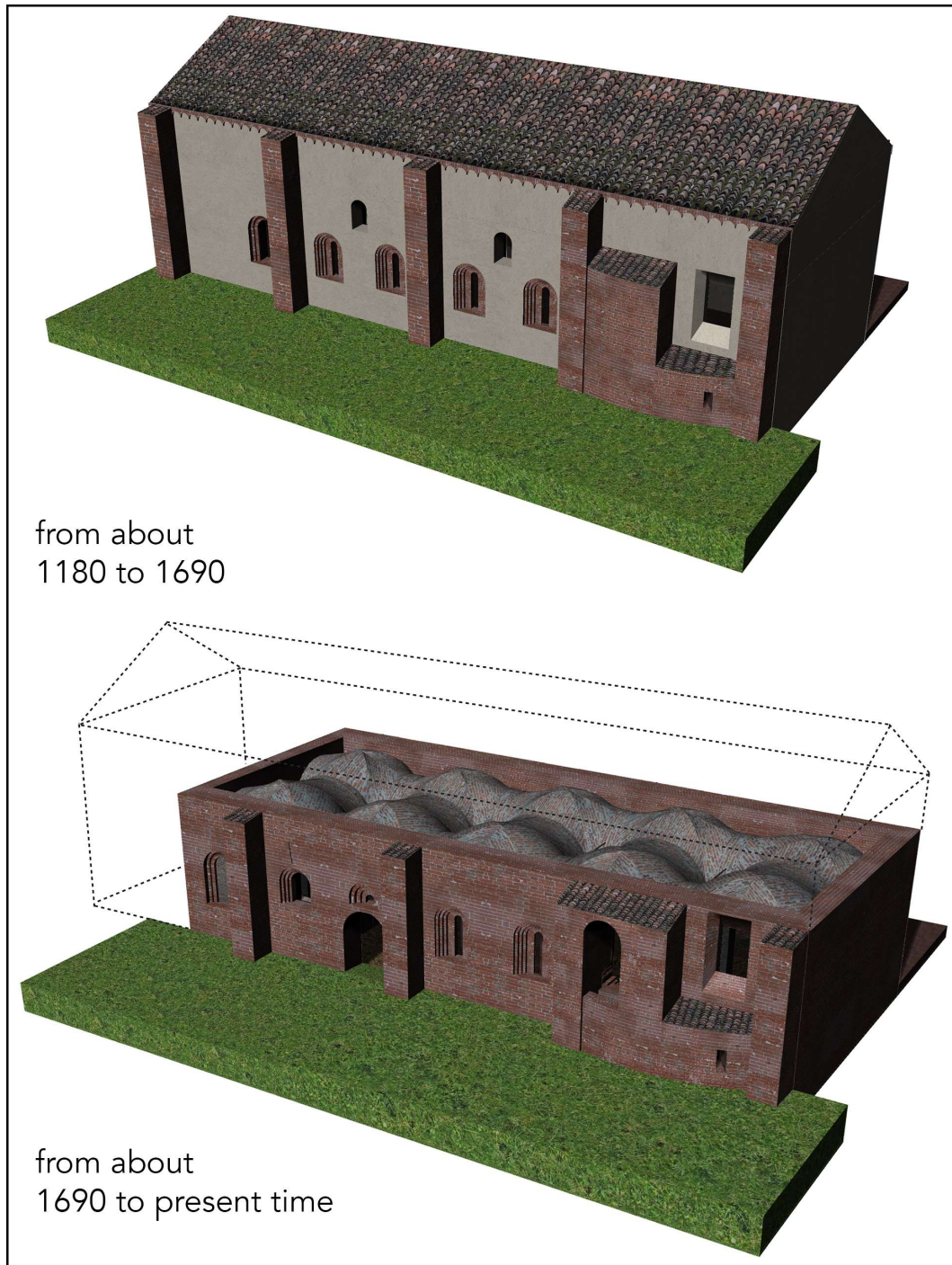

Figure 209. Chronological interpretation and changes of the refectory (backyard side) from about 1180 to present time. As described in the previous chapter, the original ceiling (higher than today) was supposed to have a wooden trussed roof supported by diaphragm arches (Fig. 206), similar to Fossanova refectory (Fig.28) and in line with the Bertea drawing (Fig. 148). After structural interventions occurred since 1690, it was turned into a groined vaulted system - (elaboration F. Diara).

# Chapter 10

## A non-conventional HBIM platform

The word chosen to describe the HBIM platform is *non-conventional*. But why a non-conventional HBIM platform? Different reasons have caused the usage of this word. The principal reason is, according also to the main purposes of this thesis mentioned in previous chapters, based on the usage of an open source solution as regard the BIM platform, such as FreeCAD open source software, because nowadays BIM specialists, architects and other users widely use and rely on commercial BIM software such as Autodesk Revit, Archicad and other solutions (Logothetis et al., 2016 and 2018). This is why brings me to thinking about the possibilities and capabilities of free and open source software (FOSS) and whether and how these solutions are suitable for the creation of an operative and methodologically correct open source HBIM platform. Consequently, starting from this real challenge, another unconventional reason is referred to the creation of a fitting custom-made solution for historical buildings and buildings archaeology.

Moreover, this thesis project is based on (as described in the previous chapter) the integration analysis of the open source software FreeCAD and a free form pure modeller software like Rhinoceros, trying to understand whether and how these different solutions (especially from a conceptual point of view) could cooperate together for the purpose of integrating an accurate modelling phase into a BIM platform, avoiding the limited modelling steps inside a BIM software.

### 10.1 Open source thought inside BIM

The use of free and open source (FOSS) solution for Cultural Heritage assets could be considered a challenge. Before we run into an open source project some questions or reflections should come up, such as: could academic laboratories, inside public universities, always afford specific up-to date commercial



technologies and instruments? Could Cultural Heritage researcher' elite be considered privileged due to their funds and economic resources? Could Cultural Heritage researches carry out with the integration of FOSS software? How these FOSS solutions could be affordable and accurate?

Answering these questions is quite complicated and we need to reasoning on it, especially because reasoning in general about the economic issue it is never easy and simple. So, could Cultural Heritage researchers be considered *privileged*? From cultural point of view certainly of course, but the merely economic aspect is the key issue. It is obvious that in order to produce a large amount of digital data, as LiDAR or photogrammetric data, we need to rely on a considerable sum of economic resources, because the instruments related to these data acquisition technologies have a not cheap commercial price and not all laboratories could effort these costs.

Nowadays by using commercial BIM software could be very easy to make compromises, as well as methodological ones as concern historical building or an archaeology project, also because doing digital Cultural research means to use specific technologies and instruments, and it means to do an important economic effort, from public or private entities.

This reasoning brings us to run into the accuracy and reliable issue of the commercial solutions towards low cost and FOSS instruments and software, and this thought could lead us to ask more questions like: who is the owner of these instruments achieves more accurate results in research? Could Cultural Heritage researchers do scientific studies with low cost or FOSS instruments? If it can be done, with the equality of results, how these studies can be compared with others performed with high cost solutions? Do both studies have the same importance? In fact, in order to obtain and stabilize final data at the end of a research, if we use a specific up-to date commercial instrument (and it has an economic relevance) that brings us to reach equal results, also as regards the metric precision, of a study carried out and managed by using low cost and / or FOSS technologies, behind this methodological choice there is a problem.

In the Cultural Heritage field, like archaeology or analyses concerning also historical buildings, analyses carried out with low cost and FOSS solution have often proved to be affordable and reliable, allowing to obtain complete results from a conceptual and methodological point of view and, moreover, the experiences gathered on GIS development for Cultural Heritage assets documentation during recent years allow reasonable optimism (Diara et al., 2018).

In facts, a fitting and good solution to guarantee the usability, accessibility, transparency and customizable opportunity of data could be provided by open source software, libraries, codes, file formats (Logothetis et al., 2016). Moreover,

FOSS solutions, thanks to their source code accessibility and modifications possibilities, often allow to adapt software, libraries and add-ons to Cultural Heritage needs and not the opposite of acting, avoiding methodological and conceptual stretches (Myers et al., 2016; Diara et al., 2018).

The adoption of FOSS solutions could be also considered a milestone in Cultural data research and production preservation and fruition, especially while closed file format and protocols are prone to constant upgrades by the developers and this thought could lead to losing the portability of file format and data on other platforms developed differently (Logothetis et al., 2016 and 2017a).

For this reason and thought, the thesis project here presented is based on the adoption of FreeCAD as open source BIM software, testing whether is possible to create an operative and complete FOSS HBIM platform and how it can be integrated, implemented, modifying following the needs of historian, buildings archaeologists and archaeologists in general.

## **10.2 FreeCAD**

FreeCAD is a parametric CAD and BIM open source software compiled in C++ and Python based on the workbenches though for different disciplines and professional figures, and these workbenches allow, due to the big community on background, increasing the default standard package of the software and therefore its potentialities and applications. During last years, FreeCAD growth up from a simple CAD software to a more complex and updated BIM platform for architectural and engineering design, and this rise depended on the people who implement, develop and manage constantly the source code of the software. Moreover, this growth should be also supported by analyses and projects for the purpose of testing FreeCAD as a complete BIM software, and in the last years this happened thanks to specific researches (Macher et al., 2017; Logothetis et al., 2017a).

Being an open source customizable solution, FreeCAD is almost an empty software that has to be compiled and integrated depending on specific needs and for this reason FreeCAD benefits from the contributions and efforts of a big community of developers, fans and users from all over the world.



Figure 210. FreeCAD homepage and direct download link

For the purpose of managing a BIM or HBIM project, it is almost bare from a lot of necessary tools and it requires to be connected with open source libraries and packages developed from FOSS and FreeCAD community. Talking about BIM projects, from a semantic point of view, this software could be considered more than a 3D parametric modeller: in fact, in addition to allows guarantee the presence of 3D modelling tools, it allows to connect to parametric objects features and information concerning its characteristics, as well as the connection by semantic relations.

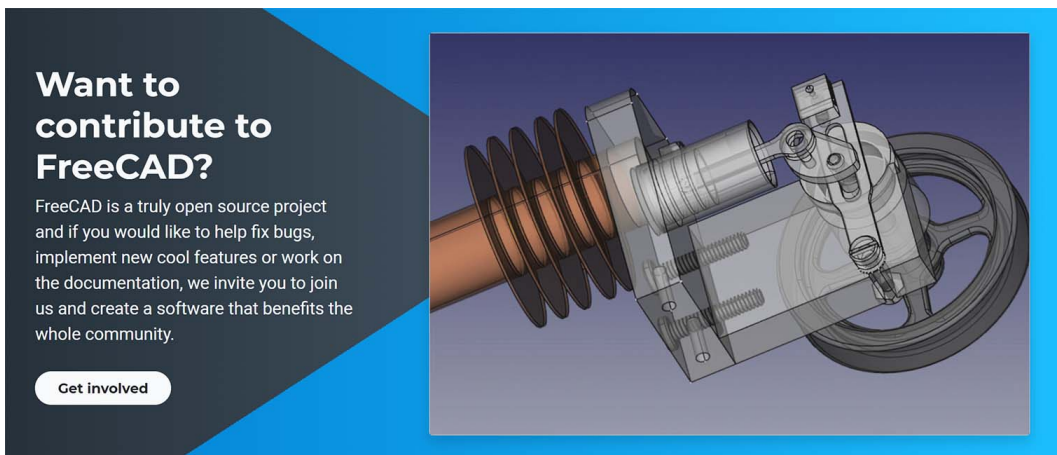

Figure 211. Quick access to big community on FreeCAD homepage to get involved

## 10.2.1 Main features of FreeCAD

As mentioned before, FreeCAD is a complete **parametric modeller**, and its objects are natively parametric: it means that the shape related to objects can be managed by using properties or even depend on other objects. All the modifications concerning models are recalculated real time through the left menu, and registered by a stack. These parameters and modifications could be performed also by using Python scripts in the console.

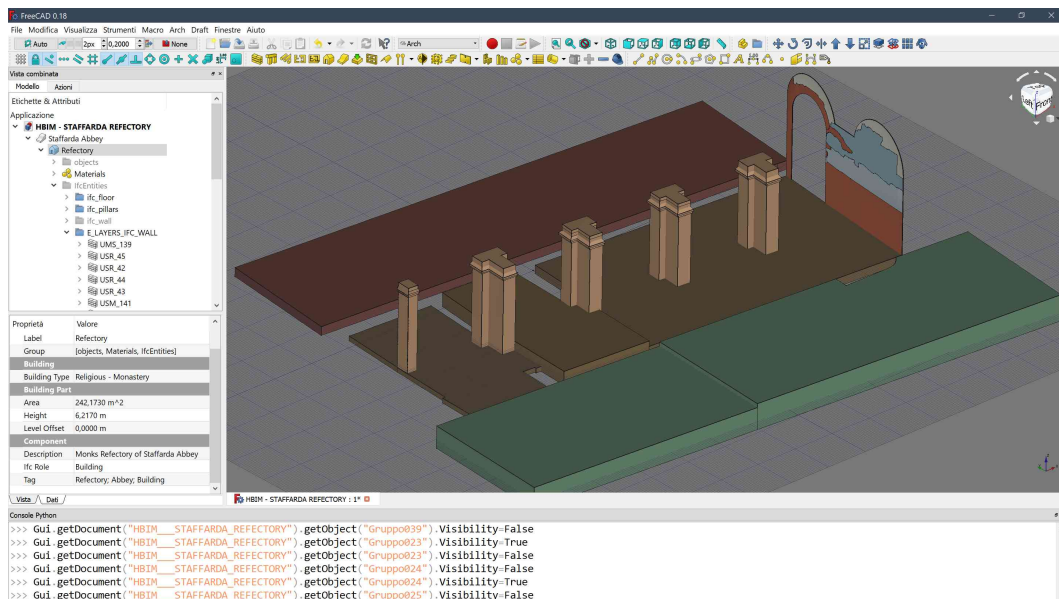

Figure 212. FreeCAD general overview: on the upper part command tools; on the left data and object tree; on the lower part the Python console; on the foreground the 3D space (elaboration F. Diara).

Moreover, FreeCAD has a geometry kernel based on **Open CASCADE Technology (OCCT)**<sup>31</sup>, allowing complex three-dimensional operations on complex shape types, supporting also a wide range of geometric entities, Boolean operations, fillets and file formats. However, due to software bugs and crashes complex operation of modelling could experience different issues.

As just mentioned before, the software has a **flexible and modular structure** allowing improving it by useful additional extensions (workbenches or

<sup>31</sup> Briefly, Open CASCADE Technology is a software development kit, including C++ libraries, thought for the development of 3D CAD applications. It provides services for 3D modelling and CAD data exchange.

macro modules) to add functionality to the main kernel of the application. In this regard, the default pre-installed modules are concerning DRAFT, SKETCHER, ARCH and PART workbenches<sup>32</sup>.

The **DRAFT** Workbench allows drawing 2D objects and it allows to perform and manage tools to define a working plane and commands in order to control the position of designed geometries. Furthermore, the created objects can be used as the backbone for the purpose of modelling 3D objects, by using other workbenches (ARCH and PART above all).

The **SKETCHER** workbench allowing sketching 2D geometries by using constraints. As the previous workbench, it is possible to modelling 3D objects by using other workbenches.

The **ARCH** workbench is probably the most used and the most important inside FreeCAD. It makes possible to perform BIM workflows thanks to, in addition to the full support to the IFC data (by using IfcOpenShell libraries), its features and commands, such as the presence of parametric entities related to architecture and industry field: WALL, STRUCTURAL ELEMENT, COMPONENT, ROOF, WINDOWS, STAIR, PIPE, and FURNITURE are family entities though for new projects and modern architecture.

An important feature of ARCH workbench is concerning the possibilities of managing and using solid 3D objects created by using other workbenches (such as PART) and also by importing 3D solid model (STEP and IGES for example) from another modeller software (and this feature needs in order to perform the integration inside this thesis work).



Figure 213. ARCH workbench and DRAFT command tools

As far as BIM functionality are concerned, FreeCAD allows to integrate the default workbench list with the additional (via add-on manager) **BIM** workbench. In fact, by using this tool the correct implementation of BIM workflows occurred, and it allows managing the BIM project, from the general detail to the floors design. Anyway, BIM module cannot do without ARCH module, which is referred to single architecture entities.

The **PART** workbench is a module that allows to manage the geometric primitives related to Open Cascade Technology libraries. Moreover, it could be

<sup>32</sup> Here is the workbenches list of FreeCAD: <https://www.freecadweb.org/wiki/Workbenches>

considered the pure modelling module of FreeCAD, that allows to modelling objects starting for example from DRAFT or SKETCHER drawings.



Figure 214. PART workbench command tools

However, the 3D objects created with this module are intended to be managed with Boolean operations (unions and cuts) in order to build more complex shapes. Anyway, complexes operations concerning more shapes, geometries and solids may result unstable and may happen the crash of FreeCAD. For this reason, PART modelling tool is good for very simple operations of unions or cuts Open Cascade Technology shapes but for complexes elements and components related to historical architecture a pure free form modeller is recommended.

### 10.3 Compiling FreeCAD

FreeCAD development is based on C++ and Phyton language and its implementations are available for Windows, MacOS and Linux operating systems users. Moreover, it can be downloadable through the developing version as well as the source code in order to test latest beta versions and for the purpose of managing and testing these versions of the software.

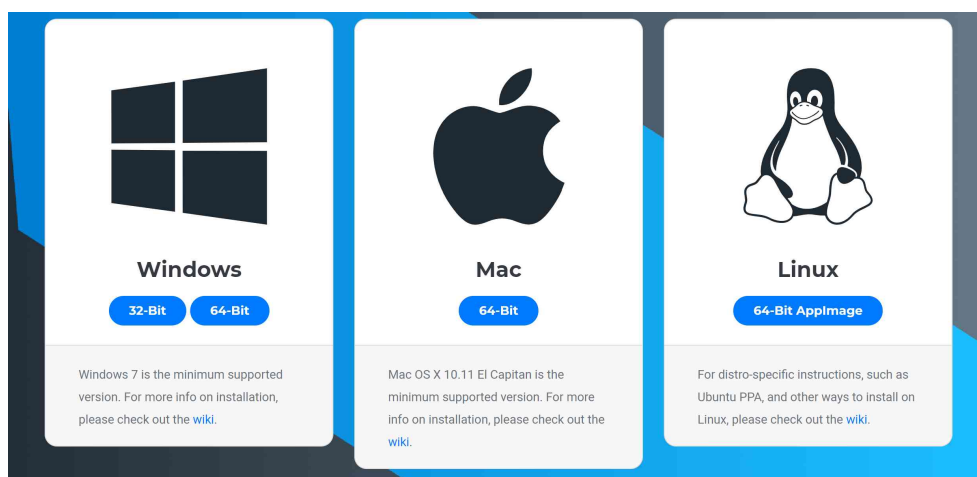

Figure 215. FreeCAD 0.18 downloadable versions

Despite the installation of FreeCAD through the binary packages (.exe or .dmg) could seem complete and easy to perform, the correct usage and future customization of FreeCAD require different open source preparatory packages, tools and libraries, such as Python Installer, PIP, CMake, Homebrew package, XCode, Microsoft Visual C++, GIT.

Here briefly a short description of these tools and libraries:

#### PIP

PIP is the package installer for Python.

#### Python installer

Python in general is a programming language allowing to work quickly and integrate systems more effectively.

#### Homebrew

Homebrew is FOSS software management system that simplifies the installation of software and tools on MacOS and Linux operating systems.

#### XCode

XCode is an integrated development environment of MacOS and it supports different development languages such as C, C++, Java, AppleScript, Python, Swift

#### Microsoft Visual C++

Microsoft Visual C++ is a distributable package of shared code that comes as part of Windows operative system and enables applications to run.

#### GIT

Git is a free and open source control system designed to handle projects with speed and efficiency.

#### CMake

It is an open-source, cross-platform family of tools designed to build, test and package software

### **10.3.1 FreeCAD on MacOS**

In order to install and customize FreeCAD on MacOS system these are the main required tools and libraries to be included after the binary installation of FreeCAD

package: XCode, Python installer, PIP, CMake, Homebrew. These are the procedures in order to install them:

XCode installation (from Mac App store)

<https://itunes.apple.com/it/app/xcode/id497799835?mt=12>

Python installation (online installer)

<https://www.python.it/download/>

PIP installation (package manager for Python – from MacOS terminal):

```
sudo easy_install pip
```

CMake installation (online installer)

<https://cmake.org/download/>

Homebrew package manager installation (from MacOS terminal):

```
/usr/bin/ruby -e "$(curl -fsSL  
https://raw.githubusercontent.com/Homebrew/install/master/install)"  
"
```

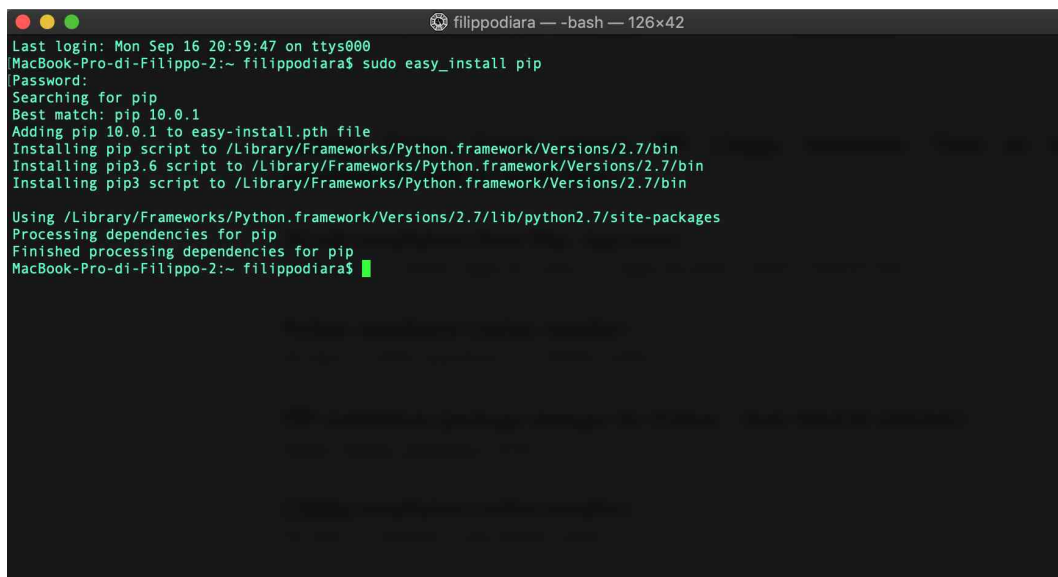

```
filippodiara — -bash — 126x42
Last login: Mon Sep 16 20:59:47 on ttys000
MacBook-Pro-di-Filippo-2:~ filippodiara$ sudo easy_install pip
Password:
Searching for pip
Best match: pip 10.0.1
Adding pip 10.0.1 to easy-install.pth file
Installing pip script to /Library/Frameworks/Python.framework/Versions/2.7/bin
Installing pip3.6 script to /Library/Frameworks/Python.framework/Versions/2.7/bin
Installing pip3 script to /Library/Frameworks/Python.framework/Versions/2.7/bin

Using /Library/Frameworks/Python.framework/Versions/2.7/lib/python2.7/site-packages
Processing dependencies for pip
Finished processing dependencies for pip
MacBook-Pro-di-Filippo-2:~ filippodiara$
```

Figure 216. PIP installation on MacOS terminal

Moreover, FreeCAD could be compiled and installed manually (for expert users) on MacOS machines from the terminal by getting the source code, cloning it into a specific directory and creating the building folder (lines to write one by one):



```
mkdir ~/FreeCAD
cd ~/FreeCAD
git clone https://github.com/FreeCAD/FreeCAD YOR FOLDER
mkdir ~/FreeCAD/build
```

Required dependencies and formulas can be installed by using Homebrew commands on MacOS terminal:

```
brew tap freecad/freecad
brew install eigen
brew install --only-dependencies freecad --with-packaging-utils
```

### 10.3.2 FreeCAD on Windows

FreeCAD on Windows machines, after the binary installation, requires different tools and libraries to be included on the package, like, Python installer, CMake, GIT, and here there are the procedures in order to install them:

Python installation (binary installer)

<https://www.python.it/download/>

CMake installation (binary installer)

<https://cmake.org/download/>

GIT installation (binary installer)

<https://git-scm.com/>

In order to compile FreeCAD manually on Windows, this is the terminal script (GIT command) for the source code download, after we run the prompt or Windows PowerShell into a specific directory:

```
git clone https://github.com/FreeCAD/FreeCAD.git FreeCAD-code
```



```
Windows PowerShell
Windows PowerShell
Copyright (c) 2016 Microsoft Corporation. Tutti i diritti sono riservati.

PS C:\Users\Filippo> git clone https://github.com/FreeCAD/FreeCAD.git FreeCAD-code
Cloning into 'FreeCAD-code'...
remote: Enumerating objects: 109, done.
remote: Counting objects: 100% (109/109), done.
remote: Compressing objects: 100% (74/74), done.
Receiving objects: 6% (11911/198501), 2.56 MiB | 1.26 MiB/s
```

Figure 217. FreeCAD source code download on Windows

## 10.4 FreeCAD customization and implementation

### 10.4.1 Libraries, macros and workbenches

As it has mentioned before, being an open source dynamic software FreeCAD can be integrated and implemented depending on specific needs. Indeed, inside FreeCAD the modification or the creation of add-ons, macros, workbenches (developed by using Python and C++ environment), allows the customization of specific tools and commands of workbenches, parameters, roles, descriptions of objects depending on the project goals.

As far as HBIM of a historic building is concerned, ARCH, DRAFT, PART and PART DESIGN workbenches are probably the most important chunks to be used. ARCH workbench has different tools to define architectural elements of a building, from the biggest ones to the smallest, such as walls, structures, and components.

The main libraries, add-ons, workbenches implemented on FreeCAD for the purpose of developing this thesis project and future similar projects are: Teigha file converter, IfcOpenShell, Graphviz, LibLAS, FCInfo, SimpleProperties, FCInfoToMouse, Dynamic data Workbench, Defeaturing Workbench, Reporting Workbench, and there is a brief description of these tools and libraries:

#### **Teigha file converter**

Teigha file converter is a DWG converter in DXF, it can be used both as the third part software and macro inside FreeCAD.

#### **IfcOpenShell**

IfcOpenShell is an open source library that allows managing, importing and exporting the IFC open format, a necessary requirement for the BIM platform.

#### **Graphviz**

Graphviz is an open library that allows to create dependencies graphics concerning objects and layers inside the tree project of FreeCAD.

#### **LibLAS**

LibLAS is a C/C++ library, as well as libLAS repository, to manage points clouds data with the LAS file format.

### **FCInfo**

FCInfo is a macro add-on that gives a series of information about the selected object and it shows all the characteristics of objects not directly created on FreeCAD.

### **SimpleProperties**

SimpleProperties is a macro that shows properties concerning face area, object volume and object bounding box dimension of a selected 3D object.

### **FCInfoToMouse**

FCInfoToMouse is a macro that shows properties concerning local XYZ coordinates on real time on mouse cursor and also as a label in the project tree.

### **BIM workbench**

BIM workbench allows setting up BIM workflows project by defining characteristics of the site and of the building, including floor levels, openings and so on.

### **Dynamic data Workbench**

Dynamic data Workbench allows creating custom feature Python objects to serve as containers for customizable properties.

### **Defeaturing Workbench**

Defeaturing Workbench is an add-on thought for editing STEP models, removing of the selected features from the model.

### **Reporting Workbench**

Reporting Workbench allows creating queries based on SQL language, showing in addition the result into a data sheet, easily to export it.

Installing and implementing FreeCAD with macros and workbenches is very easy thanks to the ADDON MANAGER (both for Windows and MacOS) that allows downloading and installing additional tools for different usage. In this way has been possible the installation of BIM workbench, Dynamic data workbench, Defeaturing workbench, Reporting workbench, FCInfo macro, SimpleProperties macro, FCinfoToMouse macro.

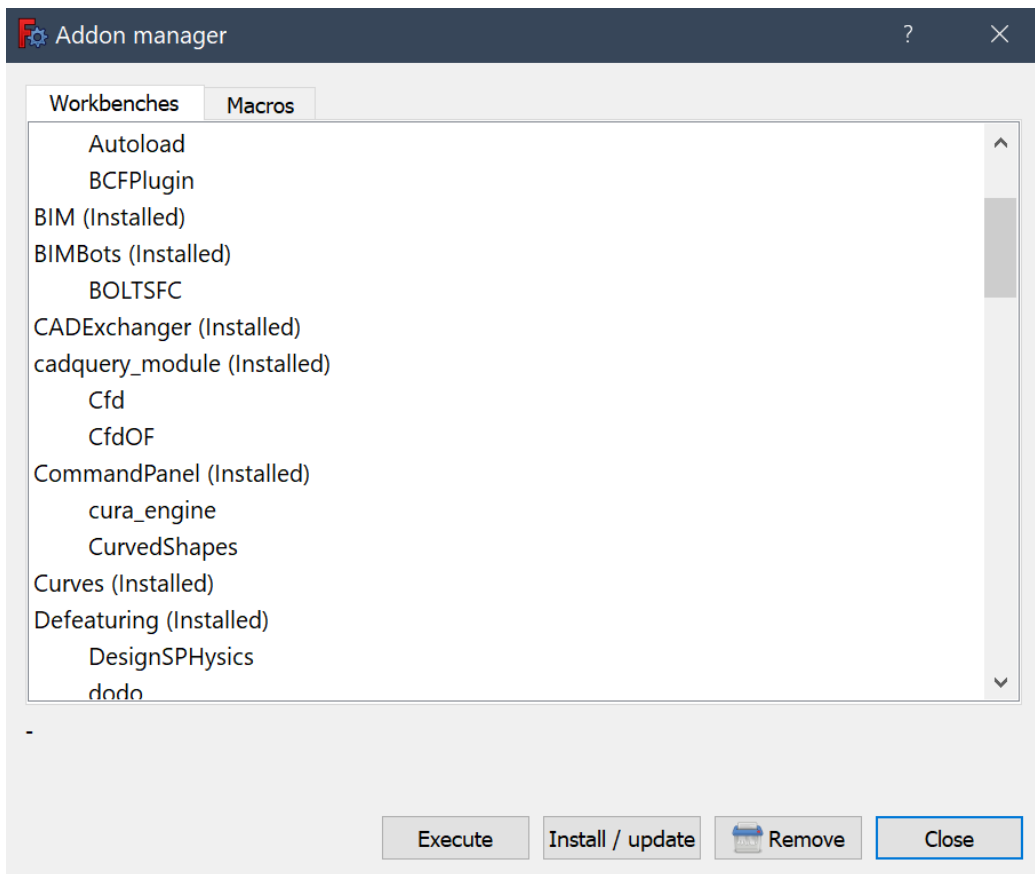

Figure 218. FreeCAD addon manager

Furthermore, the installation of libraries and tools like Teigha file converter, IfcOpenShell, Graphviz, LibLAS need to be performed by downloading manually or managing codes on the terminal of Windows or MacOS. As far as the MacOS operative system is concerned, these libraries need to be downloaded and installed in this way:

**Teigha file converter – online package (download and install)**

[https://www.opendesign.com/guestfiles/oda\\_file\\_converter](https://www.opendesign.com/guestfiles/oda_file_converter)

**IfcOpenShell – online package (download and install)**

<http://ifcopenshell.org/python.html>

**Graphviz installation (from terminal):**

```
brew install graphviz
```

LibLAS repository installation (from terminal):

```
git clone git://github.com/libLAS/libLAS.git liblas
```

LibLAS installation (from Homebrew terminal)

```
brew install liblas
```

Performing FreeCAD projects by using Windows operative system these libraries and tools can be downloaded and installed in this way:

Teigha file converter – online package (download and install)

```
https://www.opendesign.com/guestfiles/oda\_file\_converter
```

IFCOpenShell – online package (download and install)

```
http://ifcopenshell.org/python.html
```

Graphviz installation (Visual Studio packages – need to set PATH variable):

```
https://graphviz.gitlab.io/\_pages/Download/Download\_windows.html
```

LibLAS repository installation (from prompt or Windows PowerShell and after installed GIT):

```
git clone git://github.com/libLAS/libLAS.git liblas
```

#### 10.4.2 Material Database

FreeCAD CAD/BIM platform has a default big material database related to the architectural design and engineering filed. It can be managed in the ARCH workbench, by using the MATERIALS command tool: through a drop-down menu it shows material widely used for new architectural design projects, such as glass, concrete, aluminium, steel, plastic, generic wood. It contains these material because the software hasn't been developed for the purpose of managing existing buildings or managing historical buildings and the related historical materials, for example for historical architecture or archaeological sites and remains.

In fact, this database is referred to the MasterFormat<sup>33</sup> and Omniclass<sup>34</sup> standard classification, which are comprehensive classifications systems for the construction industry, and can be used for different applications, such as filing physical materials or organizing and managing specific information of a project.

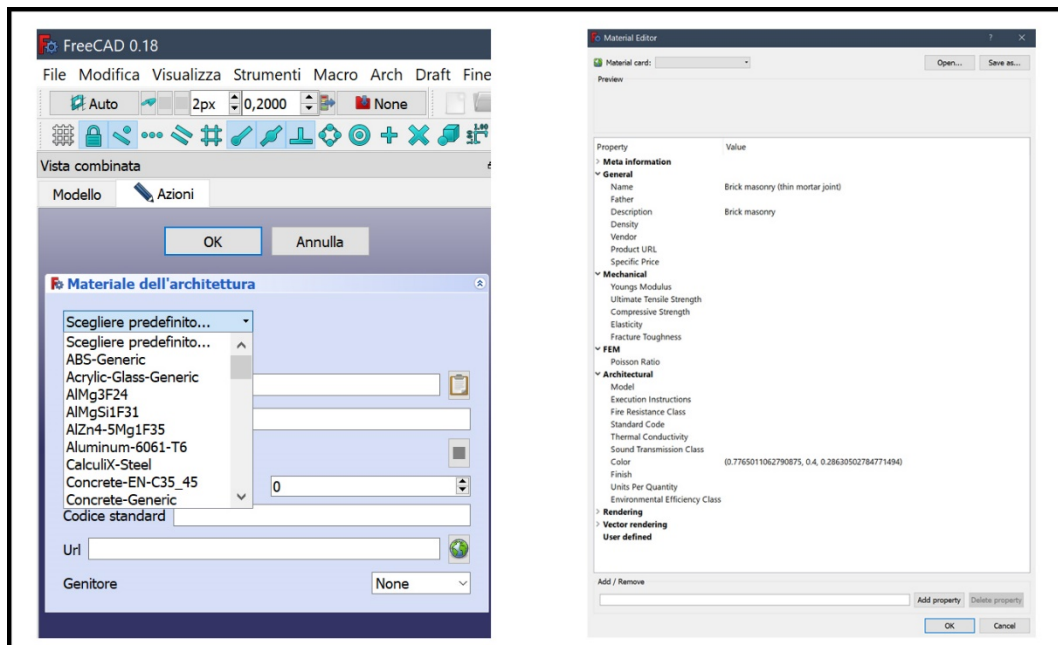

Figure 219. FreeCAD default material database and material editor

This type of classification contains particular characteristics of materials, such as mechanical properties like Ultimate Tensile Strength, Compressive Strength, Youngs Modulus, Elasticity, Fracture Toughness and architectural properties like Environmental Efficiency Class, Fire Resistance Class, Sound Transmission Class, Thermal Conductivity. These materials and properties can be implemented directly into 3D parametric objects of FreeCAD, and, in this way, for example, an extruded vertical rectangle becomes a parametric concrete wall, including the related properties.

Despite these limitations, FreeCAD allows us to customize the default materials database, and it permitting to create a custom material database depending on specific needs. In fact, in order to perform an HBIM project, the customization of

<sup>33</sup> [www.buildsite.com/masterformat](http://www.buildsite.com/masterformat)

<sup>34</sup> [www.csiresources.org/standards/omniclass](http://www.csiresources.org/standards/omniclass)

this materials database becomes a fundamental step, and FreeCAD allows this kind of intervention and implementation: by using the MATERIALS EDITOR TOOL the creation of a custom-made material library becomes possible (for example new\_material.FCMat): starting from MasterFormat or Omniclass classification, the new material properties can be included inside the material card by specifying general information and properties such as mechanical, architectural and rendering properties.

Acting in this way, an HBIM project, like this or similar, performed with FreeCAD could integrate a custom-made historical materials database, containing for example materials like travertine, marble, limestone, sandstone, clay, dirt, brick, mortar, plaster, iron, bronze and other kinds of materials.

#### **10.4.3 Custom roles for FreeCAD**

The creation of an HBIM platform of historical buildings requires some precautions, especially as far as definition and classification of macro and micro architectural components, pieces of evidences and materials are concerned.

Performing an HBIM project, architectural predefined entities, depending on BuildingSmart standard classification<sup>35</sup>, should be assigned to parametric objects in order to define a generic vertical extruded solid as a WALL entity.

However, FreeCAD, like other BIM software, doesn't contain specific architectural predefined entities related to historical buildings because the BuildingSmart standard classification referred to IFC2X3 and IFC4.1 schemas<sup>36</sup> have been designed for industry, architectural design and engineering projects and doesn't include historical architectural families and descriptions, and this is a critical point to be solved as far as Heritage assets modelling is concerned (Simeone et al., 2014; Scianna et al., 2015). Anyway, the architectural entities roles of FreeCAD can be extended following the historical architecture needs, even if they are not provided with the integration inside IFC2X3 and IFC4.1 schemas. In fact, this kind of implementation is related just to a local and demonstrative modification of architectural roles.

---

<sup>35</sup> <https://technical.buildingsmart.org/>

<sup>36</sup> <https://technical.buildingsmart.org/standards/ifc/ifc-schema-specifications/>

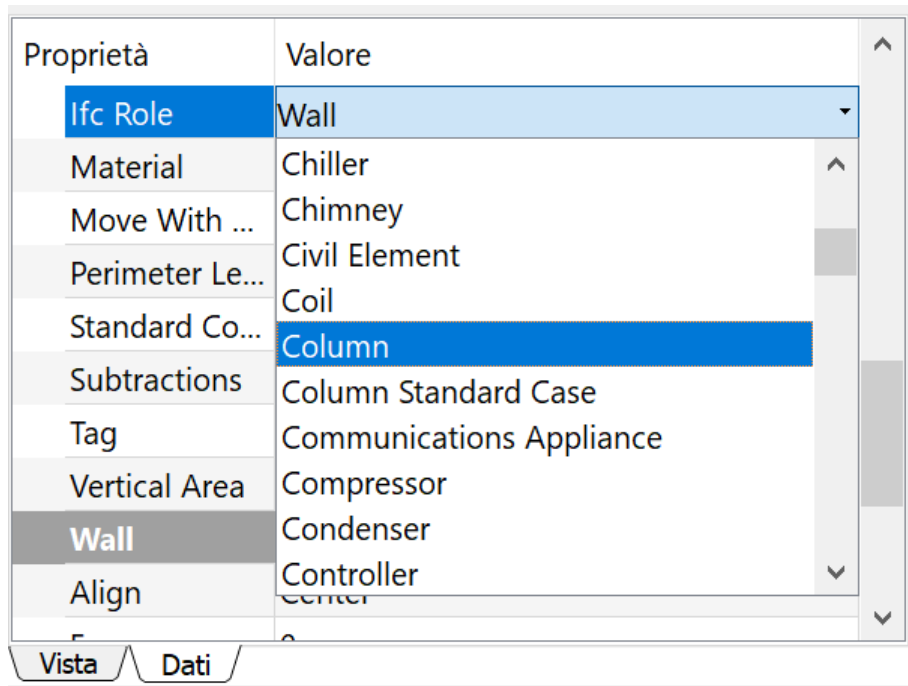

Figure 220. FreeCAD IFC Role on left data menu

By using FreeCAD version 0.16 and 0.17 the modification of IFC roles (on the left menu of properties) has to be performed customizing every python file related to the entities scripts, containing specific roles for specific entities: for example IFC roles of ARCH WALL entity can be implemented by adding custom roles inside the ArchWall.py file, and the same thing for the purpose of modifying ARCH STRUCTURE entity shall customize the ArchStructure.py file and find the roles line.

Differently from this procedure, by using FreeCAD latest 0.18 version the IFC roles list, equally editable, is related to a single drop-down menu containing same roles for all IFC entities and then not specific roles for specific entities.

#### 10.4.4 IFC Schema proposal for Cultural Heritage assets

The definition of historical architectural entities inside the BuildingSmart schemas and standards is probably the main ongoing research field for HBIM studies. Following previous procedures and according to historical buildings' needs, for example WALL entity can be extended with roles as cladding, buttress, terrace, retaining wall; STRUCTURE entity could include roles like wall cavity,



opening related to doors and windows, load-bearing structure, architrave; the COMPONENT entity could include roles related to the smallest historical architectural components as quoin, brick, roof tile.

Moreover, this list of roles, even if it regards industry and architectural projects, can be extended also regarding archaeological sites and buildings archaeology: for example, the FreeCAD roles tool concerning the archaeological documentation method may allow the classification of archaeological units as the archaeological evidences: *POSITIVE UNIT* related to accumulation activities, *NEGATIVE UNIT* concerning erosion or removing activities, *NEUTRAL UNIT* related to transformation activities, *HIDDEN UNIT* referred to hidden evidences behind or under other units. Moreover a classification could include the typology of reference units (UR) mentioned in chapter 4: *masonry stratigraphic unit* (USM), *render / plaster stratigraphic unit* (USR), *architectural element* (EA), *architectural complex* (CA), *block of the building* (CF), *general elevation* (PG), *particular elevation* (PP), *horizontal structure* (SO), *functional unit* (UF). These classifications might be included in entities like WALL, STRUCTURE and COMPONENT, from the biggest to the smallest unit (USM and USR).

Consequently, following these proposal modifications and carrying out an HBIM project for archaeology or buildings archaeology, the recording of the stratigraphic evolution, through the definition of archaeological units, could be possible also including specific description units by units.

In this sense, the development of a custom-made workbench inside FreeCAD is a real challenge (modifying for instance the ARCH workbench), for example thought for historical buildings or archaeological sites. In this regard, roles mentioned before could be included in a custom tool or additional workbench called *STRATIGRAPHIC UNITS*, thus based on stratigraphic evidences, as parametric surfaces linked to the IFC model, and their interpretation.

From the archaeological and historical point of view the archaeological and architectural evidences, related to typologies of stratigraphic units and macro and micro architectural elements could be included inside FreeCAD IFC entities like that:

#### **Component model entity**

Masonry stratigraphic unit (USM), render / plaster stratigraphic unit (USR), architectural element (EA).

**Wall model entity**

Masonry stratigraphic unit (USM), block of the building (CF), general elevation (PG)

**Structure model entity**

Architectural complex (CA), horizontal structure (SO), functional unit (UF)

In general, stratigraphic units related to buildings archaeology (mainly USM and USR) could be included into COMPONENT and WALL entities, due to their particularities strictly linked to the architectural field, because a masonry stratigraphic unit, such as render / plaster units, could be entirely part of a wall. Indeed, stratigraphic units could be classified as IFC WALL entities, and in general as wall layer, customizing in any way the description, tag, standard code fields by including text and alphanumerical data concerning description of each units and information.

However, according to the IFC2X3 and IFC4.1 schemas, entities and roles related to historical architecture does not include in the lists, due to, as mentioned more times, the industry and design limitations concerning BIM projects (Yang et al., 2019).

For HBIM purposes, Cultural Heritage assets and peculiarities need to be included inside standard definition and classification of building elements and architectural components. In fact, Wall, Window, Column, Roof, BuildingElement, Element and so on, are classification families that rarely fit with Cultural Heritage assets, such as a vaulted ceiling, pillars, capitals and more complexes opening systems like single-lancet windows or double lancet windows, not to mention to decorations and decorative plasters.

According to these needs, an update IFC schema could be included in future building components and architectural elements concerning Cultural Heritage assets, for example by adding SUB TYPES on the principal IFC entities, like the following proposal:

**Sub types of IFC\_ROOF**

Arch; Pointed Arch; Round Arch; Vault; Rib Vault; Groin Vault; Barrel Vault

**Sub types of IFC\_WALLS**

Apsis; Cladding Wall; Buttress; Terrace; Retaining Wall

**Sub types of IFC\_WINDOW or IFC\_OPENING\_ELEMENT**

Arch; Archivolt; Pointed Arch; Round Arch; Single-lancet Window; Double-lancet Window; Triple-lancet Window

#### **Sub types of IFC\_DOOR or IFC\_OPENING\_ELEMENT**

Arch; Archivolt; Pointed Arch; Round Arch; Double-lancet Door

#### **Sub types of IFC\_BUILDING\_ELEMENT**

Architrave; Arch; Archivolt; Pointed Arch; Round Arch; Buttress; Bracket; Shelf

#### **Sub types of IFC\_ELEMENT**

Quoin; Brick; Roof tile; Stone Element; Stone Block

However, the integration and implementation of IFC2X3 and IFC4.1 schema depends on the application of specific international standard and on the adoption of these ones from countries, and these steps could be very long and years consuming procedures. In other words, this presented proposal would be a theoretical suggestion for the future implementation of the BuildingSmart IFC schemas.

## **10.5 Refectory HBIM platform**

### **10.5.1 NURBS managing process**

As described on modelling previous chapter, NURBS surfaces of concerning all architectural elements and stratigraphic units of the refectory created using Rhinoceros software have been exported in **STEP** format (Standard for the Exchange of Product model data), defined by ISO normative 10303-21<sup>37</sup>. STEP is standard format for model and their data exchange concerning metric and geometric information and other information, such as the modelling history of the object for the right information sharing process.

---

<sup>37</sup> <https://www.iso.org>

So, by using STEP file format the information related to objects are recognized by different coding protocols of software and data could be sharing in a three-dimensional model.

NURBS models created by using Rhinoceros software are related to models composed by flat shapes and surfaces without the volumetric dimension and then the thickness parameter. For this reason, NURBS models (characterized by closed exterior edges and internal section curves) can't be directly implemented on BIM platforms, because they need to be parametrized manually depending on real measurements. Correctly explained by Banfi F. (2017) on Grade Of Generation analysis, in a BIM environment the realization of BIM objects becomes possible by editing the related thickness of NURBS irregular shapes.

The image shows the 'Direzione' (Direction) dialog box in FreeCAD. It is divided into several sections:

- Direzione:** Contains three radio buttons: 'Lungo la normale', 'Lungo il bordo', and 'Direzione personalizzata'. The 'Direzione personalizzata' option is selected. To the right of 'Lungo il bordo' is an 'Invertita' checkbox. Below these is a 'Seleziona' button.
- Direzione personalizzata:** Contains three input fields for X, Y, and Z coordinates. X is set to 1,0000, Y to 0,0000, and Z to 0,0000.
- Lunghezza:** Contains two input fields: 'Nello stesso verso' (0,3 m) and 'Nel verso contrario' (0,0000 m). Below these is a 'Simmetrica' checkbox.
- Angolo di rastremazione verso l'esterno:** Contains two input fields, both set to 0,0000 deg.
- Crea solido:** A checked checkbox at the bottom left.

Figure 221. FreeCAD extrude command tool and its parameters

In FreeCAD platform, this procedure has been carried out by using PART workbench, which allows, in addition to different modelling tools, extruding the imported STEP object (automatically recognized as a PART object when imported) using the **extrusion command tool**, allowing to create a parametric and volumetric solid object starting from NURBS shapes and surfaces created with Rhinoceros. Before the extrusion computation, by using the additional DEFEATURING

workbench has been possible the removal of features of STEP objects (apart from metric data) in order to obtain clean surfaces ready to be extruded.

The extrusion process involves the right parametrization of surfaces, applying on the right Cartesian plane (X, Y, Z) the **thickness** value, which can be modifying through the left data menu related to parameters. However, this procedure has been led carefully due to different shapes overlaps after the extrusion computation, for this reason some joined elements, such as walls and openings related to windows, have experienced subtractions operations among extruded shapes, in order to obtain a right volumetric combination.

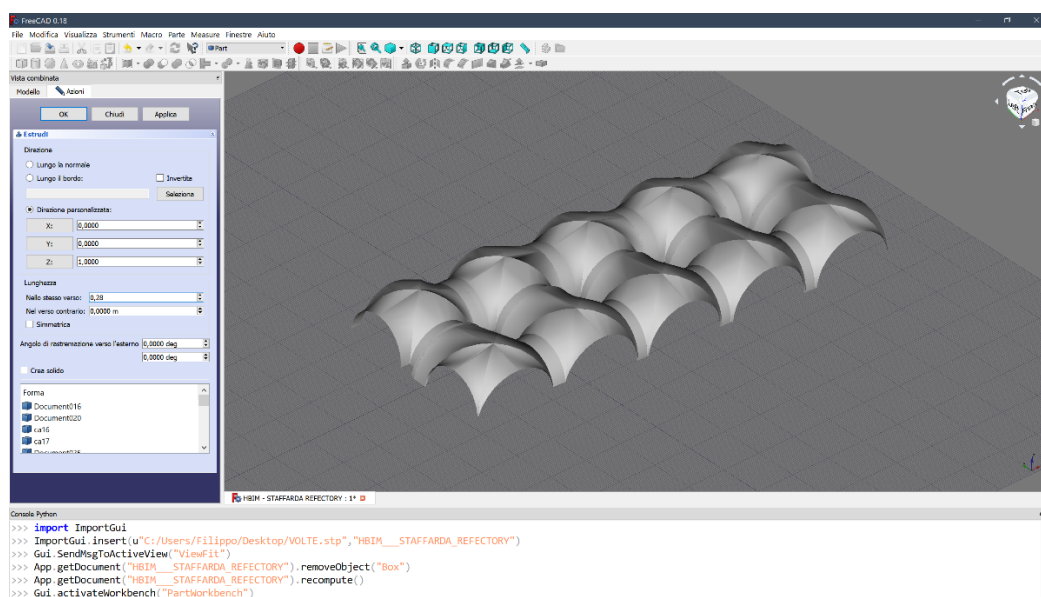

Figure 222. Extruding operation (on Z positive plane) concerning vaults (elaboration F. Diara).

As far as the **vaults** and **arches** modelling is concerned, due to the unperformed metric survey on the crawl space for its off limits conditions, the thickness value and then the extrados surface of vaults has been defined calculating approximatively the brick dimension and plaster thickness and extruding surfaces depending on it, in this case about 35 cm. Going deeper, the extrusion regarding the imported **stratigraphic surfaces units** has been led and managed applying a thickness value of 5 mm maximum per units, and this operation, although a minimum approximated value has been set-up, allows to obtain a solid extruded object of each unit.

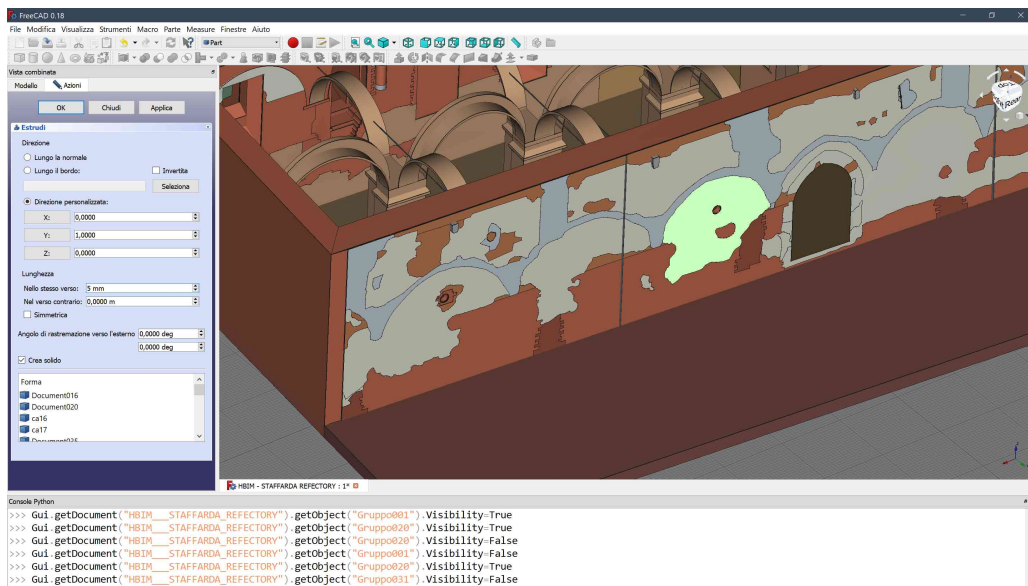

Figure 223. Extruding operation concerning a stratigraphic plaster unit extruding in Y positive plane of 5 mm (elaboration F. Diara).

Furthermore, the additional DYNAMIC DATA workbench has influenced this processing step especially because it allows creating custom Python objects to serve as containers for customizable features and properties (including the thickness obtained by the extrusion computation). Then, these properties can be edited, managed and copy into other related objects and also used in a CSV internal database in order to collect and modify, in real time, the parameter and objects. Lately, dynamic data concerning objects can be shared with other FreeCAD users who do not have this workbench installed, remaining fully functional.

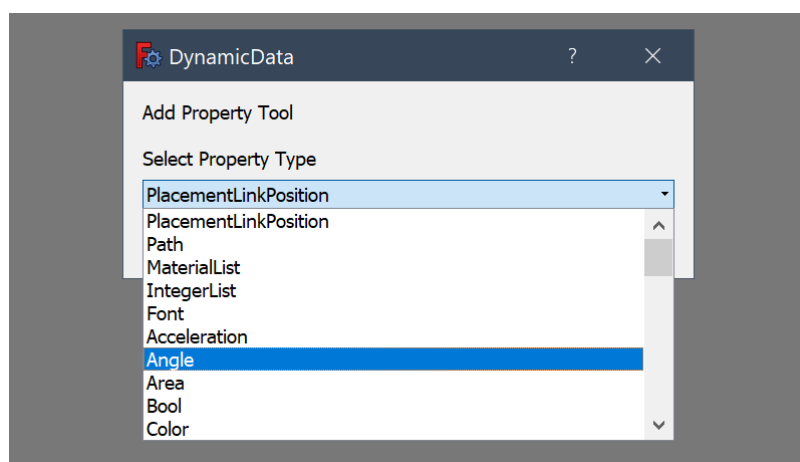

Figure 224. Dynamic Data property type drop-down menu

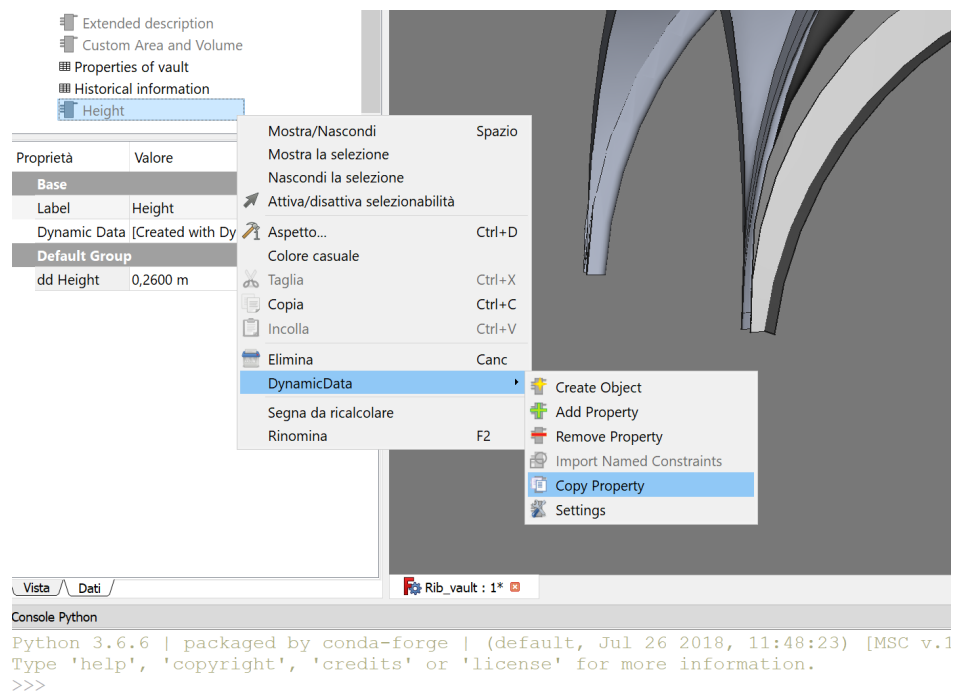

Figure 225. Dynamic Data options and tools

Performing these operations extruded NURBS surfaces are now ready to be converted into BIM parametric objects, having a thickness and volumetric dynamic data. The following step in order to fully convert objects should be the IFC entities attribution.

### 10.5.2 IFC entities and roles attribution

Extruded objects generated in PART workbench resulted in right volumes and thickness values and then can be considerable fully editable and flexible models. However, in order to become BIM objects they need to be classified as IFC architectural entities.

According to actual BuildingSmart IFC schemas (IFC2X3 and IFC4.1)<sup>38</sup>, as already mentioned, the classification is referred to principally to AEC industry (Architecture Engineering and Construction) and it still doesn't include historical architectural families and classification. This attribution step has been affected also by the **IFC ROLE** classification, based on IFC schemas, included inside FreeCAD.

<sup>38</sup> <https://technical.buildingsmart.org/standards/ifc/ifc-schema-specifications/>

In fact, the **drop-down menu** includes 161 IFC classification referred to IFC2X3 and IFC4.1 schemas, which, as already mentioned, rarely have fit with the refectory elements and peculiarities. For these reasons have been conducted two lines of acting for refectory elements:

- Standard attribution of the IFC ROLE classification, following ISO normative and standards;
- Ad-hoc attribution of the customized IFC ROLE classification, overlooking the ISO standards (demonstrative modification).

On the first attribution, the refectory architectural elements have been adapted to the FreeCAD IFC ROLE classification, and in general to ISO normative and standards. But in the second proposed attribution happened the opposite: FreeCAD IFC ROLE classification has been adapted to the refectory elements and peculiarities.

Table 19. IFC ROLE classification referred to the first attribution (ISO normative and standards)

| <b>IFC ENTITY</b>           | <b>ASSIGNED TO</b>                  |
|-----------------------------|-------------------------------------|
| IfcSite                     | Santa Maria di Staffarda abbey      |
| IfcBuilding                 | Refectory                           |
| ifcBuildingStorey           | Six floor / ground levels           |
| IfcRamp                     | Height difference on the ground     |
| IfcRoof                     | Groined Vaults                      |
| IfcWall                     | Walls and stratigraphic units       |
| IfcCurtainWall              | Filled entrances and windows        |
| IfcColumn                   | Pillars and the cornering column    |
| IfcOpeningElement           | Windows and portals                 |
| IfcBeam                     | Wooden beam and the windowsill      |
| IfcStair                    | Stairs and steps                    |
| IfcReinforcingBar           | Reinforcing anchors                 |
| IfcBuildingElement          | Buttresses and arches               |
| IfcBuildingElementComponent | Semi-columns and shelves / brackets |



```

1  {}
2  "IfcActuator": { "attributes": [] },
3  "IfcAirTerminal": { "attributes": [] },
4  "IfcAirTerminalBox": { "attributes": [] },
5  "IfcAirToAirHeatRecovery": { "attributes": [] },
6  "IfcAlarm": { "attributes": [] },
7  "IfcAnnotation": { "attributes": [] },
8  "IfcAudioVisualAppliance": { "attributes": [] },
9  "IfcBeam": { "attributes": [] },
10 "IfcBeamStandardCase": { "attributes": [] },
11 "IfcBoiler": { "attributes": [] },
12 "IfcBuilding": { "attributes": [] },
13 "IfcBuildingElement": { "attributes": [] },
14 "IfcBuildingElementPart": { "attributes": [] },
15 "IfcBuildingElementProxy": { "attributes": [] },
16 "IfcBuildingStorey": { "attributes": [] },
17 "IfcBurner": { "attributes": [] },
18 "IfcCableCarrierFitting": { "attributes": [] },
19 "IfcCableCarrierSegment": { "attributes": [] },
20 "IfcCableFitting": { "attributes": [] },
21 "IfcCableSegment": { "attributes": [] },
22 "IfcChiller": { "attributes": [] },
23 "IfcChimney": { "attributes": [] },
24 "IfcCivilElement": { "attributes": [] },
25 "IfcCoil": { "attributes": [] },
26 "IfcColumn": { "attributes": [] },
27 "IfcColumnStandardCase": { "attributes": [] },
28 "IfcCommunicationsAppliance": { "attributes": [] },
29 "IfcCompressor": { "attributes": [] },
30 "IfcCondenser": { "attributes": [] },
31 "IfcController": { "attributes": [] },
32 "IfcCooledBeam": { "attributes": [] },
33 "IfcCoolingTower": { "attributes": [] },
34 "IfcCovering": { "attributes": [] },
35 "IfcCurtainWall": { "attributes": [] },
36 "IfcDamper": { "attributes": [] },
37 "IfcDiscreteAccessory": { "attributes": [] },
38 "IfcDistributionChamberElement": { "attributes": [] },
39 "IfcDistributionControlElement": { "attributes": [] },
40 "IfcDistributionElement": { "attributes": [] },
41 "IfcDistributionFlowElement": { "attributes": [] },
42 "IfcDistributionPort": { "attributes": [] },
43 "IfcDoor": { "attributes": [] },
44 "IfcDoorStandardCase": { "attributes": [] },
45 "IfcDuctFitting": { "attributes": [] },
46 "IfcDuctSegment": { "attributes": [] },
47 "IfcDuctSilencer": { "attributes": [] },
48 "IfcElectricAppliance": { "attributes": [] },
49 "IfcElectricDistributionBoard": { "attributes": [] },
50 "IfcElectricFlowStorageDevice": { "attributes": [] },
51 "IfcElectricGenerator": { "attributes": [] },
52 "IfcElectricMotor": { "attributes": [] },
53 "IfcElectricTimeControl": { "attributes": [] },
54 "IfcElementAssembly": { "attributes": [] },
55 "IfcElementComponent": { "attributes": [] },
56 "IfcEnergyConversionDevice": { "attributes": [] },
57 "IfcEngine": { "attributes": [] }

```

JSON file

Figure 226. FreeCAD predefined IFC2X3 schema containing the 161 IFC standard roles

Then, the first solution is concerning the rigid application of **ISO normative and standards**. Despite it is referred to stringent adaptations of the refectory architectural elements to these rules, in the same time it ensures and allows to export and share correctly the entire IFC model created to other BIM platform, viewers and servers which are based on the same normative and standards.

The second solution is based essentially on a proposal **custom classification** concerning parts of architectural elements and stratigraphic units related to the refectroy. This solution guarantees a fitting classification for some peculiarities but

has different drawbacks, because it doesn't follow the ISO normative and standards as well as this custom IFC classification is not recognized on other BIM platform and management software based on these rules. Indeed, this custom classification can be used just only for a **demonstrative solution** or for an internal and local usage on FreeCAD software, performing and adapting queries on it, but without exporting models and sharing IFC data.

Table 20. IFC ROLE classification referred to the second custom attribution

| <b>IFC ENTITY</b>           | <b>ASSIGNED TO</b>                   |
|-----------------------------|--------------------------------------|
| IfcSite                     | Santa Maria di Staffarda abbey       |
| IfcBuilding                 | Refectory                            |
| ifcBuildingStorey           | Six floor / ground levels            |
| IfcRamp                     | Height difference on the ground      |
| <b>IfcVault</b>             | Groined Vaults                       |
| IfcWall                     | Walls                                |
| <b>IfcUSM</b>               | Masonry stratigraphic units          |
| <b>IfcUSR</b>               | Render / plaster stratigraphic units |
| IfcCurtainWall              | Filled entrances and windows         |
| IfcColumn                   | Cornering column                     |
| <b>IfcPillar</b>            | Pillars                              |
| IfcOpeningElement           | Windows and portals                  |
| IfcBeam                     | Wooden beam and the windowsill       |
| IfcStair                    | Stairs and steps                     |
| IfcReinforcingBar           | Reinforcing anchors                  |
| <b>IfcButtress</b>          | Buttresses                           |
| <b>IfcArch</b>              | Arches                               |
| IfcBuildingElementComponent | Semi-columns and shelves / brackets  |

```

149 "IfcTransportElement": { "attributes": [] },
150 "IfcTubeBundle": { "attributes": [] },
151 "IfcUnitaryControlElement": { "attributes": [] },
152 "IfcUnitaryEquipment": { "attributes": [] },
153 "IfcValve": { "attributes": [] },
154 "IfcVibrationIsolator": { "attributes": [] },
155 "IfcVirtualElement": { "attributes": [] },
156 "IfcVoidingFeature": { "attributes": [] },
157 "IfcVault": { "attributes": [] },
158 "IfcUSM": { "attributes": [] },
159 "IfcUSR": { "attributes": [] },
160 "IfcButtress": { "attributes": [] },
161 "IfcPillar": { "attributes": [] },
162 "IfcArch": { "attributes": [] },
163 "IfcWall": { "attributes": [] },
164 "IfcWallElementedCase": { "attributes": [] },
165 "IfcWallStandardCase": { "attributes": [] },
166 "IfcWasteTerminal": { "attributes": [] },
167 "IfcWindow": { "attributes": [] },
168 "IfcWindowStandardCase": { "attributes": [] }

```

Figure 227. FreeCAD predefined IFC2X3 schema implemented with other definitions

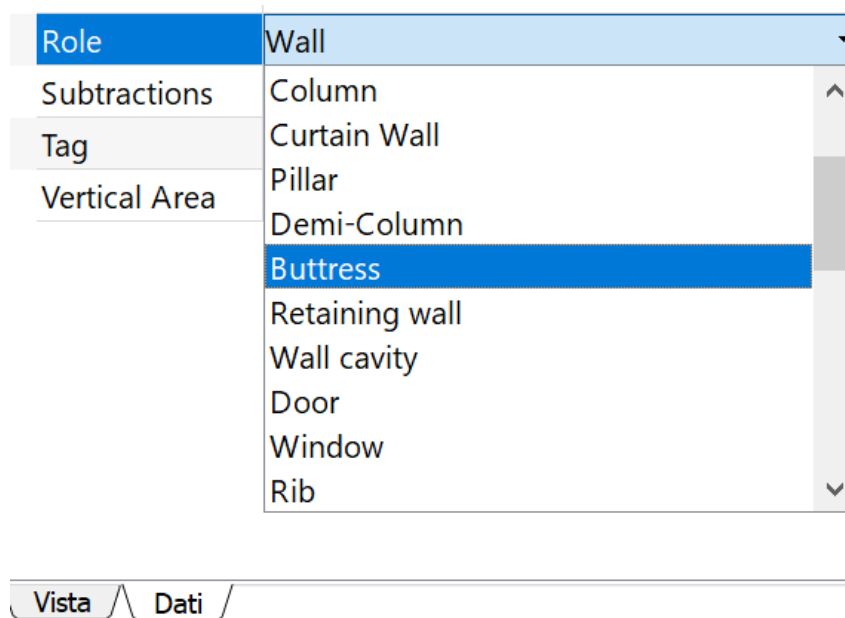

Figure 228. FreeCAD drop-down menu concerning IFC roles after the modifying process

### 10.5.3 Description of IFC entities

Inside FreeCAD, the left menu of attributes after the creation of IFC entities shows different parameters and options to customize and compiled: it includes the **DESCRIPTION** voice fillable by a **text string**. As we can imagine this empty space can be filled by a customize text description of the concerning object, depending on the outline given by the user. FreeCAD pop-up information say that the description field is optional, but for the purpose of performing and managing information of the architectural elements and stratigraphic units it should be a mandatory option to be filled.

| Proprietà        | Valore                           |
|------------------|----------------------------------|
| Base             | Extrude015                       |
| Clone Of         |                                  |
| Description      | Ultima Cena Fresco (XVI century) |
| Hi Res           |                                  |
| Horizontal Area  | 6,8100 m <sup>2</sup>            |
| Ifc Role         | Wall                             |
| Material         | Fresco                           |
| Move With Host   | true                             |
| Perimeter Length | 7,4000 m                         |
| Standard Code    | USR45                            |
| Subtractions     |                                  |
| Tag              | Period_4_1510_1525               |
| Vertical Area    | 9,4300 m <sup>2</sup>            |

Figure 229. FreeCAD left data menu component: in red the description field of a stratigraphic unit

### 10.5.4 Materials of IFC entities

As described in previous paragraphs FreeCAD allows to customize the default materials database, permitting to create custom materials depending on real materials of the project. In fact, by using the MATERIALS EDITOR TOOL has been possible the creation of new materials concerning the refectory, although they do not fit properly with MasterFormat and Omniclass standard classification of

materials. However, it has been feasible to manage and classify materials especially from the visualization and rendering point of view, because materials properties include also other kinds of technical information<sup>39</sup> (mechanical and architectural properties) which have not been possible to include on the platform at the moment, but for further investigation and implementation they should be considered.

In this sense, for the purpose of integrating the refractory materials<sup>40</sup>, inside FreeCAD have been included the following materials and short description: *Brick masonry (thin mortar joint)*; *Brick masonry (large mortar joint)*; *Stone*; *Brown wood*; *Dark wood*; *Plaster*; *Fresco*; *Render*; *Clay ground*; *Brick floor*; *Grass ground*; *Modern brick masonry*; *Metal*; *Brick masonry and plaster*; *Lack of material*. Then, this material addition has been set-up just following the render and colour detail and general description, aside from the MasterFormat and Omniclass classification for the already mentioned reasons.

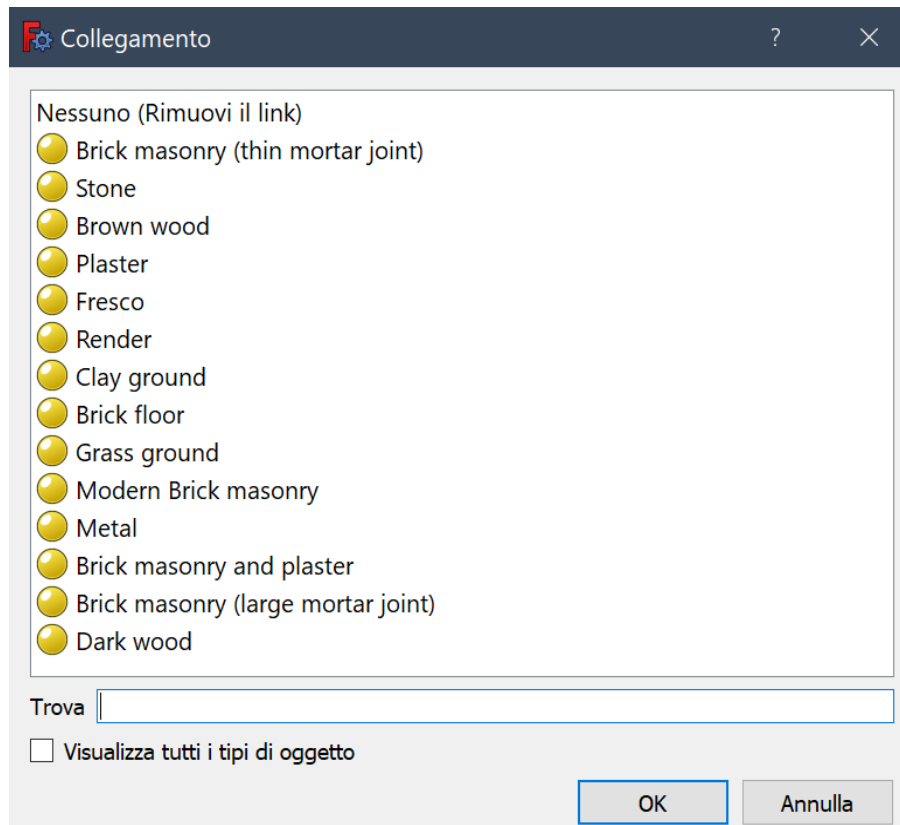

Figure 230. FreeCAD custom list referred to materials

<sup>39</sup> Such as Ultimate Tensile Strength, Compressive Strength, Youngs Modulus, Elasticity, Fracture Toughness and architectural properties like Environmental Efficiency Class, Fire Resistance Class, Sound Transmission Class, Thermal Conductivity.

<sup>40</sup> The material analysis of the refractory is reported on TAV.3-7-11-15-19.

| Proprietà        | Valore                           |
|------------------|----------------------------------|
| Base             | Extrude015                       |
| Clone Of         |                                  |
| Description      | Ultima Cena Fresco (XVI century) |
| Hi Res           |                                  |
| Horizontal Area  | 6,8100 m <sup>2</sup>            |
| Ifc Role         | Wall                             |
| Material         | Fresco                           |
| Move With Host   | true                             |
| Perimeter Length | 7,4000 m                         |
| Standard Code    | USR45                            |
| Subtractions     |                                  |
| Tag              | Period_4_1510_1525               |
| Vertical Area    | 9,4300 m <sup>2</sup>            |

Figure 231. FreeCAD left data menu component: in red the material classification

| Proprietà        | Valore                           |
|------------------|----------------------------------|
| Base             | Extrude015                       |
| Clone Of         |                                  |
| Description      | Ultima Cena Fresco (XVI century) |
| Hi Res           |                                  |
| Horizontal Area  | 6,8100 m <sup>2</sup>            |
| Ifc Role         | Wall                             |
| Material         | Fresco                           |
| Move With Host   | true                             |
| Perimeter Length | 7,4000 m                         |
| Standard Code    | USR45                            |
| Subtractions     |                                  |
| Tag              | Period_4_1510_1525               |
| Vertical Area    | 9,4300 m <sup>2</sup>            |

Figure 232. FreeCAD left data menu component: in red the Standard Code description concerning the stratigraphic units identification number

### 10.5.5 Standard code for IFC entities

Standard Code is another parameter that can be found on the left menu after the IFC entities creation. It is generally referred to an optional **identification code** for the component object, for example an identification code related to MasterFormat and Omniclass standard classification or concerning other kinds of encoding values. The input type is basically a **text string**, although it can be filled using **alphanumerical values** depending on codes. For this reason, Standard Code optional property become fitting for the purpose of integrating the **identification numbers of stratigraphic units**, for example USM 132; USR 45; EA 54 and so on. In fact, this optional property in this HBIM platform has been adapted to the need for buildings archaeology and archaeology in general by filling the empty space with the stratigraphic units numbers.

### 10.5.6 Tag for IFC entities

On the left menu concerning the architectural component, FreeCAD allows to include an optional TAG for the object. It is referred to an empty space fillable by a **text string** input type. Being an optional text string concerning the object, like the description field, it can be managed depending on the outline and purposes given by the user. For this project thesis, TAG field has been managed as a text space for the integration of the historical interpretation of the refectory, including tags like *Historical phases 1, 2, 3, 4* or *Period 1,2,3,4,5* and so on, depending on the historical interpretation and classification of the objects.

To summarize and conclude, these FreeCAD data menu voices have been useful for the purpose of integrating a different kind of information referred to the architectural elements and stratigraphic units: the IFC ROLE has been used to define the architectural role of all BIM objects; the DESCRIPTION field has been filled with a general description concerning elements; MATERIAL property classified the material depending on visualizing and rendering parameters; STANDARD CODE defined the identification number of architectural elements and stratigraphic units depending on the right classification performed at the moment of the stratigraphic analysis; TAG optional text field has been used in order to include the historical interpretation of elements and then of the refectory.

These data menu voices have great importance inside FreeCAD, principally for two reasons: first of all, they permit the integration of different **properties** and **semantic information** concerning the elements; these features can be explored and investigated by performing custom **querying operations**, because inside FreeCAD the implementation of SQL language (as we will see on the following chapter) allows to analyse data based on custom needs.

| Proprietà        | Valore                           |
|------------------|----------------------------------|
| Base             | Extrude015                       |
| Clone Of         |                                  |
| Description      | Ultima Cena Fresco (XVI century) |
| Hi Res           |                                  |
| Horizontal Area  | 6,8100 m <sup>2</sup>            |
| Ifc Role         | Wall                             |
| Material         | Fresco                           |
| Move With Host   | true                             |
| Perimeter Length | 7,4000 m                         |
| Standard Code    | USR45                            |
| Subtractions     |                                  |
| Tag              | Period_4_1510_1525               |
| Vertical Area    | 9,4300 m <sup>2</sup>            |

Figure 233. FreeCAD left data menu component: in red the tag description concerning the historical interpretation of the element

Table 21. FreeCAD data menu and the compilation strategy

| FreeCAD data menu | Input type       | Compiled with                      |
|-------------------|------------------|------------------------------------|
| IFC Role          | Drop-Down Menu   | Role related to US and EA          |
| Description       | Free Text        | Description concerning US and EA   |
| Material          | Pop-Up Menu      | US and EA single or multi material |
| Standard Code     | Integer and text | Identification number of US and EA |
| Tag               | Free Text        | Historical interpretation          |



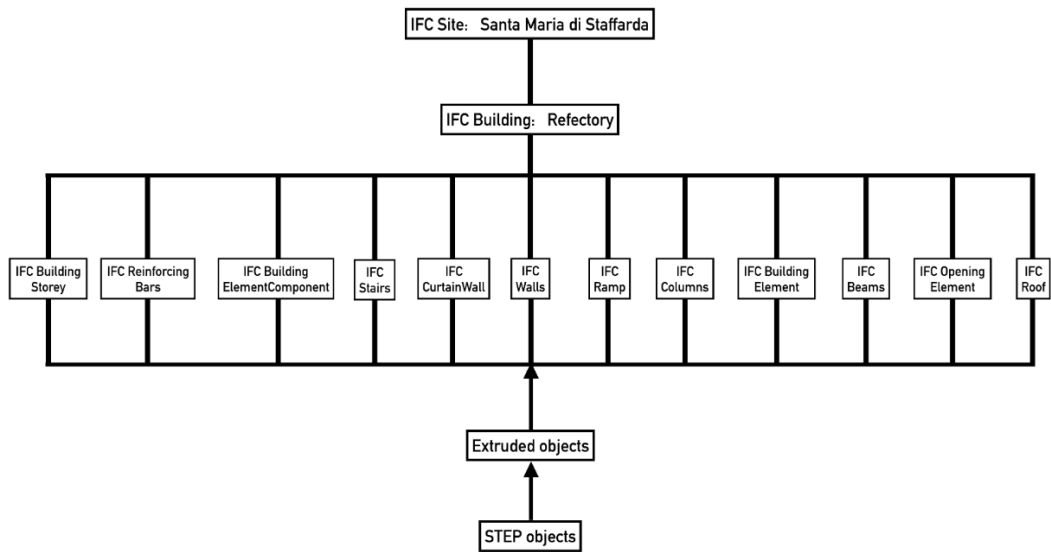

Figure 234. Dependencies graphic concerning IFC entities creation from STEP objects

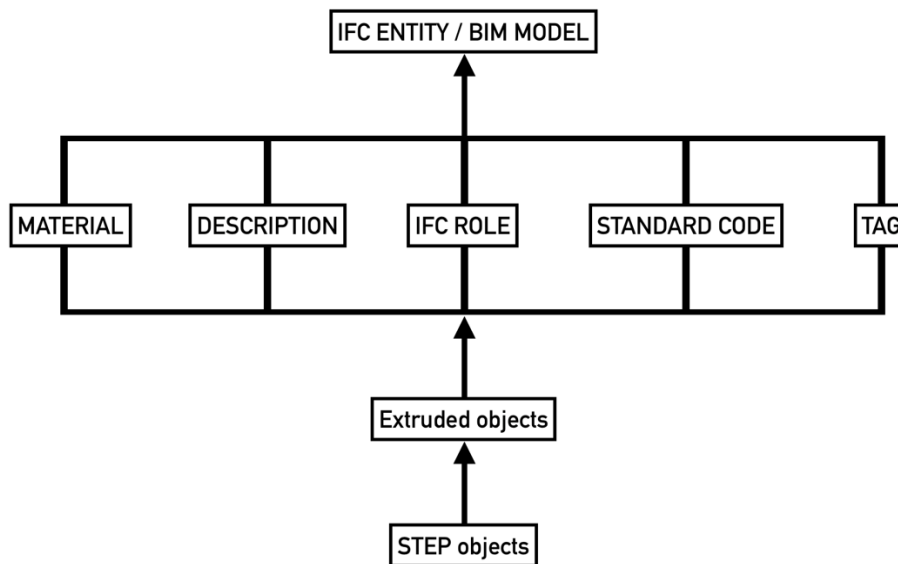

Figure 235. IFC entities creation and properties starting from STEP objects

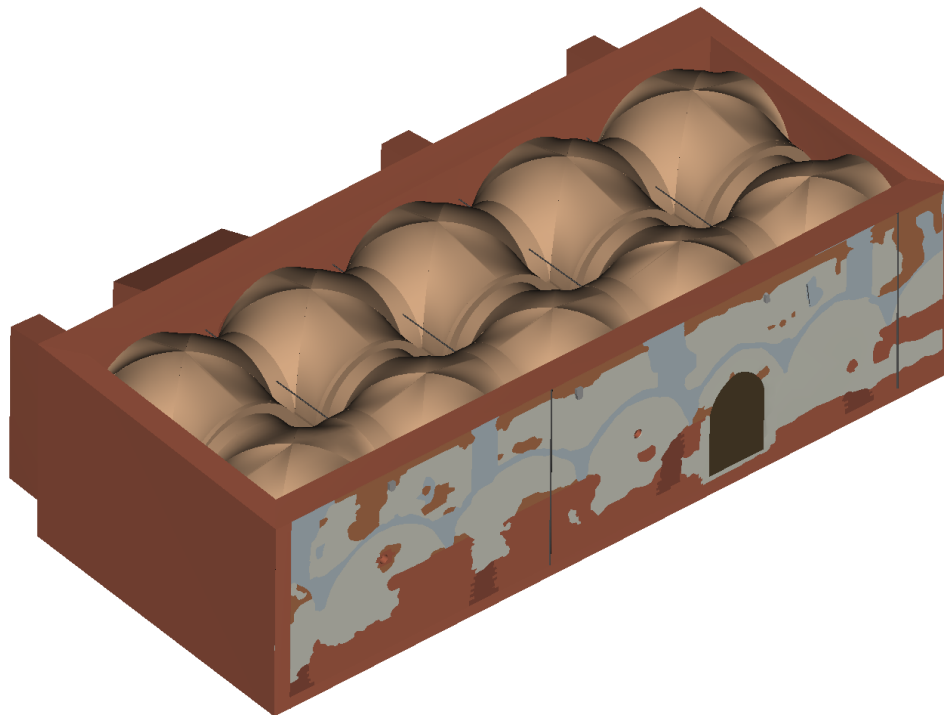

Figure 236. Overview on final BIM model of the refectory (cloister side) - (elaboration F. Diara).

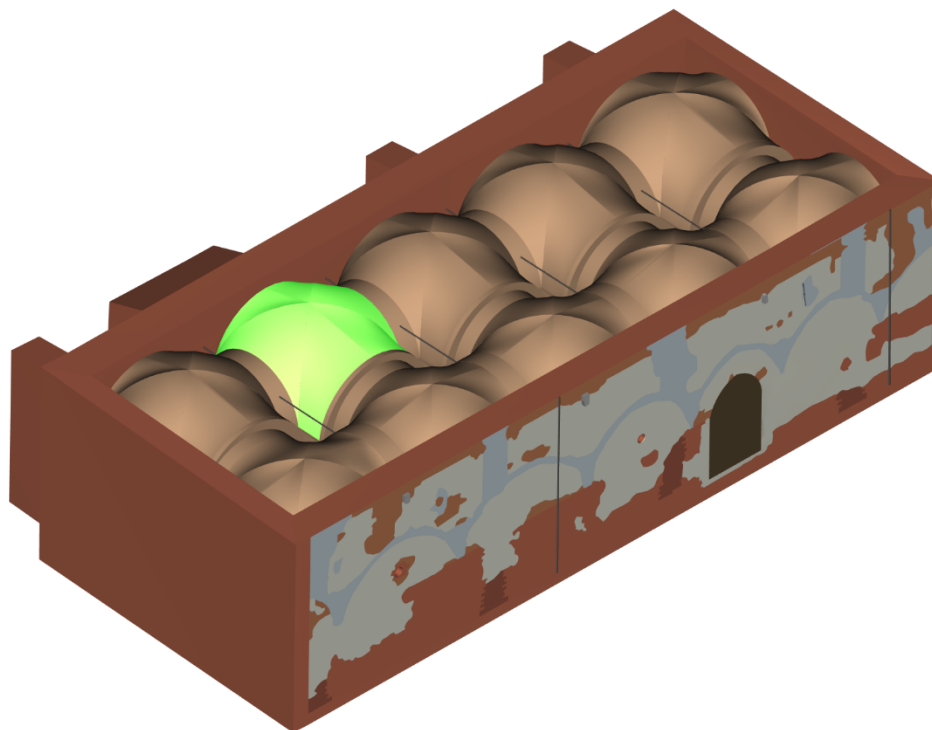

Figure 237. Refectory (cloister side): complex architectural elements - vaults system (elaboration F. Diara).

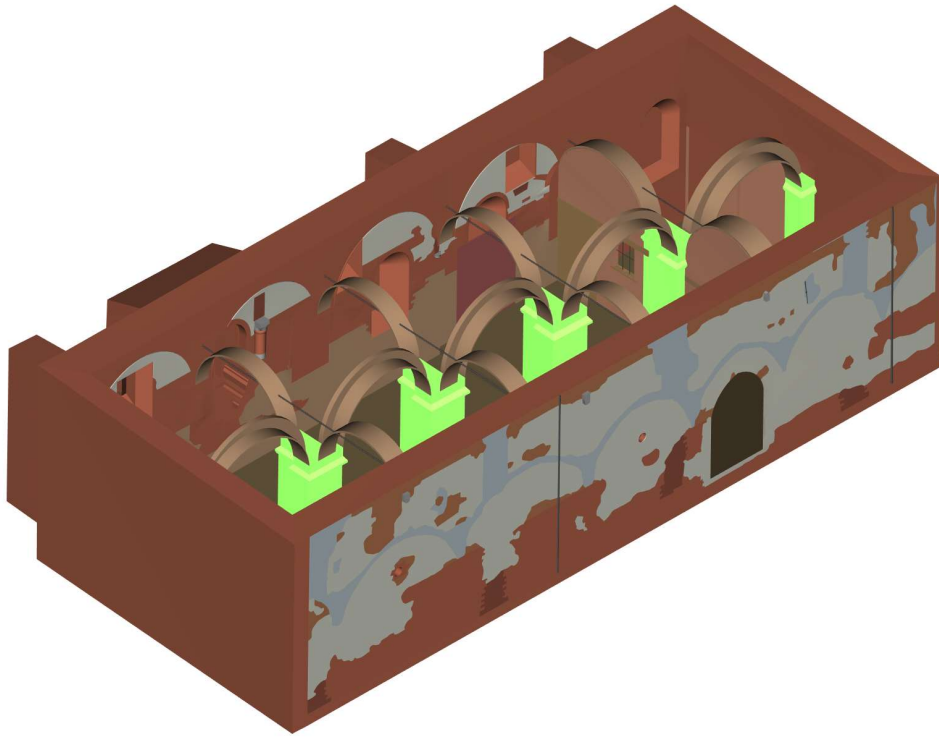

Figure 238. Refectory (cloister side): structural elements – pillars (elaboration F. Diara).

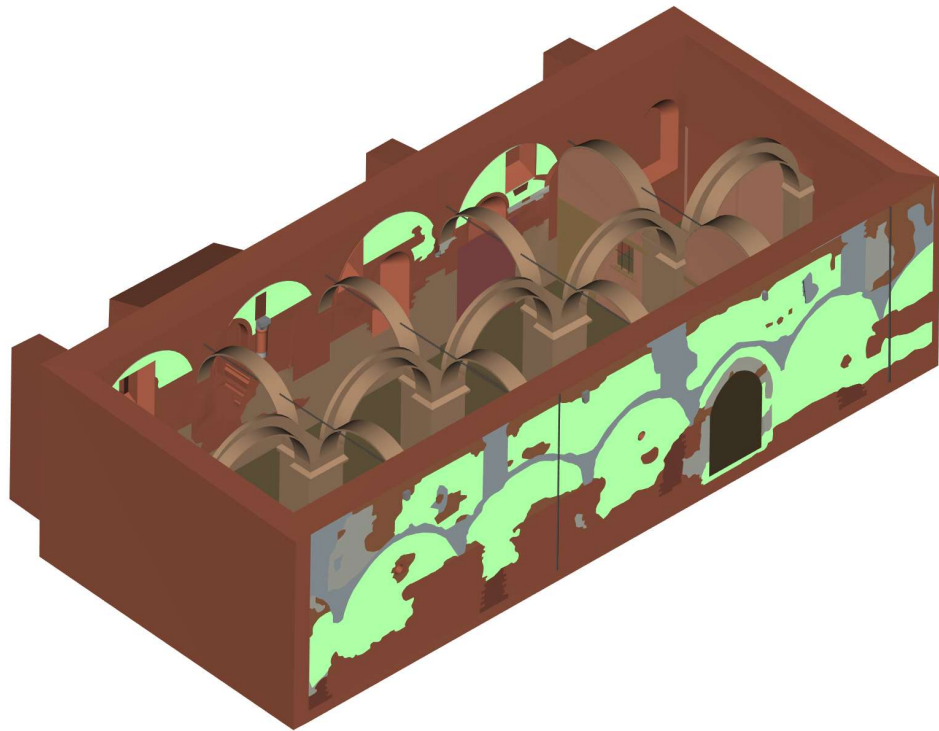

Figure 239. Refectory (cloister side): stratigraphic units selection (elaboration F. Diara).

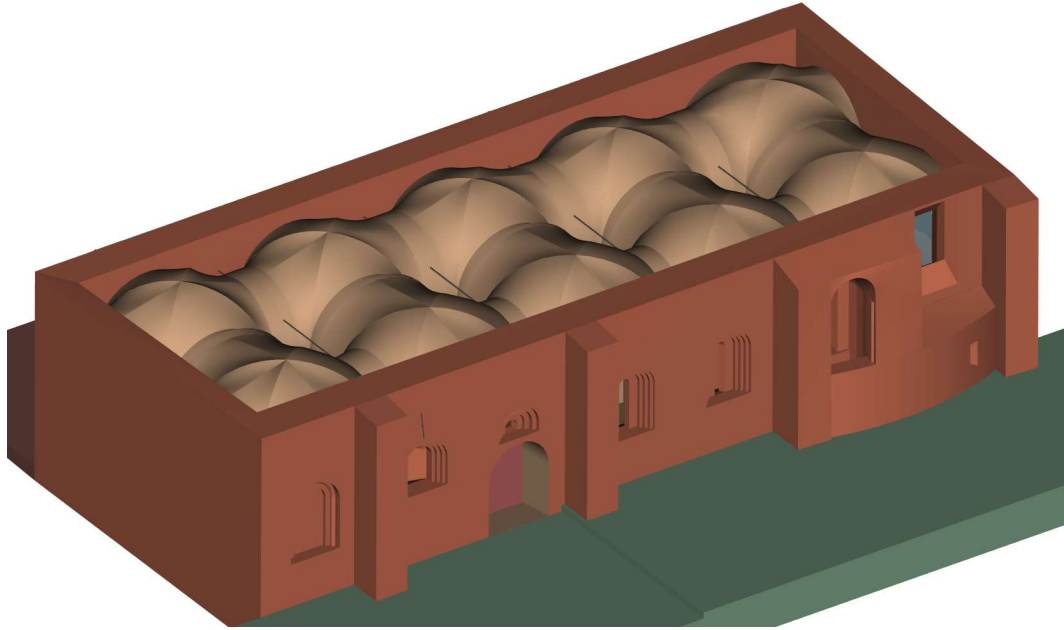

Figure 240. Overview on final BIM model of the refectory (backyard side) - (elaboration F. Diara).

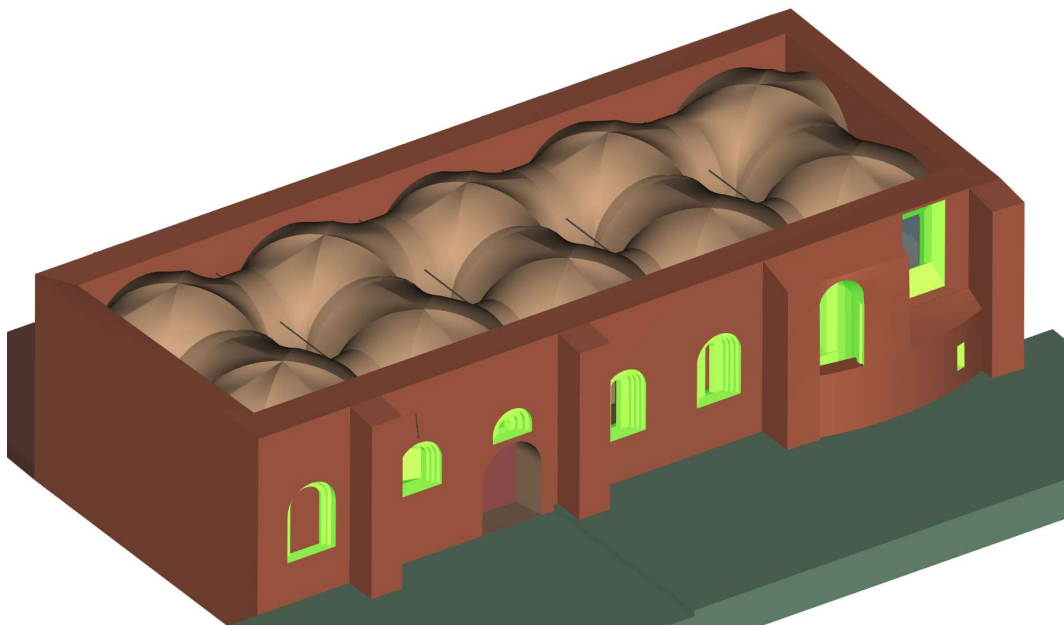

Figure 241. Refectory (backyard side): windows selection (elaboration F. Diara).

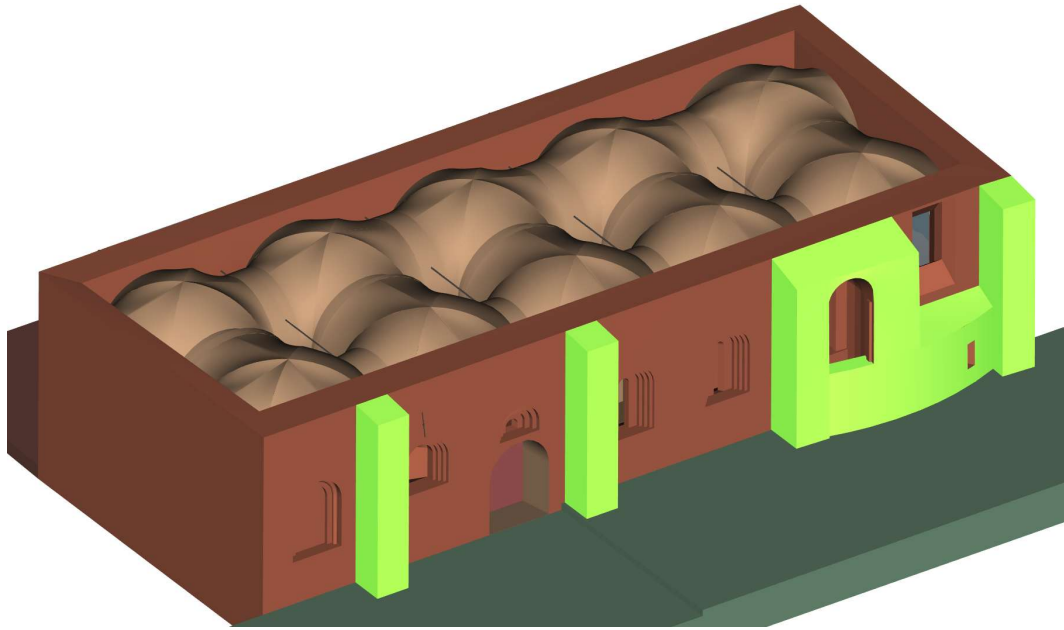

Figure 242. Refectory (backyard side): buttresses selection (elaboration F. Diara).

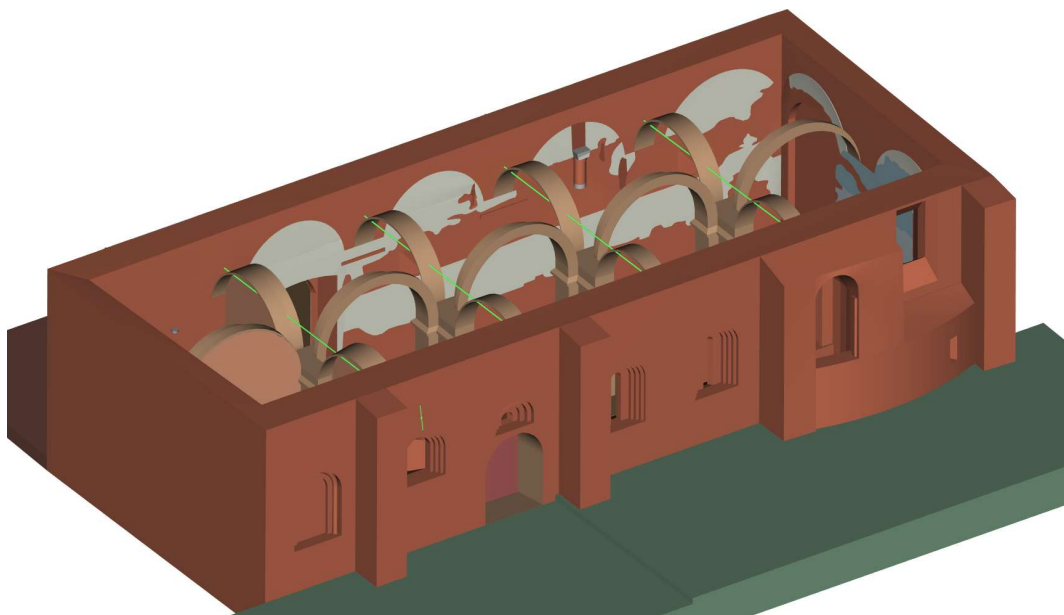

Figure 243. Refectory (backyard side): reinforcing anchors selection (elaboration F. Diara).

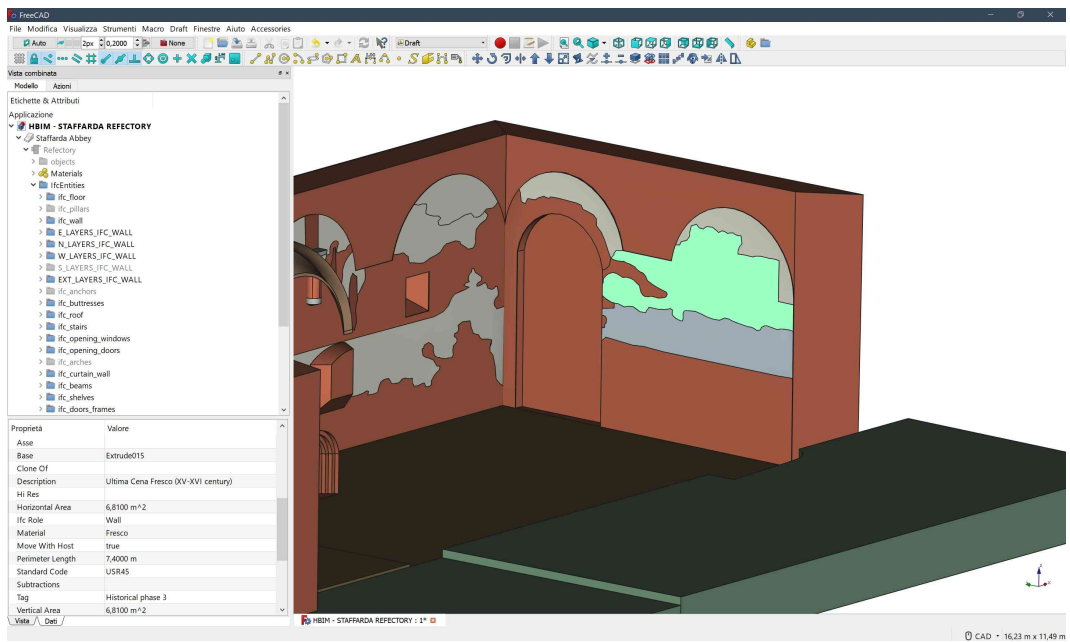

Figure 244. Overview on USR 45 fresco unit and data menu on the left (elaboration F. Diara).

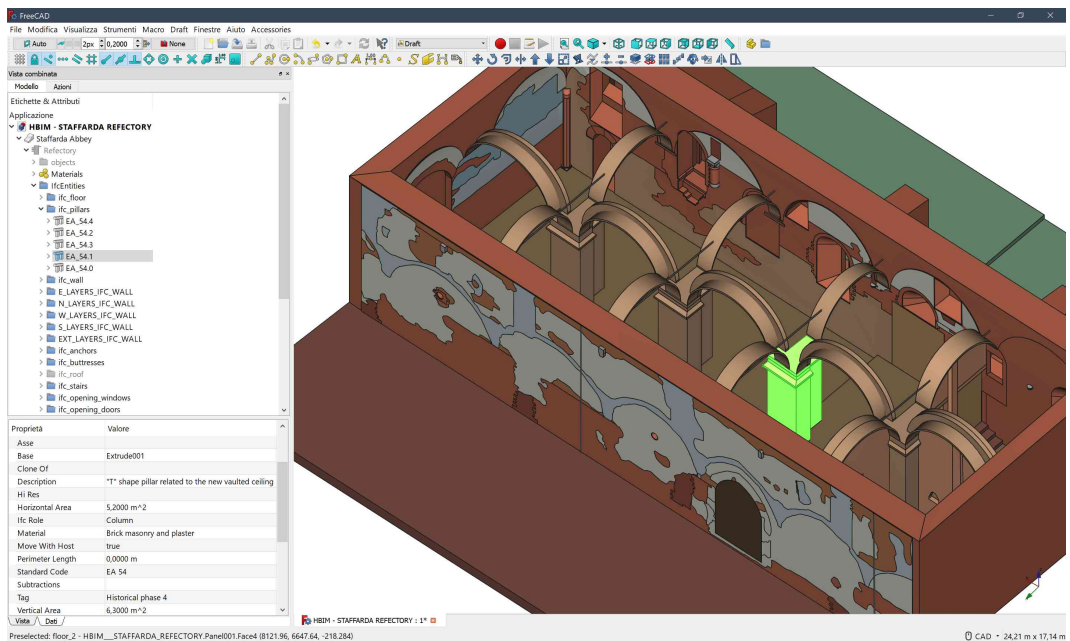

Figure 245. Overview on EA 54 pillar and its properties on data menu on the left (elaboration F. Diara).



Figure 246. Detail on a stratigraphic masonry unit and its properties on SimpleProperties Macro (elaboration F. Diara).

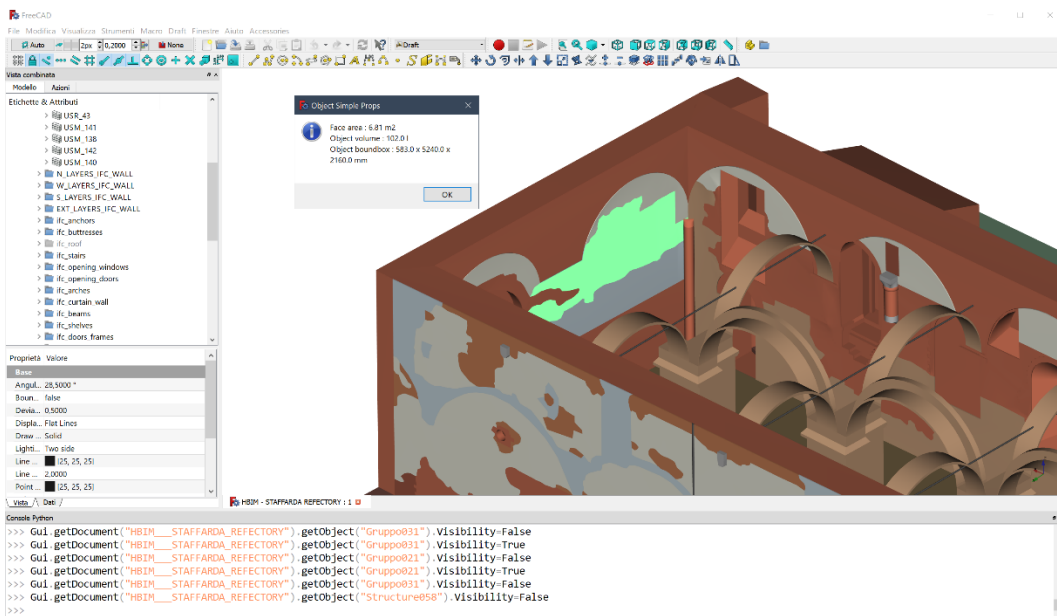

Figure 247. Fresco units and its properties on SimpleProperties Macro (elaboration F. Diara).

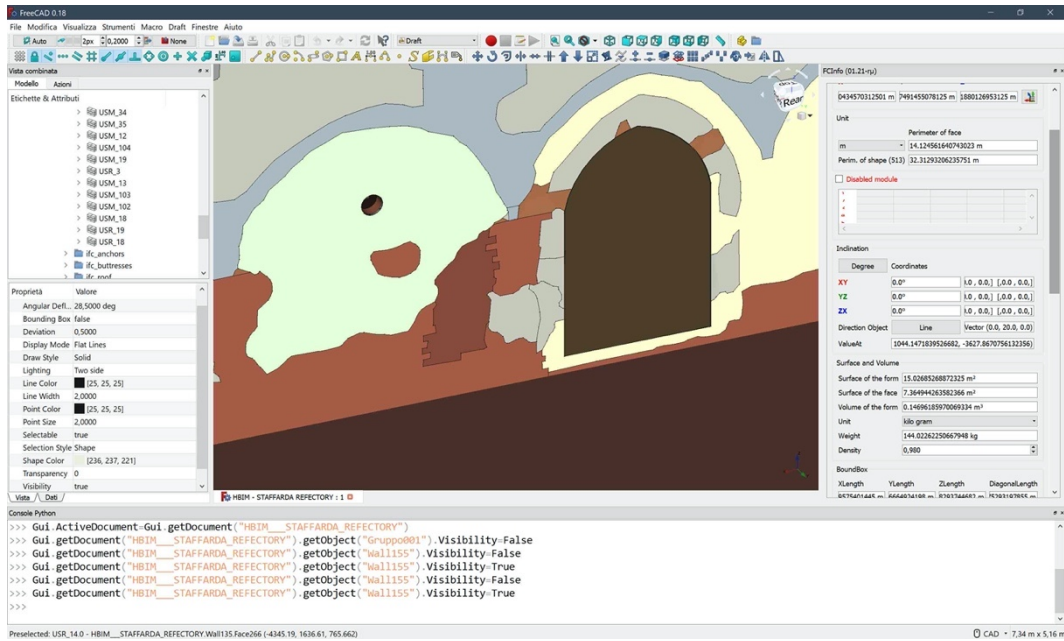

Figure 248. Overview on render / plaster unit and its properties on FCInfo Macro on the right (elaboration F. Diara).

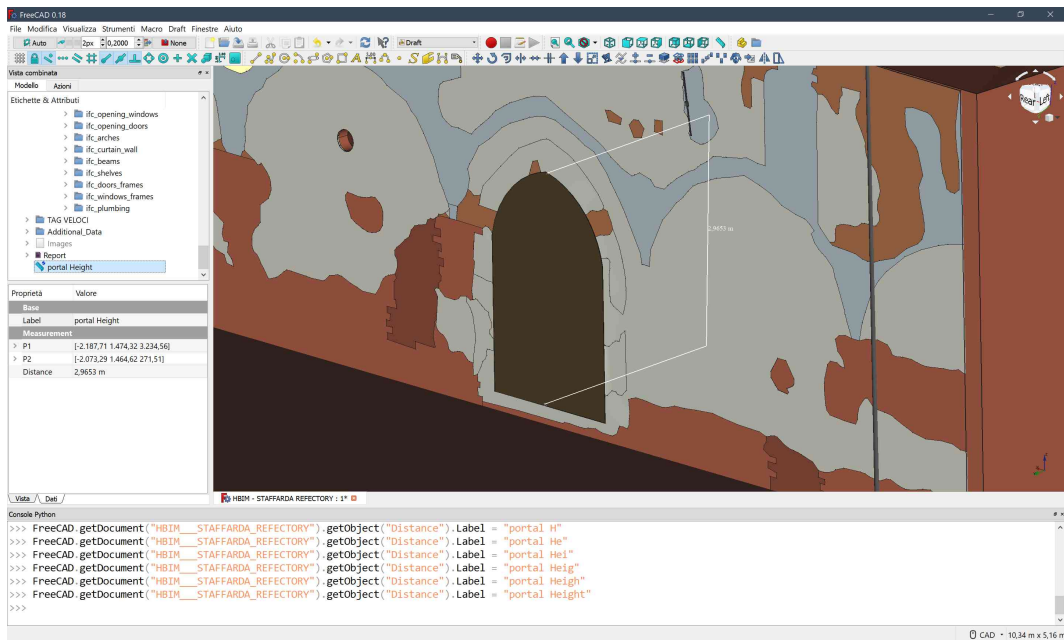

Figure 249. Portal height calculated by the measurement tool of FreeCAD (elaboration F. Diara).





# Chapter 11

## Semantic dimension and knowledge sharing

BIM methodology is focusing on the integration of heterogeneous information that creates and implement a semantic and oriented-based conceptual model (Brusaporci et al., 2018). In this sense, differences between historic buildings and new constructions consist of the architectural peculiarities (including transformations actions) as well as in the great amount and variety of information concerning historic buildings. Then, the BIM modelling and management require the semantic identification, description, recognition and interrogation of objects and different kinds of information (De Luca et al., 2011).

Actual BIM platforms, in addition to representing fundamental solutions concerning modelling and managing phases for AEC industry projects, shall be also considered necessary safety collectors of knowledge regarding parametric objects. Indeed, BIM software (commercial as well as FreeCAD) enable the connection between attributes and individual features to each parametric object which, through semantic classification processes, become architectural elements (as seen in the previous chapter). The semantic dimension, and then the information that can be achieved from BIM models, is the main actor inside BIM platforms and has a great importance as far as knowledge and sharing process are concerned (Murphy et al., 2009; Simeone et al., 2014).

The information inside a BIM project, besides the internal contribution, have to be planned in order to spread out the knowledge achieved. Moreover, this BIM data shall be investigated through the utilization of internal databases and custom querying operations, making possible (in addition to semantic relations) the on-demand comprehension and analysis depending on specific needs (Simeone et al., 2014; Diara et al., 2018).

Finally, can be argued that information are fundamental and distinctive features of BIM projects, which without a proper semantic contribution could be considered just modelling and representative projects, end in themselves and without real

purposes (De Luca et al., 2011; De Luca et al., 2014). Then, the combination of metric information with historic qualitative and data and knowledge, that might help the monitoring and consolidation phases, could be defined as a custom ontology concerning the refectory: in this sense, despite the original philosophic definition, the computer science definition of ontology<sup>41</sup> is essentially based on the information and knowledge description, comprehension and sharing process between the digital world (hardware and software) and who may use these data (Caciotti et al., 2014; Messaoudi et al., 2018).

As far as HBIM projects are concerned, the integration of **historical information** are a mandatory step especially because it could ease in addition to management and monitoring operations also enhancement processes, and, as we have seen, in this project historical information are concerning the chronological interpretation of the refectory starting from stratigraphic analysis, phases detection and chronological periods individuation (Beltramo et al., 2019a; Parisi et al., 2019). In this sense, represent and reproduce the objective state of art of historical buildings mean focusing also on semantic knowledge resulting from morphological and conceptual peculiarities as well as quantitative and qualitative data and finally time element (Caciotti et al., 2014; Historic England 2017).

## 11.1 Semantic data

As mentioned in the previous chapter, the semantic dimension inside FreeCAD has been set, in addition to the historical information (stratigraphic analysis and interpretation), also referring to **architectural classifications - materials – description – identification codes - tags**. This data organization guaranteed the right and required data implementation on the HBIM archiving system and this kind of repository could allow the managing processes as well as the sharing of the knowledge.

---

<sup>41</sup> From a philosophic point of view ontology is focusing on the study of being and of reality (Devaux et al, 2009)

|                                       |                  |                                  |
|---------------------------------------|------------------|----------------------------------|
| Matrix concerning the unit            | ● Additions      | East_Matrix                      |
|                                       | Asse             |                                  |
|                                       | Base             | Extrude015                       |
|                                       | Clone Of         |                                  |
| General description of the unit       | ● Description    | Ultima Cena Fresco (XVI century) |
| Detailed photo attached               | ● Hi Res         | Fresco detail                    |
|                                       | Horizontal Area  | 6,8100 m <sup>2</sup>            |
| IFC classification                    | ● Ifc Role       | Wall                             |
| Material of the object                | ● Material       | Fresco                           |
|                                       | Move With Host   | true                             |
|                                       | Perimeter Length | 7,4000 m                         |
| Stratification identification numbers | ● Standard Code  | USR_45                           |
|                                       | Subtractions     |                                  |
| Chronological period                  | ● Tag            | Period_4_1510_1525               |
|                                       | Vertical Area    | 6,8100 m <sup>2</sup>            |

Figure 250. IFC object properties and parameters inside FreeCAD HBIM platform

### 11.1.1 Architectural entities and materials

A first and required semantic classification refers to architectural entities obtained after the extrusion operations of PART objects. The semantic classification of architectural elements involves, as we have seen, the simplification and standardization of the uniqueness and irregularities of historical buildings, and these operations could reduce the time realization steps inside a custom workflow.

Then, through this semantic classification performed by according to IFC schemas IFC2X3 and IFC4.1, extruded objects, in addition to have a geometric value, can be clustering in typological architectural sub divisions in order to achieve a new level of meaning (Macher et al., 2017). This classification, as already mentioned, is based on technical standards used on the AEC industry: in this sense, the IFC open format, regularized by the normative ISO 16739, is composed by header section, types, entities, functions, and rules referred to construction (Lee et al., 2014). This kind schematic regularization leads of us to consider IFC open format as considered a dynamic database, making possible relations among features (Diara et al., 2018).

As mentioned in previous chapter, in order to test and overcome the IFC schemas standard classification two different operative lines have been carried out: first of all a standard attribution of FreeCAD IFC ROLE classification, following ISO normative and standards have been conducted, and, as we have seen, it caused

an important adaptation as far as the refectory architectural elements are concerned; second operative actions have been carried out by managing a custom attribution and then overlooking the ISO standards and perceiving as proposal demonstrative attribution.

Table 22. IFC ROLE classification referred to the first attribution (ISO normative and standards)

| <b>IFC ENTITY</b>           | <b>ASSIGNED TO</b>                  |
|-----------------------------|-------------------------------------|
| IfcSite                     | Santa Maria di Staffarda abbey      |
| IfcBuilding                 | Refectory                           |
| ifcBuildingStorey           | Six floor / ground levels           |
| IfcRamp                     | Height difference on the ground     |
| IfcRoof                     | Groined Vaults                      |
| IfcWall                     | Walls and stratigraphic units       |
| IfcCurtainWall              | Filled entrances and windows        |
| IfcColumn                   | Pillars and the cornering column    |
| IfcOpeningElement           | Windows and portals                 |
| IfcBeam                     | Wooden beam and the windowsill      |
| IfcStair                    | Stairs and steps                    |
| IfcReinforcingBar           | Reinforcing anchors                 |
| IfcBuildingElement          | Buttresses and arches               |
| IfcBuildingElementComponent | Semi-columns and shelves / brackets |

Table 23. IFC ROLE classification referred to the second custom attribution

| <b>IFC ENTITY</b> | <b>ASSIGNED TO</b>              |
|-------------------|---------------------------------|
| IfcSite           | Santa Maria di Staffarda abbey  |
| IfcBuilding       | Refectory                       |
| ifcBuildingStorey | Six floor / ground levels       |
| IfcRamp           | Height difference on the ground |

|                             |                                      |
|-----------------------------|--------------------------------------|
| <b>IfcVault</b>             | Groined Vaults                       |
| IfcWall                     | Walls                                |
| <b>IfcUSM</b>               | Masonry stratigraphic units          |
| <b>IfcUSR</b>               | Render / plaster stratigraphic units |
| IfcCurtainWall              | Filled entrances and windows         |
| IfcColumn                   | Cornering column                     |
| <b>IfcPillar</b>            | Pillars                              |
| IfcOpeningElement           | Windows and portals                  |
| IfcBeam                     | Wooden beam and the windowsill       |
| IfcStair                    | Stairs and steps                     |
| IfcReinforcingBar           | Reinforcing anchors                  |
| <b>IfcButtress</b>          | Buttresses                           |
| <b>IfcArch</b>              | Arches                               |
| IfcBuildingElementComponent | Semi-columns and shelves / brackets  |

Directly linked to the first classification there is the material information mapping. Indeed, as far as materials are concerned, due to the not performed deep analyses on materials properties (especially since it was not the goal of the project), the refectory materials have been classified and managed referring the visualization and rendering point of view, in addition to the evident semantic point of view<sup>42</sup>. Indeed, inside the FreeCAD platform have been included custom materials and short description by using the already seen MATERIAL EDITOR TOOL: *Brick masonry (thin mortar joint); Brick masonry (large mortar joint); Stone; Brown wood; Dark wood; Plaster; Fresco; Render; Clay ground; Brick floor; Grass ground; Modern brick masonry; Metal; Brick masonry and plaster; Lack of material.*

The previous properties concerned IFC objects, are characterized for being customizable features, despite the already mentioned limitations as far as the IFC schemas are concerned: in fact, IFC roles can be editable by re-coding the local IFC2X3 schema using for example Notepad++ and then verifying the right modification inside the platform through the drop-down menu; by contrast the

---

<sup>42</sup> The material analysis of the refectory is reported on TAV.3-7-11-15-19.

materials database can be correctly extended by using the specific tool, in this way specific materials can be assigned to object through the database material list.

### 11.1.2 Stratigraphic units and analysis

In addition to basic semantic data concerned metric information, architectural and material classification the most important information inside this project is referred to **historical information**, which is divided into stratigraphic analysis and the consequently chronological interpretation.

As we have seen in previous chapters, the schematic workflow regarding management of stratigraphic units can be resumed in this way: the required and mandatory on field analysis of units was the first step and subsequently their documentation through photogrammetric and LiDAR surveys; the second step has been performed for the purpose of mapping and analysing stratigraphic units on 2D CAD environment through the support of orthophotos derived from previous surveys; the three-dimensional mapping of units on the NURBS model was the next step and it has regarded the stratigraphic units modelling on the main architectural model; then the 3D NURBS objects concerning each stratigraphic units have been imported on FreeCAD BIM platform and have been parametrized for the purpose of obtaining BIM objects including the IFC compatibility.

Moreover, the interpretation step concerning stratigraphic units and relative chronological phases and periods has been performed after first on field surveys and especially after the 2D CAD analysis on orthophotos and the consequently creation of matrices diagrams, necessary tool and methodology for the relative and absolute chronological interpretation.

Differently from the previous data, this information need another integration methodology. Indeed, this kind of information, derived from studies and analyses performed externally from the HBIM platform, could be included through free text strings inside the IFC objects properties menu. In this sense stratigraphic units have been imported on FreeCAD environment and managed as parametric shapes, then the resulted objects have been named depending on identification numbers and reference units (USM\_1, USR\_1, EA\_1 and so on), furthermore, objects related to stratigraphic units have been stored on specific folder on model tree depending on walls order. In this way, by clustering objects by walls and reference numbers it has been possible to obtain tidy management. Furthermore, a proper integration

methodology has been found by using the IFC properties on FreeCAD menu: in this regard, a concise description of units has been stored on the DESCRIPTION field and the identification numbers of units, established during stratigraphic analysis, has been set on STANDARD CODE field and this classification has been useful also for the purpose of quickly recognize and find out the required unit or object.

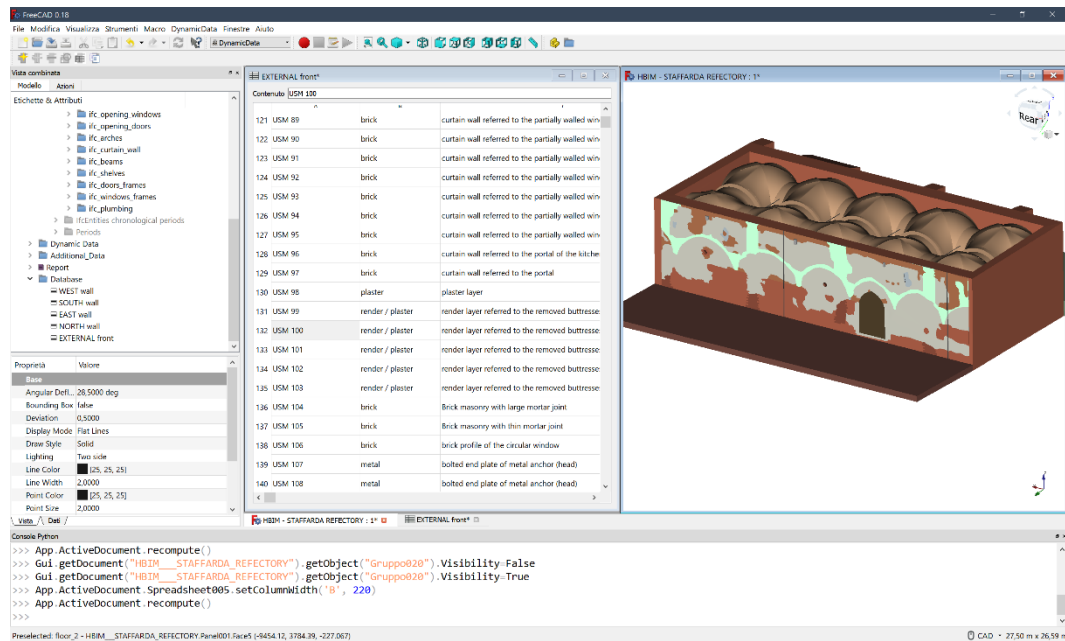

Figure 251. Stratigraphic units database inside FreeCAD (elaboration F. Diara).

The physical stratigraphic relations among units have been included through the integration of stratigraphic diagrams (matrix) as well as the chronological interpretation carried out by using matrices: in fact, the created Harris' matrices have been imported as pictures elements on refectory model tree and they have been clustered in *stratigraphic\_analysis* folder and arranged depending on single walls and fronts. Moreover, this unconventional data results fundamental because it can be integrated on properties of IFC objects, in fact, matrices concerning each wall have been included as hyperlink on ADDITIONS attribute of single IFC object related to stratigraphic units.

Moreover, descriptive and detailed photographs concerning internal and external walls and stratigraphy have been imported and managed as pictures elements inside FreeCAD, and these pictures have been attached as attribute by using the HI RES field on the left menu of IFC objects. In addition to photographs regarding internal and external walls, inside the platform has been also stored



iconographic resources and drawings (in this case the Cesare Bertea drawing) as well as bibliographic references referred to Staffarda and the refectory. In this regard, despite iconographic resources have been collected obviously as pictures, the bibliographic references have been stored into a datasheet inside the folder *additional\_data*.

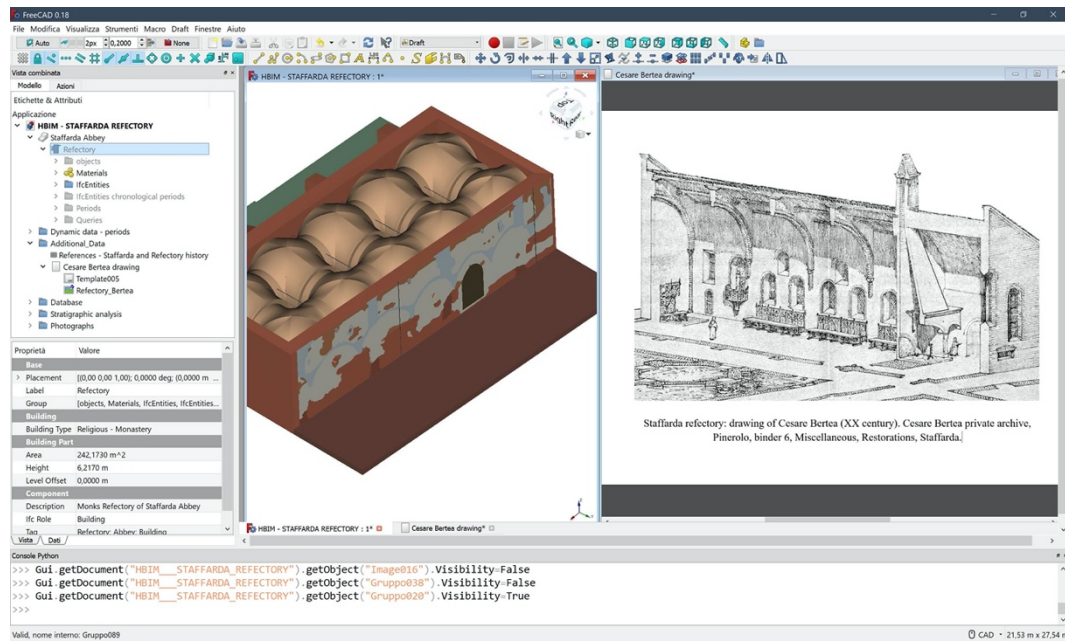

Figure 252. Iconographic sources of the refectory inside FreeCAD platform (elaboration F. Diara).

Acting in this way the traditional 2D documentation regarding stratigraphic analysis, often disconnected by the context and then from the 3D documentation as well as also often unpublished and secure kept on researchers' drawers, has been included and integrating directly on 3D HBIM model and on single objects, enriching the platform also with non-conventional information.

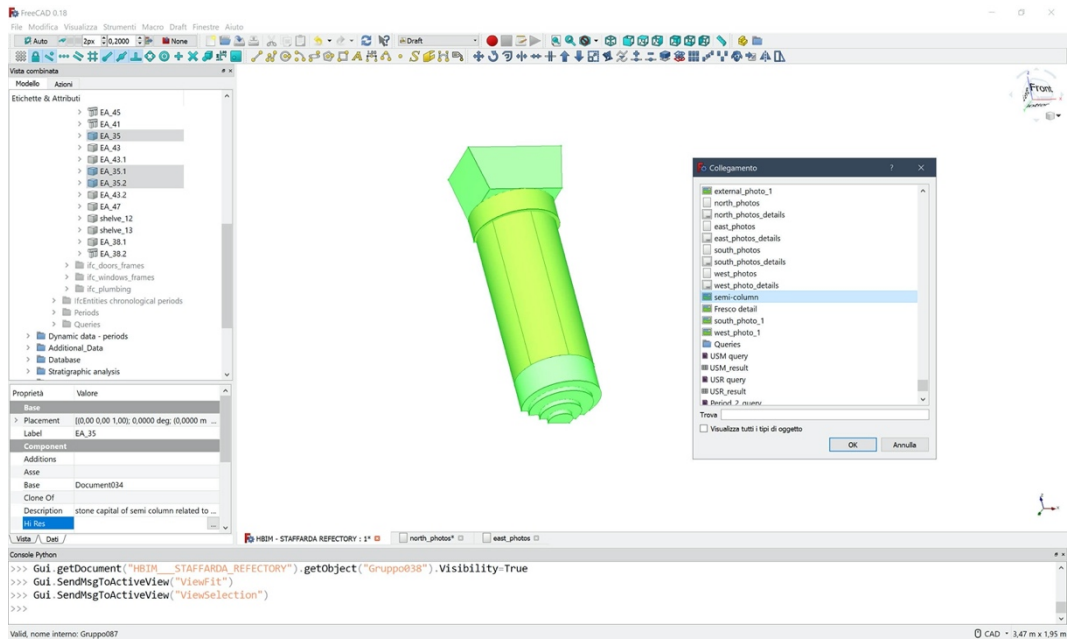

Figure 253. Image attribution to specific element: semi-column (elaboration F. Diara).

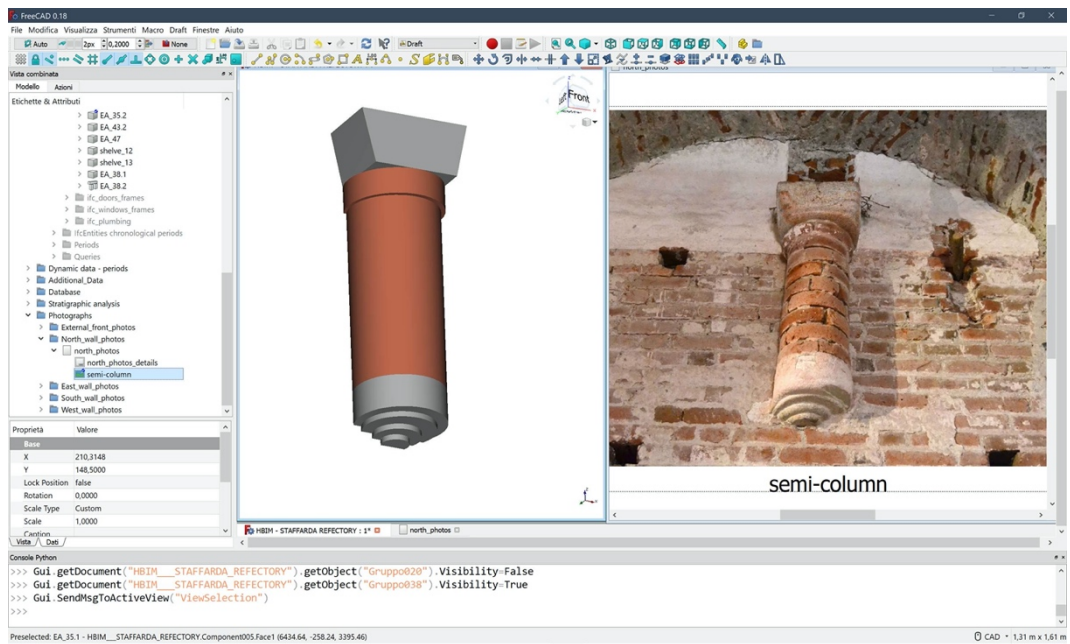

Figure 254. Semi-column and its reference image attached to the object (elaboration F. Diara).

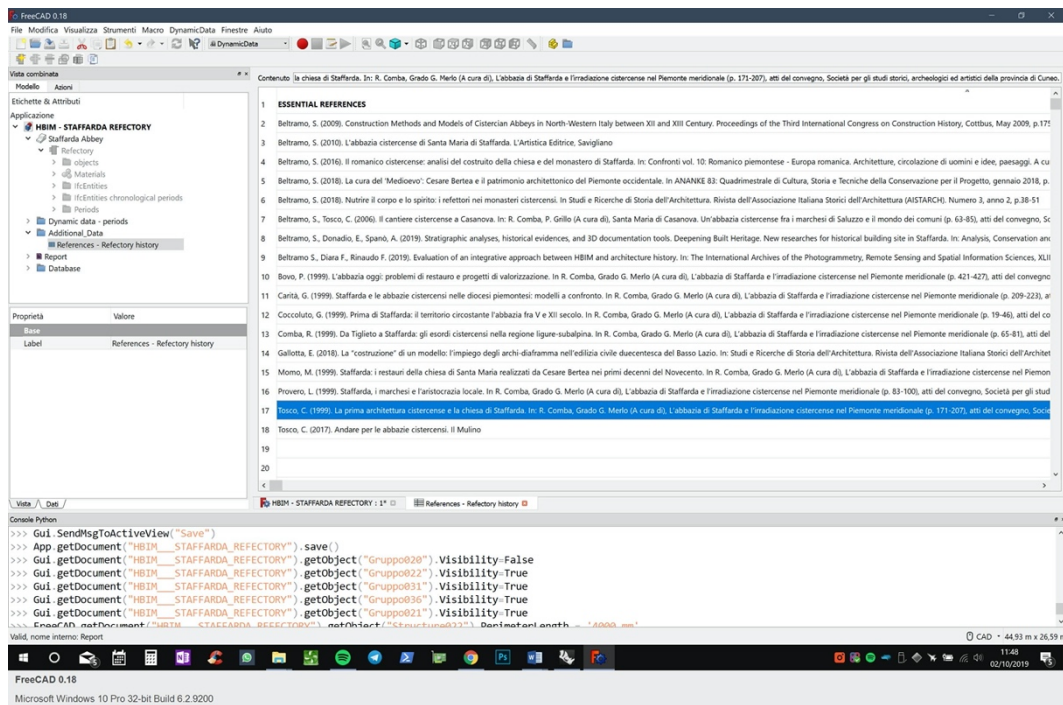

Figure 255. Bibliographic resources inside the FreeCAD database (elaboration F. Diara).

### 11.1.3 Historical interpretation

Historical interpretation of stratigraphic units and of the refectory has been performed through the utilization of descriptive and representative methods. The inclusion of time element inside the semantic data is fundamental (De Luca et al., 2011; De Luca et al., 2014) in order to understand the temporal fragmentation of the refectory and represent its evolution over the time. In this sense, a representative documentation method concerns the inclusion of Harris' matrices as far as the relations interpretation is concerned, indeed, stratigraphic diagrams including the subjective interpretation concerning phases and periods have been imported as pictures elements on the already mentioned *stratigraphic\_analysis* folder on the model tree (it includes three files: simple matrix; matrix with phases; matrix with chronological periods), and exactly as normal matrices, they have been integrated on IFC objects as a hyperlink on the ADDITIONS attribute. Furthermore, the chronological interpretation has been highlighted by using custom colours on 3D visualization of IFC objects, and the colour choice was depended by the same colours used for the interpretation rows on matrices.

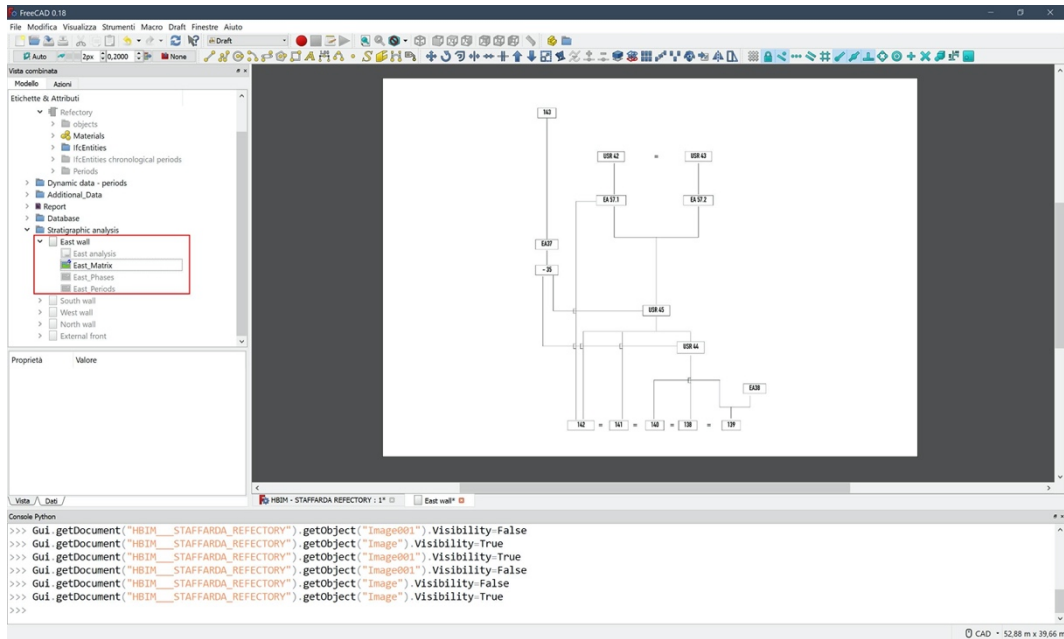

Figure 256. Matrix of east wall inside the FreeCAD archive (elaboration F. Diara).

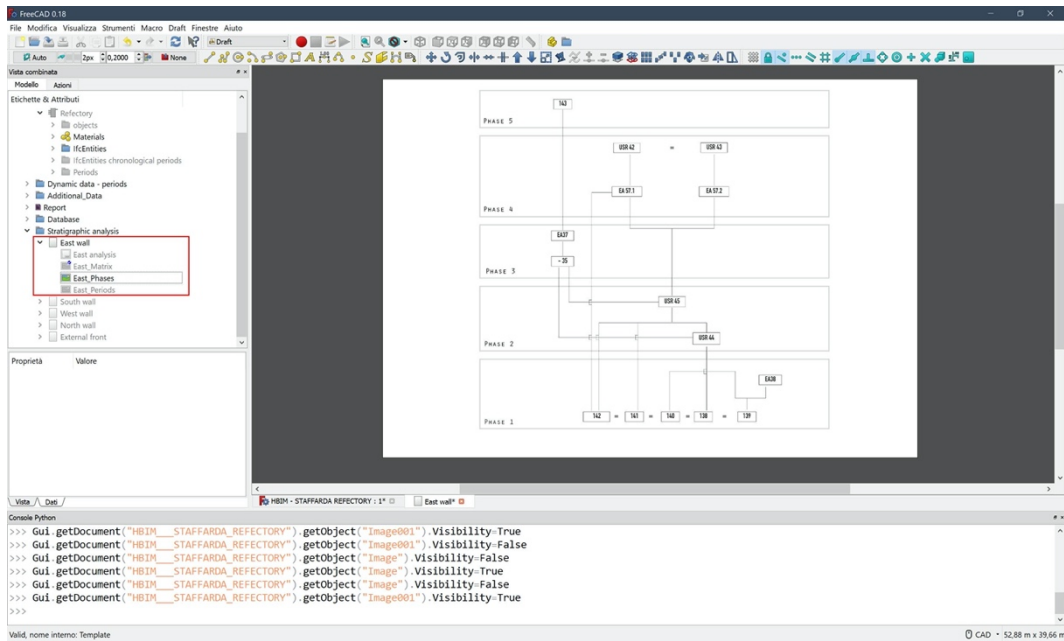

Figure 257. Matrix and phases of east wall inside the FreeCAD archive (elaboration F. Diara).

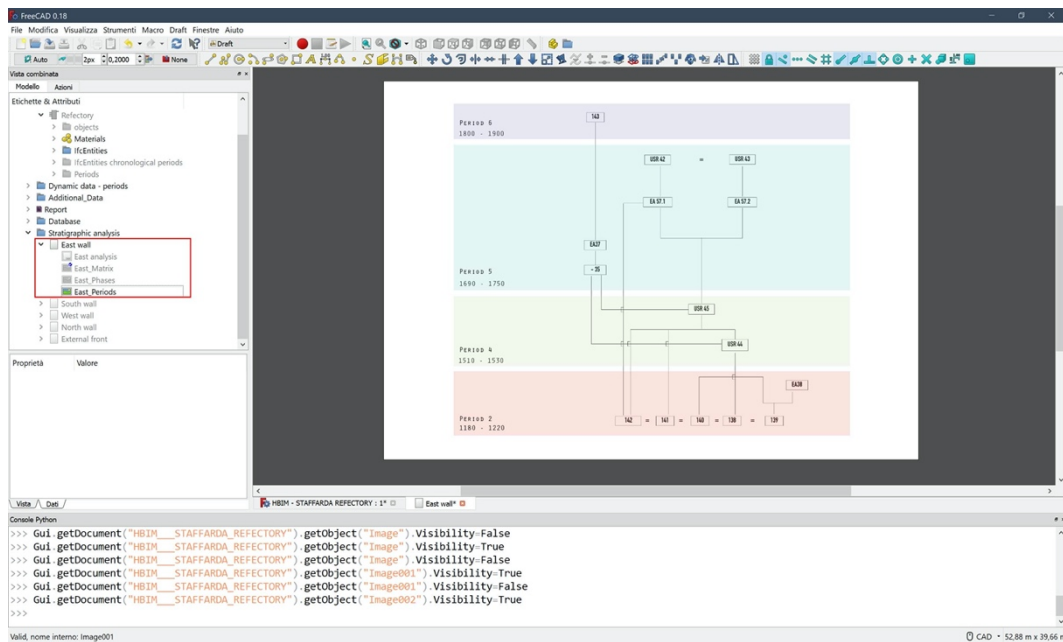

Figure 258. Matrix and chronological periods of east wall inside the FreeCAD archive (elaboration F. Diara).

The chronological interpretation of units and then of the refectory can be also stored on the TAG field as a descriptive method. As already mentioned, inside FreeCAD the TAG text field has been set for the purpose of integrating the chronological interpretation of the refectory and this step has been aided through the utilization of another useful additional tool, the DYNAMIC DATA workbench. In fact, the TAG text field has been compiled once the dynamic objects have been set: through the utilization of this workbench have been created dynamic objects called “Period 2”, “Period 4”, “Period 5”, “Period 6”, “Period 7” which include a short text description of chronological periods, especially concerned specific dates. Periods 1 and 3 are not included on the BIM platform because, as already mentioned, do not occur on the refectory area: in fact, Period 1 is referred to the suspended arches on the upper right part of the external front (outside the refectory area) while Period 3 is related to the other suspended cross arches on the central upper part of the external front beyond the refectory limits.

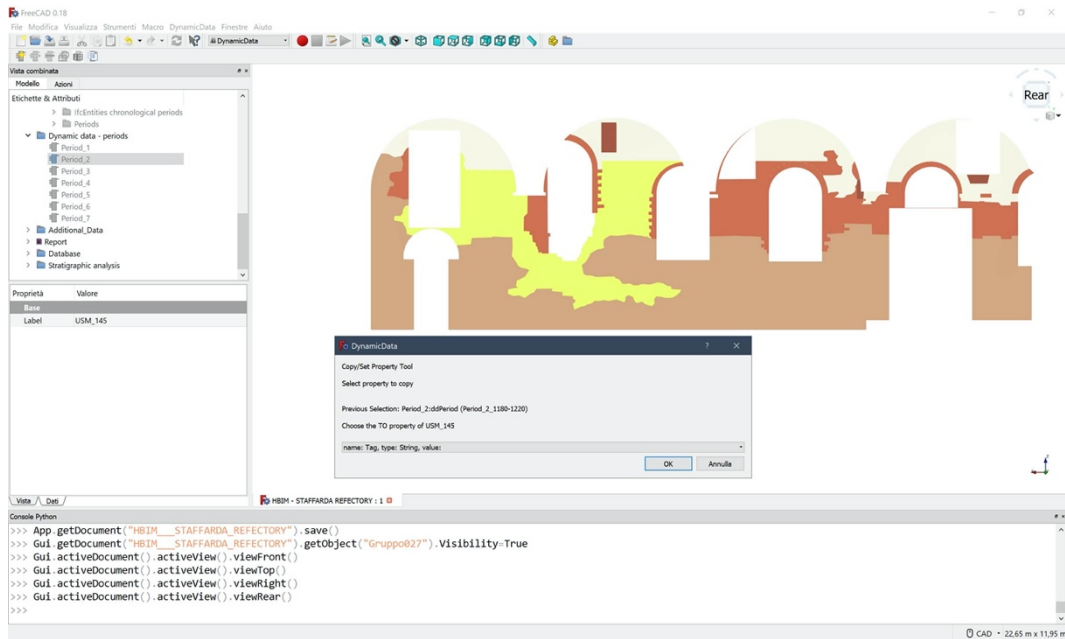

Figure 259. Specific Tag attribution through the dynamic data tool: period 2 to USM 145 (elaboration F. Diara).

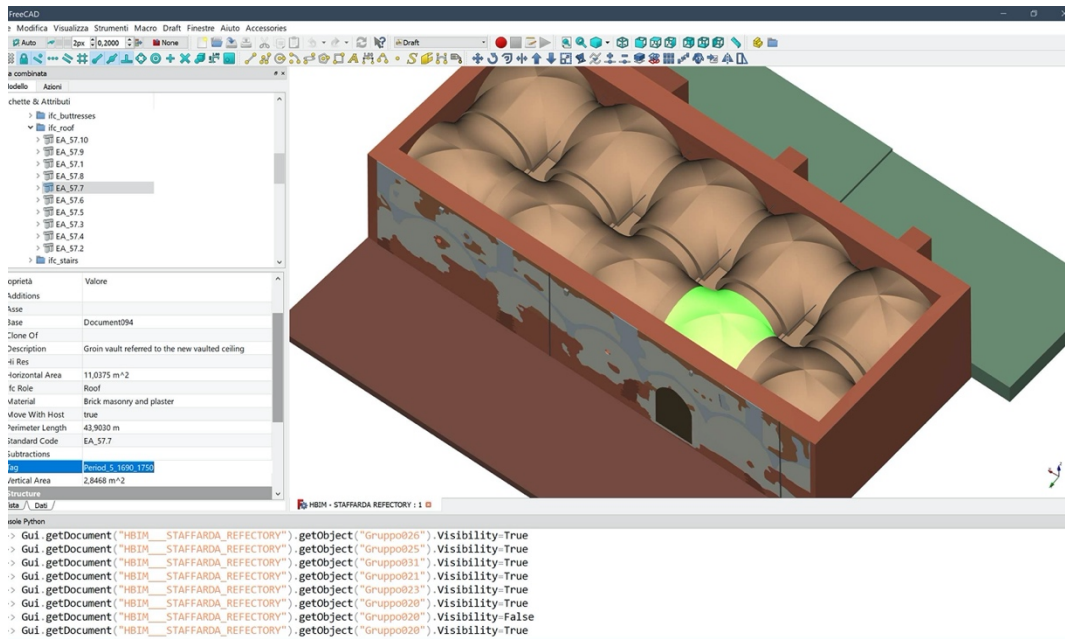

Figure 260. Chronological period into Tag text field: period 5 for groin vaults (elaboration F. Diara).

Table 24. Stratigraphic units and analysis on FreeCAD and the integration methodology

| <b>Stratigraphic units and analysis</b> | <b>Integration methodology</b> |
|---|--------------------------------|
| 3D shapes of stratigraphic units        | Parametric modelling           |
| Description of units                    | Free text DESCRIPTION field    |
| Identification numbers for units        | Object label, STANDARD CODE    |
| Photographs                             | Pictures imported              |
| Stratigraphic diagrams (Matrix)         | Pictures imported              |
| Historical interpretation               | Pictures imported, TAGs        |

Once created these objects, individual chronological periods have been assigned as properties to specific IFC objects into the TAG text field, depending on the historical interpretation carried out after the stratigraphic analysis (see chapters 7 and 8). Moreover, each chronological period have been also classified by using specific colours, based on the chronological interpretation colouring carried out during the analyses on stratigraphic diagrams (Matrix) and then the assigned colour was automatically also assigned to related IFC objects. In this way, the graphical representation of historical periods through architectural elements and stratigraphic evidences were possible, easing the global comprehension of the historical evolution of the refectory inside the FreeCAD HBIM platform.

Then, the HBIM semantic dimension here represented is based on the integration and connection between the IFC entities and the related information through different annotations (syntactical implementation) and integration methodologies. Then, the inclusion of particular information inside the platform, such as the 2D documentation concerning photographs, helps the general comprehension of the refectory and its peculiarities, and this integration step has been performed manually, by uploading and connecting 2D data to IFC objects.

This resulted ontological-based model integrates and supports different quantitative (real time measurements) and qualitative data that have to be managed and investigated through ad-hoc analysis, for example relational and selective queries, for the purpose of ensuring the future studies, analyses and maintenance operations (Diara et al., 2019; Yang et al., 2019).

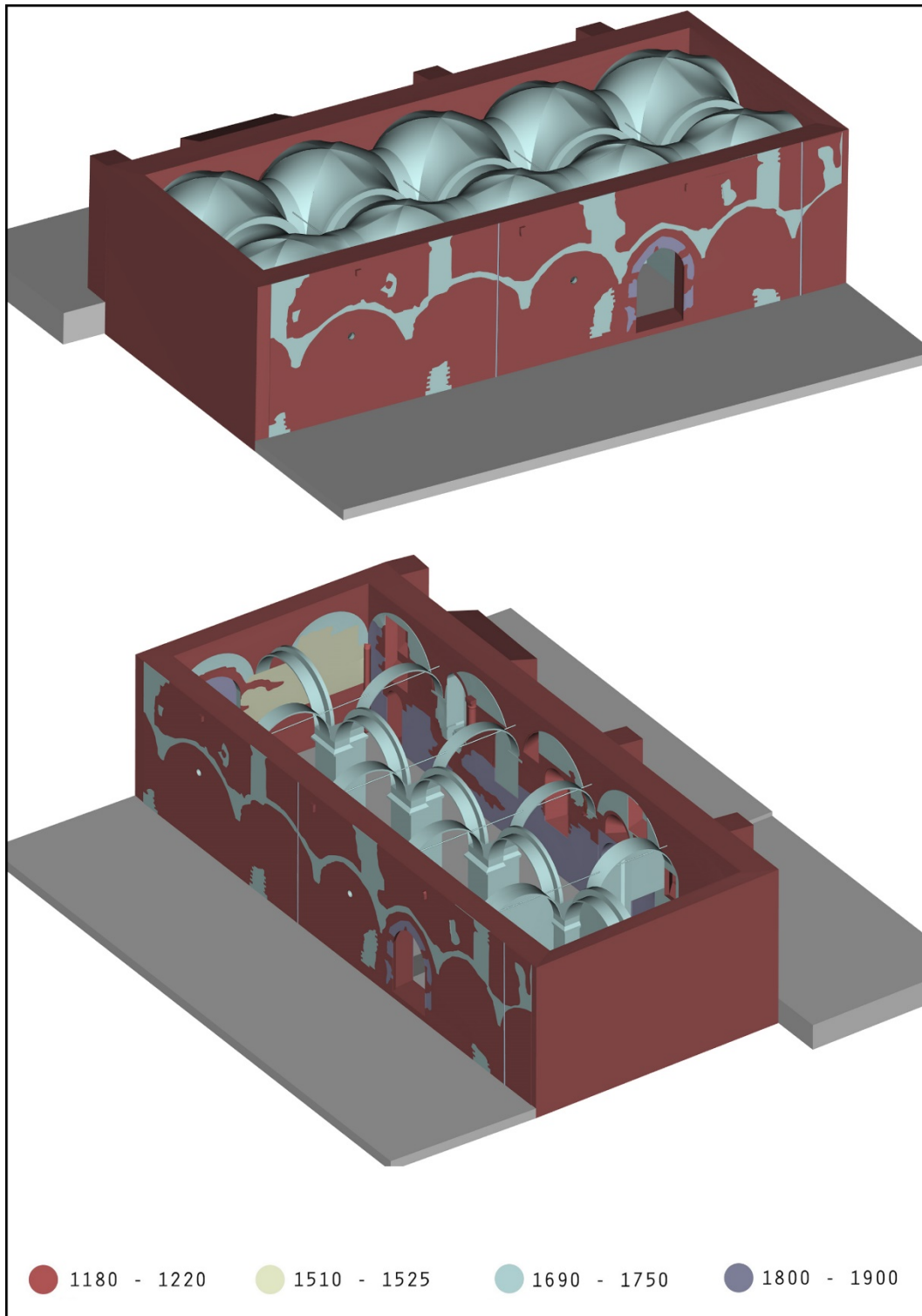

Figure 261. Details of chronological periods and units of the refectory (HBIM model) - (elaboration F. Diara).



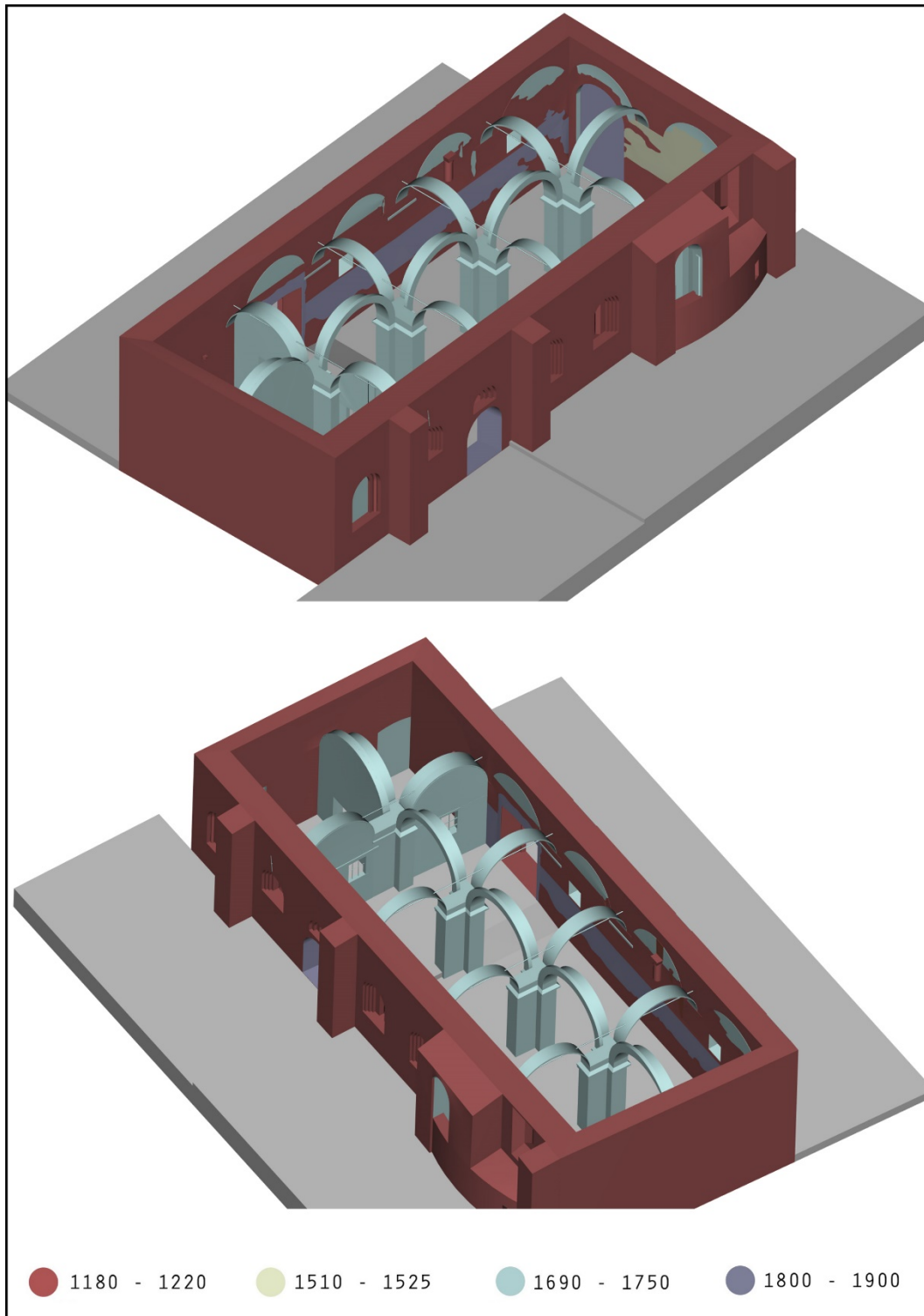

Figure 262. Details of chronological periods and units of the refectory (HBIM model) - (elaboration F. Diara).

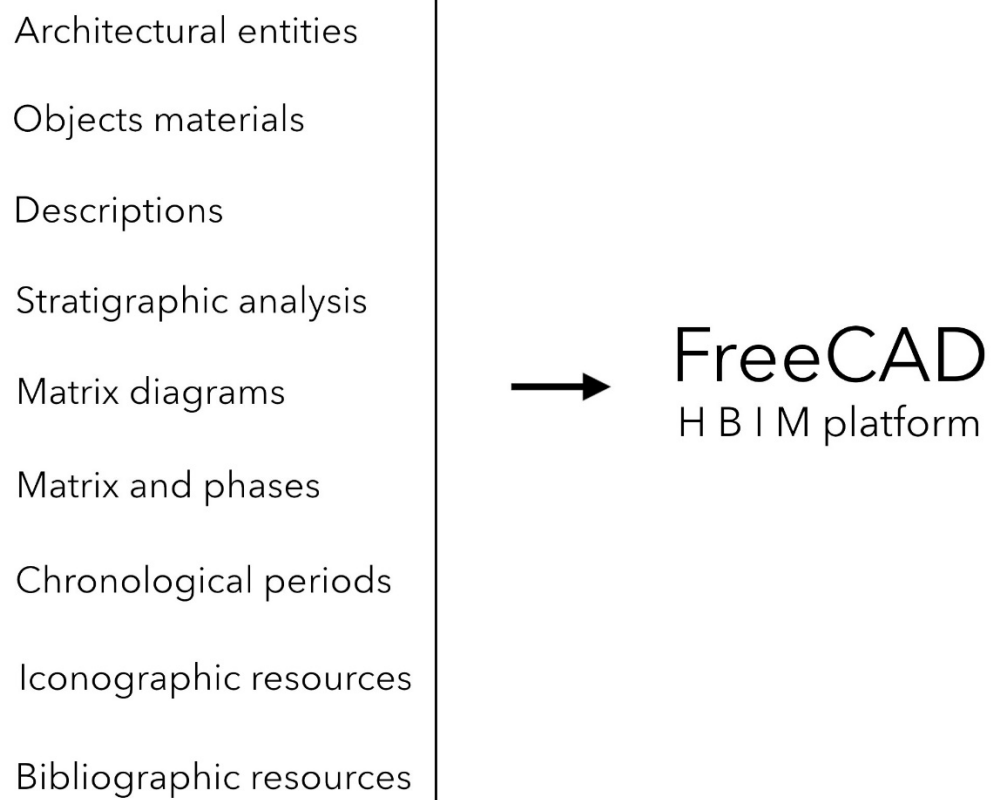

Figure 263. Information concerning the refectory inside the FreeCAD HBIM platform

## 11.2 Data querying

After the performed integration, the semantic dimension based on ad-hoc information is prepared to be analysed and questioned through custom and specific needs. In this sense, data querying and management is an important step on HBIM projects because it allows performing punctual analyses not only on graphic visualization of IFC objects but also their features and attributes, concerning also unconventional 2D documentation: in fact, in this group could be included materials and stratigraphic units analysis, enabling also the data updating and consequently the historical interpretation.

The interrogation phases could occur inside BIM platforms as well as by using third-party software thought for the BIM sharing and visualization processes, such as viewers and web servers. However, software like viewers and the greatest part of web servers are generally based on predefined queries or IFC schema-based filters (Tauscher et al, 2016). These kinds of interrogations rely on architectural elements defined by the ISO standards inside IFC schemas and in particular are predefined viewer-based queries which allow the switch-on and switch-off of specific architectural elements (wall, column, window, beam, and so on). As could be argued, these predefined queries based on the visualization of IFC standards shall be suitable especially for AEC industry BIM projects.

As far as the refectory is concerned, query processes and tests have been performed principally by using the local FreeCAD platform and also testing BIMServer as a web server and BIM Vision as advanced viewer and data checker. Furthermore, FreeCAD and BIMServer platforms have been used also for the purpose of testing two different queries languages: in fact, in this project the query analysis has been carried out by using principally two query languages, such as the Structured Query Language (SQL) and the JavaScript Object Notation (JSON).

### 11.2.1 Structured Query Language (SQL)

SQL (Structured Query Language) is an international standard (ISO), easy and common language for storing, manipulating and retrieving information inside databases. Most common relational database management systems that use SQL language are: Oracle, Sybase, Microsoft SQL Server, Access, Ingres, etc. (Li et al., 2016).

In fact, SQL language is used to communicate with common databases. According to ANSI (American National Standards Institute), it is the standard

language for relational database management systems (RDMS). Moreover, the Express Query Language (EQL) is an additional and generic SQL-like language that allows performing queries (using the same SQL statements) on data available in STEP format, and as the IFC has been developed based on STEP and EXPRESS, the EQL language can be applied to IFC objects (Li et al., 2016).

In order to access, perform and manage a database and query, SQL statements have to be used and implemented. In fact, the SQL language is composed by *statements* that are used to perform tasks such as update data on a database, or manage data from a database. The most common SQL statement in order to perform queries is the SELECT statement, even if it includes more statements to perform a lot of operations with a database. The most important SQL statements are:

- SELECT - extracts data from a database
- UPDATE - updates data in a database
- DELETE - deletes data from a database
- INSERT INTO - inserts new data into a database
- CREATE DATABASE - creates a new database
- ALTER DATABASE - modifies a database
- CREATE TABLE - creates a new table
- ALTER TABLE - modifies a table
- DROP TABLE - deletes a table
- CREATE INDEX - creates an index (search key)
- DROP INDEX - deletes an index

For example, the following SQL statement selects all records in a database table called "Customers":

```
SELECT * FROM Customers;
```

### 11.2.2 JavaScript Object Notation (JSON)

JavaScript Object Notation (JSON) is a data-interchange format. It is based on a subset of the JavaScript Programming Language, Standard ECMA-262 3rd Edition - December 1999. JSON is a text format that is completely language independent although it uses conventions that are familiar to programmers of the C-family of languages, including C, C++, C#, Java, JavaScript, Perl, Python, and many others. For these properties JSON could be defined as the ideal data-interchange language.

JSON language is based on these two structures, and the other programming languages support them, making data format interchangeable:

- A collection of name/value pairs. In various languages, this is realized as an object, record, structure, dictionary, hash table, keyed list, or associative array.
- An ordered list of values. In most languages, this is realized as an array, vector, list, or sequence.

Moreover, JSON language follows these syntax rules:

- Data is in name/value pairs
- Data is separated by commas
- Curly braces hold objects
- Square brackets hold arrays

The JSON language example defines employees objects (an array of 3 employee records):

```
{
"employees": [
  {"firstName": "John", "lastName": "Doe"},
  {"firstName": "Anna", "lastName": "Smith"},
  {"firstName": "Peter", "lastName": "Jones"}
]
}
```

### 11.2.3 Querying the refectory - SQL and FreeCAD

Inside FreeCAD software the implementation of query languages, such as SQL, allows to perform new data analysis based on custom needs. One of the main characteristics of FreeCAD, as mentioned in previous chapters, is the constant development of the source code, add-on, macros and workbenches from the community, and the growth of the community (developers, fans and other) itself. In order to use SQL language and perform SQL queries in a Python environment like FreeCAD we need to install SQL parser module by evoking this code on terminal, after the inclusion of Python variable path on the system:

```
pip install sqlparser
```

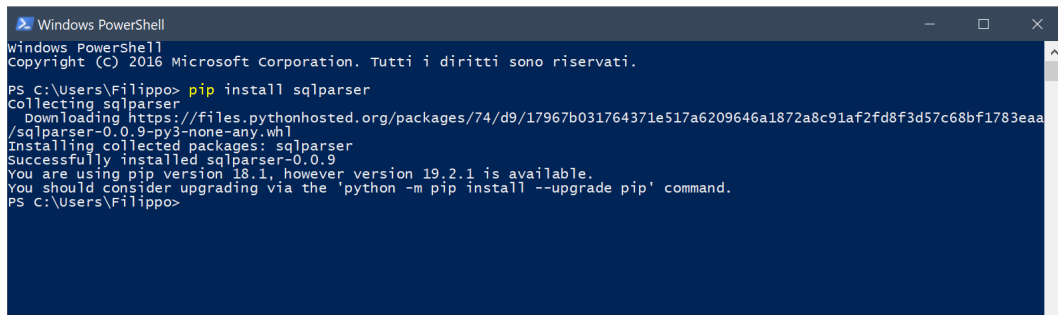

```
Windows PowerShell
Copyright (c) 2016 Microsoft Corporation. Tutti i diritti sono riservati.

PS C:\Users\Filippo> pip install sqlparser
Collecting sqlparser
  Downloading https://files.pythonhosted.org/packages/74/d9/17967b031764371e517a6209646a1872a8c91af2fd8f3d57c68bf1783eaa
/sqlparser-0.0.9-py3-none-any.whl
Installing collected packages: sqlparser
Successfully installed sqlparser-0.0.9
You are using pip version 18.1, however version 19.2.1 is available.
You should consider upgrading via the 'python -m pip install --upgrade pip' command.
PS C:\Users\Filippo>
```

Figure 264. PIP installation through Windows PowerShell terminal

In this sense, queries based on SQL parser can be carried out by using Python console on FreeCAD software. In this way, objects can be analysed by using and / or combining simple query methods, such as *Select*, *Where*, *And*, *Or*, *Not*, and other.

In this scenario, the REPORTING WORKBENCH has a fundamental role as regards the querying analysis on FreeCAD. In fact, it makes possible the extraction of information from objects inside a FreeCAD document, but this feature is stronger than it looks: the SQL statement set in report configuration, in addition to generate an output to query, it creates automatically a datasheet report based on the SQL statement and SQL parser. So, this feature is an excellent way to query and generate automatically reports of analysed objects.

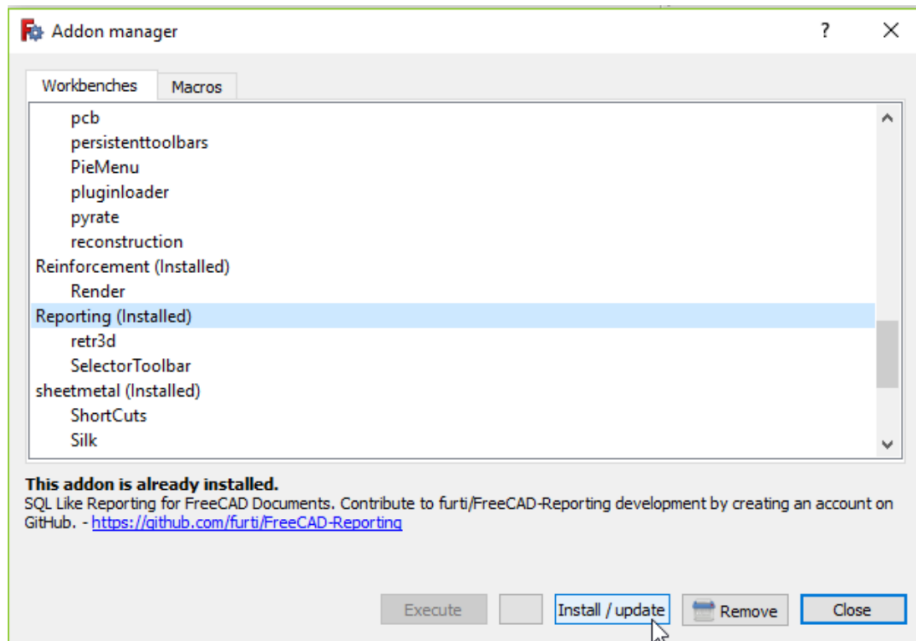

Figure 265. Reporting workbench on addon manager

Before introducing a SQL query, on Python console we should evocate the already installed SQL parser module inside FreeCAD through this code:

```
from sql import freecad_sql_parser
sql_parser = freecad_sql_parser.newParser()
```

However, in order to keep from writing this code every time we need a query, the SQL parser evocation code can be integrated inside all query by adding the two rows code above the query code.

Then, SQL-based queries can be managed and carried out by using Python console inside FreeCAD software. In this way, an architectural element could be analysed by using and / or combining simple query methods, such as *Select*, *Where*, *And*, *Or*, *Not*, and other. For the purpose of testing SQL queries inside FreeCAD, the SQL parser evocation code has been integrated inside all queries by adding the two rows code above the query code. Going deeper, the SQL queries concerning the refectory has been performed in order to investigate and make relations between:

- TAGs: set up referred to chronological periods of the refectory;
- Material: set up based on refectory materials;
- IFC Entities: referred to architectural components and stratigraphic units;
- Standard Code: set up referred to stratigraphic units numeric identification (EA-USM-USR-Negative);
- Descriptions.

As mentioned before, by using the REPORTING WORKBENCH is possible to conduct queries analyses in two ways and both require the SQL parser: the first method is based on the simple query writing on Python console of FreeCAD and the output result is given by green text strings on below the query text input; moreover, in order to obtain a tidy result based on datasheet layout the creation of a new report based on SQL statement might be a suitable solution because, after compiling depending on our need the SQL statement configuration, it creates automatically a datasheet output report based on the previous statement.

As far as the architectural entities semantic classification, SQL query analyses inside FreeCAD have been conducted by following two designed IFC classification described in previous chapter: a first one is based on the ISO normative and standard and the demonstrative one, as we have seen, is based on custom IFC roles classification after the modification of the schema. Indeed, a default classification is concerned the standard IFC roles such as a wall, roof, opening elements and so on, while the custom classification regarding the refectory has been carried out by adding inside the IFC2X3 schema of FreeCAD the roles: USM – USR - GROIN VAULT – PILLAR – BUTTRESS – ARCH.



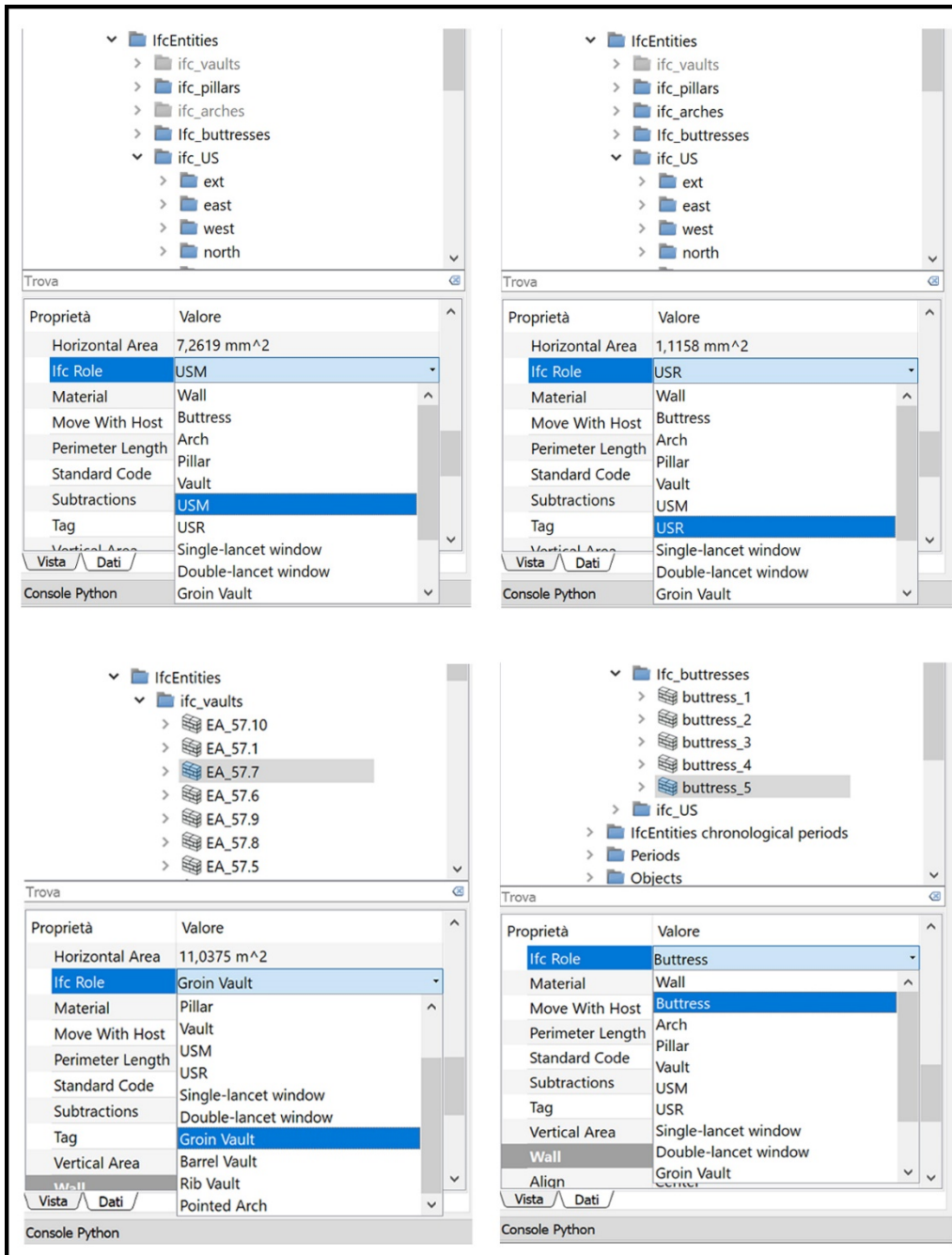

Figure 266. Customized IFC role inside the drop-down menu of FreeCAD

After this modification, inside the graphic interface of FreeCAD, on the left properties menu of IFC objects, custom role results available on the drop-down menu and they can be associated to a specific object. In the same way, the SQL query based on the SELECT syntax can include the new custom classification

without generating syntax or content errors. Here are different examples of SQL queries designed and performed for FreeCAD objects, based on Python console:

### Query\_1: Select all IFC WALL entities

Query was written on Python console (input), the result (output) appeared in the green text below;  
Based on ISO normative and standard classification

```
from sql import freecad_sql_parser

sql_parser = freecad_sql_parser.newParser()

select_something = sql_parser.parse("Select Label from
document Where IfcRole = 'Wall'")

select_something.execute()
```

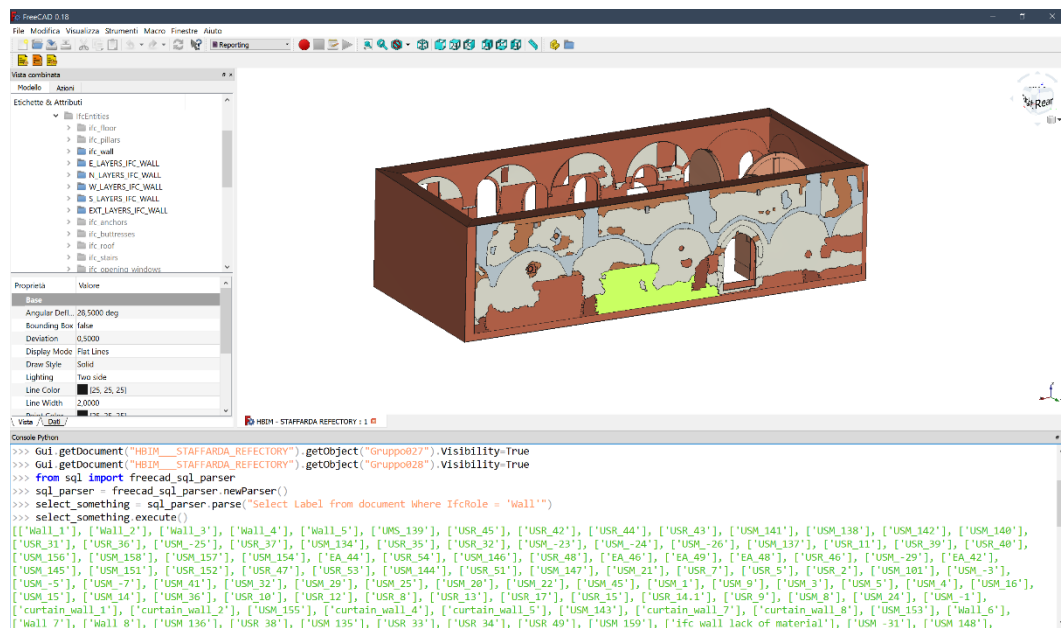

Figure 267. IFC Wall entities query, input and output (in green text) - (elaboration F. Diara).

## Query\_2: Select LABEL and TAG from IFC WALL entities

Query was written on Python console (input), the result (output) appeared in the green text below;  
Based on ISO normative and standard classification

```
from sql import freecad_sql_parser

sql_parser = freecad_sql_parser.newParser()

select_name = sql_parser.parse("SELECT Label, Tag From
document Where IfcRole = 'Wall'")

select_name.execute()
```

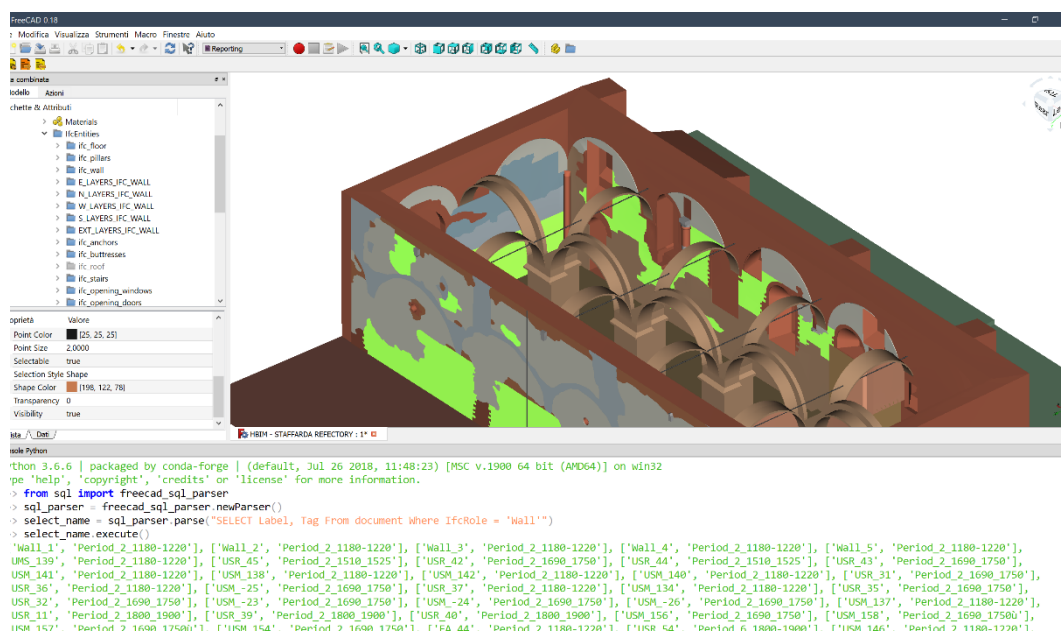

Figure 268. LABEL and TAG of wall entities query, input and output (in green text) - (elaboration F. Diara).

### Query\_3: Select all elements with PLASTER material

Query was written on Python console (input), the result (output) appeared in the green text below;  
Based on ISO normative and standard classification

```
from sql import freecad_sql_parser

sql_parser = freecad_sql_parser.newParser()

select_label = sql_parser.parse("SELECT Label From
document Where Material.Label = 'Plaster'")

select_label.execute()
```

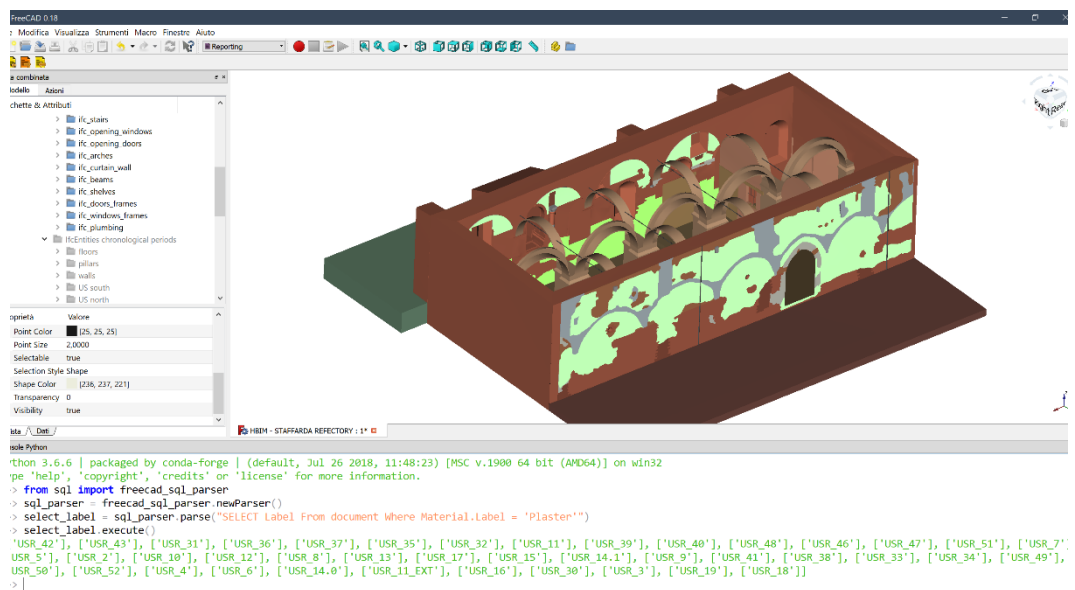

Figure 269. Plaster material query, input and output (in green text) - (elaboration F. Diara).

#### Query\_4: Select LABEL and MATERIAL from IFC COLUMN entities

Query was written on Python console (input), the result (output) appeared in the green text below;  
Based on ISO normative and standard classification

```
from sql import freecad_sql_parser

sql_parser = freecad_sql_parser.newParser()

select_name = sql_parser.parse("SELECT Label,
Material.Label From document Where IfcRole =
'Column'")

select_name.execute()
```

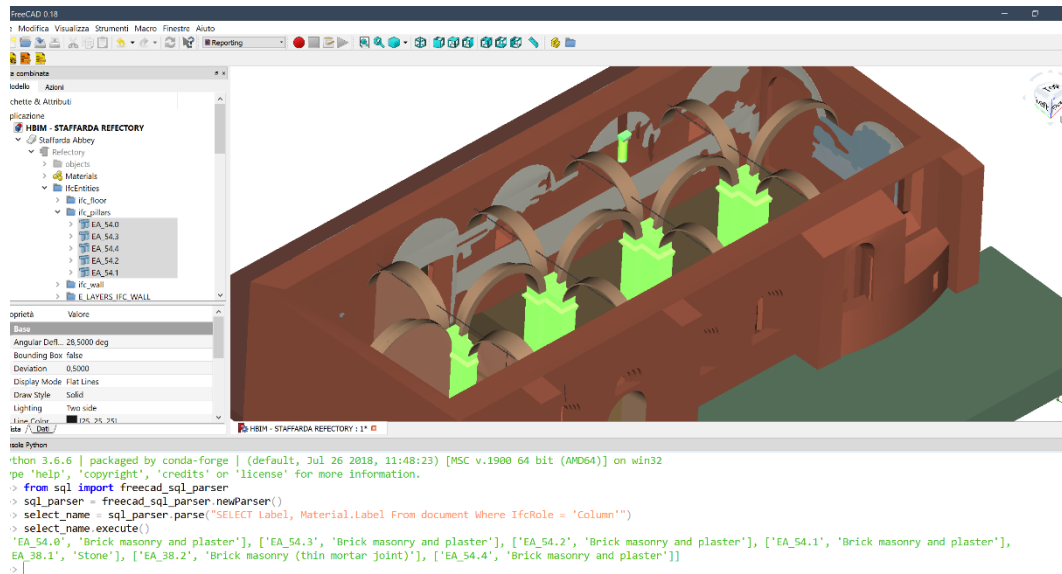

Figure 270. LABEL and MATERIAL of column entities query, input and output (in green text) - (elaboration F. Diara).

## Query\_5: Select LABEL and MATERIAL from IFC OPENING ELEMENT entities

Query was written on Python console (input), the result (output) appeared in the green text below;  
Based on ISO normative and standard classification

```
from sql import freecad_sql_parser

sql_parser = freecad_sql_parser.newParser()

select_name = sql_parser.parse("SELECT Label,
Material.Label From document Where IfcRole = 'Opening
Element'")

select_name.execute()
```

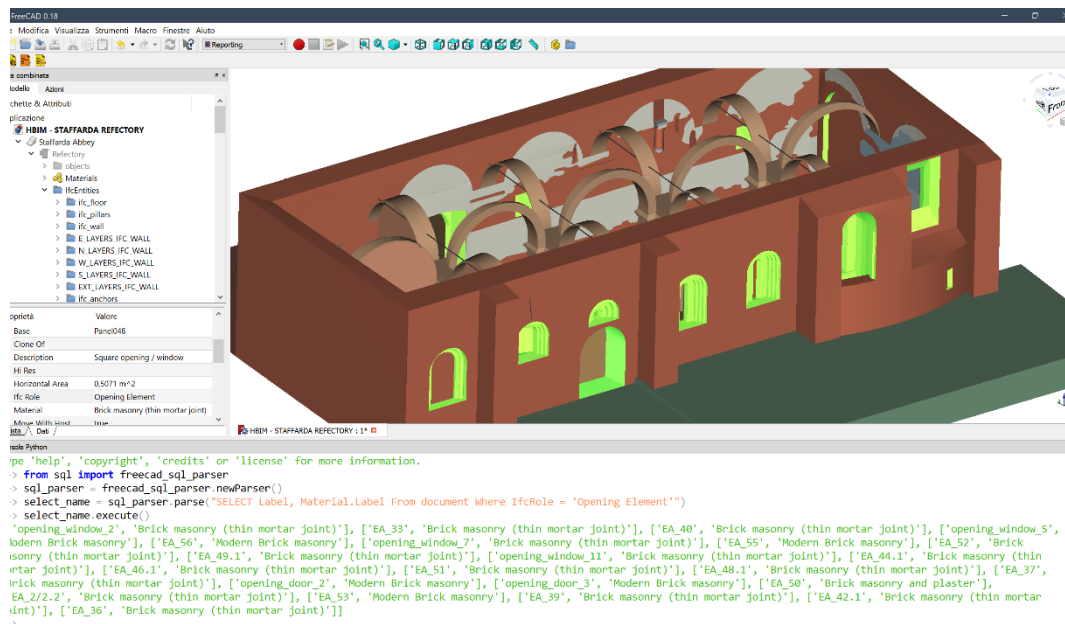

Figure 271. LABEL and MATERIAL of opening entities query, input and output (in green text) - (elaboration F. Diara).

## Query\_6: Select objects with TAG “Period\_2\_1180-1220”

Query was written on Python console (input), the result (output) appeared in the green text below;  
Based on ISO normative and standard classification

```
from sql import freecad_sql_parser

sql_parser = freecad_sql_parser.newParser()

select_label = sql_parser.parse("Select Label from
document Where Tag = 'Period_2_1180-1220'")

select_label.execute()
```

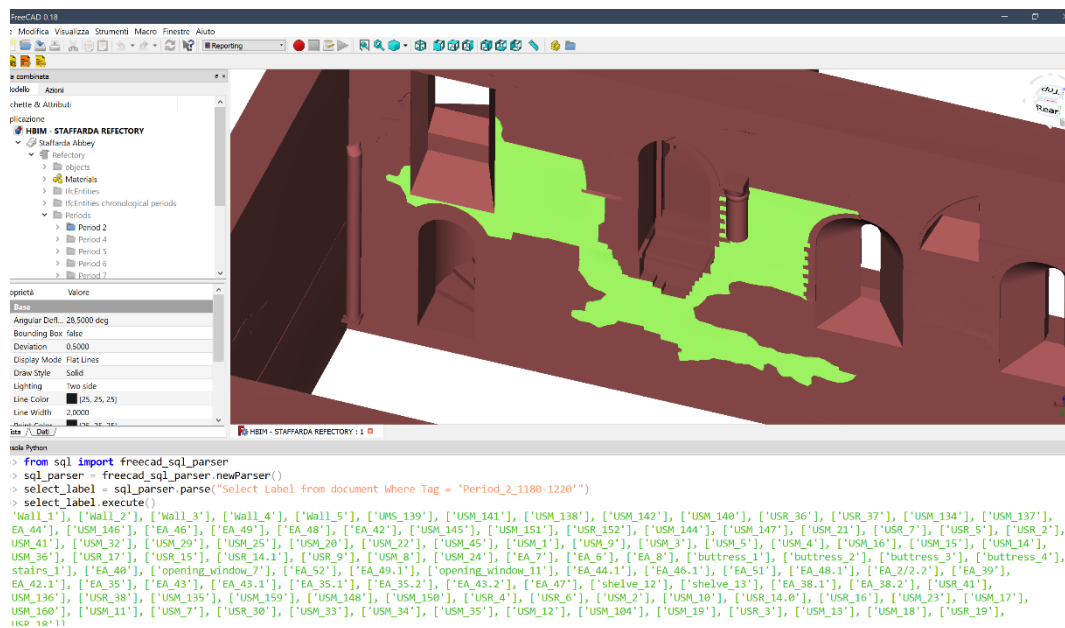

Figure 272. Period 2 query, input and output (in green text) - (elaboration F. Diara).

### Query\_7: Select objects with STANDARD CODE “USR\_4”

Query was written on Python console (input), the result (output) appeared in the green text below;  
Based on ISO normative and standard classification

```
from sql import freecad_sql_parser

sql_parser = freecad_sql_parser.newParser()

select_something = sql_parser.parse("Select Label from
document Where StandardCode = 'USR'")

select_something.execute()
```



Figure 273. Standard code query, input and output (in green text) - (elaboration F. Diara).



## Query\_7: Count all the objects inside the project

Query was written on Python console (input), the result (output) appeared in the green text below;  
Based on ISO normative and standard classification

```
from sql import freecad_sql_parser

sql_parser = freecad_sql_parser.newParser()

select_number_of_objects = sql_parser.parse('Select
count(*) From document')

select_number_of_objects.execute()
```

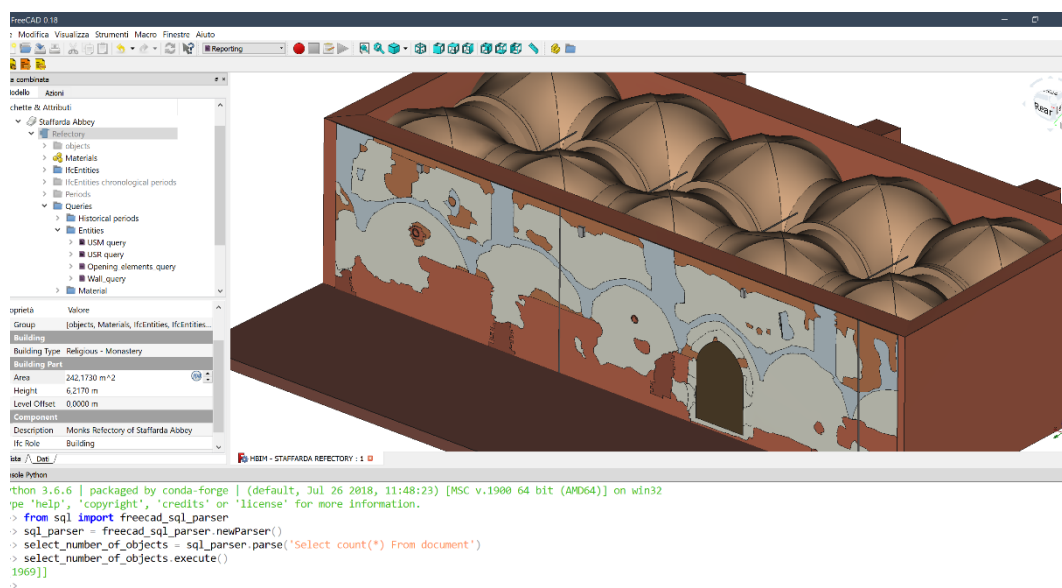

Figure 274. All objects count query, input and output (in green text) - (elaboration F. Diara).

## Query\_8: Select all IFC GROIN VAULT entities

Query was written on Python console (input), the result (output) appeared in the green text below;  
Based on custom demonstrative classification

```
from sql import freecad_sql_parser

sql_parser = freecad_sql_parser.newParser()

select_something = sql_parser.parse("Select Label from
document Where IfcRole = 'Groin Vault'")

select_something.execute()
```

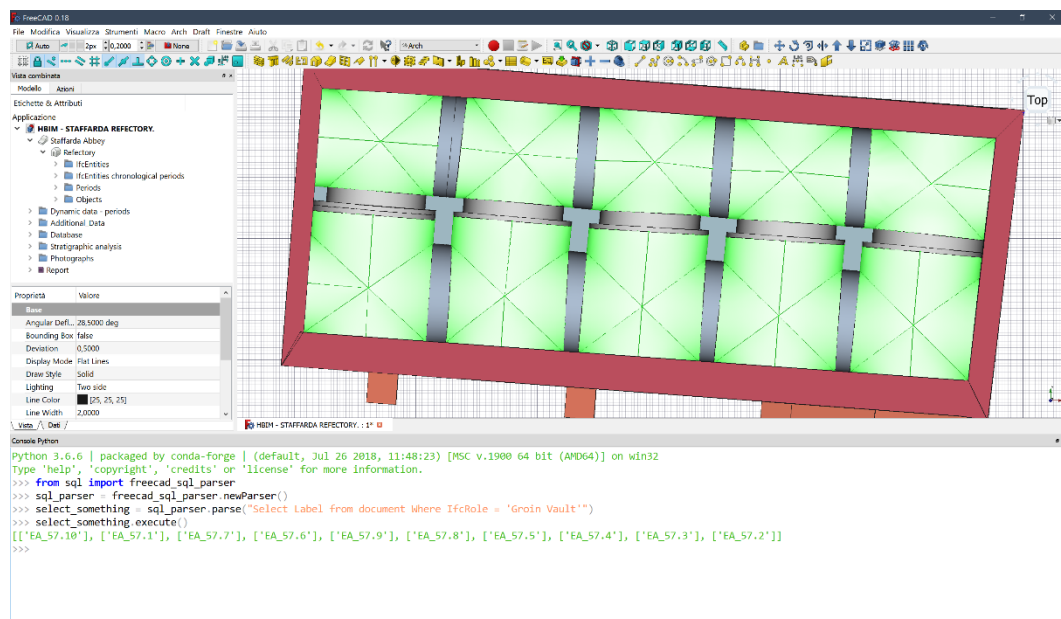

Figure 275. Groin vault customized query, input and output (in green text) - (elaboration F. Diara).

## Query\_9: Select all IFC USM entities

Query was written on Python console (input), the result (output) appeared in the green text below;  
Based on custom demonstrative classification

```
from sql import freecad_sql_parser

sql_parser = freecad_sql_parser.newParser()

select_something = sql_parser.parse("Select Label from
document Where IfcRole = 'USM'")

select_something.execute()
```

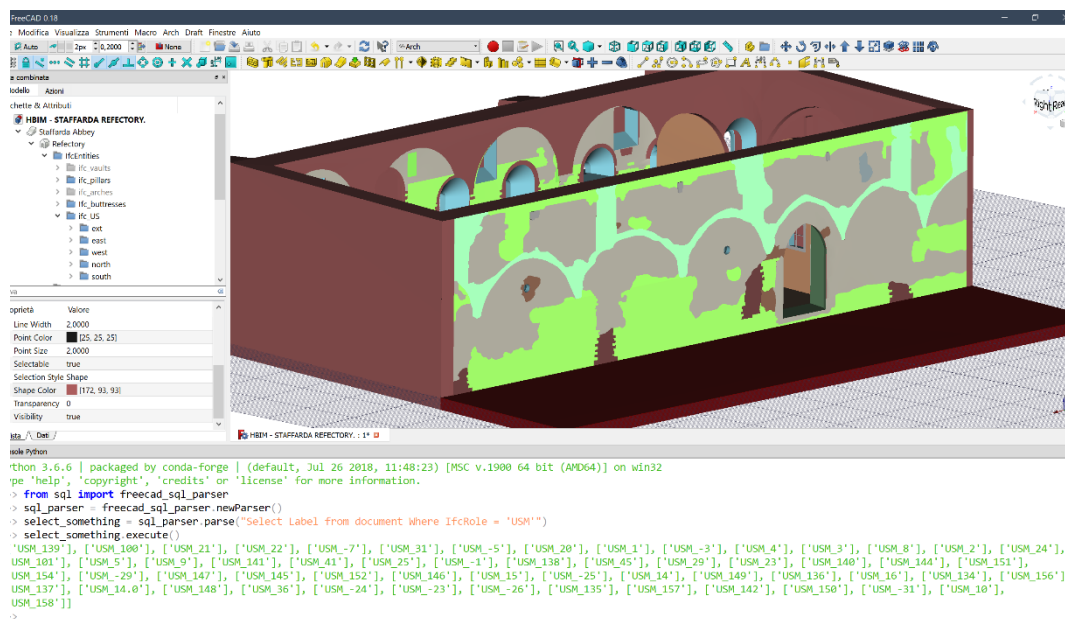

Figure 276. USM customized query, input and output (in green text) - (elaboration F. Diara).

## Query\_10: Select all IFC USR entities

Query was written on Python console (input), the result (output) appeared in the green text below;  
Based on custom demonstrative classification

```
from sql import freecad_sql_parser

sql_parser = freecad_sql_parser.newParser()

select_something = sql_parser.parse("Select Label from
document Where IfcRole = 'USR'")

select_something.execute()
```

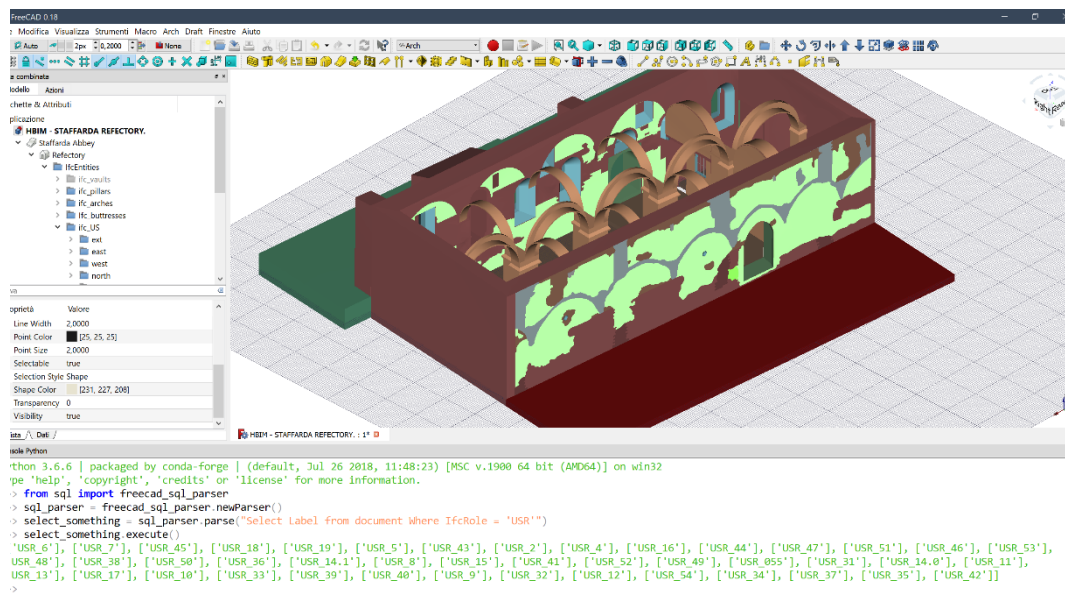

Figure 277. USR customized query, input and output (in green text) - (elaboration F. Diara).

### Query\_11: Select all IFC BUTTRESS entities

Query was written on Python console (input), the result (output) appeared in the green text below;  
Based on custom demonstrative classification

```
from sql import freecad_sql_parser

sql_parser = freecad_sql_parser.newParser()

select_something = sql_parser.parse("Select Label from
document Where IfcRole = 'Buttress'")

select_something.execute()
```

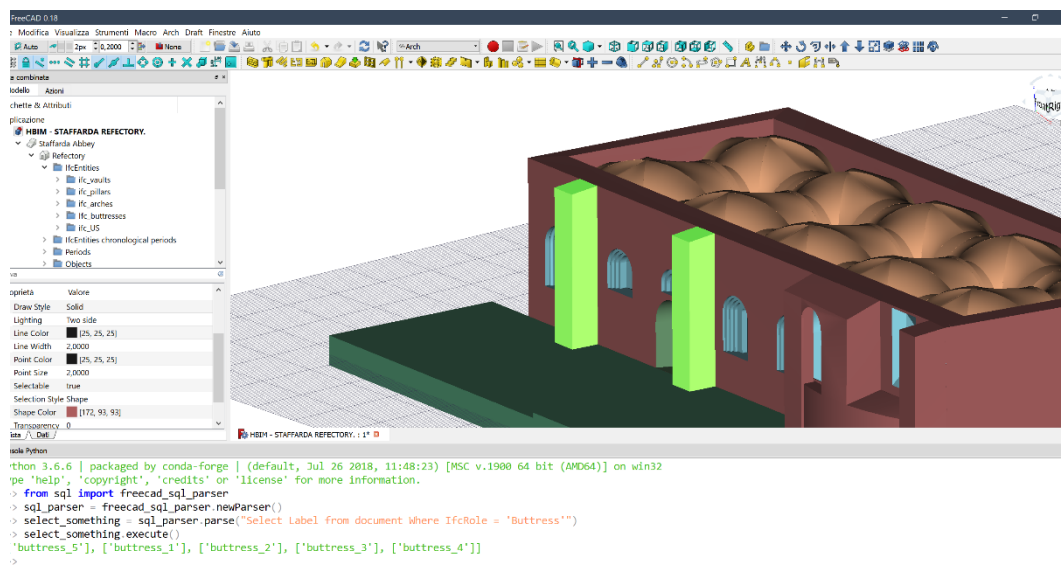

Figure 278. Buttresses customized query, input and output (in green text) - (elaboration F. Diara).

## Query\_12: Select all IFC ARCH entities

Query was written on Python console (input), the result (output) appeared in the green text below;  
Based on custom demonstrative classification

```
from sql import freecad_sql_parser

sql_parser = freecad_sql_parser.newParser()

select_something = sql_parser.parse("Select Label from
document Where IfcRole = 'Arch'")

select_something.execute()
```

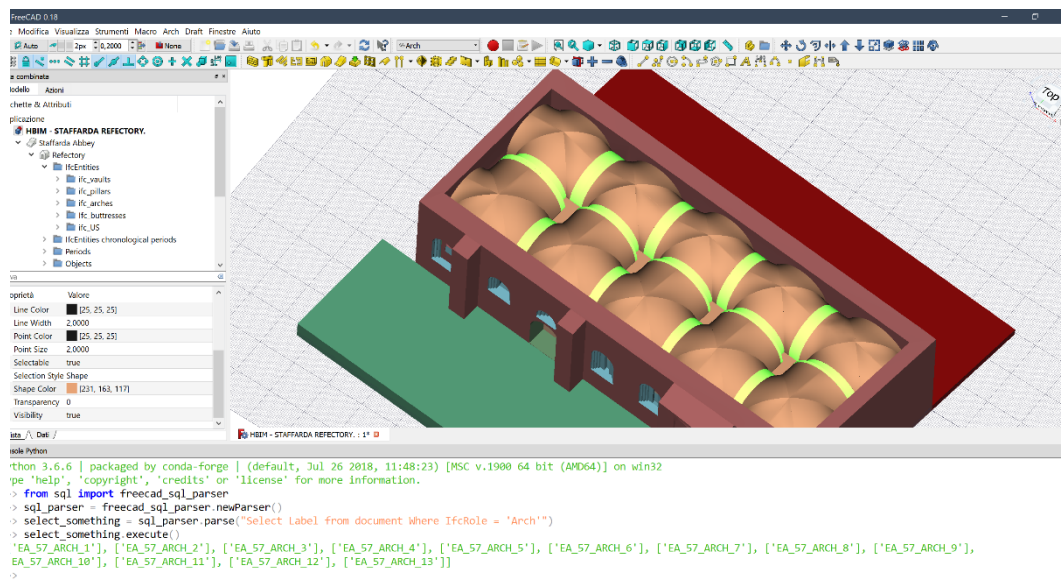

Figure 279. Arches customized query, input and output (in green text) - (elaboration F. Diara).

### Query\_13: Select all IFC USM entities

Query was written on Python console (input), the result (output) appeared in the green text below;  
Based on custom demonstrative classification

```
from sql import freecad_sql_parser

sql_parser = freecad_sql_parser.newParser()

select_something = sql_parser.parse("Select Label from
document Where IfcRole = 'Pillar'")

select_something.execute()
```

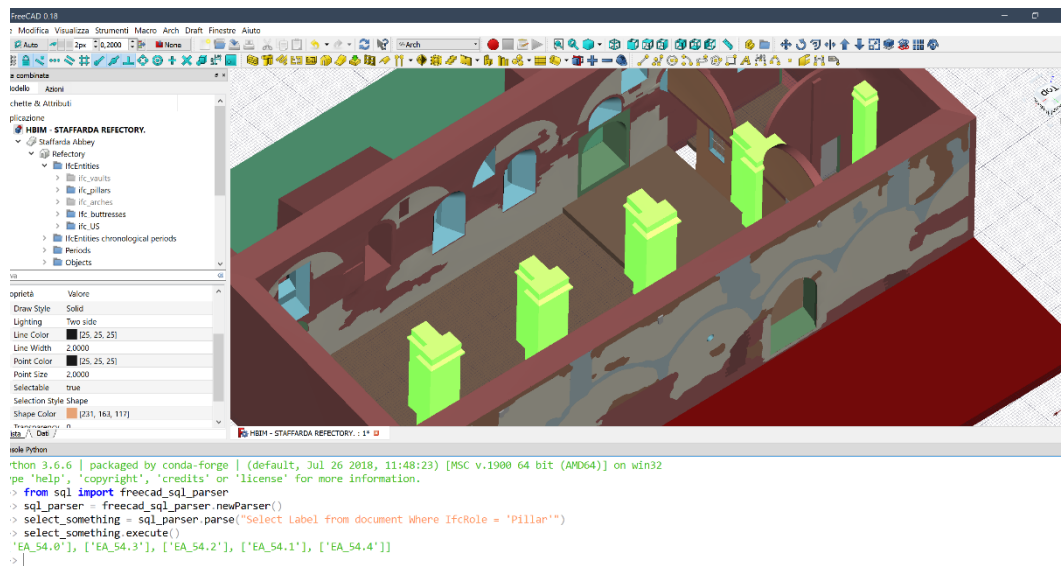

Figure 280. Pillars customized query, input and output (in green text) - (elaboration F. Diara).

This first example group of SQL queries is based directly on scripting on Python console of FreeCAD. As mentioned before is possible to perform query analyses obtaining a tidy result based on datasheet layout. These query analyses can be conducted by creating a new report based on SQL statement that generates automatically a datasheet output report based on the previous SQL statement easily to export in CSV format in order to exchange and preserve data externally. This solution could be the most suitable in order to pre-compile custom queries and share the results for example into a database management system. Here are different examples of SQL queries based on statements and reports:

## Query\_14: Select LABEL and DESCRIPTION from IFC WALL entities

Query was written on statement configuration and the result is given by the datasheet report;  
Based on ISO normative and standard classification

Select Label, Description from document Where IfcRole = 'Wall'

The screenshot shows the FreeCAD 0.18 interface. On the left, the 'Wall\_query Config' dialog box is open, showing the statement configuration. The main window displays a table with the following data:

| Contenuto | Label   | Description                                 |
|-----------|---------|---|
| 1         | Wall_1  | Perimeter walls of the refectory            |
| 2         | Wall_2  | Perimeter walls of the refectory            |
| 3         | Wall_3  | Perimeter walls of the refectory            |
| 4         | Wall_4  | Perimeter walls of the refectory            |
| 5         | Wall_5  | Wall related to the access to the pulpit    |
| 6         | URM_139 | brick masonry                               |
| 7         | USR_45  | Ultima Cena Fresco (XV-XVI century)         |
| 8         | USR_42  | Plaster on bezel of the new vaulted ceiling |
| 9         | USR_44  | Groundwork layer for Ultima Cena Fresco     |
| 10        | USR_43  | Plaster on bezel of the new vaulted ceiling |
| 11        | USM_141 | brick masonry                               |
| 12        | USM_138 | brick masonry                               |
| 13        | USM_142 | brick masonry                               |
| 14        | USM_140 | brick masonry                               |
| 15        | USR_31  | Plaster on bezel of the new vaulted ceiling |
| 16        |         |   |

Below the table, the Python console shows the following code:

```

pe 'help', 'copyright', 'credits' or 'license' for more information.
-> from sql import freecad_sql_parser
-> sql_parser = freecad_sql_parser.newParser()
-> select_number_of_objects = sql_parser.parse("Select count(*) From document")
-> select_number_of_objects.execute()
1969]]
-> Gui.getDocument("HBIM - STAFFARDA REFECTORY").getObject("Gruppo031").Visibility=False
-> App.ActiveDocument.Result021.setColumnWidth('B', 473)
-> App.ActiveDocument.recompute()
-> App.ActiveDocument.Result022.setColumnWidth('B', 440)
    
```

Figure 281. Reporting query: statement configuration (select from wall entities) - (elaboration F. Diara).

The screenshot shows the FreeCAD 0.18 interface. On the left, the 'Wall\_query Config' dialog box is open. The main window displays a table with the following data:

| Contenuto | Label   | Description                                 |
|-----------|---------|---|
| 1         | Wall_1  | Perimeter walls of the refectory            |
| 2         | Wall_2  | Perimeter walls of the refectory            |
| 3         | Wall_3  | Perimeter walls of the refectory            |
| 4         | Wall_4  | Perimeter walls of the refectory            |
| 5         | Wall_5  | Wall related to the access to the pulpit    |
| 6         | URM_139 | brick masonry                               |
| 7         | USR_45  | Ultima Cena Fresco (XV-XVI century)         |
| 8         | USR_42  | Plaster on bezel of the new vaulted ceiling |
| 9         | USR_44  | Groundwork layer for Ultima Cena Fresco     |
| 10        | USR_43  | Plaster on bezel of the new vaulted ceiling |
| 11        | USM_141 | brick masonry                               |
| 12        | USM_138 | brick masonry                               |
| 13        | USM_142 | brick masonry                               |
| 14        | USM_140 | brick masonry                               |
| 15        | USR_31  | Plaster on bezel of the new vaulted ceiling |
| 16        |         |   |

Below the table, the Python console shows the following code:

```

pe 'help', 'copyright', 'credits' or 'license' for more information.
-> from sql import freecad_sql_parser
-> sql_parser = freecad_sql_parser.newParser()
-> select_number_of_objects = sql_parser.parse("Select count(*) From document")
-> select_number_of_objects.execute()
1969]]
-> Gui.getDocument("HBIM - STAFFARDA REFECTORY").getObject("Gruppo031").Visibility=False
-> App.ActiveDocument.Result021.setColumnWidth('B', 473)
-> App.ActiveDocument.recompute()
-> App.ActiveDocument.Result022.setColumnWidth('B', 440)
    
```

Figure 282. Reporting query: select label and description from wall entities (results on datasheet) - (elaboration F. Diara).



## Query\_15: Select LABEL and DESCRIPTION from IFC OPENING ELEMENT entities

Query was written on statement configuration and the result is given by the datasheet report;  
Based on ISO normative and standard classification

Select Label, Description from document Where IfcRole = 'Opening Element'

The screenshot shows the 'Opening\_elements\_query Config' dialog box with the following configuration:

- Statement: Select Label, Description from document Where IfcRole = 'Opening Element'
- Buttons: OK, Annulla
- Options:  Skip Column Names,  Skip Drop Rows After Statement,  Hide Results Row

The 'openings\_results' table is displayed with the following data:

| Label | Description   |
|-------|---|
| 1     |   |
| 2     | opening_windo... Square thin opening into the access to the pupil |
| 3     | EA_33 Square opening / window                                     |
| 4     | EA_40 square window   |
| 5     | opening_windo... Opening / hole on the wall                       |
| 6     | EA_56 Square modern window  |
| 7     | opening_windo... walled single lancet window                      |
| 8     | EA_55 Square modern window  |
| 9     | EA_52 Partially covered square opening / window                   |
| 10    | EA_49.1 square opening referred to a re-opened single la...       |
| 11    | opening_windo... walled single lancet window                      |
| 12    | EA_44.1 walled single lancet window                               |
| 13    | EA_46.1 single lancet window                                      |
| 14    | EA_51 Partially covered square opening / window                   |
| 15    | EA_48.1 cut single lancet window                                  |
| 16    | EA_37 walled entrance   |

The Python console shows the following code:

```

thon 3.6.6 | packaged by conda-forge | (default, Jul 26 2018, 11:48:23) [MSC v.1900 64 bit (AMD64)] on win32
pe 'help', 'copyright', 'credits' or 'license' for more information.
> from sql import freecad_sql_parser
> sql_parser = freecad_sql_parser.newParser()
> select_number_of_objects = sql_parser.parse('Select count(*) From document')
> select_number_of_objects.execute()
19691]
> Gui.getDocument("HBM - STAFFARDA REFECTORIO").getObject("Gruppo031").Visibility=False
> App.ActiveDocument.Result021.setColumnWidth('B', 473)
> App.ActiveDocument.recompute()
  
```

Figure 283. Reporting query: statement configuration (select from opening entities) - (elaboration F. Diara).

The screenshot shows the 'Opening\_elements\_query Config' dialog box with the following configuration:

- Statement: Select Label, Description from document Where IfcRole = 'Opening Element'
- Buttons: OK, Annulla
- Options:  Skip Column Names,  Skip Drop Rows After Statement,  Hide Results Row

The 'openings\_results' table is displayed with the following data:

| Label | Description   |
|-------|---|
| 1     |   |
| 2     | opening_windo... Square thin opening into the access to the pupil |
| 3     | EA_33 Square opening / window                                     |
| 4     | EA_40 square window   |
| 5     | opening_windo... Opening / hole on the wall                       |
| 6     | EA_56 Square modern window  |
| 7     | opening_windo... walled single lancet window                      |
| 8     | EA_55 Square modern window  |
| 9     | EA_52 Partially covered square opening / window                   |
| 10    | EA_49.1 square opening referred to a re-opened single la...       |
| 11    | opening_windo... walled single lancet window                      |
| 12    | EA_44.1 walled single lancet window                               |
| 13    | EA_46.1 single lancet window                                      |
| 14    | EA_51 Partially covered square opening / window                   |
| 15    | EA_48.1 cut single lancet window                                  |
| 16    | EA_37 walled entrance   |

The Python console shows the following code:

```

thon 3.6.6 | packaged by conda-forge | (default, Jul 26 2018, 11:48:23) [MSC v.1900 64 bit (AMD64)] on win32
pe 'help', 'copyright', 'credits' or 'license' for more information.
> from sql import freecad_sql_parser
> sql_parser = freecad_sql_parser.newParser()
> select_number_of_objects = sql_parser.parse('Select count(*) From document')
> select_number_of_objects.execute()
19691]
> Gui.getDocument("HBM - STAFFARDA REFECTORIO").getObject("Gruppo031").Visibility=False
> App.ActiveDocument.Result021.setColumnWidth('B', 473)
> App.ActiveDocument.recompute()
  
```

Figure 284. Reporting query: select label and description from opening entities (results on datasheet) - (elaboration F. Diara).

## Query\_16: Select all IFC USM entities

Query was written on the statement configuration field and the result is given by the datasheet report;  
Based on custom demonstrative classification

Select Label from document Where IfcRole = 'USM'

The screenshot shows a software interface with a 'USM query Config' dialog box on the left and a 'Risultati' (Results) window on the right. The dialog box contains the following text:

```
Header: USM
Statement: Select label from document Where IfcRole = 'USM'
```

Below the dialog box, there are several checkboxes:  Skip Column Names,  Skip Empty Rows After Statement, and  Print Result in bold. There is also a 'Remove' button and an 'Add Statement' button.

The 'Risultati' window displays a table with the following content:

| Contenuto | USM     |
|-----------|---------|
| 1         | USM     |
| 2         | Label   |
| 3         | USM_139 |
| 4         | USM_100 |
| 5         | USM_21  |
| 6         | USM_22  |
| 7         | USM_-7  |
| 8         | USM_31  |
| 9         | USM_-5  |
| 10        | USM_20  |
| 11        | USM_1   |
| 12        | USM_3   |
| 13        | USM_4   |
| 14        | USM_3   |
| 15        | USM_8   |
| 16        | USM_2   |
| 17        | USM_24  |
| 18        | USM_101 |

At the bottom of the interface, there is a Python console with the following code:

```
!thon 3.6.6 | packaged by conda-forge | (default, Jul 26 2018, 11:48:23) [MSC v.1900 64 bit (AMD64)] on win32
pe 'help', 'copyright', 'credits' or 'license' for more information.
> App.getDocument("HBIM__STAFFARDA_REFECTORIO_"),removeObject("Result")
> App.getDocument("HBIM__STAFFARDA_REFECTORIO_"),recompute()
> App.getDocument("HBIM__STAFFARDA_REFECTORIO_"),removeObject("Report")
> App.getDocument("HBIM__STAFFARDA_REFECTORIO_"),recompute()
> Gui.activateWorkbench("ReportingWorkbench")
> App.getDocument("HBIM__STAFFARDA_REFECTORIO_").addObject("App:DocumentObjectGroup", "Gruppo")
> App.getDocument("HBIM__STAFFARDA_REFECTORIO_").getObject("Gruppo028").addObject(App.getDocument("HBIM__STAFFARDA_REFECTORIO_").getObject("Report"))
```

Figure 285. Reporting query: statement configuration (select from USM entities) - (elaboration F. Diara).

The screenshot shows a software interface with a 'USM query' dialog box on the left and a 'Risultati' (Results) window on the right. The dialog box contains the following text:

```
Header: USM
Statement: Select label and description from document Where IfcRole = 'USM'
```

Below the dialog box, there are several checkboxes:  Skip Column Names,  Skip Empty Rows After Statement, and  Print Result in bold. There is also a 'Remove' button and an 'Add Statement' button.

The 'Risultati' window displays a table with the following content:

| Contenuto | USM     |
|-----------|---------|
| 1         | USM     |
| 2         | Label   |
| 3         | USM_139 |
| 4         | USM_100 |
| 5         | USM_21  |
| 6         | USM_22  |
| 7         | USM_-7  |
| 8         | USM_31  |
| 9         | USM_-5  |
| 10        | USM_20  |
| 11        | USM_1   |
| 12        | USM_3   |
| 13        | USM_4   |
| 14        | USM_3   |
| 15        | USM_8   |
| 16        | USM_2   |
| 17        | USM_24  |
| 18        | USM_101 |

At the bottom of the interface, there is a Python console with the following code:

```
!thon 3.6.6 | packaged by conda-forge | (default, Jul 26 2018, 11:48:23) [MSC v.1900 64 bit (AMD64)] on win32
pe 'help', 'copyright', 'credits' or 'license' for more information.
>
```

Figure 286. Reporting query: select label and description from USM entities (results on datasheet) - (elaboration F. Diara).

## Query\_17: Select all IFC USR entities

Query was written on statement configuration and the result is given by the datasheet report;  
Based on custom demonstrative classification

Select Label from document Where IfcRole = 'USR'

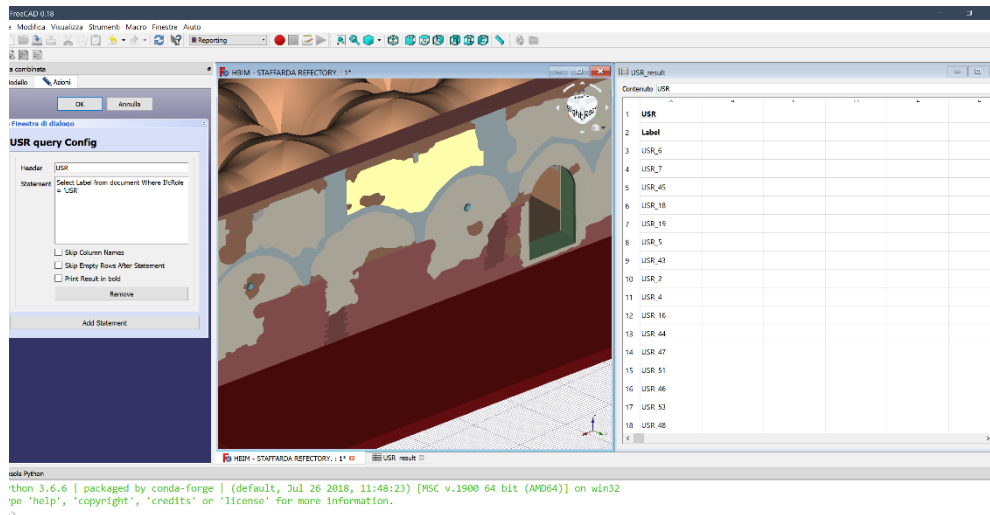

Figure 287. Reporting query: statement configuration (select from USR entities) - (elaboration F. Diara).

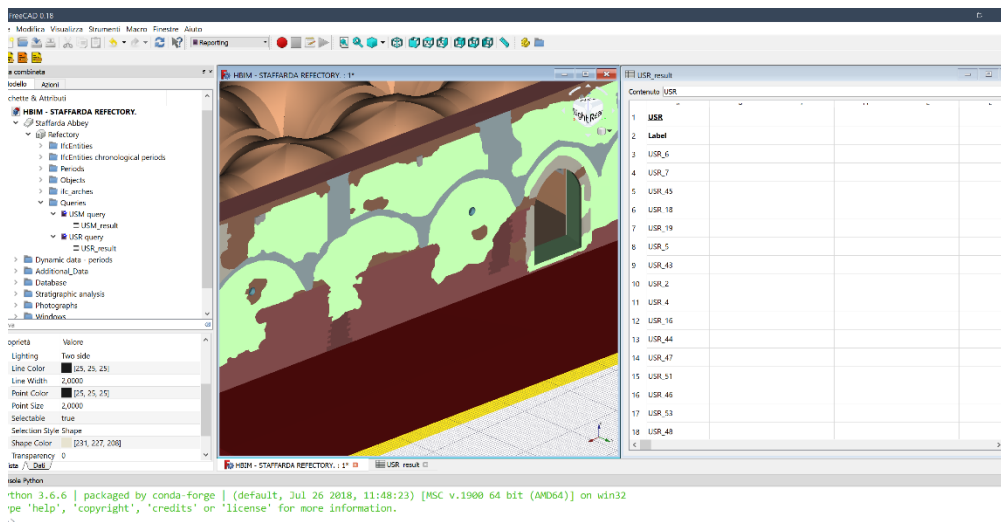

Figure 288. Reporting query: select label and description from USR entities (results on datasheet) - (elaboration F. Diara).

## Query\_18: Select LABEL and DESCRIPTION of PLASTER elements

Query was written on statement configuration and the result is given by the datasheet report;  
Based on custom demonstrative classification

Select Label, Description from document Where Material.Label = 'Plaster'

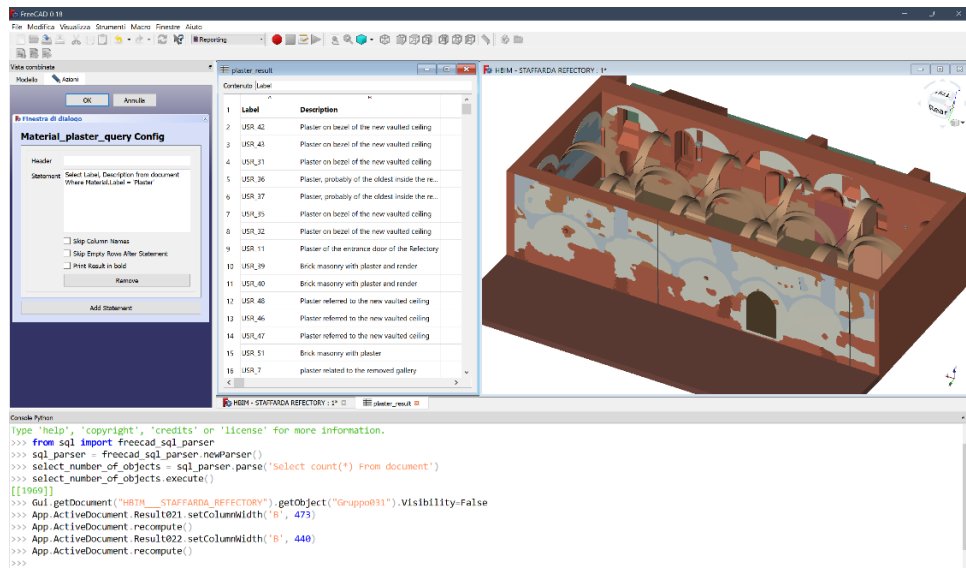

Figure 289. Reporting query: statement configuration (select from plaster entities) - (elaboration F. Diara).

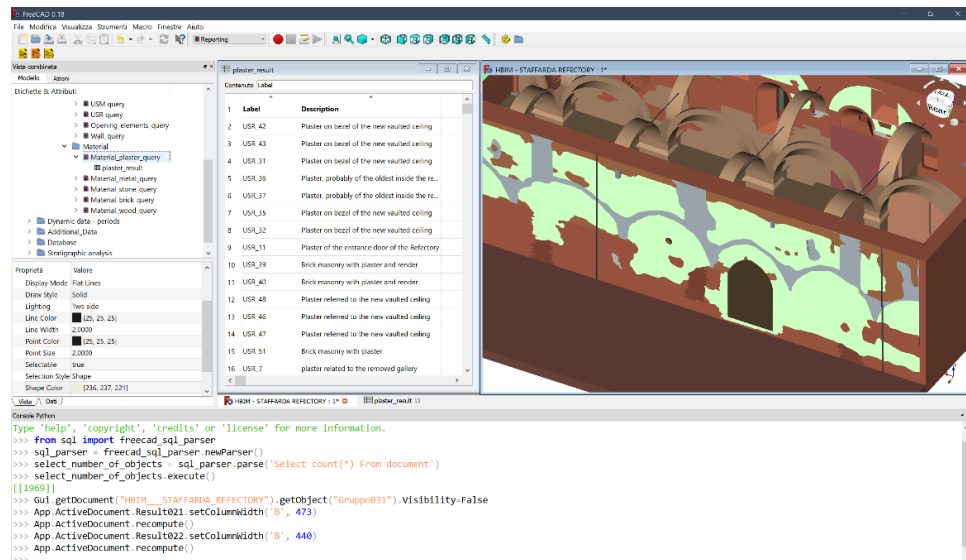

Figure 290. Reporting query: select label and description from plaster entities (results on datasheet) - (elaboration F. Diara).

## Query\_19: Select LABEL and DESCRIPTION of STONE elements

Query was written on statement configuration and the result is given by the datasheet report;  
Based on custom demonstrative classification

Select Label, Description from document Where Material.Label = 'Stone'

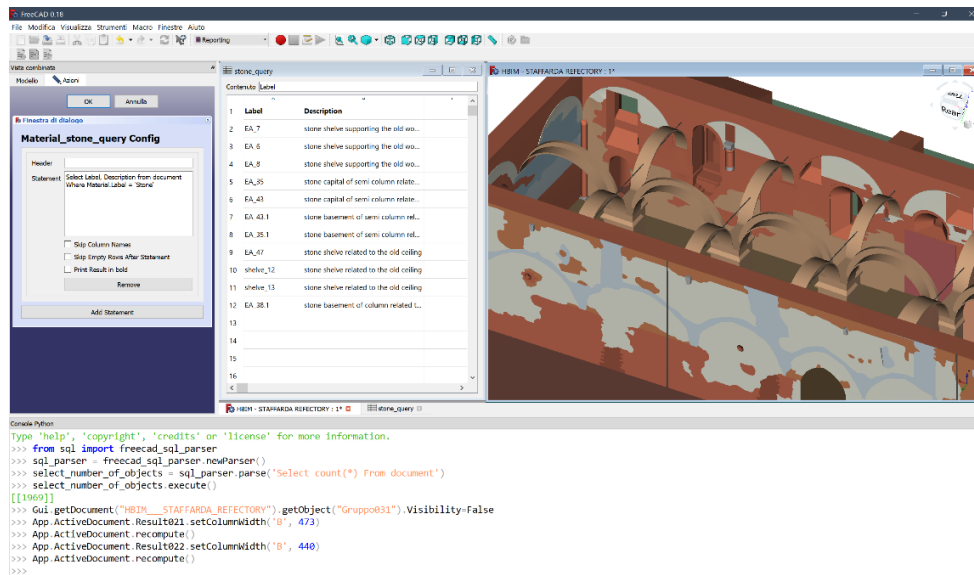

Figure 291. Reporting query: statement configuration (select from stone entities) - (elaboration F. Diara).

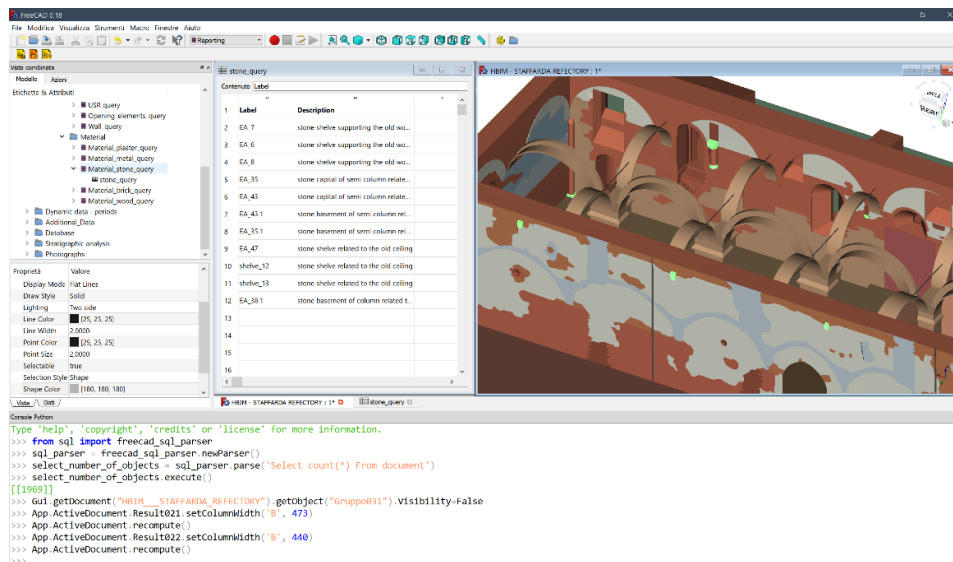

Figure 292. Reporting query: select label and description from stone entities (results on datasheet) - (elaboration F. Diara).

## Query\_20: Select objects with TAG “Period\_2\_1180-1220”

Query was written on statement configuration and the result is given by the datasheet report

```
Select Label from document Where Tag = 'Period_2_1180-1220'
```

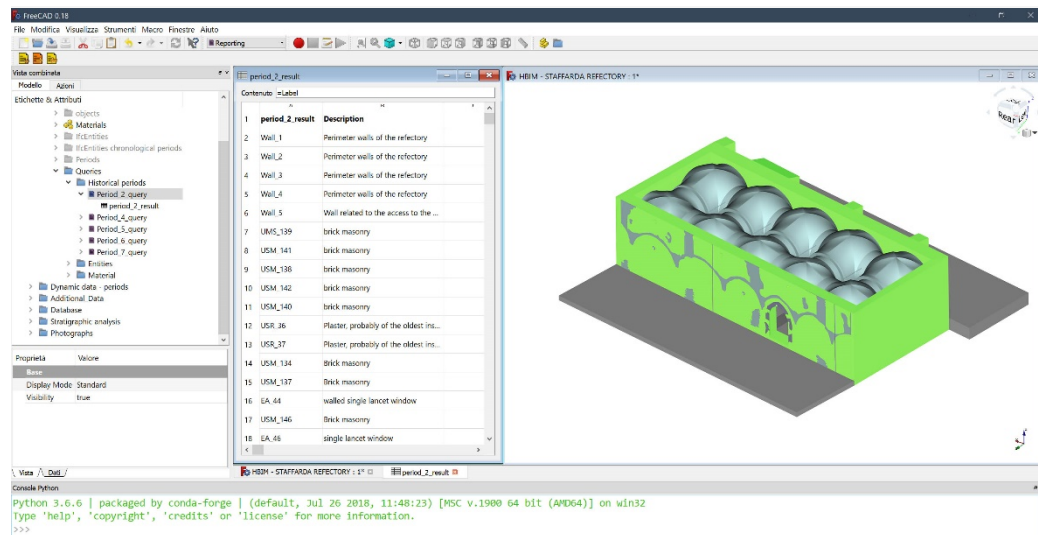

Figure 293. Reporting query: select objects of Period 2 (results on datasheet) - (elaboration F. Diara).

## Query\_21: Select objects with TAG “Period\_4\_1510-1525”

Query was written on statement configuration and the result is given by the datasheet report

```
Select Label from document Where Tag = 'Period_4_1510-1525'
```

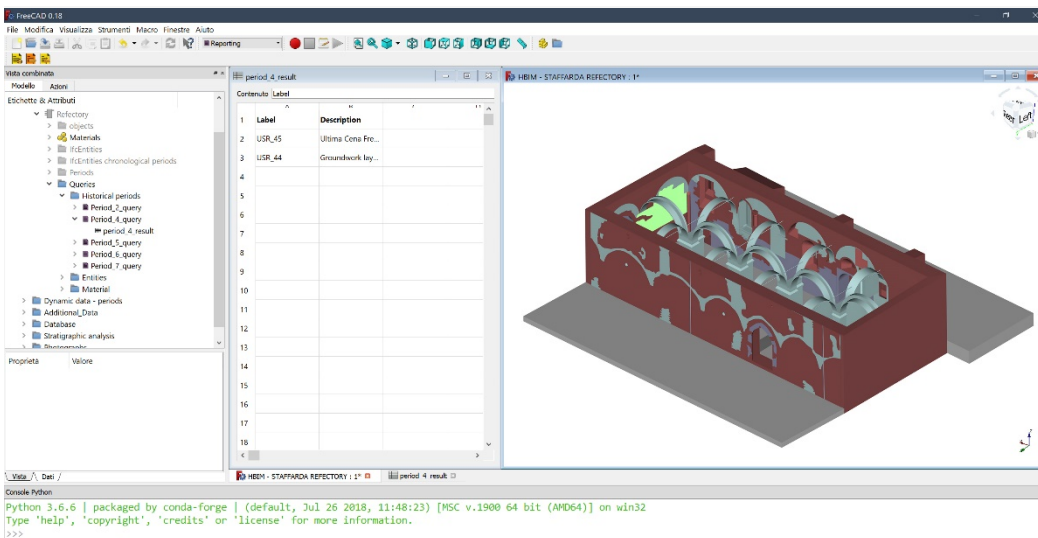

Figure 294. Reporting query: select objects of Period 4 (results on datasheet) - (elaboration F. Diara).

## Query\_22: Select objects with TAG “Period\_5\_1690-1750”

Query was written on statement configuration and the result is given by the datasheet report

Select Label from document Where Tag = 'Period\_5\_1690-1750'

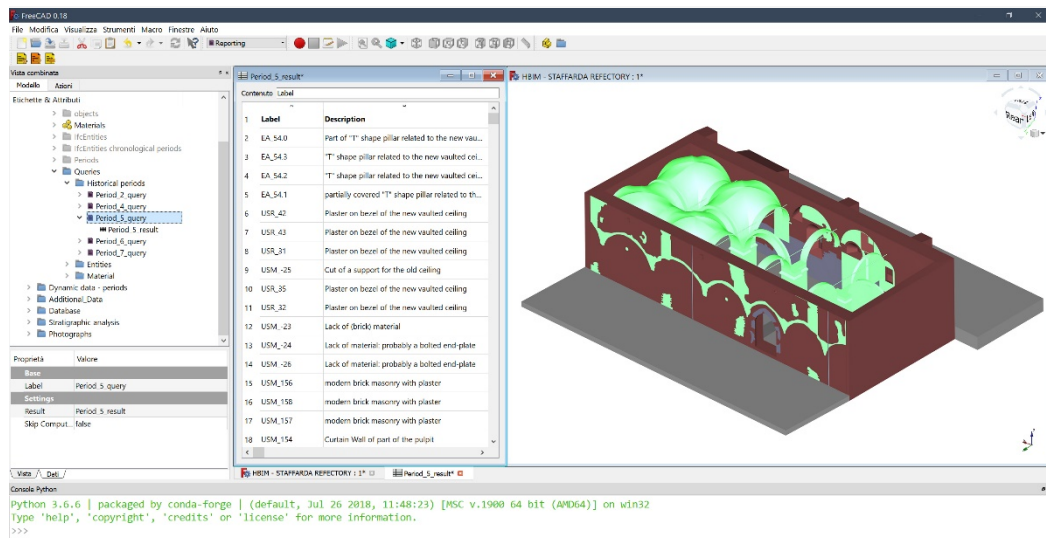

Figure 295. Reporting query: select objects of Period 5 (results on datasheet) - (elaboration F. Diara).

## Query\_23: Select objects with TAG “Period\_6\_1800-1900”

Query was written on statement configuration and the result is given by the datasheet report

Select Label from document Where Tag = 'Period\_6\_1800-1900'

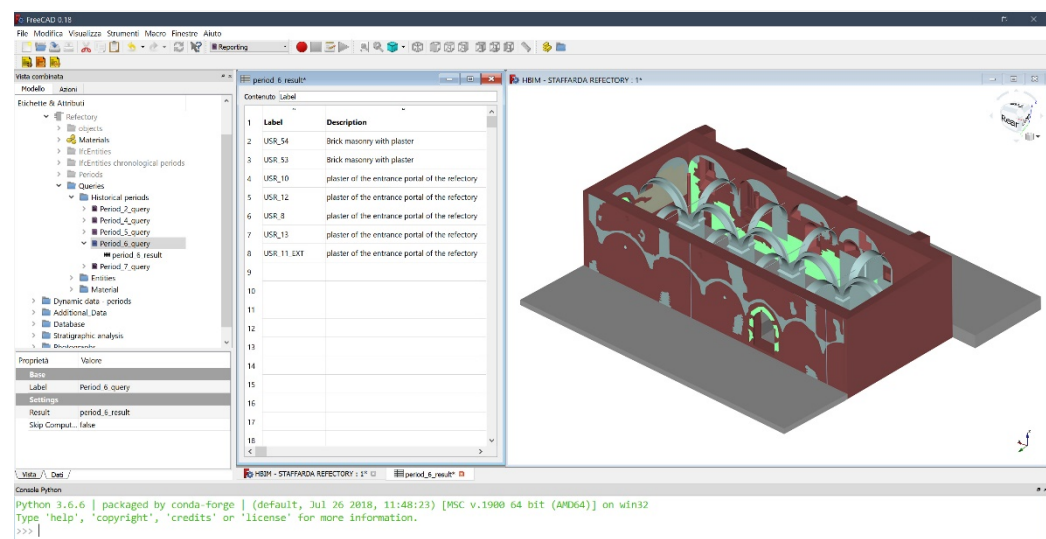

Figure 296. Reporting query: select objects of Period 6 (results on datasheet) - (elaboration F. Diara).

## Query\_24: Select objects with TAG “Period\_7\_1910-1925”

Query was written on statement configuration and the result is given by the datasheet report

Select Label from document Where Tag = 'Period\_7\_1910-1925'

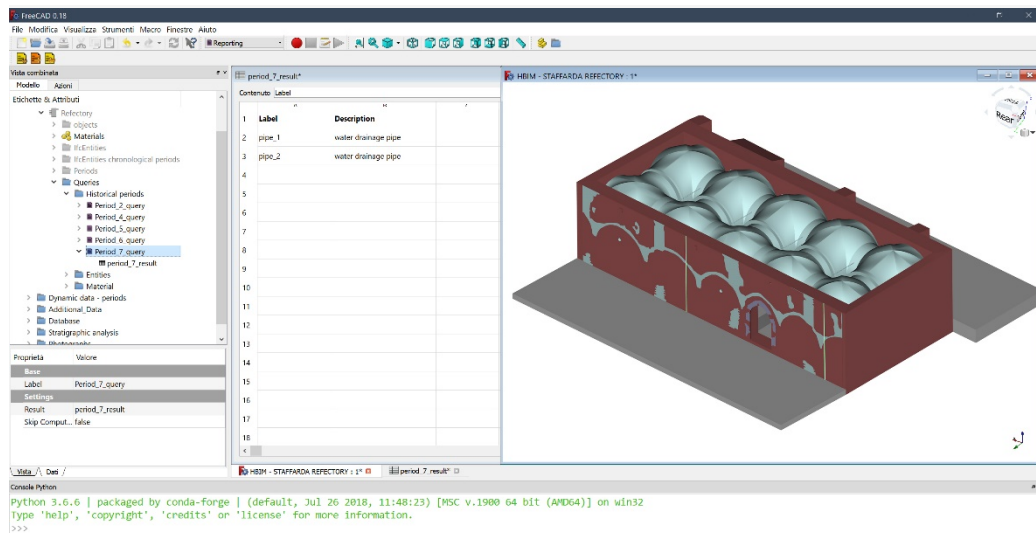

Figure 297. Reporting query: select objects of Period 7 (results on datasheet) - (elaboration F. Diara).

As mentioned before, these query analyses based on SQL statement and automatic spreadsheet report can be easily to export in CSV format in order to manage and exchange data externally. Here is the example of the IFC\_Wall query exportation in CSV and following data managing into Google Documents:

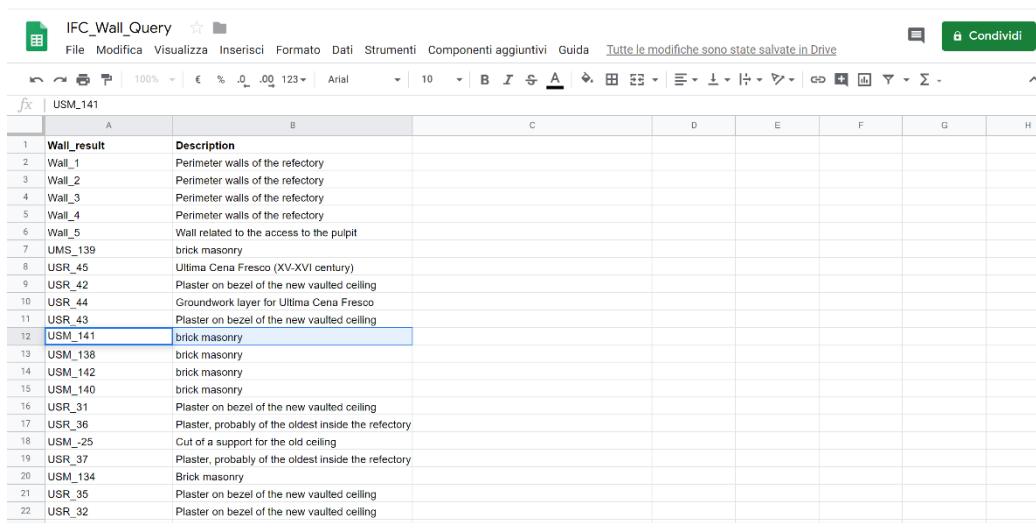

Figure 298. Exported data from IFC wall query to Google document



## 11.2.4 Querying the refectory - JSON and BIMServer

Query processes have been conducted also testing BIMServer<sup>43</sup> web software as A web server. As mentioned before, despite FreeCAD has been tested in order to carry out query analyses based on SQL language, the investigation inside BIMServer have been conducted by using JavaScript Object Notation (JSON) query language. Moreover, these interrogations are focusing on the ISO standards concerning IFC schemas (wall, column, window, beam, and so on) because, as mentioned in previous chapters, these viewers and servers software are thought, like BIM software, for AEC industry and obviously are strictly based on IFC schemas. For these reasons, query investigation concerning the refectory has been carried out apart from the custom demonstrative classification (designed for different architectural elements and stratigraphic units) focusing just on ISO and standards classifications.

As far as the software is concerned, BIM Server is an open source solution that allow sharing BIM projects and objects based on IFC schemas, moreover this tool can be managed by using an online server or by localhost (Logothetis et al., 2018; Diara et al., 2018). Being an open source tool, it requires some installation arrangements: in this sense, Java package is a required tool to be installed. Furthermore, BIMServer is also an integrated tool inside FreeCAD software, but in order to correctly implement this solution to the BIM platform JSON and Requests Phyton modules are required.

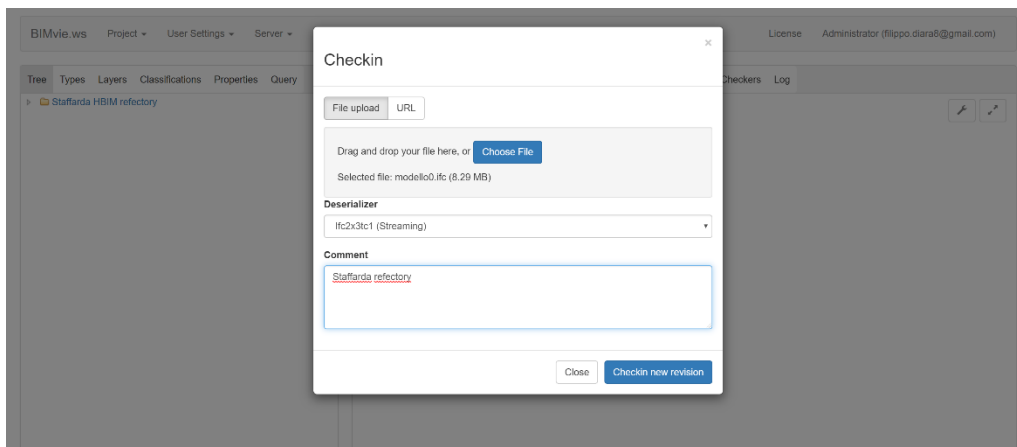

Figure 299. Model check-in inside the BIMServer platform

---

<sup>43</sup> [www.bimserver.org/](http://www.bimserver.org/)

How BIMServer works? This tool is essentially a BIM object visualizer and sharing software thanks to its sub-tool BIMvie.ws, and it allows us to visualize, analyse and query IFC objects as well as make updating revisions to other collaborators (Logothetis et al., 2018; Diara et al., 2018). Inside BIMServer a critical point is concerning the 3D visualization, because the model uploaded is rebuilt as a triangulated object through the predefined rendering engines inside the tool. For this reason, different parametric objects, in particular vaults objects, are represented in a triangulated-based way. Moreover, the visualization objects based on IFC WINDOW role is reproduced semi-transparent.

One of these important features is the query possibility, based on standard IFC schemas, in fact during the BIMServer configuration is possible the installation of different query engines (as a plugin), such as BimQL and JavaScript Object Notation, and this last one is based on the eclipse modelling framework and Oracle Berkeley DB, a basic database inside BIM Server (Lee et al., 2014).

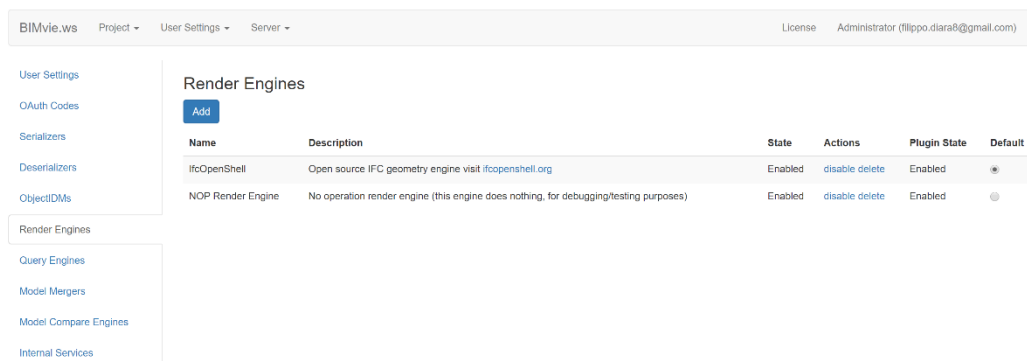

Figure 300. Render Engines inside BIMServer

As mentioned before, BIMServer has been tested by performing JavaScript Object Notation query language. Inside the web tool, the queries drop-down menu includes different predefined query focusing on architectural elements analysis as much as the query string below the menu is completely editable depending on specific needs. In fact, these strings can be modified, according to building entities classification and particular relations. Here are different JSON queries performed inside BIMServer:

## Query\_25: Select IFC WALL entities

Query was selected on the predefined drop-down menu of BIMServer;  
Based on ISO normative and standard classification

```
{  
  
  "type": {  
  
    "name": "IfcWall",  
  
    "includeAllSubTypes": true  
  
  }  
  
}
```

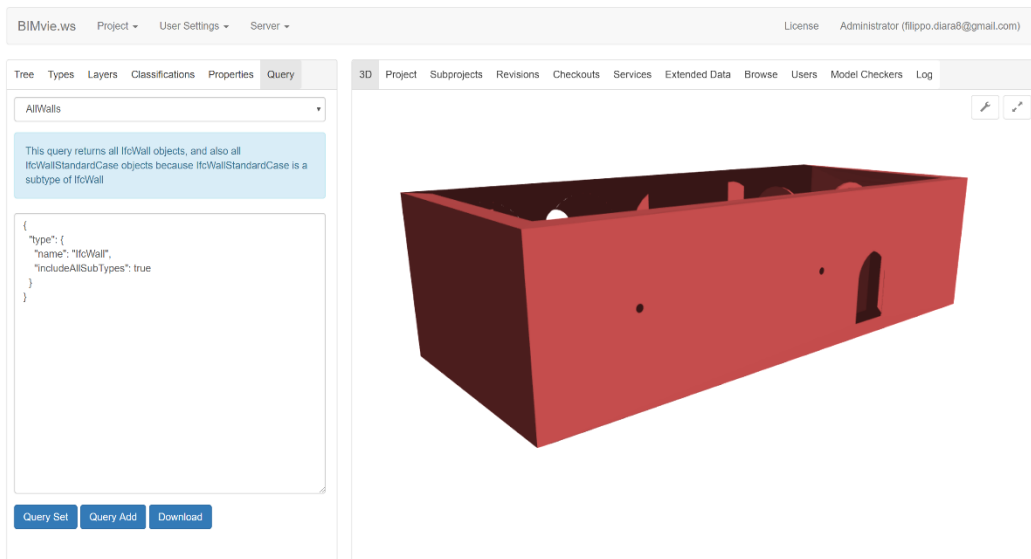

Figure 301. Wall entities query inside BIMServer (elaboration F. Diara).

## Query\_26: Select IFC ROOF entities

Query was selected on the predefined drop-down menu of BIMServer;  
Based on ISO normative and standard classification

```
{  
  
  "type": {  
  
    "name": "IfcRoof",  
  
    "includeAllSubTypes": true  
  
  }  
  
}
```

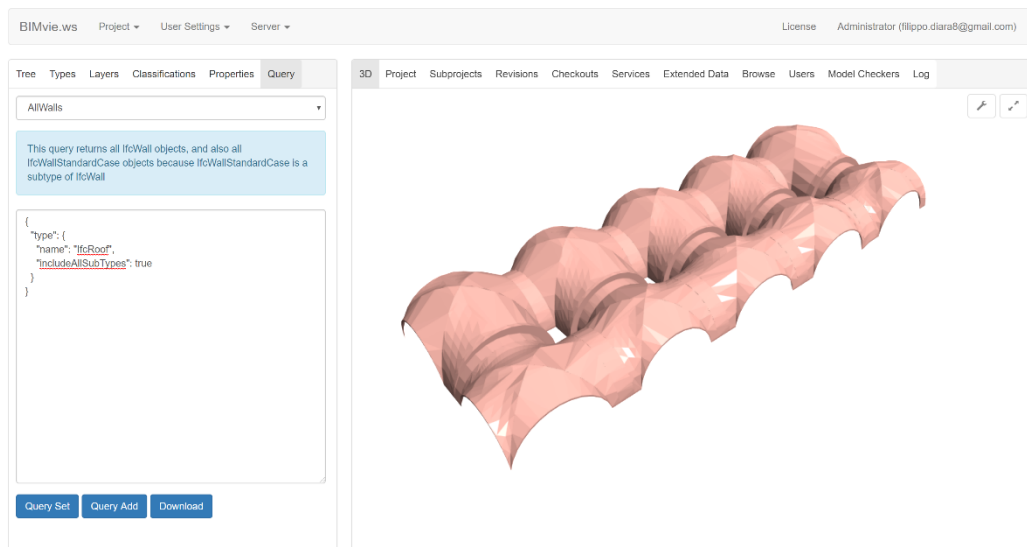

Figure 302. Roof entities query inside BIMServer (elaboration F. Diara).

### Query\_27: Select IFC BUILDING STOREY entities

Query was selected on the predefined drop-down menu of BIMServer;  
Based on ISO normative and standard classification

```
{  
  
  "type": {  
  
    "name": "IfcBuildingStorey",  
  
    "includeAllSubTypes": true  
  
  }  
  
}
```

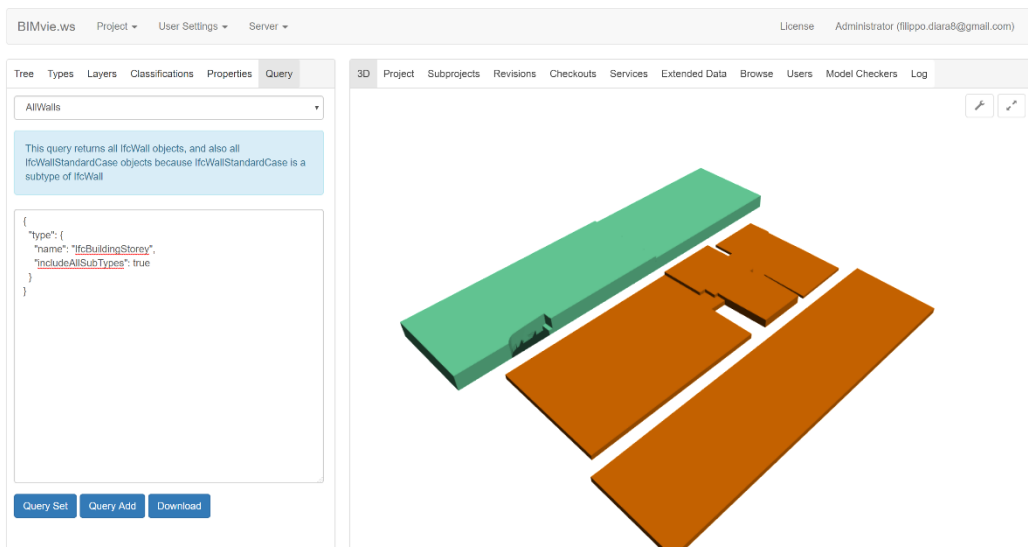

Figure 303. Building storey entities query inside BIMServer (elaboration F. Diara).

## Query\_28: Select IFC WALL – BUILDINGELEMENT – DOOR - WINDOW

Query was selected on the predefined drop-down menu of BIMServer;

Based on ISO normative and standard classification

```
{
  "types": [
    {
      "name": "IfcWall",
      "includeAllSubTypes": true
    },
    {
      "name": "IfcBuildingElement"
    },
    {
      "name": "IfcDoor"
    },
    {
      "name": "IfcWindow"
    }
  ]
}
```

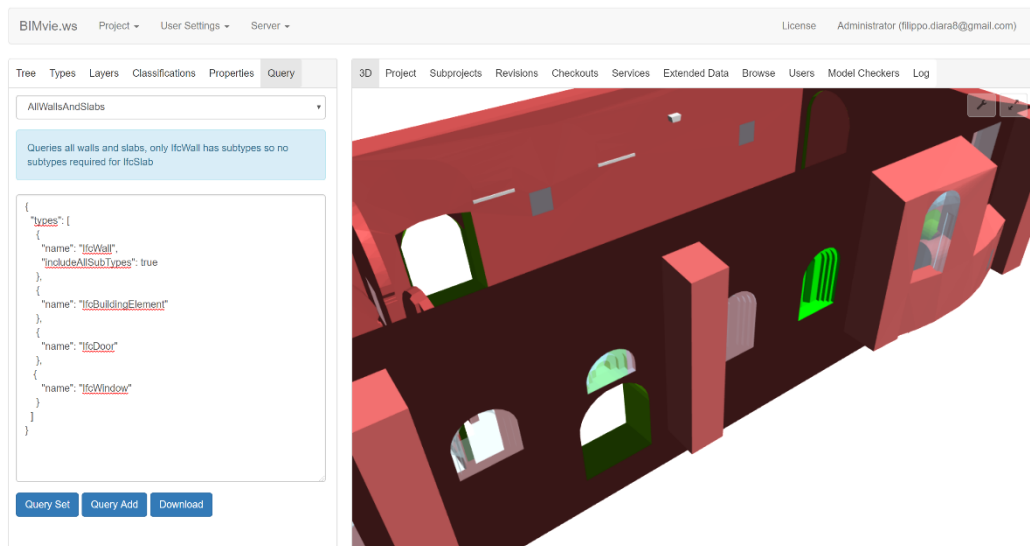

Figure 304. Query based on selection of wall, door, window, building elements (elaboration F. Diara).

## Query\_29: Select IFC BUILDING STOREY – COLUMN - ROOF

Query was selected on the predefined drop-down menu of BIMServer;  
Based on ISO normative and standard classification

```
{
  "types": [
    {
      "name": "IfcBuildingStorey",
      "includeAllSubTypes": true
    },
    {
      "name": "IfcColumn"
    },
    {
      "name": "IfcRoof"
    }
  ]
}
```

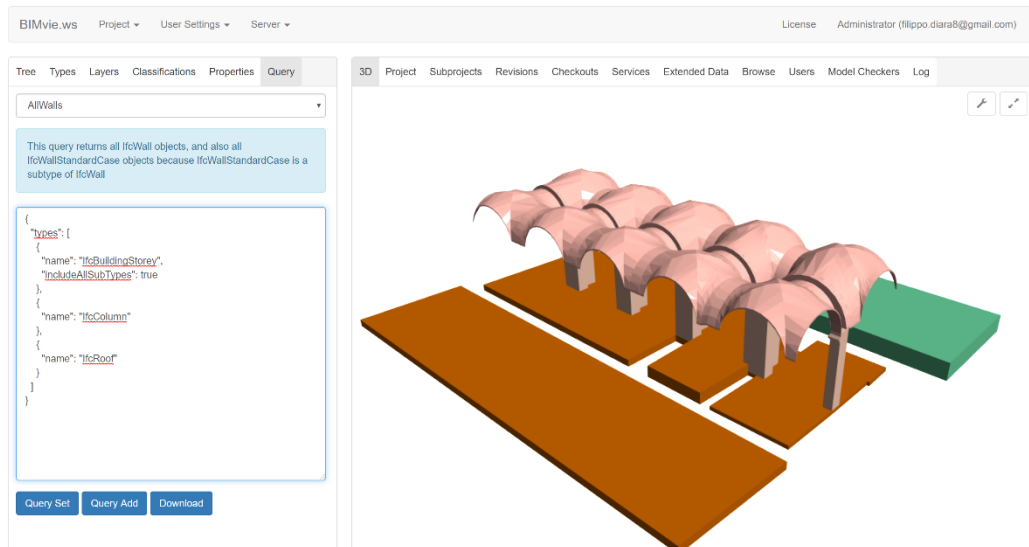

Figure 305. Query based on selection of building storey, column, roof (elaboration F. Diara).

### Query\_30: Select type IFC DOOR and WINDOW

Query was selected on the predefined drop-down menu of BIMServer;  
Based on ISO normative and standard classification

```
{  
  "types": ["IfcDoor", "IfcWindow"]  
}
```

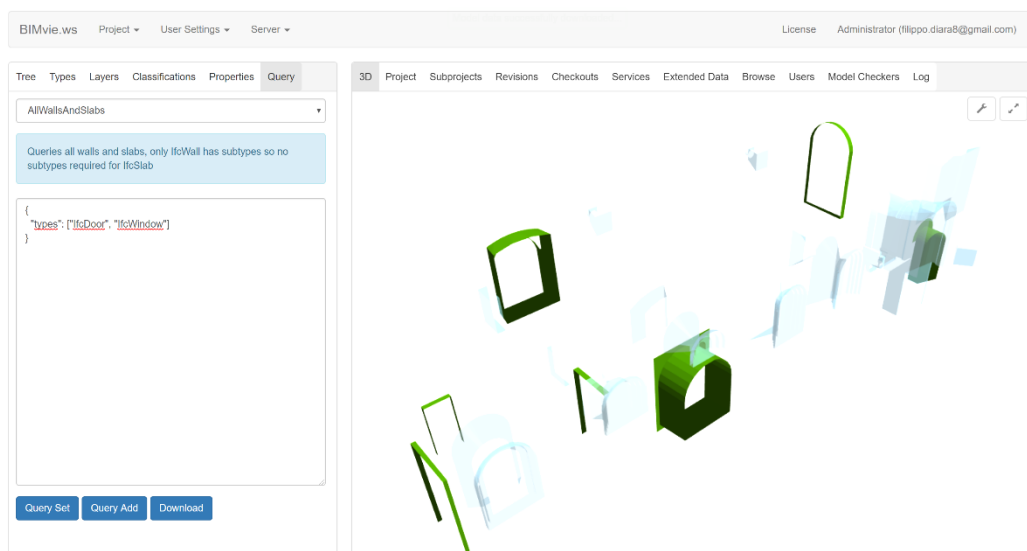

Figure 306. Query based on selection of window and door type inside BIMServer (elaboration F. Diara).



### 11.2.5 BIM Vision analyses

Further analyses, after the creation of the HBIM model of the refectory, have been performed, in addition to web servers, also by using dynamic viewers and analysers.

BIM Vision from Datacomp<sup>44</sup> is a freeware software able to visualize IFC objects (based on IFC2X3 schema) created by using BIM platform such as Autodesk Revit or Graphisoft Archicad or other BIM solutions. In this regard, BIM Vision software has been tested as analyser, manager and viewer software able to perform metric analyses on IFC objects (classified following the ISO standard classification mentioned before), such as calculate distances, areas and volumes of selected shapes. Moreover, interesting operations can be performed in order to obtain dynamic planar architectural sections of the model including the possibility to edit and export the resulted sections. For these reasons, BIM Vision, despite a large number of analysers and viewers, could be considered a good solution in order to carry out dynamic metric analyses on IFC models. Moreover, this solution should be considered also by external users or collaborators thanks to its user-friendly interface and easiness application.

By using this useful tool, have been performed analyses on the IFC model of the refectory for the purpose of generating planar sections and metric investigation: in this sense, the imported model was the model obtained using the ISO standard classification for architectural elements, which, inside the software are described by predefined colours and transparencies (such as windows).

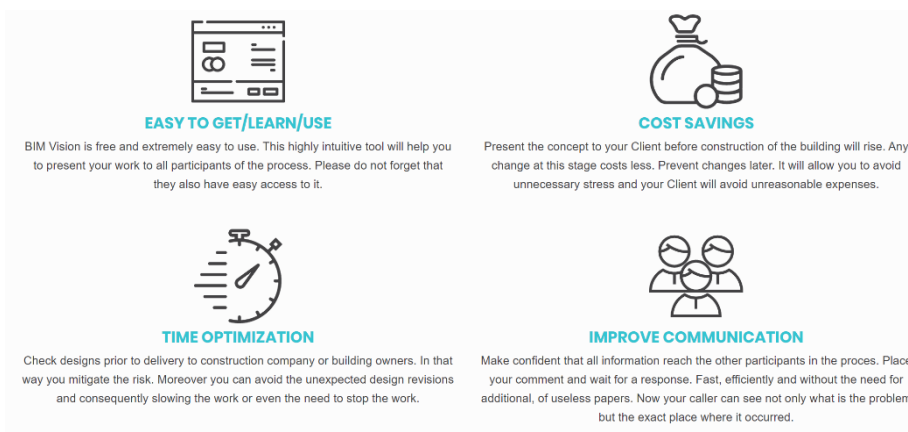

Figure 307. Main claimed benefits of BIM Vision

<sup>44</sup> [www.bimvision.eu](http://www.bimvision.eu)

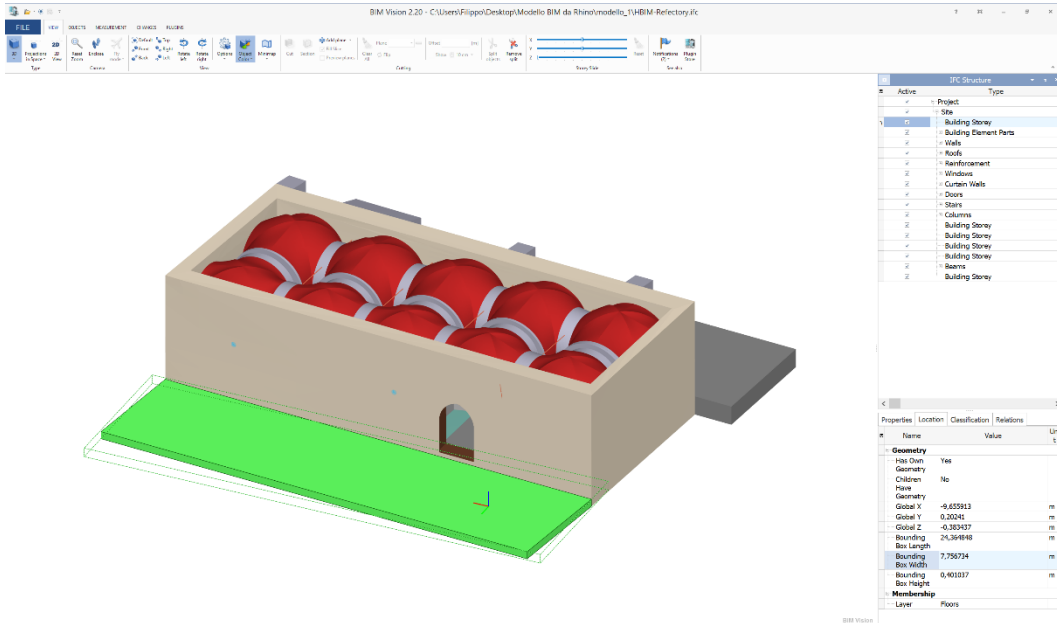

Figure 308. Main interface of BIM Vision: on the right the architectural entities tree and their properties below (elaboration F. Diara).

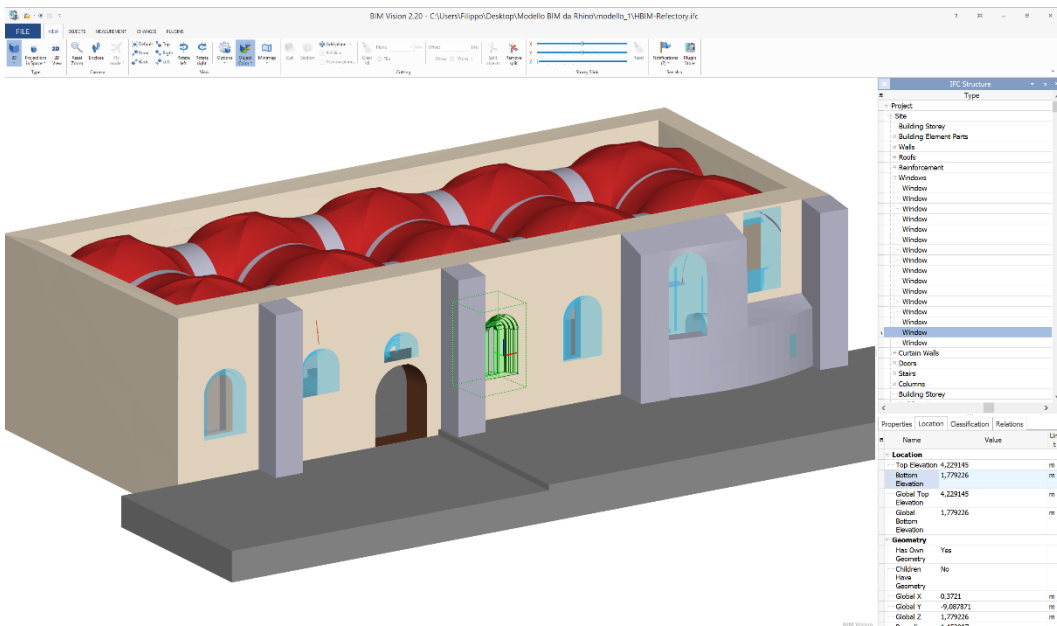

Figure 309. Windows analysis of the refectory and their properties below (on the right) - (elaboration F. Diara).

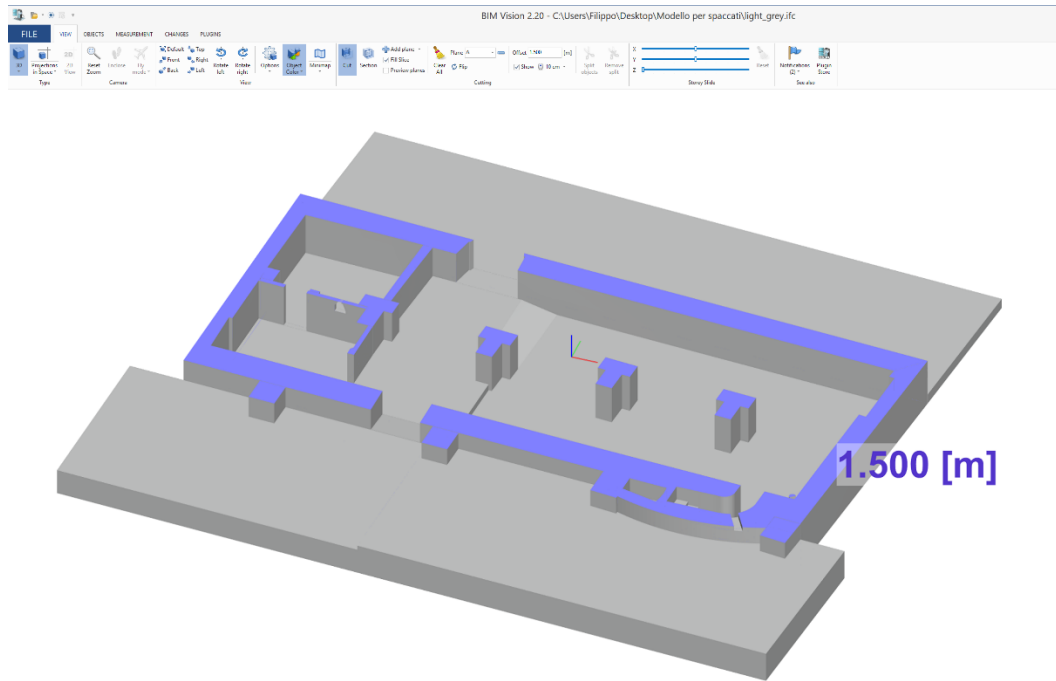

Figure 310. Section of the refectory with BIM Vision: Z plane at 1.50m of height (elaboration F. Diara).

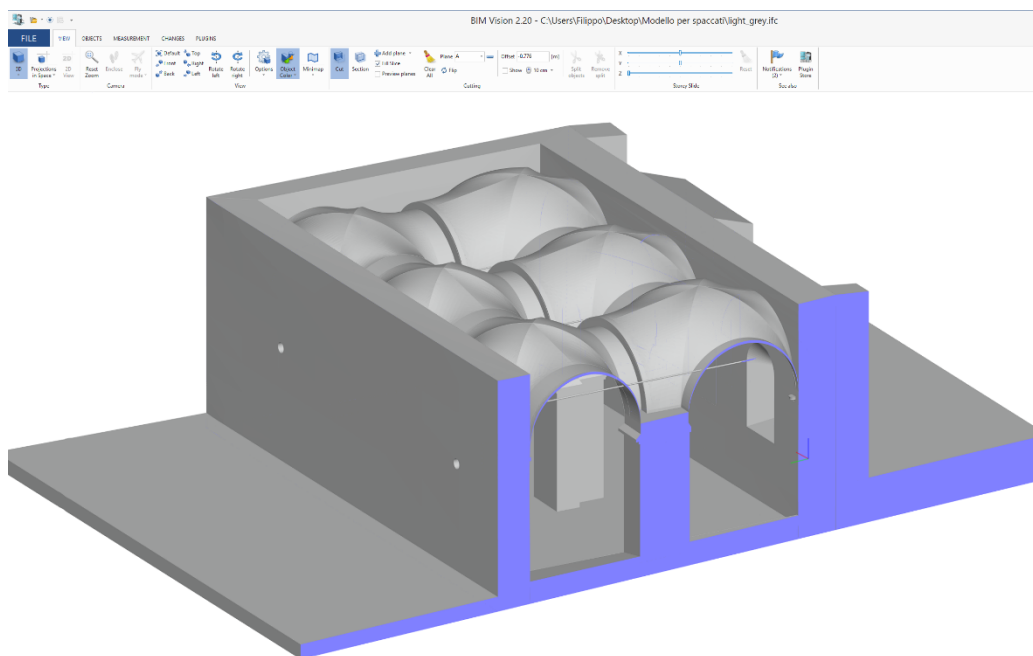

Figure 311. Section of the refectory with BIM Vision: X plane section (elaboration F. Diara).

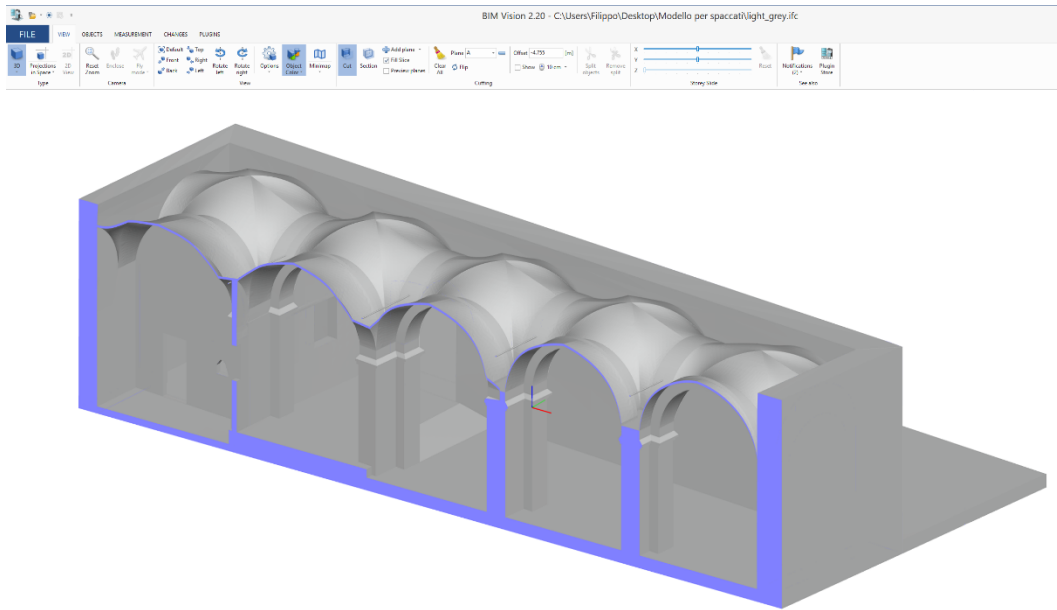

Figure 312. Section of the refectory with BIM Vision: Y plane section (elaboration F. Diara).

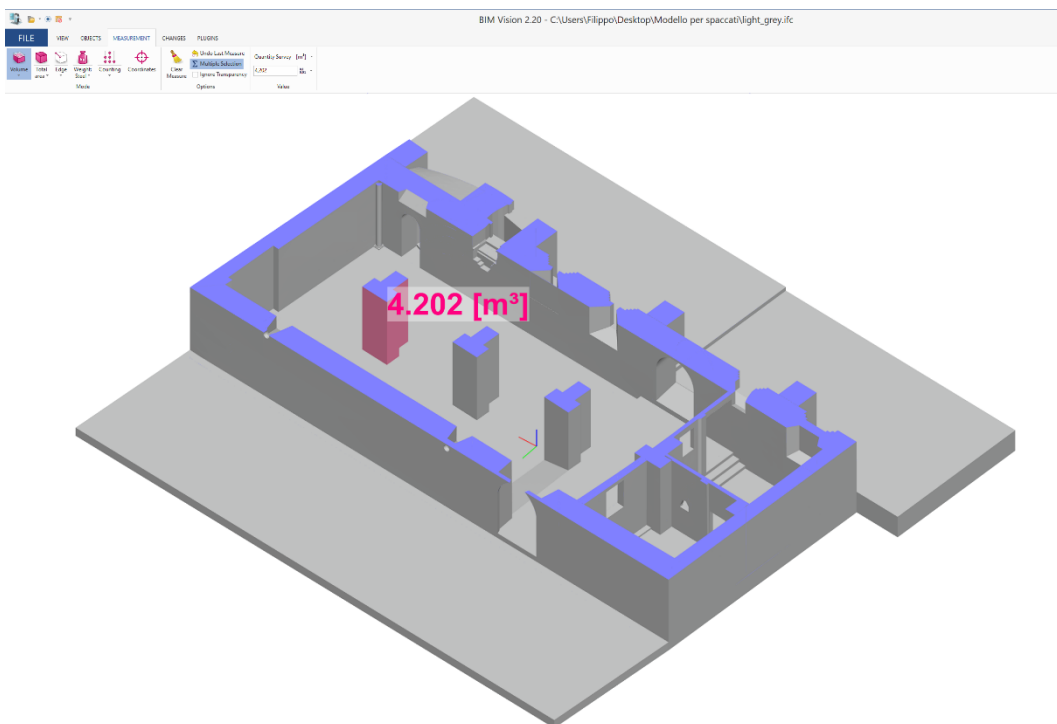

Figure 313. Section on Z plane and area analysis of the refectory with BIM Vision (elaboration F. Diara).

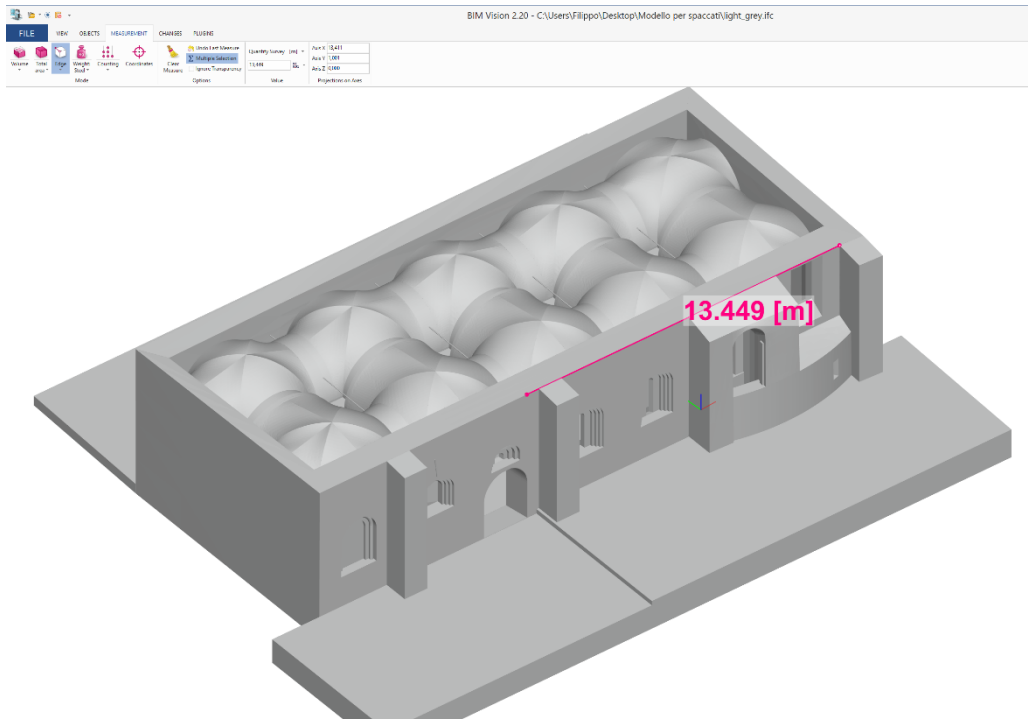

Figure 314. Distances analysis of the refectory with BIM Vision (elaboration F. Diara).

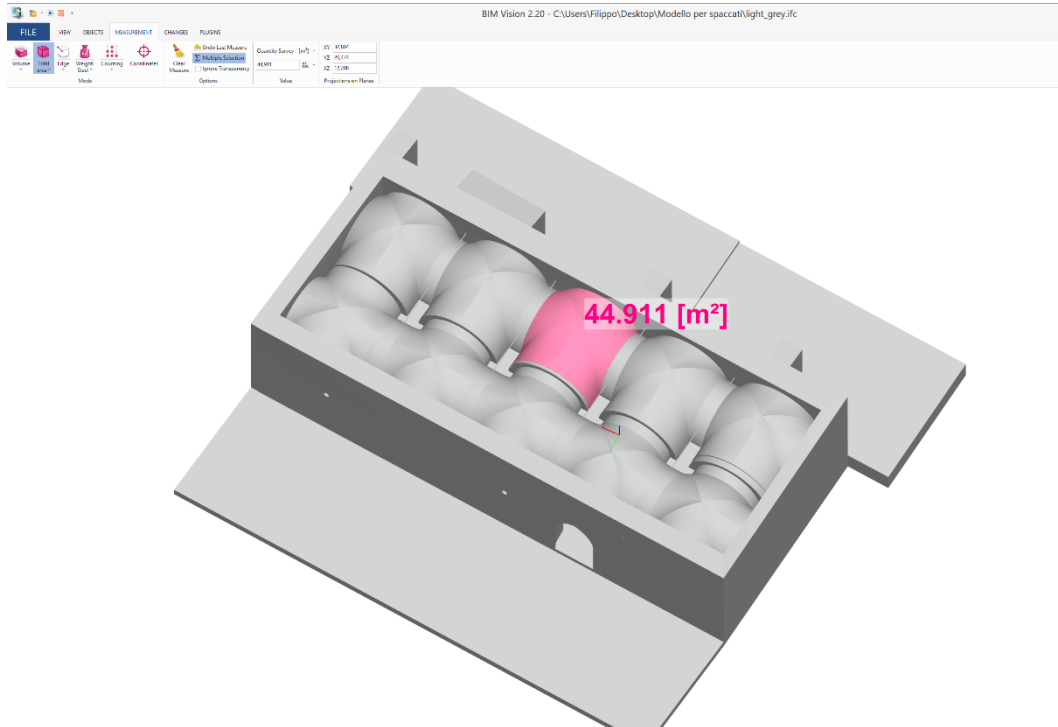

Figure 315. Areas analysis of the refectory with BIM Vision (elaboration F. Diara).

## 11.3 Knowledge sharing

Data communication is a fundamental step for the purpose of sharing data to people at the end of knowledge processes: in this sense communication is the dialogue moment between who carried out the research and who is getting the final data. The communication and investigation of HBIM data can be also carried out by performing third-parts analyses and using not common software in order to extract information from IFC files. Indeed, in addition to visualize, manage and query information concerning IFC objects inside FreeCAD, BIMServer or BIM Vision, these analyses can be carried out also externally by using different solutions, because, as mentioned in previous chapters, IFC objects are considered real database and data container. In this regard, in order to extract complete data set from an IFC model created with FreeCAD the **IFC File Analyser**, developed by the National Institute of Standards and Technology (NIST) has been tested. Moreover, this software has been developed also for the STEP file.

IFC File Analyzer<sup>45</sup> generates CSV (comma-separated values spreadsheet) or XLSX (Excel file format for data sheets) files from an uploaded IFC file. Through this operation all the information concerning the IFC file, including building elements, materials, geometry, relationship and other properties, can be extracted. Although CSV is the most used database format by considering its flexibility and easy access, a better solution could be the XLSX format for the creation of worksheets inside a single spreadsheet file, while the CSV exportation allows obtaining different file for each IFC entity. In this sense, by exporting XLSX file, the instances of the attributes of an IFC entity are stored in every row inside the worksheet (Diara et al., 2018).

After the extraction process, CSV and XLSX file containing data form IFC objects can be stored and managed inside a relational or spatial DBMS (Database Management System). This possibility is fundamental for the purpose of sharing information and then knowledge through most used information platforms: database. In this sense, the internal (integrated) BIM database and the possible external database are essential in order to collect, manage and spread a large amount of information concerning IFC objects (Logothetis et al., 2017b; Brusaporci et al., 2018).

---

<sup>45</sup> <https://www.nist.gov/services-resources/software/ifc-file-analyzer>

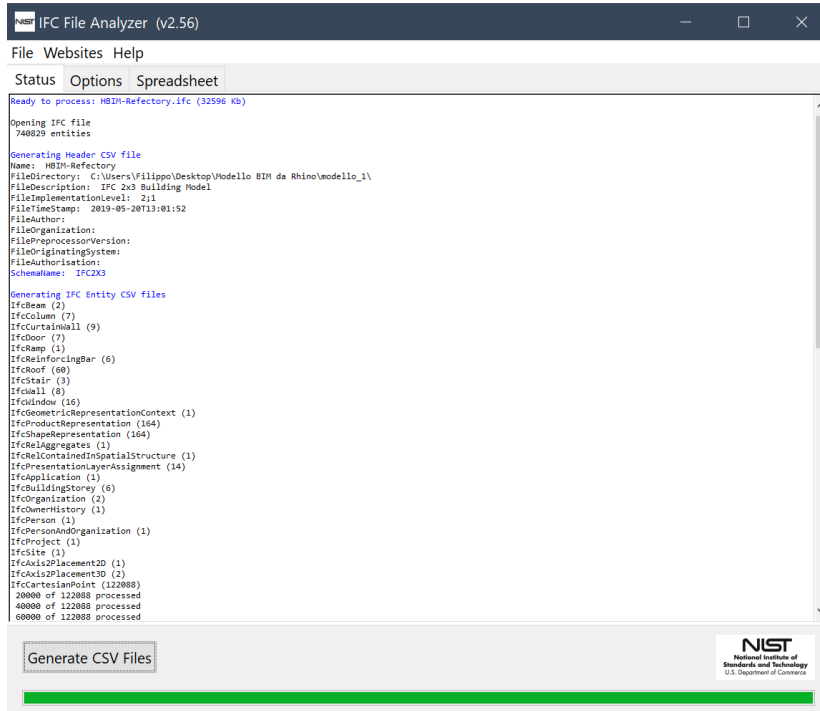

Figure 316. IFC file reading inside IFC File Analyzer

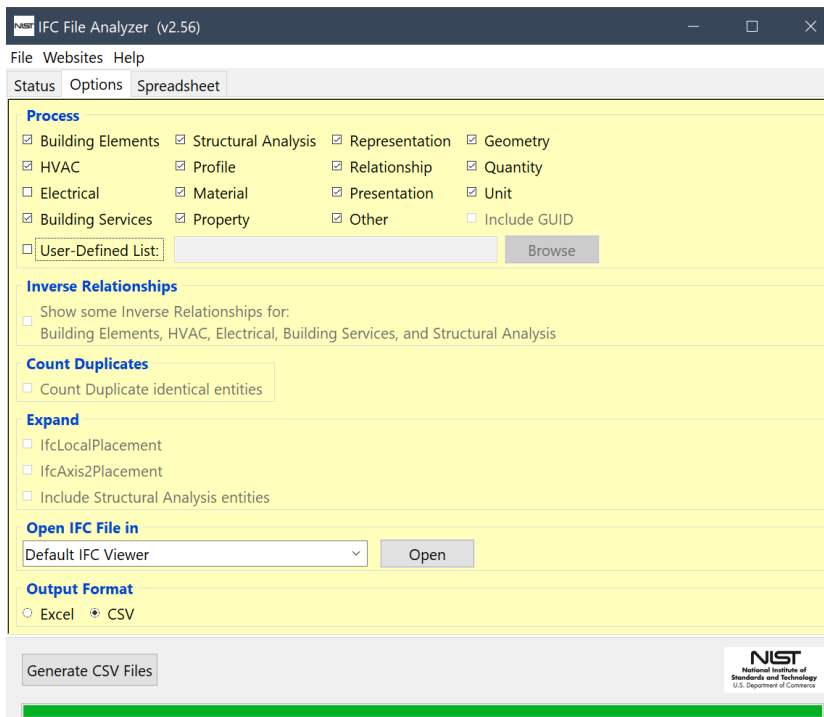

Figure 317. Datasheet generation options inside IFC File Analyzer

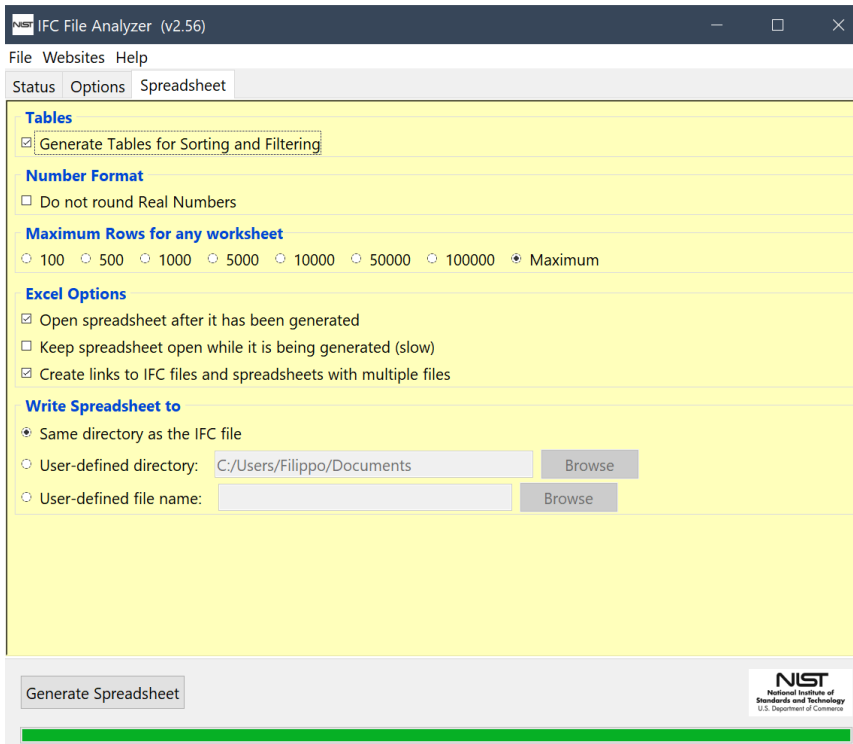

Figure 318. XLSX datasheet generation option inside IFC File Analyzer

|  |                  |          |          |
|--|------------------|----------|----------|
| Header.csv                             | 24/10/2019 08:47 | File CSV | 1 KB     |
| IfcApplication.csv                     | 24/10/2019 08:47 | File CSV | 1 KB     |
| IfcAxis2Placement2D.csv                | 24/10/2019 08:47 | File CSV | 1 KB     |
| IfcAxis2Placement3D.csv                | 24/10/2019 08:47 | File CSV | 1 KB     |
| IfcBeam.csv                            | 24/10/2019 08:47 | File CSV | 1 KB     |
| IfcBuildingStorey.csv                  | 24/10/2019 08:47 | File CSV | 1 KB     |
| IfcCartesianPoint.csv                  | 24/10/2019 08:48 | File CSV | 4.291 KB |
| IfcCartesianTransformationOperator2... | 24/10/2019 08:48 | File CSV | 1 KB     |
| IfcCartesianTransformationOperator3... | 24/10/2019 08:48 | File CSV | 1 KB     |
| IfcColumn.csv                          | 24/10/2019 08:47 | File CSV | 1 KB     |
| IfcConnectedFaceSet.csv                | 24/10/2019 08:48 | File CSV | 5 KB     |
| IfcConversionBasedUnit.csv             | 24/10/2019 08:52 | File CSV | 1 KB     |
| IfcCurtainWall.csv                     | 24/10/2019 08:47 | File CSV | 2 KB     |
| IfcDimensionalExponents.csv            | 24/10/2019 08:52 | File CSV | 1 KB     |
| IfcDirection.csv                       | 24/10/2019 08:48 | File CSV | 1 KB     |
| IfcDoor.csv                            | 24/10/2019 08:47 | File CSV | 2 KB     |
| IfcFace.csv                            | 24/10/2019 08:49 | File CSV | 7.382 KB |
| IfcFaceBasedSurfaceModel.csv           | 24/10/2019 08:49 | File CSV | 7 KB     |
| IfcFaceBound.csv                       | 24/10/2019 08:49 | File CSV | 1 KB     |
| IfcFaceOuterBound.csv                  | 24/10/2019 08:51 | File CSV | 6.376 KB |
| IfcGeometricRepresentationContext.csv  | 24/10/2019 08:47 | File CSV | 1 KB     |
| IfcLocalPlacement.csv                  | 24/10/2019 08:51 | File CSV | 6 KB     |
| IfcMeasureWithUnit.csv                 | 24/10/2019 08:52 | File CSV | 1 KB     |
| IfcOrganization.csv                    | 24/10/2019 08:47 | File CSV | 1 KB     |
| IfcOwnerHistory.csv                    | 24/10/2019 08:47 | File CSV | 1 KB     |

Figure 319. Generated CSV from IFC file with IFC File Analyzer



For computer science experts, information concerning IFC objects can be read and modify directly on source code by opening the IFC file by using code editors, such as Notepad++ for Windows and XCode for MacOS. Notepad++ is a full-featured text editor with features like: syntax highlighting and syntax folding, user defined syntax highlighting and folding, PCRE (Perl Compatible Regular Expression) search/replace, customizable GUI (Graphic user interface) with vertical tab and vertical document list, document map, word completion, macro recording and playback, launch with different arguments, and more. XCode is an integrated development environment (IDE), including a text editor, a compiler, and a build system into one software package. XCode is Apple’ official IDE for MacOS and iOS developers. Furthermore, it supports different development languages such as C, C++, Java, AppleScript, Python, Swift. By using these useful tools, the complete access and management of the IFC file become possible: properties such as description, roles, and classifications, can be read and modified easily. This approach is useful after the creation of the models to set and fix some IFC parameters and to verify the whole source code of the IFC model.

```

5372 #5365=IFCCARTESIANPOINT((0.,0.,0.));
5373 #5366=IFCAXIS2PLACEMENT3D(#5365,#5364,#5363);
5374 #5367=IFCLOCALPLACEMENT($,#5366);
5375 #5368=IFCSHAPEREPRESENTATION(#11,'Body','Brep',
      (#3188,#3322,#3510,#3680,#3859,#4047,#4199,#4306,#4404,#4484,#4654,#4734,#4814,#4894,#4974,#5054,#5098
5376 #5369=IFCPRODUCTDEFINITIONSHAPE($,$,#5368));
5377 #5370=IFCBUILDINGELEMENTPROXY('2_07QK31CHw9eMZ8MG7B8D',#5,'Apertura USM 30','',$,#5367,#5369,$,.ELEMENT.);
5378 #5371=IFCCARTESIANPOINT((0.836778015,0.25945462,0.015));
5379 #5372=IFCCARTESIANPOINT((0.836778015,0.25945462,0.));
5380 #5373=IFCCARTESIANPOINT((0.836778015,0.253604691,0.));
5381 #5374=IFCCARTESIANPOINT((0.836778015,0.253604691,0.015));

```

Figure 320. “BuildingElementProxy” entity detection inside an IFC file by using XCode

```

5373 #5366=IFCAXIS2PLACEMENT3D(#5365,#5364,#5363);
5374 #5367=IFCLOCALPLACEMENT($,#5366);
5375 #5368=IFCSHAPEREPRESENTATION(#11,'Body','Brep',
      (#3188,#3322,#3510,#3680,#3859,#4047,#4199,#4306,#4404,#4484,#4654,#4734,#4814,#4894,#4974
5376 #5369=IFCPRODUCTDEFINITIONSHAPE($,$,#5368));
5377 #5370=IFCELEMENT('2_07QK31CHw9eMZ8MG7B8D',#5,'Apertura USM 30','',$,#5367,#5369,$,.ELEMENT.);
5378 #5371=IFCCARTESIANPOINT((0.836778015,0.25945462,0.015));
5379 #5372=IFCCARTESIANPOINT((0.836778015,0.25945462,0.));
5380 #5373=IFCCARTESIANPOINT((0.836778015,0.253604691,0.));
5381 #5374=IFCCARTESIANPOINT((0.836778015,0.253604691,0.015));
5382 #5375=IFCPOLYLOOP((#5371,#5372,#5373,#5374));

```

Figure 321. “BuildingElementProxy” entity replacement with “Element” by using XCode

Although it seems a flexible operation, the modification of the IFC source code should be carried out and planned carefully by considering also the integrity of the model, especially whether it is related to other IFC models (backup is strictly recommended) and also according to the IFC2X3 definitions schema (Diara et al., 2018). The extraction of data from IFC objects allows the management of geometric and historical information on external platforms. In this regard, the creation of a relational database management system (RDBMS) should be fundamental in order

to collect and query geometric and alphanumeric data alongside the BIM platform that can be used to plan and perform future interventions (Lo Turco et al, 2017a). Furthermore, database advantages can be several, for example the data backup and data recovery as well as sharing and integration processes are fundamental steps on the same level of data analysis.

Moreover, for further analyses, the creation of a spatial database should be also considered, because it becomes very important to manage geometrical data, location of elements and topological data through their spatial relations. In this sense, continuing working rely on open source solutions the utilization of the PostGIS plugin inside the PostgreSQL database should be taken into account. This open source plugin allows managing geographic data for the PostgreSQL object-relational database (Logothetis et al, 2017b). The future possibility to include in this project spatial analyses through the usage of PostgreSQL and PostGIS plugin ensures to manage the collected data into a 3D GIS system, useful in order to connect this HBIM project to a GIS project, by relating metric information, architectural entities, geographic and spatial relations (Rinaudo F., 2016; Diara et al., 2018).

Furthermore, another important aspect of sharing process not to be underestimated is concerning the **portability and accessibility** of data and then of knowledge. In this sense, VR (virtual reality) and AR (augmented reality) integration to BIM and HBIM projects give a fundamental support to immersive analysis as well as the accessibility and usability of data (Balletti et al., 2019; Banfi et al., 2019); at the same time mobile devices (especially tablet and pads) play an important role for the portability and easiness of managing and exchanging three-dimensional and semantic data in an easy and smart way (Barazzetti et al., 2015). All these enhancement supports can be easily performed by using online simple viewers and user-friendly platforms, such as Sketchfab<sup>46</sup>, that is useful and powerful online platform for 3D models easy sharing, especially for a not specialized audience. One of the advantages of this platform is the possibility to include inside the uploaded models different text annotations useful for a synthetic and punctual informative dimension. Moreover, in addition to being suitable for the VR experience, Sketchfab is also a mobile application (for iOS and Android) able to always connect us with our 3D models. In this regard, the online platform has been tested and used just in order to share simplified and conceptual models of the actual refectory and the proposed first construction of the building<sup>47</sup>.

---

<sup>46</sup> <https://sketchfab.com/>

<sup>47</sup> The simplified and conceptual models of the refectory are available by scanning the QR code (Fig.331), or by visiting this page <https://sketchfab.com/philixx88>

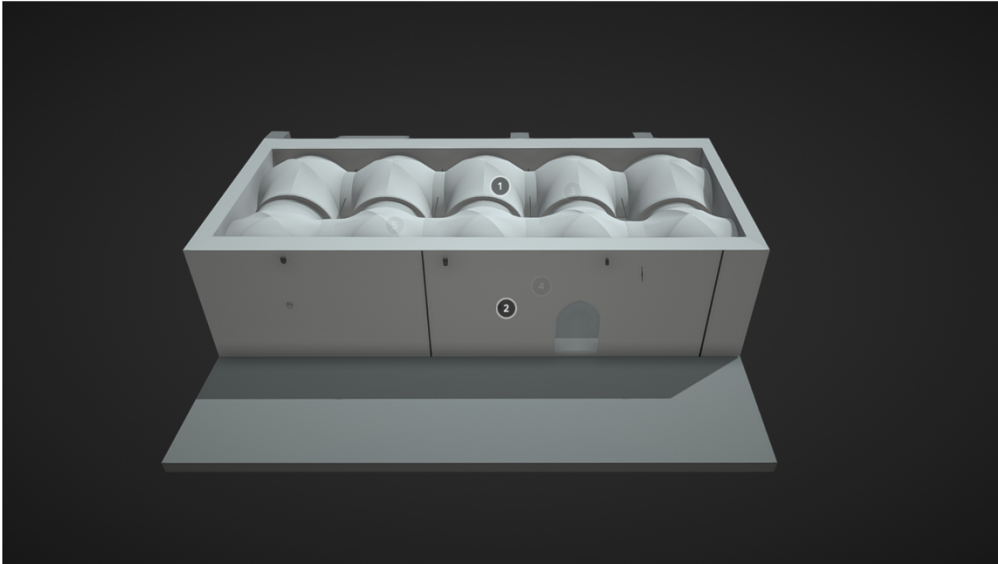

Staffarda refectory

3D Model

Figure 322. Staffarda refectory simplified and conceptual NURBS model inside Sketchfab (elaboration F. Diara).

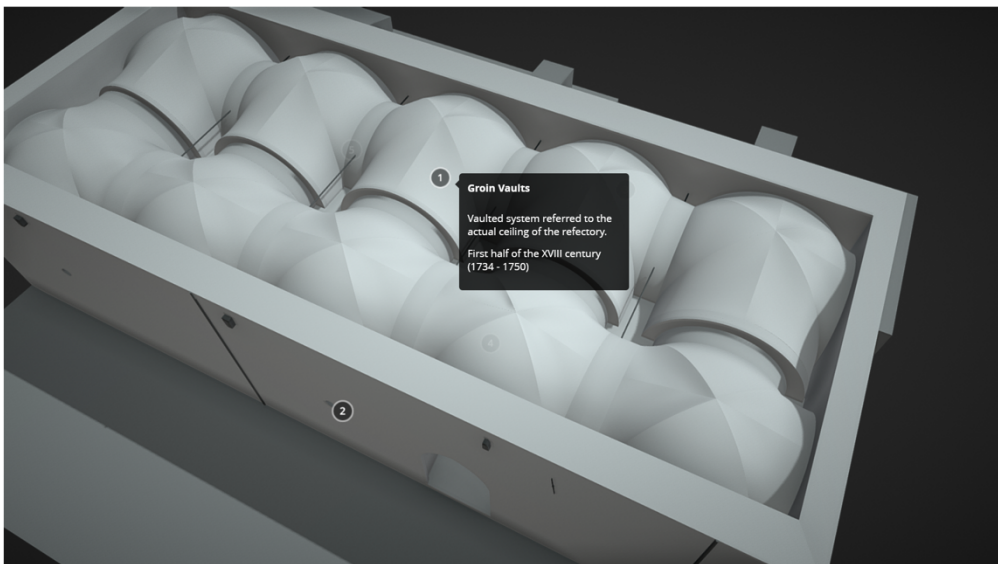

Staffarda refectory

3D Model

Figure 323. Staffarda refectory annotative point concerning the vaulted system (elaboration F. Diara).

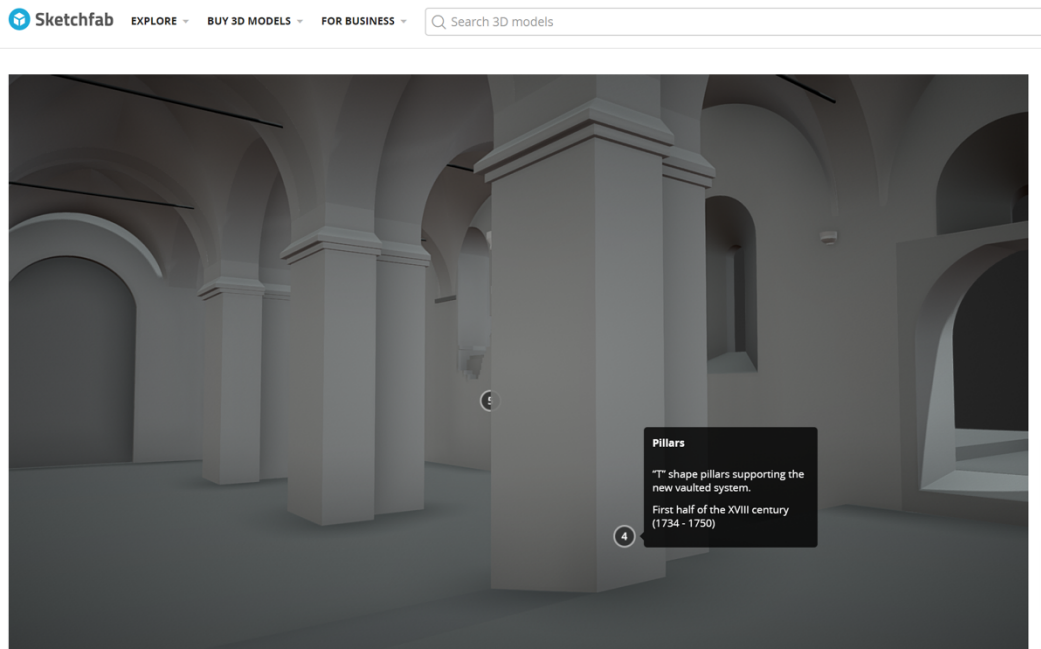

Staffarda refectory  
3D Model

Figure 324. Staffarda refectory annotative point concerning pillars (elaboration F. Diara).

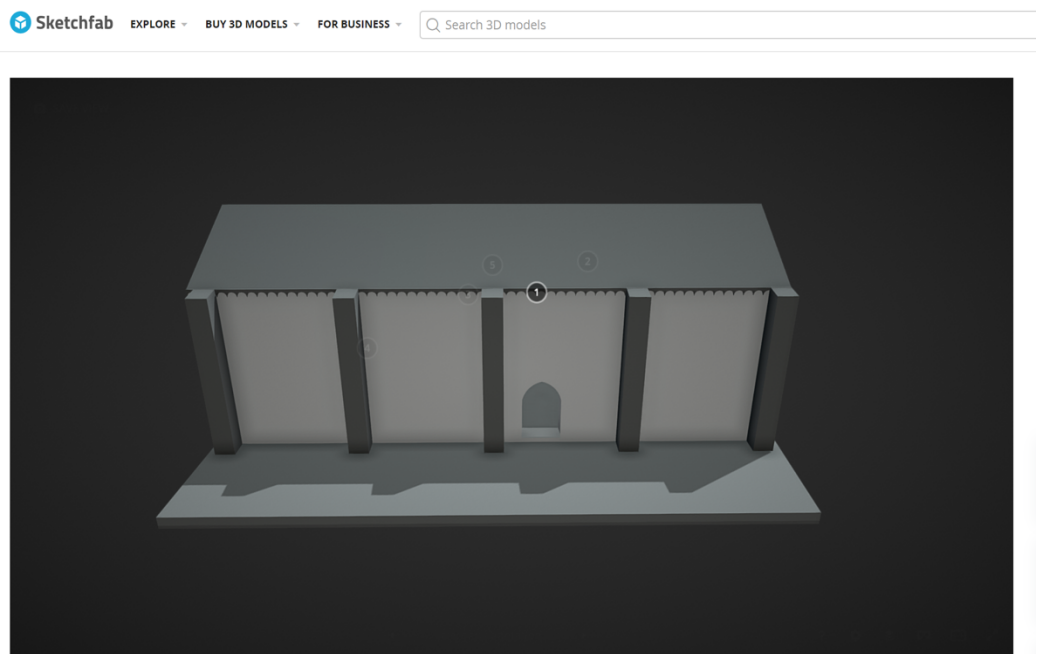

Staffarda refectory - proposal model  
3D Model

Figure 325. Staffarda refectory simplified NURBS proposal model inside Sketchfab (elaboration F. Diara).



Staffarda refectory - proposal model  
3D Model

Figure 326. Staffarda refectory proposal model: annotation point for buttresses (elaboration F. Diara).



Staffarda refectory - proposal model  
3D Model

Figure 327. Staffarda refectory proposal model: annotation point for the pulpit (elaboration F. Diara).



Staffarda refectory - proposal model  
3D Model

Figure 328. Staffarda refectory proposal model: annotation point for diaphragm arches (elaboration F. Diara).

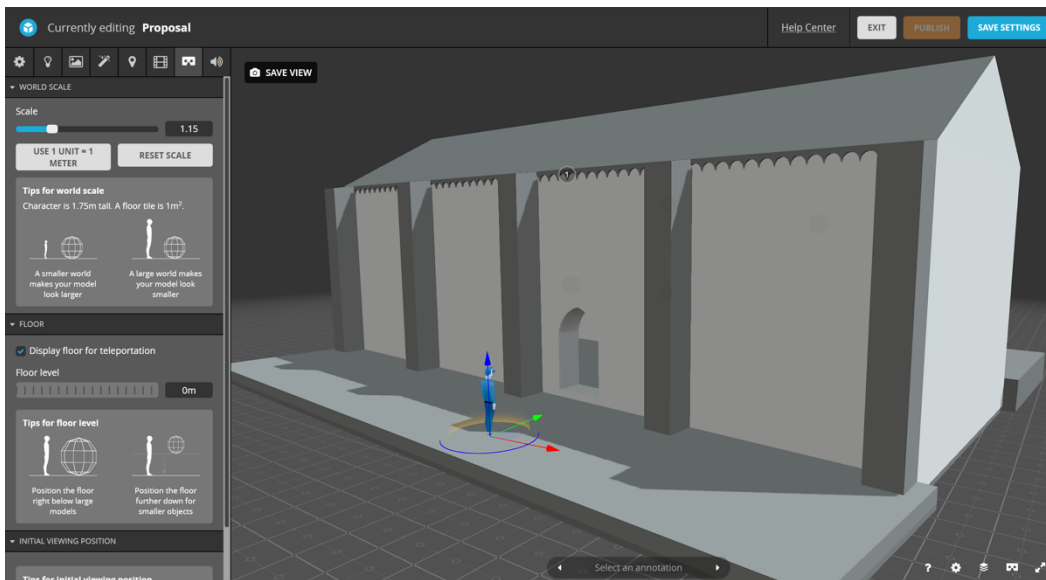

Figure 329. Staffarda refectory proposal model: VR settings inside Sketchfab (elaboration F. Diara).



Figure 330. Staffarda refectory model on Sketchfab iPad platform (elaboration F. Diara).



Figure 331. QR code link to Sketchfab models

# Chapter 12

## Results

These analyses and experimentation carried out till now allow us to draw some results, based on initial objectives and purposes concerning this project. Briefly, the project here presented was based on the creation of a custom workflow thought for the creation of an open source HBIM platform (FreeCAD) integrating historic information concerning the wall stratification of the refectory as well as a pure free form modeller as Rhinoceros for the refectory modelling phase. So, this workflow started with the metric survey and stratigraphic survey of the Staffarda refectory, continued in parallel with the set-up of the BIM platform, the modelling phase using Rhinoceros and the stratigraphic analysis concerning the internal walls of the refectory and the south front of the cloister of Staffarda abbey (where is the entrance of the refectory). Next, this workflow moved from the parametrization of architectural elements modelled to the chronological interpretation of the refectory based on the stratigraphy, then after this phase the HBIM platform, containing the historical information, has been designed step by step also by including custom modification such as IFC roles and custom queries.

Then, after we have seen what has been produced, initial questions and purposes can be compared with the obtained results. The first question was about the possibility to create a **custom BIM platform for Cultural Heritage assets (HBIM)**, such as for historical building and archaeology field. The answer to this question can be found by analysing the FreeCAD workflow, from the initial set-up to the query result. In this sense, FreeCAD has proved to be a reliable and proper solution for a different point of view. First of all, being an open source solution, this tool can adapt its features to specific needs by including additional workbenches and macros in order to enrich and modify the default workflow for a BIM creation. From a compatibility point of view, FreeCAD has proved to be able to read, modify and parametrize NURBS objects obtained with Rhinoceros software proving itself to be a proper open source solution for the purpose of



exchanging different free form objects. In this sense, due to its modelling and tools limitations, FreeCAD could combine its workflows with free form modellers such as Rhinoceros, and this closely unusual cooperation (between open source and commercial software) could be considered a good solution, avoiding compromises with the modelling phase (Diara et al., 2019).

Moreover, inside the modification panorama concerning this project is also included the FreeCAD IFC schema modification for the purpose of including also particular architectural elements (USM – USR – Pillars – Vault – and so on) typically not included inside the standard classification. As we have seen, the proposed custom classification obtained by modifying the IFC2X3 schema of FreeCAD worked as far as the local visualization and query processes are concerned, while if we had to use this custom classification into external software like web servers or viewers it would have been unusable because these software are based on original IFC schemas, thought for sharing operations and exchanging file and formats. For this reason, there are some critical points in this custom workflow: the most evident is given by the custom demonstrative architectural elements classification, that, as we have seen, includes ad-hoc entities but excluded from the actual ISO standard classification based on IFC schemas. Of course, the standard classification has been thought for AEC industry and for this reason it hardly can adapt its semantic categorisation for Cultural Heritage assets, but at the same time a proper Heritage assets classification is strictly required nowadays, even if it means long leads times. BIM is the present for the architectural design and AEC industry in general but it should become a proper and complete methodology also for historical buildings or archaeological sites, because 3D models without a semantic dimension including different kinds of data should be considered useless for research.

Furthermore, as we have seen, by using REPORTING WORKBENCH and the SQL language has been possible to perform custom and ad-hoc queries based on entities, materials, stratification and relations analyses.

Concluding, by setting up and managing locally FreeCAD is certainly possible to obtain a complete and ad-hoc HBIM system, able to satisfy specific needs concerning Cultural Heritage assets, despite the obvious BIM standard limitations.

The second question introduced in the first chapter was about the possibility to create a dynamic system that collects, **manage and produce information in the same time**. As we have seen, this certainly occurred thanks to the default and additional tools of FreeCAD, which have permitted the inclusion of different kinds of data, such as a custom material database (by using the material editor), photographic data (Matrix – Historical drawings – Detailed photographs),

bibliographic resources (Datasheet), objects description, architectural roles, identification numbers, tags and so on. So, FreeCAD was able to collect different information concerning the analysed refectory, becoming proper documentation instrument and also a data producer thanks to the possibility of performing custom SQL queries useful for the purpose of investigate and monitor data and the refectory status. Moreover, the choice of investigating the refectory through SQL queries is also due to the possibility of performing the same queries with the same language in another possible database environment, allowing also interoperability analyses.

The third question was about the possibility of integrating **stratigraphic information inside the HBIM platform**. Understand and represent stratigraphic peculiarities or surfaces features of historical buildings is always a difficult task depending on the visibility, its interpretation and its representation through 2D or 3D methodologies (Reina Ortiz et al., 2019). The 3D representation of stratigraphy has been possible also thanks to Rhinoceros modeller, because stratigraphic units, such as all the refectory objects, have been modelled after importing orthophotos inside the software and mapping and drawing units by units. Then, units have been imported as NURBS models inside the FreeCAD platform and then they have experienced the parametrization process in order to become dynamic BIM objects. In this sense, surfaces referred to stratigraphic units have been extruded from few millimetres, in this way surfaces obtained a right thickness in order to be considered parametric objects. Finally, to stratigraphic units mapped have been assigned the IFC WALL role as far as the ISO standard classification is concerned and the IFC USM and IFC USR regarding the demonstrative custom classification. Then, stratigraphic units have been properly included inside the platform as direct architectural elements of the refectory as well as historical information thank to the added properties. In this sense, the integration of historical knowledge from stratigraphy into an HBIM system generates a comprehensive knowledge-based platform that allows diagnosis and maintenance processes on walls and surfaces (Caciotti et al., 2014; Beltramo et al., 2019a).

The fourth question was about the critical point of creating a complete and proper BIM and HBIM platform by using **open source solution**. As we have seen, this purpose was partially gained, because, despite the FreeCAD HBIM platform results now complete and operative, it was obtained also by using NURBS models generated with Rhinoceros commercial software that helped the modelling phase of the project. However, without time limitations and considering the constant development of FreeCAD and its tools is certainly possible to create a BIM and HBIM projects by using just open source solutions, also regarding the sharing processes.

However, the utilization of open source solutions did not always mean the easiness of the platform organization and development, even if in all these steps the full access to libraries, tools and sources has been provided. In the same way, despite the intricate appearance due to script command and the source exposure, this open platform, as well as other open source solutions, can guarantee the complete and clear data access and management (Myers et al., 2016). In this sense, open source solutions and the exchangeable IFC open standard guarantee to get through the economic limitations for the creation of BIM platforms. Furthermore, the open source thought applied in this project thesis was also inspired and due to the CIPA (International Committee of Architectural Photogrammetry)<sup>48</sup> directions for the correct diffusion of adopted solutions as well as inspired to GAMHer project (Bitelli et al., 2017).

The fifth question was about the possibilities of creating a HBIM system starting from metric information managed by modelling **free form NURBS surfaces**. The previous answer partially answered also to this one, because modelling limitations are referred to all actual BIM solutions, open source and commercial. In this sense, the Rhinoceros modelling workflow, as well as other free form modellers, has been included inside the HBIM platform thanks to the additional tool of FreeCAD, for the purpose of obtaining a detailed model concerning all architectural peculiarities of historical buildings and Cultural Heritage assets in general. However, in this reasoning the ability of modelling of the operator is crucial and could affect the final result as far as the level of detail is concerned.

Despite the numerous studies on Staffarda abbey, the religious context required more and more exhaustive stratigraphic analyses on the monastery buildings, especially as far as the refectory is concerned. Indeed, these analyses have been performed for the purpose of investigating and increasing the **historic comprehension of the refectory** as well as the abbey, through the stratigraphic analysis of the internal walls in relation to the south external front of the cloister and the other architectural elements in the backyard.

The analyses here performed obtained good results as far as the internal and external stratigraphic analysis and chronological interpretation of the refectory is concerned, and the adopted BIM methodology adopted has proved to be the best

---

<sup>48</sup> CIPA is a scientific committee inside the non-governmental international organization ICOMOS (International Council on Monuments and Sites)

solution for buildings archaeology projects, because it can integrate from historical information to three-dimensional documentation, including the possibility of update and publish information. Then, the open source HBIM platform here presented could be a suitable solution focused on metrical and historical documentation through the performed analyses on stratigraphy. Moreover, it is intended to become an open platform in order to increase and update the analysis on the refectory as well as on Staffarda abbey, allowing future maintenance projects.

Concluding this section, the here presented workflow presents some **innovative points** concerning the creation of HBIM for historical buildings. First of all, it is based on the utilization of **open source** BIM software as FreeCAD, overcoming the drawbacks and limitations of property software and creating an operative ad-hoc open source HBIM platform<sup>49</sup>; however, as we have seen, the modelling phase has been performed by using a free form modeller such as Rhinoceros software, and for this reason the **NURBS modelling** of the refectory could be considered an innovative solution as far as the HBIM creation is concerned, as pointed out also by other recent studies (Oreni et al., 2014; Banfi F., 2017); finally, another important innovative point certainly is the implementation inside the HBIM platform of **stratigraphic analysis** and then the historical information derived from it, for the purpose of ensuring the data collection, management, monitoring operations and enhancement processes of the Staffarda refectory inside a unique platform, avoiding data fragmentation (Beltramo et al., 2019a).

Despite innovative and positive points of this work described above, different **critical issues** occurred in the workflow sections. As we have seen, the actuation this experimental scan-to-BIM workflow involves working in the same time with **different software** and sometimes also operative systems platforms and it could be dangerous for file and data exchange and compatibility and then for the project stability in general; in this sense, experimental workflows should be necessary planned in all operative steps, including software and OS we could use, for the purpose of ensuring data preservation (Diara et al., 2019).

As far as the stability of the presented workflow is concerned, an experienced issue to be reported is focusing on the **unstable commands and limited tools** of FreeCAD. In fact, in addition to the manual implementation of add-ons and libraries

---

<sup>49</sup> Anyway, managing and performing analyses with open source solutions and open query languages also mean having a minimum of computer science skills.

inside the software, different problems came up due to bugs, crashes and open source code problems, even if they have been fixed and this problem solving has been a time-consuming operation. However, this fixing operation wasn't the only **time-consuming** step in this workflow: in this regard, the modelling phase was the longest phase of the performed workflow.

Lately, the absence of a **semantic classification for Cultural Heritage assets** has been one of the most critical issues inside this work, even if by using the full customizable FreeCAD software is possible to overcome these limitations by offering an ad-hoc, despite it is demonstrative and local, classification for the refectory peculiarities.

The here conducted applications of the presented custom workflow had resulted satisfying feedbacks, despite the already mentioned critical issues. Then, after these analyses, possible **future work** could be defined.

First of all, the created HBIM platform should be used as a basis for the future comprehension of the historical evolution of the Staffarda abbey. This analysis can be performed by managing and implementing the already custom internal database as well as updating the geometric and volumetric information of the refectory.

Moreover, the custom workflow can be therefore applied to other contexts that need this type of analyses, and it could be a real future challenge. As far as the customization process is concerned the customization of FreeCAD software can be carried out according to other specific needs: in fact, it would be interesting to adapt this custom workflow to other types of archaeological analyses, for example in order to document field archaeology and then the related excavations, reporting archaeological stratification to semantic dimension inside a custom BIM environment purposely built. In this sense, it would be also interesting to continue the exploration and development of libraries of FreeCAD as well as follow and support the steady creation of additional plugins and workbenches from the FreeCAD community. In this sense, one of future goals is trying to understand how far these open source instruments can push and can help the proper documentation of Cultural Heritage assets, overcoming the closure limits of commercial and closed solutions.

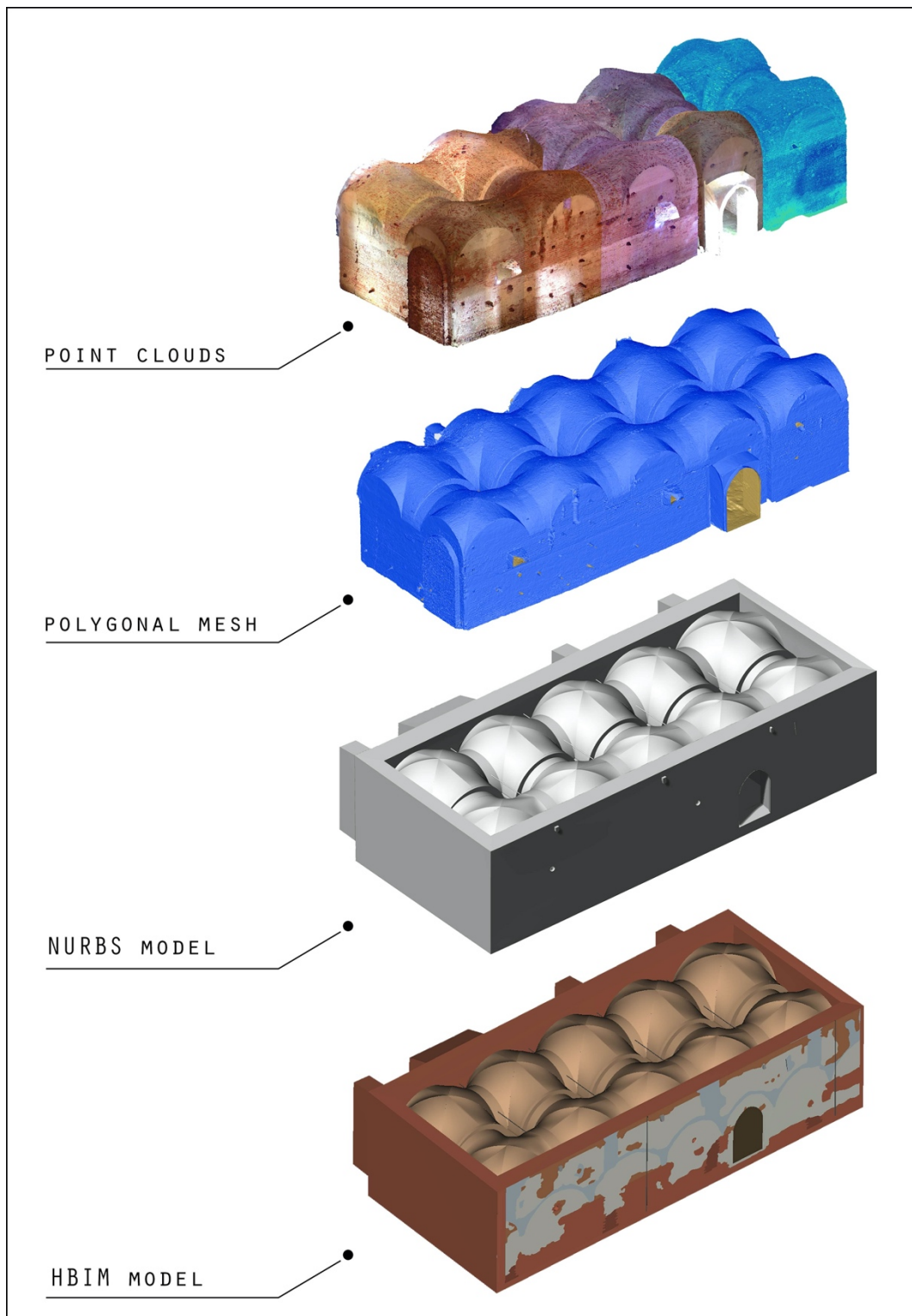

Figure 332. From point clouds to HBIM model via NURBS (elaboration F. Diara).

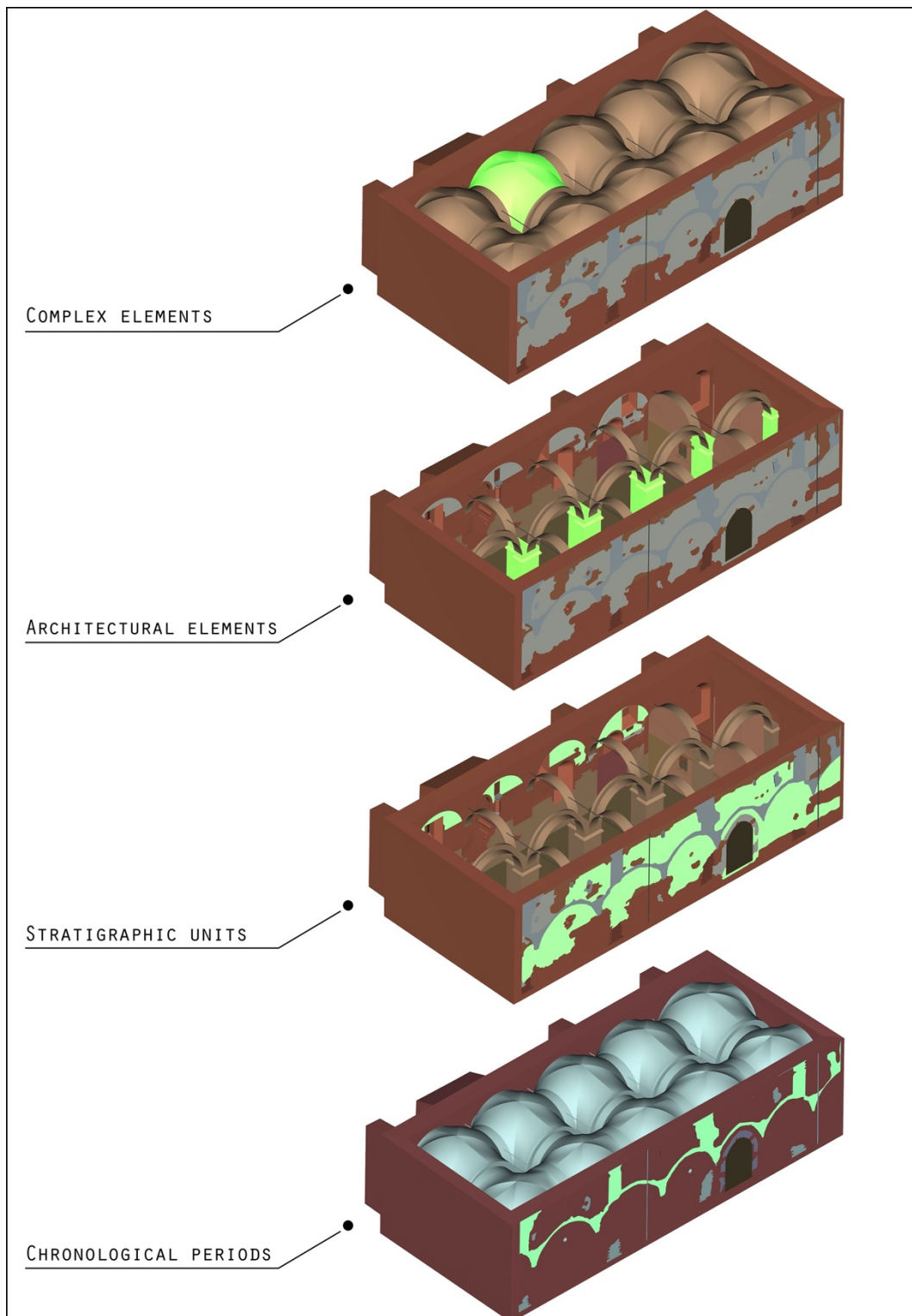

Figure 333. Refectory HBIM model main features (elaboration F. Diara).

# Conclusions

The principal aim of this research was to take the advantages and benefits of BIM methodology for **buildings archaeology purposes** through non-conventional strategies and solutions, especially since stratigraphic units as well as Cultural Heritage assets peculiarities have no BIM standard classification.

Analysing the obtained results, we can argue that BIM could be the proper methodology for the purpose of documenting and collecting a different kind of data concerning a specific historic architecture in years, especially because through the utilization of BIM solutions 3D models might become, in addition to being a dynamic geometric representation, the structural basis for any kind of analyses and applications, focusing principally on the information value. Then, the complete analysis of a Cultural Heritage context could be carried out by interacting the extracted data from an IFC model (entities, elements, geometry, location, materials, etc.) and other kinds of data linked to the object, such as the historical evolution as well as bibliographic resources, archives data, past restorations, images, and so on. Throughout this solution can be therefore overcome the limitations of traditional stratigraphic studies based on Harry' Matrix interpretation often disconnected from the architectural context. For these reasons BIM could be a suitable solution as well as a methodological synthesis for building archaeology studies and its operative workflows.

However, as we have seen, the implementation of these kinds of information for historical architecture as well as Cultural Heritage in general is still an ongoing research field and it depends also on testing new experimental and non-conventional ways to integrate them on BIM platforms. In fact, by using ad-hoc and customized solutions can be achieved good dynamic results, adapting geomatics techniques and methodologies to specific needs and not the opposite. In this regard, the utilization of full customizable open source solutions follows exactly this thought, even if some BIM limitations remain as far as the IFC definitions and classification are concerned, which hardly fit with Cultural Heritage assets needs, and for this reason they require specific definitions and classification.

Acting in this way it is possible to ensure data protection, publication as well as exchanging and sharing moments. Being an architectural-based informative system, BIM methodology could be also associated with the spatial-based GIS informative system (Bitelli et al., 2017; Yang et al., 2019): in this regard, they are used as data storage and management through to the utilization of integrated



architectural or spatial databases, in addition to the representative visualization. Furthermore, the cooperation between BIM / HBIM and GIS solutions could be a reliable, fitting and sustainable solution for the purpose of having a fitting data-set and planning conservative or restorative actions (Osello et al., 2016; Rinaudo F., 2016; Bitelli et al., 2017; Vacca et al., 2018). Indeed, this work was carried out by performing an experimental workflow focused on HBIM creation for building archaeology could cooperate with other research carried out using GIS solutions conducted in Staffarda abbey (Beltramo et al., 2019b) for the purpose of obtaining a complete and uniform vision of all different construction phases and then the historic evolution of the abbey' complex. In this sense, the integration HBIM-GIS could be a suitable solution for the purpose of investigating the architectural and spatial scale of historical buildings. Then, as mentioned in previous chapters, the *time* element is a fundamental feature to be managed inside an HBIM, and the integration of stratigraphic analysis is significant for *visualize, read* and *query* the historical evolution (Diara et al., 2018).

In this panorama, the combination of solutions and methodologies used was fundamental for the historic reconstruction of the refectory, acting with multidisciplinary in order to achieve a collectable and sharable knowledge. In this sense and as can be argued in these rows, integration could be considered one of the main words of this research project: integration concerning different data and information; integration concerning different software; integration concerning different type of researches and studies as well as resulting professional figures.

Despite these aspects have not always characterized the historians' methodologies, BIM solutions and in general multidisciplinary and transparent approaches have to be the unique way to be taken for the future of the research, responsible research. Moreover, experimenting new methodologies and new ways of acting is a reliable and suitable solution to carry out and perform further documentation analyses and communicate and enhance final data. In this sense, as we, researchers, want a responsible technological innovation, we have to do a responsible research, also cooperating each other for the purpose of ensuring a responsive data. Making research also means making innovative and experimental research, avoiding to stand in the traditional comfort zone of the research.

# References

- Adami, A., Scala, B., and Spezzoni, A. (2017). Modelling and accuracy in a BIM environment for planned conservation: the apartment of Troia of Giulio Romano. In: *The International Archives of the Photogrammetry, Remote Sensing and Spatial Information Sciences*, XLII-2/W3, 17-23, 2017.
- Attico, D., Turrina, A., Banfi, F., Grimoldi, A., Landi, A., Condoleo, P., Brumana, R. (2019). The HBIM analysis of the geometry to understand the constructive technique: the use of the trompe volume in a brick vault. In: *The International Archives of the Photogrammetry, Remote Sensing and Spatial Information Sciences*, Volume XLII-2/W11, 2019 GEORES 2019 – 2nd International Conference of Geomatics and Restoration, 8–10 May 2019, Milan, Italy
- Augenti, A. (2016). *Archeologia dell'Italia medievale*. Editori Laterza
- Balletti, C., Guerra, F., Scocca, V., Gottardi, C. (2015). 3D integrated methodologies for the documentation and the virtual reconstruction of an archaeological site. *ISPRS - International Archives of the Photogrammetry, Remote Sensing and Spatial Information Sciences*. XL-5/W4. 215-222. 10.5194/isprsarchives-XL-5-W4-215-2015.
- Balletti, C., Gottardi, C., Guerra, C. (2019). Geomatics techniques for the enhancement and preservation of Cultural Heritage. In: *The International Archives of the Photogrammetry, Remote Sensing and Spatial Information Sciences*, Volume XLII-2/W11, 2019 GEORES 2019 – 2nd International Conference of Geomatics and Restoration, 8–10 May 2019, Milan, Italy. pp.133-140
- Banfi, F. (2016). Building Information Modelling – A Novel Parametric Modeling Approach Based on 3D Surveys of Historic Architecture. *Digital Heritage. Progress in Cultural Heritage: Documentation, Preservation, and Protection*. pp.1-12. 2016
- Banfi F. (2017). BIM orientation: grades of generation and information for different type of analysis and management process. In: *The International Archives of*

*the Photogrammetry, Remote Sensing and Spatial Information Sciences*, XLII-2/W5, pp. 57-64

- Banfi, F. (2019). The integration of a scan-to-HBIM process in BIM application: the development of an add-in to guide users in Autodesk Revit. In: *The International Archives of the Photogrammetry, Remote Sensing and Spatial Information Sciences*, XLII-2/W11, 141-148, 2019.
- Banfi, F., Brumana, R., Stanga, C. (2019). Extended reality and informative models for the architectural heritage: from scan-to-BIM process to virtual and augmented reality. *Virtual Archaeology Review*, 10(21), 14-30.
- Banfi, F., Barazzetti, L., Previtali, M., Roncoroni, F. (2017). Historic BIM: a new repository for structural health monitoring, *Int. Arch. Photogramm. Remote Sens. Spatial Inf. Sci.*, XLII-5/W1, 269-274
- Barazzetti L., Banfi F., Brumana R., Oreni D., Previtali M., Roncoroni F. (2015). HBIM and augmented information: towards a wider user community of image and range-based reconstructions, In: *The International Archives of the Photogrammetry, Remote Sensing and Spatial Information Sciences*, XL-5/W7, 35-42, 2015
- Barazzetti, L. (2016). Parametric as-built model generation of complex shapes from point clouds. In: *Advanced Engineering Informatics*, 30 (2016) 298–311, 2016.
- Bartolucci, D. (2009). *Principi di laser scanning 3D, hardware, metodologie applicative, esempi*. Dario Flaccovio Editore, Palermo
- Bellero, M. (1985). I cistercensi e il paesaggio rurale: l'abbazia di S.Maria di Lucedio fra il XII e il XV secolo, in *Studi Storici*, 26, 1985, pp.337-351
- Beltramo, S. (1999). Rivalta Scrivia tra storia e restauro: l'architettura cistercense dell'abbazia di Santa Maria, in "Novinostra", n.2., 1999, pp-9-39
- Beltramo, S. (2009a). *Stratigrafia dell'architettura e ricerca storica*. Carocci editore, Roma

- Beltramo, S. (2009b). Construction Methods and Models of Cistercian abbeys in North-Western Italy between XII and XIII Century. Proceedings of the Third International Congress on Construction History, Cottbus, May 2009, p.175-182
- Beltramo, S. (2010). L'abbazia cistercense di Santa Maria di Staffarda. L'Artistica Editrice, Savigliano
- Beltramo, S. (2016). Il romanico cistercense: analisi del costruito della chiesa e del monastero di Staffarda. In: Confronti vol. 10: Romanico piemontese - Europa romanica. Architetture, circolazione di uomini e idee, paesaggi. A cura di Saverio Lomartire. Centro Studi Città e Territorio. p.14-25
- Beltramo, S. (2018a). La cura del 'Medioevo': Cesare Berteà e il patrimonio architettonico del Piemonte occidentale. In ANANKE 83: Quadrimestrale di Cultura, Storia e Tecniche della Conservazione per il Progetto, gennaio 2018, p. 26-33
- Beltramo, S. (2018b). Nutrire il corpo e lo spirito: i refettori nei monasteri cistercensi. In Studi e Ricerche di Storia dell'Architettura. Rivista dell'Associazione Italiana Storici dell'Architettura (AISTARCH). Numero 3, anno 2, p.38-51
- Beltramo, S. (2018c). Rib vaults in 12th-century religious architecture in the North-West of Italy. Hortus Artium Medievalium 24, 2018, pp.345-355
- Beltramo S., Diara F., Rinaudo F. (2019a). Evaluation of an integrative approach between HBIM and architecture history. In: The International Archives of the Photogrammetry, Remote Sensing and Spatial Information Sciences, XLII-2/W11, p.225-229
- Beltramo, S., Donadio, E., Spanò, A. (2019b). Stratigraphic analyses, historical evidences, and 3D documentation tools. Deepening Built Heritage. New researches for historical building site in Staffarda. In: Analysis, Conservation and Restoration of tangible and intangible Cultural Heritage, p. 273-301
- Beltramo, S., Tosco, C. (2006). Il cantiere cistercense a Casanova. In: R. Comba, P. Grillo (A cura di), Santa Maria di Casanova. Un'abbazia cistercense fra i

- marchesi di Saluzzo e il mondo dei comuni (p. 63-85), atti del convegno, Società per gli studi storici, archeologici ed artistici della provincia di Cuneo.
- Bitelli, G., Balletti, C., Brumana, R., Barazzetti, L., D'Urso, M. G., Rinaudo, F., and Tucci, G. (2017). Metric documentation of Cultural Heritage: research directions from the Italian GAMHER project, *Int. Arch. Photogramm. Remote Sens. Spatial Inf. Sci.*, XLII-2/W5, 83-90.
- Boato, A. (2008). *L'archeologia in Architettura. Misurazioni, stratigrafie, datazioni, restauro.* Marsilio, Elementi
- Bonfanti, C., Chiabrando, F., Spanò, A. (2007). Studies and knowledge fusion in archaeological site maps managed in a 3D GIS. In: *International archives of the photogrammetry, remote sensing and spatial information sciences.* - ISSN 1682-1750. -XXXVI-5/c53(2007), pp. 153-158.
- Bornaz, L. (2006). I sistemi a scansione laser. La tecnica del laser scanner terrestre. Udine 24-26 novembre (2004) In: *Laser scanning terrestre, Chapter: I sistemi a scansione laser.* Editor: CISM
- Bornaz, L., Rinaudo, F (2004). Terrestrial laser scanner data processing. In: *The International Archives of the Photogrammetry, Remote Sensing and Spatial Information Sciences, Volume XXXV, XXth ISPRS Congress 2004*, pp. 514-519
- Bovo, P. (1999). *L'abbazia oggi: problemi di restauro e progetti di valorizzazione.* In R. Comba, Grado G. Merlo (A cura di), *L'abbazia di Staffarda e l'irradiazione cistercense nel Piemonte meridionale* (p. 421-427), atti del convegno, Società per gli studi storici, archeologici ed artistici della provincia di Cuneo.
- Brogiolo, G.P. (2013). *Archeologia dell'edilizia storica. Documenti e metodi.* Con contributi di A. Zonca e L. Zigrino, New Press, Como
- Brogiolo, G.P., Cagnana, A., a cura di. (2012). *Archeologia dell'architettura. Metodi e interpretazioni.* Firenze, All'Insegna del Giglio

- Brumana, R., Della Torre, S., Previtali, M., Barazzetti, L., Cantini, L., Oreni, D., Banfi, F. (2018). Generative HBIM modelling to embody complexity (LOD, LOG, LOA, LOI): surveying, preservation, site intervention—the Basilica di Collemaggio (L'Aquila). *Applied Geomatics*. 10. 10.1007/s12518-018-0233-3.
- Brusaporci, S., Maiezza, P., Tata, A., 2018. A framework for architectural heritage HBIM semantization and development. In: *The International Archives of the Photogrammetry, Remote Sensing and Spatial Information Sciences, Volume XLII-2*, pp.179-184, 2018.
- Caciorgna, M., T. (2002). L'abbazia di Fossanova. Vicende e problemi di un'abbazia tra Stato della Chiesa e Regno (secoli XII-XIII). In: *Il monachesimo cistercense nella Marittima medievale. Storia e arte*. Casamari, Bibliotheca Casaemariensis. p. 90-128
- Cacciotti, R., Blaško, M., Valach, J. (2014). A diagnostic ontological model for damages to historical constructions. *Journal of Cultural Heritage*, 16 (1), 40-48.
- Capitel, A., (1998). *Metamorfosis de monumentos y teorías de la restauración*. Alianza Editorial, S.A., Madrid, 1998.
- Carandini, A. (1981). *Storie dalla terra*, De Donato, Bari
- Carbonara, G., (2013). *Il restauro non è conservazione...In: Collana di Lectiones Magistrales (a cura di Donatella Scatena)*. Sapienza Università di Roma. *Lectio Magistralis per l'inaugurazione dell'A.A. 2008/2009*. Mary Joan Crowley Production Editor.
- Carità, G. (1999). Staffarda e le abbazie cistercensi nelle diocesi piemontesi: modelli a confronto. In R. Comba, Grado G. Merlo (A cura di), *L'abbazia di Staffarda e l'irradiazione cistercense nel Piemonte meridionale (p. 209-223)*, atti del convegno, Società per gli studi storici, archeologici ed artistici della provincia di Cuneo.

- Chevrier, C., Charbonneau, N., Grussenmeyer, P., Perrin, J. (2010). Parametric documenting of built heritage: 3D virtual reconstruction of architectural details. *International Journal of Architectural Computing* 8 (2), 131–146.
- Chiabrandò, F., Lo Turco, M., Rinaudo, F. (2017). Modeling the decay in an HBIM starting from 3D point clouds. A followed approach for Cultural Heritage knowledge. In: *The International Archives of the Photogrammetry, Remote Sensing and Spatial Information Sciences*, Ottawa, Canada, Vol. XLII-2/W5, pp.605-612
- Chiabrandò, F., Spanò, A. (2013). Points clouds generation using TLS and dense-matching techniques. A test on approachable accuracies of different tools. In: *ISPRS Ann. Photogramm. Remote Sens. Spatial Inf. Sci.*, II-5/W1, pp.67-72
- Chow, L., Graham, K., Grunt, T., Gallant, M., Rafeiro, J., and Fai, S. (2019). The evolution of modelling practices on Canada' Parliament Hill: an analysis of three significant heritage building information models (HBIM), *Int. Arch. Photogramm. Remote Sens. Spatial Inf. Sci.*, XLII-2/W11, 419-426.
- Coccoluto, G. (1999). Prima di Staffarda: il territorio circostante l'abbazia fra V e XII secolo. In R. Comba, Grado G. Merlo (A cura di), *L'abbazia di Staffarda e l'irradiazione cistercense nel Piemonte meridionale* (p. 19-46), atti del convegno, Società per gli studi storici, archeologici ed artistici della provincia di Cuneo.
- Colucci, E., Spanò, A., Chiabrandò, F., (2017). WebGIS tools to disseminate archaeological landscape memory In: *TERRITORIO ITALIA*. - ISSN 2240-7707. - STAMPA. - 2(2017), pp. 57-78.
- Comba, R. (1999). Da Tiglieto a Staffarda: gli esordi cistercensi nella regione ligure-subalpina. In R. Comba, Grado G. Merlo (A cura di), *L'abbazia di Staffarda e l'irradiazione cistercense nel Piemonte meridionale* (p. 65-81), atti del convegno, Società per gli studi storici, archeologici ed artistici della provincia di Cuneo.
- De Luca, L., Busayarat, C., Stefani, C., Véron, P., Florenzano, M. (2011). A semantic based platform for the digital analysis of architectural heritage. *Computers & Graphics* 35 (2), 227–241.

- De Luca, L., Bagneris, M., Chevrier, C., Ciblac, T., Vallet, J.M., Bromblet, P., Desseilligny, M.P., Brunetaud, X., Al Mukhtar, M., Dubois, F., Cherblanc F., and Jourdan R. (2014): MONUMENTUM: Digital modelling and data management for the conservation of masonry structures. ICOMOS General Assembly, Florence, 10-15/11/2014.
- Devaux M., Lamanna M. (2009). The Rise and Early History of the Term Ontology (1606–1730), *Quaestio. Yearbook of the History of the Metaphysics*, 9, 2009, pp. 173–208 (on Leibniz pp. 197–198).
- Diara, F. (2013) Sperimentazioni di nuove tecniche fotogrammetriche di medio e basso costo applicate all'archeologia dell'architettura. In: *Conservazione e valorizzazione dei siti archeologici. Approcci scientifici e problemi di metodo. Proceedings of XXIX Convegno di Studi di Bressanone*, 9-12 luglio 2013, Edizioni Arcadia Ricerche, pp. 585-594
- Diara, F. (2014). New software and technologies applied to documentation and communication of Cultural Heritage. Proceedings of “Conference on Cultural Heritage and New Technologies (CHNT)” meeting on Vienna (Austria) from 11 to 13 November 2013.
- Diara, F., Rinaudo, F. (2018). Open source HBIM for Cultural Heritage: a project proposal. In: *The International Archives of the Photogrammetry, Remote Sensing and Spatial Information Sciences*, Vol. XLII-2, 2018 ISPRS TC II pp.303-309, 2018.
- Diara F., Rinaudo F. (2019). From reality to parametric models of Cultural Heritage assets for HBIM. In: *The International Archives of the Photogrammetry, Remote Sensing and Spatial Information Sciences*, Volume XLII-2, 2019, pp. 413-419. 27th CIPA International Symposium: Documenting the past for a better future, Avila, Spain, 1-5 Sep. 2019
- Diara, F. (2020). Cultural Heritage digital data: future and ethics. In: *Digital Cultural Heritage* (Springer), pp. 303-314. Related to the Conference on Digital Cultural Heritage (DCH17). Berlin 2017. ISBN: 978-3-030-15200-0 (First online 22 June 2019).



- Dogliani, F. (1988). La ricerca sulle strutture edilizie tra archeologia stratigrafica e restauro architettonico, in R. Francovich, R. Parenti (a cura di), “Archeologia e Restauro dei monumenti”, (Pontignano 1987), Firenze, All’Insegna del Giglio. p.223-247
- Dogliani, F. (2002). Ruolo e salvaguardia delle evidenze stratigrafiche nel progetto e nel cantiere di restauro. In *Arqueologia de la arquitectura*, 1. pp.113-130.
- Fai, S., Graham, K., Duckworth, T., Wood, N., Attar, R. (2011). Building information modelling and heritage documentation, In: 18th International Conference on Virtual Systems and Multimedia. XXIII CIPA Symposium – Prague, Czech Republic – 12–16 September (On CDROM).
- Fai, S., Rafeiro, J. (2014). Establishing an appropriate level of detail (LoD) for a building information model (BIM) – West Block, Parliament Hill, Ottawa, Canada. *ISPRS Annals of the Photogrammetry, Remote Sensing and Spatial Information Sciences*, 2(5), pp.123-130
- Fassi, F., Parri S. (2013). Web 3D BIM for the Department of Cultural Heritage. Tests and experimentation on the Spire of the Duomo of Milan. In: *To know, conserve, enhance* (a cura di Rosa Anna Genovese). Arte tipografica editrice. pp.271-290
- Francovich, R., Bianchi, G. (2002). L’archeologia dell’elevato come archeologia. In *Arqueologia de la arquitectura*, 1. pp. 101-111.
- Gabrielli, F. (1996). La “Cronotipologia relativa come metodo di analisi degli elevati: la facciata del palazzo Pubblico di Siena. In *Archeologia dell’Architettura*, I, p.17-40
- Gabrielli, N., (1973). *Arte nell’antico marchesato di Saluzzo*. Editore: Istituto Bancario San Paolo di Torino, 1973
- Gallotta, E. (2018). La “costruzione” di un modello: l’impiego degli archidiaframma nell’edilizia civile duecentesca del Basso Lazio. In: *Studi e Ricerche di Storia dell’Architettura*. Rivista dell’Associazione Italiana Storici dell’Architettura (AISTARCH). Numero 3, anno 2, p.52-63

- Garba, S.B., Hassanain, H.M. (2004). A review of object oriented cad potential for building information modelling and life cycle management. In: 1st ASCAAD International Conference, e-Design in Architecture, KFUPM, Dhahran, Saudi Arabia, December, pp. 343–359.
- Gelichi, S. (2003). Introduzione all'archeologia medievale. Storia e ricerca in Italia. Carocci editore, Roma.
- Georgopoulos, A., Brumana, R., Oreni, D., Raimondi, A., Barazzetti, L., Bregianni, A. (2013). HBIM for documentation, dissemination and management of built Heritage. The case study of St. Maria in Scaria D'Intelvi. International Journal of Heritage in the Digital Era. 2. 2. 10.1260/2047-4970.2.3.433.
- Harris, E., C. (2002). Principi di stratigrafia archeologia. Carocci editore, Roma.
- Historic England (2017). BIM for Heritage: Developing a Historic Building Information Model. Swindon. Historic England.
- ISO/TC 184/SC 4. (1994). "Industrial automation systems and integration — Product data representation and exchange—Part 11: Description methods: The EXPRESS language reference manual." ISO 10303-11:1994, Geneva.
- Karachaliou, E., Georgiou, E., Psaltis, D., and Stylianidis, E. (2019). UAV for mapping historic buildings: from 3D modelling to BIM, Int. Arch. Photogramm. Remote Sens. Spatial Inf. Sci., XLII-2/W9, 397-402.
- Kinder, N.T. (1997). I cistercensi. Vita quotidiana, cultura, arte, Electa, Milano, 1997.
- La Torre, A. (2015). L'abbazia cistercense di Snata maria di Staffarda - Analisi del costruito e dei materiali lapidei del chiostro. Rel. Maurizio Gomez Serito, Silvia Beltramo, Luca Finco. Politecnico di Torino, Corso di laurea specialistica in Architettura (Restauro E Valorizzazione), 2015
- Le Goff, J. (1964). La civiltà dell'Occidente medievale. Einaudi
- Lee, G., Jeong, J., Won, J., Cho, C., You, S. J., Ham, S., & Kang, H. (2014). Query performance of the IFC model server using an object-relational database

- approach and a traditional relational database approach. *Journal of Computing in Civil Engineering*, 28 (2), 210-222.
- Li, H., Liu, H., Liu, Y., and Wang, Y. (2016). An object-relational IFC storage model based on oracle database. *Int. Arch. Photogramm. Remote Sens. Spatial Inf. Sci.*, XLI-B2, 625-631
- Lo Turco, M., Mattone, M., Rinaudo, F. (2017a). Metric survey and BIM technologies to record decay conditions. In: *The International Archives of the Photogrammetry, Remote Sensing and Spatial Information Sciences*. Florence, Italy, Vol. XLII-5/W1, 2017 Geomatics & Restoration – Conservation of Cultural Heritage in the Digital Era, pp.261-268
- Lo Turco, M., Mattone, M., Rinaudo, F. (2017b). Dal rilievo metrico all'HBIM per l'analisi dello stato di conservazione della fabbrica. In: *ANANKE*. - ISSN 1129-8219. - (2017), pp. 141-146.
- Leroux-Dhuys, J.F., Gaud, H. (1998). *Les abbayes cisterciennes*. Editions Place des Victoires, 1998
- Logothetis, S., Stylianidis, E. (2016). BIM Open Source Software (OSS) for the documentation of Cultural Heritage. In: *Virtual Archaeology Review*, 7(15): 28-35
- Logothetis, S., Karachaliou, E., Stylianidis, E. (2017a) From OSS CAD to BIM for Cultural Heritage digital representation. In: *The International Archives of the Photogrammetry, Remote Sensing and Spatial Information Sciences*. Nafplio, Greece, Vol. XLII-2/W3, 2017 3D Virtual Reconstruction and Visualization of Complex Architectures, 1–3 March 2017
- Logothetis, S., Valari, E., Karachaliou, E., Stylianidis, E. (2017b). Spatial DMBS architecture for a free and open source BIM, In: *The International Archives of the Photogrammetry, Remote Sensing and Spatial Information Sciences*, Ottawa, Canada, Vol. XLII-2/W5, pp.467-473
- Logothetis, S., Karachaliou, E., Valari, E., and Stylianidis, E. (2018). Open source cloud-based technologies for BIM, *Int. Arch. Photogramm. Remote Sens. Spatial Inf. Sci.*, XLII-2, 607-614.

- Macher, H., Landes, T., Grussenmeyer, P. (2017). From Point Clouds to Building Information Models: 3D Semi-Automatic Reconstruction of Indoors of Existing Buildings. In: Applied Sciences 2017, 7, 1030
- Macher, H., Boudhaim, M., Grussenmeyer, P., Siroux, M., and Landes, T. (2019). Combination of thermal and geometric information for BIM enrichment. Int. Arch. Photogramm. Remote Sens. Spatial Inf. Sci., XLII-2/W15, 719–725
- Macher, H., Chow, L., and Fai, S. (2019). Automating the verification of heritage building information models created from point cloud data, Int. Arch. Photogramm. Remote Sens. Spatial Inf. Sci., XLII-2/W9, 455-460
- Manacorda, D. (2004). Prima lezione di archeologia. Editori Laterza
- Mannoni, T., Poleggi, E. (1974). Fonti scritte e strutture medievali: del “castello” di Genova. In: Archeologia medievale numero 1 del 1974, p. 171-194
- Messaoudi, T., Véron, P., Halin, G., De Luca, L. (2018). An ontological model for the reality-based 3D annotation of heritage building conservation state. In: Journal of Cultural Heritage. Vol. 29, pp.100-112. 2018
- Myers, D., Dalgity, A., & Avramides, I. (2016). The Arches heritage inventory and management system: a platform for the heritage field. In: Journal of Cultural Heritage Management and Sustainable Development, 6 (2), 213-224.
- Momo, M. (1999). Staffarda: i restauri della chiesa di Santa Maria realizzati da Cesare Bertea nei primi decenni del Novecento. In R. Comba, Grado G. Merlo (A cura di), L'abbazia di Staffarda e l'irradiazione cistercense nel Piemonte meridionale (p. 383-419), atti del convegno, Società per gli studi storici, archeologici ed artistici della provincia di Cuneo.
- Murphy, M., McGovern, E., Pavia, S. (2009). Historic building information modelling (HBIM). Structural Survey 27 (4), 311–327.
- Murphy, M., McGovern, E., Pavia, S. (2013). Historic Building Information Modelling – Adding intelligence to laser and image based surveys of European classical architecture. ISPRS Journal of Photogrammetry and Remote Sensing, 76, 89-102.

- Murtiyoso, A., Grussenmeyer, P. (2019). Automatic Heritage building point cloud segmentation and classification using geometrical rules. *Int. Arch. Photogramm. Remote Sens. Spatial Inf. Sci.*, XLII-2/W15, 821–827.
- Oreni D., Brumana R., Banfi F., Bertola L., Barazzetti L., Cuca B., Previtali M., Roncoroni F. (2014). Beyond Crude 3D Models: From Point Clouds to Historical Building Information Modeling via NURBS. *Lecture Notes in Computer Science*. 8740. 166-175. 10.1007/978-3-319-13695-0\_16.
- Oreni, D., Brumana, R., Della Torre, S., Banfi, F. (2017). Survey, HBIM and conservation plan of a monumental building damaged by earthquake, *Int. Arch. Photogramm. Remote Sens. Spatial Inf. Sci.*, XLII-5/W1, 337-342
- Osello, A., Rinaudo, F. (2016). Cultural Heritage Management Tools: The Role of GIS and BIM. *3D Recording, Documentation and Management of Cultural Heritage*, 2016, pp.105-124.
- Parenti, R. (1985). La lettura stratigrafica delle murature in contesti archeologici e di restauro architettonico. In: *Restauro & Città*, I, 2, pp.55-68
- Parenti, R. (1988). Sulla possibilità di datazione e di classificazione delle murature. In R. Francovich, R. Parenti (a cura di), *Archeologia e restauro dei monumenti*, Firenze, pp. 280-304.
- Parenti, R. (1992). Fonti materiali e lettura stratigrafica di un centro urbano: I risultati di una sperimentazione “non tradizionale”. In: *Archeologia Medievale*; Jan 1, pp.7-62
- Parenti, R. (2000). Architettura, archeologia della. In R. Francovich & D. Manacorda, (Eds.). *Dizionario di archeologia. Temi, concetti, metodi* (pp. 39-43). Rome-Bari: Laterza
- Parisi, P., Lo Turco, M., Giovannini, E. C. (2019). The value of knowledge through H-BIM models: historic documentation with a semantic approach, *Int. Arch. Photogramm. Remote Sens. Spatial Inf. Sci.*, XLII-2/W9, 581-588

- Pierotti, P., Quirós Castillo, J., A. (2001). Archeologia dell'architettura e storia dell'architettura: due discipline a confronto. II Congresso Nazionale di Archeologia Medievale a cura di Gian Piero Brogiolo, Firenze, All'Insegna del Giglio, pp. 377-380
- Provero, L. (1999). Staffarda, i marchesi e l'aristocrazia locale. In R. Comba, Grado G. Merlo (A cura di), L'abbazia di Staffarda e l'irradiazione cistercense nel Piemonte meridionale (p. 83-100), atti del convegno, Società per gli studi storici, archeologici ed artistici della provincia di Cuneo.
- Reina Ortiz, M., Yang, C., Weigert, A., Dhanda, A., Min, A., Gyi, M., Su, S., Fai, S., and Santana Quintero, M. (2019). Integrating heterogeneous datasets in HBIM of decorated surfaces, *Int. Arch. Photogramm. Remote Sens. Spatial Inf. Sci.*, XLII-2/W15, 981–988.
- Remondino, F (2011). 3D surveying and modelling of complex architectural sites and heritage objects. In: *Tecnologie per la comunicazione del patrimonio culturale*, a cura di E. Ippoliti e A. Meschini. Vol. 4, n. 8 (2011) pp. 90-98
- Remondino, F., El-Hakim, S. (2006). Image-based 3D modelling: a review. In: *The Photogrammetric Record*, Vol. 21(115), pp. 269-291.
- Rinaudo, F., (2007). Principi di funzionamento e tecniche di acquisizione, in *Sistemi a scansione per l'architettura e il territorio*, F. Sacerdote, G. Tucci a cura di, ALINEA EDITRICE, Firenze, 2007.
- Rinaudo, F. (2011a). From the measurement to the information system: the role of Geomatics in the documentation of Cultural Heritage. In: *From knowledge to the project. Methodologies and tools for conservation and restoration* (a cura di Rosa Anna Genovese). Arte tipografica editrice. pp.143-159
- Rinaudo, F. (2011b). Geomatics and Archaeology. In: *From knowledge to the project. Methodologies and tools for conservation and restoration* (a cura di Rosa Anna Genovese). Arte tipografica editrice. pp.353-367
- Rinaudo, F. (2013). The Spatial Informative System of the Park of the Royal Castle of Racconigi: a new approach for the cultural and environmental heritage. In: *To know, conserve, enhance* (a cura di Rosa Anna Genovese). Arte tipografica editrice. pp.313-324

- Rinaudo, F. (2016). GIS and 3D modelling: from knowledge to restoration. In: Cultural Heritage: Innovative techniques for the conservation project (a cura di Rosa Anna Genovese). Giannini Editore. pp.317-328
- Romeo, E. (2016). Instaurare, reficere, renovare. Tutela, conservazione, restauro e riuso prima delle codificazioni ottocentesche. LEXIS Compagnia Editoriale in Torino srl (Celid).
- Scianna, A., Villa, B. (2011). GIS applications in archaeology. In: Archeologia e calcolatori 22, 2011, pp. 337-363
- Scianna, A., Serlorenzi, M., Gristina, S., Filippi, M., Paliaga, S. (2015). Sperimentazione di tecniche BIM sull'archeologia romana: il caso delle strutture rinvenute all'interno della cripta della chiesa dei SS. Sergio e Bacco in Roma. In: Archeologia e calcolatori supplemento 7, 2015, pp. 199-212
- Simeone, D., Cursi, S., Toldo, I., Carrara, G. (2014). BIM and knowledge management for building heritage, ACADIA 2014 design agency, pp. 681-690
- Spallone R., Piano, A., Piano, S. (2016). B.I.M. and cultural heritage: multi-scalar and multi-dimensional analysis and representation of an historical settlement. The case study of Montemagno, a New Village in Piedmont - In: DISEGNARE CON... - ISSN 1828-5961. - ELETTRONICO. - 16(2016), pp. 1-12.
- Spanò, A., Chiabrando, F., Sammartano, G., and Teppati Losè, L. (2018). Integrated imaging approaches supporting the excavation activities. Multi-scale geospatial documentation in Hierapolis (Tk). In: Int. Arch. Photogramm. Remote Sens. Spatial Inf. Sci., XLII-2, pp.1075-1082
- Tauscher, E., Smarsly, K. (2016). Generic BIM queries based on the IFC object model using graph theory. July 2016 Conference: The 16th International Conference on Computing in Civil and Building Engineering At: Osaka, Japan
- Tommasi, C., Achille, C., Fassi, F. (2016). From point cloud to BIM: a modelling challenge in the cultural heritage field. In: *The International Archives of the*

*Photogrammetry, Remote Sensing and Spatial Information Sciences*, XLI-B5, 429-436. 2016

- Tosco, C. (1999). La prima architettura cistercense e la chiesa di Staffarda. In: R. Comba, Grado G. Merlo (A cura di), *L'abbazia di Staffarda e l'irradiazione cistercense nel Piemonte meridionale* (p. 171-207), atti del convegno, Società per gli studi storici, archeologici ed artistici della provincia di Cuneo.
- Tosco, C. (2003). Una proposta di metodo per la stratigrafia dell'architettura, In: *Archeologia Dell'architettura All'Insegna del Giglio*, pp.17-27
- Tosco, C. (2016). *L'architettura medievale in Italia 600-1200*. Il Mulino
- Tosco, C. (2017). *Andare per le abbazie cistercensi*. Il Mulino
- Tse, T.K., Wong, K.A., Wong, K.F. (2005). The utilisation of building information models in nD modelling: a study of data interfacing and adoption barriers. *Journal of Information Technology in Construction*, ITcon 10, Special Issue From 3D to nD modelling, pp. 85–110, <<http://www.itcon.org/2005/8>>, (accessed 20.01.11).
- Vacca, G., Quaquero, E., Pili, D., Brandolini, M. (2018). GIS-HBIM integration for the management of historical buildings. In: *The International Archives of the Photogrammetry, Remote Sensing and Spatial Information Sciences*, Volume XLII-2, 2018 ISPRS TC II Mid-term Symposium “Towards Photogrammetry 2020”, 4–7 June 2018, Riva del Garda, Italy. pp. 1129-1135
- Van Leeuwen, J.P., Wagter, H., Oxman, R.M. (1996). Information Modelling for Design Support, a Feature-based approach. In: *Proceedings of the 3rd Conference on Design and Decision Support Systems in Architecture and Urban Planning*, Spa, Belgium, pp. 304–325.
- Wood, J. (1994). *Building Archaeology. Applications in Practice*, Oxbow Monograph, Oxford, 1994.
- Yang, X., Koehl, M., Grussenmeyer, P., Macher, H. (2016). Complementarity of historic building information modelling and geographic information systems.



ISPRS - International Archives of the Photogrammetry, Remote Sensing and Spatial Information Sciences. XLI-B5. 437-443.

Yang, X., Lu, Y., Murtiyoso, A., Koehl, M., Grussenmeyer, P. (2019). HBIM Modeling from the Surface Mesh and Its Extended Capability of Knowledge Representation. ISPRS International Journal of Geo-Information. 8. 301.

# Web references

[www.3dreshaper.com](http://www.3dreshaper.com)  
[www.bimserver.org](http://www.bimserver.org)  
[www.bimvision.eu](http://www.bimvision.eu)  
[www.buildingsmart.org](http://www.buildingsmart.org)  
[www.buildsite.com](http://www.buildsite.com)  
[www.cipaheritagedocumentation.org](http://www.cipaheritagedocumentation.org)  
[www.csiresources.org](http://www.csiresources.org)  
[www.danielgm.net/cc](http://www.danielgm.net/cc)  
[www.faro.com](http://www.faro.com)  
[www.forum.freecadweb.org](http://www.forum.freecadweb.org)  
[www.freecadweb.org](http://www.freecadweb.org)  
[www.icomos.org](http://www.icomos.org)  
[www.iso.org](http://www.iso.org)  
[www.isprs.org/publications/annales](http://www.isprs.org/publications/annales)  
[www.isprs.org/publications/archives](http://www.isprs.org/publications/archives)  
[www.nationalbimstandard.org](http://www.nationalbimstandard.org)  
[www.nist.gov](http://www.nist.gov)  
[www.opendesign.com](http://www.opendesign.com)  
[www.python.it/download](http://www.python.it/download)  
[www.qgis.org/it/site](http://www.qgis.org/it/site)  
[www.rhino3d.com](http://www.rhino3d.com)  
[www.sketchfab.com](http://www.sketchfab.com)  
[www.surveysoft.it](http://www.surveysoft.it)  
[www.uni.com](http://www.uni.com)



# Hardware and software appendix

The experimental workflow here presented and the experimentation concerning the HBIM platform creation, from LiDAR data to parametric models, have been ran under a specific hardware and software. In addition to the workstations inside the Geomatics for Cultural Heritage Lab (G4CH), ad-hoc tests and experimentations have been conducted by using a personal machine equipped in this way:

- CPU - 2.8GHz quad-core Intel Core i7, Turbo Boost up to 3.8GHz, with 6MB shared L3 cache
- Storage 512GB PCIe-based on board SSD
- Double partition: MacOS and Windows 10 Pro
- RAM Memory 16 GB of 2133MHz LPDDR3 on board memory
- GPU Radeon Pro 555 with 2GB of GDDR5 memory with automatic switching to Intel HD Graphics 630

This is the complete list of software used for this experimental workflow, in order of utilization:

## **Faro Scene:**

Point clouds registration and alignment

## **MicroSurvey Star-Net Pro**

Coordinate system offsetting

## **3D Reshaper:**

Point clouds cleaning actions and reality-based model creation

## **Rhinoceros:**

Geometric primitives interpretation; NURBS modelling of the refectory and stratigraphic units mapping

**CloudCompare:**

Standard Deviation analysis

**XCODE (for MacOS):**

Source codes management; IFC schemas inspection and customization

**Notepad++:**

Source codes management; IFC schemas inspection and customization

**FreeCAD (and additional workbenches and macros):**

Used versions 0.17 and 0.18 for HBIM platform creation; data management; queries design and management

**BIMServer:**

Queries and data management

**BIM Vision:**

Sections, data measurement and management

**NIST IFC File Analyser:**

IFC data extraction

# Acknowledgements

This work has been inspired by the guidelines of the International Committee of Architectural Photogrammetry (CIPA) – the scientific committee of ICOMOS - concerning Cultural Heritage documentation and preservation through the utilization of open source solutions for the correct data dissemination, idea also adopted by the GAMHer project. In this regard, this project work has been supported and funded by the GAMHer project (Geomatics data Acquisition and Management for landscape and built Heritage in a European perspective), a 3 years project financed under the Italian PRIN 2015 framework (Progetti di Ricerca di Rilevante Interesse Nazionale).

In this sense, a big thank goes to my tutor (more than that) and mentor Fulvio Rinaudo, constant source of inspiration and support, who believed in me and also gave me the possibility to work together as equals doing deep and brave research on open source HBIM and modelling field.

Moreover, I would like to thank people and friends who work into the Geomatic for Cultural Heritage Lab (G4CH) for their support and suggests.

I want to thank Silvia Beltramo for case study choice and for supporting the historical interpretation of the refectory.

The biggest thank goes to all people close to me in these years, who always supported and believed me constantly.

Finally and selfishly, a big thank goes to me for what I have managed, learned and for how much I have grown. Doing research also means to be brilliant and innovative, experiencing an academic and interior growth. For all these reasons I will never stop doing research in the Building Archaeology field as well as in the Geomatics field.

