

Experimental Real-Time Setup for Vision Driven Hand-Over with a Collaborative Robot

Original

Experimental Real-Time Setup for Vision Driven Hand-Over with a Collaborative Robot / Scimmi, Leonardo Sabatino; Melchiorre, Matteo; Mauro, Stefano; Pastorelli, Stefano. - ELETTRONICO. - (2019), pp. 1-5. (Intervento presentato al convegno 2019 International Conference on Control, Automation and Diagnosis (ICCAD))
[10.1109/ICCAD46983.2019.9037961].

Availability:

This version is available at: 11583/2805652 since: 2020-03-24T09:01:05Z

Publisher:

IEEE

Published

DOI:10.1109/ICCAD46983.2019.9037961

Terms of use:

This article is made available under terms and conditions as specified in the corresponding bibliographic description in the repository

Publisher copyright

IEEE postprint/Author's Accepted Manuscript

©2019 IEEE. Personal use of this material is permitted. Permission from IEEE must be obtained for all other uses, in any current or future media, including reprinting/republishing this material for advertising or promotional purposes, creating new collecting works, for resale or lists, or reuse of any copyrighted component of this work in other works.

(Article begins on next page)

Experimental Real-Time Setup for Vision Driven Hand-Over with a Collaborative Robot

Leonardo Sabatino Scimmi, Matteo Melchiorre, Stefano Mauro and Stefano Pastorelli

Department of Mechanical and Aerospace Engineering (DIMEAS)

Politecnico di Torino

Turin, Italy

{leonardo.scimmi, matteo.melchiorre, stefano.mauro, stefano.pastorelli}@polito.it

Abstract—Collaborative robotics aims to make possible a close collaboration between human operators and robots in the industry scenario. To achieve this goal, the robot must be able to adapt its behavior to the movements of human co-worker. This work presents a control strategy that permits to drive a UR3 collaborative robot in order to perform a hand-over task with a human operator. The movements of the operator are acquired by a 3D vision system made of multiple Microsoft Kinect sensors, so to prevent possible occlusions related to the presence of the robot or dynamic obstacles in the field of view of the sensors. Thus, the human skeletons extracted from depth sensors are handled by an algorithm that generates an optimized skeleton. A path-planning algorithm uses the skeleton information to calculate the robot joints velocities to accomplish the task. Experimental tests have been conducted to verify the effectiveness of the hand-over strategy here proposed. The hardware setup prepared for the experimental phase of the work and the results obtained from the tests are presented and discussed.

Keywords—collaborative robotics; hand-over; motion tracking; dynamic target; motion control.

I. INTRODUCTION

Collaborative robots bring new solutions in industrial applications where both human and robot skills are required. The main challenge is to safely approach the operator to the machine in order to carry out a cooperative task, whose level of interaction defines the collaboration grade. In fact, it is common to distinguish between workspace sharing systems and workspace and time-sharing systems [1]. In the first class, human and robot share the same space while performing separate or sequential tasks; in the second one, coordination in space and time is required to jointly handle objects, thus human robot interaction is inevitable. During assembly task, for example, human-robot hand-over plays a significant role and is a crucial sub-task [2]. In addition, the interaction level defines the control scheme and the workspace layout [3]. If task is carried out sequentially, the control must guarantee the avoidance of collisions in non-structured environments; if space-time synchronization is needed, the collision avoidance on robot links is combined with dynamic target following on the end-effector to make possible the hand-over. The latter contains all the features which characterize a full collaborative application which considers also the human-robot interaction.

A summary of the main case study for workspace and time-sharing system or hand-over can be found in [4]: the examples which move towards the industrial application suffer the safety requirements for collaborative industrial robots [5], showing sequential cooperation without handing-over parts synchronously; other studies which do not refer to industrial application, investigate the human-robot hand-over giving interesting results on the final relative position or robot velocity peak, which are useful to evaluate human perception during the gesture. In [6] a collaborative robot driven by vision is tested as robotic assistant to a car mechanic; hand tracking through color images segmentation and dynamic movement primitives-based control are implemented to characterize the hand-over by means of spatial and time indexes. A human-human and human-robot hand-over study is presented in [7] to build a discrete adaptive coordination strategy for a six dofs robot; a depth sensor registers the human joints motion and the robot adapts its behavior depending on the human task state. Both the cited examples show interesting results in terms of hand-over quality evaluation using weak vision strategies or discrete state-based control, which are not sufficient for a safe collaborative application. [8] is one of the most recent studies considering wearable sensors combined with active control to predict human intention and optimize the hand-over task, but the lack of a local control strategy represents a limit for industrial application, since moving in dynamic environment require fast algorithm to update on-line the robot trajectory.

This paper is based on the previous work [4] and aims to improve and validate with experimental tests the collaborative layout and the control strategy to successfully achieve human-robot hand-over in dynamic environments. A multi-vision system based on depth cameras is used for real-time tracking of the human motion and a collaborative robot UR3 by Universal Robots [9] is controlled on-line to drive the end-effector towards the human hand. A local control strategy is implemented to generate an attractive field on the moving target and to stop the robot TCP with an opportune final position and orientation, relative to the human hand, to facilitate the hand-over. The proposed scheme results in a collaborative-ready set-up, since it utilizes sensor fusion to compensate occlusions during motion tracking and a target-following algorithm based on attractive velocities, which can be easily combined with collision avoidance in order to drive the end-effector in the hand-over position, keeping other robot links away from obstacles [10].

II. COLLABORATIVE WORKSPACE AND TASK DESIGN

Fig. 1 shows the layout of the collaborative space. The human operator is standing in front of the robot, which is mounted on the workbench. They are displaced so that the intersection between the human and the robot workspace produces a collaborative volume which corresponds to almost 40% of the robot workspace. This choice opens to a wide range of hand-over positions (meeting points) and gives the human the possibility to meet the robot casually inside the collaborative volume. Two Microsoft Kinect sensors are displaced behind the robot, with their principal axis forming a 70 degrees angle and intersecting approximately at the center of the human workspace, which is measured considering the extended upper limbs as the radius of two sphere centered on the shoulders. The human joints are tracked from two points of view and multiple-Kinect algorithm is used to output an optimized skeleton at sample rate of 30 Hz [11]. The human upper body position is then interfaced with the UR3 robot in the World frame, which is built using reference points and the calibration procedure described in [4]. Fig. 2 illustrates the schematics of the task of human and robot, whose goal is to hand-over parts to be assembled starting and finishing from their relative resting pose. Without loss of generality, both human and robot can be giver or receiver, since the aim is to accomplish the collaborative task without discussing the human perception during the hand-over stages, because many contributes already investigated this field. In this work, the human is the giver and starts his task pointing towards the exchanging area. When the hand enters in the collaborative volume V_c , the robot reacts and drives its end effector towards the target. Once the hand and the robot gripper are at the meeting distance, the robot stops and receives the object. In this phase, the human can adjust his hand pose for the hand-over within a meeting volume V_m , in order to reach the interaction without that the UR3 moves. The meeting volume is a sphere centered on the robot TCP. Finally, the human retracts his upper limb and the robot goes to its home position as the hand exits from the meeting volume. In Fig. 2 the main task sequence is labeled with circular boxes, while the giver and receiver sub-tasks are introduced on the side of each branch; in the middle, the trigger events are also shown.

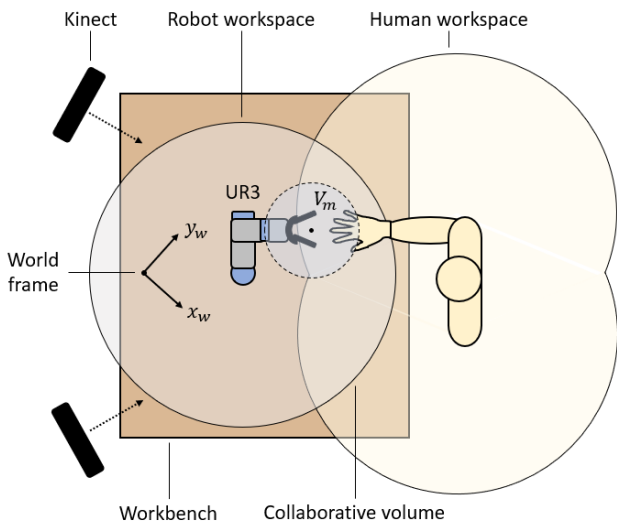

Fig. 1. Collaborative set-up for human-robot hand-over.

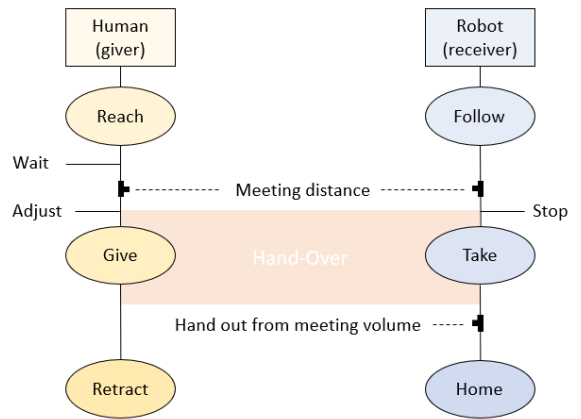

Fig. 2. Structure of the hand-over task for human and robot.

It is important to notice that the task of human and robot are connected in time and space: the relative position of hand and end-effector triggers the hand-over stages in order to execute the task synchronously, within the limit of collaborative application. In fact, the maximum robot TCP cartesian velocity is set to 0.25 m/s for collaborative purpose, resulting in a waiting phase for the operator, who's usually reaching faster the meeting point. In general, this will not affect the hand-over position if the separation of direction and velocity method is used for motion planning [4].

III. HAND-OVER CONTROL STRATEGY

The hand-over control strategy is based on two different algorithms: a duplex-Kinect algorithm and a path-planning algorithm, as in [4]. The duplex-Kinect algorithm is developed according to [11], instead the path-planning algorithm has been modified. The improvements in the path-planning are presented in this Section. In [4] the robot, in order to perform a hand-over task, considers as target point the right hand of the human operator. In this work the robot target is a virtual point, called *virtual hand*, that is an extension of the hand on the x_h - y_h plane as shown in Fig. 3. The origin of the hand frame moves rigid to the hand, while its orientation is fixed with the axis parallel to the world frame. This solution allows the robot to stop its motion in front of the human hand and to achieve the hand-over properly. In fact, considering the human hand as target point, the robot could place its TCP above or below the hand of the operator. Furthermore, using the virtual hand, it is not necessary to consider a security sphere around the hand of the human operator, because the robot stops away from the hand.

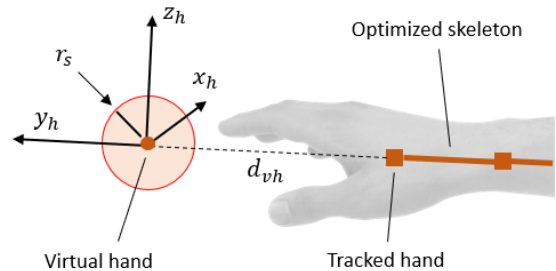

Fig. 3. The virtual hand uses as target point for the hand-over task. d_{vh} is the distance between the tracked hand and the virtual one.

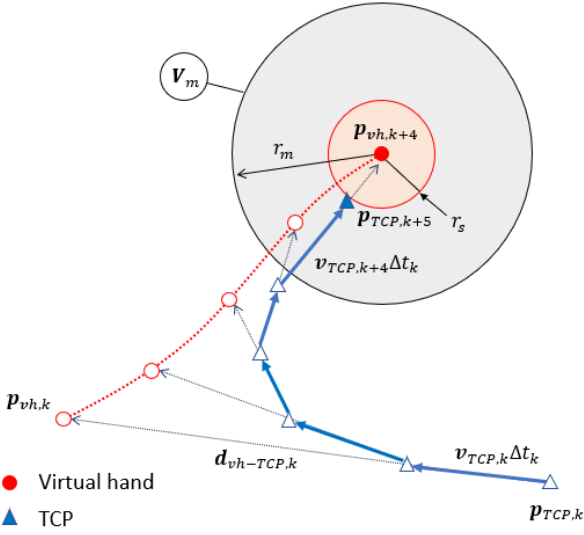

Fig. 4. Motion planning resulting from the hand-following algorithm for successive samples k , where Δt_k is the sampling rate of the vision system.

For control purposes, two spheres have been considered in this work, as can be seen in Fig. 4. The internal sphere with radius r_s is called *stopping volume* V_s , since the robot stops moving when the TCP reaches this volume around the target. The external sphere with radius r_m is the *meeting volume*: after the TCP reached the stopping volume, the robot can move again only when the distance between the virtual point and the TCP is bigger than r_m , therefore when the operator retracts his hand after the hand-over task has been accomplished. Using the meeting volume, small displacements of the hand from the TCP are permitted without involving robot motion. This facilitates the fulfillment of the hand-over task. The position vector of the virtual hand \mathbf{p}_{vh} is used to generate the TCP linear velocity vector \mathbf{v}_{TCP} to drive the robot towards the target. In [4], the velocity \mathbf{v}_{TCP} is obtained from the distance vector \mathbf{d}_{vh-TCP} between the target point position vector and the TCP position vector, through a constant diagonal matrix K , as in (2):

$$\mathbf{d}_{vh-TCP} = \mathbf{p}_{vh} - \mathbf{p}_{TCP} \quad (1)$$

$$\mathbf{v}_{TCP} = K \mathbf{d}_{vh-TCP} \quad (2)$$

In this work, a smooth profile for the TCP linear velocity is adopted, to obtain no sudden movements of the robot. In Fig. 5, the magnitude of the linear velocity v_{TCP} versus the distance between the target point and the TCP is shown. For what concerns the orientation of the TCP, this is represented in terms of unit quaternion and the angular velocity vector $\boldsymbol{\omega}_{TCP}$ is calculated as in [4]. The joint velocities vector $\dot{\mathbf{q}}$, that is the result of the path-planning algorithm, is obtained inverting the Jacobian J

$$\dot{\mathbf{q}} = J^{-1} \cdot [\mathbf{v}_{TCP}; \boldsymbol{\omega}_{TCP}] \quad (4)$$

To avoid any unintentional contact between the links of the robot and the human operator, a collision avoidance algorithm, based on the works presented in [10, 12-13], is considered.

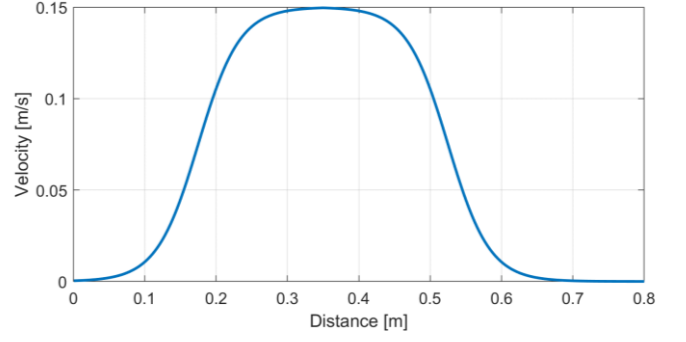

Fig. 5. Profile of the magnitude TCP linear velocity versus the distance between the virtual hand and the TCP.

The results of the collision avoidance algorithm, expressed as a joints velocity vector $\dot{\mathbf{q}}_{ca}$, and the ones of the path-planning algorithm are summed up in order to avoid collisions while the robot try to reach the target point.

IV. EXPERIMENTAL TESTS

To validate the effectiveness of the hand-over control strategy, experimental tests have been carried out. In this section, the experimental setup and the results of significant tests are described.

A. Experimental setup

In Fig. 6 a scheme of the experimental hardware is shown. The experimental setup consists of three PCs, two Microsoft Kinect v2, a UR3 robot from Universal Robots and a router. Each Kinect is connected to a PC. The PCs have i7-6700 processor and 32 GB RAM and the algorithms run in the Matlab environment. The router has a transfer speed of 300 Mbps. In the following, the two PCs connected to the Kinect will be called “Master” and “Slave” and the third PC “External robot controller”. The Master is in charge of the acquisition process from the two Kinect. In fact, the Master handles the start/stop triggers for the acquisition of the sensors to synchronize the samples. In this way, the Master and the Slave receive the data from the Kinect and locate them in the World reference frame, obtaining at the sample time t_k the skeletons $\mathbf{S}_{M,k}$ and $\mathbf{S}_{S,k}$. Then the Slave sends the skeleton $\mathbf{S}_{S,k}$ to the Master, that uses the skeleton data of the PCs to generate the optimized skeleton $\mathbf{S}_{opt,k}$, that is the result of the duplex-Kinect algorithm.

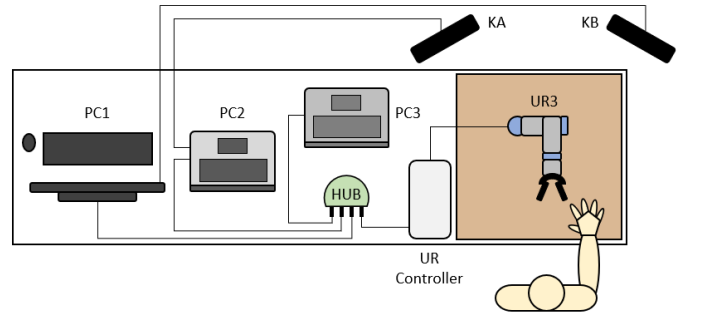

Fig. 6. Experimental hardware layout.

```

1. for  $k \in \{\text{kinect samples}\}$ 
2.    $S_{A,k}, S_{B,k} \rightarrow \text{Master}$ 
3.    $S_{opt,k} \rightarrow \mathbf{p}_{joints,k}$ 
4.    $\mathbf{p}_{joints,k} \rightarrow \mathbf{p}_{vh,k}$ 
4.    $fb \text{ data}, \mathbf{p}_{vh,k} \rightarrow \text{Ext. robot controller}$ 
5.     if  $\mathbf{p}_{vh,k} \in V_{CV} \ \&\& \ \mathbf{p}_{TCP,k}, \mathbf{p}_{vh,k} \notin V_{SV}$ 
6.       Hand following  $\rightarrow \mathbf{v}_{TCP,k}$ 
7.       Collision Avoidance  $\rightarrow \dot{\mathbf{q}}_{ca,k}$ 
8.        $\dot{\mathbf{q}}_k = \mathbf{J}_k^{-1} \mathbf{v}_{TCP,k} + \dot{\mathbf{q}}_{ca,k} \rightarrow \text{UR3 control.}$ 
12.    else Hand following = false
13.    end
14. End

```

Fig. 7. Pseudocode of the hand-over strategy.

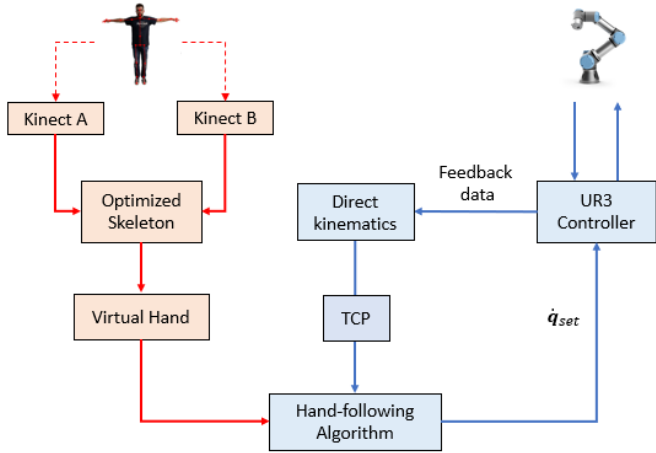

Fig. 8. In red the loop of the virtual hand position calculation that runs with a 30Hz frequency, in blue the UR3 control loop that update the $\dot{\mathbf{q}}_{set}$ with 60Hz frequency.

The optimized skeleton data (the joint positions $\mathbf{p}_{joints,k}$) are then sent from the Master to the External robot controller, that calculates the position of the virtual hand $\mathbf{p}_{vh,k}$. The External robot controller receive also feedback data from the controller of the robot. The feedback data and the target point position are the input of the path-planning algorithm, that generates the joints velocity vector $\dot{\mathbf{q}}_k$. Finally, the External robot controller send the vector $\dot{\mathbf{q}}_k$ to the controller of the robot through UR3 customized APIs, built by the authors to interface the robot with Matlab. A pseudocode of the Kinect acquisition process and the calculation of the set velocity vector $\dot{\mathbf{q}}$ for the controller is reported in Fig. 7, while the flowchart of the hand-over strategy can be seen in Fig. 8. The virtual hand position information is updated with a 30Hz frequency, instead the vector $\dot{\mathbf{q}}$ is calculates with 60Hz frequency. So, there are two control loops: an external one that calculates the target position every 0.033 ms, and an internal one that works with a frequency of 60Hz and generates the velocity set for the controller of the UR3.

B. Tests

Different movements towards casual meeting points into the collaborative volume were performed by the human. In all cases it was observed that the robot can meet the human hand with a final pose which is suitable for the hand-over, both in position and orientation. In Fig. 9 the frames of a hand-over characteristic test are showed, while Fig. 10 illustrates, for the same test, the relative distance between the human hand and the TCP of the

robot versus the time. The 6 frames identify the main stages of the hand-over task seen in Fig. 2, which are also indicated on the distances curve with different marks. If the hand is outside the collaborative volume, the robot does not move; when the human approaches the collaborative volume, the hand-following algorithm drives the UR3 TCP, which starts pointing toward the dynamic target (*follow*). Due to the restricted robot velocity [5], the human reaches a meeting point (*reach*) and waits for the robot (*wait*). Once the relative distance assumes the stopping sphere radius value, the UR3 stops (*stop*) and the hand-over is accomplished (*hand-over*). Finally, the human exits the meeting volume (*retract*) and the robot takes the object in its home position (*home*). During the targeting phase, even if the robot represents an obstacle for the vision system, the optimization made on the skeleton solves the occlusions and produces a quite stable track of the human hand. Results in terms of trajectories are showed in Fig. 11, where the hand paths and the TCP paths are plotted, together with the stopping volume, for different meeting points. In Fig. 12 the module of the TCP linear velocity vector versus the time for a characteristic test is shown. The profile of the velocity is quite smooth, so there were no sudden movements of the robot. The norm of the TCP velocity is zero when the hand is outside the collaborative volume ($t < 1s$) and when the distance between the virtual hand and the TCP is less than ($t > 5s$).

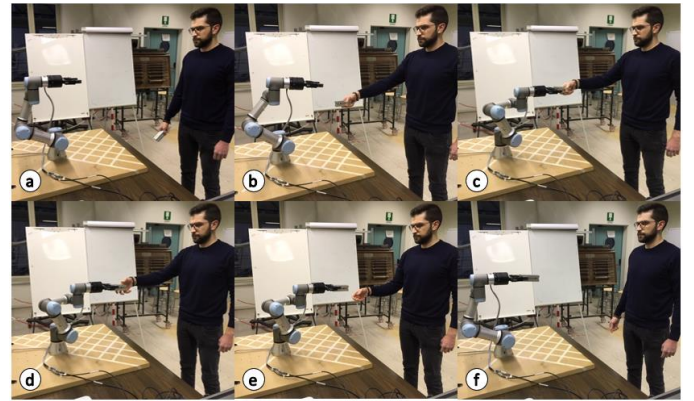

Fig. 9. Hand-over task, test frames: a) task start; b) follow; c) reach; d) hand-over; e) retract; f) home.

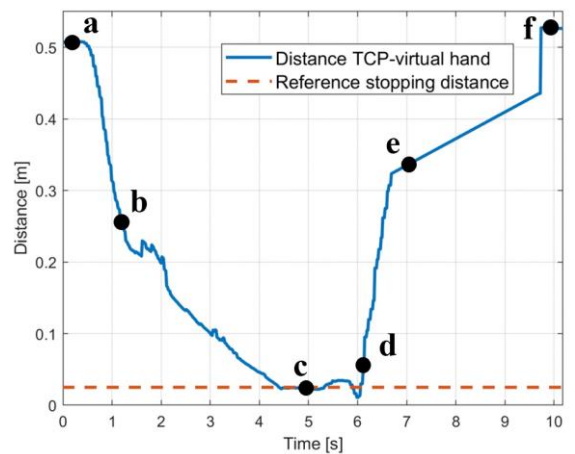

Fig. 10. Distance virtual hand-TCP in function of task time

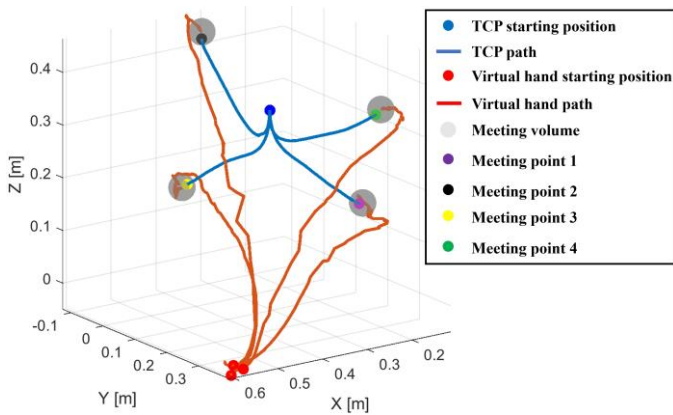

Fig. 11. Paths of the virtual hand and of the TCP of the robot for different meeting points.

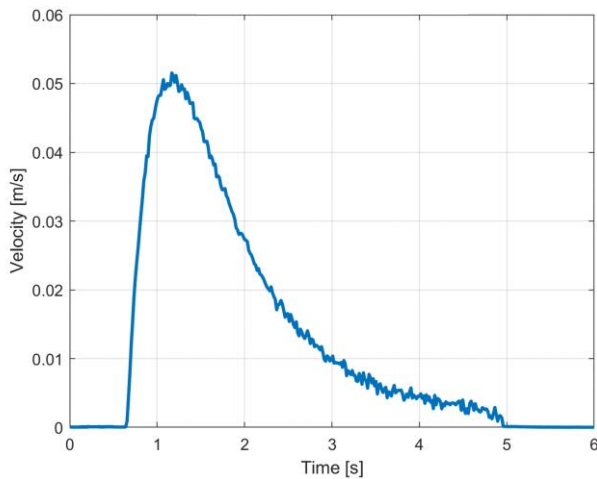

Fig. 12. Norm of the TCP linear velocity vector during the hand-over task.

V. CONCLUSIONS

In this work, a collaborative workspace and a hand-over strategy implemented on a UR3 to perform a collaborative task were presented and described. The collaborative set-up included optimized human skeleton tracking by means of two depth cameras and a local control strategy for the on-line motion planning of the robot. The collaborative task consisted in a 6-stage hand-over in which the giver (human) moved towards casual meeting point inside the robot (receiver) workspace. The proposed hardware architecture used a Master-Slave computer configuration to run the human tracking algorithm at 30 Hz. The path-planning algorithm was handled by a third computer, which sent data to the robot controller through UR3 customized APIs. Finally, the UR3 controller updates the robot velocity set at the

frequency of 60 Hz. Tests were performed to verify that the strategy successfully accomplishes the hand-over between the human operator and the collaborative robot. Results validated the control algorithm and the robot motion planning strategy, showing the improvements coming from the introduction of a virtual target, which is an extension of the human hand. Future works will involve prediction of the movements of the human operator to refine the algorithm and different modelling of the TCP linear velocity to obtain human-like movements of the robot.

REFERENCES

- [1] J. Kruger, T.K. Lien, and A. Verl, "Cooperation of human and machines in assembly lines," in *CIRP Annuals, Manufacturing Technology*, vol. 58, 2009, pp. 628-646.
- [2] M. Cakmak, S. S. Srinivasa, M. K. Lee, S. Kiesler, and J. Forlizzi, "Using spatial and temporal contrast for fluent robot-human hand-overs," in *Proc. 6th ACM/IEEE Int. Conf. Human-Robot Interaction*, 2011, pp. 489-496.
- [3] G. Michalos, S. Makris, P. Tsarouchi, T. Guasch, D. Kontovrakis, and G. Chryssolouris, "Design considerations for safe human-robot collaborative workplaces," in *Proc. CIRP - Understanding the life applications of manufacturing*, vol. 37, 2015, pp. 248-253.
- [4] M. Melchiorre, L. Scimmi, S. Mauro, and S. Pastorelli, "Influence of human limb motion speed in a collaborative hand over task," in *Proc. of the 15th Int. Conf. on Informatics in Control, Automation and Robotics*, vol. 2, 2018, pp. 349-356.
- [5] <https://www.iso.org/standard/62996.html>
- [6] A. Koene, A. Remazeilles, M. Prada, A. Garzo, M. Puerto, S. Endo, and A. M. Wing, "Relative importance of spatial and temporal precision for user satisfaction in human-robot object handover interaction," in *Proc. New Frontiers in Human-Robot Interaction*, 2014.
- [7] C. M. Huang, M. Cakmak, B. Mutlu, "Adaptive coordination strategies for human-robot handovers," in *Robotics: Science and Systems*, 2015, pp. 1-10.
- [8] W. Wang, R. Li, Z. M. Diekel, Y. Chen, Z. Zhang, and Y. Jia, "Controlling object hand-over in human-robot collaboration via natural wearable sensing," in *IEEE Transactions on Human-Machine Systems*, vol. 49(1), 2019, pp. 59-71.
- [9] <https://www.universal-robots.com/products/ur3-robot/>.
- [10] L. S. Scimmi, M. Melchiorre, S. Mauro, and S. Pastorelli, "Multiple collision avoidance between human limbs and robot links algorithm in collaborative tasks," in *Proceedings of the 15th International Conference on Informatics in Control, Automation and Robotics*, vol. 2, 2018.
- [11] K. Y. Yeung, T. H. Kwok, and C. L. Wang, "Improved skeleton tracking by a duplex kinects: a practical approach for real-time applications," in *Journal of Computing and Information Science in Engineering*, 13(4), 2013.
- [12] S. Mauro, S. Pastorelli, and L. S. Scimmi, "Collision Avoidance Systems for Collaborative Robotics," in *Mechanisms and Machine Science*, Vol. 49, pp. 344-352, 2018.
- [13] S. Mauro, L. S. Scimmi, and S. Pastorelli, "Collision Avoidance Algorithm for Collaborative Robotics," in *Int. J. Automation Technol.*, Vol. 11, No. 3, pp. 481-489, 2017.