

A Risk-Based Decision Framework for the Distribution Company in Mutual Interaction with the Wholesale Day-ahead Market and Microgrids

*Original*

A Risk-Based Decision Framework for the Distribution Company in Mutual Interaction with the Wholesale Day-ahead Market and Microgrids / Bahramara, Salah; Sheikahmadi, Pouria; Mazza, Andrea; Chicco, Gianfranco; Shafie-khah, Miadreza; Catalao, Joao P. S.. - In: IEEE TRANSACTIONS ON INDUSTRIAL INFORMATICS. - ISSN 1551-3203. - ELETTRONICO. - 16:2(2020), pp. 764-778. [10.1109/TII.2019.2921790]

*Availability:*

This version is available at: 11583/2761638 since: 2020-01-30T17:34:04Z

*Publisher:*

IEEE

*Published*

DOI:10.1109/TII.2019.2921790

*Terms of use:*

This article is made available under terms and conditions as specified in the corresponding bibliographic description in the repository

*Publisher copyright*

IEEE postprint/Author's Accepted Manuscript

©2020 IEEE. Personal use of this material is permitted. Permission from IEEE must be obtained for all other uses, in any current or future media, including reprinting/republishing this material for advertising or promotional purposes, creating new collecting works, for resale or lists, or reuse of any copyrighted component of this work in other works.

(Article begins on next page)

# A Risk-Based Decision Framework for the Distribution Company in Mutual Interaction with the Wholesale Day-ahead Market and Microgrids

Salah Bahramara, *Member, IEEE*, Pouria Sheikahmadi, Andrea Mazza, *Member, IEEE*, Gianfranco Chicco, *Fellow, IEEE*, Miadreza Shafie-khah, *Senior Member, IEEE* and João P.S. Catalão, *Senior Member, IEEE*

**Abstract**—One of the emergent prospects for active distribution networks is to establish new roles to the distribution company (Disco). The Disco can act as an aggregator of the resources existing in the distribution network, also when parts of the network are structured and managed as microgrids (MGs). The new roles of the Disco may open the participation of the Disco as a player trading energy in the wholesale markets, as well as in local energy markets. In this paper, the decision making aspects involving the Disco are addressed by proposing a bi-level optimization approach in which the Disco problem is modeled as the upper-level problem and the MGs problems and day-ahead wholesale market clearing process are modeled as the lower-level problems. To include the uncertainty of renewable energy sources, a risk-based two-stage stochastic problem is formulated, in which the Disco's risk aversion is modeled by using the conditional value at risk. The resulting non-linear bi-level model is transformed into a linear single-level one by applying the Karush-Kuhn-Tucker conditions and the duality theory. The effectiveness of the model is shown in the application to the IEEE 33-bus distribution network connected to the IEEE RTS 24-bus power system.

**Index Terms**—Active distribution networks, wholesale market, microgrids, Bi-level approach, Two-stage stochastic model, Risk management.

## NOMENCLATURE

### Acronyms

<i>CVaR/VaR</i>	Conditional Value at Risk/Value at Risk
<i>DAEM/RTEM</i>	Day-ahead energy market/Real-time energy market
<i>DER/DG</i>	Distributed energy resource/Distributed generator
<i>Disco</i>	Distribution Company
<i>DN/DNL</i>	Distribution network/Distribution network load
<i>DR</i>	Demand response
<i>DSO</i>	Distribution system operator
<i>ES</i>	Energy storage
<i>Genco</i>	Generation Company
<i>IL</i>	Interruptible load
<i>ISO</i>	Independent system operator
<i>LL/UL</i>	Lower/Upper level
<i>LMP/MCP</i>	Local market price/Market clearing price
<i>MILP</i>	Mixed integer linear programming
<i>MG/MGL/MGO</i>	Microgrid/Microgrid load/Microgrid operator
<i>RES</i>	Renewable energy source
<i>TC/ETC</i>	Total cost/Expected total cost
<i>TN/TNL</i>	Transmission network/Transmission network load

### Indices and Sets

$b/B$	Index/set of energy and offers/bids block of Genco/TNL
$Conn(i, h)$	Mapping of each bus $h$ connected to bus $i$
$d/D$	Index/set of TNL
$i, h$	Indices of DN buses
$g/G$	Index/set of Genco
$j/J$	Index/set MG
$M_n^G/M_n^D$	Set of Genco/TNL located at bus $n$

$n, N/r, R$	Index and set of TN buses
$t/T$	Index/set of time period
$\omega/W$	Index/set of scenario
$\Lambda_n^{TN}$	Set of buses directly connected to TN bus $n$

### Parameters

$B_{n-r}$	Susceptance of TN line $n-r$ (per unit)
$C_{b,g,t}^{TN}/C_{b,g,t}^{TN}$	Offer/bid price block of Genco/TNL (\$/MWh)
$C_t^{DN,IL}/C_t^{MG,IL}$	Bid price of ILs (\$/MWh)
$C_{j,t}^{DG}/C_{j,t}^{ES}$	Bid price of DG/ES (\$/MWh)
$d_t$	Duration of time $t$ (hour)
$\bar{E}_j^{ES}/\underline{E}_j^{ES}$	Maximum/Minimum energy stored in ES (MWh)
$\bar{f}_{n-r}^{TN}$	Capacity limit of each TN line $n-r$ (MW)
$\bar{I}_{i,j}^{DN}$	Maximum limitation of DN feeder current (kA)
$\bar{L}_{d,t}^{TN}/\bar{l}_{b,d,t}^{TN}$	Max demand/size of TNL energy block (MW)
$\bar{P}_g/\bar{P}_{b,g}^{TN}$	Max production/size of Genco energy block (MW)
$\bar{P}^{TN,Dis}/\underline{P}^{TN,Dis}$	Limitations of Disco power exchange with market (MW)
$\bar{P}_j^{Dis,MG}/\underline{P}_j^{Dis,MG}$	Limitations of Disco power exchange with MGs (MW)
$P_t^{DNL,Det}/P_{t,\omega}^{DNL}$	Deterministic/Probabilistic DNL (MW)
$P_{j,t}^{MGL}$	Demand of MG (MW)
$\bar{P}_j^{DG}/\underline{P}_j^{DG}$	Power limitations of DG (MW)
$\bar{P}_j^{ESch}/\underline{P}_j^{ESdch}$	Maximum charging/discharging power of ES (MW)
$\bar{P}_{t,\omega}^{RES}/C_{t,\omega}^{RES}$	Maximum output power of RES (MW)/RES operation cost (\$/MWh)
$RU_g/RD_g$	Ramp-up/down limits of Genco (MW/h)
$RU_j^{DG}/RD_j^{DG}$	Ramp-up/down limits of DG (MW/h)
$\underline{V}_j^{DN}/\bar{V}_j^{DN}$	Upper/Lower limit of voltage of DN bus (kV)
$Z_{j,h}^{DN}/R_{j,h}^{DN}$	Impedance/Resistance of DN line (ohm)
$\alpha/\beta$	Confidence level/Risk-aversion parameters
$\gamma^{Dis}/\gamma_j^{MG}$	Maximum load interruption factors of DN/MGs (MW)
$\lambda_{j,t}^{MGL}$	Selling energy price to demand of MG (\$/MWh)
$\lambda_t^{DNL}$	Selling energy price to DNL (\$/MWh)
$\psi_\omega$	Occurrence probability of each scenario

### Variables

$C_t^{TN,Dis}$	Offer/bid price of Disco to wholesale market (\$/MWh)
$C_t^{Dis,MG}$	Offer/bid price of Disco to MGs (\$/MWh)
$E_{j,t}^{ES}$	The amount of energy stored in ES (MWh)
$I_{t,j,h}^{DN}/I_{t,j,h}^{DN,Lin}$	DN feeder current/linearized current (kA/kA <sup>2</sup> )
$P_{t,i,h}^{Fm}$	Active power flow moves from bus $i$ to bus $h$ (MW)
$P_{t,i,h}^{To}$	Active power flow moves from bus $h$ to bus $i$ (MW)
$P_{t,i,h}^{Loss}$	The amount of active power losses (MW)
$L_{d,t}^{TN}/l_{b,d,t}^{TN}$	The amount of TNL and its block (MW)
$P_{g,t}^{TN}/\rho_{b,g,t}^{TN}$	Output power of Genco and its block (MW)
$P_t^{TN,Dis}$	Disco power exchange from wholesale market (MW)
$P_{j,t}^{Dis,MG}$	Disco power exchange to MGs (MW)
$P_{t,\omega}^{Dis,IL}$	The amount of load interruption of Disco (MW)

$P_{t,\omega}^{RES}$	Output power of RESs (MW)
$P_{j,t}^{MG\_IL}$	The amount of load interruption in each MG (MW)
$P_{j,t}^{DG}$	Output power of DGs (MW)
$P_{j,t}^{ESch} / P_{j,t}^{ESdch}$	Power charging/discharging of ES (MW)
$V_{t,j}^{DN} / V_{t,j}^{DN\_Lim}$	DN bus voltage/linearized voltage (kA/kV <sup>2</sup> )
$\gamma_t$	The amount of load shifting factor
$\theta_{n,t}$	Angle of TN bus voltage (rad)
$\lambda_{m,t}^{TN\_Dis}$	MCP or LMP at the TN bus m where the Disco is located
$\lambda_{j,t}^{Dis\_MG}$	Local market price
$\xi, \eta_\omega$	Auxiliary variables used in CVaR calculation

## I. INTRODUCTION

### A. Motivation and aim

IN the current evolution of the electrical distribution systems, distributed energy resources (DERs) and microgrids (MGs) are playing increasingly important roles. In this evolving framework, the distribution companies (Discos) will have to change their characteristics with respect to the past. There is an increasing trend to create multi-energy systems that may take benefits from the coordinated operation of electricity together with other energy carriers. Correspondingly, there is a trend to decentralize the decision-making concerning energy management in localized areas, under the coordination of specific aggregators. This situation is also promoting the birth of local energy markets, in which multiple entities (Discos, large consumers, aggregators) are competing to provide energy and services to the consumers.

The evolving role of the Discos is discussed in various documents. A specific example is the New York State Reforming Energy Vision [1], where the Disco is identified as the coordinator of a Distributed System Platform Provider, as the interface to connect the relevant entities, from consumers to aggregators. In this Disco-centric view, the Platform will also coordinate DER markets with the participation of competitive energy service providers. Conversely, some consumer-centric or MG-centric visions have been developed, in which the role of the Disco is considered to be progressively lower. These visions include the formation of multi-MGs managed by an aggregator [2], the *web of cells* approach [3], up to extreme *grid defection* [4] scenarios in which the local prosumers tend to become independent of the grid. The latter possibility is however unlikely to occur, because of the cost effectiveness of the centralized distribution network due to the economy of scale, together with the increasing amount of power that will be needed from the grid in the process of progressive electrification that is reaching the final user (e.g., to supply heat pumps and electric vehicles). Rather, the presence of the distribution network may provide new business opportunities to connect new DERs and manage them efficiently. In parallel with the evolution of the networks, there is a growing interest towards the development of local energy systems and markets. In [5] a multi-energy player is considered as a DER aggregator, without representing the distribution network explicitly (i.e. using a single-node multi-energy system). In [6] a local energy market is proposed to create new opportunities to increase the benefits of sellers and consumers through local cooperation, again without considering the role of the Disco.

The aspects indicated above motivate the interest towards

studying the evolution of Discos, including the action of Discos as possible aggregators, and the Disco interactions with local energy markets.

The aim of this paper is to model the decision making behavior of a Disco in the wholesale day-ahead energy market (DAEM) while it interacts with MGs in a local energy market, considering the uncertainties of generation from renewable energy sources (RESs) and demand.

### B. Literature review and contribution

The decision-making problem of a Disco that participates as a price-taker in the electricity market is modeled in different ways. Two-stage deterministic and stochastic optimization approaches are proposed in both DAEM and real-time energy market (RTEM) in [7] and [8], respectively. Optimal scheduling of DERs by the Disco is done regarding the forecast prices of DAEM and the reserve markets in [9]. The optimal operation of a Disco is modeled in [10] to manage the uncertainties of distributed generators (DGs) and loads through optimal charging/discharging of energy storage (ES). In [11, 12], the operation problem of a Disco is modeled through optimal trading energy with DER aggregators in which the problem of the Disco and the aggregators are formulated as the upper-level (UL) and the lower-level (LL) problems, respectively. As the UL problem is non-linear, the formulation is based on a non-linear model without complementarity. In [13], a hierarchical decision-making framework is proposed for distribution networks in which a Disco cooperates with several MGs. To model such a framework, a bi-level approach is used in which the Disco as the upper-level problem participates as a price-taker player in the market.

In the presence of DERs, the Disco can trade energy with these resources to reduce the purchased energy from the markets. This action changes the bids of the Disco to the market, which in turn, may lead to decreasing the wholesale energy prices. Therefore, new decision making frameworks are required where the Disco participates in wholesale markets as a price-maker player. In [14], a deterministic bi-level approach is presented where the UL problem is to maximize the social welfare of DAEM and the LL problem models the interaction between the Disco and DER managers. The strategic behavior of a Disco in the DAEM is modeled in [15] with a stochastic bi-level approach, and in [16] by considering the Disco as the leader and DAEM and RTEM as the followers. In [17], the Disco participates in the RTEM as a price-maker using a demand response aggregator in the distribution network. The solution is obtained with a bi-level optimization approach, in which the Disco and the RTEM are considered as the leader and the follower, respectively. However, RES and demand uncertainties are not considered, and the Disco cannot manage the risk of its decision-making.

In the proposed models for a price-maker Disco, for example [14-17], the behavior of DER managers such as aggregators and MGs is not modeled. In other words, these energy players propose fixed price signals to the Disco, regarding which the Disco decides on their optimal scheduling and participates in the wholesale markets. However, the effects of their optimal behavior on the decisions of the Disco and wholesale energy markets are not modeled.

MGs are appropriate solutions for better management and

operation of the DERs to meet the local demand. From the viewpoint of the market, MGs receive/offer fixed prices from/to the Disco and consequently schedule their resources. An MG operator (MGO) can participate in wholesale markets individually or through an MG aggregator regarding the licenses of the markets. When the MGO participates individually, it cannot change the market prices and acts as a price-taker regarding the low capacity in trading power with the market. On the other hand, in both modes (*i.e.* individual or through an aggregator participation), this behavior of MGs faces the independent system operator (ISO) and the distribution system operator (DSO) with the operational problems since the distribution network constraints have been ignored in such models [18]. Although a transmission system operator (TSO)-DSO iteration approach is proposed to solve this challenge, it leads to heavy operational processes endangering the deadline of finishing the market clearing process as mentioned in [19]. To overcome these operational problems, new local markets can be created in the distribution network. These local markets can be managed by the MGO receiving bids/offers from DER managers and the Disco. The MGO clears the market and decides about the optimal scheduling of the DERs and the power trading with the Disco. Regarding the response of the MGO, the Disco may change the bids/offers to the wholesale and the local markets. In such a framework, the impact of the optimal behavior of the MGO and the results of the local market can be modeled in the wholesale energy markets. Moreover, the impacts of MGOs' decisions on the distribution network constraints can be considered in the same framework.

The main contribution of this paper is the proposal of a new operation problem for a Disco to simultaneously model its mutual interactions with both wholesale and local energy markets managed by the ISO and the MGOs, respectively. The framework of this paper simultaneously solves the two aforementioned problems: 1) modeling the impact of the MGO decisions in the wholesale energy market, and 2) modeling the impact of the MGO decisions in the local market on the distribution network operation constraints.

To model such decision-making framework, a risk-based bi-level optimization approach is developed. The UL problem is the risk minimization for the Disco. The two LL problems are the clearing processes of DAEM and local markets. The risk-level Disco's decisions in the presence of uncertainties to participate in the wholesale and local markets are managed through the Conditional Value at Risk (CVaR) index.

### C. Paper Organization

In the rest of this paper, section II presents the problem description. Section III shows the mathematical formulation of the LL problems. Section IV recalls the formulation of the bi-level problem as a mathematical problem with equilibrium constraints. Section IV reports and discusses the numerical studies. Section V concludes the paper.

## II. PROBLEM DESCRIPTION

The Disco-centric decision-making framework is shown in Fig. 1. The interruptible load (IL) aggregator submits its offer to the Disco, and the Disco decides on the amount of load curtailment. The Disco sends its offers/bids to the DAEM which is cleared by the ISO. After clearing the market, the power trading of the Disco with the market is determined. On

the other hand, for each MG, the DG, the IL, and the ES managed by the DER managers submit their offers to the MGO. Moreover, the Disco sends the uniform price signal to all MGOs, so that the local market price (LMP) becomes equal for all. The MGO clears the local energy market regarding the offers of the aggregators and the Disco, and then decides on the optimal scheduling of DERs and the optimal power trading with the Disco.

Fig. 2 shows the proposed bi-level optimization approach and illustrates the internal and the external decision variables for each player. The Disco decision-making problem is formulated as the UL problem. The wholesale and the local energy markets managed by the ISO and MGOs are modeled as two separate LL problems. Optimal scheduling of the IL and the RESs, the decision variables related to risk management, as well as the power flow variables, are internal decisions of the Disco. The bids/offers to both the wholesale and the local markets are considered as the external variables of the Disco. The ISO and MGOs receive the price signals from the Disco and clear the markets to decide about power trading with the Disco. This decision is considered as the external decision variable of both LL problems. Besides, the power generation of Gencos, the power consumption of TNL, and the voltage angles of TN buses are determined as the internal decision variables of the ISO problem. On the other hand, optimal scheduling of DGs, ILs, and ESs are considered as the internal variables for each MG.

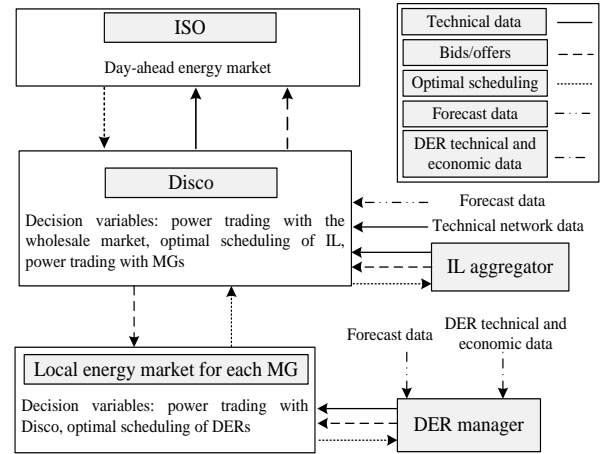

Fig. 1. Proposed decision-making framework of Disco in wholesale and local energy markets.

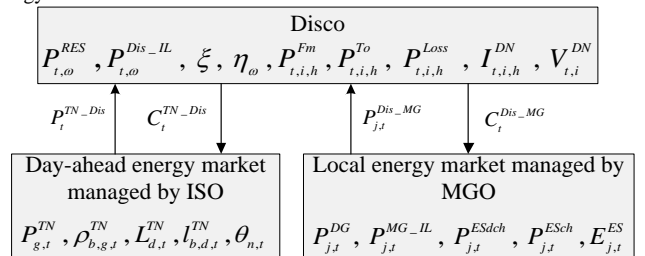

Fig. 2. The internal and external decision variables for each player in the proposed bi-level decision-making framework.

### A. Modeling uncertainties

The probability distribution functions (PDFs) used to model the uncertainties of demand, wind speed, and solar radiation, are the Normal, Weibull, and irradiance distribution models taken from [20, 21]. The Normal PDF has been discretized into seven intervals, while the other two PDFs

have been discretized into five intervals. Only the mean values of each interval are then considered, leading to a discretized set of values for each variable. The probability of occurrence represented by each discrete value is obtained through integration from the mentioned PDFs regarding the lower and upper limitations of each interval.

For each parameter, 24000 samples are generated regarding the probability of the intervals. The average value of each interval is multiplied with the forecast value of the parameter, to show the value of that parameter in each sample. Then, the scenario tree construction has been used to generate different scenarios, as described in [22]. In this approach, the time steps defined in the problem (i.e. 24 hours), and the generated samples are used as the scenario tree stages and the nodes, respectively, in which a scenario is defined as the path among the nodes. Using the scenario tree method, 1000 scenarios have been generated to model the uncertainties, which are then reduced to 15 scenarios using the General Algebraic Modeling System/Scenario Reduction (GAMS/SCENRED) package and the fast-forward scenario reduction technique. Each scenario consists of demand, wind speed, and solar radiation data for the time period (24 hours) of operation. The probability of occurrence of each scenario [20, 23] is shown in Table I. Then, the output power of wind turbine (WT) and photovoltaic (PV) arrays are calculated using the models proposed in [24].

TABLE I

OCURRENCE PROBABILITY OF SCENARIOS IN THE DECISION MAKING PROBLEM OF THE DISCO

# scenario	1	2	3	4	5
Probability	0.061	0.049	0.047	0.091	0.051
# scenario	6	7	8	9	10
Probability	0.085	0.077	0.065	0.065	0.064
# scenario	11	12	13	14	15
Probability	0.074	0.087	0.067	0.063	0.054

### B. Total cost for the Disco

The Expected Total Cost (ETC) for the Disco is expressed as the weighted average of the total costs resulting from all scenarios  $\omega = 1, \dots, W$ :

$$ETC = \sum_{\omega=1}^W \psi_{\omega} TC_{\omega} \quad (1)$$

where the total cost (TC) includes the costs of the power exchange with the DAEM and MGs, the RES operation cost, the cost of load interruption, and the revenues due to the energy sold to the consumers:

$$TC_{\omega} = \sum_{t=1}^T d_t \left[ \lambda_t^{TN\_Dis} P_t^{TN\_Dis} + \sum_{j=1}^J \lambda_{j,t}^{Dis\_MG} P_{j,t}^{Dis\_MG} + C_t^{RES} P_{t,\omega}^{RES} + \left( C_t^{DN\_IL} + \lambda_t^{DNL} \right) P_{t,\omega}^{Dis\_IL} - \lambda_t^{DNL} P_{t,\omega}^{DNL} \right] \quad \forall \omega. \quad (2)$$

The power balance constraint of the distribution network (DN) at the reference bus and at the other buses are formulated as (3) and (4), respectively.

$$P_t^{TN\_Dis} + \sum_{j=1}^J P_{j,t}^{Dis\_MG} + P_{t,\omega}^{Dis\_IL} + P_{t,\omega}^{RES} - P_{t,\omega}^{DNL} = \sum_{h \in Conn(i,h)}^H 0.5 (P_{t,i,h}^{Flow} + P_{t,i,h}^{Loss}) \quad \forall t, i = 1, \omega, \quad (3)$$

$$\sum_{j=1}^J P_{j,t}^{Dis\_MG} + P_{t,\omega}^{Dis\_IL} + P_{t,\omega}^{RES} - P_{t,\omega}^{DNL} = \sum_{h \in Conn(i,h)}^H 0.5 (P_{t,i,h}^{Flow} + P_{t,i,h}^{Loss}) \quad \forall t, i \neq 1, \omega. \quad (4)$$

The upper bound of the purchased power from the IL aggregator by the Disco is expressed as

$$0 \leq P_{t,\omega}^{Dis\_IL} \leq \gamma^{Dis} P_t^{DNL\_Det} \quad \forall t, \omega, \quad (5)$$

and the limitations to the RES output power are

$$0 \leq P_{t,\omega}^{RES} \leq \bar{P}_{t,\omega}^{RES} \quad \forall t, \omega. \quad (6)$$

The distribution network is modeled as in [25]:

$$I_{t,i,h}^{DN} = (V_{t,i}^{DN} - V_{t,h}^{DN}) / Z_{i,h}^{DN} \quad \forall t, i, h \quad (7)$$

$$-\bar{I}_{i,h}^{DN} \leq I_{t,i,h}^{DN} \leq \bar{I}_{i,h}^{DN} \quad \forall t, i, h, \quad \underline{V}_i^{DN} \leq V_{t,i}^{DN} \leq \bar{V}_i^{DN} \quad \forall t, i \quad (8)$$

$$P_{t,i,h}^{Fm} - P_{t,i,h}^{To} = \frac{R_{i,h}^{DN}}{(Z_{i,h}^{DN})^2} \left( (V_{t,i}^{DN})^2 - (V_{t,h}^{DN})^2 \right) \quad \forall t, i, h \quad (9)$$

$$P_{t,i,h}^{Fm} + P_{t,i,h}^{To} = R_{i,h}^{DN} (I_{t,i,h}^{DN})^2 \quad \forall t, i, h. \quad (10)$$

The technical constraints related to the distribution network are presented as Eqs. (7)-(10). The amount of feeders current is determined by (7). The upper and lower limitations of current and voltage of the network are modeled by (8). Eq. (9) is used to model the amount of active power flows in the network. Eq. (10) calculates the amount of power losses in each feeder (if  $I_{t,i,h}^{DN}$  or  $I_{t,i,h}^{DN} \geq 0$ ; otherwise is equal to 0). The non-linear terms  $(V_{t,i}^{DN})^2$  and  $(I_{t,i,h}^{DN})^2$  are transformed with linear ones regarding the piecewise approach proposed in [25] as follows:

$$V_{t,i}^{DN\_Lin} = -\underline{V}_i^2 + 2\underline{V}_i V_{t,i}^{DN} + \Delta V_{t,i}^{Lin} \quad \forall t, i \quad (11)$$

$$I_{t,i,h}^{DN\_Lin} = \sum_k^K (2k-1) \left( \bar{I}_{i,h}^{DN} / K \right) \Delta I_{t,i,h,k} \quad \forall t, i, h \quad (12)$$

where  $\Delta V_{t,i}^{Lin}$ ,  $k$ ,  $K$ , and  $\Delta I_{t,i,h,k}$  describes the square of  $\Delta V_{t,i}$  (summation of all the piecewise segments of voltage magnitude deviation), the piecewise segment number, the total number of piecewise segments, and the value of the  $k^{\text{th}}$  block of the current flow magnitude of feeders.

### C. Risk management

The scenarios generated to model the uncertain parameters divide the decisions of the Disco into two steps, consisting of before and after the occurrence of the scenarios. To model the operation problem of the Disco under uncertainty, a risk-based two-stage stochastic optimization approach is used. The bids of the Disco to both wholesale and local markets are independent of the occurrence of the scenarios, and are considered as the first-stage or here-and-now decisions. Conversely, the output power of RESs and the amount of load interruption depend on each scenario and are considered as the second-stage or wait-and-see decisions. Since the uncertainties of RESs and demand refer to the Disco, they are modelled only in internal decisions variables of the Disco including optimal scheduling of IL and RESs. In fact, the Disco decides on optimal bidding strategy to the DAEM and MGs before the occurrence of the scenarios, while the internal decision variables are found after the occurrence of the scenarios.

As mentioned, to model the effect of the uncertainties on the operation results, some scenarios are generated. In the worst scenarios, the expected total operation cost may be very high. Therefore, a risk management method is used to model the effect of the uncertainties on the strategic behavior of the

Disco in both wholesale and local markets [8]. The CVaR method is used to model the Disco's risk aversion [23] as follows:

$$CVaR = \xi + \frac{1}{1-\alpha} \sum_{\omega=1}^W \psi_{\omega} \eta_{\omega} \quad (13)$$

$$TC_{\omega} - \xi - \eta_{\omega} \leq 0, \quad \eta_{\omega} \geq 0 \quad \forall \omega. \quad (14)$$

The optimal value of  $\xi$  is the VaR, and  $\eta_{\omega}$  is a variable used to model the excess cost over  $\xi$  in the scenario  $\omega$ .

#### D. Final objective function of the UL problem

The final objective function of the Disco problem is described as follows:

$$\text{Minimize} \{ ETC + \beta(CVaR) \} \quad (15)$$

where the risk of Disco in decision making is controlled using the risk-aversion parameter  $\beta$ . For  $\beta = 0$  the decision-maker is neutral. When  $\beta$  increases the Disco becomes more risk-averse. The variable set of the Disco problem is described as  $\mathbf{X} = \{C_t^{TN\_Dis}, C_t^{Dis\_MG}, P_{t,\omega}^{RES}, P_{t,\omega}^{Dis\_IL}, V_{t,i}^{DN}, I_{t,i,h}^{DN}, P_{t,i,h}^{To}, P_{t,i,h}^{Fm}, \eta_{\omega}, \xi\}$ .

### III. MATHEMATICAL MODELING OF THE LL PROBLEMS

#### A. Wholesale DAEM

The DAEM problem formulation is presented as in (16)-(29). The objective function of the DAEM presented by (16) is the social welfare of the market players consisting of Gencos, the transmission network load (TNL), and the Disco, respectively. In the last term of this equation, the non-negative  $P_t^{TN\_Dis}$  is the bid, and its negative is the offer.

$$\text{Minimize} \sum_{t=1}^T d_t \left[ \sum_{g=1}^G \sum_{b=1}^B (C_{b,g,t}^{TN} \rho_{b,g,t}^{TN}) - \sum_{d=1}^D \sum_{b=1}^B (C_{b,d,t}^{TN} l_{b,d,t}^{TN}) - C_t^{TN\_Dis} P_t^{TN\_Dis} \right]. \quad (16)$$

The formulation of the constraints is reported below. The dual variables (Lagrangian multiplier for each constraint of the LL problem) are considered at the right side of the colon.

1) *Power balance constraint*: The DC power flow constraints (17) and (18) are used to model the power balance constraint at bus  $m$  (the DN location) and other buses, respectively.

$$\sum_{g \in M_n^G} P_{g,t}^{TN} - P_t^{TN\_Dis} = \sum_{r \in \Lambda_n^{TN}} B_{m-r} (\theta_{m,t} - \theta_{r,t}) : \lambda_{n,t}^{TN\_Dis} \quad \forall n = m, t \quad (17)$$

$$\sum_{g \in M_n^G} P_{g,t}^{TN} - \sum_{d \in M_n^D} L_{d,t}^{TN} = \sum_{r \in \Lambda_n^{TN}} B_{n-r} (\theta_{n,t} - \theta_{r,t}) : \lambda_{n,t}^{TN\_Dis} \quad \forall n, n \neq m, t \quad (18)$$

2) *Constraints of the Disco*: The maximum exchange power between the Disco and the market is limited by (19).

$$P_{t,Dis}^{TN} \leq P_t^{TN\_Dis} \leq \bar{P}_t^{TN\_Dis} : \underline{\mu}_t^{1\_TN}, \bar{\mu}_t^{1\_TN} \quad \forall t \quad (19)$$

3) *Constraints of Gencos*: The constraint (20) limits the power generation of the Gencos. The constraints (21)-(22) consider ramp-up (RU) and ramp-down (RD) limitations of the Gencos. The upper bounds of energy blocks related to the Gencos are limited by (23). The summation of energy blocks of Gencos is equal to their total output power, as modeled by (24).

$$P_g \leq P_{g,t}^{TN} \leq \bar{P}_g : \underline{\mu}_{g,t}^{2\_TN}, \bar{\mu}_{g,t}^{2\_TN} \quad \forall g, t \quad (20)$$

$$P_{g,t-1}^{TN} - P_{g,t}^{TN} \leq RD_g : \underline{\mu}_{g,t}^{3\_TN} \quad \forall g, t > 1, \quad P_{g,ini}^{TN} - P_{g,t}^{TN} \leq RD_g : \underline{\mu}_{g,t}^{4\_TN} \quad \forall g, t = 1 \quad (21)$$

$$P_{g,t}^{TN} - P_{g,t-1}^{TN} \leq RU_g : \underline{\mu}_{g,t}^{5\_TN} \quad \forall g, t > 1, \quad P_{g,t}^{TN} - P_{g,ini}^{TN} \leq RU_g : \underline{\mu}_{g,t}^{6\_TN} \quad \forall g, t = 1 \quad (22)$$

$$0 \leq \rho_{b,g,t}^{TN} \leq \bar{\rho}_{b,g,t}^{TN} : \underline{\mu}_{b,g,t}^{7\_TN}, \bar{\mu}_{b,g,t}^{7\_TN} \quad \forall b, g, t \quad (23)$$

$$P_{g,t}^{TN} = \sum_{b=1}^B \rho_{b,g,t}^{TN} : \lambda_{g,t}^{1\_TN} \quad \forall g, t \quad (24)$$

4) *Constraints of TNLs*: The constraint (25) limits the TNLs consumption. The upper bounds of the energy blocks related to the TNLs are limited by (26), and the summation of the energy blocks of TNLs is equal to the their energy consumption as modeled by (27).

$$0 \leq L_{d,t}^{TN} \leq \bar{L}_{d,t}^{TN} : \underline{\mu}_{d,t}^{8\_TN}, \bar{\mu}_{d,t}^{8\_TN} \quad \forall d, t \quad (25)$$

$$0 \leq l_{b,d,t}^{TN} \leq \bar{l}_{b,d,t}^{TN} : \underline{\mu}_{b,d,t}^{9\_TN}, \bar{\mu}_{b,d,t}^{9\_TN} \quad \forall b, d, t \quad (26)$$

$$L_{d,t}^{TN} = \sum_{b=1}^B l_{b,d,t}^{TN} : \lambda_{d,t}^{2\_TN} \quad \forall d, t \quad (27)$$

5) *Transmission network constraints*: The constraint (28) indicates the capacity limitation of the TN line from node  $n$  to node  $r$ . The constraint (29) defines the range of the TN voltage angle, and sets the TN bus as the reference bus.

$$-\bar{f}_{n-r}^{TN} \leq B_{n-r} (\theta_{n,t} - \theta_{r,t}) \leq \bar{f}_{n-r}^{TN} : \underline{\mu}_{n,r,t}^{10\_TN}, \bar{\mu}_{n,r,t}^{10\_TN} \quad \forall n, r \in \Lambda_n^{TN}, t \quad (28)$$

$$-\frac{\pi}{2} \leq \theta_{n,t} \leq \frac{\pi}{2} : \underline{\mu}_{n,t}^{11\_TN}, \bar{\mu}_{n,t}^{11\_TN} \quad \forall n, t, \quad \theta_{n,t} \Big|_{n=slack} = 0 : \lambda_{n,t}^{3\_TN} \Big|_{n=slack} \quad \forall t. \quad (29)$$

The variable set of the DAEM problem is described as  $\mathbf{Y} = \{P_{g,t}^{TN}, L_{d,t}^{TN}, \rho_{b,g,t}^{TN}, l_{b,d,t}^{TN}, P_t^{Dis}, \theta_{n,t}\}$ .

#### B. MGs problem

The MG problem is modeled as (30)-(43). The local market is cleared based on uniform prices. For the  $j^{\text{th}}$  MG, the operation problem is modeled by (30) which consists of the financial trading with the Disco (the non-negative  $P_{j,t}^{Dis\_MG}$  is the bid of the Disco to take energy from the MG, and its negative is the offer of the Disco to supply energy to the MG), the cost of the DGs, and the cost of the IL.

$$\text{Minimize} \quad TC^{MG}(j) = \sum_{t=1}^T \left[ -C_t^{Dis\_MG} P_{j,t}^{Dis\_MG} + C_j^{DG} P_{j,t}^{DG} + C_{j,t}^{MG\_IL} P_{j,t}^{MG\_IL} \right] \quad (30)$$

1) *Power balance constraint*: The power balance of each MG is modeled by (31).

$$P_{j,t}^{DG} + P_{j,t}^{MG\_IL} + P_{j,t}^{ESch} - P_{j,t}^{Dis\_MG} = P_{j,t}^{ESch} + P_{j,t}^{MGL} : \lambda_{j,t}^{Dis\_MG} \quad \forall j, t \quad (31)$$

2) *Power trading limit with the Disco*: The power trading between the Disco and MG is limited by (32).

$$P_{j,t}^{Dis\_MG} \leq P_{j,t}^{Dis\_MG} \leq \bar{P}_j^{Dis\_MG} : \underline{\mu}_{j,t}^{1\_MG}, \bar{\mu}_{j,t}^{1\_MG} \quad \forall j, t \quad (32)$$

3) *Constraints of DGs*: The constraint (33) represents the limitations of the output power of the DGs. Moreover, the other constraints consist of the RU and RD limitations described as (34)-(37).

$$0 \leq P_{j,t}^{DG} \leq \bar{P}_j^{DG} : \underline{\mu}_{j,t}^{2\_MG}, \bar{\mu}_{j,t}^{2\_MG} \quad \forall j, t \quad (33)$$

$$P_{j,t}^{DG} - P_{j,t-1}^{DG} \leq RU_j^{DG} : \underline{\mu}_{j,t}^{3\_MG} \quad \forall j, t > 1 \quad (34)$$

$$P_{j,t}^{DG} - P_{j,ini}^{DG} \leq RU_j^{DG} : \underline{\mu}_{j,t}^{4\_MG} \quad \forall j, t = 1 \quad (35)$$

$$P_{j,t-1}^{DG} - P_{j,t}^{DG} \leq RD_j^{DG} : \underline{\mu}_{j,t}^{5\_MG} \quad \forall j, t > 1 \quad (36)$$

$$P_{j,ini}^{DG} - P_{j,t}^{DG} \leq RD_j^{DG} : \underline{\mu}_{j,t}^{6\_MG} \quad \forall j, t = 1 \quad (37)$$

4) *Constraints of interruptible loads:* The constraint (38) is used to limit the maximum amount of interrupted load.

$$0 \leq P_{j,t}^{MG-IL} \leq \gamma_j^{MG} P_{j,t}^{MGL} : \underline{\mu}_{j,t}^{7-MG}, \bar{\mu}_{j,t}^{7-MG} \quad \forall j, t \quad (38)$$

5) *Constraints of ESs:* The constraints (39) and (40) are used to limit the maximum charging and discharging of ES. The energy stored in the ES is limited by (41) and the constraints (42) and (43) describe the coupling-in-time and the initial conditions for the energy stored in the ES, respectively.

$$0 \leq P_{j,t}^{ESch} \leq \bar{P}_j^{ESch} : \underline{\mu}_{j,t}^{8-MG}, \bar{\mu}_{j,t}^{8-MG} \quad \forall j, t \quad (39)$$

$$0 \leq P_{j,t}^{ESdch} \leq \bar{P}_j^{ESdch} : \underline{\mu}_{j,t}^{9-MG}, \bar{\mu}_{j,t}^{9-MG} \quad \forall j, t \quad (40)$$

$$E_j^{ES} \leq E_{j,t}^{ES} \leq \bar{E}_j^{ES} : \underline{\mu}_{j,t}^{10-MG}, \bar{\mu}_{j,t}^{10-MG} \quad \forall j, t \quad (41)$$

$$E_{j,t}^{ES} = E_{j,t-1}^{ES} + \eta_j^{ch} P_{j,t}^{ESch} - P_{j,t}^{ESdch} / \eta_j^{dch} : \lambda_{j,t}^{1-MG} \quad \forall j, t > 1 \quad (42)$$

$$E_{j,t}^{ES} = E_{j,ini}^{ES} + \eta_j^{ch} P_{j,t}^{ESch} - P_{j,t}^{ESdch} / \eta_j^{dch} : \lambda_{j,t}^{2-MG} \quad \forall j, t = 1. \quad (43)$$

The variable set of the MG problem is described as  $\mathbf{Z} = \{P_{j,t}^{Dis-MG}, P_{j,t}^{DG}, P_{j,t}^{MG-IL}, P_{j,t}^{ESch}, P_{j,t}^{ESdch}, E_{j,t}^{ES}\}$ .

#### IV. MATHEMATICAL PROGRAM WITH EQUILIBRIUM CONSTRAINT

Using the KKT conditions detailed in Appendix A, both LL problems are replaced with several constraints, regarding which the proposed bi-level problem is transformed to the single-level problem [24] named as mathematical program with equilibrium constraints (MPEC). Then, the non-linear terms, i.e. the first and second terms of equation (2), in the UL problem are replaced with linear expressions using duality theory [24] as presented in Appendix B. The resulting mixed-integer linear programming (MILP) model is based on the linearized form of Equation (15), subject to:

- Constraints of the Disco: Equations (3)-(14)
- KKT conditions of wholesale DAEM: Equations (44)-(60)
- KKT conditions of MGs problems: Equations (61)-(76).

This kind of problem has been addressed in [26] by considering the participation of a virtual power plant (without the Disco) in the wholesale energy market, and is proposed in this paper in the Disco-centric view.

#### V. NUMERICAL RESULTS

##### A. Data

The proposed model is applied on the IEEE 33-bus test system as a distribution network connected to the RTS 24-bus power system as shown in Fig. 3 to investigate the mutual interactions of the Disco with both markets. The input data of the distribution network and the power system are given in [9, 23, 27]. The TNL #17, located at TN bus  $m=20$ , is replaced

with the DN, and bus number 13 is considered as the reference bus. In the DN, MG1, MG2, and MG3 are located at buses 28, 20, and 18, respectively. The RESs have been located at buses 3, 8, 12, 18, 21, 22, 25, and 33. Moreover, the IL aggregator interacts with the DNLs located at buses 8, 24, 25, and 30-32. The forecast power generation of wind turbines (WTs) and photovoltaic (PV) arrays as the RESs, and the demand of the distribution network, are considered as proposed in [9, 28]. The price of selling energy by the Disco to DNL [15], the offers of the IL aggregator to the Disco, the operation cost of RESs, and the cost of MGLs interruption are shown in Fig. 4.

The bid of DGs for MG1, MG2, and MG3 are 12 \$/MWh, 14 \$/MWh, and 11 \$/MWh, respectively. The maximum power exchange of the Disco with the wholesale market is 50 MW. The technical and economic data related to the DERs in each MG are extracted from [9, 13, 16].

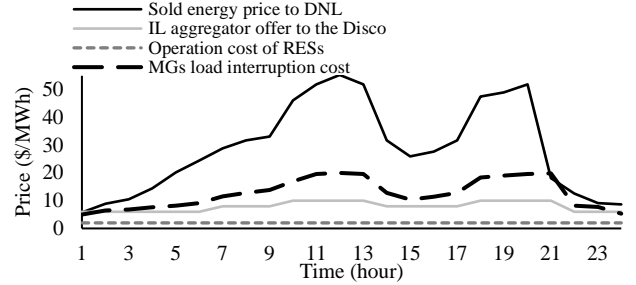

Fig. 4. Selling energy price to DNL, offers of IL aggregator and RESs, and the cost of MGLs interruption.

##### B. Results

The effect of optimal decisions of the Disco on both local and wholesale markets are investigated in this sub-section. For this purpose, four cases are presented to show the effect of different types of Disco's offers/bids to MGs and modeling the distribution network on the local and wholesale markets:

- Case I) Uniform local market price (LMP) considering DN
- Case II) Uniform LMP without DN
- Case III) Different LMPs considering DN
- Case IV) Different LMPs without DN

In Cases I and II, the uniform bids/offers are sent to MGs by the Disco, while different bids/offers are proposed to MGs in Cases III and IV by changing  $C_t^{Dis-MG}$  to  $C_{j,t}^{Dis-MG}$ . The DN power flow is calculated in Case I (base case) and Case III. The network is modeled as single bus in Cases II and IV.

The results of the four cases are compared with each other.

##### B.1. Results of Case I

The total operation cost of the Disco in each scenario is illustrated in Table II. The result are presented for the fourth

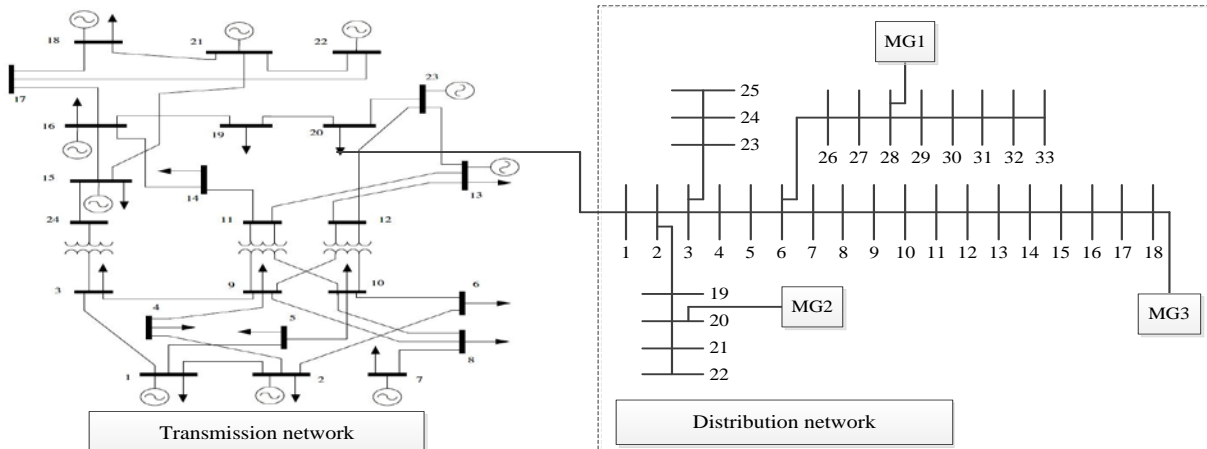

Fig. 3. The structure of the IEEE 33-bus DN connected to the IEEE 24-bus power system.

scenario ( $\omega = 4$ ), having an occurrence probability higher than other scenarios with  $\beta=0$  (risk-neutral Disco). The market clearing price (MCP) and LMP for both wholesale and local markets are shown in Fig. 5. The presence of DERs and MGs in the DN can change the Disco's decisions and impact on the MCP as shown in Fig. 6. Figs. 7, 8, and 9(a1) show the power balance of the power system, MGs, and DN, respectively. According to Figs. 5-7 and 9(a1), the behavior of the Disco (in the presence of DERs and MGs) reduces the MCPs from 10.66, 18.20, 11.96, and 10.66 \$/MWh to 10.25, 15.97, 11.72, and 10.25 \$/MWh at hours 2, 15, 22, and 24, respectively. In the other hours, the other decision makers of the wholesale market determine the market prices.

TABLE II

THE AMOUNT OF TOTAL COST IN EACH SCENARIO

# Scenario	1	2	3	4	5
Total cost (\$)	-11680	-11390	-11550	-11200	-11960
# Scenario	6	7	8	9	10
Total cost (\$)	-11038	-11800	-11700	-11510	-11500
# Scenario	11	12	13	14	15
Total cost (\$)	-11043	-12080	-11410	-11940	-11430

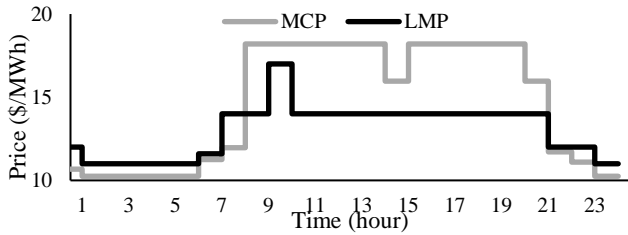

Fig. 5. MCP and LMP at each time step.

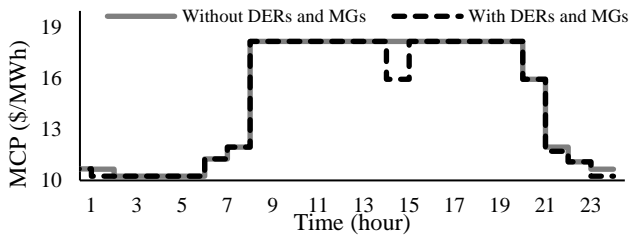

Fig. 6. The impact of the Disco's decisions on MCP with DERs and MGs.

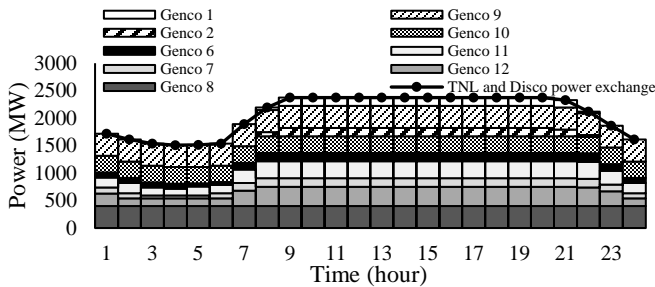

Fig. 7. Power balance results in the power system.

At hour 2, the Disco meets the demand with purchasing power from MG3 (Fig. 8(c)) and scheduling of IL and RESs (Fig. 9(a1)), which leads to decreasing the purchased power from the wholesale market. At hour 3, the same MCP reduction does not appear any longer. At hour 3, the decreasing of purchased power from the DAEM by the Disco cannot change the MCP regarding the high amount of DNL and the different amount of TNL and bids/offers of DAEM players in this hour in comparison with hour 2. At hour 3, decreasing the MCP from 10.25 \$/MWh (block 2 of Gencos 6 and 7) to 9.92 \$/MWh (block 1 of Gencos 6 and 7) would have occurred if the Disco had experienced a reduction of

76.998 MW in demand in the wholesale market, which did not occur. The same effect of reduction of purchased power from the DAEM appears at hour 15 (all MGs supply the DN, Fig. 8, and scheduling of IL and RESs, Fig. 9(a)), hour 22 (MG1 and MG3 supply the DN), and hour 24 (MG3 supplies the DN).

In the proposed model, the Disco decides on purchasing power from the IL aggregator regarding the cost of interruptible loads, the first-stage decisions, and offers of RESs. The cost of interruptible load is equal to the offer of the IL aggregator and the price of selling power to consumer as modeled in the fourth term of equation (2). The results show that the purchased power from the IL aggregator has impacts on trading power between the Disco with DAEM and MGs as well as the DN power losses. The Disco decides to purchase power from the IL aggregator at hours 2, 3, 5, 6, 9, 11, 15, 16, and 19-24. At hours 2, 15, 22, and 24, the Disco decreases purchasing power from the DAEM, which leads to decreasing MCP through purchasing power from ILs. To investigate the effect of ILs aggregators on the results, the problem is solved without considering the IL aggregator, and the results are shown in Fig. 9(a2). In hours 3, 5, 6, and 21 the purchased power from the IL aggregator changes the behavior of the Disco in trading power with the MGs. In this case, purchasing power from MG3 increases at hours 3, 5, and 6, the Disco purchases power from MG1 instead of selling power to it at hour 6, and the selling power by the Disco to MG1 and MG2 decreases at hours 3 and 21, respectively. At hours 9, 11, 16, 19, 20, and 23, without purchasing power from the IL aggregator the DN power losses increase from 0.788 MW, 3.206 MW, 1.812 MW, 2.504 MW, 2.414 MW, and 0.445 MW to 1.735 MW, 3.900 MW, 2.423 MW, 4.473 MW, 4.246 MW, and 2.676 MW, respectively. The purchased power from the IL aggregator is zero at hours 12 and 13, regarding the high price of selling power to consumers, and at hours 4, 7, 8, 13, 14, 17, and 18, when the low offers of RESs lead to purchase power from RESs instead of from the IL aggregator.

As shown in Figs. 5 and 9(a1), the bids/offers of the Disco to the MGs in the local market (LMP) depend on the cost of MGLs interruption, the operation cost of DGs, and the characteristics of power resources, such as ramp rate limitations of each MG and the dynamic behavior of ES of MG1. The LMPs are equal to the bid of MG1's DG at hours 1, 22, and 23, the bid of MG2's DG at hours 8, 9, and 11-21, and the bid of MG3's DG at hours 2-6 and 24. At hours 7 and 10, the LMP is equal to the cost of MGLs interruption. The Disco purchases power from the wholesale market with low MCP to supply the DNL and sell power with higher prices to MG1 and MG2 at hours 1-7 and 22-24. In addition, the Disco sends its bids (14 \$/MWh) to MGs with the aim of purchasing part of its required power from MGs instead of trading power with the DAEM with higher MCP. The Disco utilizes this part of power to supply the DNL and to sell energy to MG1 at hours 13 and 18, and to MG2 at hours 20 and 21. To decrease the ETC and the purchased power from the DAEM with high MCP, the offers sent by the Disco to the MGs are less than its bids to the DAEM. As such, the Disco purchases power as much as possible from the MGs at hours 8-12, 14-17, and 19.

Fig. 8 illustrates that each MG operates its power resources and interacts with the Disco to supply its load consumption. The results show that MGs receive offers/bids of the Disco in



the local market and they decide to purchase/sell power from/to it. When the bid of the Disco to MGs is greater/less than to the bids of each MG's power resources, they decide to sell/purchase power to/from the Disco. Also, if the bid/offer of the Disco is equal to the bid of MG's power resources, they either sell power to the Disco to increase their profit or purchase power from the Disco to overcome the functional limitation of their power resources.

### B.2. Comparison among the four cases

The results obtained from the four mentioned cases are shown in Fig. 9 and Table III. The Disco decides to interact with MGs considering the DN structure (power losses) as well as MG location, and also the type of LMP (uniform or different). According to Figs. 9(a) and 9(b), the sum of the power exchanges between the Disco and MGs during the operation time period for case I are 17.294 MW (MG1), 12.613 MW (MG2), and 69.058 MW (MG3), and for case II are -1.062 MW (MG1), 10.856 MW (MG2), and 43.331 MW (MG3). The power exchange between Disco and MGs are 26.878 MW (MG1), 20.830 MW (MG2), and 71.989 MW (MG3) for case III, and 0.500 MW (MG1), 13.830 MW (MG2), and 41.955 MW (MG3) for case IV. These specific results show that in cases I and III, which model the DN structure, the Disco prefers to purchase power from the MG at the farthest distance (MG3, MG1, and MG2, respectively) instead of selling energy to them, with the purpose of reducing the power losses. Therefore, the MG location in the DN can significantly change the Disco's bids/offers to the MGs and the DAEM, as shown in Table III.

The type of LMP (Disco's bids/offers to MGs) can be different from the uniform price. This has important effects on trading power between the Disco and MGs as shown in Table III (cases I and III) and Figs. 9(a) and 9(c). For instance, the Disco sells power to MG1 due to presenting an offer 14 \$/MWh, 14 \$/MWh, and 11 \$/MWh, based on uniform LMP, at hours 13, 18, and 24, respectively. Different LMPs in case III change the behavior of the Disco, so that it purchases power from MG1 regarding offers of 19.6 \$/MWh, 18.4 \$/MWh, and 12 \$/MWh in these hours, respectively. MG2 prefers to decrease the purchased power from the Disco at hours 1-7 and 20-24 from 24.751 MW (case I) to 15.381 MW (case III) because of the increased Disco's offers at these hours. The obtained revenue of MG3 from selling power to the Disco is significantly reduced in case III by changing the Disco's offers to this MG. Therefore, the type of LMP changes the role as well as the cost/revenue of MGs interacting with the Disco. The different offers proposed by

the Disco to MGs in case III improve the ETC from -11540\$ to -11760\$.

Although MCP at hours 9-20 has the maximum value, i.e. 18.2 \$/MWh in the absence of MGs and DERs, the Disco changes MCP from 18.2 to 15.97 \$/MWh only at hour 15 in case I and at hours 15 and 16 in case II through decreasing the purchased power from the DAEM by interacting with MGs, the IL aggregator, and the RESs. Since the power losses are modeled in case I, the Disco cannot decrease the purchased power from the DAEM to a specified amount for changing MCP to 15.97 \$/MWh at hour 16 (see Table III) in this case. In other hours the Disco cannot decrease MCP to 15.97 \$/MWh, since the whole TNLs (with presenting bids equal or greater than 18.2 \$/MWh) cannot be supplied through the maximum capacity of Gencos at this MCP.

### C. Risk analysis

In this sub-section the effect of the risk aversion parameter  $\beta$  on the decisions of the Disco is investigated. For this purpose, the confidence level  $\alpha$  is considered equal to 0.8, and  $\beta$  changes from 0 to 100. The results, shown in Fig. 10 and Tables IV and V, are described in the following sub-sections.

#### C.1. Results of case I

When the risk aversion parameter increases, the Disco changes the first decision variables including power exchange with the DAEM and MGs to decrease the results of  $(1 - \alpha) \times 100\%$  worst scenarios. Regarding Table IV, the risk-averse Disco ( $\beta = 100$ , typically) decides to change its bids/offers, power trading with the wholesale and local markets. For example, the bids/offer to local markets changes from 11.60\$ and 11 \$/MWh to 11\$ and 12 \$/MWh at hours 7 and 24, respectively. Also, the demand-supply balance of each MG can be influenced by changing the amount of power exchange with the Disco regarding the Disco's risk-averse bids/offers to the MGs shown in Table IV. Therefore, the risk parameter has important impacts on the first-stage decisions of the Disco that change the market outcomes and bids/offers of the Disco in the markets. By increasing  $\beta$ , the ETC of the Disco increases (minus ETC decreases) and the CVaR decreases (minus CVaR increases) with respect to Fig. 10. In other words, the risk-averse decisions of the Disco improve the total cost  $TC_\omega$  in the worst scenarios (number 4, 6, and 11) from -11200\$, -11038\$, and -11043\$ to -11248\$, -11242.5\$, and -11240\$, respectively. Moreover, the difference between the best and the worst scenarios decreases from 1040\$ to 670\$, i.e. 36%, where the total costs in each scenario are closer to the ETC (obtaining the lower total cost in the worst scenario).

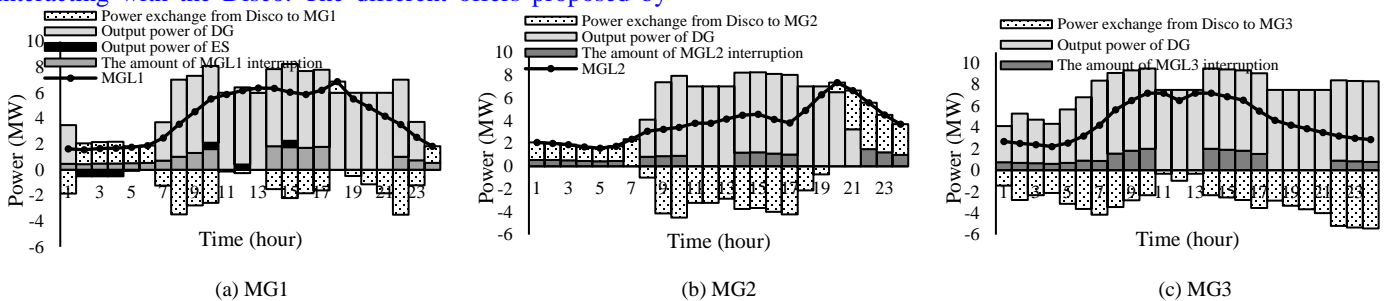

Fig. 8. Share of each MG's power resource to supply each MGL.

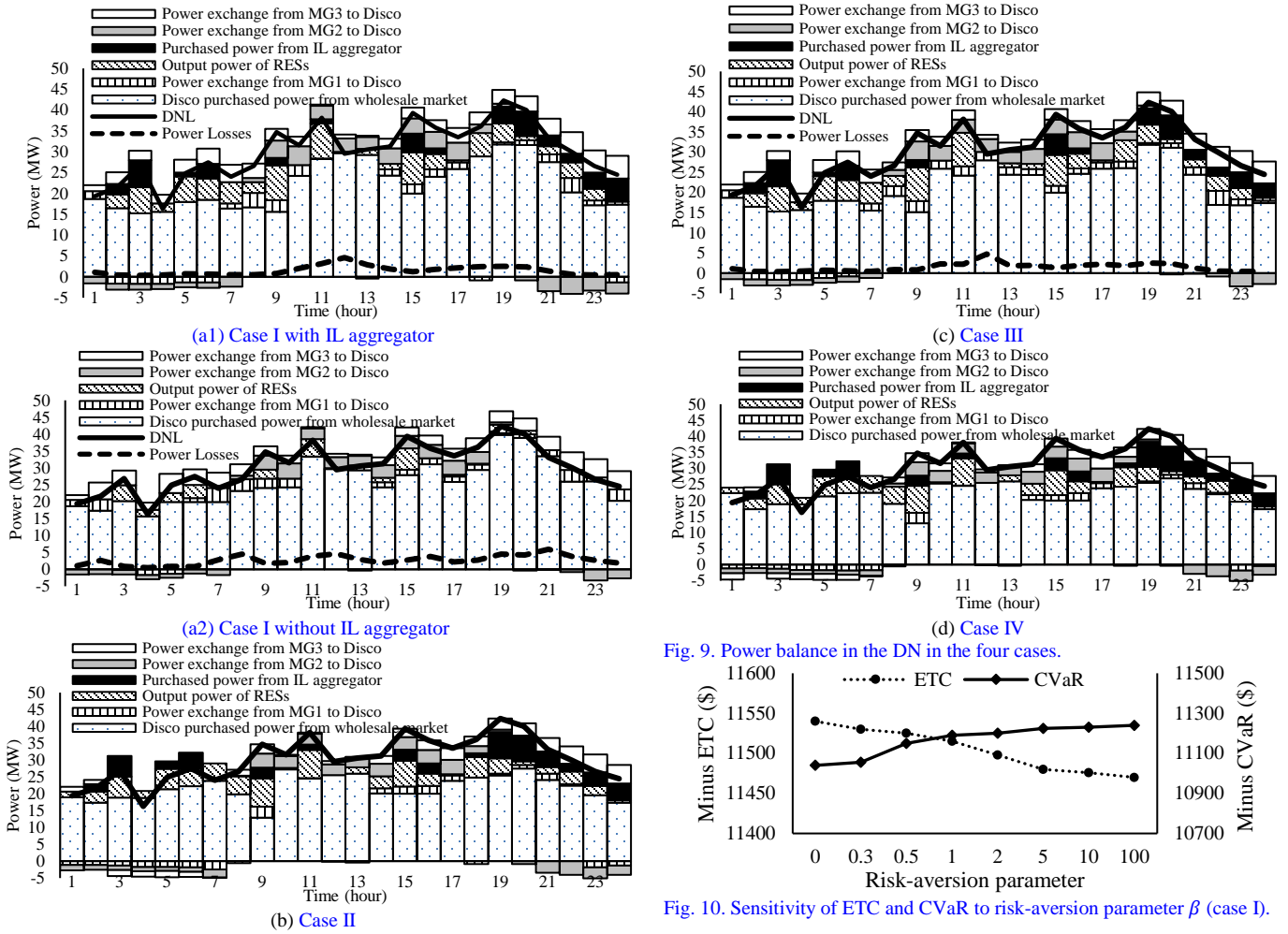

Fig. 9. Power balance in the DN in the four cases.

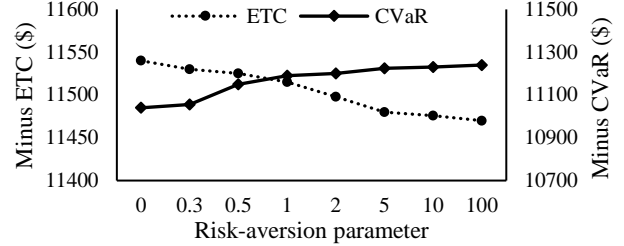

Fig. 10. Sensitivity of ETC and CVaR to risk-aversion parameter  $\beta$  (case I).

TABLE III

IMPACT OF THE DIFFERENT FORMS OF THE MODEL ON THE DISCO'S BID/OFFER PRICES TO THE DAEM AND TO EACH MG (VALUES IN \$/MWH)

Time	Case I		Case II		Case III			Case IV				
	DAEM MCP	Bidding to MGs	DAEM MCP	Bidding to MGs	DAEM MCP	Bidding to MG1	Bidding to MG2	Bidding to MG3	DAEM MCP	Bidding to MG1	Bidding to MG2	Bidding to MG3
1	10.68	12.0	10.68	12.0	10.68	12.0	14.0	11.0	10.68	12.0	14.0	11.0
2	10.25	11.0	10.25	11.0	10.25	12.0	14.0	11.0	10.25	12.0	14.0	11.0
3	10.25	11.0	10.25	11.0	10.25	12.0	14.0	11.0	10.25	12.0	14.0	11.0
4	10.25	11.0	10.25	11.0	10.25	12.0	14.0	11.0	10.25	12.0	14.0	11.0
5	10.25	11.0	10.25	11.0	10.25	12.0	14.0	11.0	10.25	12.0	14.0	11.0
6	10.25	11.0	10.25	10.8	10.25	12.0	14.0	11.0	10.25	12.0	14.0	11.0
7	11.26	11.6	11.26	11.2	11.26	12.0	14.0	11.0	11.26	12.0	14.0	11.0
8	11.96	14.0	11.96	12.8	11.96	12.0	14.0	11.0	11.96	12.0	14.0	11.0
9	18.20	14.0	18.20	15.2	18.20	13.8	14.0	13.8	18.20	13.8	14.0	13.8
10	18.20	17.0	18.20	14.0	18.20	17.0	14.0	17.0	18.20	12.0	14.0	17.0
11	18.20	14.0	18.20	14.0	18.20	19.6	14.0	19.6	18.20	12.0	14.0	11.0
12	18.20	14.0	18.20	14.0	18.20	20.0	14.0	11.0	18.20	13.296	14.0	11.0
13	18.20	14.0	18.20	14.0	18.20	19.6	14.0	19.6	18.20	13.296	14.0	11.0
14	18.20	14.0	18.20	14.0	18.20	12.8	14.0	12.8	18.20	12.8	14.0	12.8
15	15.97	14.0	15.97	14.0	15.97	12.0	14.0	11.0	15.97	12.0	14.0	11.0
16	18.20	14.0	15.97	14.0	18.20	12.0	14.0	11.4	15.97	13.296	14.0	11.4
17	18.20	14.0	18.20	14.0	18.20	12.8	14.0	12.8	18.20	12.8	14.0	12.8
18	18.20	14.0	18.20	14.0	18.20	18.4	14.0	11.0	18.20	18.4	14.0	11.0
19	18.20	14.0	18.20	14.0	18.20	12.0	14.0	11.0	18.20	12.0	14.0	11.0
20	18.20	14.0	18.20	14.0	18.20	12.0	19.6	11.0	18.20	12.0	19.6	11.0
21	15.97	14.0	15.97	14.0	15.97	12.0	14.0	11.0	15.97	12.0	14.0	11.0
22	11.72	12.0	11.72	11.0	11.72	12.0	14.0	11.0	11.72	12.0	14.0	11.0
23	11.09	12.0	11.09	11.0	11.09	12.0	14.0	11.0	11.09	12.0	14.0	11.0
24	10.25	11.0	10.25	11.0	10.25	12.0	14.0	11.0	10.25	12.0	14.0	11.0

C.2. Comparison among all cases

The Disco's risk-averse decisions in the first-stage decisions containing the power purchased from the DA market, as well as the power exchange with MGs for all cases, are given in Table V. As shown in this Table, the decisions of a risk-averse

Disco are different from those of a risk-neutral one. Moreover, these decisions depend on the type of LMPs and DN structure modeling (power losses). When  $\beta$  increases, the power purchased from MGs by the Disco changes as shown in Table V. For example, for case I, the power purchased from MGs

increases at hours 4-6, 13, 23, and 24 and decreases at hours 2, 3, 7 and 12. This behavior of the Disco changes the sum of the power losses during the whole time period of operation. The power losses for the risk-neutral Disco are 35.867 MW and

33.379 MW in cases I and III, respectively and for the risk-averse Disco are 32.589 MW and 30.683 MW, respectively for the same cases. Therefore the risk-averse Disco faces with less power losses in comparison with the risk-neutral one.

TABLE IV  
RISK-NEUTRAL AND RISK-AVERSE DISCO'S DECISIONS IN THE FIRST- AND SECOND-STAGE DECISIONS

Time	Power trading with DAEM(MW)		Power exchange with MG1 (MW)		Power exchange with MG2 (MW)		Power exchange with MG3 (MW)		Power interruption (MW)		RESs output power (MW)		Offer/Bid to MGs (\$/MWh)	
	$\beta = 0$	$\beta = 100$	$\beta = 0$	$\beta = 100$	$\beta = 0$	$\beta = 100$	$\beta = 0$	$\beta = 100$	$\beta = 0$	$\beta = 100$	$\beta = 0$	$\beta = 100$	$\beta = 0$	$\beta = 100$
1	18.711	18.711	1.843	1.843	-1.526	-1.526	1.433	1.433	0.000	0.000	0.000	0.000	12.0	12.0
2	16.470	17.057	-1.608	-1.608	-1.467	-1.467	2.776	2.721	2.538	2.065	3.300	3.300	11.0	11.0
3	15.287	15.971	-1.679	-1.679	-1.387	-1.387	2.322	2.108	6.491	6.064	6.200	6.200	11.0	11.0
4	15.631	14.170	-1.700	-1.70	-1.241	-1.241	2.115	2.908	0.000	0.000	1.970	2.559	11.0	11.0
5	17.992	18.575	-1.329	-1.329	-1.161	-1.161	3.121	3.513	0.896	0.052	6.100	6.100	11.0	11.0
6	18.488	19.342	-1.335	-1.335	-1.292	-1.292	3.602	4.461	3.523	1.980	5.130	5.130	11.0	11.0
7	16.409	17.155	1.239	0.520	-2.370	-2.370	4.151	3.290	0.000	0.000	5.087	6.008	11.6	11.0
8	16.691	17.283	3.479	3.479	0.994	0.994	3.428	3.428	0.000	0.000	2.555	2.017	14.0	14.0
9	15.636	14.802	2.777	2.777	4.135	4.135	2.793	2.793	1.833	2.561	8.315	8.315	14.0	14.0
10	24.240	24.240	2.567	2.567	4.503	4.503	2.309	2.309	0.000	0.000	0.000	0.000	17.0	17.0
11	28.304	25.949	0.120	0.120	3.220	3.220	0.310	0.310	1.034	2.755	8.355	8.355	14.0	14.0
12	29.713	26.399	0.245	-0.180	3.220	3.220	0.980	0.980	0.000	0.000	0.000	1.465	14.0	14.0
13	29.288	28.387	-0.380	0.045	2.850	2.850	0.310	0.310	0.000	0.000	1.436	1.696	14.0	14.0
14	24.304	27.000	1.499	1.499	3.730	3.730	2.309	2.309	0.000	0.000	1.287	0.000	14.0	14.0
15	19.987	19.987	2.205	2.205	3.671	3.671	2.540	2.540	4.515	4.515	7.680	7.680	14.0	14.0
16	23.987	23.987	1.825	1.825	3.985	3.985	2.778	2.778	1.400	1.400	3.630	3.630	14.0	14.0
17	25.876	27.734	1.598	1.598	4.226	4.226	3.515	3.515	0.000	0.000	0.493	0.000	14.0	14.0
18	28.874	28.874	-0.870	-0.870	2.110	2.110	2.840	2.840	0.000	0.000	5.629	5.629	14.0	14.0
19	31.801	33.079	0.480	0.480	0.720	0.720	3.290	3.290	4.000	3.000	4.525	4.525	14.0	14.0
20	31.656	31.656	1.120	1.120	-0.850	-0.850	3.630	3.630	5.864	5.864	1.040	1.040	14.0	14.0
21	27.552	27.168	1.820	1.820	-3.390	-3.390	3.980	3.980	2.603	2.927	1.980	1.980	14.0	14.0
22	20.253	20.435	3.487	3.487	-4.081	-4.081	5.190	5.190	2.051	1.888	3.725	3.725	12.0	12.0
23	17.160	18.611	1.197	3.762	-3.285	-3.285	5.334	5.334	3.867	0.000	2.775	2.775	12.0	12.0
24	17.332	17.332	-1.306	1.259	-2.701	-2.701	5.435	5.435	5.502	2.875	0.755	0.755	11.0	12.0

TABLE V  
COMPARISON BETWEEN THE FOUR CASES BASED ON THE RISK-AVERSE DISCO'S FIRST-STAGE DECISIONS (FROM THE DISCO'S POINT OF VIEW)

Time	$\beta = 0$								$\beta = 100$							
	Power trading with the DAEM (MW)				Sum of power exchanges with MGs (MW)				Power trading with the DAEM (MW)				Sum of power exchanges with MGs (MW)			
	Case I	Case II	Case III	Case IV	Case I	Case II	Case III	Case IV	Case I	Case II	Case III	Case IV	Case I	Case II	Case III	Case IV
1	18.711	18.983	18.711	22.358	1.750	-1.250	1.750	-4.625	18.711	18.983	18.711	22.358	1.750	-1.250	1.750	-4.625
2	16.470	17.332	16.470	17.332	-0.299	-1.265	-0.299	-1.265	17.057	17.332	17.057	17.332	-0.354	0.935	-0.354	0.936
3	15.287	18.848	15.287	18.848	-0.744	-4.371	-0.744	-4.371	15.971	19.379	16.121	21.334	-0.958	-2.837	-1.104	-4.792
4	15.631	18.814	15.631	18.814	-0.826	-4.544	-0.826	-4.544	14.170	16.759	14.170	17.180	-0.033	-4.123	-0.033	-4.544
5	17.992	21.337	17.962	21.337	0.631	-4.745	0.657	-4.745	18.575	21.337	17.956	21.337	1.023	-4.745	0.664	-4.745
6	18.488	22.279	17.949	22.279	0.975	-4.695	1.437	-4.695	19.342	22.279	18.019	21.857	1.834	-4.695	2.944	-4.274
7	16.409	23.814	15.505	22.455	3.020	-4.935	3.858	-3.576	17.155	21.614	13.681	20.255	1.440	-4.935	4.680	-3.576
8	16.691	19.827	19.162	18.993	7.901	1.470	5.804	2.304	17.283	23.077	19.787	18.993	7.901	-1.780	5.804	2.304
9	15.636	12.935	15.122	12.935	9.705	10.205	10.205	10.205	14.802	15.366	14.293	11.616	9.705	6.455	10.205	10.205
10	24.240	27.211	25.858	25.295	9.379	4.350	7.956	6.266	24.240	21.115	24.252	18.616	9.379	3.850	7.956	6.349
11	28.304	24.541	24.160	24.541	3.650	3.650	7.854	3.650	25.949	24.541	20.704	24.624	3.650	3.650	7.779	3.567
12	29.713	25.510	27.940	25.510	4.445	4.020	6.312	4.020	26.399	23.537	23.385	23.537	4.020	4.020	6.312	4.020
13	29.288	26.004	24.400	26.004	2.780	2.780	7.054	2.780	28.387	23.932	23.274	23.932	3.205	2.780	7.129	2.780
14	24.304	20.137	24.304	20.137	7.538	7.538	7.538	7.538	27.000	20.137	27.665	20.137	7.538	7.538	7.038	7.538
15	19.987	19.987	19.987	19.987	8.416	8.340	7.861	7.915	19.987	19.987	19.987	19.987	8.416	8.416	8.269	8.416
16	23.987	19.987	24.622	19.987	8.588	9.088	8.088	9.088	23.987	19.987	24.622	19.987	8.588	9.088	8.088	9.088
17	25.876	23.812	25.876	23.812	9.339	9.339	9.339	9.339	27.734	22.542	28.387	22.542	9.339	9.339	8.839	9.339
18	28.874	24.816	26.047	24.316	4.080	4.080	6.572	4.580	28.874	24.816	25.660	24.816	4.080	4.080	6.572	4.080
19	31.801	25.480	31.801	25.480	4.490	4.490	4.490	4.490	33.079	25.055	30.876	25.480	4.490	4.915	6.591	4.490
20	31.656	27.443	31.120	26.943	3.900	3.900	4.400	4.400	31.656	27.443	31.120	26.943	3.900	3.900	4.400	4.400
21	27.552	24.128	24.416	23.628	2.410	2.410	5.660	2.910	27.168	24.128	23.741	23.628	2.410	2.410	5.660	2.910
22	20.253	22.417	16.884	21.917	4.596	1.596	7.846	2.096	20.435	22.417	17.169	21.917	4.596	1.596	7.846	2.096
23	17.160	19.595	16.817	19.595	3.246	0.246	3.550	0.246	18.611	21.040	18.611	21.040	5.811	0.246	5.811	0.246
24	17.332	17.332	17.332	17.332	1.428	1.428	3.335	2.279	17.332	17.332	17.332	17.332	3.993	2.279	3.993	2.279

TABLE VI  
Computational Aspects for Different Numbers of MGs

# MGs	Solution Time (s)	# Single Equations	# Single Variables	# Discrete Variables
3	469.24	1,835,357	976,743	13,344
5	481.54	1,838,289	978,379	14,016
7	501.89	1,841,221	980,015	14,688
10	536.35	1,845,619	982,469	15,696
15	575.14	1,852,949	986,559	17,376
18	597.78	1,857,347	989,013	18,384

### D.Sensitivity of the model to the number of MGs

The proposed model is implemented in GAMS environment and solved using the CPLEX12 solver on a core i7, 3.3GHz system with 6GB RAM. To discuss the tractability of the proposed model, it has been applied to the case study with

different number of MGs changing from 3 MGs to 18 MGs. The results consist of the number of equations and variables as well as the simulation time, and are presented in Table VI. As shown in this Table, although with increasing the number of MGs the number of equations and variables increases, the solution time changes in an acceptable way for such problem. This example validates the effectiveness of the proposed MILP problem when the model's scale increases.

### VI. CONCLUSION

In this paper, a decision-making framework for a Disco has been presented, in which the Disco interacts with both wholesale and local markets. To model such framework, a risk-based two-stage stochastic bi-level optimization model

has been proposed, in which the upper level decision maker is the Disco and the lower levels decision makers are the ISO and the MGs operators. The KKT conditions and the duality theory have been used to transform the proposed non-linear bi-level model into a MILP problem. The results show that the risk-based decisions of the Disco in both wholesale and local markets decrease CVaR. In particular, the risk-averse Disco changes its first-stage decisions consisting of bids/offers to both markets to decrease CVaR. Therefore, the Disco can impact on the market outcomes and can increase competitiveness in both markets.

#### APPENDIX A: KKT CONDITIONS

The constraints associated with the KKT conditions for each LL problem are formulated as follows:

- **Wholesale DAEM: Stationarity constraints:**

$$-\lambda_{n,t}^{TN\_Dis} - \underline{\mu}_{g,t}^{3\_TN} + \bar{\mu}_{g,t}^{3\_TN} - \mu_{g,t}^{4\_TN} \Big|_{t>1} + \mu_{g,t+1}^{4\_TN} - \mu_{g,t}^{5\_TN} \Big|_{t=1} + \mu_{g,t}^{6\_TN} \Big|_{t>1} - \mu_{g,t+1}^{6\_TN} + \mu_{g,t}^{7\_TN} \Big|_{t=1} + \lambda_{g,t}^{1\_TN} = 0 \quad (44)$$

$$\lambda_{n,t}^{TN\_Dis} \Big|_{n \neq m} - \underline{\mu}_{d,t}^{2\_TN} + \bar{\mu}_{d,t}^{2\_TN} + \lambda_{d,t}^{2\_TN} = 0 \quad (45)$$

$$C_{b,g,t}^{TN} - \underline{\mu}_{b,g,t}^{8\_TN} + \bar{\mu}_{b,g,t}^{8\_TN} - \lambda_{g,t}^{1\_TN} = 0 \quad (46)$$

$$-C_{b,d,t}^{TN} - \underline{\mu}_{b,d,t}^{9\_TN} + \bar{\mu}_{b,d,t}^{9\_TN} - \lambda_{d,t}^{2\_TN} = 0 \quad (47)$$

$$-C_t^{TN\_Dis} + \lambda_{n,t}^{TN\_Dis} \Big|_{n=m} - \underline{\mu}_t^{1\_TN} + \bar{\mu}_t^{1\_TN} = 0 \quad (48)$$

$$-\sum_{r \in \Lambda^{TN}} B_{n-r} (\lambda_{n,t}^{TN\_Dis} - \lambda_{r,t}^{TN\_Dis}) + \sum_{r \in \Lambda^{TN}} B_{n-r} (\bar{\mu}_{n,r,t}^{10\_TN} - \bar{\mu}_{r,n,t}^{10\_TN}) + \sum_{r \in \Lambda^{TN}} B_{n-r} (\underline{\mu}_{r,n,t}^{10\_TN} - \underline{\mu}_{n,r,t}^{10\_TN}) - \underline{\mu}_{n,t}^{11\_TN} + \bar{\mu}_{n,t}^{11\_TN} + \lambda_{n,t}^{3\_TN} \Big|_{n=stack} = 0 \quad (49)$$

- **Primal, dual, and complementary constraints:**

$$0 \leq \underline{\mu}_t^{1\_TN} \perp (P_t^{TN\_Dis} - \bar{P}_t^{TN\_Dis}) \geq 0, 0 \leq \bar{\mu}_t^{1\_TN} \perp (\bar{P}_t^{TN\_Dis} - P_t^{TN\_Dis}) \geq 0 \quad (50)$$

$$0 \leq \underline{\mu}_{d,t}^{2\_TN} \perp (L_{d,t}^{TN}) \geq 0, 0 \leq \bar{\mu}_{d,t}^{2\_TN} \perp (\bar{L}_{d,t}^{TN} - L_{d,t}^{TN}) \geq 0 \quad (51)$$

$$0 \leq \underline{\mu}_{g,t}^{3\_TN} \perp (P_{g,t}^{TN}) \geq 0, 0 \leq \bar{\mu}_{g,t}^{3\_TN} \perp (\bar{P}_g - P_{g,t}^{TN}) \geq 0 \quad (52)$$

$$0 \leq \underline{\mu}_{g,t}^{4\_TN} \perp (RD_g - P_{g,t-1}^{TN} + P_{g,t}^{TN}) \geq 0, 0 \leq \mu_{g,t}^{5\_TN} \perp (RD_g - P_{g,imi}^{TN} + P_{g,t}^{TN}) \geq 0 \quad (53)$$

$$0 \leq \underline{\mu}_{g,t}^{6\_TN} \perp (RU_g - P_{g,t}^{TN} + P_{g,t-1}^{TN}) \geq 0, 0 \leq \mu_{g,t}^{7\_TN} \perp (RU_g - P_{g,t}^{TN} + P_{g,imi}^{TN}) \geq 0 \quad (54)$$

$$0 \leq \underline{\mu}_{b,g,t}^{8\_TN} \perp (\rho_{b,g,t}^{8\_TN} - 0) \geq 0, 0 \leq \bar{\mu}_{b,g,t}^{8\_TN} \perp (\bar{\rho}_{b,g,t}^{8\_TN} - \rho_{b,g,t}^{8\_TN}) \geq 0 \quad (55)$$

$$0 \leq \underline{\mu}_{b,d,t}^{9\_TN} \perp (l_{b,d,t}^{9\_TN} - 0) \geq 0, 0 \leq \bar{\mu}_{b,d,t}^{9\_TN} \perp (\bar{l}_{b,d,t}^{9\_TN} - l_{b,d,t}^{9\_TN}) \geq 0 \quad (56)$$

$$0 \leq \underline{\mu}_{n,r,t}^{10\_TN} \perp (B_{n-r} (\theta_{n,t} - \theta_{r,t}) + \bar{f}_{n-r}^{10\_TN}) \geq 0, 0 \leq \bar{\mu}_{n,r,t}^{10\_TN} \perp (\bar{f}_{n-r}^{10\_TN} - B_{n-r} (\theta_{n,t} - \theta_{r,t})) \geq 0 \quad (57)$$

$$0 \leq \underline{\mu}_{n,t}^{11\_TN} \perp (\theta_{n,t} - (\pi/2)) \geq 0, 0 \leq \bar{\mu}_{n,t}^{11\_TN} \perp (\pi/2 - \theta_{n,t}) \geq 0 \quad (58)$$

$$\lambda_{n,t}^{TN\_Dis}, \lambda_{g,t}^{1\_TN}, \lambda_{d,t}^{2\_TN}, \lambda_{g,t}^{3\_TN}, \text{Unrestricted} \quad (59)$$

where each equation is linearized as (60), in which  $M_1^{TN}$  and  $M_2^{TN}$  are large enough values and  $U^{TN}$  is a binary variable.

$$0 \leq a \perp b \geq 0 \Rightarrow a \geq 0, b \geq 0, a \leq M_1^{TN} U^{TN}, b \leq M_2^{TN} (1 - U^{TN}) \quad (60)$$

- **MGs problem: Stationarity constraints:**

$$C_j^{DG} - \lambda_{j,t}^{Dis\_MG} - \underline{\mu}_{j,t}^{2\_MG} + \bar{\mu}_{j,t}^{2\_MG} + \mu_{j,t}^{3\_MG} \Big|_{t>1} - \mu_{j,t+1}^{3\_MG} + \mu_{j,t}^{4\_MG} \Big|_{t=1} - \mu_{j,t}^{5\_MG} \Big|_{t>1} + \mu_{j,t+1}^{5\_MG} - \mu_{j,t}^{6\_MG} \Big|_{t=1} = 0 \quad (61)$$

$$-C_t^{Dis\_MG} + \lambda_{j,t}^{Dis\_MG} - \underline{\mu}_{j,t}^{1\_MG} + \bar{\mu}_{j,t}^{1\_MG} = 0 \quad (62)$$

$$C_{j,t}^{IL\_MG} - \lambda_{j,t}^{Dis\_MG} - \underline{\mu}_{j,t}^{7\_MG} + \bar{\mu}_{j,t}^{7\_MG} = 0 \quad (63)$$

$$\lambda_{j,t}^{Dis\_MG} - \underline{\mu}_{j,t}^{8\_MG} + \bar{\mu}_{j,t}^{8\_MG} + \eta_j^{ch} \lambda_{j,t}^{1\_MG} \Big|_{t>1} + \eta_j^{ch} \lambda_{j,t}^{2\_MG} \Big|_{t=1} = 0 \quad (64)$$

$$-\lambda_{j,t}^{Dis\_MG} - \underline{\mu}_{j,t}^{9\_MG} + \bar{\mu}_{j,t}^{9\_MG} - \eta_j^{dch} \lambda_{j,t}^{1\_MG} \Big|_{t>1} - \eta_j^{dch} \lambda_{j,t}^{2\_MG} \Big|_{t=1} = 0 \quad (65)$$

$$-\underline{\mu}_{j,t}^{10\_MG} + \bar{\mu}_{j,t}^{10\_MG} - \lambda_{j,t}^{1\_MG} \Big|_{t>1} + \lambda_{j,t+1}^{1\_MG} - \lambda_{j,t}^{2\_MG} \Big|_{t=1} = 0 \quad (66)$$

**Primal, dual, and complementary constraints:**

$$0 \leq \underline{\mu}_t^{1\_MG} \perp (\bar{P}_t^{Dis\_MG} - P_t^{Dis\_MG}) \geq 0, 0 \leq \bar{\mu}_t^{1\_MG} \perp (P_t^{Dis\_MG} - \bar{P}_t^{Dis\_MG}) \geq 0 \quad (67)$$

$$0 \leq \underline{\mu}_{j,t}^{2\_MG} \perp (\bar{P}_j^{DG} - P_{j,t}^{DG}) \geq 0, 0 \leq \mu_{j,t}^{2\_MG} \perp (P_{j,t}^{DG}) \geq 0 \quad (68)$$

$$0 \leq \underline{\mu}_{j,t}^{3\_MG} \perp (RU_j^{DG} - P_{j,t}^{DG} + P_{j,t-1}^{DG}) \geq 0, 0 \leq \mu_{j,t}^{4\_MG} \perp (RU_j^{DG} - P_{j,t}^{DG} + P_{j,imi}^{DG}) \geq 0 \quad (69)$$

$$0 \leq \underline{\mu}_{j,t}^{5\_MG} \perp (RD_j^{DG} - P_{j,t-1}^{DG} + P_{j,t}^{DG}) \geq 0, 0 \leq \mu_{j,t}^{6\_MG} \perp (RD_j^{DG} - P_{j,imi}^{DG} + P_{j,t}^{DG}) \geq 0 \quad (70)$$

$$0 \leq \bar{\mu}_{j,t}^{7\_MG} \perp (\gamma_j^{MG} P_{j,t}^{MGL} - P_{j,t}^{IL\_MG}) \geq 0, 0 \leq \underline{\mu}_{j,t}^{7\_MG} \perp (P_{j,t}^{IL\_MG}) \geq 0 \quad (71)$$

$$0 \leq \bar{\mu}_{j,t}^{8\_MG} \perp (\bar{P}_j^{ESch} - P_{j,t}^{ESch}) \geq 0, 0 \leq \underline{\mu}_{j,t}^{8\_MG} \perp (P_{j,t}^{ESch}) \geq 0 \quad (72)$$

$$0 \leq \bar{\mu}_{j,t}^{9\_MG} \perp (\bar{P}_j^{ESdch} - P_{j,t}^{ESdch}) \geq 0, 0 \leq \underline{\mu}_{j,t}^{9\_MG} \perp (P_{j,t}^{ESdch}) \geq 0 \quad (73)$$

$$0 \leq \bar{\mu}_{j,t}^{10\_MG} \perp (\bar{E}_j^{ES} - E_{j,t}^{ES}) \geq 0, 0 \leq \underline{\mu}_{j,t}^{10\_MG} \perp (E_{j,t}^{ES} - \bar{E}_j^{ES}) \geq 0 \quad (74)$$

$$\lambda_{j,t}^{Dis\_MG}, \lambda_{j,t}^{1\_MG}, \lambda_{j,t}^{2\_MG}, \text{Unrestricted} \quad (75)$$

where each equation is linearized as Eq. (76), in which  $M_1^{MG}$  and  $M_2^{MG}$  are large enough values and  $U^{MG}$  is a binary variable.

$$0 \leq a \perp b \geq 0 \Rightarrow a \geq 0, b \geq 0, a \leq M_1^{MG} U^{MG}, b \leq M_2^{MG} (1 - U^{MG}) \quad (76)$$

#### APPENDIX B: LINEARIZATION

In this section, the dual theory is used to linearize the non-linear terms including the cost of trading power with DAEM ( $\lambda_{m,t}^{TN\_Dis} P_t^{TN\_Dis}$ ) as well as the cost/revenue of exchanging power with MGs ( $\lambda_{j,t}^{Dis\_MG} P_{j,t}^{Dis\_MG}$ ), described as follows:

- **Cost of trading power with the DAEM:** According to the strong dual theory approach, equation (77) is obtained.

$$\sum_{t=1}^T d_t \left[ \sum_{g=1}^G \sum_{b=1}^B (C_{b,g,t}^{TN} \rho_{b,g,t}^{TN}) - \sum_{d=1}^D \sum_{b=1}^B (C_{b,d,t}^{TN} l_{b,d,t}^{TN}) \right] - \sum_{t=1}^T d_t \left[ C_t^{TN\_Dis} P_t^{TN\_Dis} \right] = \sum_{t=1}^T d_t \left[ \begin{aligned} & \underline{P}_t^{TN\_Dis} \underline{\mu}_t^{1\_TN} - \bar{P}_t^{TN\_Dis} \bar{\mu}_t^{1\_TN} - \sum_{d=1}^D \bar{L}_{d,t}^{TN} \bar{\mu}_{d,t}^{2\_TN} + \sum_{g=1}^G (P_g \underline{\mu}_{g,t}^{3\_TN} - \bar{P}_g \bar{\mu}_{g,t}^{3\_TN}) \\ & - \sum_{g=1}^G RD_g \underline{\mu}_{g,t}^{4\_TN} \Big|_{t>1} - \sum_{g=1}^G (RD_g - P_{g,imi}^{TN}) \underline{\mu}_{g,t}^{5\_TN} \Big|_{t=1} - \sum_{g=1}^G RU_g \underline{\mu}_{g,t}^{6\_TN} \Big|_{t>1} \\ & - \sum_{g=1}^G (RU_g + P_{g,imi}^{TN}) \underline{\mu}_{g,t}^{7\_TN} \Big|_{t=1} - \sum_{g=1}^G \sum_{b=1}^B \bar{P}_{b,g,t}^{TN} \bar{\mu}_{b,g,t}^{8\_TN} - \sum_{d=1}^D \sum_{b=1}^B \bar{f}_{b,d,t}^{TN} \bar{\mu}_{b,d,t}^{9\_TN} \\ & - \sum_{n=1}^N \sum_{r=1}^R (\bar{f}_{n-r,t}^{10\_TN} \underline{\mu}_{n,r,t}^{10\_TN} + \bar{f}_{n-r,t}^{10\_TN} \bar{\mu}_{n,r,t}^{10\_TN}) - \sum_{n=1}^N (\underline{\mu}_{n,t}^{11\_TN} + \bar{\mu}_{n,t}^{11\_TN}) \frac{\pi}{2} \end{aligned} \right] \quad (77)$$

For simplification, the right-hand side of this equation is replaced with  $H^{TN}$  and the equation is rewritten as (78).

$$\sum_{t=1}^T d_t \left[ C_t^{TN\_Dis} P_t^{TN\_Dis} \right] = \sum_{t=1}^T d_t \left[ \sum_{g=1}^G \sum_{b=1}^B (C_{b,g,t}^{TN} \rho_{b,g,t}^{TN}) - \sum_{d=1}^D \sum_{b=1}^B (C_{b,d,t}^{TN} l_{b,d,t}^{TN}) \right] - H^{TN} \quad (78)$$

The left-hand side of equation (78) is transformed to the non-linear term of (2) as follows. By multiplying equation (48) with its variable, equation (79) is obtained. Using (50), the equations (80) and (81) are obtained, regarding which (79) is transformed into (82). Using (82), equation (78) is transformed into (83).

$$C_t^{TN\_Dis} P_t^{TN\_Dis} = \lambda_{n,t}^{TN\_Dis} P_t^{TN\_Dis} - \underline{\mu}_t^{1\_TN} P_t^{TN\_Dis} + \bar{\mu}_t^{1\_TN} P_t^{TN\_Dis} \quad (79)$$

$$\bar{\mu}_t^{1\_TN} (\bar{P}_t^{TN\_Dis} - P_t^{TN\_Dis}) = 0 \Rightarrow \bar{\mu}_t^{1\_TN} \bar{P}_t^{TN\_Dis} = \bar{\mu}_t^{1\_TN} P_t^{TN\_Dis} \quad (80)$$

$$\underline{\mu}_t^{1\_TN} (P_t^{TN\_Dis} - \bar{P}_t^{TN\_Dis}) = 0 \Rightarrow \underline{\mu}_t^{1\_TN} P_t^{TN\_Dis} = \underline{\mu}_t^{1\_TN} \bar{P}_t^{TN\_Dis} \quad (81)$$

$$\lambda_{n,t}^{TN\_Dis} P_t^{TN\_Dis} = C_t^{TN\_Dis} P_t^{TN\_Dis} + \underline{\mu}_t^{1\_TN} \bar{P}_t^{TN\_Dis} - \bar{\mu}_t^{1\_TN} \bar{P}_t^{TN\_Dis} \quad (82)$$

$$\sum_{t=1}^T d_t \left[ \lambda_{m,t}^{TN\_Dis} P_{j,t}^{TN\_Dis} \right] = \sum_{t=1}^T d_t \left[ \sum_{g=1}^G \sum_{b=1}^B (C_{b,g,t}^{TN} P_{b,g,t}^{TN}) - \sum_{d=1}^D \sum_{b=1}^B (C_{b,d,t}^{TN} P_{b,d,t}^{TN}) \right] - H^{TN} + \underline{\mu}_{j,t}^{1-TN} \underline{P}_{j,t}^{TN\_Dis} - \bar{\mu}_{j,t}^{1-TN} \bar{P}_{j,t}^{TN\_Dis} \quad (83)$$

- **Cost/revenue of exchanging power with MGs:** The equation (84) is obtained using the strong duality theory.

$$\sum_{t=1}^T C_{j,t}^{Dis\_MG} P_{j,t}^{Dis\_MG} = \sum_{t=1}^T \left[ C_{j,t}^{DG} P_{j,t}^{DG} + C_{j,t}^{IL\_MG} P_{j,t}^{IL\_MG} \right] - \left[ \underline{\mu}_{j,t}^{1-MG} \underline{P}_{j,t}^{Dis\_MG} - \bar{\mu}_{j,t}^{1-MG} \bar{P}_{j,t}^{Dis\_MG} - \underline{\mu}_{j,t}^{2-MG} \bar{P}_j^{DG} - \underline{\mu}_{j,t}^{3-MG} R U_j^{DG} \right] - \sum_{t=1}^T \left[ -\underline{\mu}_{j,t}^{4-MG} \left( R U_j^{DG} + P_{j,ini}^{DG} \right) - \underline{\mu}_{j,t}^{6-MG} \left( R D_j^{DG} - P_{j,ini}^{DG} \right) - \underline{\mu}_{j,t}^{5-MG} R D_j^{DG} - \underline{\mu}_{j,t}^{7-MG} \gamma_j^{MG} P_{j,t}^{MGL} - \left( \underline{\mu}_{j,t}^{8-MG} + \underline{\mu}_{j,t}^{9-MG} \right) \bar{P}_j^{ES} + \underline{\mu}_{j,t}^{10-MG} \underline{E}_j^{ES} - \bar{\mu}_{j,t}^{10-MG} \bar{E}_j^{ES} + \lambda_{j,t}^{2-MG} E_{j,ini}^{ES} + \lambda_{j,t}^{Dis\_MG} P_{j,t}^{MGL} \right] \quad (84)$$

For simplification, the second term of the right-hand side of (84) is replaced with  $H^{MG}$ , regarding which (85) is obtained.

$$\sum_{t=1}^T C_{j,t}^{Dis\_MG} P_{j,t}^{Dis\_MG} = \sum_{t=1}^T \left[ C_{j,t}^{DG} P_{j,t}^{DG} + C_{j,t}^{IL\_MG} P_{j,t}^{IL\_MG} \right] - H^{MG} \quad (85)$$

The left-hand side of equation (85) is transformed into the non-linear term of (2) as follows. By multiplying equation (62) with its variable, equation (86) is obtained. Using (67), equations (87) and (88) are obtained, regarding which (86) is transformed into (89). Using (89), equation (85) is transformed into (90).

$$C_{j,t}^{Dis\_MG} P_{j,t}^{Dis\_MG} = \lambda_{j,t}^{Dis\_MG} P_{j,t}^{Dis\_MG} - P_{j,t}^{Dis\_MG} \left( \underline{\mu}_{j,t}^{1-MG} + \bar{\mu}_{j,t}^{1-MG} \right) \quad (86)$$

$$\bar{\mu}_{j,t}^{1-MG} \left( \bar{P}_j^{Dis\_MG} - P_j^{Dis\_MG} \right) = 0 \Rightarrow \bar{\mu}_{j,t}^{1-MG} \bar{P}_j^{Dis\_MG} = \bar{\mu}_{j,t}^{1-MG} P_j^{Dis\_MG} \quad (87)$$

$$\underline{\mu}_{j,t}^{1-MG} \left( P_j^{Dis\_MG} - \underline{P}_j^{Dis\_MG} \right) = 0 \Rightarrow \underline{\mu}_{j,t}^{1-MG} \underline{P}_j^{Dis\_MG} = \underline{\mu}_{j,t}^{1-MG} P_j^{Dis\_MG} \quad (88)$$

$$\lambda_{j,t}^{Dis\_MG} P_{j,t}^{Dis\_MG} = C_{j,t}^{Dis\_MG} P_{j,t}^{Dis\_MG} + \underline{\mu}_{j,t}^{1-MG} \underline{P}_j^{Dis\_MG} - \bar{\mu}_{j,t}^{1-MG} \bar{P}_j^{Dis\_MG} \quad (89)$$

$$\sum_{t=1}^T \lambda_{j,t}^{Dis\_MG} P_{j,t}^{Dis\_MG} = \sum_{t=1}^T \left[ C_{j,t}^{DG} P_{j,t}^{DG} + C_{j,t}^{IL\_MG} P_{j,t}^{IL\_MG} \right] - H^{MG} \quad (90)$$

$$+ \underline{\mu}_{j,t}^{1-MG} \underline{P}_j^{Dis\_MG} - \bar{\mu}_{j,t}^{1-MG} \bar{P}_j^{Dis\_MG}$$

## REFERENCES

- [1] New York Public Service Commission, "Reforming the Energy Vision: NYS Department of Public Service Staff Report and Proposal," Case 14-M-0101, April 24, 2014.
- [2] A. M. Jadhav, N. R. Patne, and J. M. Guerrero, "A Novel Approach to Neighborhood Fair Energy Trading in a Distribution Network of Multiple Microgrid Clusters," *IEEE Transactions on Industrial Electronics*, vol. 66, pp. 1520-1531, 2019.
- [3] P. MacDougall, B. Ran, G. B. Huitema, and G. Deconinck, "Multi-goal optimization of competing aggregators using a web-of-cells approach," in *2017 IEEE PES Innovative Smart Grid Technologies Conference Europe (ISGT-Europe)*, 2017, pp. 1-6.
- [4] A. van der Mei and J.-P. Doornik, "Grid value and defection: a demand perspective," *CIREN-Open Access Proceedings Journal*, vol. 2017, pp. 2308-2311, 2017.
- [5] M. Yazdani-Damavandi, N. Neyestani, G. Chicco, M. Shafie-Khah, and J. P. Catalao, "Aggregation of Distributed Energy Resources Under the Concept of Multienergy Players in Local Energy Systems," *IEEE Transactions on Sustainable Energy*, vol. 8, pp. 1679-1693, 2017.
- [6] Y. Wu, X. Tan, L. Qian, D. H. Tsang, W.-Z. Song, and L. Yu, "Optimal Pricing and Energy Scheduling for Hybrid Energy Trading Market in Future Smart Grid," *IEEE Trans. Industrial Informatics*, vol. 11, pp. 1585-1596, 2015.
- [7] A. A. Algarni and K. Bhattacharya, "A generic operations framework for discos in retail electricity markets," *IEEE Transactions on Power Systems*, vol. 24, pp. 356-367, 2009.

- [8] A. Safdarian, M. Fotuhi-Firuzabad, and M. Lehtonen, "A stochastic framework for short-term operation of a distribution company," *IEEE Transactions on Power Systems*, vol. 28, pp. 4712-4721, 2013.
- [9] M. Doostizadeh and H. Ghasemi, "Day-ahead scheduling of an active distribution network considering energy and reserve markets," *International Transactions on Electrical Energy Systems*, vol. 23, pp. 930-945, 2013.
- [10] S. Wang, K. Wang, F. Teng, G. Strbac, and L. Wu, "An affine arithmetic-based multi-objective optimization method for energy storage systems operating in active distribution networks with uncertainties," *Applied Energy*, vol. 223, pp. 215-228, 2018.
- [11] C. Zhang, Q. Wang, J. Wang, P. Pinson, J. M. Morales, and J. Østergaard, "Real-time procurement strategies of a proactive distribution company with aggregator-based demand response," *IEEE Transactions on Smart Grid*, vol. 9, pp. 766-776, 2018.
- [12] C. Zhang, Q. Wang, J. Wang, P. Pinson, and J. Østergaard, "Real-Time Trading Strategies of Proactive DISCO with Heterogeneous DG Owners," *IEEE Transactions on Smart Grid*, vol. 9, pp. 1688-1697, 2017.
- [13] S. Bahramara, M. P. Moghaddam, and M. Haghifam, "A bi-level optimization model for operation of distribution networks with micro-grids," *International Journal of Electrical Power & Energy Systems*, vol. 82, pp. 169-178, 2016.
- [14] H. Khazaei, B. Vahidi, S. H. Hosseini, and H. Rastegar, "Two-level decision-making model for a distribution company in day-ahead market," *IET Generation, Transmission & Distribution*, vol. 9, pp. 1308-1315, 2015.
- [15] P. Sheikhhamedi, S. Bahramara, J. Moshtagh, and M. Yazdani Damavandi, "A risk-based approach for modeling the strategic behavior of a distribution company in wholesale energy market," *Applied Energy*, vol. 214, pp. 24-38, 2018.
- [16] Q. Wang, C. Zhang, J. Wang, P. Pinson, and J. Østergaard, "Real-time trading strategies of proactive DISCO with heterogeneous DG owners," *IEEE Transactions on Smart Grid*, vol. 9, pp. 1688-1697, 2018.
- [17] C. Zhang, Q. Wang, J. Wang, M. Korpás, and M. E. Khodayar, "Strategy-making for a proactive distribution company in the real-time market with demand response," *Applied Energy*, vol. 181, pp. 540-548, 2016.
- [18] H. Gerard, E. Rivero, and D. Six, "Basic schemes for TSO-DSO coordination and ancillary services provision," *SMARTNET Deliv. D*, vol. 1, 2016.
- [19] Y. Tohidi, M. Farrokhsersht, and M. Gibescu, "A Review on Coordination Schemes Between Local and Central Electricity Markets," in *2018 15th International Conference on the European Energy Market (EEM)*, 2018, pp. 1-5.
- [20] M. Q. Wang and H. Gooi, "Spinning reserve estimation in microgrids," *IEEE Transactions on Power Systems*, vol. 26, pp. 1164-1174, 2011.
- [21] S. Bahramara, M. P. Moghaddam, and M. R. Haghifam, "Modelling hierarchical decision making framework for operation of active distribution grids," *IET Generation, Transmission & Distribution*, vol. 9, pp. 2555-2564, 2015.
- [22] R.B. Burke, *Overview of New England's Wholesale Electricity Markets, Transactive Energy Workshop, ISO New England, 18 May 2011*, [https://www.gridwiseac.org/pdfs/tew\\_2011/presentations/burkepres\\_tew1\\_1.pdf](https://www.gridwiseac.org/pdfs/tew_2011/presentations/burkepres_tew1_1.pdf).
- [23] A. J. Conejo, M. Carrión, and J. M. Morales, *Decision making under uncertainty in electricity markets* vol. 1: Springer, 2010.
- [24] S. Bahramara, M. Yazdani-Damavandi, J. Contreras, M. Shafie-Khah, and J. P. Catalão, "Modeling the strategic behavior of a distribution company in wholesale energy and reserve markets," *IEEE Transactions on Smart Grid*, vol. 9, pp. 3857-3870, 2018.
- [25] M. J. Rider, J. M. López-Lezama, J. Contreras, and A. Padilha-Feltrin, "Bilevel approach for optimal location and contract pricing of distributed generation in radial distribution systems using mixed-integer linear programming," *IET Generation, Transmission & Distribution*, vol. 7, pp. 724-734, 2013.
- [26] E. G. Kardakos, C. K. Simoglou, and A. G. Bakirtzis, "Optimal offering strategy of a virtual power plant: A stochastic bi-level approach," *IEEE Transactions on Smart Grid*, vol. 7, pp. 794-806, 2016.
- [27] S. J. Kazempour, A. J. Conejo, and C. Ruiz, "Strategic generation investment using a complementarity approach," *IEEE Transactions on Power Systems*, vol. 26, pp. 940-948, 2011.
- [28] W. Alharbi and K. Raahemifar, "Probabilistic coordination of microgrid energy resources operation considering uncertainties," *Electric Power Systems Research*, vol. 128, pp. 1-10, 2015.