

Optimized low pressure solar DEC with zeolite based adsorption

Original

Optimized low pressure solar DEC with zeolite based adsorption / Simonetti, M.; Gentile, V.; Fracastoro, G. V.; Belmonte, R.. - In: ENERGY PROCEDIA. - ISSN 1876-6102. - 122:(2017), pp. 1033-1038.
[10.1016/j.egypro.2017.07.472]

Availability:

This version is available at: 11583/2752476 since: 2019-09-17T18:44:58Z

Publisher:

Elsevier Ltd

Published

DOI:10.1016/j.egypro.2017.07.472

Terms of use:

This article is made available under terms and conditions as specified in the corresponding bibliographic description in the repository

Publisher copyright

(Article begins on next page)



CISBAT 2017 International Conference – Future Buildings & Districts – Energy Efficiency from Nano to Urban Scale, CISBAT 2017 6-8 September 2017, Lausanne, Switzerland

Integration of Renewable Energy in the Built Environment (Electricity, Heating and Cooling)

Optimized low pressure solar DEC with zeolite based adsorption

Marco Simonetti*^a, Vincenzo Gentile^a, Gian Vincenzo Fracastoro^a, Rita Belmonte^a

^aDept. of Energy, Politecnico di Torino, c.so Duca degli Abruzzi 24, 10129 Torino, Italy ^bDept. of Architecture and Design, viale Mattioli 39, 10125 Torino, Italy

Abstract

This paper presents a new concept of hybrid/natural air conditioning system with a high level of architectural integration. A solar DEC (Desiccant Evaporative Cooling) open cycle with very low pressure drops, drastically reduces the electricity consumption for driving fans. The supply air is dehumidified by an innovative zeolite coated adsorption bed and cooled indirectly by an evaporative cooler, through a low pressure drop heat exchanger. The adsorption bed is a finned coil heat exchanger coated with a SAPO-34 zeolite layer realizing both heat and mass transfer in one component. Low thermal grade heat is used to regenerate the adsorbent material, showing high compatibility with low temperature solar systems such as flat plate or evacuated tubes solar collectors. Experimental data have been used for validating a CFD model of the coated coil. The possibility to remove the adsorption heat during dehumidification reduces the air temperature with a positive effect on cooling power.

© 2017 The Authors. Published by Elsevier Ltd.

Peer-review under responsibility of the scientific committee of the CISBAT 2017 International Conference – Future Buildings & Districts – Energy Efficiency from Nano to Urban Scale

Keywords: Solar DEC; Zeolite; CFD

1. Introduction

The Air Conditioning (AC) sector has continuously increased its relevance in the last decades, while more and more European buildings are provided with space cooling system to satisfy indoor comfort demand during warm and hot seasons. The technology typically used to cover the building cooling demand are heat pumps based on vapor

* Corresponding author. Tel.: +39-011-090-4544; fax: +39-011-090-4499.

E-mail address: marco.simonetti@polito.it

compression technology. By 2025, the installed cooling capacity is likely to be 55-60 % higher than the 2010 capacity. The Institute of Energy and Transport of the European Commission have estimated the total potential space cooling demand of the EU28 to be 292 *TWh* for the residential sector in an average year. The electrical capacity needed in case of realization of estimated demand potential was evaluated at 80 *GWe* [1] [2].

The increase of cooling demand and the consequential increase of the needed electrical power capacity, pose questions about environmental impacts from the increase of electricity consumption of traditional AC systems. Moreover, there is a risk of increasing electricity grid stress during summer seasons, especially in the southern European countries. An alternative solution to vapor compression systems is the use of heat driven cooling technologies coupled with solar thermal systems, also called solar cooling technologies. Solar cooling systems can use heat at different thermal grades to activate a refrigeration cycle, differently from traditional cooling systems that use electricity to drive the compressor of a heat pump. Despite the fact that thermally driven system can still make use of electricity to feed circulation pumps and ventilation fans, their electricity demand is significantly lower than that of traditional vapor compressor chillers. Heat driven cooling systems include many technologies based on different physical and chemical processes to produce the cooling. This research focuses on Desiccant Evaporative Cooling (DEC) systems, based on solid adsorption. These are open cycles which directly treat external airflows, typically for the ventilation of indoor environments, performing two steps: i) Air dehumidification to remove water vapor from air, exploiting the affinity between adsorption materials like silica-gel, zeolite, etc..., and water vapor. This step removes the latent part of the cooling load; ii) Air sensible cooling, exploiting water evaporation to reduce air temperature. This step removes the sensible part of the cooling load.

2. NAC WALL

The NAC WALL project aims to design a DEC system, embedded in wall and façades, driven by heat at a temperature range of 50-70°C, produced by a conventional solar thermal system. [3] [4] [5] This DEC configuration includes a dehumidification component based on an air/water heat exchanger. For this purpose, a coating of SAPO34 zeolite material is applied on a finned coil. A picture of the component is shown in Figure 1 and Figure 2. With this configuration, simultaneous heat and mass transfer happens in the dehumidification component, both in the desorption and in the adsorption phase. The improvement on mass transport phenomena increases the total cooling power of a DEC system, and a reduction of global dimensions can be achieved. The reduction of system encumbrance is an important key point to achieve a better and feasible integration of DEC systems in buildings and façades.

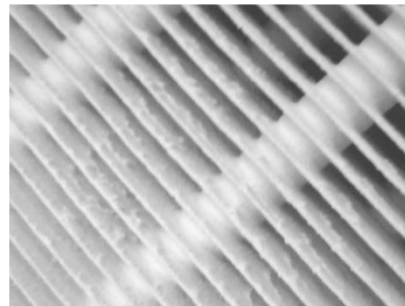

Figure 1. Coated Finned coil for heat and mass transfer

Figure 2 Zoom of the SAPO 34 coating

In order to exploit a solid adsorption bed without interruption it is necessary to use a batch configuration. Two dehumidification components work in parallel, switching between adsorption and regeneration phase, as shown in Figure 3. Figure 4 depicts the thermodynamic transformation of air on the psychrometric chart.

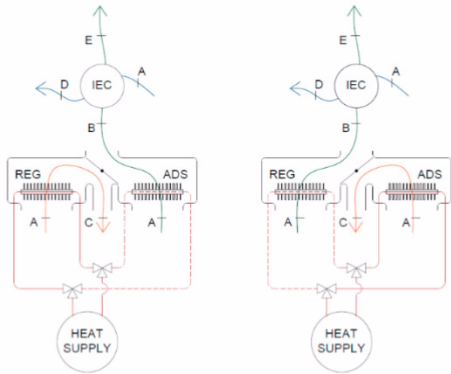

Figure 3 Scheme with two parallel dehumidifiers

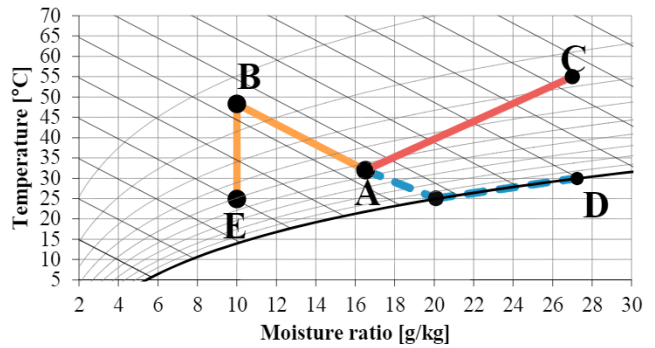

Figure 4. Air transformation on the psychrometric with isenthalpic adsorption

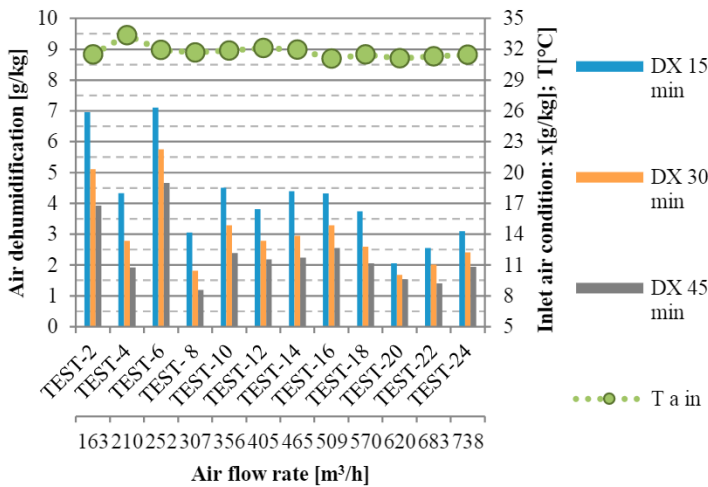

Figure 5. Recap of air dehumidification performance (DX) of the heat exchanger coated with SAPO-34 sorbent averaged on 15 minutes intervals. For each test the average inlet air temperature and moisture content are reported.

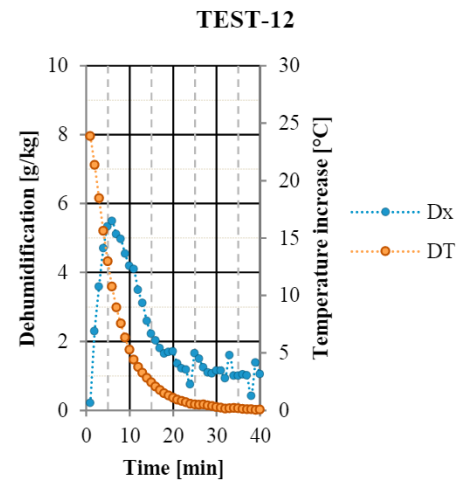

Figure 6. Evolution over adsorption TEST-12 of the air temperature increase (difference between outlet and inlet air) and dehumidification (difference between inlet and outlet)

During adsorption (A-B), air is dehumidified and the temperature increases up to 50-60 °C, due to the adsorption heat released [6]. After the dehumidification stage, air is cooled down by an indirect evaporative cooler (B-E). Water drop evaporation creates a latent heat exchange on secondary flow, cooling the primary air without increasing its moisture content. The secondary airstream (A-D) is discharged directly to the external environment, while the primary airflow is supplied to the room. In the regeneration phase, heat is supplied by increasing hot water circulation, air temperature and moisture content (A-C). The finned coil has been sized in order to reduce as much as possible the air side pressure drops, and, consequently, the electric consumptions. An experimental campaign was carried out to evaluate performances of the dehumidifier in full natural buoyancy, activated by hot water circulation through heat exchanger pipes [4]. Despite having achieved good results in the regeneration phase, the system showed low performance in terms of cooling power, in particular for the low air flow rate in the adsorption phase [4]. Hence, new tests were carried out with a forced/mixed ventilation regime, in the range of 100-700 m³/h. Dehumidification performance is summarized in Figure 5 and compared with averaged inlet air condition.

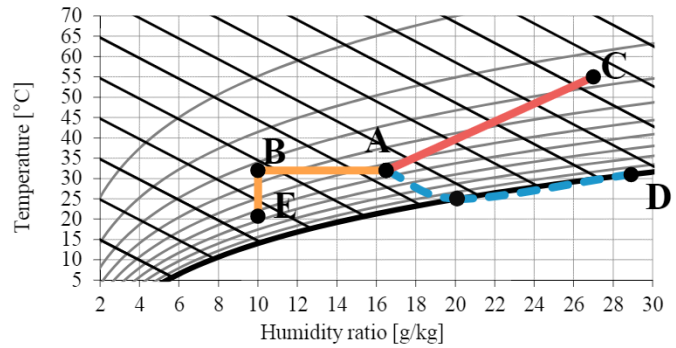
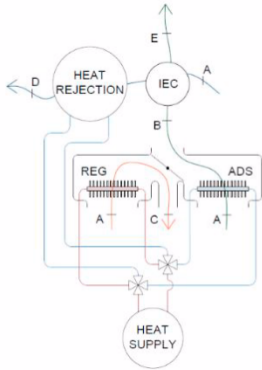

Figure 7. Scheme with heat rejection for cooled adsorption Figure 8. Air transformation on the psychrometric with cooled adsorption

The rise of air temperature can be consistent, and it is proportional to the air dehumidification, as reported in Figure 6. The rise of air temperature increases the minimum temperature that can be reached in the evaporative cooling stage, reducing the global cooling power of the system. This phenomenon can be reduced, or even cancelled, by cooling of the adsorptive mean through a cold water flow in the coil heat exchanger. Introducing a heat rejection system in the scheme of the DEC (Figure 7) that removes all the heat associated to adsorption phenomena, the air dehumidification transformation on the psychrometric chart becomes an isotherm (Figure 8).

3. Model

A 2D CFD (Computational Fluid Dynamic) transient model has been developed and solved with the commercial software Ansys Fluent, in order to evaluate T, x and u distribution in time and space (x,y). In addition to the conservation equations of mass, momentum and energy, the species transport model was used to simulate vapor diffusion. A user defined function (UDF) has been introduced to simulate the adsorption process. The assumption is made that the vapor adsorbed by zeolite is instantaneously and homogeneously distributed along the layer, due to the very thin layer of the coating. In the UDF, a mass sink at the air-zeolite interface is modelled, basing on the Linear Driving Force concept, which assumes an adsorption mass flow rate proportional to the difference between saturation and actual vapor pressure. The adsorption heat is accounted for as a volumetric heat source in the solid, thus solving the heat balance both on solid and fluid.

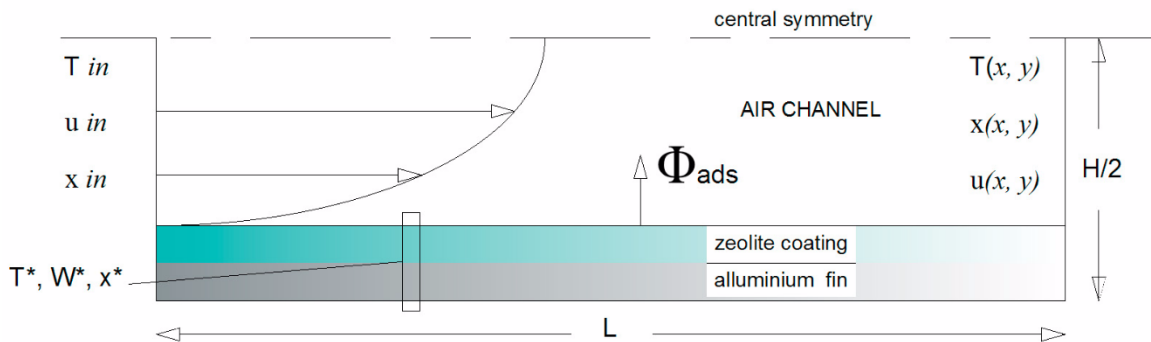

Figure 9. Scheme of the 2D CFD model of the adsorption phenomena in the heat exchanger

The model was compared with the experimental data summarised in Figure 5, and an error analysis on the total adsorbed mass in each test is reported in Figure 10.

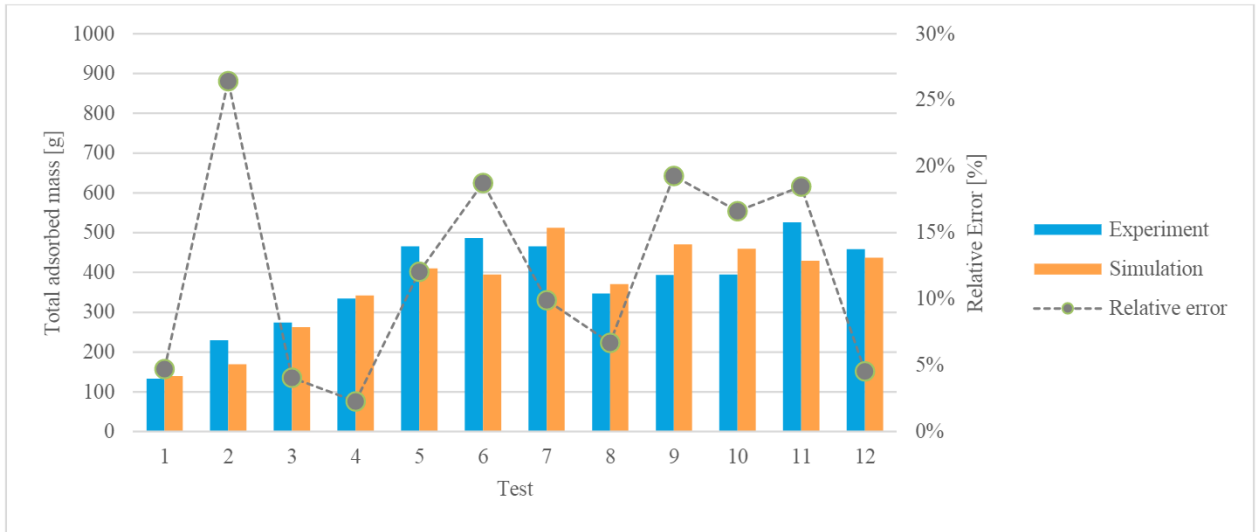

Figure 10. Comparison between experimental data and 2D CFD simulation, carried out on FLUENT, on the total adsorbed mass of water for each test.

4. Results

Two different cases were analyzed in this section, with the goal of examining the effect of the fin cooling during dehumidification:

- CASE A: no cooling of the fin during adsorption phase;
- CASE B: cooling of the fin during adsorption phase. In this case the fin is supposed to be at a constant temperature of 25 °C (298 K);

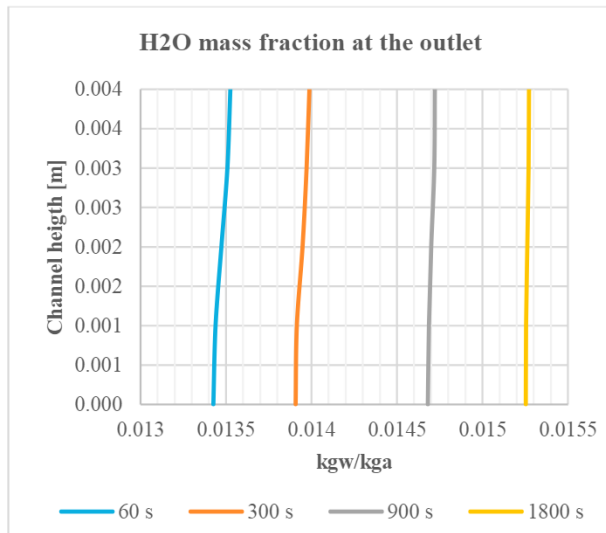

Figure 11. Air temperature distribution at the outlet section in the case A, at four different time step

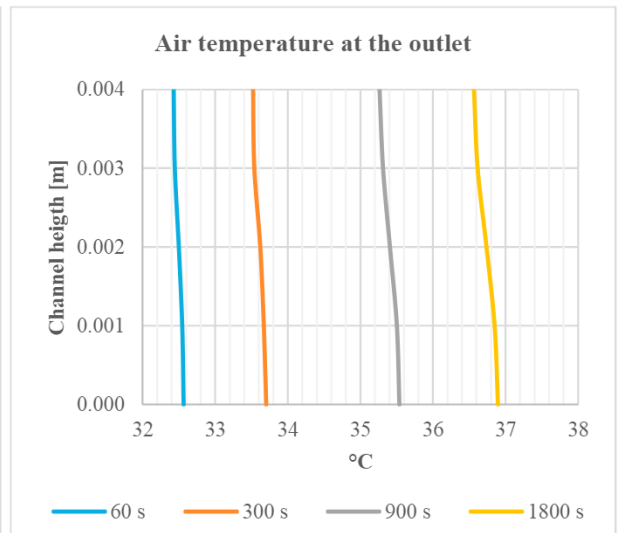

Figure 12. Air moisture distribution at the outlet section in the case A, at four different time step

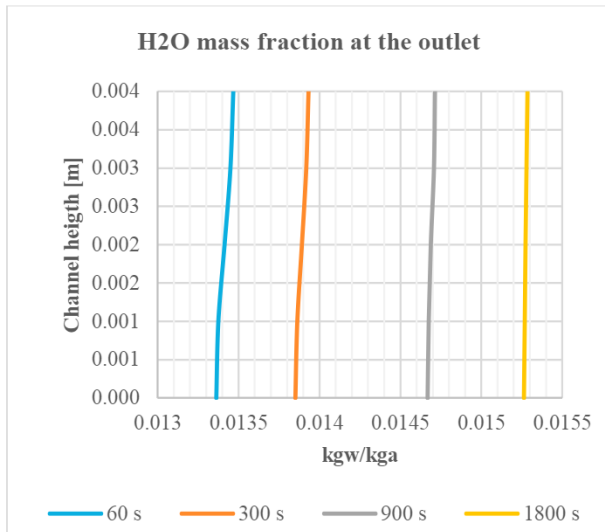

Figure 13. Air temperature distribution at the outlet section in the case A, at four different time step

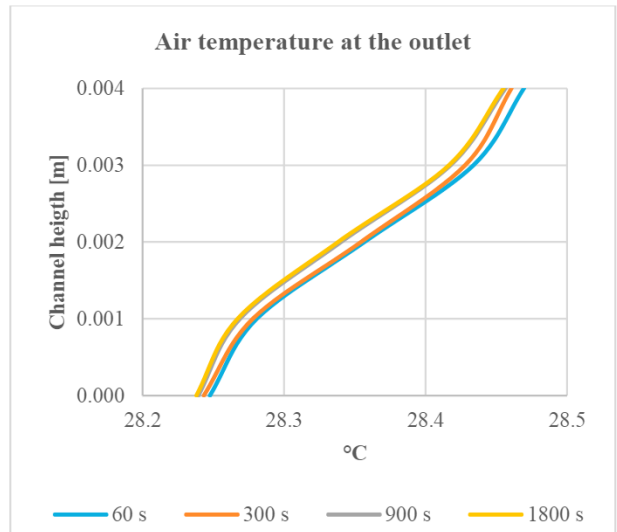

Figure 14. Air moisture distribution at the outlet section in the case A, at four different time step

As showed in Figures 13 and 14, the fin cooling has a major effect on air temperature in terms of distribution in time and in space, with a reduction of around 5-10 °C depending on the considered time step. In terms of air moisture content a very slow difference can be noted between case A and B, which causes the high flatness of adsorption isotherms of SAPO 34.

5. Conclusion

A 2D CFD model of a heat exchanger coated with SAPO 34 zeolite has been used to estimate the mass transfer of water vapor contained in air, and the related heat exchange. The model was validated with experimental data in the airflow rate range of 100-700 m³/h, at around 30 °C and variable moisture content. The validated model was used to study an improvement in the prototype system NAC-wall, simulating the transient adsorption in a typical batch operation mode. With a constant fin temperature of 25 °C a consistent reduction of the outlet air temperature can be achieved with a low increment on dehumidification performance. The main advantage is the reduction of inlet temperature on the indirect evaporative cooling stage, which follows the adsorption stage in a DEC cycle, and consequently, to reduce the achievable temperature with this configuration.

A positive effect on the total cooling power delivered to the indoor environment can be achieved introducing a heat rejection system that remove the heat of adsorption to realize an isothermal or under cooled dehumidification by the adsorption system.

References

- [1] Werner, Sven. *European space cooling demands*. 2016, Energy, p. 148-156.
- [2] Jakubcionis, Mindaugas e Carlsson, Johan. Estimation of European Union residential sector space cooling potential. *Energy Policy*. February 2017, Vol. 101, p. 225–235.
- [3] Simonetti M., Chiesa G., Grosso M., Fracastoro GV. NAC wall: An open cycle solar-DEC with naturally driven ventilation. *Energy and Buildings*. October 2016, Vol. 129, p. 357-366.
- [4] Simonetti M., Gentile V., Freni A., Calabrese L., Chiesa G. Experimental testing of the buoyant functioning of a coil coated with SAPO34 zeolite, designed for solar DEC (Desiccant Evaporative Cooling) systems of buildings with natural ventilation. *Applied Thermal Engineering* June 2016, Vol. 103, p. 781-789.
- [5] Grosso M, Fracastoro GV, Simonetti M, Chiesa G. A hybrid passive cooling wall system: concept and laboratory testing results. *Energy Procedia*. 2015, Vol. 78, p. 79-84.
- [6] Finocchiaro P., Beccali M., Gentile V. Experimental results on adsorption beds for air dehumidification. *International Journal of Refrigeration*. March 2016, Vol. 63, p. 100-112.
- [7] Aristov Y.I., Tokarev M., Freni A., Glaznev I., Restuccia G. Kinetics of water adsorption on silica Fuji Davison RD. *Microporous and Mesoporous Materials*. July 2006, Vol. 96, p. 65-71.