

Optimising energy flows and synergies between energy networks

Original

Optimising energy flows and synergies between energy networks / Badami, Marco; Fambri, Gabriele. - In: ENERGY. - ISSN 0360-5442. - ELETTRONICO. - 173:(2019), pp. 400-412. [10.1016/j.energy.2019.02.007]

Availability:

This version is available at: 11583/2731785 since: 2019-04-30T09:39:49Z

Publisher:

Elsevier Ltd

Published

DOI:10.1016/j.energy.2019.02.007

Terms of use:

This article is made available under terms and conditions as specified in the corresponding bibliographic description in the repository

Publisher copyright

(Article begins on next page)

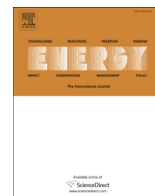

Optimising energy flows and synergies between energy networks

Marco Badami^{*}, Gabriele Fambri

Politecnico di Torino, Energy Department, C.so Duca degli Abruzzi 24, 10129 Torino, Italy



ARTICLE INFO

Article history:

Received 24 July 2018

Received in revised form

24 January 2019

Accepted 2 February 2019

Available online 4 February 2019

Keywords:

Renewable energy integration

Energy networks

Power to gas

Power to heat

Energy storage

ABSTRACT

The increased use of fluctuating renewable energy sources (RES) that is expected in the near future will lead to challenges concerning their full integration in the distribution grid, the reduction of RES curtailments and the mitigation of electric unbalances on the grid. Besides electric batteries (EB), other technologies, such as Power-to-Gas (P2G), Power-to-Heat (P2H) and Combined Heat and Power (CHP), make it possible to exploit synergies between various energy networks, thus alleviating problems of RES integration. In fact, when these technologies work simultaneously in a single energy system, their installed power mix, along with their optimised management and control, play a fundamental role in the energy optimisation of the whole system.

The aim of this paper is to offer a methodological approach for the analysis of the synergies between the different energy networks in order to cope with the increasing RES penetration. The proposed model has been used to perform a sensitivity analysis on the installed capacity of the various technologies; moreover, different simplified system management logics have been analysed by changing the priority order of the renewable energy surplus usage. The obtained results have been compared from an energetic, economic and environmental point of view.

© 2019 The Authors. Published by Elsevier Ltd. This is an open access article under the CC BY-NC-ND license (<http://creativecommons.org/licenses/by-nc-nd/4.0/>).

1. Introduction

As NASA has reported [1], the global temperature has risen by about 0.8 °C over the last 120 years. This increase is directly connected to an increase in anthropogenic greenhouse gas (GHG) emissions [2], and the 21st Conference of Parties (COP21) fixed a limit to these emissions in order to keep the global temperature increase below 2 °C [2,3]. To achieve this goal, a reduction of 50% of GHG emissions seems to be needed [4].

About 30% of GHG emissions are produced by the power sector [5], with an average emission of 520 gCO₂/kWh [6]. A shift from fossil fuel-based energy production towards renewable energy sources (RES) is therefore necessary to face this problem.

In the last few years, the installation of RES technologies (e.g. wind turbines and solar photovoltaic systems) has grown considerably and is expected to continue in the near future [7,8]; on the other hand, the major drawback of the utilisation of intermittent and variable renewable energies is the difficulty involved in matching the energy production with the energy demand [9].

In order to cover the energy demand with RES, it is necessary to

oversize the RES power installation, and this may cause an over-production during sunny and windy days. At present, the current practice is to curtail over-generation rather than to adapt the demand to an abundance of cheap, green energy. If this practice continues, it has been estimated that, by 2030, about 30 TWh of renewable electric energy will be curtailed per year and more than 200 TWh per year by 2050 [10].

One solution that can be adopted to meet the production and electric demand is to resort to electric storage systems, such as Pumped Hydro Storage (PHS), Electric Batteries (EB) and Compressed Air Energy Storage (CAES). These technologies make the electric demand more flexible in time, and thus easier to be covered by RES production. The economic impact on the energy system of different electric storage devices was analysed and compared in Ref. [11]. However, the flexibility that storage systems offer will not be enough to balance the scenario, in consideration of an ever increasing RES penetration. For this reason, the interaction between an electric energy system with other energy networks (e.g. district heating and natural gas network) can introduce benefits for the energy system as a whole, by adding flexibility to the demand side.

An interaction between the various energy networks may be achieved by implementing conversion technologies such as Power-to-Heat (P2H), which mainly uses Heat Pumps (HP) or Electric

^{*} Corresponding author.

E-mail address: marco.badami@polito.it (M. Badami).

Acronyms

CAES	Compressed Air Energy Storage
CAPEX	Capital Expenditure
CG2H	Centralised Gas boilers
CHP	Combined Heat and Power
COP	Coefficient of Performance
CP2H	Centralised Power to Heat
DH	District Heating
EH	Electric resistance Heaters
EB	Electric Batteries
FLH	Full Load Hours
G2H	Gas boilers
GHG	Greenhouse Gases
HP	Heat Pumps

LCOE	Levelised Cost of Electricity
LG2H	Local Gas boilers
LH	Local Heating
LHV	Lower Heating Value
LP2H	Local Power to Heat
NG	Natural Gas
OPEX	Operating and maintenance Expenditure
P2G	Power-to-Gas
P2H	Power to Heat
SNG	Synthetic Natural Gas
RES	Renewable Energy Sources
PV	Photovoltaic plants
TC	Total Cost
WT	Wind Turbines

resistance Heaters (HE), traditional Combined Heat and Power (CHP) plants or Power-to-Gas (P2G) systems, which convert electric energy into Synthetic Natural Gas (SNG).

As reported in the literature, these technologies may be of great benefit for the future energy scenario. For example in Ref. [12], P2H systems were analysed in a high RES penetration scenario, where this technology was supposed to satisfy the heat demand using the RES electricity production surplus; the role of CHP in a future smart energy system was instead evidenced in Refs. [13,14].

As far as P2G is concerned, several research activities have been carried out in the last few years, for example the advantages of using P2G technology in future energy systems were discussed in detail in Refs. [15,16], while the potential of P2G for RES energy accumulation in Germany was discussed in Refs. [17,18]. P2G was also applied in Ref. [19] to convert excess wind energy into SNG, thus increasing the share of wind energy, while another interesting study on the potential of P2G was carried out in Ref. [20] for the Italian scenario, where it was estimated that the current quantity of natural gas combustion could be reduced by nearly 5%, thanks to this technology.

As reported in Ref. [21], in order to move towards a high RES penetration scenario, it is necessary to study the energy system (electric, heat and natural gas sectors) as a whole. This kind of approach, which is usually called the Smart Energy System approach [13,21], can lead, thanks to a higher RES exploitation [22], to a reduction in the overall cost of the entire system. As a consequence, energy system models, such as those mentioned in Refs. [23,24], will become essential to forecast this trend. Several models have in fact been developed to simulate the energy systems of various regions, for example: for Australia [25,26], Berlin-Brandenburg (Germany) [27], Brazil [28], Finland [29], Iran [30], Pakistan [31], Rhineland-Palatinate (Germany) [32], Saudi Arabia [33], Southeast Asia [34], South/Central America [35], the USA [36,37], all of Europe [38] and for the entire World [39].

Despite the numerous articles in the literature about high RES penetration energy system scenarios, it is still difficult to find methodological approaches in literature that highlight the key aspects that should be considered when modelling and optimising these very complex energy systems.

The aim of this work has been to provide a methodological analysis for the optimisation of the synergies between different energy networks (Electric Grid, District Heating and Gas Network) in order to cope with the increasing penetration of high volatile Renewable Energy Sources. Synergy between networks can be achieved through different storage and conversion technologies, such as EB, P2G, P2H, CHP and G2H systems. To carry out this

analysis, a scenario based on real data pertaining to the city of Turin, the capital of the Piedmont Region in the north-west of Italy, has been applied. A possible simplified modelling and control methodology of the energy system, which includes electric, heat and natural gas energy networks, is discussed in this work. The model is based on the energy balance between energy production and demand, and the behaviour of the system has been evaluated from an energy, economic and environmental point of view. The impact of each technology has been evaluated, through a sensitivity analysis, by varying the installed capacity of each system. Moreover, the impact of other important parameters, such as the capital and operation expenditure of the most cutting-edge technologies and the renewable energy dispatch control has been discussed. These sensitivity analyses, conducted on the various technologies and on the control system, are useful to establish the weight that these technologies could have on a future energy system and their impact on the entire system from an environmental and economic point of view.

2. Methods

2.1. Energy system scheme

A schematic representation of the energy system studied in this work is presented in Fig. 1, where the considered electric energy is produced by RES (wind turbines and photovoltaic plants) and by CHP systems. Electric batteries (EB) are also considered as electric storage technologies in the scheme.

Heat is produced by CHP plants, by P2H technologies (Heat

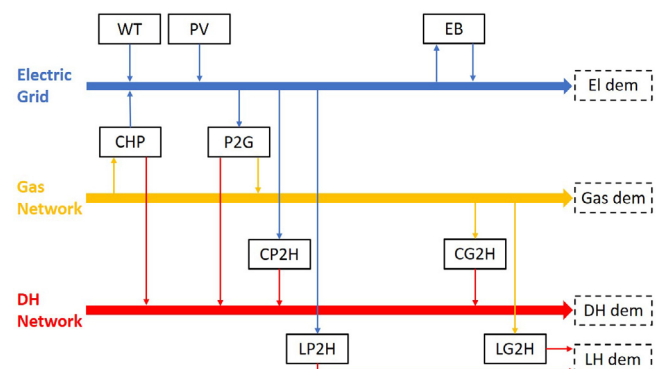

Fig. 1. Scheme of the energy system.

Pumps and Electric Heaters) and by G2H boilers. Moreover, the heat recovery during the methanation process of the P2G technology is also considered.

The natural gas (NG) grid is assumed to be an open system: in other words, the NG can be purchased from and sold outside the system, without any restrictions.

The model permits the system to be simulated over an entire year in a quasi-steady state mode, so the dynamics of the various components is not considered in this approach. Finally, the whole system was modelled as a 0 Dimensional scheme, hence the spatial distances between the different technologies were neglected.

2.2. Model scenario

The model presented above was applied to a scenario that was based on real data from the city of Turin, a city in the north of Italy, located 250 m above the sea level, characterised by 2617° days [40] and with a population of approximately 900,000 inhabitants [41].

The electricity demand, estimated from the National Grid Operator data [42], is approximately 3 TWh, that is, 1/3 of the electricity consumption of the entire metropolitan area (40% consumed by the industrial sector, 36% by the tertiary sector, 23% for domestic use and 1% for agricultural).

The thermal demand was instead derived from data reported in Ref. [43] and from the temperature profile of the city of Turin for the year 2016 [44]. The daily heat demand ($Q_{day\ heat\ season}$ [Wh]) for the heating season was calculated from October 15th to April 15th with Eq. (1) [43].

$$Q_{day\ heat\ season} = (312 - 13 T_m) V \tag{1}$$

where T_m [°C] is the average daily temperature and V [m³] is the heated volume, which corresponds to a total of about 90 million cubic meters [43]. The daily heat load outside the heating season was not considered to depend on the outside temperature and was considered to be equal to 13 Wh per cubic meter [43].

The load duration profile of the aggregated electricity and thermal load are plotted in Fig. 2. The thermal demand was divided into the district heating demand (2/3 of the total) and the local heat demand. Both the electricity and thermal load used for the simulations have a temporal resolution of 15 min.

The annual demand, the maximum peak and the mean power value of the electric and head demands are reported in Table 1.

The annual photovoltaic production profile was calculated using historical irradiation data for Turin for the year 2016 [44]. An installed capacity of 750 MW was assumed with a loss factor of 0.1, due to the non-perfect azimuth orientation [45]. This installed

Table 1
Characteristic data of the electric and heat demands.

Demand	Annual dem. [GWh]	Peak [MW]	Mean [MW]
Electric	3000	621	342
Heat	4000	2103	456

power value leads to an annual producibility of 919 GWh, which is in line with that reported in Ref. [46], where the photovoltaic solar energy potential of Turin was calculated on the basis of the available roof surface area.

As far as wind energy is concerned, the average wind speed in Turin is not enough to encourage wind turbine installations, due to the geographic position of the city. Nonetheless, the possibility of installing wind turbines was also considered to make the study more general. The annual profile of WT production was calculated from historical wind data pertaining to the Liguria region (close to Turin) for the year 2016 [44]. Taking into account the optimised energy mix proposed in Ref. [32], an installed WT power of 1000 MW was assumed.

The load duration curves of the two RES technologies are reported in Fig. 3, while the installed capacity, the annual producibility and the Full Load Hours of the RES technology are summarised in Table 2.

The installed capacities reported in Table 3 were chosen for the energy conversion and storage technologies, again considering the optimised energy mix proposed in Ref. [32], while the nominal capacities of the CHP and G2H were designed to be able to cover the maximum electric and heat load peaks.

2.3. Mathematical models

2.3.1. Electric batteries

The mathematical model of EB is characterised by four parameters: the maximum capacity $E_{el\ max\ EB}$ [kWh], and the charging and discharging efficiencies η_{ch} , η_{dis} and the C_{rate} [1/h], the latter of which is defined as follows:

$$C_{rate} = \frac{P_{el\ max\ EB}}{E_{el\ max\ EB}} \tag{2}$$

where $P_{el\ max\ EB}$ [kW] is the maximum input power. The stored energy at time t is:

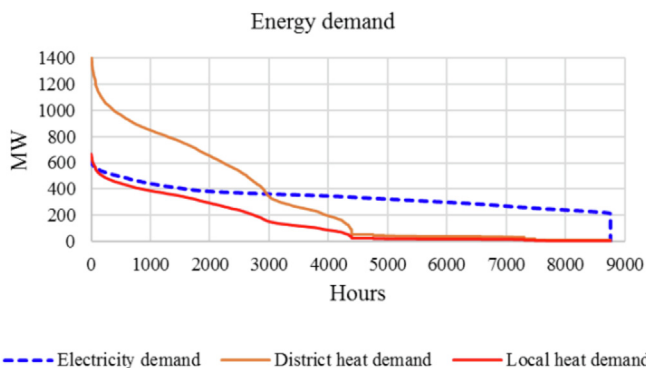

Fig. 2. Load duration curve of the energy demands (electricity demand, district heat demand and local heat demand).

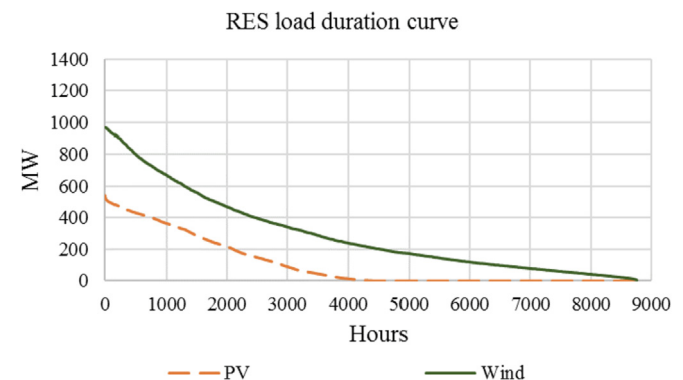

Fig. 3. Load duration curve for the WT and PV generation.

Table 2
Installed capacity of the RES technologies.

Technology	Nominal capacity [MWel]	Producibility [GWh/y]	Full Load Hours
WT	1000	2583	2583
PV	750	919	1226

Table 3
Installed capacity of the energy storage and conversion technologies.

Technology	Nominal capacity	Unit
DP2H (HP)	100	MWth
DP2H (EH)	70	MWth
LP2H (HP)	100	MWth
LP2H (EH)	70	MWth
EB	1000	MW _{hel}
P2G	200	MW _{el}
DG2H	1400	MWth
LG2H	700	MWth
CHP	620	MW _e

$$E_{el\ Li-ion} = \int_0^t (P_{el\ ch} - P_{el\ dis}) dt \quad (3)$$

where $P_{el\ ch/dis}$ is the charging/discharging power and:

$$P_{el\ ch} = \eta_{ch} P_{el\ in} \quad (4)$$

$$P_{el\ dis} = \frac{P_{el\ out}}{\eta_{dis}} \quad (5)$$

where $P_{el\ out}$ and $P_{el\ in}$ are the output electric power and the input electric power, respectively, and the corresponding energies can be calculated by means of integration.

2.3.2. Power-to-gas (P2G)

The P2G system is composed of an electrolyser and a methaniser. The electrolyser converts electric power into hydrogen that is then converted into Synthetic Natural Gas (SNG) during the methanation process. The P2G process can be summarised by means of the following equation:

$$P_{SNG} = \eta_{P2G} P_{el\ in} \quad (6)$$

where $P_{el\ in}$ [kW] is the electric input power, P_{SNG} [kW] is the produced SNG energy flow and η_{P2G} is the conversion efficiency of this process.

The heat recovered during P2G transformation, \dot{Q}_{P2G} [kW], can be calculated as follows:

$$\dot{Q}_{P2G} = \eta_{th\ P2G} P_{el\ in} \quad (7)$$

2.3.3. Power-to-Heat (P2H)

The P2H system includes Heat Pumps (HP) and Electric Heaters (EH). The heat power produced by the heat pump (\dot{Q}_{HP} [kW]) is calculated as:

$$\dot{Q}_{HP} = COP P_{el\ HP} \quad (8)$$

where COP is the coefficient of performance.

The Electric Heaters are modelled by means of the following equation:

$$\dot{Q}_{EH} = \eta_{EH} P_{el\ EH} \quad (9)$$

where \dot{Q}_{EH} [kW] is the heat power produced by the Electric Heaters and η_{EH} is the efficiency.

2.3.4. Gas boilers (G2H)

The gas boilers convert the chemical energy of natural gas into heat, and the heat power \dot{Q}_{G2H} [kW] can be calculated as follows:

$$\dot{Q}_{G2H} = \eta_{G2H} \dot{m}_{NG} LHV_{NG} \quad (10)$$

where η_{G2H} is the efficiency of the boilers, \dot{m}_{NG} [Sm³/h] is the flow rate of the natural gas and LHV_{NG} [kWh/Sm³] is its lower heating value.

2.3.5. Combined Heat and Power (CHP)

The CHP system converts the chemical energy of the natural gas into electricity, $P_{el\ CHP}$ [kW], and heat, \dot{Q}_{CHP} [kW], according to the following equations:

$$P_{el\ CHP} = \eta_{el\ CHP} \dot{m}_{NG} LHV_{NG} \quad (11)$$

$$\dot{Q}_{CHP} = \eta_{th\ CHP} \dot{m}_{NG} LHV_{NG} \quad (12)$$

where $\eta_{el\ CHP}$ and $\eta_{th\ CHP}$ are the electric and thermal efficiency of the CHP, respectively.

The efficiencies of the components used in the simulations are summarised in Table 4.

2.4. Performance indices

2.4.1. CO₂ emissions

The CO₂ emissions [tCO₂] were calculated using the following equation:

$$CO_2 = NG_{cons} * NG_{Em\ factor} \quad (13)$$

where the emission factor for natural gas is $NG_{Em\ factor} = 0.2012$ [tCO₂/MWh_{NG}] [54] and NG_{cons} [MWh_{NG}] is the yearly natural gas consumption, here defined as the natural gas consumed by the CHP plants and the G2H systems minus the synthetic gas produced by P2G.

$$NG_{cons} = NG_{CHP} + NG_{G2H} - SNG \quad (14)$$

Table 4
Efficiency of the implemented components.

Technology	Efficiency	Ref
CHP	$\eta_{el\ CHP} = 0.40$; $\eta_{th\ CHP} = 0.45$	[21,32,47–49]
P2G	$\eta_{P2G} = 0.60$; $\eta_{th\ P2G} = 0.25$	[32,50]
EB	$\eta_{ch} = 0.92$; $\eta_{dis} = 0.92$; $C_{rate} = 0.25$	[27,32,50]
HP	$COP = 3$	[21,51–53]
EH	$\eta_{EH} = 0.98$	[32]
G2H	$\eta_{G2H} = 0.90$	[48]

2.4.2. Levelised Cost of Electricity (LCOE)

An economic analysis, based on the Levelised Cost of Electricity (LCOE), was carried out. The cost of technologies that were not involved in the production or utilisation of electricity, such as gas boilers and the district heating network, were not considered in the calculation of the LCOE. Fig. 4 shows the control volume of the technologies involved in the LCOE calculation (control volume 1), while control volume 2 includes the entire system and it was used for the calculation of the CO₂ emissions that influence the LCOE due to the presence of a carbon tax.

The LCOE [€/MWh_{el}] was calculated by means of the following equation:

$$LCOE = \frac{TC + F - G - H + C}{E_{el}} \quad (15)$$

The annual total cost TC [€/year] was estimated taking into account the capital expenditure (CAPEX [€]) and the annual operative expenditure (OPEX [€/year]). In other words, $TC = \sum TC_i$ was considered as the total annual expenditure for the different technologies:

$$TC = \sum \frac{CAPEX_i}{Life\ time} + OPEX_i \quad (16)$$

With reference to Eq. (15), F [€/year] is the yearly expenditure for the fuel consumed by the CHP plants; H [€/year] are the revenues for the heat produced and distributed to customers during the year by the CHP, P2G and P2H; G [€/year] are the revenues for the synthetic natural gas produced in the year by P2G; C [€/year] is the cost for the carbon dioxide emissions of the entire system (control volume 2); finally, E_{el} [MWh_{el}/year] is the yearly electric energy produced and distributed to the customers. All the parameters used for the economic calculations are reported in Table 5.

The CAPEX and OPEX used in this study (see Table 6) were derived from an average of forecasted values found in literature for 2030.

The wind turbine technology is considered to be a mature technology and its specific CAPEX for the year 2030 varies in literature from around 1000 €/kW_{el} [27,50] to 1286 €/kW_{el} [57].

The forecast of the specific CAPEX for PV plants in 2030 is around 600–900 €/kW_{el} [27,32,56,57].

P2G plants and electric batteries are the technologies that are expected to show the greatest cost reduction over the next few years.

P2G specific CAPEX of 470 €/kW_{el} and 480 €/kW_{el} were assumed in Refs. [27,50], respectively, while higher costs were estimated in Refs. [31,32], where specific CAPEX values of 614

Table 5
Economic parameters.

Parameter	Value	Ref
Purchase cost of the NG	50 €/MWh	[27]
Selling price of the SNG	50 €/MWh	Assumption
Selling price of the heat	45 €/MWh	Assumption
Carbon tax	15 €/t	[19,55]

€/kW_{el} and 900 €/kW_{el} were reported, respectively.

The future specific CAPEX of EB is rather uncertain: an expenditure for Li-ion batteries of 150 €/kW_{el} was estimated for the year 2030 in Refs. [31,50], while 350 €/kW_{el} was estimated in Ref. [32]. The same uncertainty can also be observed for other battery technologies: the specific CAPEX for the molten salt technology was forecasted to be 319 €/kW_{el} for 2030 in Ref. [57], while a specific CAPEX of 100 €/kW_{el} was assumed for the same technology and the same year in Ref. [27].

2.5. Dispatch and supply priority

For the sake of simplicity, a rigid dispatch and supply priority has been considered in this work, and this simplified control logic is presented in Fig. 5. Although a simplified and rigid dispatching system does not fully highlight the opportunities of the coordination that could arise from an optimised management of the various technologies [58], it can still offer an indication of how the mix of storage and energy conversion technologies can be of benefit for the entire system.

2.5.1. Electric demand fulfilment

Electric demand fulfilment is achieved by attempting to maximise the RES penetration and at the same time attempting to reduce the electric energy produced by fossil fuel combustion. For this reason, in order to meet the electric demand (see Fig. 5a), the first considered option is to resort to the direct utilisation of RES. When the RES energy is lower than the electric demand, the energy stored in EB is used. The maximum discharge power of the storages is a constraint of the system, and it is set according to the storage characteristics. Finally, if the demand is not met when the stored energy is used, the CHP system is turned on.

2.5.2. Dispatching of the electric surplus

The electric surplus is defined as the amount of renewable energy that is not used to meet the electric demand. In other words, there is surplus whenever the energy produced by RES is higher than the electric demand. In a real scenario, dispatching excess renewable energy is a very complex problem. An overproduction of energy can cause reverse power flow and grid voltage unbalancing problems that can damage the functioning of the electricity grid [59,60].

The dispatching priority, chosen for the base scenario, exploits storage/conversion energy technologies by decreasing efficiency: P2H, EB and finally P2G. A subsequent analysis was carried out in which the priority order of the surplus dispatch through the three technologies was changed: P2H, EB and P2G. The electrical surplus (see Fig. 5b) is initially used to satisfy the thermal demand utilising the P2H energy conversion technology. If the thermal demand is satisfied, and there is still an electrical surplus, electric energy is stored in the batteries; finally, when the batteries are completely charged, the electricity surplus is converted into SNG by the P2G. When the storage/conversion technologies are not able to manage all the electric surplus, the RES production is curtailed in order not to overload the electric grid.

A subsequent analysis was carried out in which the priority

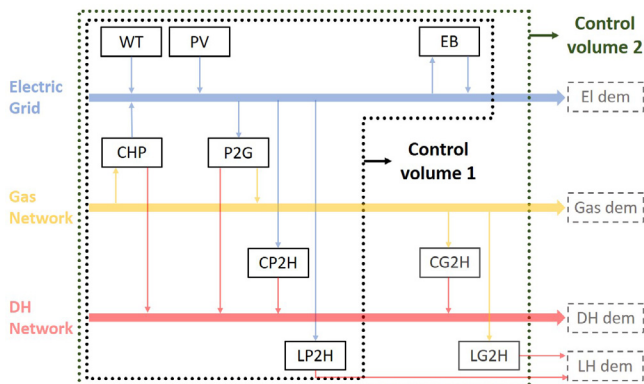

Fig. 4. Control volume 1: considered technologies for the calculation of the cost of electricity.

Table 6
Financial parameters of the installed technologies.

Technology	Specific CAPEX [€/kWe]	OPEX O&M [%CAPEX]	Life time Years	Ref.
WT	1100	3.5	25	[27,31,32,50,57]
PV	800	1.5	30	[27,32,56,57]
CHP	900	3.0	20	[32,38]
HP	2900	2.0	25	[38]
EH	100	1.0	20	[32]
EB ^a	250	1.0	15	[27,31,32,50,57]
P2G	750	2.0	20	[27,31,32,50,57]

^a The CAPEX of EB refers to its capacity and the values are therefore expressed in [€/kWeh].

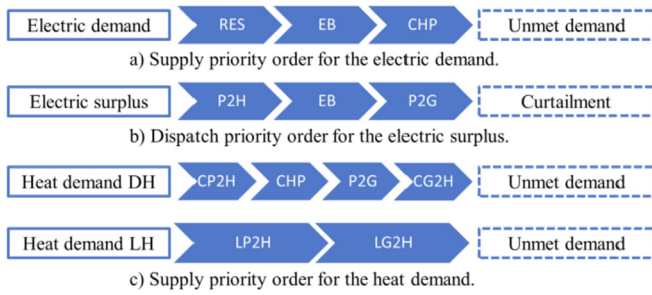

Fig. 5. Dispatch and supply priority.

order of the three technologies was changed: the different control solutions were analysed and are compared in section 3.4. This analysis, even though obviously very simplified, can give a rather clear idea of the range of variation that the real solution could undergo.

2.5.3. Heat demand fulfilment

As far as the heat supply is concerned, two different kinds of consumers were considered (see Fig. 1): the first kind represents those consumers that are connected to the district heating network (DH demand), while the second one pertains to the local heat demand (LH demand), that represents consumers that are not connected to the district heating.

The DH demand is covered by different technologies, with the following priority order (see Fig. 5c): first, if there is a surplus of electric energy, centralised Power-to-Heat systems (CP2H) are used. If there is no electric surplus, or if the heat produced by the CP2H systems is not enough, the heat produced by CHP and the heat recovered during the methanation process are used. When these technologies are not able to completely satisfy this thermal demand, centralised gas boilers (CG2H) are switched on to produce the remaining required heat.

As far as the LH demand is concerned, this heat demand has to be met by localised Power-to-Heat systems (LP2H) and gas boilers (LG2H).

The presented priority order for the DH and LH demands allows both the cost and the emissions for heat production to be reduced as the heat produced by P2H, using the free RES surplus, and the heat recovered from CHP and P2G are considered to be free of costs and CO2 emissions. Moreover, the P2H priority leads to a reduction in overloading problems caused by an overproduction of RES.

3. Results and discussion

Figs. 6–8 show how the model responds to the electric and thermal demands. The figures report the power profiles during two characteristic weeks (April) on the left and the corresponding value of the total energy over the entire year on the right.

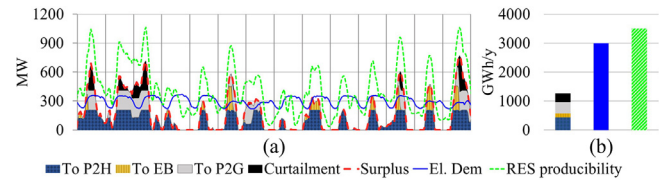

Fig. 6. Behaviour of the Electric demand, RES productivity, dispatch of the electric surplus. From 1/4 to 15/4 (a); entire year (b).

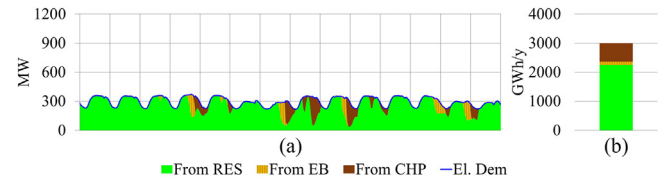

Fig. 7. Fulfilment of the Electric Demand. From 1/4 to 15/4 (a); entire year (b).

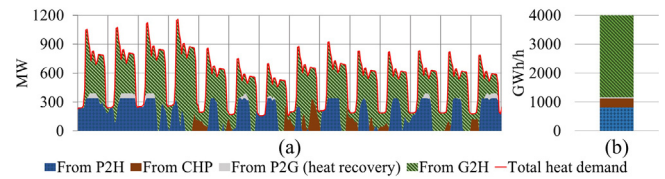

Fig. 8. Fulfilment of the Heat Demand (both DH and LHD). From 1/4 to 15/4 (a); entire year (b).

Fig. 6 shows the electric energy demand, the RES power productivity profile, the corresponding electric surplus and its dispatch. It is possible to note (see Fig. 6b) that, thanks to the high installed RES nominal power, the electric surplus is almost 35% of the RES productivity. The figure also shows how the electric surplus is dispatched (see Fig. 6a): the initial parts of the surplus peaks are converted into heat by the P2H technologies (blue area). In fact, as previously mentioned, the first technology activated, in the case of an electric surplus, is P2H (see Fig. 5b). P2H absorbs the electric surplus until its maximum capability is reached, or until the heat demand is completely satisfied. The remaining surplus is stored in the EB or converted into SNG by the P2G technology. Finally, when the electric surplus is too high, a curtailment of RES takes place (see the upper black parts of the peaks in Fig. 6a).

Fig. 7 reports the electric energy fulfilment for the same weeks. For most of the time, RESs are sufficient to cover the entire electricity demand (green area). When this is not the case, the first technology to come into operation (see Fig. 5a) is the EB storage technology (yellow area). EBs are able to provide the energy required until the stored energy is exhausted. The remaining electricity demand is covered by the electricity production of the

CHP plant (brown area). The share of RES for direct utilisation reaches 75% of the total electric demand and almost 80%, if the utilisation of renewable energy stored in the electric batteries is taken into consideration (see Fig. 7b).

The fulfilment of the heat demand from the different sources is depicted in Fig. 8. The heat from the used mix of technologies mainly comes from traditional G2H systems (dark green area), which weighs more than 65% on the heat demand throughout the entire year (see Fig. 8b). Part of the required heat is produced by the CHP plant (brown area), while the P2H technology is only used when an electric surplus is available (blue area), and it covers more than 25% of the yearly heat demand. Finally, the grey area in the graph represents the small part of heat supplied using the heat recovered during the methanation process in the P2G plant.

The total CO₂ produced during the simulated year is around 910 thousand tonnes, most of which is produced by G2H to satisfy the thermal demand (nearly 630 thousand tonnes). The P2G technology, thanks to the SNG production (which is considered to be a CO₂ free emission fuel), allows almost 50 thousand CO₂ tonnes per year to be saved.

The total annual cost for the technologies in the scenario results to be around 200 M€/y; the total cost for the purchase of NG is 80 M€/y plus almost 15 M€/y for the CO₂ emissions; the revenue from the produced SNG is around 10 M€/y, while the revenue for heat production (from P2H CHP and P2G) generates an annual revenue of nearly 50 M€/y. The LCOE results to be 77 €/MWhel.

Even though this result depends to a great extent on the analysed scenario, as well as on the economic assumption, it is possible to see specific similarities with the results present in the literature for the year 2030. In particular, in Ref. [57], the LCOE, for the European energy scenario with a high RES penetration and a high utilisation of storage and convention energy technologies, results to be around 71 €/MWhel. Different scenarios for the North-East Asia region were analysed in Ref. [50], and the resulting LCOE varies from 69 to 91 €/MWhel. The Austrian scenario was examined in Ref. [26], and the LCOE resulted to be around 70 €/MWhel. An LCOE of around 110 €/MWhel, for a regional scenario in South-West Germany, was estimated instead in Ref. [32], while an LCOE of 55–61 €/MWhel was estimated for Pakistan in Ref. [31].

3.1. Effect of the RES installed power

A sensitivity analysis of the RES installed power was carried out, and some of the results are reported in Figs. 9–16. The analysis was performed by separately increasing and decreasing the installed power of the WT and PV plants, starting from the base scenario (100%), which is reported in Tables 2 and 3.

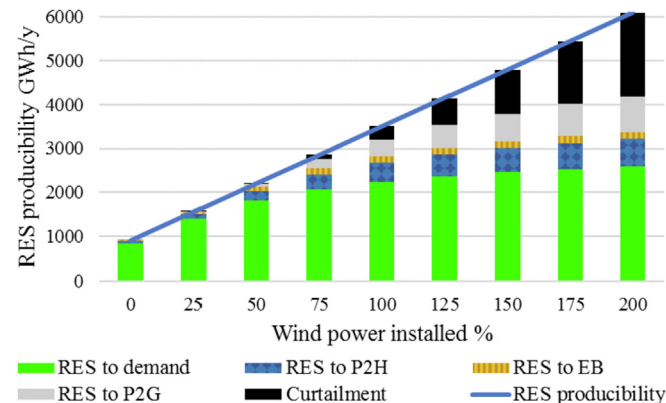

Fig. 9. Yearly RES producibility dispatch as a function of the WT nominal power.

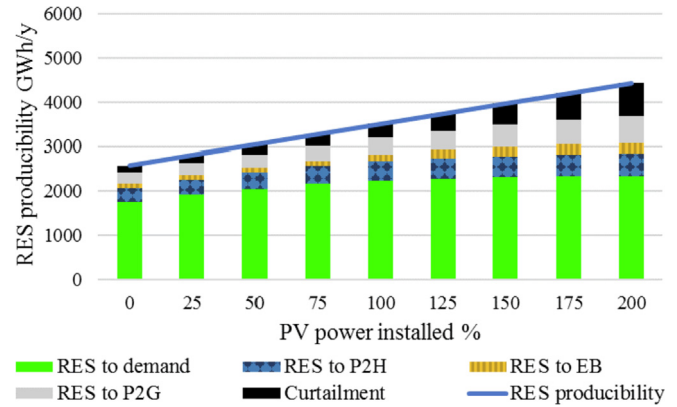

Fig. 10. Yearly RES producibility dispatch as a function of the PV nominal power.



Fig. 11. Mix of the yearly electric energy supply as a function of the WT installed power.

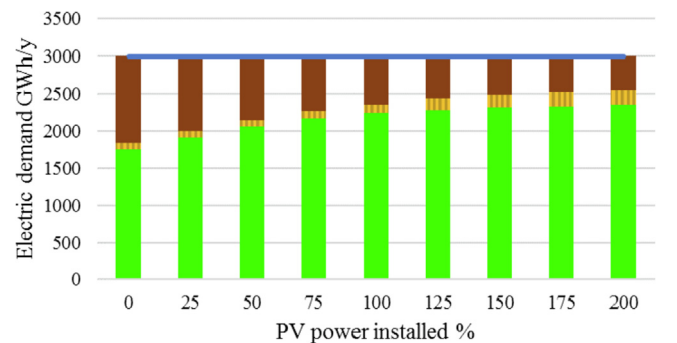

Fig. 12. Mix of the yearly electric energy supply as a function of the PV installed power.

As a result of the higher installed power and the higher value of the full load hours (FLH) (see Table 2), the increase in the WT installed capacity (Fig. 9) has a more significant impact on the system than an increase of the same percentage in PV power (Fig. 10).

Figs. 9 and 10 show the RES producibility and its dispatch to user demand (green bar), storage and conversion technologies. The direct utilisation of renewable energy shows a sort of higher limit as the RES producibility increases. This effect is due to the mismatch between the electricity demand profile and the RES production profile. It is possible to note that the higher the installed RES

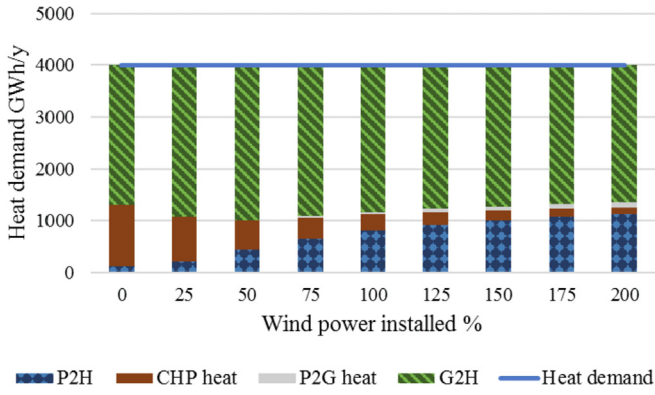

Fig. 13. Mix of the yearly heat supply as a function of the WT installed power.

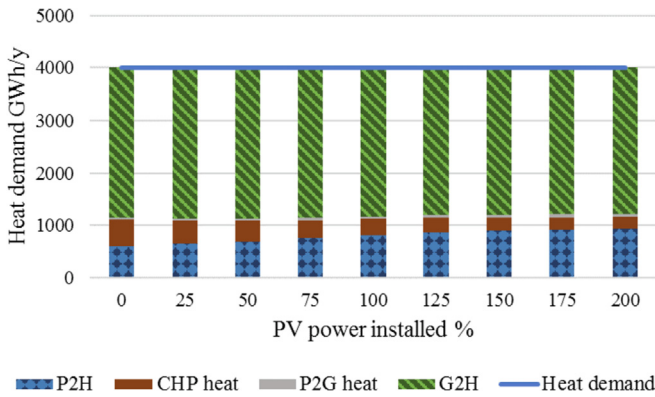

Fig. 14. Mix of the yearly heat supply as a function of the PV installed power.

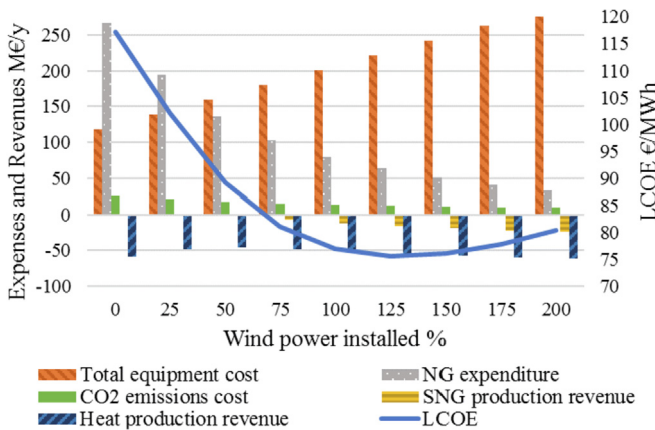

Fig. 15. LCOE as a function of the WT nominal power.

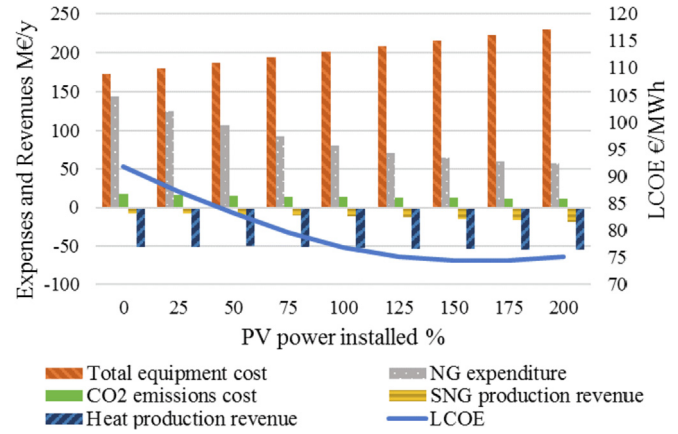

Fig. 16. LCOE as a function of the PV nominal power.

in the EB is used (yellow area); as mentioned above, neither direct RES utilisation nor EB utilisation increases linearly with the RES, but they do show a sort of saturation.

Fig. 13 and Fig. 14 show the yearly heat supply mix as a function of the WT and PV installed power, respectively. Most of the heat supply comes from the traditional G2H systems. The higher the RES nominal power is, the higher the heat produced by P2H (blue area) and the use of the heat recovered from the P2G plants (grey area), thanks to the higher availability of the electric surplus. Instead, the utilisation of the CHP heat (brown area) decreases as the RES nominal power increases, because the higher the RES production is, the lower the need of CHP electricity and as a result the lower the CHP heat production.

As the RES installed power increases, the expenditure for NG (grey bar) reduces (see Fig. 15 and Fig. 16), because of the reduction in the fuel-based energy production, and the revenues from heat delivery (blue bar) and SNG production (yellow bar) increase. On the other hand, the total equipment cost (orange bar) obviously increases linearly with the RES installed power. The combined effect of these factors leads to a minimum of the LCOE for both cases. It is possible to note, in Fig. 15, that an increase in the installed power for very low values of WT nominal power (between 0 and 25%) causes a decrease in the heat production revenues (blue bar); this is because an increase in the renewable energy decreases the need for CHP electricity production and therefore also decreases the heat produced by the plant and the corresponding revenues.

As far as CO2 emissions are concerned (see Fig. 17 and Fig. 18), the greater the installed power of RES is, the lower the CO2 emissions. The NG consumption for CHP reduces (brown bar) and the SNG produced by P2G (yellow bar) increases for an increase in the RES installed power. The fuel consumption for G2H (green bar) is also reduced by increasing RES: in fact, the higher the RES installation and the higher heat produced by P2H are, the lower the G2H utilisation.

nominal power is, the greater the role of the storage and conversion technologies, but the storage/conversion technologies obviously reach saturation for very high RES values, because they are constrained by their installed capacity. The curtailments, instead, increase considerably for high RES power installations.

Fig. 11 and Fig. 12 show the mix of the yearly electric energy supply as a function of the WT and PV installed power, respectively. As expected, the higher the RES installed power is, the higher the electric demand covered by RES (green area) and the lower the electricity produced by the CHP plant (brown area). The figures also show the electric demand that is satisfied when the energy stored

3.2. Effect of energy storage and conversion technology installed power

The results of a sensitivity analysis of the various energy storage and conversion technologies are presented in this section.

Figs. 19–21 show the LCOE as a function of the capacity of the EB, P2G and P2H technologies, while the total CO2 emissions are shown from Figs. 22–24. In the figures, 100% of the installed capacity corresponds to the value presented in Table 3.

As far as the EB capacity is concerned, Fig. 19 shows the sensitivity of the LCOE to variations in this parameter. The greater the

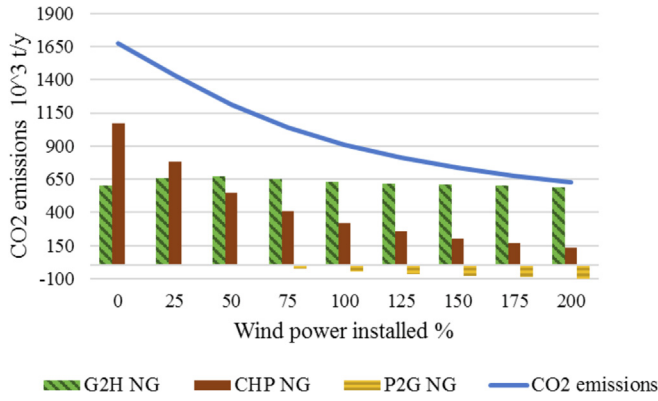

Fig. 17. CO2 emissions as a function of the WT nominal power.

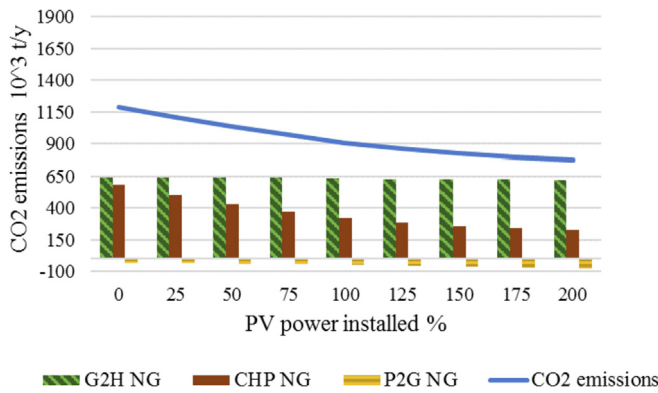

Fig. 18. CO2 emissions as a function of the PV nominal power.

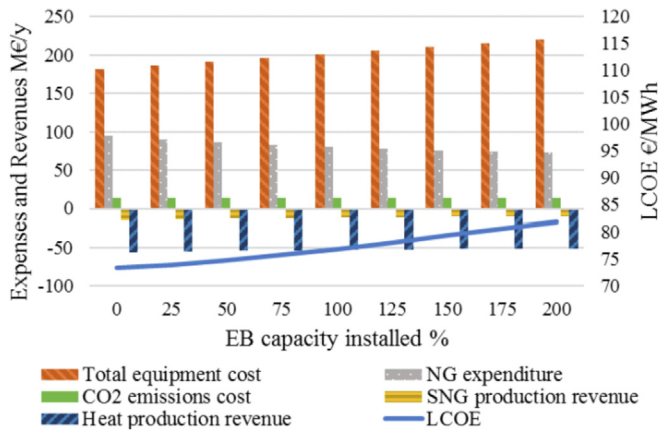

Fig. 19. LCOE as a function of the EB capacity.

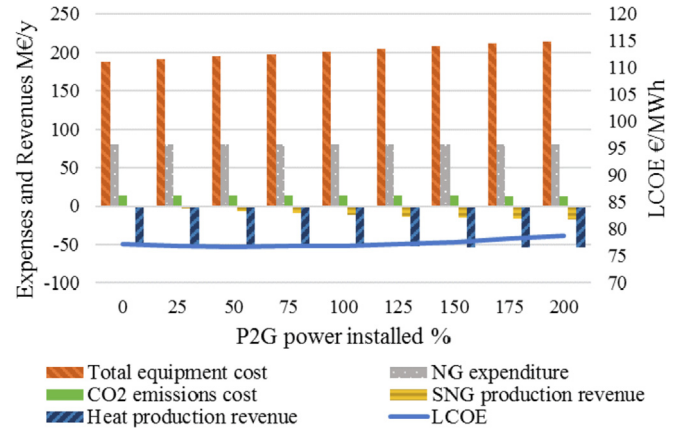

Fig. 20. LCOE as a function of the P2G capacity.

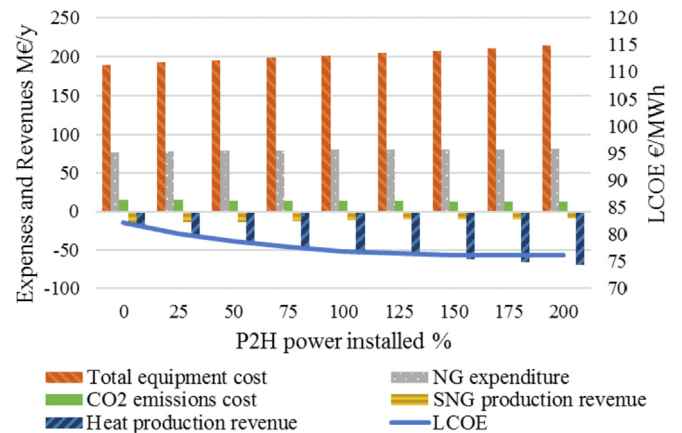

Fig. 21. LCOE as a function of the P2H capacity.

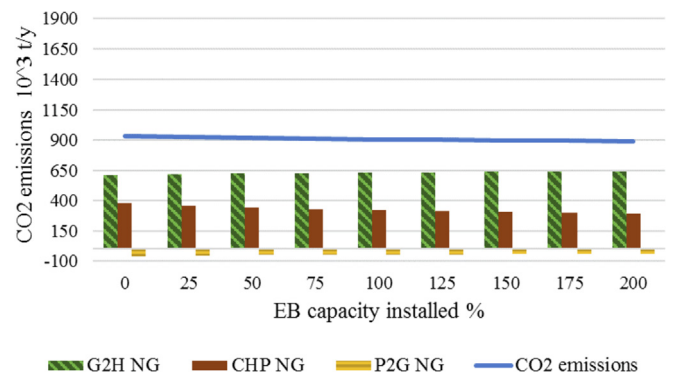

Fig. 22. CO2 emissions as a function of the EB nominal power.

installed capacity and the amount of electric demand met using the energy stored in EB are, the lower the utilisation of CHP electric energy and therefore the lower the expenditure for NG (grey bar). On the other hand, the total equipment cost increases to a great extent because of the higher investment cost for EB installation (orange bar). When these two effects are added together, LCOE always increases, which means that EB does not seem to be economically convenient in this kind of scenario (a similar result was also obtained in Ref. [32]). On the other hand, EB, thanks to its extremely fast response, is able to offer other kinds of electric advantages such as ancillary services to the grid [61]. From another

point of view, thanks to a lower utilisation of the CHP plant (see Fig. 22), the EB installation leads to a decrease in the total CO2 emissions (brown bar). This effect is partly offset by a greater NG consumption of the G2H plants (green bar), which is necessary to balance the lower heat production of CHP.

The P2G installed power effect on the LCOE and the CO2 emissions is plotted in Figs. 20 and 23, respectively. The economic benefit achievable for the production of SNG (yellow bar) is offset by an increase in the total equipment cost (orange bar). These two effects, under the hypothesis adopted and the parameters used in

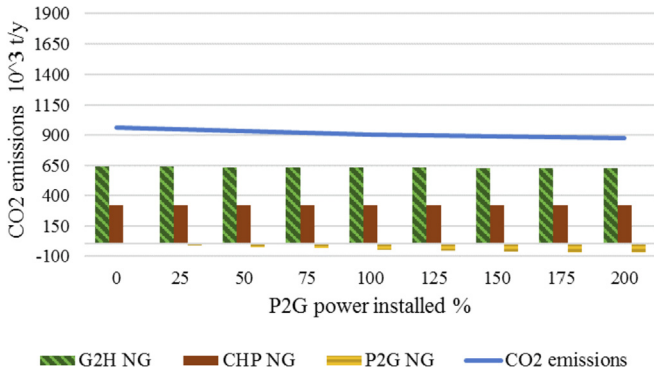

Fig. 23. CO2 emissions as a function of the P2G nominal power.

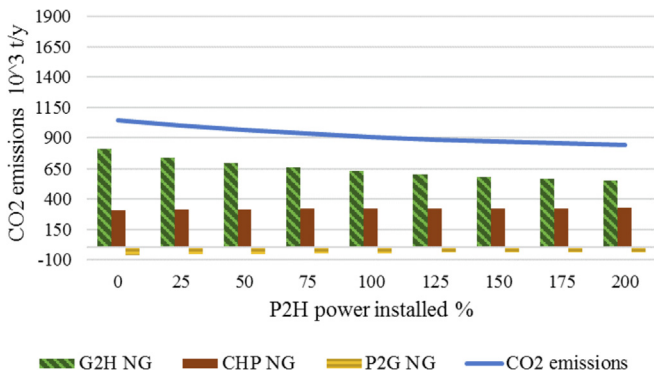

Fig. 24. CO2 emissions as a function of the P2H nominal power.

this work, produce an economic optimum that corresponds to the minimum of the LCOE curve (see Fig. 20). On the other hand, the higher the installed P2G power and produced SNG are, the lower the quantity of emitted CO2 (see Fig. 23). This positive effect is caused by the positive impact of SNG production (yellow bar), and also as a result of the reduction in G2H utilisation (brown bar), thanks to the P2G heat recovery.

The increase in the installed P2H has a positive effect on both the LCOE and CO2 emissions (see Figs. 21 and 24). The incidence of P2H on the total equipment cost is very small (orange bar), while the increase in revenues from the sale of heat is very consistent (blue bar). The total CO2 emissions also decrease as the installed power of P2H increases: the heat production from P2H leads to a consistent reduction in G2H utilisation, and thus in its emissions (green bar).

3.3. Effect of EB and P2G CAPEX

A sensitivity analysis was also carried out on the specific CAPEX of EB and P2G. The obtained results are reported in Fig. 25 and Fig. 26.

It is possible to note, from Fig. 25, that the EB installation only has a positive effect on LCOE if its specific CAPEX is lower than 150 €/kWhel.

As far as P2G is concerned (see Fig. 26), for the span of CAPEX considered in this analysis, the installation of a certain power of the P2G technology results to be positive, in economic terms. Obviously, the lower the specific CAPEX is, the higher the optimum P2G installed power. A similar result was obtained in Ref. [32], where the P2G had a positive economic effect.

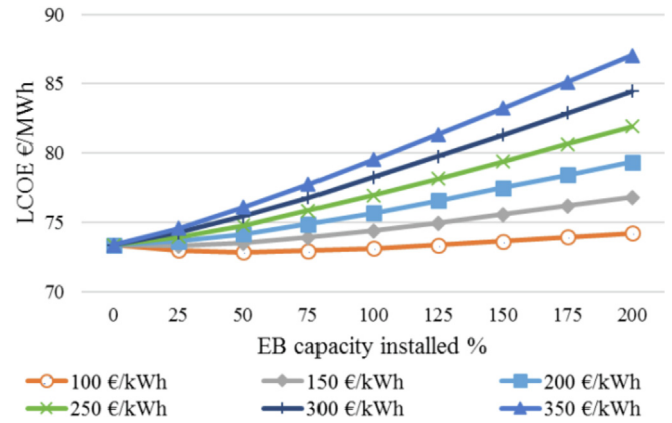

Fig. 25. LCOE as a function of the EB installed capacity for different specific CAPEX values.

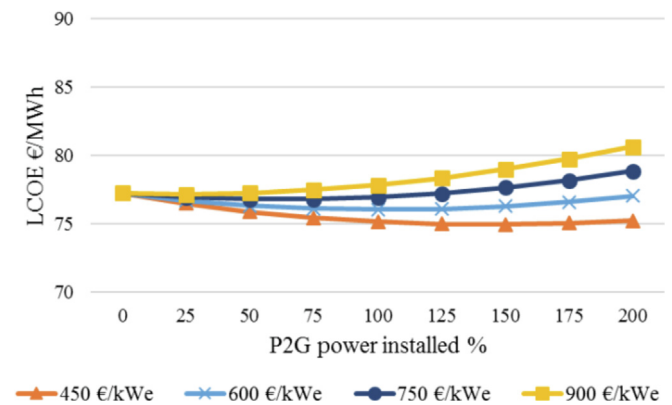

Fig. 26. LCOE as a function of the P2G installed capacity for different specific CAPEX values.

3.4. Effect of the priority dispatch of RES

When the energy produced by RES is higher than the electric demand, the excess energy must be dispatched to the different technologies or, if necessary, the RES must be curtailed in order to avoid overloading of the electric grid. In the previous analysis, a fixed priority dispatch order (described in section 2.5) was considered, where the technologies were prioritised as follows: P2H, EB and P2G.

This section studies the effect of different possible dispatch priorities of the electric surplus, and Table 7 shows the six possible priority orders that were analysed with the respective identification codes, where H-E-G is the one that was presented in the previous sections. This analysis is important to highlight to what extent the control strategy could play a fundamental role in future energy scenarios.

Table 7
Dispatch priority order codes.

Dispatch priority order	Code
P2H - EB - P2G	H-E-G
P2H - P2G - EB	H-G-E
EB - P2H - P2G	E-H-G
EB - P2G - P2H	E-G-H
P2G - P2H - EB	G-H-E
P2G - EB - P2H	G-E-H

Fig. 27 reports the surplus dispatch for the different priority logics. The amount of surplus available over the entire year is obviously not affected by the control logic. On the other hand, the priority order influences the annual rate of energy dispatched to the different technologies.

It is interesting to note that the curtailment is influenced to a great extent by the dispatch priority order: for example, a high priority of the EB produces an increase in curtailment (see E-G-H and E-H-G options in Fig. 27). The lowest level of curtailment is instead obtained for the G-H-E and H-G-E options. This effect is due to the fact that the more EBs are charged, the more often they will be saturated in the subsequent time step, which in turn will lead to an increase in the curtailments.

Fig. 28 shows the LCOE for the different priority orders. The greater the priority of EB is, the lower the fuel expenditure for CHP, even though, as mentioned above, this solution leads to an increase in curtailments. The priority of P2G influences the revenues as a result of the production of SNG, but this effect is not particularly relevant, even when P2G is the first choice. The lowest LCOE is obtained when P2H is the first priority, since the higher the priority of the P2H technology is, the higher the heat produced and thus the higher the related revenues.

The results of the carbon dioxide emission analysis are depicted in Fig. 29, where it is evident that the priority level of P2H has a great effect on CO2 emissions. The higher the priority level of this technology (H-E-G and H-G-E) is, the higher the heat produced using renewable energy, with a consequent reduction in the emissions from the traditional heat production. The highest

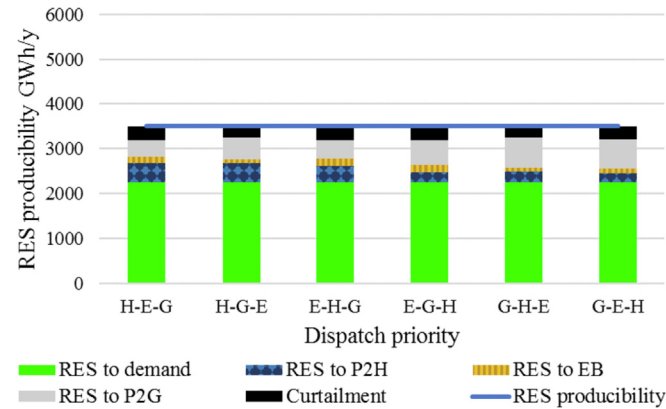

Fig. 27. Surplus dispatch as a function of the dispatch priority order.

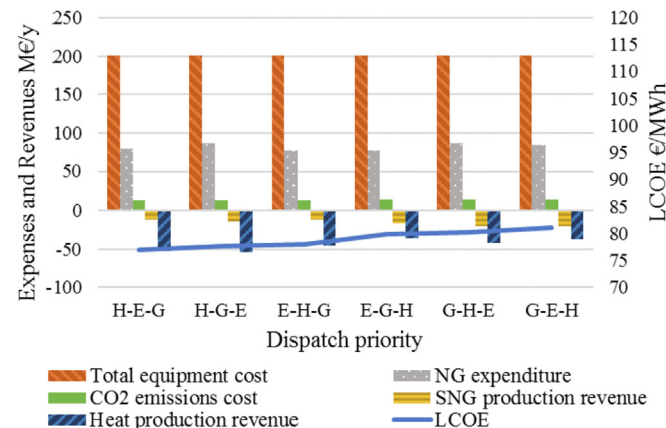

Fig. 28. LCOE as a function of the dispatch priority order.

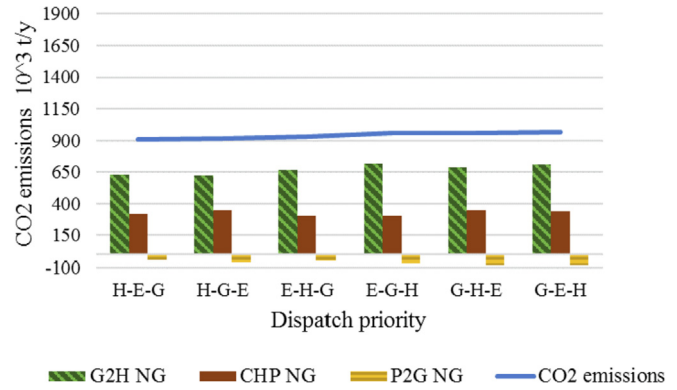

Fig. 29. CO2 emissions as a function of the dispatch priority order.

emissions are instead achieved for the E-G-H and G-E-H dispatch priority options.

4. Conclusions

This paper presents a methodological approach that may be used to model high RES penetration energy systems by considering the exploitation of possible synergies between the different energy networks (electric grid, district heating and natural gas). The proposed mathematical model, applied to a scenario based on real data pertaining to the consumption of the city of Turin (Italy), has been used to study the interaction of the three considered energy networks by means of the following technologies:

- P2G: electric energy to SNG;
- CHP: natural gas to electric energy and heat;
- P2H: electric energy to heat;
- G2H: natural gas to heat.

These technologies, as well as Electric Batteries (EB), make the energy demand more flexible in time, and facilitate a better exploitation of an increase in the fluctuating and unpredictable RES share.

A sensitivity analysis was carried out on the installed power of the different technologies, considering their behaviour, from an economic (LCOE) and greenhouse gas emission (CO2) point of view. Furthermore, different simplified control logics of the RES energy surplus priority dispatch were analysed and compared.

The main obtained results can be summarised as follows:

- 1) as shown in other studies, a future energy system with high RES penetration in the electrical sector is feasible and could also be advantageous from an economic point of view. The share of electricity demand covered by RES in the analysed scenario reaches almost 80%, and this value could easily be increased if biogas electric energy production were included;
- 2) the LCOE of the analysed energy scenarios varies from 70 to 120 €/MWh, depending on the economic assumptions, on the different types of management of the system and on the energy mix, in terms of RES and energy storage/conversion technology installation. The LCOE for the base scenario, obtained considering a reasonable energy mix and the average economic parameters reported in the literature, results to be 77 €/MWh, which is in line with the results reported in literature for similar studies of different energy scenarios for the year 2030.
- 3) despite the installation of an important share of energy storage and conversion systems, a significant part of RES energy usually

has to be curtailed to avoid grid balancing problems. As expected, the higher the installed power of the unpredictable RES technologies (e.g. WT and PV) is, the higher the share of RES energy used to meet the energy demand, with a consequent reduction in the annual quantity of CO₂ emissions. On the other hand, from an economic point of view (LCOE) and on the basis of the mix of technologies and assumption made in this work, the installed RES power shows an optimal operating point with a minimum in LCOE, due to the increase in the total equipment cost;

- 4) electric batteries (EB), as is well known, allow the electric demand peak loads to be shifted and thus the possible exploitation of RES to be increased; the electricity production from fossil fuel is also reduced accordingly. However, it is difficult that this technology could be convenient, from the economic point of view, in the absence of incentives, due to the high cost of this technology, even for the most optimistic scenario for 2030. A similar conclusion was found in Ref. [32], where it was concluded that it was not possible for EB to be competitive with the P2G log-storage technology. On the other hand, electric batteries, due to their fast dynamics, can represent an important benefit for ancillary services on the electric grid;
- 5) P2G has only recently been considered as a viable opportunity, and for this reason its future cost is quite uncertain. Despite this, a certain power capacity of P2G, with a CAPEX value based on an average forecast for 2030, has shown a positive effect from an economic and environmental point of view. This positive behaviour was also found in Ref. [32], where it was concluded that P2G technologies could be an important opportunity for future scenarios;
- 6) P2H allows direct synergies to be achieved between electricity and heat. The greater flexibility of the energy demand, due to P2H usage, improves RES exploitation considerably. Moreover, the high conversion efficiency of this technology, with its low unitary cost, can lead to important economic and environmental benefits for a future high volatile renewable energy penetration. The P2H technology, coupled with thermal storages, could be even more convenient, because it could be used easily to offer ancillary services to the electric grid. The unpredictable pikes of RES production could be stored in thermal storages in the form of thermal energy, thus decreasing RES curtailments and making the electrical network more stable to sudden variations in RES;
- 7) the effect of the dispatching priority for the RES production surplus was also studied and, even though the used system control was rigid on-off dispatching logics, it permitted the marked economic influence on the whole system to be pointed out. Increasing the synergies between the electricity and heat sectors was in fact shown to be the best solution.

Acknowledgements

This work was carried out under the PLANET “Planning and operational tools for optimising energy flows and synergies between energy networks” project activities, which were funded by the European Union’s Horizon 2020 Research and Innovation Programme under grant agreement no 773839 (topic: LCE-05-2017). The general aim of the PLANET project is to design and develop a holistic Decision Support System for grid operational planning and management in order to explore, identify, evaluate and quantitatively assess optimal strategies to deploy, integrate and operate conversion/storage systems on the distribution grid of several energy carriers.

References

- [1] Holli Riebeek. Global warming. NASA - Earth Obs; 2010. <https://earthobservatory.nasa.gov/Features/GlobalWarming/>.
- [2] Meinshausen M, Meinshausen N, Hare W, Raper SC, Frieler K, Knutti R, Frame DJ, Allen MR. Greenhouse-gas emission targets for limiting global warming to 2 C. *Nature* 2009;458(7242):1158–62.
- [3] Ritchie H, Reay DS. Delivering the two degree global climate change target using a flexible ratchet framework. *Clim Policy* 2017;17(8):1031–45.
- [4] Rogelj J, Hare W, Lowe J, Van Vuuren DP, Riahi K, Matthews B, Meinshausen M. Emission pathways consistent with a 2 °C global temperature limit. *Nat Clim Change* 2018;1(8):413–8.
- [5] Lehtveer M, Mattsson N, Hedenus F. Using resource based slicing to capture the intermittency of variable renewables in energy system models. *Energy Strat. Rev.* 2017;18:73–84.
- [6] Blanco H, Faaij A. A review at the role of storage in energy systems with a focus on Power to Gas and long-term storage. *Renew Sustain Energy Rev* 2018;81:1049–86.
- [7] Package EU. A Framework strategy for a resilient energy union with a forward-looking climate change policy. Communication from the Commission to the European Parliament, the Council, the European Economic and Social Committee, the Committee of the Regions and the European Investment Bank; 2015. p. 80. COM.
- [8] European Commission. Energy roadmap 2050. 2011. Brussels.
- [9] ENEA Consulting. THE POTENTIAL OF POWER-TO-GAS. Technology review and economic potential assessment. 2016. Paris.
- [10] DNV GL. Integration of renewable energy in Europe. DNV GL, Imperial College London, NERA Economic Consulting; 2014. p. 12.
- [11] Abdon A, Zhang X, Parra D, Patel MK, Bauer C, Worlitschek J. Techno-economic and environmental assessment of stationary electricity storage technologies for different time scales. *Energy* 2017;139:1173–87.
- [12] Pensini A, Rasmussen CN, Kempton W. Economic analysis of using excess renewable electricity to displace heating fuels. *Appl Energy* 2014;131:530–43.
- [13] Lund H, Andersen AN, Østergaard PA, Mathiesen BV, Connolly D. From electricity smart grids to smart energy systems—a market operation based approach and understanding. *Energy* 2012;42(1):96–102.
- [14] Widmann C, Lödige D, Toradmal A, Thomas B. Enabling CHP units for electricity production on demand by smart management of the thermal energy storage. *Appl Therm Eng* 2017;114:1487–97.
- [15] Parra D, Zhang X, Bauer C, Patel MK. An integrated techno-economic and life cycle environmental assessment of power-to-gas systems. *Appl Energy* 2017;193:440–54.
- [16] Götz M, Lefebvre J, Mörs F, Koch AM, Graf F, Bajohr S, Reimert R, Kolb T. Renewable Power-to-Gas: a technological and economic review. *Renew Energy* 2016;85:1371–90.
- [17] Schneider L, Kötter E. The geographic potential of Power-to-Gas in a German model region-Trier-Amprion 5. *J. Energy Storage* 2015;1:1–6.
- [18] Schiebahn S, Grube T, Robinius M, Tietze V, Kumar B, Stolten D. Power to gas: technological overview, systems analysis and economic assessment for a case study in Germany. *Int J Hydrog Energy* 2015;40(12):4285–94.
- [19] Guandalini G, Campanari S, Romano MC. Power-to-gas plants and gas turbines for improved wind energy dispatchability: energy and economic assessment. *Appl Energy* 2015;147:117–30.
- [20] Guandalini G, Robinius M, Grube T, Campanari S, Stolten D. Long-term power-to-gas potential from wind and solar power: a country analysis for Italy. *Int J Hydrog Energy* 2017;42(19):13389–406.
- [21] Mathiesen BV, Lund H, Connolly D, Wenzel H, Østergaard PA, Möller B, Nielsen S, Ridjan I, Karnøe P, Sperling K, Hvelplund FK. Smart Energy Systems for coherent 100% renewable energy and transport solutions. *Appl Energy* 2015;145:139–54.
- [22] Bačeković I, Østergaard PA. Local smart energy systems and cross-system integration. *Energy* 2018;151:812–25.
- [23] Connolly D, Lund H, Mathiesen BV, Leahy M. A review of computer tools for analysing the integration of renewable energy into various energy systems. *Appl Energy* 2010;87(4):1059–82.
- [24] Lyden A, Pepper R, Tuohy PG. A modeling tool selection process for planning of community scale energy systems including storage and demand side management. *Sustain Cities Soc* 2018;39:674–88.
- [25] Blakers A, Lu B, Stocks M. 100% renewable electricity in Australia. *Energy* 2017;133:471–82.
- [26] Lu B, Blakers A, Stocks M. 90–100% renewable electricity for the south west interconnected system of western Australia. *Energy* 2017;122:663–74.
- [27] Moeller C, Meiss J, Mueller B, Hlusiak M, Breyer C, Kastner M, Twele J. Transforming the electricity generation of the Berlin-Brandenburg region, Germany. *Renew Energy* 2014;72:39–50.
- [28] De Oliveira IA, Schaeffer R, Szklo A. The impact of energy storage in power systems: the case of Brazil’s Northeastern grid. *Energy* 2017;122:50–61.
- [29] Child M, Breyer C. Vision and initial feasibility analysis of a recarbonised Finnish energy system for 2050. *Renew Sustain Energy Rev* 2016;66:517–36.
- [30] Aghahosseini A, Bogdanov D, Ghorbani N, Breyer C. Analysis of 100% renewable energy for Iran in 2030: integrating solar PV, wind energy and storage. *Int J Environ Sci Technol* 2018;15(1):17–36.
- [31] Sadiqa A, Gulagi A, Breyer C. Energy transition roadmap towards 100%

- renewable energy and role of storage technologies for Pakistan by 2050. *Energy* 2018;147:518–33.
- [32] Kötter E, Schneider L, Sehne F, Ohnmeiss K, Schroerer R. The future electric power system: impact of Power-to-Gas by interacting with other renewable energy components. *J. Energy Storage* 2016;5:113–9.
- [33] Caldera U, Breyer C. Impact of battery and water storage on the transition to an integrated 100% renewable energy power system for Saudi Arabia. *Energy Proc* 2017;135:126–42.
- [34] Gulagi A, Bogdanov D, Breyer C. A cost optimized fully sustainable power system for Southeast Asia and the Pacific Rim. *Energies* 2017;10(5):583.
- [35] Barbosa LD, Bogdanov D, Vainikka P, Breyer C. Hydro, wind and solar power as a base for a 100% renewable energy supply for South and Central America. *PLoS One* 2017;12(3):e0173820.
- [36] Becker S, Frew BA, Andresen GB, Zeyer T, Schramm S, Greiner M, Jacobson MZ. Features of a fully renewable US electricity system: optimized mixes of wind and solar PV and transmission grid extensions. *Energy* 2014;72:443–58.
- [37] Jacobson MZ, Delucchi MA, Cameron MA, Frew BA. Low-cost solution to the grid reliability problem with 100% penetration of intermittent wind, water, and solar for all purposes. *Proc Natl Acad Sci Unit States Am* 2015;112(49):15060–5.
- [38] Connolly D, Lund H, Mathiesen BV. Smart Energy Europe: the technical and economic impact of one potential 100% renewable energy scenario for the European Union. *Renew Sustain Energy Rev* 2016;60:1634–53.
- [39] Jacobson MZ, Delucchi MA, Cameron MA, Mathiesen BV. Matching demand with supply at low cost in 139 countries among 20 world regions with 100% intermittent wind, water, and sunlight (WWS) for all purposes. *Renew Energy* 2018;123:236–48.
- [40] ENEA. "Tabella dei gradi/giorno dei Comuni italiani raggruppati per Regione e Provincia." Available on line at: http://efficienzaenergetica.acs.enea.it/doc/dpr412-93_allA_tabellagradiigiorno.pdf.
- [41] Dati ISTAT. Available on line at: http://dati.istat.it/Index.aspx?DataSetCode=DCIS_POPRES1#.
- [42] Terna. Statistiche regionali. 2016. Available on line at: <http://download.terna.it/terna/0000/1007/10.PDF>.
- [43] Noussan M, Jarre M, Poggio A. Real operation data analysis on district heating load patterns. *Energy* 2017;129:70–8.
- [44] Renewables.ninja web site. Available on line at: <https://www.renewables.ninja/>.
- [45] Bergamasco L, Asinari P. Scalable methodology for the photovoltaic solar energy potential assessment based on available roof surface area: application to Piedmont Region (Italy). *Sol Energy* 2011;85(5):1041–55.
- [46] Bergamasco L, Asinari P. Scalable methodology for the photovoltaic solar energy potential assessment based on available roof surface area: further improvements by ortho-image analysis and application to Turin (Italy). *Sol Energy* 2011;85(11):2741–56.
- [47] Pochettino E. IREN at a glance. 2017. Available on line at: <http://www.tpg.unige.it/TPG/wp-content/uploads/2017/11/Teleriscaldamento-cogenerazione-ed-accumuli.pdf>.
- [48] Nastasi B, Lo Basso G. Power-to-gas integration in the transition towards future urban energy systems. *Int J Hydrog Energy* 2017;42(38):23933–51.
- [49] Badami M, Modica S, Portoraro A. A biofuel-based cogeneration plant in a natural gas expansion system: an energetic and economic assessment. *Appl Therm Eng* 2017;118:52–61.
- [50] Bogdanov D, Breyer C. North-East Asian Super Grid for 100% Renewable Energy supply: optimal mix of energy technologies for electricity, gas and heat supply options. *Energy Convers Manag* 2016;112:176–90.
- [51] Esen H, Inalli M, Esen M. A techno-economic comparison of ground-coupled and air-coupled heat pump system for space cooling. *Build Environ* 2007;42(5):1955–65.
- [52] Esen H, Inalli M, Esen M. Technoeconomic appraisal of a ground source heat pump system for a heating season in eastern Turkey. *Energy Convers Manag* 2006;47(9–10):1281–97.
- [53] Bach B, Werling J, Ommen T, Münster M, Morales JM, Elmegaard B. Integration of large-scale heat pumps in the district heating systems of Greater Copenhagen. *Energy* 2016;107:321–34.
- [54] Juhlich K. CO2 emission factors for fossil fuels. In: *Climate Change; 2016*. Available on line at: https://www.umweltbundesamt.de/sites/default/files/medien/1968/publikationen/co2_emission_factors_for_fossil_fuels_correction.pdf.
- [55] European emission allowances web site. Available on line at: <https://www.eex.com>.
- [56] Masson G, Breyer C. Competitiveness of PV in Europe. In: *32nd EU PVSEC, Munich; 2016*.
- [57] Pleßmann G, Blechinger P. How to meet EU GHG emission reduction targets? A model based decarbonization pathway for Europe's electricity supply system until 2050. *Energy Strat. Rev.* 2017;15:19–32.
- [58] Müller SC, Georg H, Nutaro JJ, Widl E, Deng Y, Palensky P, Awais MU, Chenine M, Küch M, Stifter M, Lin H. Interfacing power system and ict simulators: challenges, state-of-the-art, and case studies. *IEEE Trans Smart Grid* 2018;9(1):14–24.
- [59] Ciocia A, Boicea VA, Chicco G, Di Leo P, Mazza A, Pons E, Spertino F, Nouredine H. Voltage control in low-voltage grids using distributed photovoltaic converters and centralized devices. *IEEE Trans Ind Appl* 2018;55(1):225–37.
- [60] Howlader AM, Sadoyama S, Roose LR, Sepasi S. Distributed voltage regulation using Volt-Var controls of a smart PV inverter in a smart grid: an experimental study. *Renew Energy* 2018;127:145–57.
- [61] Tan J, Zhang Y. Coordinated control strategy of a battery energy storage system to support a wind power plant providing multi-timescale frequency ancillary services. *IEEE Trans Sustain Energy* 2017;8(3):1140–53.