

Downtime estimation of building structures using fuzzy logic

Original

Downtime estimation of building structures using fuzzy logic / DE IULIIS, Melissa; Kammouh, Omar; Cimellaro, GIAN PAOLO; Tesfamariam, Solomon. - In: INTERNATIONAL JOURNAL OF DISASTER RISK REDUCTION. - ISSN 2212-4209. - ELETTRONICO. - (2019), pp. 1-13. [10.1016/j.ijdr.2018.11.017]

Availability:

This version is available at: 11583/2723879 since: 2019-10-16T15:24:27Z

Publisher:

Elsevier

Published

DOI:10.1016/j.ijdr.2018.11.017

Terms of use:

openAccess

This article is made available under terms and conditions as specified in the corresponding bibliographic description in the repository

Publisher copyright

(Article begins on next page)

DOWNTIME ESTIMATION OF BUILDING STRUCTURES USING FUZZY LOGIC

Melissa De Iuliis^a, Omar Kammouh^b, Gian Paolo Cimellaro^c, and Solomon Tesfamariam^d

^aDept. of Structural, Geotechnical and Building Engineering, Politecnico di Torino, Italy, Email: melissa.deiuliis@polito.it.

^bDept. of Structural, Geotechnical and Building Engineering, Politecnico di Torino, Italy, Email: omar.kammouh@polito.it

^cDept. of Structural, Geotechnical and Building Engineering, Politecnico di Torino, Italy (Corresponding author), Email: gianpaolo.cimellaro@polito.it

^dSchool of Engineering, The University of British Columbia, Kelowna, BC, Canada, Email: solomon.tesfamariam@ubc.ca

Abstract

Residential buildings are designed to withstand earthquake damage because it causes the buildings to be inhabitable for a period of time, called the *downtime*. This paper introduces a method to predict the downtime of buildings using a Fuzzy logic hierarchical scheme. Downtime is divided into three components: downtime due to the actual damage (DT1); downtime due to irrational delays (DT2); and downtime due to utilities disruption (DT3). DT1 is evaluated by relating the damageability of the building's components to pre-defined repair times. A rapid visual screening is proposed to acquire information about the analyzed building. This information is used through a hierarchical scheme to evaluate the building vulnerability, which is combined with a given earthquake intensity to obtain the building damageability. DT2 and DT3 are estimated using the REDi™ Guidelines. DT2 considers irrational components through a specific sequence, which defines the order of components repair, while DT3 depends on the site seismic hazard and on the infrastructure vulnerability. The proposed method allows to estimate downtime combining the three components above, identifying three recovery states: re-occupancy; functional recovery; and full recovery. A case study illustrating the applicability of the methodology is provided in the paper. The downtime analysis is applied to buildings with *low* and *medium* damage levels. Results from the case study show that total repair time is higher in the medium damage case, as it is expected. In both evaluations, the downtime is influenced more by irrational components and it is different in the three recovery states.

Keywords: Downtime, Restoration, Building structure, Fuzzy logic, Earthquake Resilience,

1. Introduction

The engineering community is continuously developing new methodologies to quantify the impact of natural and man-made disasters on buildings and infrastructures [1; 2]. Over the years, however, the focus has been shifting to managing and minimising the natural disasters risk, as it is prohibitively expensive (often impossible) to prevent it. In engineering, the concept of resilience has several definitions [3-5]. Bruneau et al. [6] defined seismic resilience as “the ability of both physical and social systems to reduce the change of a shock, to absorb such a shock if it occurs and to quickly re-establish normal performance”. Cimellaro et al. [7] introduced the concept of functionality recovery and suggested that resilience is “the ability of social units (e.g. organizations, communities) to mitigate hazards, contain the effects of disasters when they occur, and carry out recovery activities in ways to minimize social disruption and mitigate the effects of further earthquakes”. Wagner and Breil [8] define resilience as the ability to “withstand stress, survive, adapt, and bounce back from a crisis or a disaster and rapidly move on”.

The resilience of a system depends on its performance, which can range between 0 and 100%, where 0 means no service is available and 100 indicates a full level of service. Bruneau et al. [6] suggest that the loss of resilience is the service drop of the system over the total restoration period, which starts after the hazard event and finishes when the serviceability returns to its initial state. Mathematically, the loss of resilience can be defined as follows:

$$LOR = \int_{t_0}^{t_1} [100 - Q(t)] dt \quad (1)$$

where LOR is loss in resilience, t_0 is the time at which a disastrous event occurs, t_1 is the time at which the serviceability of the system is 100%, $Q(t)$ is the serviceability of the system at a given time t .

Several resilience frameworks can be found in literature. Some tackled the engineering resilience on the country level [9; 10] and some on the local and community levels [11-14]. Liu et al. [15] proposed a framework that combines dynamic modelling with resilience analysis. Two interconnected critical infrastructures have been analysed using the framework by performing a numerical calculation of the resilience conditions in terms of design, operation, and control parameter values for given failure scenarios. A quantitative method to evaluate the resilience at the state level was introduced in [9]. In their approach, the data provided by the Hyogo Framework for Action (HFA) [16], which is a work developed by the United Nations (UN), is used in the analysis. Another quantitative framework for evaluating community resilience is the PEOPLES framework [5]. PEOPLES is an expansion of the resilience research at the Multidisciplinary Center of Earthquake Engineering Research (MCEER). PEOPLES framework involves seven dimensions: Population, Environment, Organized government services, Physical infrastructures, Lifestyle, Economic, and Social capital [17].

The absence of a concise approach makes resilience difficult to determine, especially because the concept of resilience involves different aspects, such as seismic prediction, vulnerability assessment, coupling effects,

121
122 72 interdependencies and downtime estimation [18-22]. In the context of seismic risk assessment, quantifying downtime is
123
124 73 of importance to decision makers and owners [23].

125
126 74 In the seismic resilience evaluation, downtime is “the time necessary to plan, finance, and complete repair
127
128 75 facilities damaged by earthquakes or other disasters and is composed by rational and irrational components” [24]. The
129 76 “rational” components are predictable and easily quantifiable, such as construction costs and the time needed to repair
130
131 77 damaged facilities. The “irrational” components, on the other hand, consider the time needed to mobilize for repairs
132
133 78 (financing, workforce availability and, regulatory and economic uncertainty).

134
135 79 Several studies focusing on developing earthquake loss estimation techniques have been performed by The Federal
136
137 80 Emergency Management Agency (FEMA). These studies have resulted in the development of a loss estimation software
138 81 “HAZUS” [25]. HAZUS 97 was the first edition of the risk assessment software, built using GIS technology. HAZUS, in
139
140 82 which downtime is derived from the structural and nonstructural damage probabilities, provides an estimate for the
141
142 83 damage caused by extreme events. Porter et al. [26] introduced *Assembly-Based Vulnerability (ABV)* framework that
143
144 84 extends the School and Kustu approach for developing theoretical damage relationships. In the ABV, seismic
145 85 vulnerability functions were created for each building component using the related structural response and damage state
146
147 86 to estimate earthquake losses. Moreover, FEMA recently released the *Performance Assessment Calculation Tool*
148
149 87 (PACT), which is an electronic tool for performing probabilistic computation and accumulation of losses for individual
150
151 88 buildings [27]. It includes several utilities used to specify the building properties and it uses a methodology to assess the
152
153 89 seismic performance of individual buildings accounting for uncertainty in the building response. The methodology is
154 90 related to the damage that a building may experience and to the consequences of such damage. Later on, Almufti and
155
156 91 Willford [28] presented the *Resilience-based Earthquake Design Initiative (REDi™)*, which is a tool developed by Arup
157
158 92 in 2013 based on the result obtained from PACT. It aims to provide owners, architects, and engineers a framework for
159
160 93 implementing resilience-based earthquake design and for achieving much higher performance.

161 94 The methodologies described above mainly consider probabilistic type uncertainty. However, the decision making
162
163 95 framework is complex and it is subject to ignorance, imprecision and vagueness type uncertainties [29]. Using such
164
165 96 methodologies, the quantification of downtime, and therefore resilience, uses historical data and resources that are
166
167 97 usually not readily available. Furthermore, such parameters lead to complex mathematical formulation, and consequently,
168
169 98 existing methodologies are inappropriate for cases with high-uncertainty. Therefore, it is crucial to have a simple method
170 99 for predicting the downtime for building structures. This paper proposes a new methodology to evaluate the downtime
171
172 100 for three recovery states (e.g. re-occupancy, functional and full recovery) of building structures after earthquakes. The
173
174 101 methodology permits a fast and economical estimation of downtime parameters that involve uncertainties using the
175
176 102 Fuzzy Logic hierarchical scheme [30] in which information of damaged buildings is combined. Such information is

obtained from a Rapid Visual Screening, which is a questionnaire carried out by a screener to identify the design and the components of the damaged buildings. Moreover, the use of a fuzzy inference system allows the estimation of building damageability, which is the main parameter to quantify downtime. The methodology can be used by owners, engineers, architects, and decision makers for managing earthquakes consequences, minimizing the impacts of the earthquakes, and allowing the damaged buildings to recover as soon as possible.

2. Fuzzy logic

Zadeh [31] introduced the concept of fuzzy set and the theory behind it, which comes with the idea that complex systems can't be studied through classical mathematics as they are not "expressive" to characterize input-output relations in a situation of imprecision and uncertainty. While in the classical binary logic a statement can be valued by an integer number, zero or one corresponding to true or false, in the fuzzy logic a variable x can be a member of several classes (fuzzy sets) with different membership grades (μ) ranging between 0 (x does not belong to the fuzzy set) and 1 (x completely belongs to the fuzzy set) [32]. Later on, fuzzy sets were implemented to new approaches in which linguistic variables were used instead or in addition to numerical variables [33]. Fuzzy logic became a key factor in several fields such as Machine Intelligence Quotient (MIQ) to mimic the ability of human, industrial applications, and earthquake engineering. As shown in Fig. 1, the fuzzy logic consists of three main steps: 1) Fuzzification; 2) Fuzzy inference system; and 3) Defuzzification.

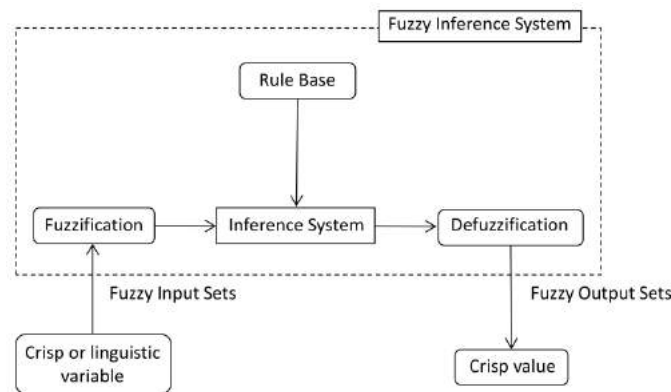

Fig. 1. Fuzzy Inference System

2.1. Fuzzification

Every basic input parameters have a range of values that can be clustered into linguistic quantifiers, for instance, very low (VL), low (L), medium (M), high (H) and very high (VH). The process of assigning linguistic values is a form of data compression called *granulation*. The fuzzification step converts the input values into a homogeneous scale by assigning corresponding membership functions with respect to their specified granularities [32].

241
 242 127 A membership function defines how input point is represented by a membership value between 0 and 1, and it is used
 243
 244 128 to quantify a linguistic term. There are different forms of membership functions but the most common types are the
 245
 246 129 triangular, trapezoidal, and Gaussian shapes. The type of the membership function can be context dependent and it is
 247
 248 130 generally chosen according to the user experience [34].
 249

250 131 2.2. Fuzzy Rules

252 132 The *fuzzy rule base* (FRB) is derived from *fuzzy knowledge base*, which is based on expert knowledge and/or
 253
 254 133 historical data, to define the relationships between inputs and outputs. The *fuzzy rule base* consists of statements called
 255
 256 134 rules that express the decision maker's opinion or judgment about an uncertain situation. The most common type is the
 257
 258 135 *Mamdani* type [35], which is a simple IF-THEN rule with a condition and a conclusion. For instance, considering two
 259 136 inputs x_1 and x_2 , the i^{th} rule R_i has the following formulation:

$$261 137 R_i : \text{IF } x_1 \text{ is } A_{i1} \text{ AND } x_2 \text{ is } A_{i2} \text{ THEN } y \text{ is } B_i, \quad i = 1, \dots, n \quad (2)$$

263 138 where x_1 and x_2 are the input linguistic variables (antecedent), A_{i1} and A_{i2} are the input sets, n is the total number of rules,
 264
 265 139 y is the output linguistic variable (consequent), B_i is the consequent fuzzy set. The IF-THEN rule involves both the
 266
 267 140 evaluation of the antecedents (x_1 and x_2) by fuzzifying the input and applying the fuzzy logic operator (AND), and the
 268
 269 141 application of this result to the consequent, known as implication.

270 142 An optimal strategy to select fuzzy rules of the FLC system has been recently proposed in [36; 37]. In their work, a
 271
 272 143 binary coded GA is used to realize an adaptive method in order to employ and optimize the fuzzy rule base through a
 273
 274 144 fitness function.

276 145 In this paper, the fuzzy rules are defined using a proposed weighted average method to systematize the process. A
 277
 278 146 weighting factor W , for instance 1 or 2, is assigned to each input. The weighting factor is usually defined using expert's
 279 147 judgement. This value represents the impact of the input towards the output (e.g. a weighting factor 2 signifies a higher
 280
 281 148 impact of the input towards the output). The output can be identified by considering the weights of the inputs. This is
 282
 283 149 mathematically represented in Equation 3, where L_{out} refers to the level of the output (*low*, *medium* or *high*, which can be
 284
 285 150 substituted by 1, 2, and 3 respectively), $L_{inp,i}$ is the level of input i , $W_{inp,i}$ is the weight of input i .

286 151 Consider the following example of a fuzzy rule base: IF input x_1 is *Low* ($L_{inp,1} = 1$) AND input x_2 is *Medium* ($L_{inp,2} = 2$)
 287
 288 152 and the corresponding weights are $W_{inp,1} = 1$ and $W_{inp,2} = 2$ respectively THEN the output y is $L_{out} = 1.67$ (using Equation 3)
 289
 290 153 which can be rounded to 2. Therefore, the level of the output y is *medium* (i.e., 2 corresponds to *medium*).

291
 292 154 Once Fuzzy rules are obtained, they are assigned to each parameter required for the downtime assessment.
 293
 294
 295
 296
 297
 298
 299
 300

$$L_{out} = \frac{\sum_{i=1}^n L_{inp,i} \times W_{inp,i}}{\sum_{i=1}^n W_{inp,i}} \quad (3)$$

2.3. Fuzzy Inference System (FIS)

The results of the rules are combined to obtain a final output through a process called *inference*. The evaluations of the fuzzy rules and the combination of the results of the individual rules are performed using fuzzy set operations to describe the behavior of a complex system for all values of the inputs. Different aggregation procedures are available: intersection, minimum, product, union, maximum, and summation [38]. For example, Mamdani's inference system consists of three connectives: the aggregation of antecedents in each rule (AND connectives), implication (IF-THEN connectives), and aggregation of the rules (ALSO connectives).

2.4. Defuzzification

Defuzzification represents the inverse of the fuzzification process. It is performed according to the membership function of the output variable. The purpose of the defuzzifier component of a fuzzy logic system (FLS) is to defuzzify the fuzzy output and obtain a final crisp output. Many different techniques to perform defuzzification are available in the literature, such as: center of the area, center of gravity, bisector of area, etc.

3. Methodology to quantify downtime

The Downtime assessment can be performed following five steps, which are:

- Step 1: Performance of a Rapid Visual Screening (RVS) of the potentially damaged buildings;
- Step 2: Creation of a hierarchical scheme, in which information obtained from the RVS is used as input;
- Step 3: Translation of the RVS results into numerical data through the use of Fuzzy system. The numerical data is used to define the Building Damageability membership (BD) following the defined hierarchical scheme;
- Step 4: Evaluation of the repairs (rational components), delays (irrational components), and utilities disruption considering the damage memberships that are greater than zero;
- Step 5: Defuzzification of the downtimes obtained from the analysis to quantify the total repair time.

In the following, each step will be expounded.

The evaluation of the downtime can be handled through a comprehensive hierarchical structure, which follows a logical path combining the parameters that contribute in the downtime analysis. The methodology starts with a Rapid Visual Screening procedure (RVS) of the potentially damaged buildings based on a sidewalk survey and a Data Collection form performed by an expert evaluator. The RVS aims to analyze the building and to collect information on the building design characteristics and on the building's components that are subject to damage after an earthquake. The Data Collection form includes building identification information, its use and size, photograph and/or sketches of the building, and data related to its seismic performance [39] (see Fig. 2).

RAPID VISUAL SCREENING OF BUILDINGS	
INSPECTION INFORMATION	
Screeener(s): _____	Date/Time: _____
BUILDING INFORMATION	
State: _____	City/Town: _____ Address: _____
Zip code: _____	Latitude: _____ Longitude: _____
SKETCHES	PHOTOGRAPH
Scale: _____	
BUILDING DESIGN INFORMATION	
No. stories: _____	Building height (ft.): _____ Total floor area (sq. ft.): _____ Year of construction: _____
Occupancy:	Assembly Commercial Emer.Services Historic Units: _____
	Industrial Office School Government
	Utility Warehouse Residential Shelter
Structural system:	C1 <input type="checkbox"/> C2 <input type="checkbox"/> C3 <input type="checkbox"/>
Vertical irregularity:	Yes <input type="checkbox"/> No <input type="checkbox"/> Plan irregularity: Yes <input type="checkbox"/> No <input type="checkbox"/>
Construction quality:	Poor <input type="checkbox"/> Average <input type="checkbox"/> Good <input type="checkbox"/>
PRE-EARTHQUAKE RECOVERY PLANNING INFORMATION	
Post-Earthquake inspection program: Yes <input type="checkbox"/> No <input type="checkbox"/>	
Engineer on contract:	Yes <input type="checkbox"/> No <input type="checkbox"/> Contractor on contract: Yes <input type="checkbox"/> No <input type="checkbox"/>
Type of financing:	
No <input type="checkbox"/>	Pre-arranged credit line <input type="checkbox"/> SBA-backed loans <input type="checkbox"/> Private loan <input type="checkbox"/>
Insurance <input type="checkbox"/>	
Comments:	

Fig. 2 Rapid Visual Screening form

This process is affected by subjective and qualitative judgments [40], which can be handle through the fuzzy set theory. A Fuzzy system is implemented in the procedure to translate the RVS results from linguistic terms into numerical data. Building information from the RVS is incorporated through a hierarchical structure, which follows a logical order

421
 422 192 for combining specific contributors (e.g. site seismic hazard and building vulnerability modules) to estimate the building
 423
 424 193 damage [30]. The building damageability is carried out as five-tuple membership values (μ_{VL}^{BD} , μ_L^{BD} , μ_M^{BD} , μ_H^{BD} ,
 425
 426 194 μ_{VH}^{BD}) and each membership value is associated with five damage states, *very low* (VL), *low* (L), *medium* (M), *high* (H),
 427
 428 195 *and very high* (VH). The building membership can be considered as the limit state in which the structure may be for a
 429
 430 196 given site seismic hazard and building vulnerability. For this reason, the downtime analysis is carried out for the degrees
 431 197 of damage membership that are greater than zero, which represents the possibility of the building being in a limit state.
 432
 433 198 For instance, if the damage membership is $(\mu_{VL}^{BD}, \mu_L^{BD}, \mu_M^{BD}, \mu_H^{BD}, \mu_{VH}^{BD}) = (0, 0, 0.37, 0.63, 0)$, the downtime is
 434
 435 199 quantified for damage = *Medium* (0.37) and damage = *High* (0.63) [41].
 436

437 200 These fuzzy numbers describe the damage expected as a result of a given earthquake and are used to calculate the
 438
 439 201 *repairs, delays, and utilities disruption*. To estimate the downtime due to *repairs*, it is necessary to define the repair time
 440
 441 202 for each component of the analyzed building and the number of workers assigned for the repair.

442 203 Downtime due to *delays* is based on irrational components. The irrational components considered in the paper are a
 443
 444 204 selection from the components introduced in REDI™: post-earthquake inspection, engineering mobilization, financing,
 445
 446 205 contractor's mobilization, and permitting. [24].

447 206 Downtime due to *utilities* depends on the infrastructure systems that are likely to be disrupted after an earthquake (e.g.
 448
 449 207 electricity, water, gas, etc.). The evaluation of utilities disruption is necessary since functional and full recovery of the
 450
 451 208 building cannot be reached while utilities are disrupted.

452
 453 209 Finally, once the rational components, the irrational components, and the utilities disruption are known, the total repair
 454
 455 210 can be estimated. A downtime value is computed for each damage membership as follows:

$$DT = \sum_{i=1}^n DT_i * \mu_i \quad (4)$$

456
 457 211 where DT_i is the downtime for a certain granulation, i is the granulation assigned to the damage membership, μ_i is the
 458
 459 212 damage membership degree of granulation i . The hierarchical downtime structure is illustrated in Fig. 3.
 460
 461 213
 462
 463 214
 464
 465
 466
 467
 468
 469
 470
 471
 472
 473
 474
 475
 476
 477
 478
 479
 480

481
482
483
484
485
486
487
488
489
490
491
492
493
494
495
496
497
498
499
500
501
502
503
504
505
506
507
508
509
510
511
512
513
514
515
516
517
518
519
520
521
522
523
524
525
526
527
528
529
530
531
532
533
534
535
536
537
538
539
540

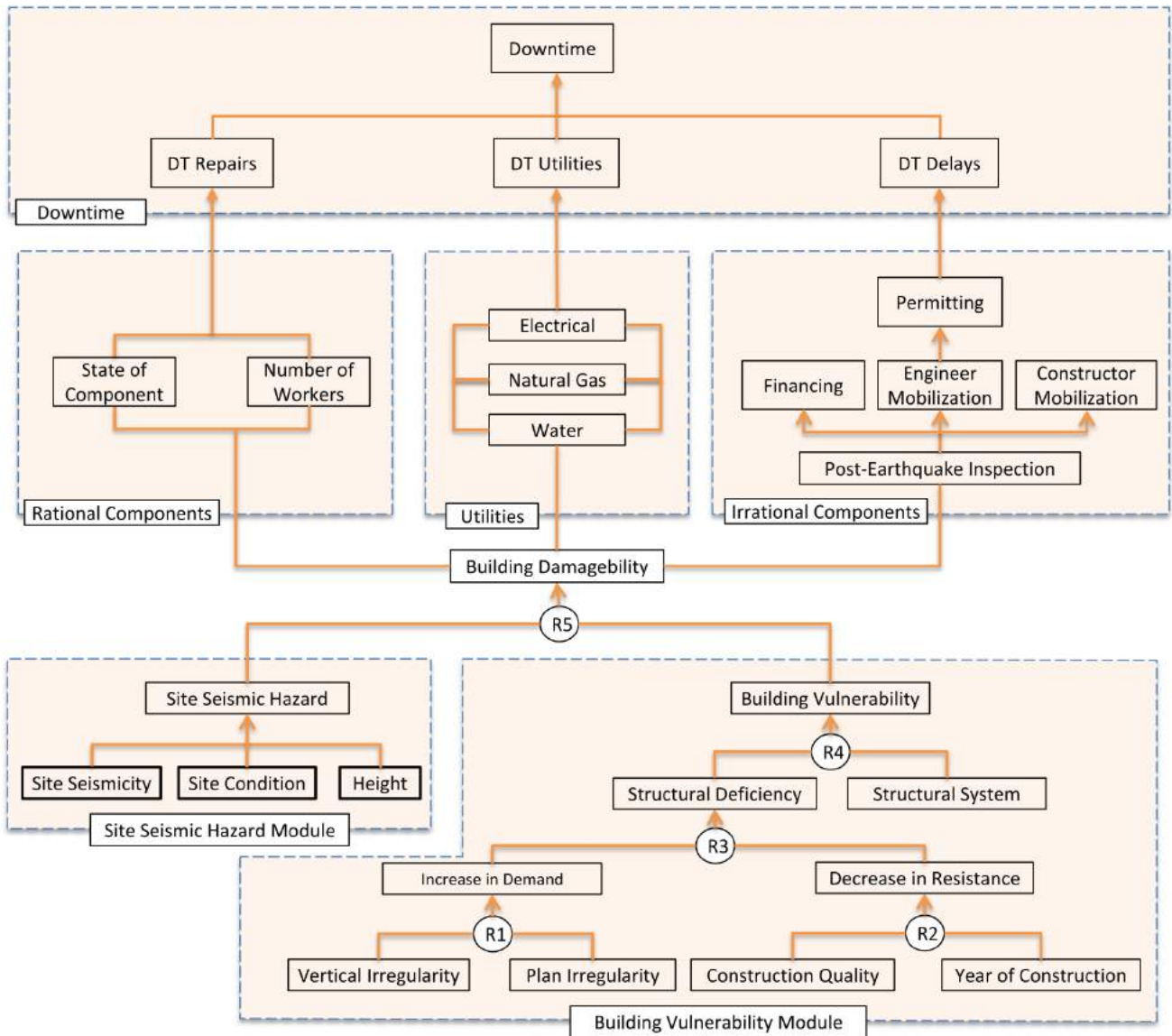

Fig. 3. Hierarchical downtime assessment of buildings

3.1. Building damage estimation

The building damage is estimated through a hierarchical scheme that includes all variables contributing to the building damage (Fig. 3). The proposed hierarchical scheme for the building damageability is an adaptation from Tesfamariam and Saatcioglu [32], in which aggregation of the variables is done through the fuzzy model introduced before, and the granularity assigned to the fuzzification is associated with the level of damage state. Furthermore, a heuristic model to assign membership values starting from linguistic information is employed in this paper. This model can generate membership functions using human intelligence and understanding. The membership functions considered in the methodology are those introduced by Tesfamariam and Saatcioglu [32], which are based on triangular fuzzy numbers (TFNs) and range between 0 and 1. Triangular fuzzy memberships present overlapping areas and ranges that are calibrated and adjusted to reflect a prevalent condition. That is, in this work, after testing input data, they are calibrated in

order to have a *low* and *medium* Building Damage. Further information is provided in [42]. The weighting method introduced before is used to define the fuzzy rules and to connect the inputs and the outputs of the system. Finally, at each level of the hierarchical scheme, the weighted average method is used for the defuzzification to obtain an index I , as follows:

$I = \sum_{i=1}^n q_i * \mu_{R,i}$	(5)
------------------------------------	-----

where q_i is the quality-ordered weights, $\mu_{R,i}$ is the degree of membership, i is the tuple fuzzy set. The quality-ordered weights used in the methodology are established through calibration based on the 1991 Northridge Earthquake observed damages [32]. In the weighted average method, each membership function is weighted with respect to its maximum membership value. It is used in this work because it is the most accurate method for symmetrical membership functions.

For the Building Damageability, defuzzification is not required. Each damage membership grade that is greater than zero is used independently in the downtime analysis. The resulting downtimes corresponding to the different memberships are combined to obtain a final downtime value, as described before. According to the logical path proposed in the hierarchical scheme, the Building Damageability index (I^{BD}) is computed by integrating Site Seismic Hazard (SSH) and Building Vulnerability (BV). Building Vulnerability index (I^{BV}) is obtained through the integration of the two components: Structural Deficiency (SD) and Structural System (SS). On the other hand, the Site Seismic Hazard index (I^{SH}) is computed by combining the earthquake source conditions, source-to-site transmission path properties, and site conditions. I^{SH} is expressed in terms of building response acceleration, which can be obtained as a function of the building fundamental period (T).

Structural Deficiency can be divided into two categories [43]: factors contributing to an increase in seismic demand (Decrease in Demand) and factors contributing to a reduction in ductility and energy absorption (Decrease in Resistance). Parameters that contribute to the decrease in resistance are Construction Quality (CQ) and Year of Construction (YC). In general, the year of construction can be classified into three distinct states [44]: low code ($YC \leq 1941$), moderate code ($1941 \leq YC \leq 1975$), and high code ($YC \geq 1975$). These threshold values are derived from the North America practice. On the other hand, parameters that contribute to the increase in seismic demand are Vertical Irregularity (VI) and Plan Irregularities (PI).

Three reinforced concrete building types are identified for the evaluation of the Structural System component (SS): moment resisting frames (C1), moment resisting frames with infill masonry walls (C2) and shear wall (C3). The granulation assigned to each parameter is shown in Fig. 4. The Fuzzy rules assigned to each parameter are listed in Table 1, Table 2, Table 3, Table 4, and Table 5.

601
602
603
604
605
606
607
608
609
610
611
612
613
614
615
616
617
618
619
620
621
622
623
624
625
626
627
628
629
630
631
632
633
634
635
636
637
638
639
640
641
642
643
644
645
646
647
648
649
650
651
652
653
654
655
656
657
658
659
660

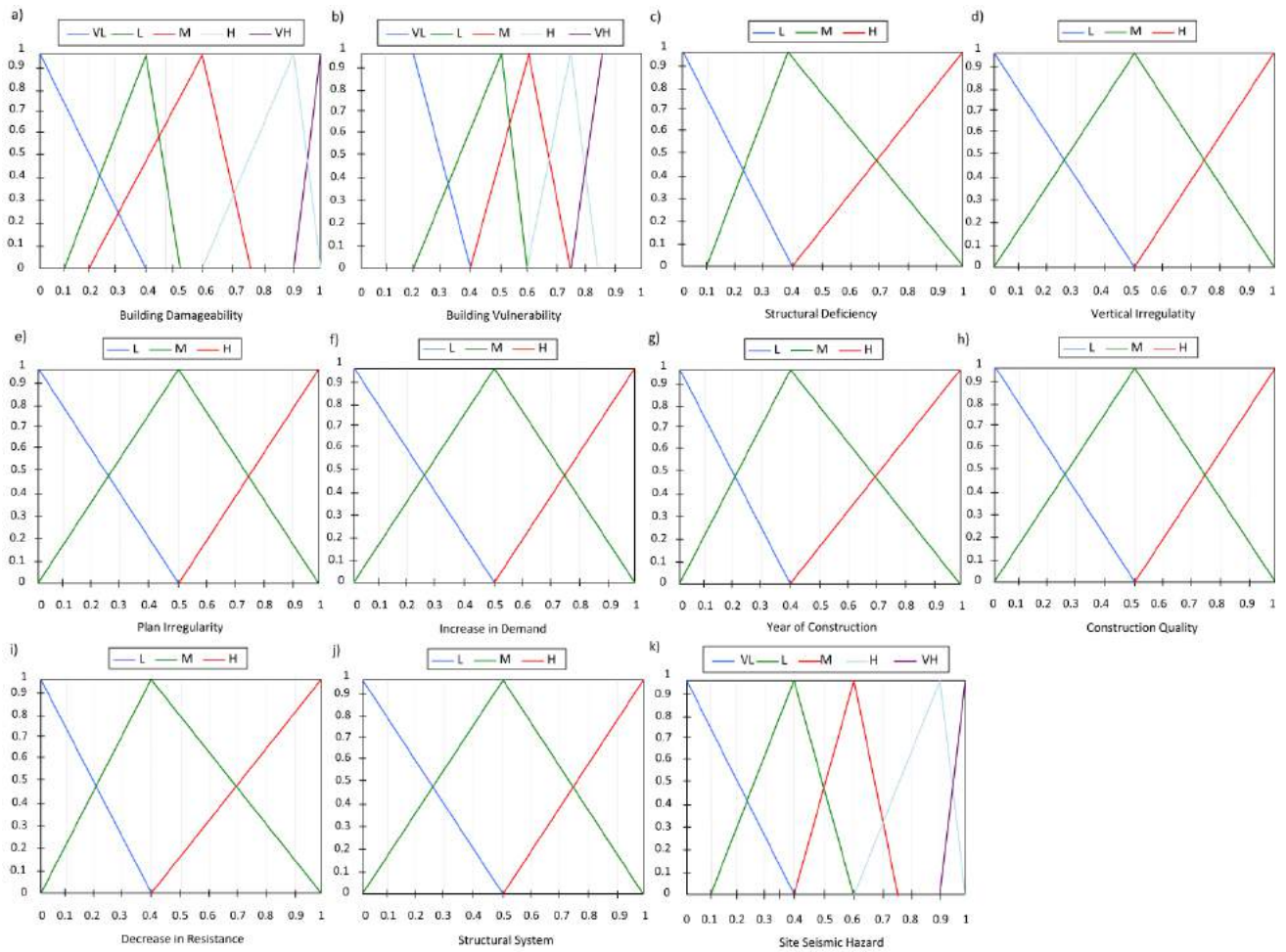

Fig. 4. Membership functions and granulation for: a) Building Damageability; b) Building Vulnerability; c) Structural Deficiency; d) Vertical Irregularity; e) Plan Irregularity; f) Increase in Demand; g) Year of Construction; h) Construction Quality; i) Decrease in Resistance; j) Structural System; k) Site Seismic Hazard

Table 1. Fuzzy rules for Building Damageability

Rule	SSH $W=2$	BV $W=1$	BD
1	VL	VL	VL
2	VL	L	VL
3	VL	M	L
4	VL	H	L
5	VL	VH	L
6	L	VL	L
7	L	L	L
8	L	M	L
9	L	H	M
10	L	VH	M
11	M	VL	L
12	M	L	M
13	M	M	M
14	M	H	M
15	M	VH	H

661
662
663
664
665
666
667
668
669
670
671
672
673
674
675
676
677
678
679
680
681
682
683
684
685
686
687
688
689
690
691
692
693
694
695
696
697
698
699
700
701
702
703
704
705
706
707
708
709
710
711
712
713
714
715
716
717
718
719
720

16	H	VL	M
17	H	L	M
18	H	M	H
19	H	H	H
20	H	VH	H
21	VH	VL	H
22	VH	L	H
23	VH	M	H
24	VH	H	VH
25	VH	VH	VH

Table 2. Fuzzy rules for Building Vulnerability

<i>Rule</i>	<i>SD</i> <i>W=2</i>	<i>SS</i> <i>W=1</i>	<i>BV</i>
1	L	L	L
2	L	M	L
3	L	H	M
4	M	L	M
5	M	M	M
6	M	H	M
7	H	L	M
8	H	M	H
9	H	H	H

Table 3. Fuzzy rule for Increase in Demand

<i>Rule</i>	<i>VI</i> <i>W=2</i>	<i>PI</i> <i>W=1</i>	<i>ID</i>
1	L	L	L
2	L	M	L
3	L	H	M
4	M	L	M
5	M	M	M
6	M	H	M
7	H	L	M
8	H	M	H
9	H	H	H

721
722
723
724
725
726
727
728
729
730
731
732
733
734
735
736
737
738
739
740
741
742
743
744
745
746
747
748
749
750
751
752
753
754
755
756
757
758
759
760
761
762
763
764
765
766
767
768
769
770
771
772
773
774
775
776
777
778
779
780

Table 4. Fuzzy rules for Decrease in Resistance

<i>Rule</i>	<i>CQ</i> <i>W=2</i>	<i>YC</i> <i>W=1</i>	<i>DR</i>
1	L	L	L
2	L	M	L
3	L	H	M
4	M	L	M
5	M	M	M
6	M	H	M
7	H	L	M
8	H	M	H
9	H	H	H

Table 5. Fuzzy rules for Structural Deficiency

<i>Rule</i>	<i>ID</i> <i>W=1</i>	<i>DR</i> <i>W=2</i>	<i>SD</i>
1	L	L	L
2	L	M	M
3	L	H	M
4	M	L	L
5	M	M	M
6	M	H	H
7	H	L	M
8	H	M	M
9	H	H	H

3.2. Downtime due to repairs

In general, the Downtime (*DT*) is the combination of the time required for *repairs* (*DT repairs*, rational components), *delays* (*DT delays*, irrational components), and the time of *utilities* disruption, as follows:

$$DT = \max((DT \text{ repairs} + DT \text{ delays}); DT \text{ utilities})$$

(6)

The combination of the three components depends on the chosen recovery state (i.e. re-occupancy recovery, functional recovery, and full recovery) [45]. For example, in the re-occupancy recovery state, consideration of *utilities* disruption is not required, thus the downtime is the result of the time required for *repairs* and *delays* only.

Downtime due to repairs depends on the state of the damaged components as well as on the number of workers assigned. These are the rational parameters contributing in the downtime evaluation.

781
782
329 **3.3. State of Components**
783

784
330 Component repair times are obtained from PACT, an electronic calculation tool released by FEMA [46], which
785
786
331 evaluates the repair times from consequence functions that indicate the distribution of losses as a function of damage
787
788
332 state. The distribution (and dispersion) of the potential repair time is derived from data representing the 10th, 50th, and
789
790
333 90th percentile estimates of labor effort. In this work, only data representing the 50th and 90th percentile has been used
791
334 as the 10th percentile is not desirable for downtime assessment. Once component repair times for each damage state are
792
793
335 known, the values can be used to compute the total component repair time. This is done by defuzzifying the component
794
795
336 repair times using the corresponding membership values, as follows:
796

$RT : \sum_{i=1}^n rt_i * \mu_{R,i}$	(7)
--------------------------------------	-----

799
337
800
801
338 where RT is the component total repair time, rt_i is the repair time of the component considered, i is the damage state
802
803
339 level, $\mu_{R,i}$ represents the damage membership value considered in the analysis. In this methodology, the repairs sequences
804
805
340 presented in REDi™ [28], which defines the order of repairs (Fig. 5), is used to quantify the repair time. The repairs
806
341 sequences depend on the building damage state. That is, if the building damage state is classified as *Medium*, structural
807
808
342 components can be repaired simultaneously (in parallel); if the building damage state is classified as *High* or *Very High*,
809
810
343 structural repairs are done for one floor at a time (in series). The difference in repair time estimates for a parallel vs.
811
344 series assumption can be significant. For instance, the parallel scheme estimates may be in the order of months, and the
812
813
345 series repair scheme estimates may be in the order of years, depending on the number of floors in the building.
814

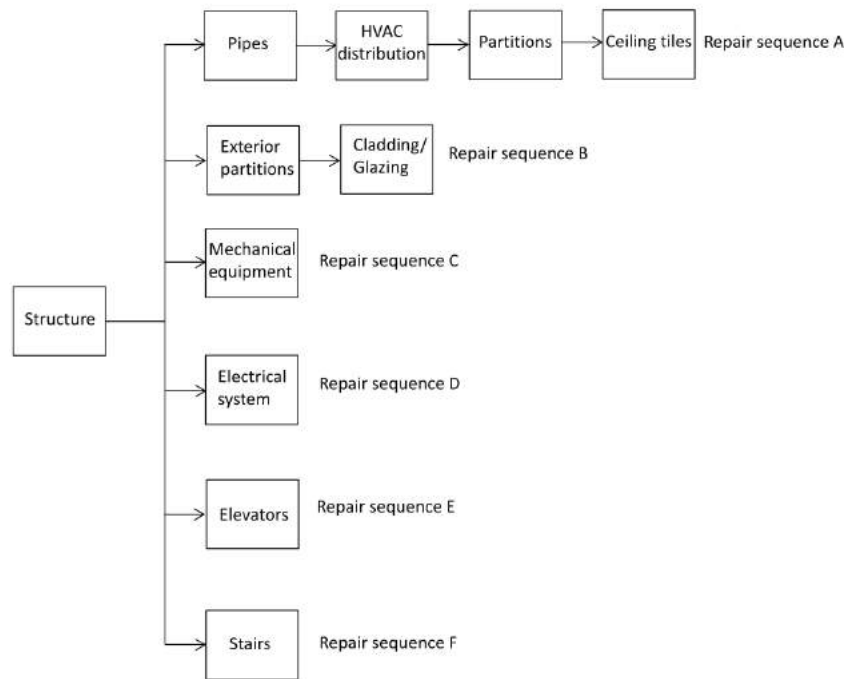

834
835
836
347 Fig. 5. Repair sequence from REDi™
837
838
839
840

841
842 **3.4. Number of workers**
843

844 Depending on the crew number, repairs can be carried faster or slower. FEMA P-58 indicates that the maximum
845
846 number of workers per sq. ft. ranges from 1 worker per 250 sq. ft. to 1 worker per 2000 sq. ft. [27]. Following the
847
848 REDI™ instructions, repairs for structural components have a labor allocation limitation of 1 worker per 500 sq. ft per
849
850 floor. For non-structural repairs, REDI™ recommends using 1 worker per 1000 sq. ft.

851 Equation (7) computes the maximum number of workers for structural repairs in a building for a gross area:
852

$N_{\max} = 2.5 \times 10^{-4} A_{\text{tot}} + 10$	(8)
---	-----

853
854
855 where N_{\max} is the maximum number of workers on site, A_{tot} is the total floor area of the building (sq. ft.).
856
857

858
859 **3.5. Downtime due to delays**
860

861 There are several causes of delay that can increase the time required to achieve a recovery state. Downtime due to
862
863 delays is derived from irrational components introduced by Comerio [24] (Fig. 3). The irrational components used in the
864
865 methodology are a selection from the components presented in REDI™: Financing, Post-earthquake inspection, Engineer
866
867 mobilization, Contractor mobilization, and Permitting.

868 Downtime due to delays is largely based on the building damage. For instance, in buildings where the expected
869
870 damage state is *Low*, less downtime due to delays is likely to occur. In the following, irrational components are
871
872 examined.
873

874 **3.5.1. Financing**
875
876

877 The time required to obtain financing is considered as a significant delay in the recovery process. The degree of delay
878
879 due to financing depends on the financing method: private loans, Small Business Administration (SBA), insurance, or
880
881 pre-arranged credit line. Delays due to financing need to be considered in case the building damage state is greater than
882
883 or equal to *High*.
884

885 **3.5.2. Post-earthquake inspection**
886
887

888 After an earthquake event, official inspectors are often required to inspect the potentially damaged buildings. Delays
889
890 due to post-earthquake inspection depend basically on the building use. For instance, if the building is an essential
891
892 facility, inspectors are expected to arrive earlier due to the importance of the building in the community. In addition, it is
893
894 possible to sign up for programs such as the Building Occupancy Resumption Program (BORP) [47], which can reduce
895
896
897
898
899
900

901
902 374 downtime significantly. Delays due to post-earthquake inspection are considered for every recovery state if the building
903
904 375 damage state is higher than *Medium*. Otherwise they are not included as there would be no structural damage.
905

906 907 376 **3.5.3. Engineer mobilization**

908
909
910 377 Delay due to engineer mobilization is mostly the time required for finding engineers plus the time needed to carry out
911 378 engineering review and/or re-design. Such delay is considered in the analysis if the building damage state is *Medium* or
912
913 379 *High*.

914 915 916 380 **3.5.4. Contractor mobilization**

917
918 381 Delays due to contractor mobilization are obtained from FEMA. Their consideration depends on the building damage
919
920 382 state in each recovery state: *High* in re-occupancy, *Medium* in functional recovery, and *Low* in full recovery state.
921

922 923 383 **3.5.5. Permitting**

924
925 384 Delays due to permitting consider the time needed for the local building jurisdiction to review and approve the
926
927 385 proposed repairs. It is necessary to include delays due to permitting if the building damage state is *High* and/or *Medium*.
928
929

930 386 **3.6. Downtime due to utilities disruption**

931
932 387 Utilities are likely to be disrupted after an earthquake event of certain intensity. Since utility service is required for
933
934 388 functional and full recovery, delays due to utility disruption need to be considered for those recovery states.

935 389 There are several challenges that make the prediction of utilities downtime difficult to achieve. For example, the
936
937 390 utility systems are widely distributed geographically, so the systems endure a wide range of seismic intensities and local
938
939 391 site effects. Utilities disruption times are defined from data about past earthquakes. Restoration fragility curves developed
940
941 392 by Kammouh and Cimellaro [48] can be used to determine the restoration time for the different utilities. In their work,
942
943 393 they have introduced an empirical probabilistic model to estimate the downtime of the lifelines following an earthquake
944 394 [48; 49] Different restoration functions were derived for different earthquake magnitudes using a large earthquake
945
946 395 database that contains data on the downtime of the infrastructures. The functions were presented in terms of probability
947
948 396 of recovery versus time. The downtime corresponding to 95% of exceedance probability of recovery is used as a
949
950 397 deterministic downtime for the considered infrastructure.

951 398 Generally, the disruption of utilities should be considered only in *functional* and *full recovery* states when the
952
953 399 maximum membership value of the site seismic hazard is greater than or equal to *Medium* ([50-52]).

954
955 400 In this work, we consider three utility systems:
956
957
958
959
960

3.6.1. Utilities disruption

In general, electricity systems recover quickly, ranging between 2 and 14 days for a full recovery, and they perform better than other utility systems because of their high level of redundancy.

Natural gas systems tend to require a longer time for restoration (from 7 to 84 days for full restoration of service). The major cause of disruption for most earthquakes is re-lighting and re-pressurizing the gas services to individual buildings after the gas shut off for safety purpose.

Water system disruption time is usually extensive in all earthquakes, ranging from 6 days to 10 weeks for full restoration. The methodology used for determining the water disruption time follows the same criteria of natural gas disruption.

4. Illustrative example

In this section, the proposed downtime estimation method is illustrated through a case study. The case study consists of a three-story residential building with floor area $A = 4800$ sq. ft. per floor, structural system $SS = C1$, and a fundamental period $T_1 = 0.38s$. The 1994 Northridge Earthquake has been selected as the hazard event. From the RVS, information about the analyzed building has been collected and presented in Table 6. In addition, from the response spectrum of the 1994 Northridge Earthquake, the spectral acceleration S_a has been identified as 0.50g. In the following, the downtime estimation procedure is illustrated in detail.

4.1. Damage estimation

Transformation: the first step is to transform the basic risk items into comparable numbers, which are mainly based on expert knowledge. In particular, the transformation values for VI, PI and, CQ are calibrated for the 1994 Northridge Earthquake damage database [32]. The transformation values are listed in Table 6.

Table 6. Basic risk items and transformation

Basik risk item	Field observation	Transfomation
Structural system (SS)	Moment resisting frames C(1)	0.70
Vertical irregularity (VI)	Yes	0.80
Plan irregularity (PI)	Yes	0.80
Contruction quality (CQ)	Poor	0.99
Year of construction (YC)	1960	$-0,01*YC+20,25$

Fuzzification: fuzzifying the transformed values with respect of their granulation. That is, after selecting a transformation value for each parameter, one can enter the corresponding graph in Fig. 4 and obtain the degree of membership for each parameter. The results are presented in Table 7.

Table 7. Fuzzification process

Basic risk items	Fuzzification
Vertical irregularity	$(\mu_L^{VI}, \mu_M^{VI}, \mu_H^{VI}) = (0, 0.40, 0.60)$
Plan irregularity	$(\mu_L^{VI}, \mu_M^{VI}, \mu_H^{VI}) = (0, 0.40, 0.60)$
Construction quality	$(\mu_L^{CQ}, \mu_M^{CQ}, \mu_H^{CQ}) = (0, 0.01, 0.99)$
Year of construction	$(\mu_L^{YQ}, \mu_M^{YQ}, \mu_H^{YQ}) = (0, 0.60, 0.40)$
Structural system	$(\mu_L^{SS}, \mu_M^{SS}, \mu_H^{SS}) = (0, 0.50, 0.50)$
Site seismic hazard	$(\mu_{VL}^{SSH}, \mu_L^{SSH}, \mu_M^{SSH}, \mu_H^{SSH}, \mu_{VH}^{SSH}) = (0, 0.50, 0.50, 0, 0)$

Inference: Mamdani's inference system is performed through the hierarchical scheme in Fig. 3. It is implemented starting with R_1 and R_2 till R_5 . An example of inference for the Increase-in-Demand index (I^{ID}) is given in this section. The inference of other indices is done in a similar fashion.

As mentioned before, the *Increase in demand* index (I^{ID}) is the combination of vertical and plan irregularities. Using the fuzzy rule base, I^{ID} is computed to be:

$\mu_L^{ID} = \max(\min(0, 0), \min(0, 0.40)) = 0$	(9)
$ID = \mu_M^{ID} = \max(\min(0, 0.60), \min(0.40, 0), \min(0.40, 0.40), \min(0.40, 0.60), \min(0.60, 0)) = 0.4$	
$\mu_H^{ID} = \max(\min(0.60, 0.40), \min(0.60, 0.60)) = 0.60$	

Defuzzification: using the previously mentioned quality-ordered weights factors, $q_i (i=1,2,3) = [0.25, 0.5, 1]$, the I^{ID} is defuzzified as follows:

$ID = \sum_{i=1}^n q_i \cdot \mu_i = 0.25 \times 0 + 0.5 \times 0.4 + 1 \times 0.6 = 0.80$	(10)
--	------

Defuzzification of other indexes is given in Table 8.

Table 8. Defuzzification process

Index	Inference/Aggregation	Defuzzification
I^{DR}	(R2)= YC + CQ	0.77
I^{SD}	(R3)= $I^{ID} + I^{DR}$	0.63
I^{BV}	(R4)= $I^{SD} + I^{SS}$	0.54

For the building damageability index (I^{BD}), defuzzification is not performed because the membership values are used in the subsequent analysis (i.e., components repair time evaluation), as we mentioned before. The membership of I^{BD} is

given through inferencing the *Site seismic hazard* index (I^{SSH}) and the *Building vulnerability* index (I^{BV}) as $(\mu_{VL}^{BD}, \mu_L^{BD}, \mu_M^{BD}, \mu_H^{BD}, \mu_{VH}^{BD}) = (0, 0.35, 0.65, 0, 0)$. Since the memberships that are greater than zero are associated with μ_L^{BD} (0.35) and μ_M^{BD} (0.65), the downtime analysis for $I^{BD} = Low$ and $I^{BD} = Medium$ is carried out. According to the membership degree results, the downtime is quantified for re-occupancy recovery state.

To build the fuzzy logic system, Simulink® software has been used. Simulink® is a block diagram environment for multi domain simulation. It is integrated with MATLAB® and simulates a fuzzy inference system with the use of a graphical editor [53]. Simulink® represents a system as a collection of blocks, which are used for modeling, simulating or testing some systems. Fig. 6 shows the case study model, in which the blocks used are: sources (provide an input), Fuzzy Logic Controller (evaluates the Fuzzy Inference System (FIS) for a given set of inputs and generates the corresponding output), Bus creator (creates a signal from its inputs), and Display (provides a numeric output). After modeling each level of the system and ensuring that the combination between each block is correct, Simulink® model is then run through the Run tool in order to obtain the Building Damageability index. The I^{BD} index (0.46) evaluated through the Simulink implementation

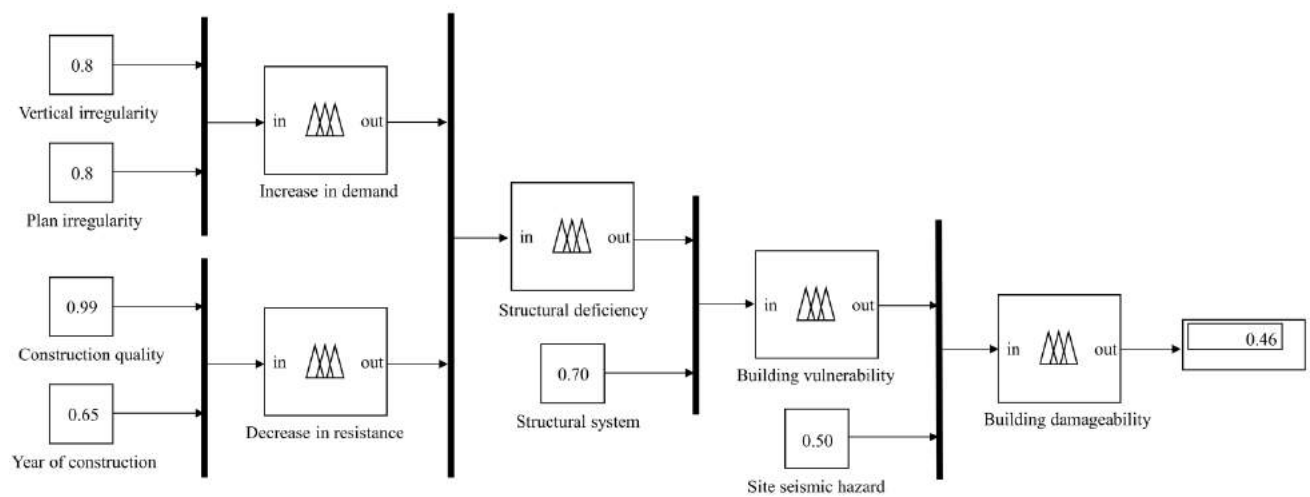

Fig. 6) is fuzzified in order to obtain the building damage membership using the corresponding membership function in Fig. 4.

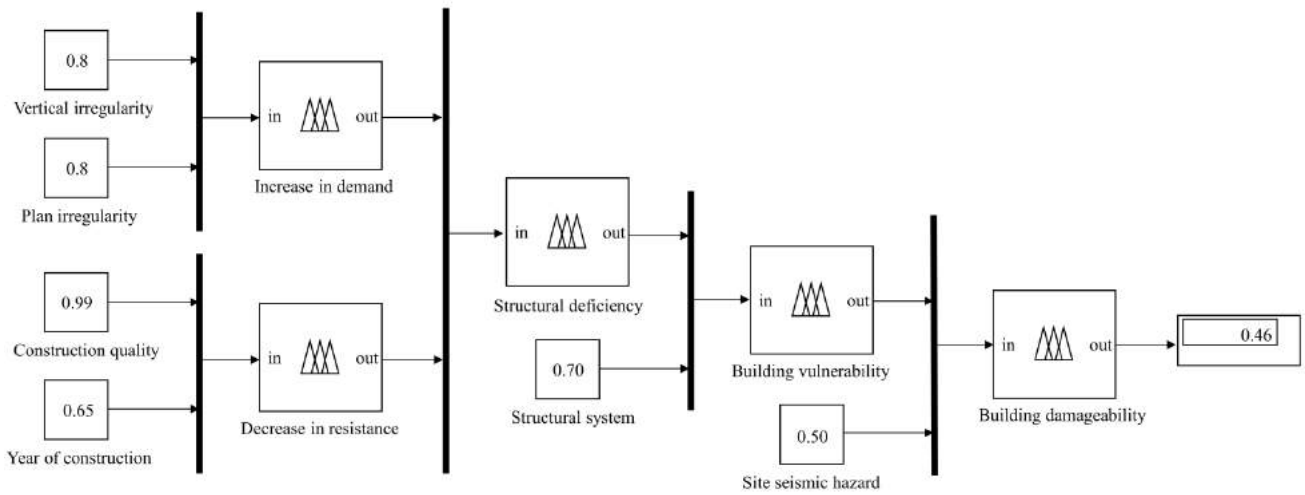

Fig. 6. Simulink implementation

4.2. Downtime due to repairs

In this example, the main interest is in calculating the ‘best-estimate’ repair times, so the median values (50th percentile, 50% probability of non-exceedance) are used. PACT provides the necessary repair time for each type of damaged component in terms of ‘worker-days’. The process for obtaining this information is presented in Table 9 and Table 10, where repair times for building components related to *Low* and *Medium* damage state, organized by repair sequence, are summarized. The number of ‘worker-days’ of each component is computed by multiplying the unitary worker-days value by the corresponding number of units (EA, units) or area (SF, square feet), whichever relevant. Once the ‘Worker-days’ outputs are known, the values are defuzzified with the corresponding membership degrees of the building damage state (in this case study 0.35 and 0.65), using Eq. (7).

Table 9. Component repair times and worker days for *Low damage*

Floor	Repair	Component type	Worker-days per unit or area	EA or SF	Total worker-days	Defuzzification
Floor 1	Structural repairs	Concrete beam	22.758	2 units	45.5	15.93
		Link beams < 16"	17.358	1 units	17.358	6.08
	Repair sequence A	Interior partitions	5	215.3sq.ft	1076.4	376.74
		Ceiling	17	30sq.ft	510	178.50
	Repair sequence B	Exterior partitions	32	20sq.ft	640	224
	Repair sequence D	Transformer < 100 kVA	1.818	1 unit	1.818	0.64
	Low voltage switchgear	2.226	1 unit	2.226	0.78	
	Repair sequence F	Stairs	13.965	4 units	55.86	19.55
Floor 2	Structural repairs	Concrete beam	22.758	1 unit	22.758	7.97
		Link beams < 16"	17.358	1 unit	17.358	6.08
	Repair	Interior partitions	5	220sq.ft	1100	385

1201
1202
1203
1204
1205
1206
1207
1208
1209
1210
1211
1212
1213
1214
1215
1216
1217
1218
1219
1220
1221
1222
1223
1224
1225
1226
1227
1228
1229
1230
1231
1232
1233
1234
1235
1236
1237
1238
1239
1240
1241
1242
1243
1244
1245
1246
1247
1248
1249
1250
1251
1252
1253
1254
1255
1256
1257
1258
1259
1260

	sequence A	Ceiling	17	10sq.ft	170	59.5
	Repair sequence B	Exterior partitions	32	5sq.ft	160	56
	Repair sequence D	Transformer < 100 kVA	1.818	1 unit	1.818	0.64
		Low voltage switchgear	2.226	1 unit	2.226	0.78
	Repair sequence F	Stairs	13.965	4 units	55.86	19.55
Floor 3	Structural repairs	Concrete beam	22.758	3 units	68.27	23.89
	Repair sequence A	Interior partitions	5	190sq.ft	950	332.5
		Ceiling	17	15sq.ft	255	89.25
	Repair sequence D	Transformer < 100 kVA	1.818	1 unit	1.818	0.64
		Low voltage switchgear	2.226	1 unit	2.226	0.78
	Repair sequence F	Stairs	13.965	4 units	55.86	19.55
Roof	Repair sequence C	Chiller	11.088	1 unit	11.088	3.88

Table 10. Component repair times and worker days for *Medium* damage

Floor	Repair	Component type	Worker-days per unit or area	EA or SF	Total worker-days	Defuzzification
Floor 1	Structural repairs	Concrete beam	22.758	2 units	45.5	29.58
		Link beams < 16"	17.358	1 unit	17.358	11.28
	Repair sequence A	Interior partitions	5	215.3sq.ft	1076.4	699.66
		Ceiling	17	30sq.ft	510	331.50
	Repair sequence B	Exterior partitions	32	20sq.ft	640	416
	Repair sequence D	Transformer < 100 kVA	1.818	1 unit	1.818	1.18
		Low voltage switchgear	2.226	1 unit	2.226	1.45
	Repair sequence F	Stairs	13.965	4 units	55.86	36.31
Floor 2	Structural repairs	Concrete beam	22.758	1 unit	22.758	14.79
		Link beams < 16"	17.358	1 unit	17.358	11.28
	Repair sequence A	Interior partitions	5	220sq.ft	1100	715
		Ceiling	17	10sq.ft	170	110.5
	Repair sequence B	Exterior partitions	32	5sq.ft	160	104
	Repair sequence D	Transformer < 100 kVA	1.818	1 unit	1.818	1.18
		Low voltage switchgear	2.226	1 unit	2.226	1.45
	Repair sequence F	Stairs	13.965	4 units	55.86	36.31
Floor 3	Structural repairs	Concrete beam	22.758	3 units	68.27	44.38
	Repair sequence A	Interior partitions	5	190sq.ft	950	617.5
		Ceiling	17	15sq.ft	255	165.75
	Repair sequence D	Transformer < 100 kVA	1.818	1 unit	1.818	1.18

	Low voltage switchgear		2.226	1 unit	2.226	1.45
	Repair sequence F	Stairs	13.965	4 units	55.86	36.31
Roof	Repair sequence C	Chiller	11.088	1 unit	11.088	7.21

4.2.1. Structural repairs

Low and *Medium* building damage states implies that the structural components can be repaired in parallel.

Considering that the floor area is the same at all floors, the number of workers allocated to each floor is:

$no. \text{ of workers} = (4800 \text{ sq.ft.}) \cdot (1 \text{ worker}/(500 \text{ sq.ft})) = 10 \text{ workers}$	(11)
--	------

Equation (8) shows that the maximum number of workers that are allowed to perform structural repairs at any time is 22 workers. Thus, the number of workers computed in Eq. (11) is considered acceptable because it is less than the maximum number allowed. By summing the defuzzified outcomes (last column) corresponding to the structural components at floor 1, floor 2 and floor 3 and dividing by the number of workers defined using Eq. (11), one can obtain the days required for structural repairs: (2.2; 1.4; 2.4) days and (4; 2.6; 4.4) days for *Low* and *Medium* damage analyses, respectively. Thus, all floors can be repaired in parallel in around 2.4 days (Low damage) and 4.4 days (Medium damage.)

4.2.2. Non-structural repairs

Non-structural repairs can begin after all structural repairs are complete. Repair sequences considered in the case study are Repair Sequence A, B, C, D, and F. The repair sequences are summarized in Table 11, in which the number of workers per floor and the corresponding maximum number of workers allowed are presented.

Table 11. Number of workers for non-structural repairs

Repair Sequence	Number of workers per floor	Max number of worker per component type
Repair Sequence A	#workers = (4800sq.ft) (1worker/1000sq.ft) = 5 workers	15
Repair Sequence B	#workers = (4800sq.ft) (1worker/1000sq.ft) = 5 workers	15
Repair Sequence C	#workers = (1 damaged unit) (3 workers/damaged unit) = 3 workers	9
Repair Sequence D	#workers = (1 damaged unit) (3 workers/damaged unit) = 2 workers	9
Repair Sequence F	#workers = (4 damaged unit) (2 workers/damaged unit) = 8 workers	6

Repair sequence F has a larger number of workers per floor than the maximum allowed per Repair Sequence. Thus, the number of workers is limited to 6 workers for Repair Sequence F. The repair time for each repair sequence is

calculated by summing their respective worker-days and dividing by the number of workers assigned to that repair sequence (Table 12 and Table 13).

Table 12. Repair time for each Repair Sequence for *Low* damage

Floor 1	Repair sequence A	RT = (555.34 worker days)/5 workes = 111.05 days
	Repair sequence B	RT = (224 worker days)/5 workes = 45 days
	Repair sequence D	RT = (1.42 worker days)/2 workes = 0.71 day
	Repair sequence F	RT = (19.55 worker days)/6 workes = 2.76 days
Floor 2	Repair sequence A	RT = (444.5 worker days)/5 workes = 88.9 days
	Repair sequence B	RT = (56 worker days)/5 workes = 11.2 days
	Repair sequence D	RT = (1.42 worker days)/2 workes = 0.71 day
	Repair sequence F	RT = (19.55 worker days)/6 workes = 2.76 days
Floor 3	Repair sequence A	RT = (421.75 worker days)/5 workes = 84.4 days
	Repair sequence D	RT = (1.42 worker days)/2 workes =0.71 day
	Repair sequence F	RT = (19.55 worker days)/6 workes = 2.76 days
Roof	Repair sequence C	RT = (3.88 worker days)/3 workes = 1.3 days

Table 13. Repair time for each sequence for *Medium* damage

Floor 1	Repair sequence A	RT = (1031.16 worker days)/5 workes = 206.23 days
	Repair sequence B	RT = (416 worker days)/5 workes = 83.2 days
	Repair sequence D	RT = (2.63 worker days)/2 workes = 1.31 day
	Repair sequence F	RT = (36.31 worker days)/6 workes = 6.05 days
Floor 2	Repair sequence A	RT = (825.5 worker days)/5 workes = 165.1 days
	Repair sequence B	RT = (104 worker days)/5 workes = 20.8 days
	Repair sequence D	RT = (2.63 worker days)/2 workes = 1.31 day
	Repair sequence F	RT = (36.31 worker days)/6 workes = 6.05 days
Floor 3	Repair sequence A	RT = (783.25 worker days)/5 workes = 156.65 days
	Repair sequence D	RT = (2.64 worker days)/2 workes =1.31 day
	Repair sequence F	RT = (36.31 worker days)/6 workes = 6.05 days

Roof Repair sequence C RT = (7.21 worker days)/3 workers = 2.40 days

4.3. Downtime due to delays

The downtime analysis due to delays is carried out only for the *Medium* damage. That is, delays can increase the downtime if only the building damage is greater than *Low*. Delays considered are: post-earthquake inspection and engineer mobilization (Table 14).

Table 14. Impeding factors delays

Post-earthquake inspection		Engineer mobilization	
Building type	Delays P50	Max buil. damage	Delays P50
BORP	1 days	Medium	6 weeks

Delays due to post-earthquake hazard inspection depend basically on the building use. As mentioned before, the possibility to subscribe in a Building Occupancy Resumption Program (BORP) [47] or equivalents can reduce delay due the presence of prearrangement as there is no necessity of official city-inspectors. Repair of minor structural damage would likely require an engineer to stamp and approve the proposed repair strategy, but not necessary perform any structural calculations. This may take some time for the engineer to review the damage.

4.4. Downtime due to utilities disruption

Utilities disruption is not considered in downtime assessment for re-occupancy recovery state because this only affects building functionality.

4.5. Total repair time

As mentioned before, for the re-occupancy recovery state, downtime is computed as the sum of DT repairs and DT delays, as follows:

$DT_{(damage=Low)} = DT_{repairs} + DT_{delays} = 284.3 + 0 = 284.3 \text{ days}$	(12)
$DT_{(damage=Medium)} = DT_{repairs} + DT_{delays} = 527.98 + 43 = 571 \text{ days}$	

Once the downtimes of each damage state is obtained, the final result is computed by weighted the two downtimes using the damage membership values defined before, as follows:

$DT = \sum_{i=1}^n DT_i * \mu_i = (284.3 * 0.35) + (571 * 0.65) = 470.6 \text{ days}$	(13)
---	------

Equation (13) shows that the final downtime of the residential building is around 470.6 days. Repair schedules help identify the repairs that control the total repair time (Fig. 7 and Fig. 8). In the figures, the x-axis represents the days

needed to complete repairs, while the y-axis is the floor at which repairs are conducted. The red bar shows the required time for structural repairs, which occur in parallel in around 2.4 days (*Low damage*) and 4.4 days (*Medium damage*). After the structural repairs, non- structural repairs divided in repair sequences can begin, as it is shown from the areas that are not overlapped. It is evident that repair sequence A controls the overall repair duration. Instead, the other repair sequences can be organized in different ways with no impact on downtime [28]. Moreover, the figures show that the time for structural and non-structural repairs increases with the damage. In the repair schedule for *Medium* damage analysis, the repair times are about twice that of *Low* damage.

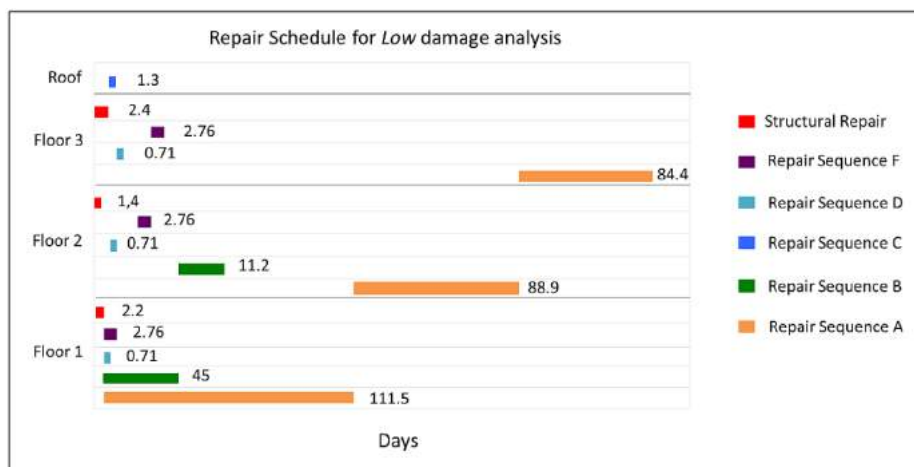

Fig. 7. Repair schedule for *Low* damage analysis

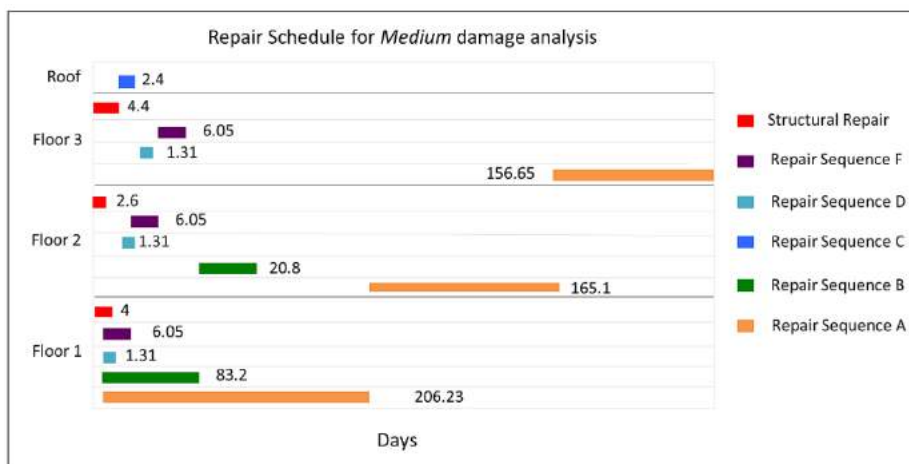

Fig. 8. Repair schedule for *Medium* damage analysis

Conclusions

This paper introduces and shows the applicability of a new methodology that quantifies the downtime of buildings

1501
1502 following an earthquake for three recovery states: re-occupancy, functional recovery, and full recovery. In the
1503 methodology, downtime is divided into three main components: downtime due to repairs, downtime due to delays, and
1504 downtime due to utilities disruption. Usually, the decision-making process for the downtime estimation is a highly
1505 uncertain procedure since it requires complex analysis of parameters that contribute to different types of uncertainties.
1506 For example, building irregularities (topography), construction quality, and the relationship between the building damage
1507 and the seismic hazard. To overcome the complexity of other existing methodologies of downtime analysis and
1508 uncertainties, the fuzzy logic is applied. Compared to the traditional probabilistic methodologies, the advantage of using
1509 the fuzzy logic in downtime analysis is that: it is simpler and faster for quick assessments and decision-making; it deals
1510 with imprecise and fuzzy data, which includes linguistic parameters, and it can provide a downtime evaluation of
1511 buildings under different hazards through a hierarchical scheme in which the parameters that influence the damage are
1512 aggregated. The hierarchical scheme provides a simple organization of the system combining specific contributors at
1513 every level of the system. The methodology can be divided in five main areas: quantification of building damage,
1514 evaluation of repairs (rational components), delays (irrational components), and utilities disruption, and measure of
1515 downtime.

1516
1517 As a case study, the proposed methodology is applied to a residential building. The results show that the total repair
1518 time is heavily influenced by non-structural components. Moreover, delays before construction, such as Financing and
1519 Engineer mobilization, contribute significantly to the total repair time after a disastrous event. That is, irrational
1520 components increase the total downtime.

1521
1522 The main limitation of this work is the availability of real database to test and verify the proposed methodology.
1523 However, this will be considered in a follow up work in the future. Further research work will also be oriented towards
1524 extending the methodology to evaluating the downtime of building structures in other countries as well as the resilience
1525 of building structures using the fuzzy logic.

1526 1527 **Acknowledgment**

1528
1529 The research leading to these results has received funding from the European Research Council under the Grant
1530 Agreement n° ERC_IDEAL RESCUE_637842 of the project IDEAL RESCUE—Integrated Design and Control of
1531 Sustainable Communities during Emergencies.

1532 1533 **References**

1534
1535 [1] G.P. Cimellaro, and D. Lopez-Garcia, Algorithm for design of controlled motion of adjacent structures, *Journal of Structural control and Health*
1536 *Monitoring* 18 (2011):140-148.

- 1562 [2] G.P. Cimellaro, T. Giovine, and D. Lopez-Garcia, Bidirectional Pushover analysis of irregular structures, *Journal of Structural Engineering, ASCE*
1563 140 (2014):04014059.
- 1564 [3] G.P. Cimellaro, O. Villa, and A. De Stefano, Serviceability of Natural Gas Distribution Networks after Earthquakes, *Journal of Earthquake and*
1565 368
1566 369 *Tsunami* 7 (2013):22.
- 1567 [4] G.P. Cimellaro, O. Villa, and M. Bruneau, Resilience-Based Design of Natural gas distribution networks, *Journal of Infrastructure Systems, ASCE*
1568 571
1569 21 (2015):05014005.
- 1570 [5] G.P. Cimellaro, C. Renschler, A.M. Reinhorn, and L. Arendt, PEOPLES: a framework for evaluating resilience, *Journal of Structural Engineering*
1571 572
1572 573 142 (2016):04016063.
- 1573 [6] M. Bruneau, S. Chang, R. Eguchi, G. Lee, T. O'Rourke, A.M. Reinhorn, M. Shinozuka, K. Tierney, W. Wallace, and D.V. Winterfelt, A framework
1574 574
1575 575 to quantitatively assess and enhance the seismic resilience of communities, *Earthquake Spectra* 19 (2003):733–752.
- 1576 [7] G.P. Cimellaro, A.M. Reinhorn, and M. Bruneau, Framework for analytical quantification of disaster resilience, *Engineering Structures* 32
1577 576
1578 577 (2010):3639-3649.
- 1579 [8] I. Wagner, and P. Breil, The role of ecohydrology in creating more resilient cities, *Ecohydrology & Hydrobiology* 13 (2013):113-134.
- 1580 [9] O. Kammouh, G. Dervishaj, and G.P. Cimellaro, Quantitative Framework to Assess Resilience and Risk at the Country Level, *ASCE-ASME Journal*
1581 579
1582 580 *of Risk and Uncertainty in Engineering Systems, Part A: Civil Engineering* 4 (2018):04017033.
- 1583 [10] O. Kammouh, G. Dervishaj, and G.P. Cimellaro, A New Resilience Rating System for Countries and States, *Procedia Engineering* 198
1584 581
1585 582 (2017):985-998.
- 1586 [11] O. Kammouh, A. Zamani-Noori, C. Renschler, and G.P. Cimellaro, Resilience Quantification of Communities Based on Peoples Framework.
1587 583
1588 584 Paper read at 16th World Conference on Earthquake Engineering (16WCEE), January 9-13, 2017, at Santiago, Chile. 2017.
- 1589 [12] O. Kammouh, A.Z. Noori, V. Taurino, S.A. Mahin, and G.P. Cimellaro, Deterministic and fuzzy-based methods to evaluate community resilience,
1590 585
1591 586 *Earthquake Engineering and Engineering Vibration* 17 (2018):261-275.
- 1592 [13] O. Kammouh, and G.P. Cimellaro, PEOPLES: a tool to measure community resilience. In *Proceedings of 2018 Structures Congress (SEI2018)*,
1593 587
1594 588 edited by J. G. Soules, Fort Worth, Texas. April 19–21, 2018: ASCE- American Society of Civil Engineering, 2018, pp. 161 - 171,
1595 589
1596 590 doi:10.1061/9780784481349.015.
- 1597 [14] O. Kammouh, A. Zamani-Noori, G.P. Cimellaro, and S.A. Mahin, Resilience Evaluation of Urban Communities Based on Peoples Framework,
1598 591
1599 592 *ASCE-ASME Journal of Risk and Uncertainty in Engineering Systems, Part A: Civil Engineering* (in press).
- 1600 [15] J.J. Liu, M. Reed, and T.A. Girard, Advancing resilience: an integrative, multi-system model of resilience, *Personality and Individual Differences*
1601 593
1602 594 111 (2017):111-118.
- 1603 [16] U. ISDR, Hyogo framework for action 2005-2015: building the resilience of nations and communities to disasters. Paper read at Extract from the
1604 595
1605 596 final report of the World Conference on Disaster Reduction (A/CONF. 206/6). 2005.
- 1606 [17] C.S. Renschler, A.E. Frazier, L.A. Arendt, G.P. Cimellaro, A.M. Reinhorn, and M. Bruneau, *A framework for defining and measuring resilience at*
1607 597
1608 598 *the community scale: The PEOPLES resilience framework*: MCEER Buffalo, 2010.
- 1609 [18] G.P. Cimellaro, D. Solari, and M. Bruneau, Physical infrastructure interdependency and regional resilience index after the 2011 Tohoku
1610 599
1611 600 earthquake in Japan, *Earthquake Eng. Struct. Dyn.* 43 (2014):1763.
- 1612 [19] G.P. Cimellaro, and D. Solari, Considerations about the optimal period range to evaluate the weight coefficient of coupled resilience index, *Eng.*
1613 601
1614 602 *Struct.* 69 (2014):12.
- 1615 [20] S.E. Chang, T. McDaniels, J. Fox, R. Dhariwal, and H. Longstaff, Toward disaster-resilient cities: characterizing resilience of infrastructure
1616 603
1617 604 systems with expert judgments, *Risk Analysis* 34 (2014):416-434.
- 1618 [21] H. Bonstrom, and R.B. Corotis, First-Order Reliability Approach to Quantify and Improve Building Portfolio Resilience, *Journal of Structural*
1619 605
1620 606 *Engineering* 142 (2016):C4014001.
- 1621 [22] G.P. Cimellaro, V. Arcidiacono, and A.M. Reinhorn, Disaster Resilience Assessment of Building and Transportation System, *Journal of*
1622 607
1623 608 *Earthquake Engineering* (2018):1-27.
- 1624 [23] G.P. Cimellaro, A. Zamani-Noori, O. Kammouh, V. Terzic, and S.A. Mahin, Resilience of Critical Structures, Infrastructure, and Communities,
1625 609
1626 610 Berkeley, California: Pacific Earthquake Engineering Research Center (PEER), 2016.
- 1627 [24] M.C. Comerio, Estimating downtime in loss modeling, *Earthquake Spectra* 22 (2006):349-365.
- 1628 [25] C.A. Kircher, R.V. Whitman, and W.T. Holmes, HAZUS earthquake loss estimation methods, *Natural Hazards Review* 7 (2006):45-59.
- 1629 [26] K.A. Porter, A.S. Kiremidjian, and J.S. LeGrue, Assembly-based vulnerability of buildings and its use in performance evaluation, *Earthquake*
1630 611
1631 612 *spectra* 17 (2001):291-312.
- 1632 [27] F.E.M.A. FEMA Seismic performance assessment of buildings, "Methodology", CA, USA: Applied Technology Council for the Federal
1633 613
1634 614 Emergency Management Agency, 2012.
- 1635 [28] I. Almufti, and M. Willford, Resilience-based earthquake design (REDi) rating system, version 1.0. Arup, 2013.
- 1636 [29] S. Tesfamariam, R. Sadiq, and H. Najjaran, Decision making under uncertainty—An example for seismic risk management, *Risk analysis* 30
1637 615
1638 616 (2010):78-94.
- 1639 [30] S. Tesfamariam, and M. Saatcioglu, Seismic vulnerability assessment of reinforced concrete buildings using hierarchical fuzzy rule base modeling,
1640 617
1641 618 *Earthquake Spectra* 26 (2010):235-256.
- 1642 [31] L.A. Zadeh, Information and control, *Fuzzy sets* 8 (1965):338-353.
- 1643 [32] S. Tesfamariam, and M. Saatcioglu, Risk-based seismic evaluation of reinforced concrete buildings, *Earthquake Spectra* 24 (2008):795-821.
- 1644 [33] L.A. Zadeh, Outline of a new approach to the analysis of complex systems and decision processes, *IEEE Transactions on Systems, Man and*
1645 619
1646 620 *Cybernetics* 1100 (1973):38-45.
- 1647 [34] J.M. Mendel, Fuzzy logic systems for engineering: a tutorial, *Proceedings of the IEEE* 83 (1995):345-377.
- 1648 [35] E.H. Mamdani, Application of fuzzy logic to approximate reasoning using linguistic synthesis. Paper read at Proceedings of the sixth international
1649 621
1650 622 symposium on Multiple-valued logic. 1976.
- 1651 [36] M.E. Uz, and M.N. Hadi, Optimal design of semi active control for adjacent buildings connected by MR damper based on integrated fuzzy logic
1652 623
1653 624 and multi-objective genetic algorithm, *Engineering Structures* 69 (2014):135-148.
- 1654 [37] M.N. Hadi, and M.E. Uz, Investigating the optimal passive and active vibration controls of adjacent buildings based on performance indices using
1655 625
1656 626 genetic algorithms, *Engineering Optimization* 47 (2015):265-286.
- 1657 [38] G. Klir, and B. Yuan, *Fuzzy sets and fuzzy logic*, Vol. 4: Prentice hall New Jersey, 1995.
- 1658 [39] FEMA, Rapid Visual Screening of Buildings for Potential Seismic Hazards (FEMA P-154): Federal Emergency Management Agency, 2015.
- 1659 [40] F.C. Hadipriono, and T.J. Ross, A rule-based fuzzy logic deduction technique for damage assessment of protective structures, *Fuzzy Sets and*
1660 627
1661 628 *Systems* 44 (1991):459-468.
- 1662 [41] S. Tesfamariam, and M. Sanchez-Silva, A model for earthquake risk management based on the life-cycle performance of structures, *Civil*
1663 629
1664 630 *Engineering and Environmental Systems* 28 (2011):261-278.
- 1665 [42] S. Tesfamariam, and M. Saatcioglu, Seismic risk assessment of RC buildings using fuzzy synthetic evaluation, *Journal of Earthquake Engineering*
1666 631
1667 632 12 (2008):1157-1184.
- 1668 [43] M. Saatcioglu, D. Mitchell, R. Tinawi, N.J. Gardner, A.G. Gillies, A. Ghobarah, D.L. Anderson, and D. Lau, The August 17, 1999, Kocaeli
1669 633
1670 634 (Turkey) earthquake damage to structures, *Canadian Journal of Civil Engineering* 28 (2001):715-737.
- 1671 [44] M. Hazus, Earthquake loss estimation methodology technical and user manual, (1999).

1621
1622
1623
1624
1625
1626
1627
1628
1629
1630
1631
1632
1633
1634
1635
1636
1637
1638
1639
1640
1641
1642
1643
1644
1645
1646
1647
1648
1649
1650
1651
1652
1653
1654
1655
1656
1657
1658
1659
1660
1661
1662
1663
1664
1665
1666
1667
1668
1669
1670
1671
1672
1673
1674
1675
1676
1677
1678
1679
1680

[45] D. Bonowitz, Resilience Criteria for Seismic Evaluation of Existing Buildings: A Proposal to Supplement ASCE 31 for Intermediate Performance Objectives. In *Improving the Seismic Performance of Existing Buildings and Other Structures*, 2010, pp. 477-488.

[46] F.E.M.A. FEMA, Seismic performance assessment of buildings, "Implementation Guide", CA, USA: Applied Technology Council for the Federal Emergency Management Agency, 2012.

[47] C. Mayes, D. Hohbach, M. Bello, M. Bittleston, S. Bono, D. Bonowitz, C. Cole, D. McCormick, E. Reis, and K. Stillwell, SEAONC Rating System for the Expected Earthquake Performance of Buildings. Paper read at SEAOC Convention Proceedings. 2011.

[48] O. Kammouh, and G.P. Cimellaro, Restoration Time of Infrastructures Following Earthquakes. Paper read at 12th International Conference on Structural Safety & Reliability (ICOSSAR 2017), at Vienna, Austria. 2017.

[49] O. Kammouh, G.P. Cimellaro, and S.A. Mahin, Downtime estimation and analysis of lifelines after an earthquake, *Engineering Structures* 173 (2018):393-403.

[50] J. Eiding, and C.A. Davis, *Recent earthquakes: implications for US water utilities*: Water Research Foundation, 2012.

[51] M. O'Rourke, and G. Ayala, Pipeline damage due to wave propagation, *Journal of Geotechnical Engineering* 119 (1993):1490-1498.

[52] M. O'Rourke, and E. Deyoe, Seismic damage to segmented buried pipe, *Earthquake Spectra* 20 (2004):1167-1183.

[53] S. Sivanandam, S. Sumathi, and S. Deepa, *Introduction to fuzzy logic using MATLAB*, Vol. 1: Springer, 2007.

[54] A.T. Council, ATC-13:Earthquake damage evaluation data for California. CA., USA., (1985).

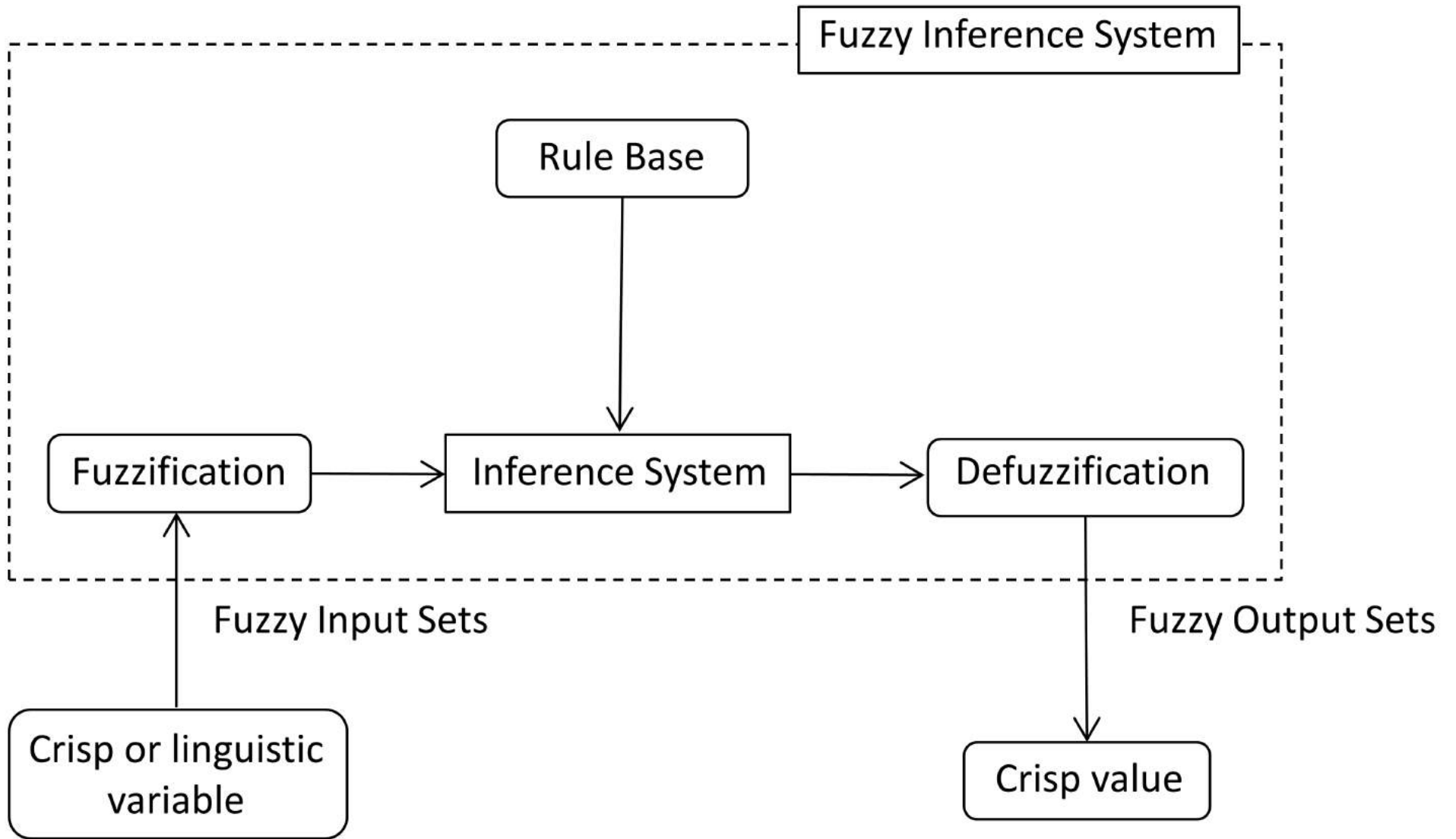

RAPID VISUAL SCREENING OF BUILDINGS

INSPECTION INFORMATION

Screener(s): _____

Date/Time: _____

BUILDING INFORMATION

State: _____

City/Town: _____

Address: _____

Zip code: _____

Latitude: _____

Longitude: _____

SKETCHES

PHOTOGRAPH

Scale: _____

BUILDING DESIGN INFORMATION

No. stories: _____ Building height (ft.): _____ Total floor area (sq. ft.): _____ Year of construction: _____

Occupancy: Assembly Commercial Emer.Services Historic **Units:** _____
 Industrial Office School Government
 Utility Warehouse Residential Shelter

Structural system: C1 C2 C3

Vertical irregularity: Yes No Plan irregularity: Yes No

Construction quality: Poor Average Good

PRE-EARTHQUAKE RECOVERY PLANNING

INFORMATION

Post earthquake inspection program: Yes No

Engineer on contract: Yes No Contractor on contract: Yes No

Type of financing:

No Pre-arranged credit line SBA-backed loans Private loan

Insurance

Comments:

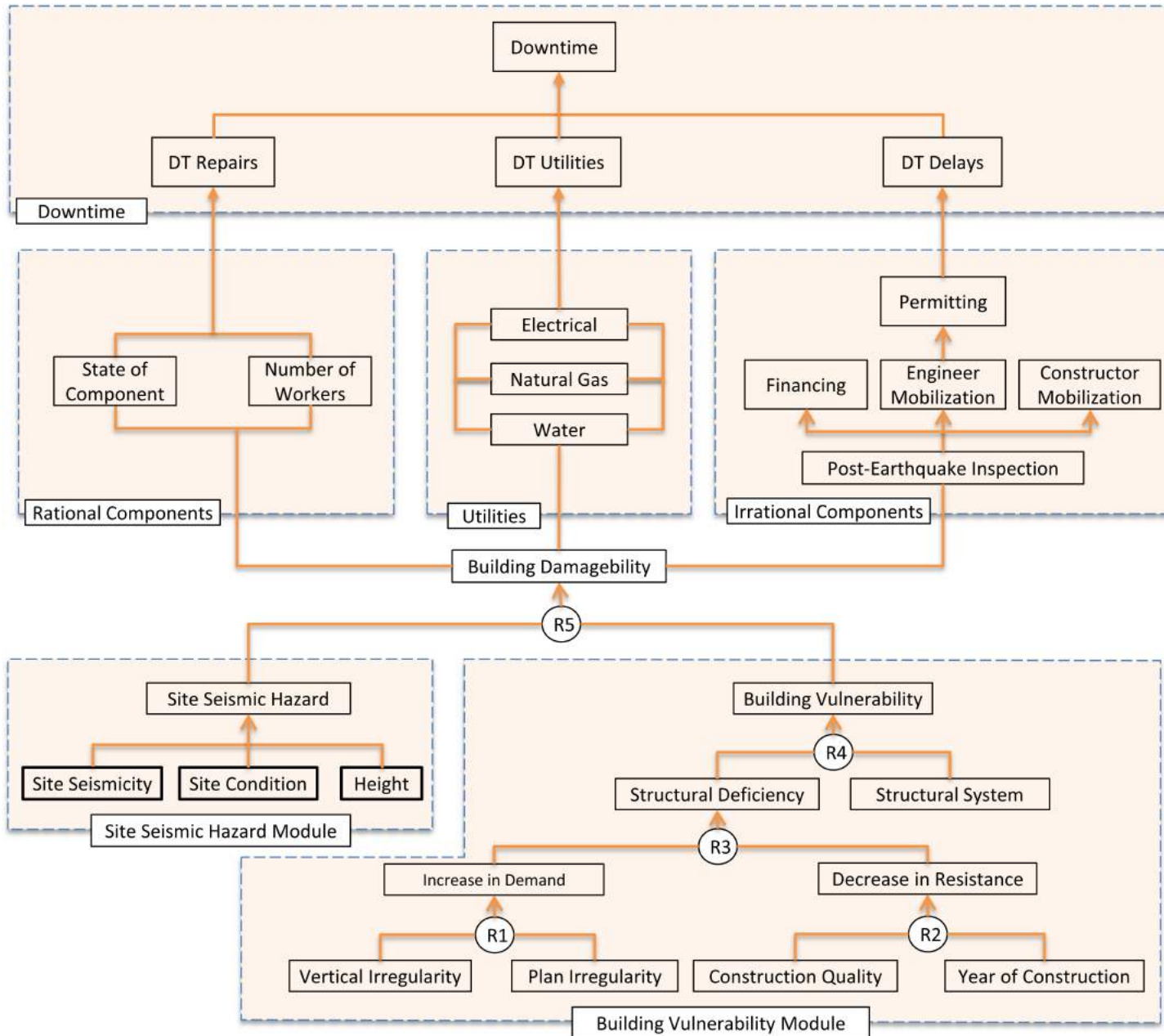

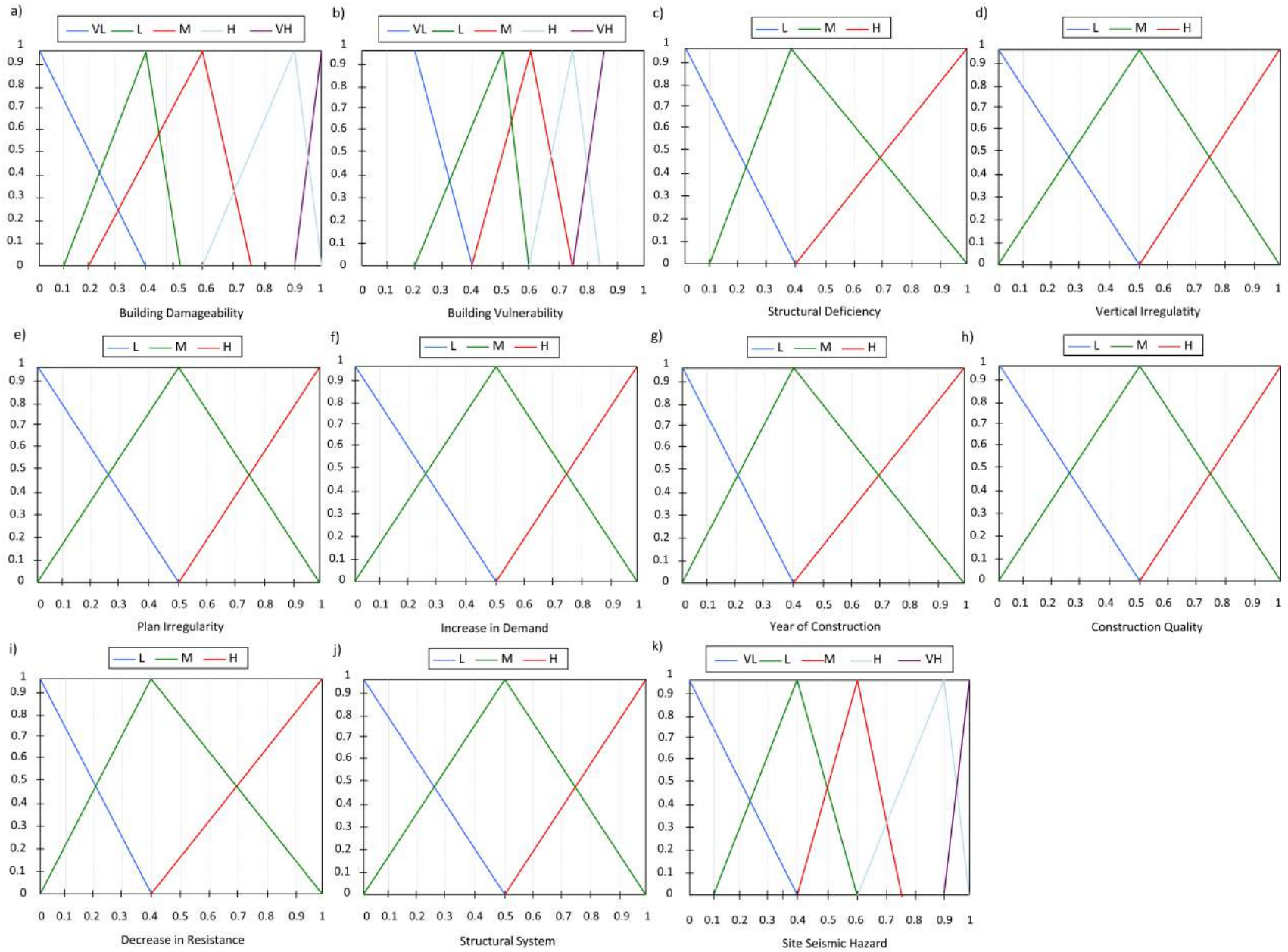

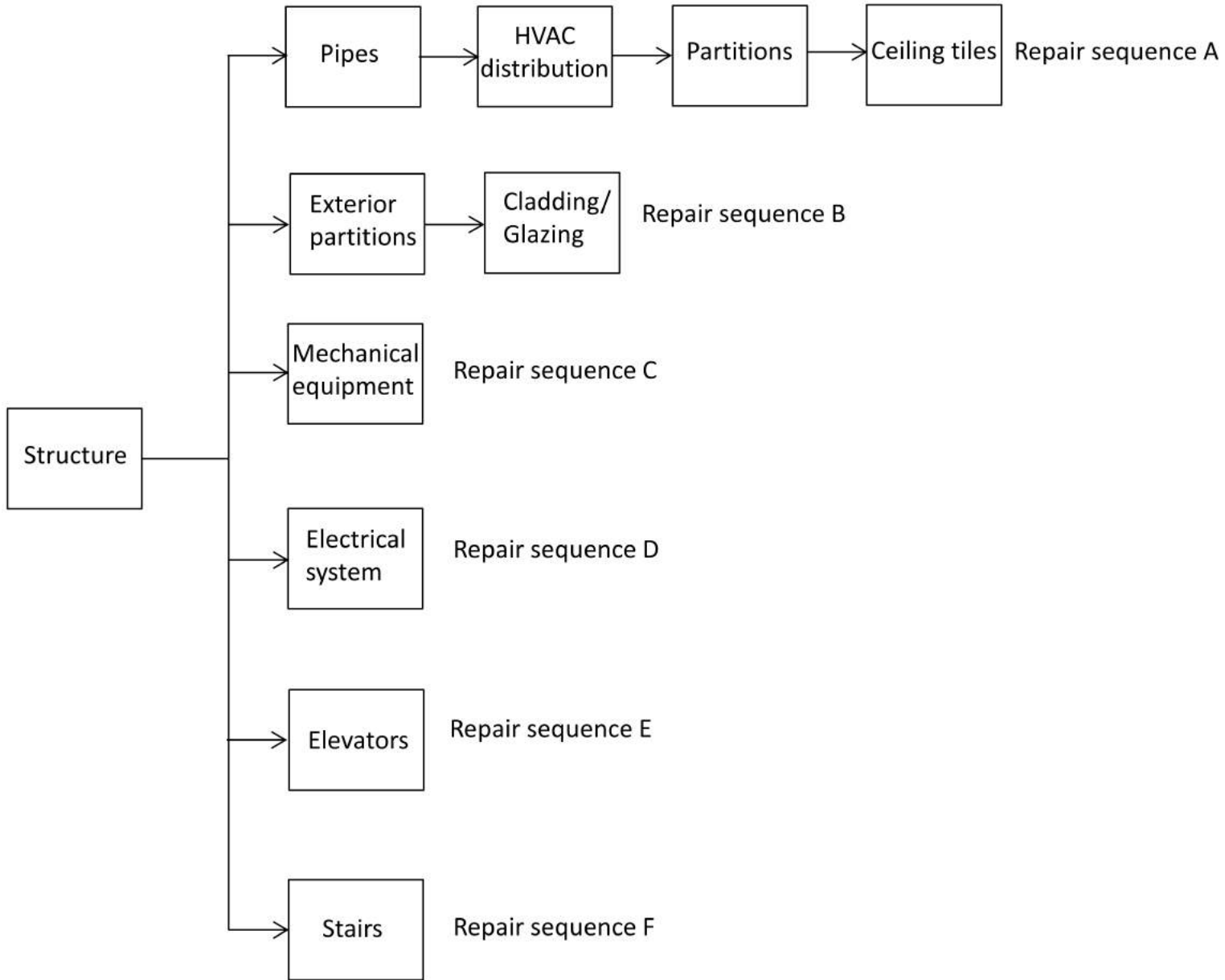

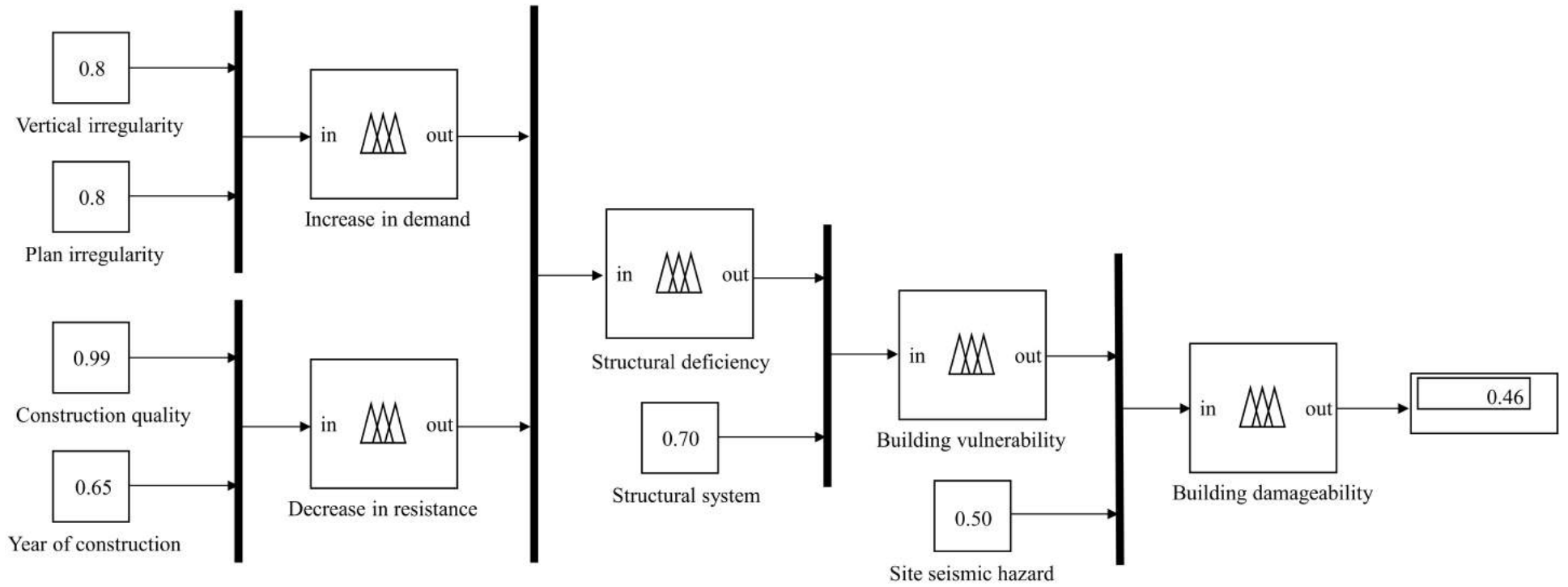

Repair Schedule for *Low* damage analysis

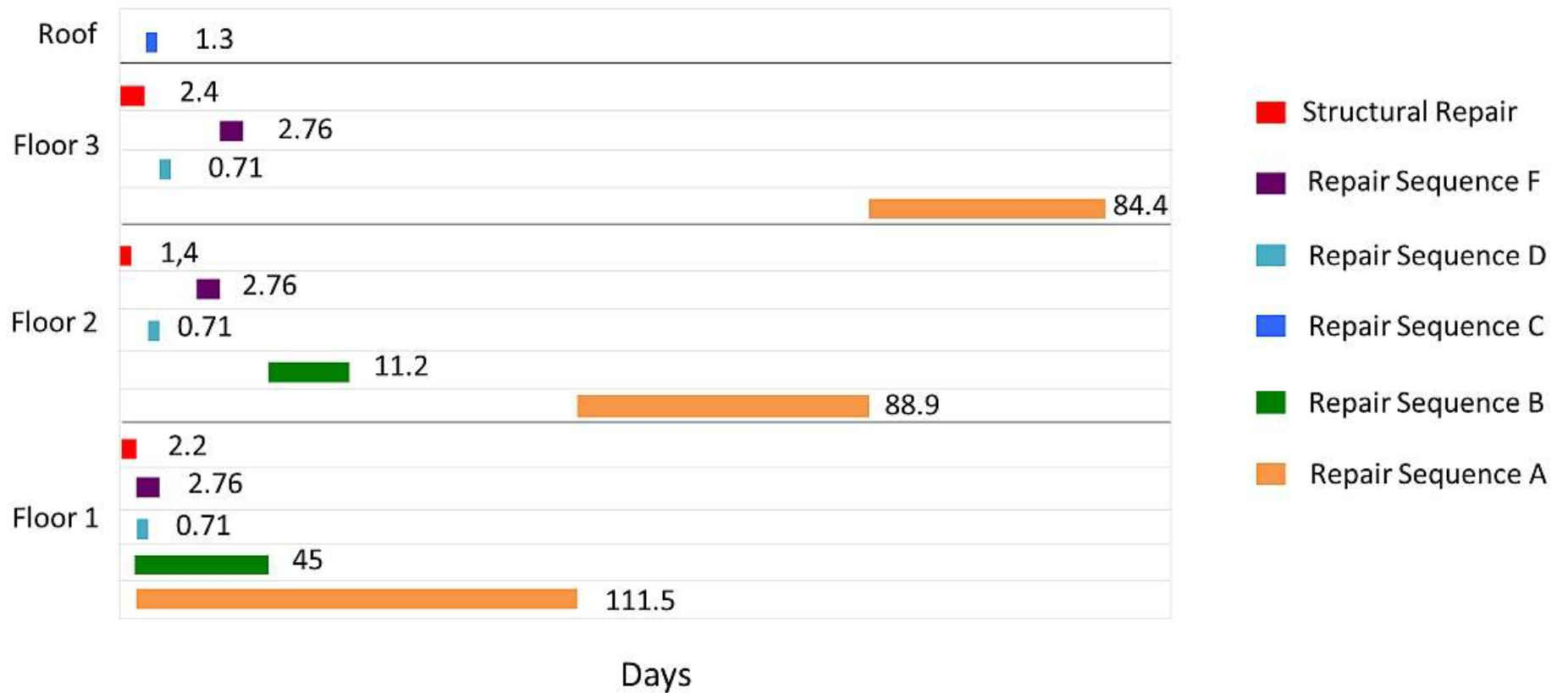

Repair Schedule for *Medium* damage analysis

