

Horizontal Air-Water Two-Phase Flow Measurement Using an Electrical Impedance Probe and a Venturi Flow Meter

Original

Horizontal Air-Water Two-Phase Flow Measurement Using an Electrical Impedance Probe and a Venturi Flow Meter / Chiesa, G; Bertani, C; Falcone, N; Bersano, A; Salve, M DE; Panella, B. - In: JOURNAL OF PHYSICS. CONFERENCE SERIES. - ISSN 1742-6588. - ELETTRONICO. - 1224:(2019), p. 012040. (Intervento presentato al convegno 36th UIT Heat Transfer Conference tenutosi a Catania, Italy nel 25–27 June 2018) [10.1088/1742-6596/1224/1/012040].

Availability:

This version is available at: 11583/2733835 since: 2019-05-21T10:46:38Z

Publisher:

IOPscience

Published

DOI:10.1088/1742-6596/1224/1/012040

Terms of use:

This article is made available under terms and conditions as specified in the corresponding bibliographic description in the repository

Publisher copyright

IOP postprint/Author's Accepted Manuscript

"This is the accepted manuscript version of an article accepted for publication in JOURNAL OF PHYSICS. CONFERENCE SERIES. IOP Publishing Ltd is not responsible for any errors or omissions in this version of the manuscript or any version derived from it. The Version of Record is available online at <http://dx.doi.org/10.1088/1742-6596/1224/1/012040>

(Article begins on next page)

PAPER • OPEN ACCESS

Horizontal Air-Water Two-Phase Flow Measurement Using an Electrical Impedance Probe and a Venturi Flow Meter

To cite this article: G Chiesa *et al* 2019 *J. Phys.: Conf. Ser.* **1224** 012040

View the [article online](#) for updates and enhancements.



IOP | ebooks™

Bringing you innovative digital publishing with leading voices to create your essential collection of books in STEM research.

Start exploring the collection - download the first chapter of every title for free.

Horizontal Air-Water Two-Phase Flow Measurement Using an Electrical Impedance Probe and a Venturi Flow Meter

G CHIESA¹, C BERTANI¹, N FALCONE¹, A BERSANO¹,
M DE SALVE¹, B PANELLA¹

¹ Energy Department
Politecnico di Torino
Corso Duca degli Abruzzi, 24, 10129 Torino (TO), Italy

E-mail: nicolo.falcone@polito.it

Abstract. Two-phase flow rate measurement is extremely important in many industrial sectors (nuclear, chemical, oil and gas, etc.). Nevertheless, the instrumentation required to perform these measurements is still very limited despite the huge research efforts during the last years. In the frame of the development of instrumentation for the two-phase flow rate measurement, the main aim of this study is the characterization of a spool piece consisting of a Venturi Flow Meter, and two Electric Capacitance Probes mounted in a horizontal test section, where an air-water two phase flow occurs. The probes response is analyzed versus superficial velocities of liquid and gas, flow patterns and void fraction. The test section consists of a nominal ID 80 mm horizontal transparent pipe equipped with a Venturi Flow Meter, a new capacitance probe with concave electrodes and a SIET designed electrical capacitance probe with ten long linear electrodes. In this experimental campaign, the air flow rate is in the range 0.048-0.119 kg/s (superficial velocity from 8 to 19 m/s) and the range of water flow rate is 0.0040-0.0535 kg/s (superficial velocity from 0.0006 m/s to 0.0103 m/s). These ranges of superficial velocities correspond to wavy stratified and annular-dispersed flow patterns along the test section.

1. Introduction

Two-phase flow rate measurement is still an open challenge that affects several industrial sectors such as the nuclear, the oil and gas, the chemical ones. Despite the abundancy of single-phase measurement devices relying on different physical principles, a universal device for two-phase flow rate measurement is still lacking. This is due to the fact that the flow is governed by several parameters (void fraction, phases velocities, etc.), which cannot be measured by a single instrument. For this reason, the development of a spool piece is under study. In general, a spool piece consists of a series of different instruments that are used to acquire various signals necessary to measure and to recognize two-phase phenomena. The spool piece under study couples a traditional flow rate measurement instrument such as a Venturi Flow Meter (VFM) with devices for the measurement of the void fraction. Several measurement techniques have been adopted to measure the void fraction (neutron radiography, gamma



rays' tomography, optical probes, etc.) but they are very expensive, bulky and, if they involve ionizing radiations, they require particular attention and safety measures [1-5].

To measure the void fraction, another possibility is to use electrical impedance or capacitance probes (ECP) such as wire mesh sensors [6] or probes with radial electrodes [7]. Such devices have been coupled to form a "spool piece" in the studies previously carried out at Dipartimento Energia (DENERG) of Politecnico of Torino (Italy)[8].

In order to perform air-water two-phase flow measurement under different flow conditions and flow patterns, the spool piece consists of impedance probes and a VFM. An ECP designed by SIET (SIET ECP) was originally used, which allowed to get information on the phases distributions inside the probe volume, but required a very complex elaboration of 10 different signals. Moreover, the SIET ECP did not provide the average void fraction in the test section. In order to obtain directly this average void fraction, two new capacitance probes with a 24-Bit Capacitance-to-Digital Converter AD7746 [9] have been developed at DENERG (DENERG ECP) and added to the spool piece.

The spool piece is mounted on a transparent experimental apparatus to allow the visual observation of the flow patterns. The final goal is to combine the signals of the two capacitance probes and the VFM to get the void fraction, the flow pattern and the flow rate, without the need of a visual observation, such as in the case of an opaque pipe.

The two-phase flow is obtained by mixing air and water, and different flow conditions can be generated by varying the flow rate of the two fluids. In the present experimental campaign, the air flow rates are in the range 0.048-0.119 kg/s (superficial velocity in the range 8-19 m/s) and water flow rate range is 0.0040-0.0535 kg/s (superficial velocity in the range 0.0006-0.0103 m/s). The resulting flow patterns can change along the horizontal pipe and they are wavy-stratified and dispersed-annular.

This paper presents the experimental apparatus, the experimental matrix, the test procedures to characterize the signals of VFM (differential pressure), and the signals of the ECP designed by SIET and of the new ECPs with 24-Bit Capacitance-to-Digital Converter AD7746.

2. Experimental apparatus and instrumentation

The experimental apparatus (Figure 1) consists of an air supply loop, a demineralized water supply loop, a test section with the Spool Piece (SP) and two pneumatic quick-closing valves for the volume-averaged void fraction measurement, a water/air separator and the instrumentation for the measurement of single-phase fluids flow rate, pressure and temperature.

The air is fed to the test section by a blower (UNIJET500), whose rotation frequency is fixed by an inverter, while the water is supplied by a tank thanks to gravity. The mixing zone of the two fluids is located a few centimeters upstream the inlet guillotine valve. The air enters axially, whereas the water is injected radially. The water mass flow rate is measured by a rotameter, while the air flow rate is measured by a calibrated orifice flow meter.

The test section has a total length of approximately 2900 mm and consists of all the components located between the guillotine quick-closing valves; it comprises a PMMA (PolyMethylMethacrylate) horizontal pipe with a nominal inner diameter of 80 mm, which allows the visualization of the flow, the SP and an outlet pipe. The spool-piece consists of a SIET ECP with nine external long linear electrodes and one internal central electrode, two new ECPs with concave electrodes, and the VFM. The SIET ECP, whose length is 390 mm, is located approximately 700 mm downstream the inlet pneumatic valve. The pipe connecting the SIET ECP to the VFM is 995 mm long and is equipped with the two DENERG ECPs. The VFM, shown in Figure 2 a), is 340 mm long with a throat diameter of 40 mm; it is a symmetric Venturi, so both sides have the same inclination (21°) [10]. The outlet pneumatic quick-closing valve is located 495 mm downstream the VFM.

The outlet pipe has the same inner diameter of the test section and is 700 mm long. Downstream the outlet pipe a tank is installed in order to separate the phases.

The test section is equipped with two pneumatic quick closing valves used to measure the average volumetric void fraction; actuating the pneumatic quick-closing valves, the liquid phase is trapped in the test section pipe and its volume can be measured by draining the trapped water. Since the pipe volume is 14.2 dm^3 , the average volumetric void fraction can be determined.

The air flow rate is measured by an orifice equipped with a differential pressure transducer, having an accuracy of 0.15% of the span; the temperatures are measured by means of thermocouples (K-type, $0.5 \text{ }^\circ\text{C}$ accuracy) at the blower outlet, at the inlet of SIET ECP, at VFM inlet and at the test section outlet. The water flow rate is measured by an ASA rotameter with an accuracy of 0.2% of the span. The VFM is instrumented with two differential pressure transducers for the measurement of the pressure drops between the inlet and the throat (reversible pressure drop; transducer accuracy 0.2% of the span) and between the inlet and the outlet (irreversible pressure drop; transducer accuracy 0.04% of the span).

The ECP designed by SIET, shown in Figure 2 b), is 90 cm long (flange to flange) and it consists in a central electrode and 9 electrodes (39 cm long) on the external surface equally spaced of 22.5° from the upper side (0°) to the lower one (180°); their positions are shown in Figure 3. The electrodes are connected to an electronic circuit by several reed relays and two insulation transformers that prevent common mode disturbances. Each external electrode is connected, at the upper and lower extremity, to two reed relays to activate, in a predefined sequence, the excited electrode and the measuring one; the internal one is connected only in the upper extremity and it is always used as measuring electrode, when the corresponding reed relay is activated. The SIET probe can provide information about the average linear void fraction along 9 different radii and all the possible cords between the different circumferential electrodes. A complete description of the theory of the ECP has been presented in [11].

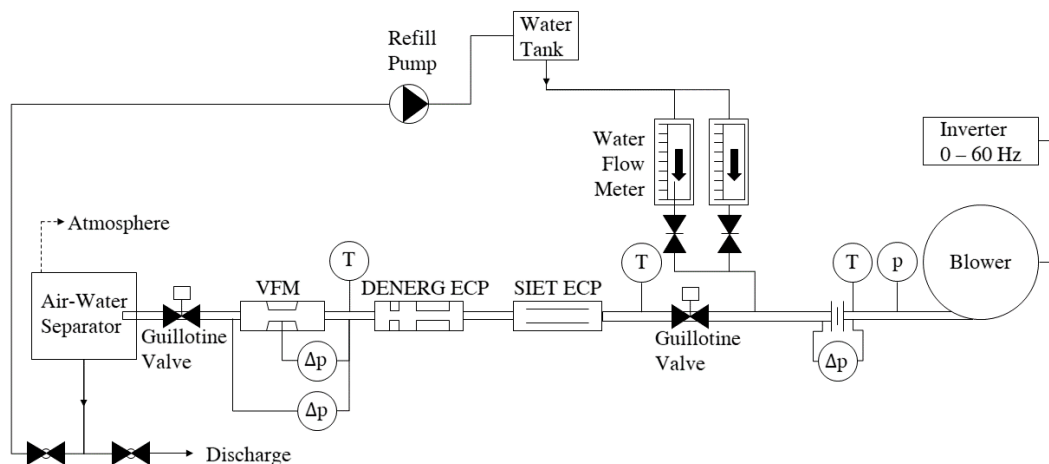

Figure 1 Schematic of the experimental apparatus.

Figure 2c) shows the new capacitance probes (DENERG ECPs), which are made by copper concave electrodes (Figure 3). The two DENERG ECPs are placed on the outer wall of the pipe and they are characterized by different surfaces S (Table 1). Two ECPs with different surfaces have been tested, since the ECP surface should be chosen taking into account the flow pattern occurring in the test section; in fact, their signal is proportional to the equivalent dielectric constant of the two-phase flow.

A 24-Bit Capacitance-to-Digital Converter AD7746 (range: $\pm 4 \text{ pF}$) [9] generates the signal on one concave electrode and receives the response on the other one.

In the case of the wider electrodes the signals of the measured capacitance are out of the measurement range. For this reason it is necessary to design properly the electrodes to optimize the capacitance sensor.

The signals are acquired using three National Instruments DAQ systems (NI USB 6353, NI 9213 and NI 9205) and are managed using the LabVIEW software.

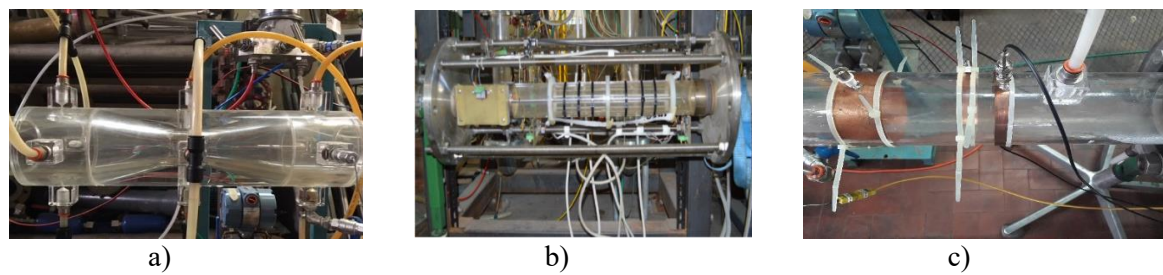

Figure 2: a) The Venturi flow meter (VFM), b) SIET ECP, and c) Probes with concave electrodes designed at DENERG.

Table 1 Concave electrodes geometrical data.

| Electrodes | D_e [mm] | D [mm] | L [mm] | g [mm] | w [mm] | S [mm ²] |
|------------|------------|----------|----------|----------|----------|------------------------|
| A | 90 | 80 | 45 | 20 | 125 | 5625 |
| B | 90 | 80 | 15 | 5 | 140 | 2100 |

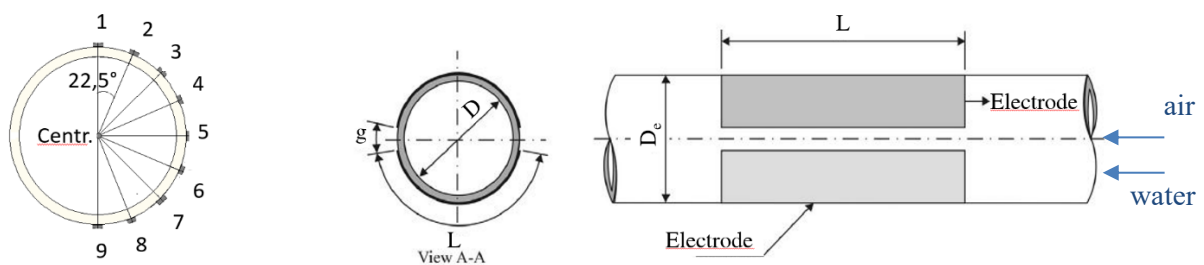

Figure 3 SIET ECP electrodes' position (left) and schematic of the concave electrodes [12] (right).

3. Test procedure and experimental matrix

All the ECPs have been calibrated in static conditions in order to characterize their output signal with liquid only, air only and known heights of water in the test section. In each run, the water and air mass flow rates are regulated respectively by changing the frequency of the inverter connected to the blower and by opening/closing a needle valve located downstream the rotameter. Since the water is provided by gravity and the water tank is located just 3 m above the test section, the possible operational range is not too wide due to the limited available gravitational head.

Pressures, temperatures and the signals from the probes are acquired when the flow in the test section has reached steady-state conditions. At the end of each run the average volumetric void fraction is measured 5-10 times, making use of the quick closing valves, to have a sufficient statistic.

As regard the ECP SIET probe, the signals are sent to the DAQ and managed by a program in the LabVIEW environment. On the other hand, the signals of the concave electrode's sensors are generated and received by an Analog Device- Evaluation board AD7746 (range: ± 4 pF) and managed by an Evaluation Board Software v2.2 [13]. The measurements in the different probes and the data elaboration are synchronized by a "master" program developed in LabVIEW environment.

In the present experimental campaign, the air and water flow rates range respectively from 0.048 to 0.119 kg/s (superficial velocity from 8 to 19 m/s) and from 0.0040 to 0.0535 kg/s (superficial velocity 0.0006 - 0.0103 m/s), as shown in Table 2, which also reports superficial velocities, pressure and temperature at the test section inlet, and the average volumetric void fraction in some typical test run. The experimental void fraction range is 0.976-0.997 and the flow quality range is 0.60-0.96. The resulting flow pattern are wavy-stratified and dispersed-annular. For the same couple of flow rates of

the liquid and gas phases different separate tests have been carried out to assess the repeatability of the measurements.

Table 2 Experimental matrix.

| j_g [m/s] | j_l [m/s] | x [-] | $T_{in, ECP}$ [°C] | p [barg] | α [-] |
|-------------|-------------|---------|--------------------|------------|--------------|
| 12.0 | 0.0016 | 0.901 | 19.6 | 0.091 | 0.992 |
| | 0.0037 | 0.796 | 20.6 | 0.091 | 0.986 |
| | 0.0054 | 0.724 | 20.9 | 0.091 | 0.983 |
| | 0.0087 | 0.621 | 20.9 | 0.092 | 0.977 |
| | 0.0106 | 0.572 | 21.0 | 0.092 | 0.973 |
| 13.5 | 0.0018 | 0.902 | 21.5 | 0.127 | 0.992 |
| | 0.0038 | 0.813 | 22.5 | 0.127 | 0.987 |
| | 0.0054 | 0.757 | 22.7 | 0.127 | 0.984 |
| | 0.0085 | 0.662 | 23.0 | 0.127 | 0.979 |
| | 0.0102 | 0.618 | 23.0 | 0.128 | 0.976 |
| 16.0 | 0.0019 | 0.907 | 24.3 | 0.164 | 0.992 |
| | 0.0038 | 0.828 | 24.7 | 0.165 | 0.988 |
| | 0.0053 | 0.772 | 24.8 | 0.166 | 0.985 |
| | 0.0086 | 0.677 | 24.8 | 0.167 | 0.980 |
| | 0.0102 | 0.636 | 25.1 | 0.167 | 0.978 |
| 19.7 | 0.0017 | 0.934 | 26.1 | 0.252 | 0.994 |
| | 0.0039 | 0.858 | 26.5 | 0.253 | 0.990 |
| | 0.0053 | 0.815 | 25.5 | 0.259 | 0.987 |
| | 0.0091 | 0.719 | 26.2 | 0.258 | 0.982 |
| | 0.0102 | 0.695 | 25.8 | 0.258 | 0.981 |

4. Results and discussion

The transparent pipes of the test section allowed to visualise the evolution of the flow pattern along the pipe. In all the experimental tests stratified-wavy and dispersed-annular flow patterns occurred along the first part of the test section, i.e. from the inlet of the test section up to the inlet of the VFM. The VFM perturbs the flow pattern, which converts to dispersed flow downstream the VFM in all the experimental tests. The experimental flow pattern along the first part of the test section have been compared with the Taitel-Duckler [14] map for horizontal flow (Figure 4) where χ is the Martinelli parameter [15][16] defined as:

$$\chi = \frac{j_l}{j_g} \left(\frac{\rho_l}{\rho_g} \right)^{0.5} \quad (1)$$

and the parameter K is defined as [14]:

$$K = \left[\frac{\rho_g j_g^2 j_f}{(\rho_f - \rho_g) g v_f} \right]^{0.5} \quad (2)$$

The agreement is good in the experimental runs with lower value of the air superficial velocity, since the flow pattern in this region is still developing; in fact the length to diameter ratio at the VFM entrance is approximately equal to 25. Downstream the VFM, the length of the pipe is 450 mm only, which corresponds to L/D equal to 5.6; therefore the flow pattern is still fully undeveloped and cannot be compared with any flow pattern map or model.

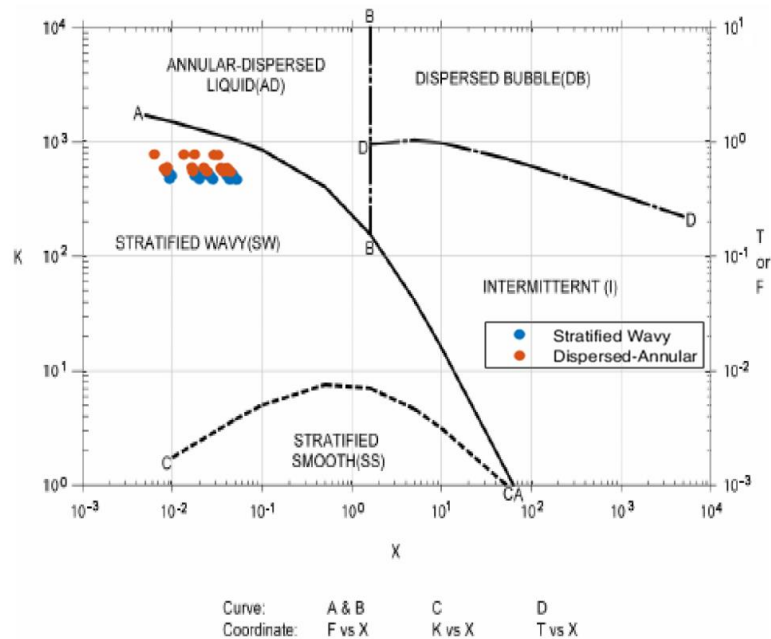

Figure 4 Taitel and Dukler map with experimental working conditions.

It is necessary to highlight that the flow pattern affects slip ratios and the distribution of interfaces between water and air and therefore also the average void fraction. The method of quick-closing valves allows to measure the average void fraction in the whole volume of the test section, i.e. the mean value between the void fraction in the first part of the test section (where annular wavy flow pattern occurs), the one downstream the VFM (where dispersed flow was seen) and the one inside the VFM.

The measured void fraction has been compared with the predictions of the Chisholm slip model [17], which is one of the more accurate for horizontal flow according to [18], and has shown a very good agreement.

As far as the responses of the VFM and ECPs are concerned, they have been analysed first of all in single-phase, following the same methodology presented in [10]. Afterwards, their two-phase response has been studied. The results are described in the following subchapters.

4.1 Response of the VFM

In two-phase flow the total mass flow rate through the VFM, is a function of the two-phase pressure drop Δp_{TP} measured between the inlet and the throat of the VFM and the two-phase density ρ_{TP} , and can be written as:

$$W_{tot} = K_{TP} \sqrt{2 \Delta p_{TP} \rho_{TP}} \quad (3)$$

where K_{TP} is a proportionality coefficient that is function of geometrical data of the VFM and its single-phase discharge coefficient.

Using the approach of Lockhart and Martinelli [15] the total mass flow rate in the VFM can be estimated as:

$$W_{tot} = K_g \sqrt{2 \Delta p_g \Phi_g^2 \rho_g} \quad (4)$$

where K_g relates to the gas phase, Δp_g is the pressure drop of the gas phase estimated from the superficial velocity of the gas and from the discharge coefficient of Venturi, Φ_g^2 is the two-phase flow multiplier that considers the effect of the gas phase and ρ_g is the gas density.

The previous campaigns showed that the two-phase flow multiplier is a function of the Martinelli parameter [15][16]; on the basis of best-fit of the results of the present campaign (Figure 5) the following correlation has been developed:

$$\Phi_g^2 = \frac{\Delta p_{TP}}{\Delta p_g} = 8.3791 \chi + 1.002 \quad (5)$$

where the pressure drop Δp_{TP} is the one measured between the inlet and the throat of the VFM and χ is the Martinelli parameter as in Equation (1).

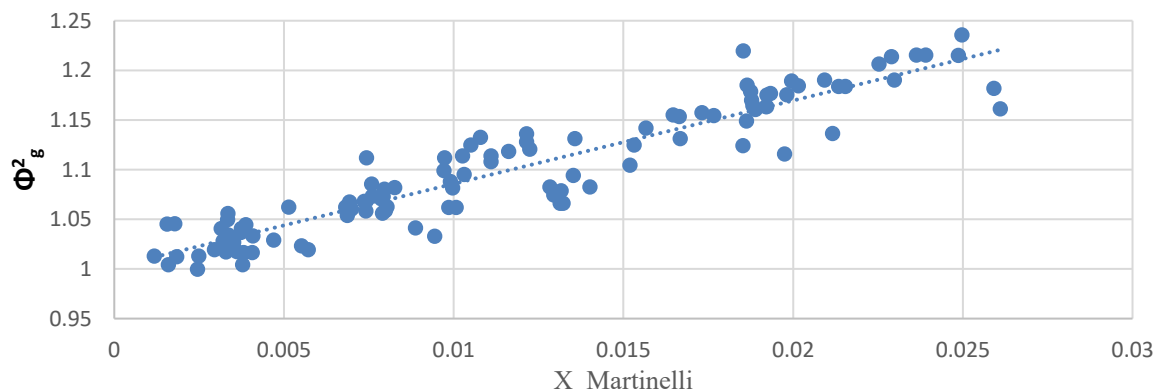

Figure 5 Experimental two-phase multiplier as a function of Lockhart-Martinelli.

Figure 6 reports the irreversible pressure drop between the VFM inlet and outlet, versus the total flow rate. Since this pressure drop is very small, a great accuracy of the transducer is necessary. The previous experimental campaigns showed that the dependency of the irreversible pressure loss on the superficial velocity of the phases and on the density of the gas phase is influenced by the flow pattern; the best-fit of the present experimental campaign allowed the development of the following equations for wavy-stratified and dispersed-annular flow patterns:

$$\text{wavy-stratified flow pattern} \quad \Delta P_{irr} = 0.2205 (\rho_g J_g^{1.91}) \left(\frac{J_l}{J_g} \right)^{0.137} \quad (6)$$

$$\text{dispersed-annular flow pattern} \quad \Delta P_{irr} = 0.2405 (\rho_g J_g^{1.903}) \left(\frac{J_l}{J_g} \right)^{0.147} \quad (7)$$

The discrepancy between the prediction of Equations (6) and (7) and the experimental data is approximately $\pm 10\%$, while 12% discrepancy was found in our previous studies which did not considered the different flow patterns.

Therefore, the knowledge of the reversible and irreversible pressure drop through the VFM could allow the evaluation of the superficial velocities of the two phases and therefore the total two-phase flow rate, but the identification of the flow pattern is fundamental in order to properly correlate the irreversible pressure drop and the two-phase multiplier to the phases superficial velocities (Figure 6).

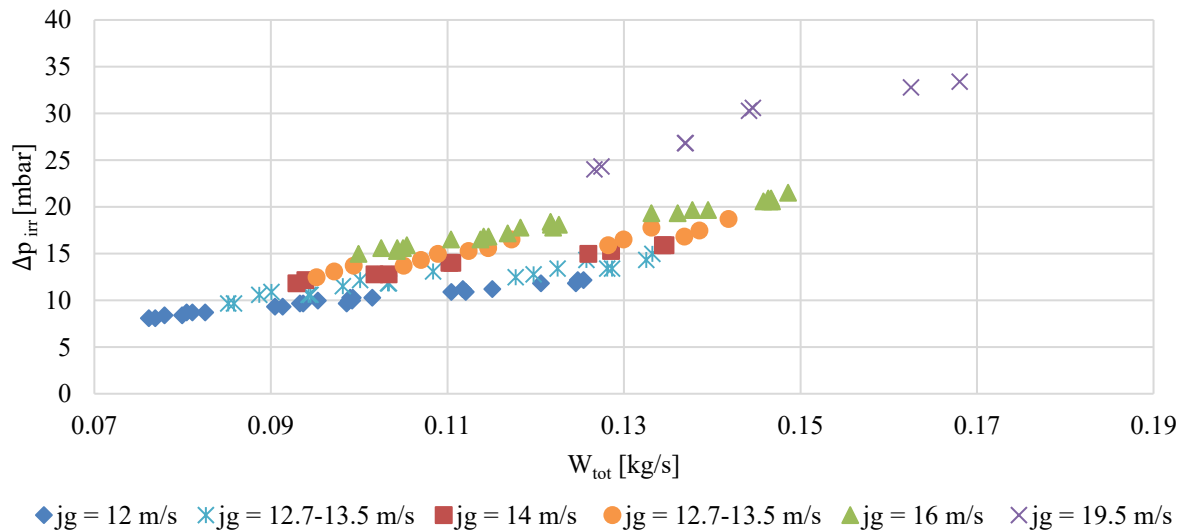

Figure 6 VFM irreversible pressure loss vs total flow rate (present experimental campaign).

4.2 Response of DENERG ECPs

To perform the static calibration of the new capacitance probes with concave electrodes developed at DENERG, the quick isolation valves have been closed, the test section has been gradually filled and the relationships between the equivalent electrical capacitance of the water-air mixture and the water level in the probe was found. These relationships are represented in Figure 7. In presence of a mixture of air and water, the probes behaves as capacitors in series with different dielectric constants, and they show a good sensitivity at low liquid level (level lower than the half pipe).

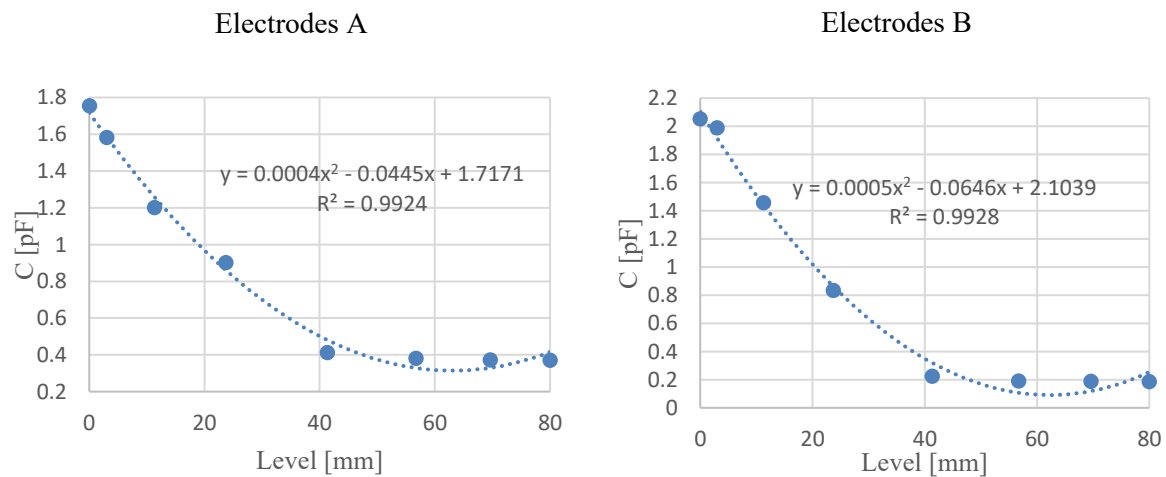

Figure 7 Calibration of the two configurations of concave electrodes' sensor.

The dynamic behavior of these two concave sensors has then been studied for different couples of values of the air and water superficial velocities. Figure 8 and Figure 9 show the measured capacitance versus the superficial velocity of the liquid phase, at different superficial velocity of the gas phase. The analysis of the signals shows that the measured capacitance increases as the void fraction increases. In particular, their sensitivity is good in case of dispersed-annular flow pattern (high capacitance values), whereas the sensitivity is poorer for the stratified-wavy flow pattern. In particular the probe A, which has a bigger surface, shows a steeper increase of the capacitance when the air superficial velocity increases; the capacitance reaches the full scale value of the measuring instrument (4 pF) for high values of the air superficial velocity (greater than 16 m/s); in this case, an ECP with lower surface (probe B) is necessary.

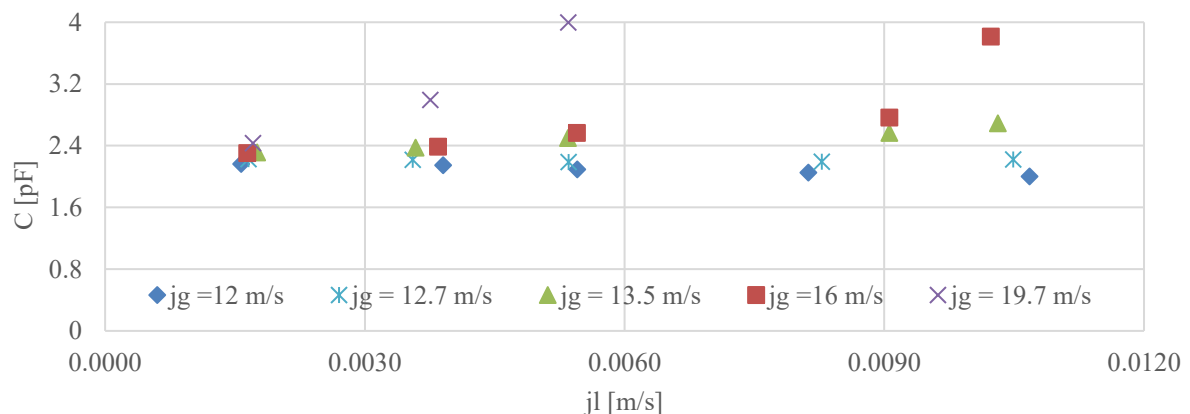

Figure 8 Capacitance values vs liquid superficial velocity, parameterized with gas superficial velocity (Electrodes A).

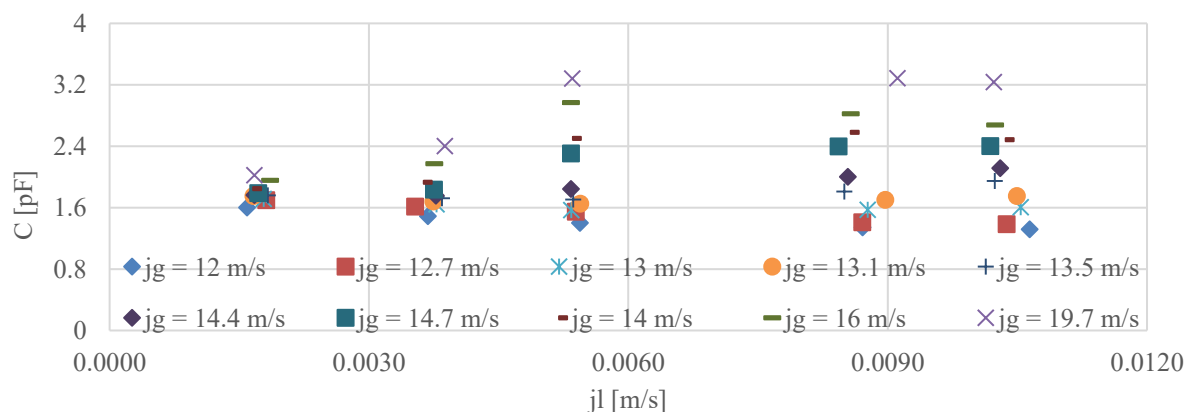

Figure 9 Capacitance values vs liquid superficial velocity, parameterized with gas superficial velocity (Electrodes B).

The relationship between the capacitance measured with the probe B and the void fraction measured by the QCV method has also been studied in the whole ranges of air and water superficial velocities. The results are reported in Figure 10, where the results have been grouped on the basis of the water superficial velocities. Four ranges of water superficial velocity have been considered; for each of them a different best-fit line has been found. Moving from the left towards the right of the void fraction axis, the flow patterns changes from wavy-stratified to dispersed-annular flow. Therefore the capacitance signal is not sufficient to determine the void fraction. The knowledge of the flow pattern is also necessary.

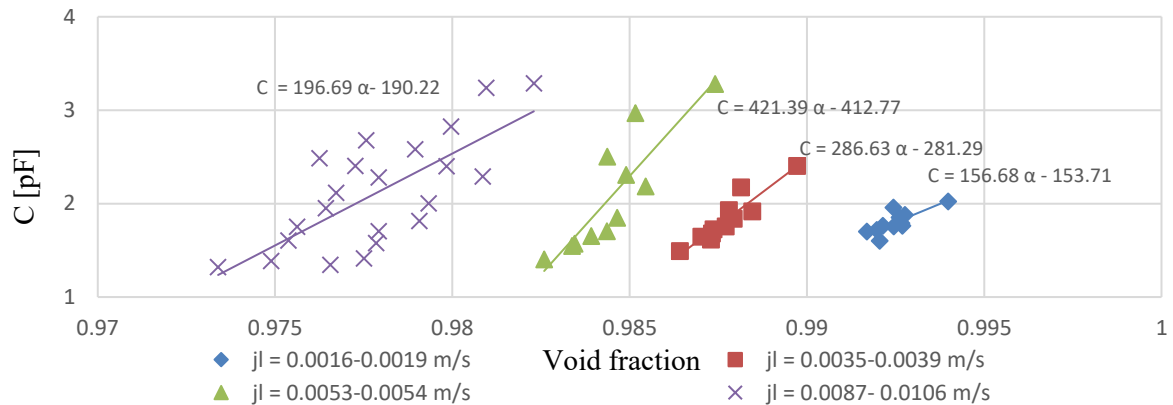

Figure 10 Capacitance values vs experimental void fraction.

4.3 Response of the SIET ECP

The results obtained with the SIET ECP in the present experiments are in agreement with all those of previous campaigns [10]. The curves in Figure 11 and Figure 12 show the normalized signals $V_{i,j}^*$ as a function of the position of the electrodes at different experimental values of the void fraction measured by the QCV method. $V_{i,j}^*$ is calculated as follows:

$$V_{i,j}^* = \frac{RMS_{TP-ij} - RMS_{l-ij}}{RMS_{g-ij} - RMS_{l-ij}} \quad (8)$$

where the subscript ij identifies the measuring electrodes combination and RMS is the root mean square of electrical signals. This value is a function of the local void fraction and of the probe sensitivity. Figure 11 reports the signal measured between electrode 1 (probe top) and all the other circumferential electrodes for two values of air superficial velocity, while figure 12 is relative to electrode 9 (probe bottom) and all the other ones.

Increasing the air flow rate, the flow pattern changes from wavy-stratified to dispersed-annular. The different distribution of the phases is identified by the ECP. In the case of higher air superficial velocities (dispersed annular flow), the measurements between the circumferential electrodes are rather insensitive to the void fraction (Figure 11b and Figure 12b), so it is necessary to consider also the measurements on the central electrode.

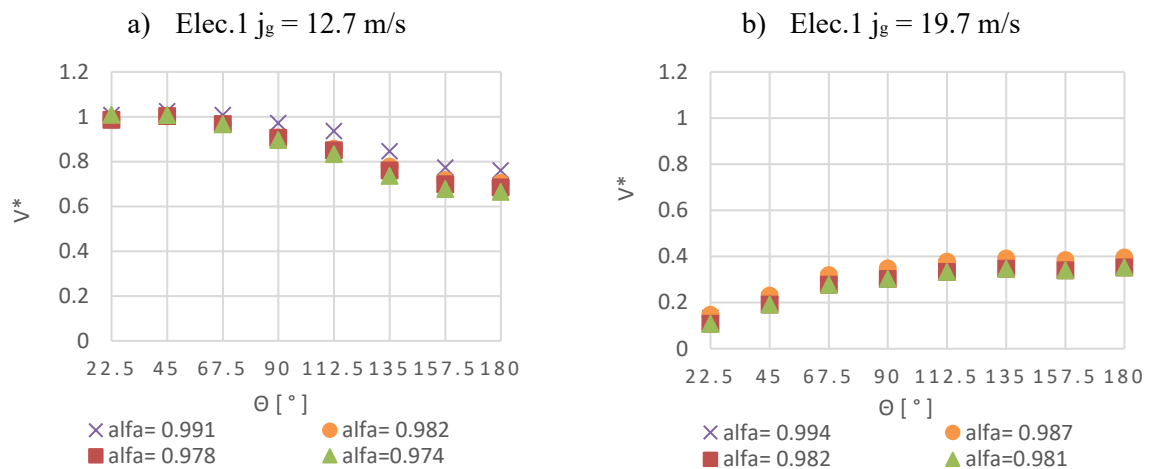

Figure 11 Dimensionless voltage drop electrode 1 (top).

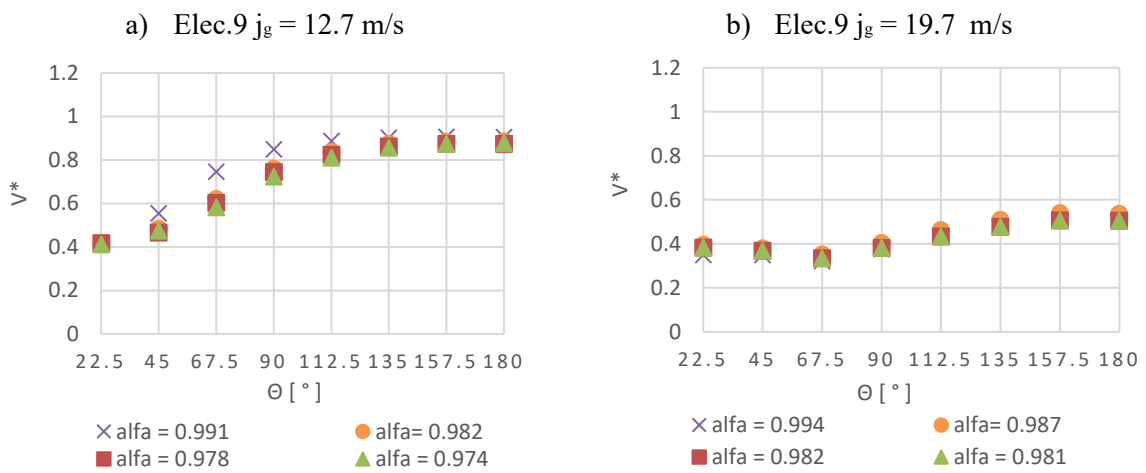

Figure 12 Dimensionless voltage drop electrode 9 (bottom).

Figure 13 shows the signals between the central electrode and the circumferential ones. The signal increases linearly with the void fraction and the trend of the curves depends on the position of the electrodes with respect to the vertical axis of the tube.

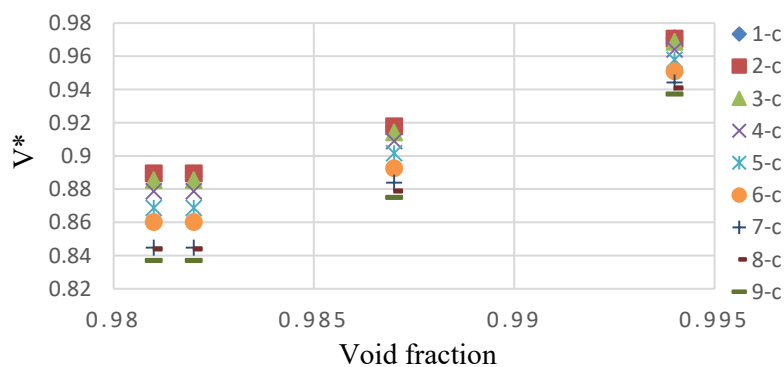

Figure 13 Dimensionless voltage drop associated with the measurements of the central electrode vs experimental void fraction.

5. Conclusions and perspectives

In this study a spool piece constituted by a Venturi Flow Meter, a new capacitance probe with concave electrodes designed at DENERG-Politecnico di Torino and the electrical capacitance probe designed by SIET have been characterized for wavy stratified and dispersed-annular flow pattern.

The results of the SIET ECP agree with those of the previous experimental campaigns. The DENERG ECP and the VFM demonstrated the possibility to determine respectively the average void fraction and the superficial velocity of the phases once the flow pattern is known. The elaboration of the signals from the SIET ECP can provide information on the flow pattern. In the future, taking the present experimental results into account, the design modification of the DENERG ECP will improve the performance of this probe; a second probe will also be positioned downstream the VFM and the range of the flow patterns will be extended. The final goal is the development of a two-phase flow forecasting model based on the transducers responses.

Acknowledgments: Thanks to Rocco Costantino for the technical support in the laboratory.

References

- [1] Oddie G and Pearson J R A 2004 *Annu. Rev. Fluid Mech.* **36** 149-172
- [2] Kumar S B, Moslemian D and Dudokovic M P 1995 *Flow Meas. Instrum.* **6** 61-73
- [3] Veera U P 2001 *Chem. Eng. J.* **81** 251-260
- [4] Dyakowsky T 1996 *Meas. Sci. Technol.* **7** 343-353
- [5] Mishima K, Hibiki T and Nishihara H 1997 *Nucl. Eng. Des.* **175** 25-35
- [6] De Salve M, Monni G and Panella B 2012 *J. Phys. Conf. Ser.* **395** 012179
- [7] Monni G, De Salve M, Panella B and Randaccio C 2013 *Sci. Technol. Nucl. Ins.* **2013** 568287
- [8] Monni G, De Salve M and Panella B 2014 *Prog. Nucl. Energy* **77** 167-175
- [9] Analog Devices, 24-bit Capacitance-to-digital Converter with Temperature Sensor AD7746.
- [10] Caramello M, De Salve M, Monni G, Panella B 2014 Modellizzazione di uno spool piece per la stima dei parametri caratteristici dei deflussi bifase, Report RdS/PAR2013/095
- [11] De Salve M, Monni G, Panella B, Randaccio C 2012 Electrical Capacitance Probe characterisation for vertical annular air-water flow investigation in *HEFAT2012 Conference Proceedings*
- [12] Ahmed Wael H, Ismail Basel I. 2008 Innovative Techniques for two-phase flow measurements *Recent Patents on electrical engineering* **1** 1-13
- [13] Analog Devices, AD7746 Evaluation Board data sheet.
- [14] Taitel Y, Dukler A E 1 1976 *AIChE J.* **22** 47-55
- [15] Lockhart R W, Martinelli R C 1949 *Chem. Eng. Prog.* **45** 38-48
- [16] Martinelli R C, Nelson D B 1948 *Trans. ASME* **70** 695
- [17] Chisholm D 1973 *J. Mech. Eng. Sci.* **15** 235-236
- [18] Mathure N 2010 Study of flow patterns and void fraction in horizontal two-phase flow *Master of Science, Oklahoma State University*