

Fall of Potential Measurement of the Earth Resistance in Urban Environments: Accuracy Evaluation

Original

Fall of Potential Measurement of the Earth Resistance in Urban Environments: Accuracy Evaluation / Colella, Pietro; Pons, Enrico; Tommasini, Riccardo; Di Silvestre, Maria Luisa; Riva Sanseverino, Eleonora; Zizzo, Gaetano. - In: IEEE TRANSACTIONS ON INDUSTRY APPLICATIONS. - ISSN 0093-9994. - STAMPA. - 55:3(2019), pp. 2337-2346. [10.1109/TIA.2019.2892680]

Availability:

This version is available at: 11583/2724278 since: 2020-01-16T16:49:40Z

Publisher:

IEEE / Institute of Electrical and Electronics Engineers

Published

DOI:10.1109/TIA.2019.2892680

Terms of use:

This article is made available under terms and conditions as specified in the corresponding bibliographic description in the repository

Publisher copyright

IEEE postprint/Author's Accepted Manuscript

©2019 IEEE. Personal use of this material is permitted. Permission from IEEE must be obtained for all other uses, in any current or future media, including reprinting/republishing this material for advertising or promotional purposes, creating new collecting works, for resale or lists, or reuse of any copyrighted component of this work in other works.

(Article begins on next page)

Fall of Potential Measurement of the Earth Resistance in Urban Environments: Accuracy Evaluation

Pietro Colella*, *Member, IEEE*, Enrico Pons*, *Member, IEEE*, Riccardo Tommasini†

Maria Luisa Di Silvestre‡, Eleonora Riva Sanseverino‡, Gaetano Zizzo‡

* Politecnico di Torino, DENERG, Torino, Italy, pietro.colella@polito.it

† Passed away on January, 2017

‡ Università degli Studi di Palermo, DEIM, Palermo, Italy

Abstract—Both Standards EN 50522 and IEEE 81 propose the Fall of Potential Method (FPM) to carry out the measurement of the Resistance to Earth (R_{ES}) of an Earthing System (ES). However, in urban areas, the recommended distances between the ES and auxiliary electrodes are not easy to respect, due to the presence of buildings and tarmac. Furthermore, unknown buried metallic parts and interconnections among ESs could modify the earth potential profile of the area, affecting the measurement results. In this paper, the key-issues that influence the measured R_{ES} when the FPM is used in an urban environment are presented. A parametric analysis, carried out with Comsol Multiphysics, quantifies the errors due to wrong positioning of the auxiliary electrodes and due to the presence of interconnected ESs in the proximity of the ES under test. In addition, a real case of field measurement is described, emphasizing the main aspects that could compromise the results. Finally, practical suggestions to reduce errors are provided.

I. ACRONYMS AND NOMENCLATURE

BP	Buried metallic part.
C	Current electrode.
d	Maximum extension of the earthing system.
d_C	Distance between earthing system and current electrode.
d_P	Distance between earthing system and voltage probe.
DSO	Distribution System Operator.
ECP	Extraneous Conductive Part.
EPP	Earth Potential Profile.
EPR	Earth Potential Rise.
ES	Earthing System.
FEM	Finite Element Method.
FPM	Fall of Potential Method.
FPM/Clamp	Fall of potential / clamp-on method.
GES	Global Earthing System.
HV	High Voltage.
I	Test current.
LV	Low Voltage.
MV	Medium Voltage.
P	Voltage probe.
R_{ES}	Resistance to earth.
V	Voltage between the earthing system under test and the voltage probe.
ϵ_r	Relative percentage error.

II. INTRODUCTION

The international Standard EN 50522 states that Earthing Systems (ESs) of MV/LV substations shall be dimensioned in order to avoid dangerous touch voltages [1].

According to EN 50522, the observance of permissible touch voltage is satisfied if one of the following conditions is fulfilled:

- 1) the relevant installation becomes a part of a Global Earthing Systems (GES) [2]–[5];
- 2) the stipulation for the permissible touch voltage is proved, generally by measurements [6];
- 3) the Earth Potential Rise (EPR) does not exceed safety thresholds, which are defined on the basis of the eventual adoption of recognized specified measures M, described in Annex E of EN 50522 [1]. As known, to evaluate the EPR, an estimation/measurement of the resistance to earth R_{ES} of the substation under test shall be carried out. One of the methods suggested by both EN 50522 and IEEE Std. 81 is the Fall of Potential Method (FPM) [1], [7].

In urban and industrial areas, in case of a MV single line to earth fault, a single ES plays only a small part in ensuring safety for staff and public. In fact, thanks to the interconnection among ESs made through protective conductors (e.g. MV cable shields), the current injected by a single ES is only a small part of the entire fault current, with a consequent reduction of touch voltages [8]–[10]. This effect is the basis of the GES and therefore the first condition should be the most logical option. Unfortunately, the GESs that are officially certified are still few [3]. Therefore, the observance of permissible touch voltage is often verified through the EPR computation, which requires an estimation/measurement of R_{ES} . To accomplish this task, one of the methods suggested by both EN 50522 and IEEE Std. 81 is the Fall of Potential Method (FPM).

In urban areas, the FPM is not easy to be used, as several issues can affect the results [11]. In particular, an underestimation of R_{ES} can be due to:

- 1) an erroneous positioning of auxiliary electrodes [6];

- 2) the interconnection of the ES under test with other MV ESs, through protective conductors (e.g. MV cable sheaths) [12];
- 3) the presence of LV neutral additional earthing, implemented to guarantee the electrical continuity and the grounding of LV neutral conductors [13];
- 4) the presence of unknown buried metallic parts, such as water pipes or bare buried earth conductors [9];
- 5) electromagnetic noises, created by electric systems located in the vicinity (e.g. urban light railways).

In this paper, the main aspects that should be considered using the FPM in an urban environment are discussed in section III. Furthermore, the problems of incorrect positioning of the auxiliary electrodes and of interconnections among ESs are analyzed through simulations in section IV. Finally, in section V, the results of field measurements are reported to better explain the key-issues that can affect the results.

III. FALL OF POTENTIAL METHOD ANALYSIS

In this section, the main aspects that should be considered before measuring the resistance to earth with the FPM are presented and discussed.

A. Positioning of the auxiliary electrodes

The measurement setup of the FPM is depicted in Fig. 1 [14], [15]. As known, two auxiliary electrodes (C and P) are required. They must be placed with the aim of reducing their interference. Usually, they lie on a straight line with the ES under test. The ES and the auxiliary current electrode C are connected to a current generator, which injects the current I . The voltage V between the ES and the voltage probe P is measured.

The standard EN 50522 (Annex L) provides a method to measure the R_{ES} with the FPM and earth tester. It can be adopted for earth electrodes and ESs of small or medium extent, such as for example single rod earth electrodes, strip earth electrodes, earth electrodes of overhead line towers with lifted off or attached earth wires, medium voltage ESs and separation of the low-voltage ESs [1]. According to this method, if the conditions reported in the set (1) are verified, the R_{ES} of an ES characterized by a maximum extension d in the measuring direction can be computed by the ratio V/I [1].

$$\begin{cases} d_P \geq 2.5 \cdot d \\ d_P > 20m \\ d_C \geq 4 \cdot d \\ d_C > 40m \end{cases} \quad (1)$$

A helpful suggestion for the positioning of auxiliary electrodes can be found also in IEEE Std. 81 [7], [14], [16]. For small electrodes, if condition (2) is verified, R_{ES} can be computed without significant errors. The distance reported in eq. (2) is based on the theoretically correct position for measuring the exact electrode impedance for a soil with uniform resistivity [7], [16]. Therefore, the more in-homogeneous the soil, the higher the measurement error.

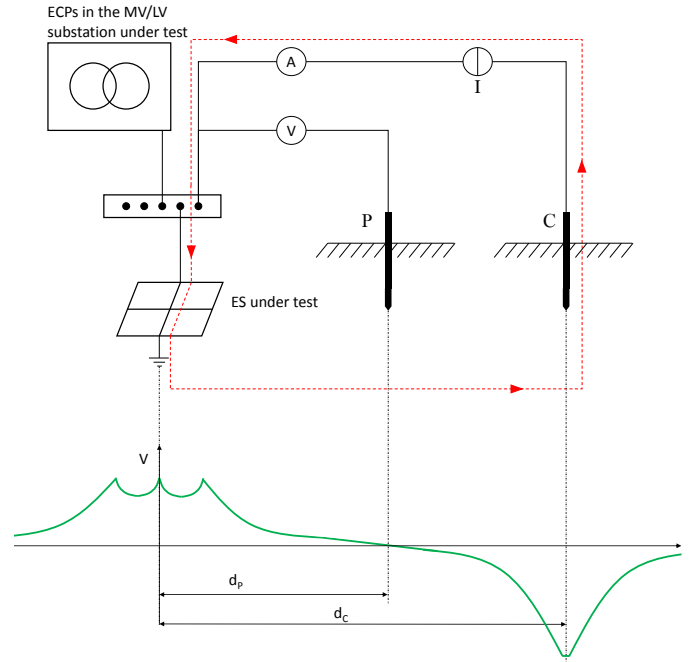

Figure 1. FPM measurement setup, current paths and earth potential profile.

$$d_P = 62\% \cdot d_C \quad (2)$$

However, in an urban environment, conditions (1) and (2) are not easy to be met because tarmac and buildings reduce the number of places where auxiliary electrodes can be positioned. For these reasons, the auxiliary current electrode and the voltage probe are often not optimally located, thus introducing an error in the earth resistance evaluation. The positioning problem will be discussed in detail in section IV, analyzing the results of a parametric analysis.

B. Interconnection among ESs

The interconnection among the ESs of the MV/LV substation through protective conductors, such as MV cable sheaths, should always be considered in earth measurements [8]. In fact, as shown in Fig. 2, the current that flows through the ES under test can be just some percent of the total test current I [8], [10], [17]. Consequently, EPR and R_{ES} can be underestimated.

The existence of an interconnection of the ES under test with other ESs can also be due to the LV neutral grounding systems: a single user can have alternative feeding substations for reliability purposes and, while the phase conductors are sectioned, LV neutrals are never interrupted. LV neutral conductors can also be earthed along their path to improve safety. In this case, as presented in [13], in addition to the reduction of the earth current similar to that described before for MV cable sheaths, the high number and the proximity of the earth rods have an impact also on the potential distribution on the soil surface: the voltage probe can be placed where the soil potential is far from zero. As a consequence, the measurement error increases and R_{ES} is underestimated.

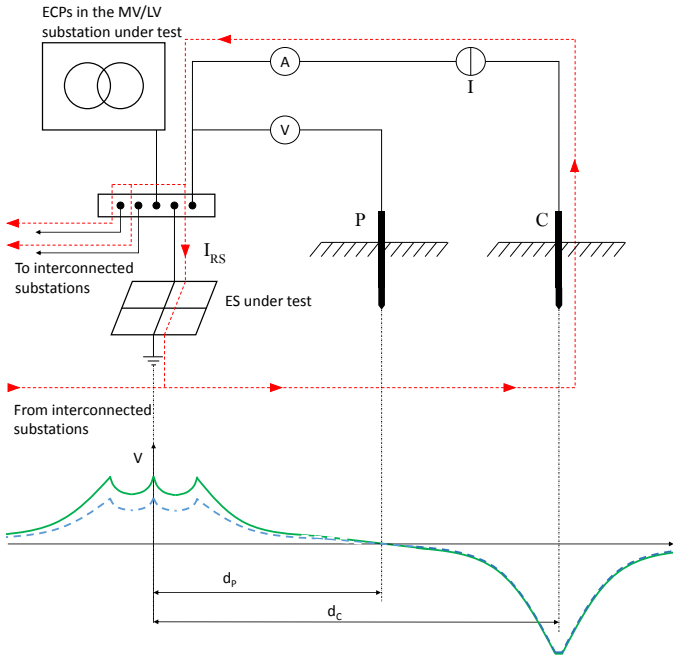

Figure 2. Error due to interconnection among ESs. The dashed blue line and the continuous green line represent the EPP for the scenario with and without interconnection, respectively.

If the MV/LV substation is under construction, a simple solution is the disconnection of the ES under test from other ESs. Vice-versa, if the MV/LV substation is already in operation, other strategies should be adopted. In fact, in order to carry out the measurement safely, before disconnecting the ES from the cable sheaths, the whole MV feeder shall be powered off, with a consequent service interruption that is generally considered unacceptable by Distribution System Operators (DSOs). An alternative solution suggested by EN 50522 is to use high frequency earth testers, which are commonly adopted to decouple transmission tower earth wires; the frequency shall be sufficiently high to make the impedance of the interconnection conductors relevant, representing a practically negligible shunt circuit to the earthing of the single ES [1].

Another approach to take into account the interconnection among ESs is to measure the portion of the current that flows into the ES under test only. This method is proposed by the IEEE Std. 81 by the name of “Fall of potential/clamp-on method” (FPM/Clamp) [7]. However, this method cannot always be adopted, because earthing conductors could be not easily accessible and current clamps could not be installed. Furthermore, even if this technique is adopted, the measurement error due to the perturbation of the soil surface potential due to LV neutrals distributed groundings is not eliminated.

The effects of the interconnection among ESs are also presented in the discussion of the parametric analysis in section IV.

C. Presence of buried metallic parts

Another point that should be considered in earth resistance measurements is the presence of Buried metallic Parts (BPs), which can either belong to the earthing network (e.g. bare

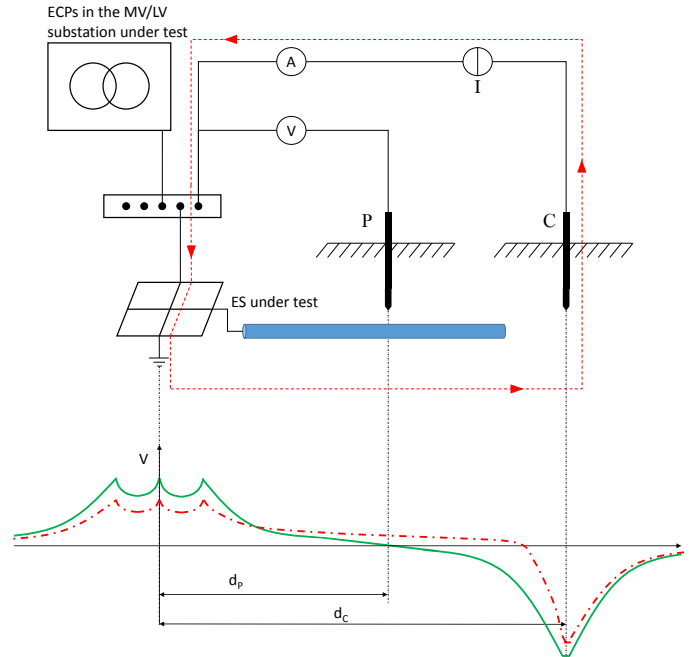

Figure 3. Error due to the presence of buried metallic parts, interconnected to the ES. The dot-dash red line and the continuous green line represent the EPP for the scenario with and without the buried metallic part, respectively.

buried conductors) or not (e.g. water and gas pipes). These objects are commonly widespread in urban areas and usually have a large extension. Generally, no information about them is available during R_{ES} measurements. They can be interconnected to the ES or kept floating. According to their interconnection level and to their distance from the ES under test, they can modify the current field and the Earth Potential Profile (EPP) [9]. An unfavorable condition happens when the voltage probe P is placed over a metallic object interconnected to the ES, as shown in Fig. 3. In this case, the reference potential given by P is far from zero and both EPR and R_{ES} are underestimated.

IV. PARAMETRIC ANALYSIS

As discussed in the previous section, standards EN 50522 and IEEE Std. 81 provide suggestions for the positioning of auxiliary electrodes (eq. (1) and eq. (2)) [1], [7]. However, the recommended distances are not easy to be respected in urban environments due to the presence of buildings and tarmac. Moreover, the interconnection among ESs and the presence of buried metallic parts significantly affects the measurement, as described in section III.

In order to quantify the error caused by an incorrect positioning of current electrode and voltage probe, and by the presence of buried interconnected ESs, a parametric analysis was carried out by Comsol Multiphysics, a commercial software based on the Finite Element Method (FEM), already validated in previous papers [9], [18].

Four scenarios are considered. For the sake of clarity, their characteristics are summarized in Table I.

In the first, an ES of a MV/LV substation and an auxiliary current probe are modeled. The distance between their center

Table I
EXAMINED SCENARIOS

Scenario [#]	Modeled ESs [#]	d_C [m]
1	1	40
2	1	20
3	3	40
4	3	20

is 40 m. Notice that, for the considered case, 40 m is the acceptability threshold recommended by EN 50522 [1] for the distance d_C , as shown in eq. (1). To quantify the error due to erroneous positioning of auxiliary electrodes, in scenario 2 the distance between the tested ES and the auxiliary current probe was reduced to 20 m.

To evaluate the error due to interconnected electrodes in the proximity of the ES, two additional scenarios were implemented, taking as a reference the real MV feeder described in [3] and reported for the sake of clarity in Fig. 4. The effects of interconnected ESs are two, i.e. the reduction of the current driven into the earth by the tested ES and the modification of the EPP. In order to properly consider the former, the percentage of the total test current injected by each ES was computed. To take into account the latter, two extra ESs were added to the scenarios 1 and 2. The ES under test is identified by number 8 in Fig. 4 while the two extra ESs by numbers 7 and 9. These substations are the closest in the entire feeder; this choice was made to emphasize the EPP modification effect.

In subsection IV-A, details about the geometry and the materials adopted in the simulations are reported.

In subsection IV-B, the FEM settings are provided, with reference to the techniques chosen to model a theoretically infinite domain, such as the ground.

Finally, in subsection IV-C, the results of the parametric analysis are reported.

A. Geometry and Materials

The ESs of the MV/LV substations were modeled as square electrodes, buried at 0.5 m under the soil level, while the earth rod typically used as auxiliary current electrode is modeled as a cylinder.

The radius (r_C) and thickness of electrodes (t_{ES}) were set equal to 5 cm. This value is different from the typical one (≈ 0.5 cm) in order to simplify the geometry definition and the mesh creation in the FEM software. To be sure that this will not significantly impact the simulation results, different lengths of the auxiliary current electrode (L_C), thicknesses of the square electrode conductor (t_{ES}) and radius of the auxiliary current electrode (r_C) were tested for scenario 1. Differences can be noticed only near the auxiliary current electrode, for distances lower than 2 m. Considering the positions of the voltage probe adopted in this work, modeling the auxiliary current electrode and the square electrodes with dimensions different from the real ones does not significantly affect the results and the conclusions of the paper [19].

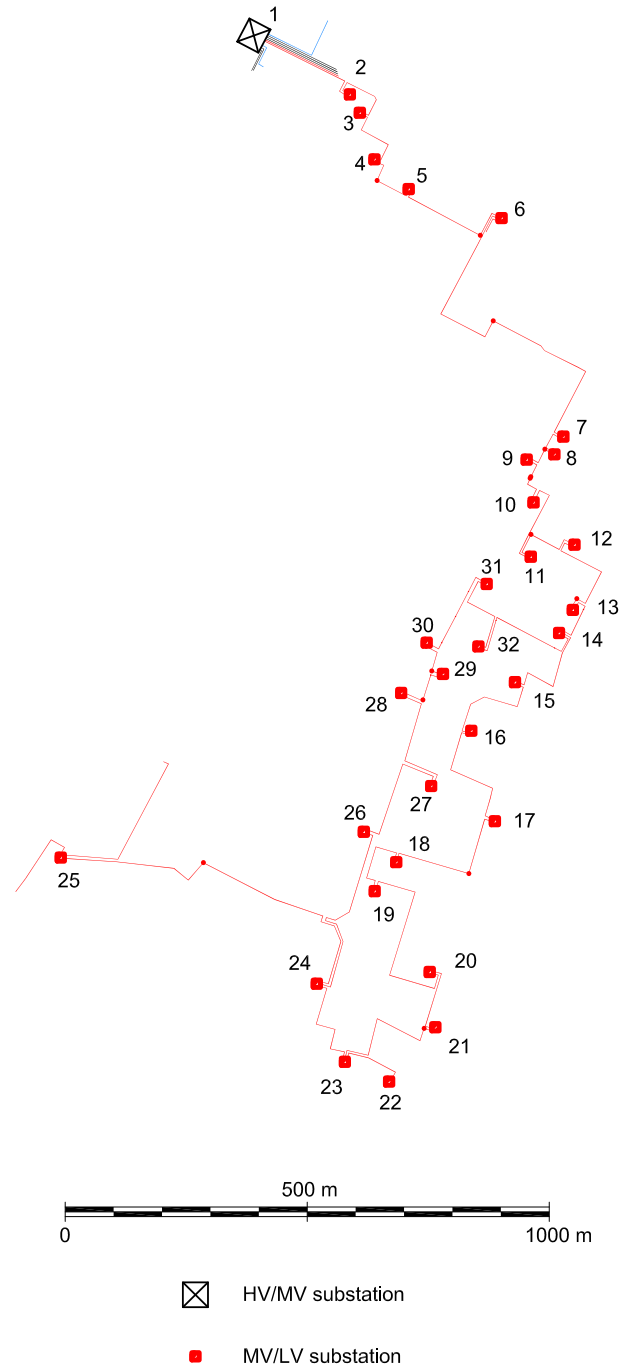

Figure 4. Comparison among the methods: the considered MV line.

The soil was considered homogeneous, characterized by a resistivity of $100 \Omega m$, while all the electrodes are made in copper. Other geometrical and electrical details are reported in Table II. For the sake of clarity, as an example, the implemented model for scenario 1 is depicted in Fig. 5, as well as the Cartesian coordinate system: the ES and the auxiliary current electrode C are drawn in red and green, respectively.

B. FEM settings

All the electric potentials are referred to the reference earth, i.e. a part of the Earth whose electric potential is conven-

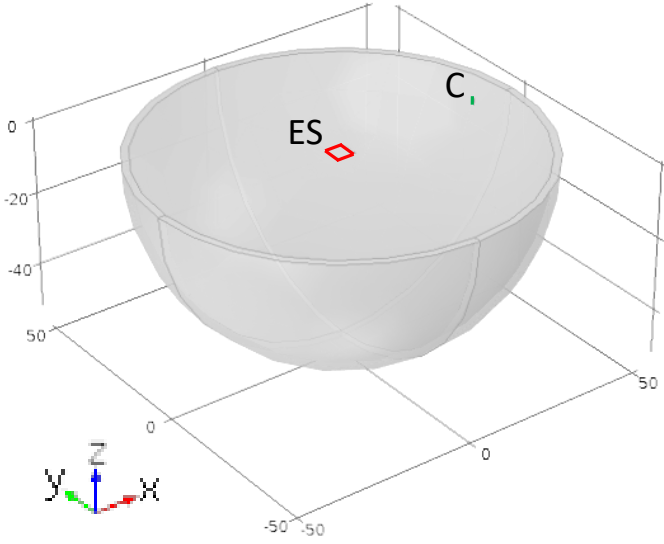

Figure 5. The implemented model. The ES and the auxiliary current electrode C are drawn in red and green, respectively.

Table II
GEOMETRICAL AND ELECTRICAL DETAILS

Symbol	Quantity	Values
L_{ES}	ES electrode length	5 m
(X_7, Y_7)	Coordinates in m of the center of the ES 7	(19, 34)
(X_8, Y_8)	Coordinates in m of the center of the ES 8	(0, 0)
(X_9, Y_9)	Coordinates in m of the center of the ES 9	(-57, 7)
L_C	Auxiliary current electrode length	1 m
d_{CS1}	Distance between the centers of the ES under test and auxiliary current electrodes for the Scenario 1 and 3	40 m
d_{CS2}	Distance between the centers of the ES under test and auxiliary current electrodes for the Scenario 2 and 4	20 m
t_{ES}	Square electrode conductor thickness	5 cm
r_C	Auxiliary current electrode radius	5 cm
ρ_{cu}	Electrical resistivity of copper	$1.66 \cdot 10^{-8} \Omega m$
ρ_{soil}	Electrical resistivity of the soil	100 Ωm

tionally taken as zero, being outside the zone of influence of the earthing systems [1]. In order to model the unbounded domain correctly, without increasing the size of the problem, the method based on spatial transformation was adopted [20]. This implementation maps the model coordinates from the local, finite-sized domain to a stretched domain. The inner boundary of this stretched domain corresponds to the local domain, but at the external boundary the coordinates are scaled towards infinity [21]–[23]. In this way, it is possible to set the potential of the external boundary equal to 0 V.

The other boundary condition in the simulations concerns the grounding electrodes. In scenarios 1 and 2, the square ES injects into the soil 1 A; the same current is “picked up” by the auxiliary current electrode. In scenarios 3 and 4, when the ES is not isolated, just a portion of the total test current is driven into the soil by the ES under test. Therefore, in order to properly set the current injected by each of the three ESs in the

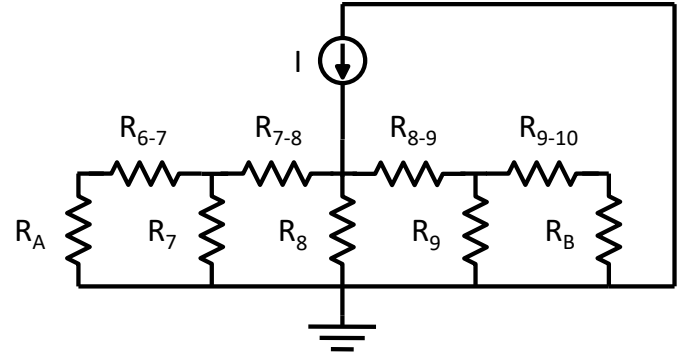

Figure 6. Circuitual model implemented to compute the distribution of the test current among the ESs of the feeder. R_A is the equivalent resistance of the upward earthing network (as seen by substation 6), R_{X-Y} is the resistance of the MV cable shield between the generic substations X and Y, R_Z is the earth resistance of the generic substation Z, R_B is the equivalent resistance of the downward earthing network (as seen by substation 10), I is the test current.

simulation, the distribution of the test current among the ESs of the feeder shall be computed. With this aim, an equivalent simplified electrical circuit of the MV earthing network was built, considering the R_{ES} of each ES and the resistance of the MV cable sheaths, calculated from the cross-section and the length of the conductors [3]; a current generator, which injects the test current of 1 A, was connected in parallel to the ES under test (n 8). The electrical circuit is depicted in Fig. 6. The currents that flow through the resistance to earth of the ESs 7, 8 and 9 are found to be equal to 0.080 A, 0.083 A and 0.078 A, respectively. In this simplified circuitual model of the MV feeder, only the resistive parameters were considered. However, the current distribution is comparable to the values of the reduction factor available in literature, where the ratio between the earth current and the fault current is in the range between 0.5% and 20% [8], [10].

C. Results of the Parametric Analysis

The R_{ES} of the MV/LV substation earthing system under test was computed by eq. (3):

$$R_{ES} = \frac{V}{I} = \frac{EPR_{ES} - V_P(x, y)}{I} \quad (3)$$

where:

- V is the voltage between the ES under test (square electrode) and the voltage probe P ;
- I is the test current;
- EPR_{ES} is the Earth Potential Rise of the ES under test;
- $V_P(x, y)$ is the potential of the voltage probe in the position identified by the coordinates x, y , considered equal to the potential of the soil surface in the same point.

As discussed in the previous sections, the ES under test drives into the soil just a small percentage of the test current when it is interconnected with other electrodes (scenario 3 and 4), with a consequent increment of the measurement error and an underestimation of the resistance to earth. To improve the accuracy, according to the characteristics of the network,

Table III
PARAMETRIC ANALYSIS RESULTS

Scenario #	FPM/Clamp	$(x, y) _{d_C}$ [m]	$(x, y) _{d_P}$ [m]	R_{ES} [Ω]	ϵ_r [%]
1	-	(40, 0)	(-20, 0)	7.46	-10.93
1	-	(40, 0)	(24.8, 0)	8.38	0.02
2	-	(20, 0)	(-10, 0)	6.42	-23.40
2	-	(20, 0)	(12.4, 0)	8.35	-0.30
3	NO	(40, 0)	(-20, 0)	0.51	-93.95
3	NO	(40, 0)	(24.8, 0)	1.24	-85.23
3	YES	(40, 0)	(-20, 0)	6.09	-27.33
3	YES	(40, 0)	(24.8, 0)	14.86	77.41
4	NO	(20, 0)	(-10, 0)	0.29	-96.48
4	NO	(20, 0)	(12.4, 0)	1.94	-76.83
4	YES	(20, 0)	(-10, 0)	3.54	-57.77
4	YES	(20, 0)	(12.4, 0)	23.31	178.35

sometimes it is possible to measure the portion of the current that flows into the ES under test only (FPM/Clamp).

The calculated values for R_{ES} are reported in Table III for the more relevant positions of the voltage probe, with reference to the suggestions of both EN 50522 and IEEE Std.81. The distance d_P requested by IEEE Std. 81 (eq. (2)) is 24.8 m for the scenarios 1 and 3, and 12.4 m for scenario 2 and 4. To allow a comparison among the several configurations of auxiliary electrodes, a reference value R_{ES}^* , equals to 8.37 Ω , was computed with Comsol Multiphysics in a different simulation, where only the ES under test is present. In this way, the relative percentage error (ϵ_r) could be calculated. For scenarios 3 and 4, the results for both the traditional FPM and the FPM/Clamp were computed.

According to the results reported in Table III for scenarios 1 and 2 (isolated ES), it can be observed that if eq. (2) is satisfied, it is possible to obtain extremely small percentage errors. However, if the voltage probe is not placed exactly in the required position, the errors quickly increase. The nearer the ES and the current electrode, the more evident this effect. Vice-versa, for scenarios 3 and 4, the fulfillment of eq. (2) does not provide small percentage errors, for neither FPM nor FPM/Clamp. However, if FPM/Clamp is adopted, R_{ES} is overestimated; therefore it could be considered an acceptable result from the point of view of safety.

For new not interconnected MV/LV substations, a good practice would be the fixed installation of the two auxiliary electrodes (C and P of Fig. 1) at a proper distance from the ES, so that the measurement of R_{ES} could be carried out in a simple and accurate way. In case of interconnected ESs, this may not be enough, as the results of this analysis show. A possible solution to monitor the efficacy of the ES over time could be the following procedure:

- STEP 1: measurement of R_{ES} when the ES is still isolated (not interconnected with other ESs), in order to verify that the ES is adequately designed and installed;
- STEP 2: connection of the ES to the earthing network;
- STEP 3: repeating the measurement keeping constant the generator output current.

In the future, if the earthing network is not remarkably changed, it will be sufficient to compare the result of the measurement to the value got at step 3. If no significant

difference is observed, R_{ES} can be considered equal to the value obtained in step 1.

In Fig. 7 and 8, the isolines of the relative percentage error defined by the position of the voltage probe are reported for scenario 1 and 2.

According to these contour plots, it is evident that the errors rapidly decrease moving away from the ES: for both the scenarios, when the voltage probe is placed at (-10, 0), an error of about -20% is obtained.

However, to get $\epsilon_r < 5\%$, a large distance between the ES and the voltage probe is required.

In addition, it can be noticed that the isolines are not symmetrical with reference to the ES. Dividing the ground in four areas (north ($y > 0$), south ($y < 0$), est ($x > 0$), west ($x < 0$)), two asymmetries can be noticed. The first one between the west and east portions of ground with reference to the ES; the second one between the north and west areas. Both are due to the presence of the auxiliary current electrode, which modifies the electric potential profile of the ground with reference to the case in which only the ES is present. According to these results, contrary to what might be thought, it could be more convenient to place the voltage probe along the north or south directions, rather than on the west side. The common practice of placing the voltage probe on the opposite side of the ES with respect to the auxiliary current electrode should be avoided.

From a practical point of view, errors lower than 20% could be considered acceptable, provided that the conditions reported by standards for the observance of permissible touch voltages are largely satisfied [1], [24].

In Fig. 9 and 10, the isolines of the relative percentage error defined by the position of the voltage probe are reported for scenarios 3 and 4 when the FPM is adopted. It can be noticed that for the considered case, the position of the voltage probe does not significantly influence the accuracy of the measurement, which is mainly affected by the distribution of the test current. Small percentage errors can be obtained in the proximity of the auxiliary current electrode. This result cannot be considered always valid, since in real field measurements it is impossible to evaluate if R_{ES} is under- or overestimated.

If the FPM/Clamp is adopted, the isolines are modified as shown in Fig. 11 and 12. At the same distance from the ES under test, the percentage errors are significantly lower, even if still rather high. In this case, the error is due to the modification of the EPP produced by the ESs 7 and 9.

V. FIELD MEASUREMENTS

In order to provide practical examples of the issues reported in section III, the resistance to earth of an MV/LV substation in a city was measured with the FPM.

In particular, the effects of buried metallic parts in the test area are described.

A. Measurement description

A satellite image of the field measurement site is reported in Fig. 13. For confidentiality issues, all geographical references and labels were deleted.

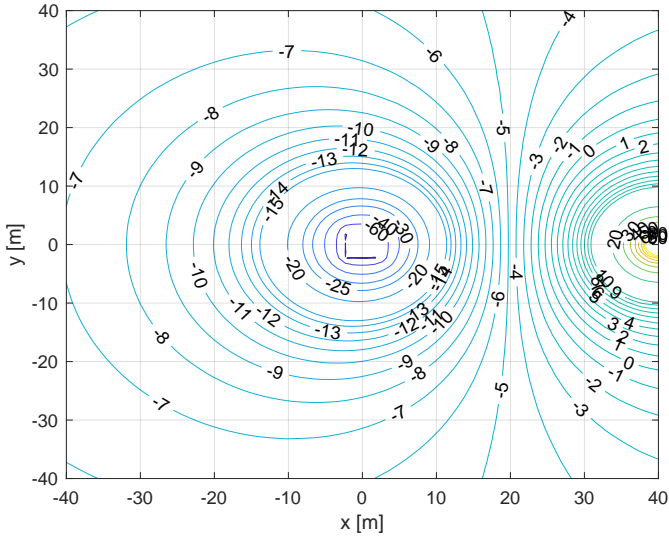

Figure 7. Percentage error ϵ_r of R_{ES} for scenario 1 ($d_C = 40$ m), according to the position of the voltage probe.

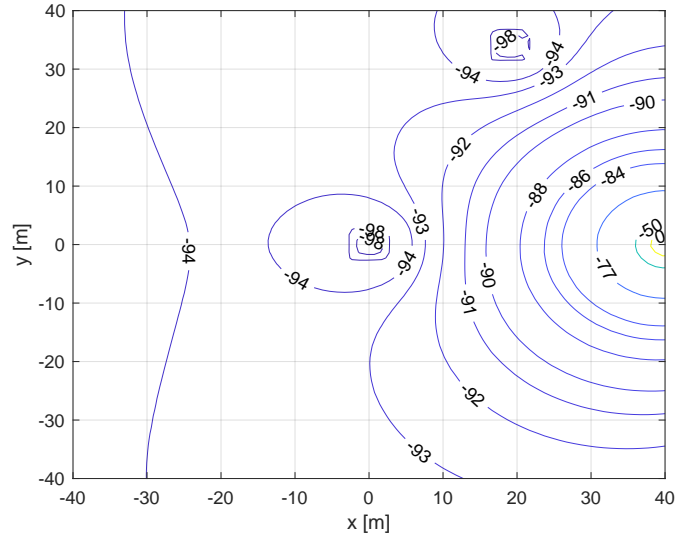

Figure 9. Percentage error ϵ_r of R_{ES} for scenario 3 ($d_C = 40$ m), according to the position of the voltage probe (FPM).

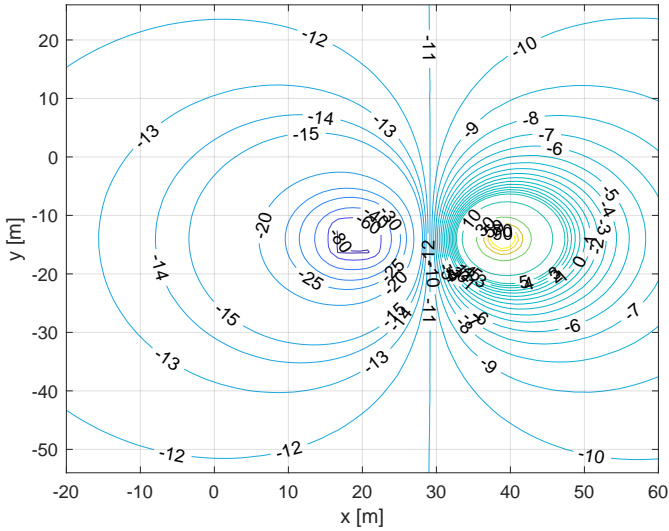

Figure 8. Percentage error ϵ_r of R_{ES} for scenario 2 ($d_C = 20$ m), according to the position of the voltage probe.

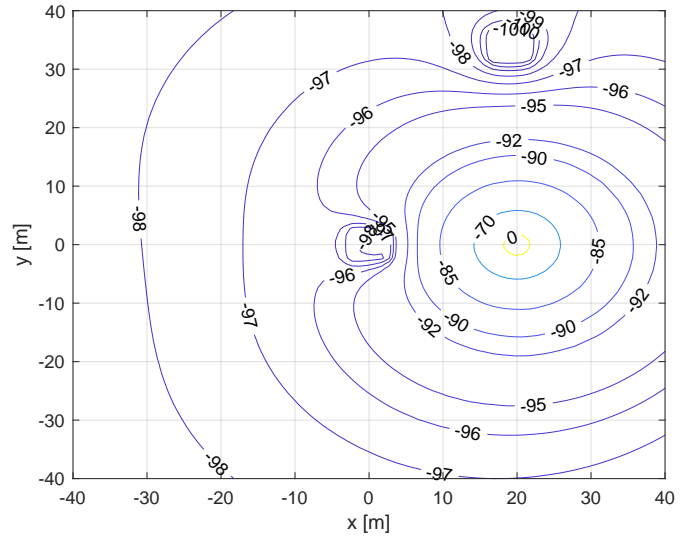

Figure 10. Percentage error ϵ_r of R_{ES} for scenario 4 ($d_C = 20$ m), according to the position of the voltage probe (FPM).

A soil resistivity of $250 \Omega m$ was measured, according to the Wenner four-electrode configuration method.

To measure R_{ES} , a 3 terminal ground resistance tester, specifically designed for FPM, was used.

The ES of the substation under test is formed by a ground ring electrode with a diameter of 5 m, buried at a depth of 0.75 m. Its maximum extension d is 5 m.

In Fig. 13, the MV/LV substation is highlighted with a pink-white oblique lines hatch, while the location of auxiliary electrodes is reported with colored circles. To evaluate how the position of current electrode C and voltage probe P affects the measurement, four different tests were done. The number near the circles identifies the test, the letters C and P stand for current electrode and voltage probe, respectively.

B. Measurement results

The distances of the auxiliary electrode from the MV/LV substation and the values of the resistance R_{ES} measured in the four tests are reported in Table IV.

The set of conditions (1), required by EN 50522, was not completely fulfilled. As often happens, the useful area to place the auxiliary electrodes was too small, due to the presence of

Table IV
MEASUREMENT RESULTS

Test number	d_C	d_P	$[\Omega]$
1	23	38	3.3
2	14	38	0.42
3	30	24	0.96
4	38	19	4.82

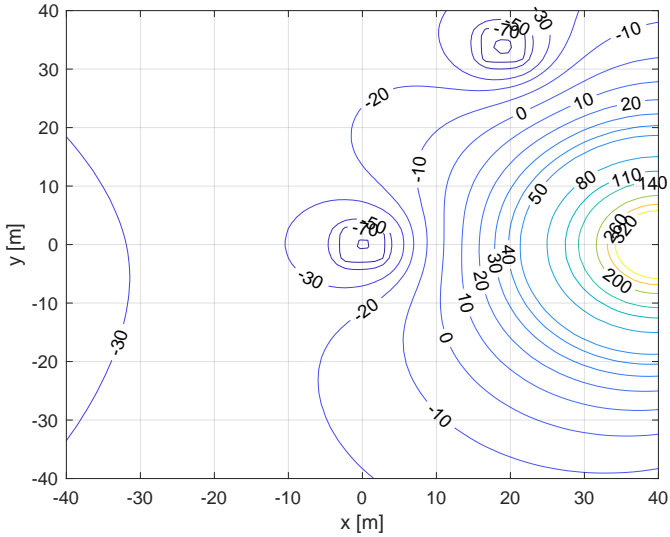

Figure 11. Percentage error ϵ_r of R_{ES} for scenario 3 ($d_C = 40$ m), according to the position of the voltage probe (FPM/Clamp).

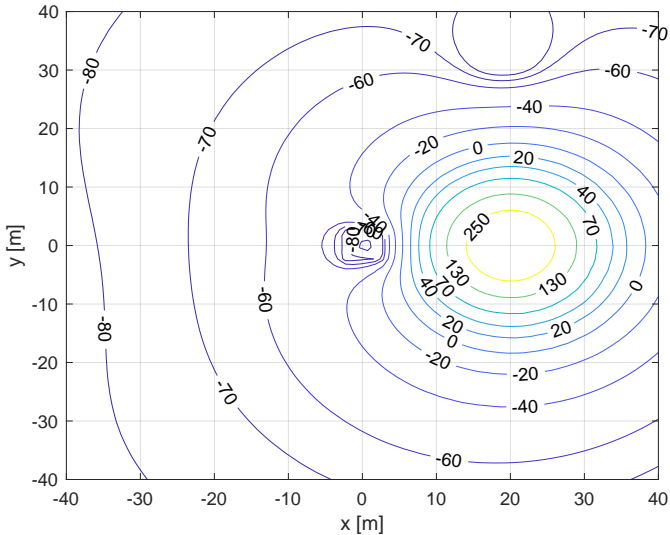

Figure 12. Percentage error ϵ_r of R_{ES} for scenario 4 ($d_C = 20$ m), according to the position of the voltage probe (FPM/Clamp).

streets and buildings.

As shown in Table IV, the position of auxiliary electrodes considerably affects the results. Minimum and maximum values of R_{ES} differ for more than 90%.

In test 2 and 3, the voltage probe was intentionally placed over the MV cable feeding the substation. The low values of R_{ES} are probably due to the presence of bare conductors interconnected with the ES under test, buried together with the power cables, as shown in subsection III-C.

In order to avoid this issue, when the measurements are carried out, the topographic map of the distribution system should be available, together with information on the distribution system characteristics.

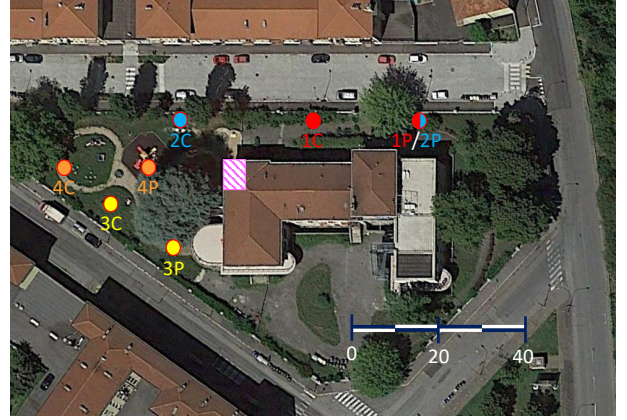

Figure 13. Satellite image of the field measurement site provided by Google Earth. The circles represent the location of auxiliary electrodes. The numbers identify the test number, the letters C and P the current and voltage electrodes, respectively.

VI. CONCLUSION

In urban and industrial areas, in case of a MV single line to earth fault, a single ES plays only a small part in ensuring safety for staff and public. In fact, thanks to the interconnection among ESs made through protective conductors (e.g. MV cable shields), the current injected by a single ES is only a small part of the entire fault current, with a consequent reduction of touch voltages. This effect is the basis of the GES. Unfortunately, the GESs that are officially certified are still few and consequently the observance of permissible touch voltage is often verified through the EPR computation, which requires an estimation/measurement of R_{ES} . To accomplish this task, one of the methods suggested by both EN 50522 and IEEE Std. 81 is the Fall of Potential Method (FPM).

In this paper, theoretical considerations and practical examples of the key-issues that can affect earth resistance (R_{ES}) measurements carried out through the FPM in urban environments were provided.

In order to quantify the error caused by an erroneous positioning of current electrode and voltage probe, and by the presence of buried interconnected ESs, a parametric analysis was carried out by Comsol Multiphysics, a commercial software based on the Finite Element Method.

A comparison between the criteria suggested by EN 50522 and IEEE Std. 81 is carried out for isolated and interconnected ESs. According to the simulation results, if the ES under test is isolated, IEEE Std. 81 method allows lower errors, even if the position of the voltage probe should be accurately chosen. In urban areas, characterized by the presence of buildings and tarmac, the fulfillment of this condition could be very difficult and, for this reason, the authors suggest to bury fixed current and voltage auxiliary electrodes for all the new MV/LV substations. In this way, periodic measurements could be carried out simply and accurately throughout the ES lifetime. If the ES under test is interconnected to other ESs, this could be not enough. For the considered case study, with interconnected ESs, the error is never lower than 75% and can reach 178%. This error can be higher in real scenarios due to the presence of the LV earthing network, not considered in the

simulations presented in this paper, which can modify both the fault current and the potential distribution on the soil surface. The disconnection of the ESs for each periodic measurement is not a practicable solution, as it generally requires to power off the whole MV feeder, which is considered unacceptable for DSOs. Moreover, disconnecting any earth bonds is contrary to best maintenance practice. Therefore, if technically possible, the best option to reduce measurement error is to compute R_{ES} considering the current that flows through the ES under test only (FPM/Clamp). Otherwise, if not possible, the FPM with high frequency tester can be employed to decouple the ES under test. However, even if these techniques are adopted, the measurement error due to the perturbation of the soil surface potential is not eliminated.

Another alternative is to measure R_{ES} twice when the MV feeder is out of service for a scheduled maintenance, keeping constant the test current: in the first measure, the ES is disconnected from the earthing network and R_{ES} can be measured with a small error, allowing to verify that the ES is adequately designed and installed; in the second measure, the ES is interconnected. The obtained value can therefore be associated to that of the disconnected configuration. In this way, it is possible to monitor just the “interconnected” R_{ES} value over the time; if no significant changes are observed on this value, the efficacy of the ES can be considered preserved.

Finally, according to the simulation results of the isolated ES (scenario 1 and 2), and keeping in mind that the presence of buried electrodes in the proximity of the ES under test can play a significant role in modifying the EPP, when the criterion suggested by EN 50522 is adopted, it is more convenient to place the voltage probe not along the direction that connects the ES with the current electrode, due to the non symmetric electric potential profile, but along a perpendicular direction.

Even if the suggestions summarized in this manuscript can minimize the measurement error, the R_{ES} evaluation through the FPM remains difficult in particular contexts, such as for example the urban one. Considering the issues reported in this paper and that an ES plays only a small part in ensuring safety for staff and public in the event of an MV earth fault condition, a more convenient approach is represented by GES.

REFERENCES

- [1] *Earthing of power installations exceeding 1 kV a.c.* EN 50522, 07 2011.
- [2] G. Cafaro, P. Montegiglio, F. Torelli, P. Colella, R. Napoli, E. Pons, R. Tommasini, A. De Simone, E. Morozova, G. Valtorta, A. Barresi, F. Tummolillo, A. Campoccia, M. L. Di Silvestre, E. Riva Sanseverino, G. Zizzo, L. Martirano, G. Parise, and L. Parise, “The global grounding system: Definitions and guidelines,” in *Environment and Electrical Engineering (EEEIC), 2015 IEEE 15th International Conference on*. IEEE, 2015, pp. 537–541.
- [3] P. Colella, E. Pons, and R. Tommasini, “A comparative review of the methodologies to identify a global earthing system,” *IEEE Transactions on Industry Applications*, vol. 53, no. 4, pp. 3260–3267, 2017.
- [4] —, “The identification of global earthing systems: a review and comparison of methodologies,” in *Environment and Electrical Engineering (EEEIC), 2016 IEEE 16th International Conference on*. IEEE, 2016, pp. 1–6.
- [5] G. Parise, L. Martirano, L. Parise, F. Tummolillo, G. Vagnati, A. Barresi, G. Cafaro, P. Colella, M. L. Di Silvestre, P. Montegiglio, E. Morozova, R. Napoli, E. Pons, E. Riva Sanseverino, S. Sassoli, R. Tommasini, F. Torelli, G. Valtorta, and G. Zizzo, “A practical method to test the safety of HV/MV substation grounding systems,” in *Environment and Electrical Engineering (EEEIC), 2015 IEEE 15th International Conference on*. IEEE, 2015, pp. 502–506.
- [6] G. Parise, L. Martirano, L. Parise, S. Celozzi, and R. Araneo, “Simplified conservative testing method of touch and step voltages by multiple auxiliary electrodes at reduced distance,” *Industry Applications, IEEE Transactions on*, vol. 51, no. 6, pp. 4987–4993, 2015.
- [7] *Guide for Measuring Earth Resistivity, Ground Impedance, and Earth Surface Potentials of a Grounding System*. IEEE Standard 81, 12 2012.
- [8] E. Pons, P. Colella, R. Napoli, and R. Tommasini, “Impact of MV ground fault current distribution on global earthing systems,” *Industry Applications, IEEE Transactions on*, vol. 51, no. 6, pp. 4961–4968, 2015.
- [9] E. Pons, P. Colella, R. Tommasini, R. Napoli, P. Montegiglio, G. Cafaro, and F. Torelli, “Global earthing system: Can buried metallic structures significantly modify the ground potential profile?” *Industry Applications, IEEE Transactions on*, vol. 51, no. 6, pp. 5237–5246, 2015.
- [10] P. Colella, R. Napoli, E. Pons, R. Tommasini, A. Barresi, G. Cafaro, A. De Simone, M. L. Di Silvestre, L. Martirano, P. Montegiglio, E. Morozova, G. Parise, L. Parise, E. Riva Sanseverino, F. Torelli, F. Tummolillo, G. Valtorta, and G. Zizzo, “Currents distribution during a fault in an MV network: Methods and measurements,” *IEEE Transactions on Industry Applications*, vol. 52, no. 6, pp. 4585–4593, 2016.
- [11] P. Colella, E. Pons, R. Tommasini, E. R. Sanseverino, M. L. Di Silvestre, and G. Zizzo, “Earth resistance measurements in urban contexts: Problems and possible solutions,” in *2017 IEEE International Conference on Environment and Electrical Engineering and 2017 IEEE Industrial and Commercial Power Systems Europe (EEEIC / I&CPS Europe)*. IEEE, 2017, pp. 1–6.
- [12] A. Campoccia, E. R. Sanseverino, and G. Zizzo, “Analysis of interconnected earthing systems of MV/LV substations in urban areas,” in *Universities Power Engineering Conference, 2008. UPEC 2008. 43rd International*. IEEE, 2008, pp. 1–5.
- [13] G. Cafaro, P. Montegiglio, F. Torelli, A. Barresi, P. Colella, A. De Simone, M. L. Di Silvestre, L. Martirano, E. Morozova, R. Napoli, G. Parise, L. Parise, E. Pons, E. Riva Sanseverino, R. Tommasini, F. Tummolillo, G. Valtorta, and G. Zizzo, “Influence of LV neutral grounding on global earthing systems,” *IEEE Transactions on Industry Applications*, vol. 53, no. 1, pp. 22–31, 2017.
- [14] G. F. Tagg, “Measurement of earth-electrode resistance with particular reference to earth-electrode systems covering a large area,” *Electrical Engineers, Proceedings of the Institution of*, vol. 111, no. 12, pp. 2118–2130, 1964.
- [15] J. Ladanyi and B. Smohai, “Influence of auxiliary electrode arrangements on earth resistance measurement using the fall-of-potential method,” in *Energy (IYCE), 2013 4th International Youth Conference on*. IEEE, 2013, pp. 1–6.
- [16] E. Curdts, “Some of the fundamental aspects of ground resistance measurements,” *Transactions of the American Institute of Electrical Engineers, Part I: Communication and Electronics*, vol. 77, no. 5, pp. 760–767, 1958.
- [17] P. Colella, E. Pons, and R. Tommasini, “MV ground fault current distribution: an analytical formulation of the reduction factor,” in *2017 IEEE International Conference on Environment and Electrical Engineering and 2017 IEEE Industrial and Commercial Power Systems Europe (EEEIC / I&CPS Europe)*. IEEE, 2017, pp. 1–6.
- [18] A. Mujezinovic, A. Muharemovic, I. Turkovic, and Z. Bajramovic, “Application of finite element method in calculation of large and complex grounding systems,” in *Electrical and Power Engineering (EPE), 2012 International Conference and Exposition on*. IEEE, 2012, pp. 688–692.
- [19] V. Cataliotti and A. Campoccia, *Impianti di terra*. TNE, 2013.
- [20] J. Li, T. Yuan, Q. Yang, W. Sima, and C. Sun, “Finite element modeling of the grounding system in consideration of soil nonlinear characteristic,” in *High Voltage Engineering and Application (ICHVE), 2010 International Conference on*. IEEE, 2010, pp. 164–167.
- [21] O. Zienkiewicz, C. Emson, and P. Bettess, “A novel boundary infinite element,” *International Journal for Numerical Methods in Engineering*, vol. 19, no. 3, pp. 393–404, 1983.
- [22] P. Colella, E. Pons, and R. Tommasini, “Dangerous touch voltages in buildings: The impact of extraneous conductive parts in risk mitigation,” *Electric Power Systems Research*, vol. 147, pp. 263–271, 2017.
- [23] A. Stohchniol, “A general transformation for open boundary finite element method for electromagnetic problems,” *Magnetics, IEEE Transactions on*, vol. 28, no. 2, pp. 1679–1681, 1992.
- [24] *IEEE Guide for Safety in AC Substation Grounding*. IEEE Standard 80, 01 2000.