

Composite and Damping Materials Characterization with an Application to a Car Door

Original

Composite and Damping Materials Characterization with an Application to a Car Door / Fasana, A.; Ferraris, Alessandro; Berti Polato, D.; Airale, A. G.; Carello, M.. - STAMPA. - Mechanisms and Machine Science, vol 68:(2019), pp. 174-184. (Intervento presentato al convegno IFToMM ITALY 2018 tenutosi a Cassino (I) nel 29-30/11/2018) [10.1007/978-3-030-03320-0_19].

Availability:

This version is available at: 11583/2723150 since: 2020-04-29T10:29:44Z

Publisher:

Springer

Published

DOI:10.1007/978-3-030-03320-0_19

Terms of use:

This article is made available under terms and conditions as specified in the corresponding bibliographic description in the repository

Publisher copyright

Springer postprint/Author's Accepted Manuscript

This version of the article has been accepted for publication, after peer review (when applicable) and is subject to Springer Nature's AM terms of use, but is not the Version of Record and does not reflect post-acceptance improvements, or any corrections. The Version of Record is available online at: http://dx.doi.org/10.1007/978-3-030-03320-0_19

(Article begins on next page)

Composite and damping materials characterization with an application to a car door

Alessandro Fasana^[0000-0001-5851-9890], Alessandro Ferraris^[0000-0003-0712-3399], Davide Berti Polato^[0000-0001-8241-8192], Andrea Giancarlo Airale^[0000-0002-6857-1008], Massimiliana Carello^[0000-0003-2322-0340]

Politecnico di Torino - Mechanical and Aerospace Engineering Department, Torino, Italy
massimiliana.carello@polito.it

Abstract

This paper presents the characterization of a Carbon Fibre Reinforced Plastic (CFRP) and a couple of damping materials, particularly suited to the manufacturing process of composites. Young's modulus and loss factor of each material are defined by means of the Oberst beam test method, where a specific curve fitting technique replaces the half-power bandwidth procedure to ameliorate the estimates of the parameters. Effects of both temperature and aging are reported, since operational conditions are various and time duration very important for most components, for sure in the automotive sector. Two sandwich beams, formed by the sequence CFRP/damping material/CFRP, are also tested to experimentally verify the effectiveness of this configuration to provide damping. Finally, two complete car doors have been produced with a CFRP composite, with and without an intermediate damping layer. Their modal parameters have been extracted by an experimental modal analysis and show that the damping material can effectively ameliorate the noise and vibration response of the structure.

Keywords: damping materials, automotive application, Oberst test, FEM, NVH, FRF, CFRP Component.,

Introduction

Vehicle manufacturers give large attention to a couple of main constraints: pollutant emission and customer satisfaction. These two limits are directly connected to the light – weight design and vehicle noise reduction. This research combines these two targets, integrating damping material characterization, for comfort improvement, and the use of CFRP composite, in line with the mass reduction trend.

The activity is focused on the definition of structural and damping material properties, as a function of temperature and aging, and then on the effects of damping material on complete CFRP automotive door. Damping materials in this research are provided by KRAIBURG® GmbH and are named SUT 9609 and HHZ 9578.

One of the most interesting characteristic of these products is the possibility to be simply integrated in the production process of the composite. Patches of damping

material can be positioned directly between CFRP layers, with no additional manufacturing step. This characteristic makes these materials very interesting to enhance the damping properties of laminates, with almost null production time increment.

Material characteristics are determined in accordance to the Oberst test method [1]. Integrating the test bench in a climatic cell, the tests are performed at different temperatures and at different aging steps. Two complete car doors have been produced, with and without a sandwiched layer of damping material. A comparison of their experimental modal properties and frequency response functions gives an indication of the beneficial effects of damping.

Experimental test methodology

The Oberst test method is chosen in this research to determine elastic modulus and damping properties of materials. This test allows to define material characteristics by maintaining the specimen completely in the elastic region, thus avoiding plastic deformation as in [2–4]. Each sample can then be repeatedly tested so to obtain also an evaluation of aging effects on materials.

The Oberst test specimen consists in a cantilever beam, excited in defined frequency range (0 – 2000 Hz, in the current case). The output (displacement) is measured by a contact-less capacitive sensor and yields the natural frequencies and damping ratios of the beam. The geometric and mass properties of specimens, combined with the Bernoulli-Euler beam model, then give Young's modulus and loss factor of the material. Tested samples are (Table 1):

- Structural Base: a CFRP beam with no damping material. The base is made of 3 layers of Twill 300 (280gg) from Angeloni® CFRP composite fabric. With this beam, the elastic and damping characteristics of the CFRP material can be evaluated;
- One side damped beam: The base beam is covered by damping material on one side (Figure 1, top). With this beam, the elastic and damping characteristics of the damping material can be evaluated;
- Sandwich layout: a layer of damping material is included in the CFRP structure (Figure 1, bottom). This specimen is not usually adopted to evaluate the damping material characteristics but, on the other hand, this configuration is practically very interesting because it may be much more effective than the single free layer arrangement, as far as damping is concerned.

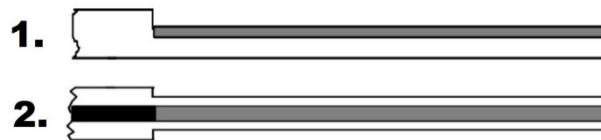

Figure 1. Sample layout: 1. Beam damped one side, 2. Sandwich layout

The bench test used for the experiment (Figure 2) is made of a massive steel base (14.6 kg) to avoid any vibration of the clamped end (right hand side, Figure 2). Free length of specimen was set to 200 mm and the excitation was given at about 20% of the length by an electromagnetic contact-less exciter (B&K MM002). In this position, the input was given far from the nodes of the first mode shapes, so to conveniently excite the natural frequencies. The beam response was recorder at the free-end by a contact-less capacitive sensor. The excitation was a swept sine signal, ranging from 1 Hz to 2000 Hz, which is almost the maximum frequency of the exciter. This range guarantees the excitation up to the fifth natural frequency, while the first mode has been discarded [1]. The sampling frequency was four times larger than the maximum exciting frequency and swept duration was fixed at five minutes permitting a good trade-off between data reliability, measuring time and temperature variations in the climatic chamber.

Aim of this research is also the comparison of two damping materials, to define the best compromise between damping and mechanical characteristics at different temperatures and aging steps. Both materials are rubber-based compounds, produced in thin and flexible sheets which can simply be integrated in a CFRP stacking sequence. Vibrational characteristics of a vehicle are fundamental in the quality customer perception; therefore, a damping material should work as long as possible in each environment, sustaining different climatic conditions. For that reason, Oberst tests have been performed at different temperatures and aging steps, in a climatic chamber. Thermal tests have been performed between -20°C and $+60^{\circ}\text{C}$ with steps of 10°C , thus covering most of climatic situations sustained by vehicles for major part of their lives, as indicated in [5]. As shown in Figure 3, the test bench remained at constant temperature for 1.5 hours in order to reach the thermal equilibrium before running the test.

The aging effects on damping materials have been investigated with the cycle indicated in [6]. Temperature [$-30/+80^{\circ}\text{C}$] and humidity [70/90 %] variations are reported in Figure 4. The Oberst test has been repeated on the same specimen, after 0/264/528/792 hours, i.e. after 0/11/22/33 days of the accelerated aging cycle. Three beams for each configuration and material (15 in total) have been studied, and the showed results are averages over three specimens.

Table 1. Characteristics of the beams (average of three specimens)

Material	Layers	Thickness [mm]	Width [mm]	Length [mm]	Mass [g]	Density [kg/m^3]
CFRP	3	0,91	12,81	259,88	3,93	1305
One side SUT 9609	3 + 1	1,96	12,84	259,77	8,25	1259
One side HHZ 9578	3 + 1	1,85	12,72	260,23	9,58	1568
Sandwich SUT 9609	2 + 1 + 2	1,72	12,74	259,75	7,44	1308
Sandwich HHZ 9578	2 + 1 + 2	1,64	12,69	259,71	7,98	1471

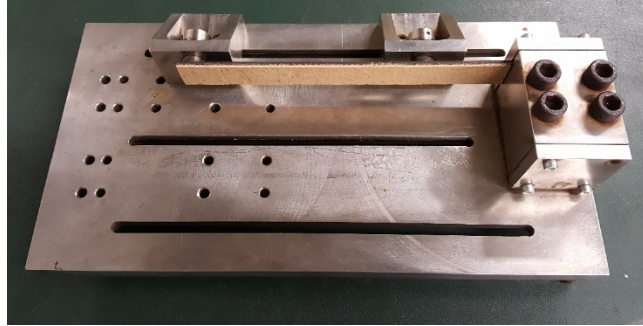

Figure 2. Oberst test bench

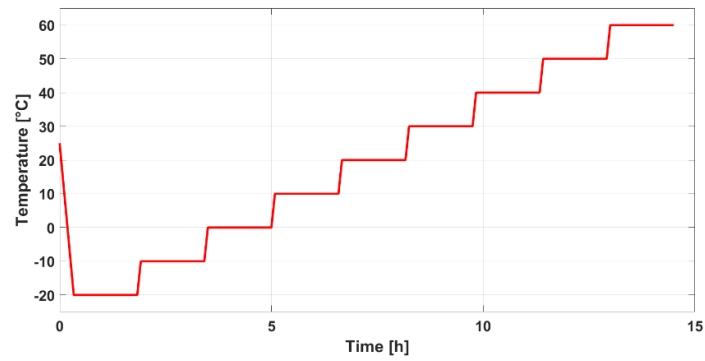

Figure 3. Controlled temperature diagram for the Oberst test

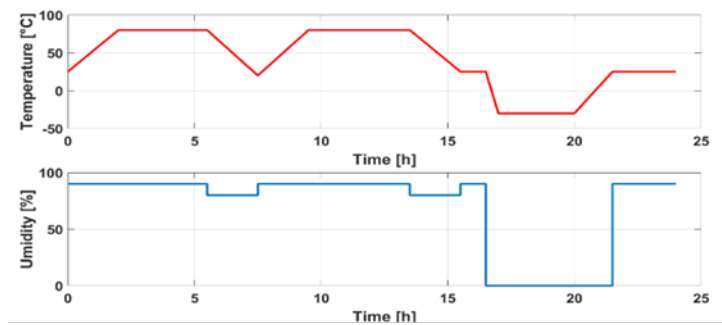

Figure 4. Controlled temperature - humidity diagram for the aging cycle

Analysis

A classical method for estimating the natural frequency and damping ratio of a single degree of freedom system, apart from the time domain logarithmic decrement

method [7], is the half-power method also called -3 dB method (1,8), based on the Frequency Response Function (FRF). The method is very popular due to its very simple application, but its results may be wrong when very low or very high damped structures are under test. These cases are indeed typical of a CFRP beam (structural base, low damping) and a sandwich layout (high damping), so that a different technique has been applied (9). Basically, the new technique fits the model of the measured output (displacement) of the beam, with the following advantages:

- 1) Many spectral lines are used, which gives a least square solution for both frequency and damping;
- 2) It can be applied to lightly and highly damped structures;
- 3) A synthesized FRF can be plotted to visually verify if it correctly fits the original data.

Damping material comparison

This section presents the experimental results, obtained as an average over the three specimens, of the five considered configurations: one structural base beam, two damped one side beams, two sandwich beams.

Structural beam

The structural base beam is made of three layers of T300 (twill 200gr/m²) carbon fibre reinforced plastics in epoxy matrix, and all specimens are obtained from the same plate in order to avoid scattering due to production process. The expected aging and thermal behaviour of CFRP is completely confirmed from the results shown in Figure 5: its characteristics remain almost constant at any temperature and don't show any aging effect. The obtained loss factor is very low, confirming the NVH (Noise Vibration and Harshness) criticalities generated by the increasing use of composites in vehicles [10–12]. The external aspect of CFRP remains unchanged after 792 hours of aging cycle, confirming that use on external automotive panels is not critical, at least from an aesthetic point of view.

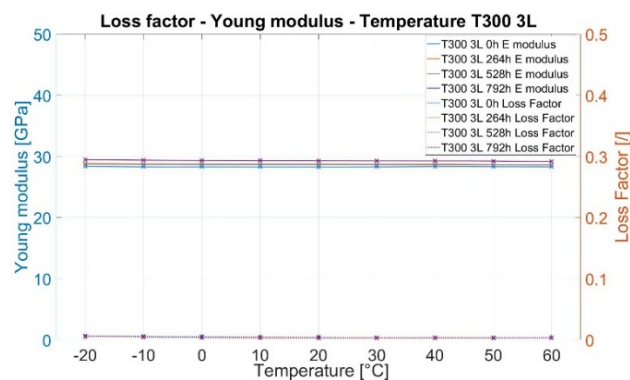

Figure 5. Young's modulus and loss factor of T300 CFRP – temperature

One side damped beam

The beam is made of 3 layers of CFRP, with the same stacking sequence of the structural beam, and a single layer of almost one millimeter of SUT 9609 or HHZ 9578. This is the configuration recommended by [1,5] to correctly characterize the material. It should be noted that no adhesive layer is required to form the laminate because of the common curing process of the materials, and then bonding issues [13,14] are avoided.

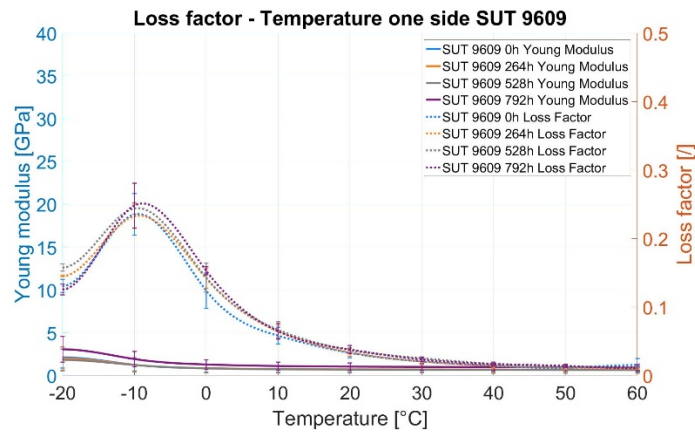

Figure 6. Young's modulus - loss factor - temperature for SUT 9609

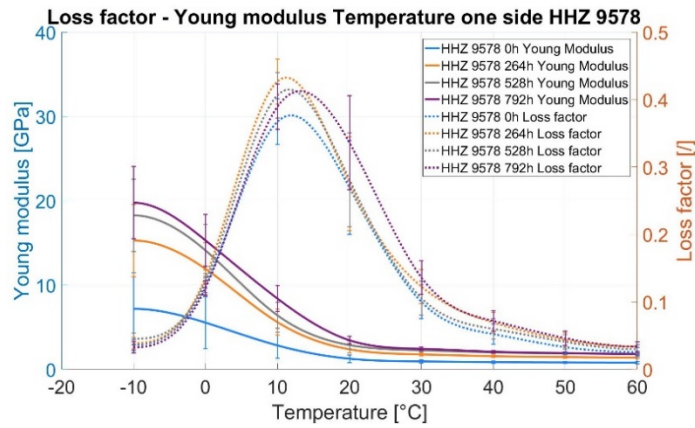

Figure 7. Young's modulus - loss factor - temperature for HHZ 9578

Curves in Figure 6 and 7 present the properties of damping materials, as a function of temperature and aging step. Temperature strongly affects both materials: SUT 9609 shows its maximum loss factor (≈ 0.25) around -10°C , while damping peak

(0.4) is between 10°C and 20°C for HHZ 9578. As regards Young's modulus, both materials show a viscoelastic characteristic, with maxima in the low temperature range. HHZ 9578 curves start at -10°C because at lower temperatures specimens are so bended, because of material shrinking, to impede data acquisition.

In particular, HHZ 9578 shows a manifest increment of elastic modulus at each aging step. Variations of loss factor with time are also present but remain lower than data scattering. SUT 9609 presents a behaviour which is almost unaffected by aging. In fact, both the elastic modulus and loss factor remain inside data scattering for all aging tests. This indicates a good material stability, which is an important characteristic for actual applications.

It is worth noticing that loss factors and Young's modulus are averaged over three specimens and over the measured modes of the Oberst beam. This is the reason of sometimes large variations of results around the mean values.

Sandwich beam

The characteristics of sandwich beams are analyzed by considering the entire specimen as a single equivalent material, so to verify its effectiveness in practical applications. Specimens are formed of two laminates of CFRP (T300) and one layer of damping material in the middle (thicknesses in Table 1). The procedure to manufacture these specimens is the same as for a standard undamped laminate. A layer of damping material is simply added in the stacking sequence, and the composite then undergoes a standard curing process.

The resulting behaviour (Figures 8 and 9), which is common to both materials, is the drastic variation of elastic modulus between 0 h and 264 hours of aging cycle. HHZ 9578 shows some differences of the loss factor, while SUT 9609 sandwich is almost unaffected by aging cycle.

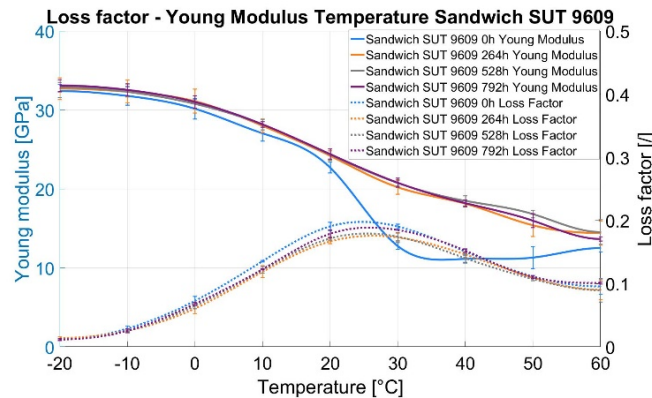

Figure 8. Young's modulus - loss factor -temperature sandwich SUT 9609

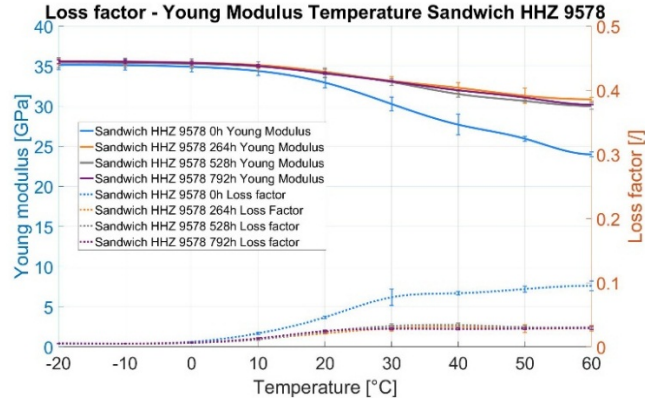

Figure 9. Young's modulus - loss factor -temperature sandwich HHZ 9578

The behaviour of both sandwiches is completely different from the pure material characteristics highlighted in Figures 6 and 7. HHZ 9578 sandwich beam shows almost constant properties, with limited damping potential. On the contrary, SUT 9609 exhibits quite typical temperature variations: Young's modulus decreases while the loss factor, with significant values of 0.1-0.2, reaches its maximum at about 25°C.

Considering the higher damping capability and the temperature working range, which is interesting for commonly used vehicles, SUT 9609 has been chosen to build the car door components presented in following section.

Car doors

Carbon fiber doors of sport cars are very lightweight components that, because of the almost null damping properties of the material, do not effectively contribute to the noise and vibration comfort within the vehicle as described in (15) and (16). Doors are usually formed by two elements, the internal and the external parts, which are separately manufactured, and eventually bonded along their borders by an adhesive layer.

This same process has been employed to produce the parts represented in Figure 10, and finally the doors. These elements are composed by 6 layers of CFRP (T300, 0/90°) for a total mass of 2.09 kg. Similar panels have also been produced by adding, at the center of the stacking sequence, a layer of SUT 9609, 0.5 mm thick, for a total mass of 2.24 kg (7% increment). Details can be found in [18].

First the internal and external parts, and then the complete door, have undergone an experimental modal analysis (17–19). In brief, a random excitation in the 0-400 Hz band was given through a shaker and the corresponding accelerations were recorded in 42 points for each panel, with free-free conditions.

An example of results is given in Figure 11, showing the first mode shape of the external panel, in both the undamped and damped cases, where nodal lines can be

spotted along the x and z axes. Differences are present in mode shapes and have been quantified by calculating the Modal Assurance Criterion (MAC):

$$MAC_{DU} = \frac{|\{\psi_D\}^T \{\psi_U\}^*|^2}{(\{\psi_D\}^T \{\psi_D\}^*)(\{\psi_U\}^T \{\psi_U\}^*)} \quad (1)$$

Where: $\{\Psi\}$ is the mode shape, the subscript indicates Undamped and Damped components, T stands for transposed and * for conjugated. MAC is equal to one when a perfect correspondence between modes is obtained and goes to zero when modes are orthogonal.

By using many modes, of both damped and undamped parts, a MAC matrix can be defined in order to quantify their resemblance. Figure 12 displays a representation of MAC matrices for the external panel (12a) and for the complete door (12b). X and Y axes give the natural frequency of the undamped and damped components and the vertical bars indicate MAC values. In particular, Figure 12a points out that mode at 24 and 29 Hz of the undamped external panel are only partly similar to the single damped mode at 29 Hz. The remaining modes are similar both in frequency and shape. The damping material, although very flexible, widens the distance between the carbon fiber layers and then increases the area moment of inertia of the composite. The combination of these two opposite factors, together with the increment of mass, does not really alter the natural frequencies of the component in the damped/undamped layouts.

The advantageous effects of damping are clearly shown in Figure 13. The FRFs between each output (acceleration, 84 points) and the single input (force) have been computed and their modulus have been summed. This sum gives an indication of the total output of the door, as regards both frequencies and amplitudes. Not only the peaks of the damped door (red dashed line) are generally lower than resonances of the undamped layout but also the overall damped FRF is well below the original curve. This result is interesting also when sound harshness is concerned, since the response of the door is largely reduced in the high frequency range. A comprehensive study of the acoustic response of the components has not been carried out so that it is impossible to quantify the influence of the damping material on sound emission. A hint on the impact of the SUT 9609 layer on sound can be given by listening to these registrations (undamped & damped).

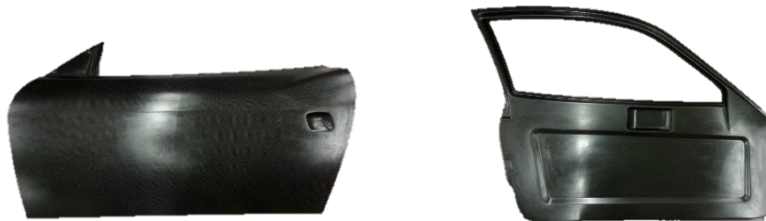

Figure 10. The internal and external parts of the door

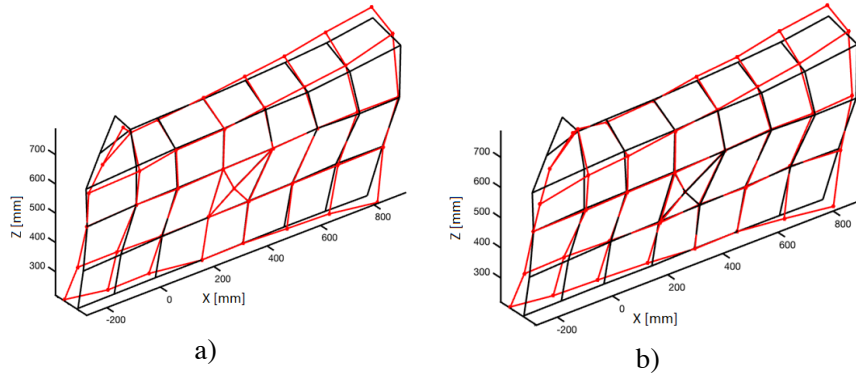

Figure 11. First mode shape of the external panel
 a) undamped b) damped with SUT 9609
 Black lines: undeformed geometry – red lines: mode shape

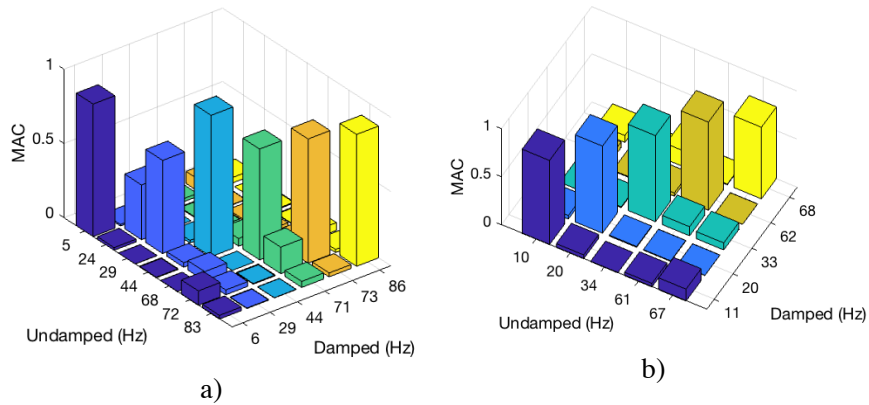

Figure 12. Graphical representation of mac matrix
 a) external panel b) door

A more quantitative description can be given by the damping ratios. Even in the low frequency range, where resonance peaks are still very evident, the damping material produces good results (Table 2). Above 200 Hz, the response of the damped door is so limited to barely show resonances.

A global quantification can also be given by considering the overall values of the two FRFs represented in Figure 13, i.e. the sum of all their spectral lines: the ratio of these values is 2.7. In the 0-400 Hz frequency range, the amplitude of the response of the undamped door is therefore 2.7 times larger than in the damped configuration.

The previously introduced characterization of materials would be very useful to analyse the dynamics of the doors by using a Finite Element Model (FEM). An effective FEM would allow, for example, to optimize dimensions and positions of the damping layers. Unfortunately, as discussed in [18], it was impossible to rely on the CAD model at disposal to build an accurate FEM. In fact, its geometrical precision was so poor to require a very cumbersome refinement to reach an acceptable comparison with the experimental results even in the simple case of the outer undamped panel.

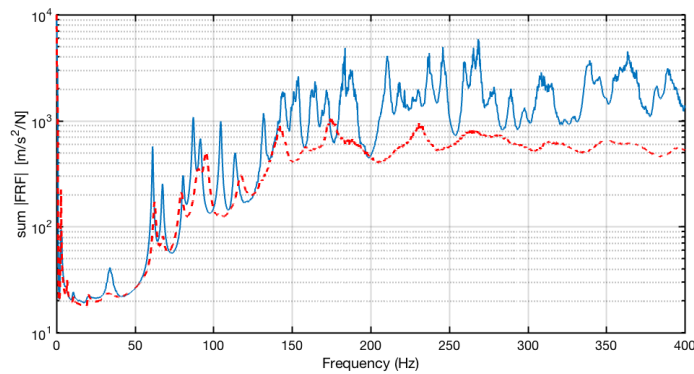

Figure 13. Sum of the FRFs of the door solid line: no damping; dashed line: SUT 9609

Table 2. Damping ratios of the two doors

	Mode 1	Mode 2	Mode 3	Mode 4	Mode 5
Undamped	5.3	3.6	5.2	0.4	0.8
Damped	2.7	3.6	14.8	1.2	1.8

Conclusions

The paper presents the characterization of a CFRP composite, produced by Angeloni®, and two rubber based materials, produced by KRAIBURG® GmbH and named SUT 9609 and HHZ 9578. The Oberst beam technique has been chosen because it is a non-destructive test method that allows the same specimens to be repeatedly used. This is important in order to characterize the materials not only as a function of temperature but also of time. In fact, all specimens underwent an accelerated aging process to verify their capability of maintaining constant properties during their working life. The results are particularly encouraging for one of the two damping materials (SUT 9609) which has consequently been chosen to manufacture a car door. This material is simply combined with CFRP layers because its formu-

lation is compatible with the resins of the carbon fibre fabric and can then be submitted to the same curing process (20,21). Two advantages are obtained: first, no extra adhesive films are required between the layers but a perfect cohesion is obtained by the curing process; second, no variation is imposed to the production process of the sandwich, since the damping material is produced in thin, flexible sheets, and can be handled as a carbon fibre layer. The comparison of the modal properties of two similar doors, with and without SUT 9609, shows that even a small layer of damping material can have a very positive impact on the sound and vibration response of the components and can be a viable solution for NVH problems.

References

- [1] American Society for Testing and Materials International. ASTM E756 – 05 (Reapproved 2010). Standard Test Method for Measuring Vibration-Damping Properties of Materials. 2010.
- [2] Fagone M, Loccarini F, Ranocchiai G. Strength evaluation of jute fabric for the reinforcement of rammed earth structures. *Compos Part B Eng.* 2017 Mar;113:1–13.
- [3] Mastali M, Dalvand A, Sattarifard A. The impact resistance and mechanical properties of the reinforced self-compacting concrete incorporating recycled CFRP fiber with different lengths and dosages. *Compos Part B Eng.* 2017 Mar;112:74–92.
- [4] Pach J, Pyka D, Jamroziak K, Mayer P. The experimental and numerical analysis of the ballistic resistance of polymer composites. *Compos Part B Eng.* 2017 Mar;113:24–30.
- [5] SAE International. SAE J1594 JUL2010 Vehicle Aerodynamics Terminology. 2010.
- [6] IEC 60068 - 2 - 1 International Electrotechnical Commission, International standard for Environmental testing.
- [7] Tweten DJ, Ballard Z, Mann BP. Minimizing error in the logarithmic decrement method through uncertainty propagation.
- [8] Papagiannopoulos GA, Hatzigeorgiou GD. On the use of the half-power bandwidth method to estimate damping in building structures. *Soil Dyn Earthq Eng.* 2011 Jul;31(7):1075–9.
- [9] Fasana A, Ferraris A, Airale AG, Berti Polato D, Carello M. Oberst and aging tests of damped CFRP materials: Fitting procedure and experimental results. *Compos Part B Eng* [Internet]. 2018 Apr [cited 2018 Apr 27]; Available from: <http://linkinghub.elsevier.com/retrieve/pii/S1359836817338507>
- [10] Govindswamy K, Wellmann T, Eisele G. Aspects of NVH Integration in Hybrid Vehicles. *SAE Int J Passeng Cars - Mech Syst.* 2009 May 19;2(1):1396–405.
- [11] Eisele G, Wolff K, Wittler M, Abtahi R, Pischinger S. NVH of Hybrid Vehicles.
- [12] Fasana A, Carello M, Ferraris A, Airale A, Polato DB. NVH Analysis of Automotive Components: A Carbon Fiber Suspension System Case. In: Boschetti

G, Gasparetto A, editors. *Advances in Italian Mechanism Science* [Internet]. Cham: Springer International Publishing; 2017 [cited 2017 Jun 16]. p. 345–54. Available from: http://link.springer.com/10.1007/978-3-319-48375-7_37

[13] Bai JM, Sun CT. The Effect of Viscoelastic Adhesive Layers on Structural Damping of Sandwich Beams*. *Mech Struct Mach*. 1995 Jan;23(1):1–16.

[14] Burlayenko VN, Sadowski T. Influence of skin/core debonding on free vibration behavior of foam and honeycomb cored sandwich plates. *Int J Non-Linear Mech*. 2010 Dec;45(10):959–68.

[15] Al-Zubi MA, Ayorinde EO, Dundar MA, Warriach M, Murty Y. Vibro-Acoustic Characterization and Optimization of Periodic Cellular Material Structures (PCMS) for NVH Applications. *J Mater Sci Res* [Internet]. 2013 Sep 5 [cited 2017 Jun 15]; 2(4). Available from: <http://www.ccsenet.org/journal/index.php/jmsr/article/view/27761>

[16] Gur Y, Wagner D. Damping properties and NVH Modal Analysis Results of Carbon Fiber Composite Vehicle Components. *SAE Int J Mater Manuf* [Internet]. 2017 Mar 28 [cited 2018 Apr 27];10(2). Available from: <http://papers.sae.org/2017-01-0500/>

[17] Yang S, Gibson RF, Gu L, Chen W-H. Modal parameter evaluation of degraded adhesively bonded composite beams. *Compos Struct*. 1998 Sep;43(1):79–91.

[18] Fasana A, Ferraris A, Airale AG, Berti Polato D, Carello M. Experimental Characterization of Damped CFRP Materials with an Application to a Lightweight Car Door. *Shock Vib*. 2017;2017:1–9.

[19] Maia NMM, Montalvão e Silva JM, editors. *Theoretical and experimental modal analysis*. Taunton, Somerset, England : New York: Research Studies Press ; Wiley; 1997. 468 p. (Mechanical engineering research studies).

[20] Nobili A, Signorini C. On the effect of curing time and environmental exposure on impregnated Carbon Fabric Reinforced Cementitious Matrix (CFRCM) composite with design considerations. *Compos Part B Eng*. 2017 Mar;112:300–13.

[21] Kim K-W, Kim D-K, Kim B-S, An K-H, Park S-J, Rhee KY, et al. Cure behaviors and mechanical properties of carbon fiber-reinforced nylon6/epoxy blended matrix composites. *Compos Part B Eng*. 2017 Mar;112:15–21.

ACKNOWLEDGMENTS

The authors wish to acknowledge: Gummiwerk KRAIBURG GmbH for the damping material “KRAIBON® SUT9609/24 and HHZ 9578” and the active support during all the activity and G. Angeloni® S.R.L. for the structural CFRP material.