

A new genetic algorithm model-based prognostic approach applied to onboard electrohydraulic servomechanisms

Original

A new genetic algorithm model-based prognostic approach applied to onboard electrohydraulic servomechanisms / Dalla Vedova, M. D. L.; Bonanno, G.; Maggiore, P.. - In: WSEAS TRANSACTIONS ON ENVIRONMENT AND DEVELOPMENT. - ISSN 1790-5079. - ELETTRONICO. - 13:(2017), pp. 431-440.

Availability:

This version is available at: 11583/2704231 since: 2018-03-23T23:48:05Z

Publisher:

World Scientific and Engineering Academy and Society

Published

DOI:

Terms of use:

This article is made available under terms and conditions as specified in the corresponding bibliographic description in the repository

Publisher copyright

(Article begins on next page)

A New Genetic Algorithm Model-Based Prognostic Approach Applied to Onboard Electrohydraulic Servomechanisms

M. D. L. DALLA VEDOVA G. BONANNO P. MAGGIORE

Department of Mechanical and Aerospace Engineering

Politecnico di Torino

Corso Duca degli Abruzzi 24 – 10129, Turin

ITALY

matteo.dallavedova@polito.it

Abstract: - The ever green solution of the electro hydraulic actuator (EHA) applications for the control of modern primary flight commands, justified by the superiority of hydraulic systems in furnishing more efficient solutions for power supplying in a controlled manner, brings us to focus on the need to make the EHA as efficient and reliable as possible. To this purpose, it must be noted that reliability of modern systems is increasingly more based on the valid support of diagnostics and prognostics; in fact, these two are the most robust instruments which mitigate life cycle costs without losing reliability and guarantee, in compliance with regulations, the bases for health management of integrated components, subsystems and systems. Developing a fault detection algorithm able to identify the precursors of EHA faults and their degradation patterns is thus beneficial for anticipating the incoming failure and alerting the maintenance crew so as to properly schedule the servomechanism replacement. About that, this paper proposes a new EHA model-based fault detection and identification method (FDI) that makes use of deterministic and heuristic solvers in order to converge to the actual state of wear of the tested actuator. The proposed FDI algorithm has been tested on three different types of progressive failures (the clogging of the first stage of the flapper-nozzle valve, the rising of friction between spool and sleeve and finally the rising of friction between jack and cylinder): to this purpose, a dedicated simulation test environment was developed. Results showed an adequate robustness and a suitable confidence was gained about its ability to early identify EHA malfunctions with low risk of false alarms or missed failures.

Key-Words: - EHA, aeronautical servomechanism, numerical modeling, fault detection/identification (FDI), prognostics, genetic algorithm.

1 Introduction

The principal aim of a servo-actuator is to convert the different power sources available depending on the general concept of design (mechanical, electrical, hydraulic or pneumatic source), into a controlled motion of specific parts of the aircraft in order to meet operative needs. The most common and intuitive application of servo-actuators is the controlled movement of mobile surfaces of the aircraft for the actuation of primary commands. Such an example is particularly explicative of the high level of criticality of such a component, suggesting how the critical aspect of the reliability of this kind of system is particularly under discussion and is frequently a subject matter when tackling airworthiness. Up to now, the usual solution to guarantee an adequate level of reliability was delivered to the scheduling of a rigorous program of maintenance that should guarantee that an actuation system continues to operate in the normal range of safety conditions.

However, such an approach could not prove efficient. By the way, the scheduling of costly maintenance is not related to the effective conditions of wear of the actuator, but just to the expectations of degeneration related to the system lifetime previsions. On the other hand, extreme and unexpected operative scenarios may lead to damage and unscheduled maintenance. Therefore, this type of approach in some cases could lead to the increasing of the risk to use damaged system or the increasing of the cost to maintain operative systems that in a good state. An alternative strategy to perform an efficient maintaining procedure could consist in monitoring the functional parameters of the system under discussion and to determine its state of health by observing and studying the deviation of its response from the original one, and, in general, to get evidence of an anomalous behavior. It must be noted that the prediction of this kind of failures should be guaranteed at a high level of reliability.

1.1 Prognostics and Health Management

The practice of monitoring and analyzing the system's response (through electrical acquisition) and, then, to provide an evaluation of the evolution of the fault, has gradually become an important task of the system engineering, till to generate a new discipline, generally known as Prognostics, having the purpose to predict the moment in which a certain component loses its functionality and is not further able to meet desired performances. It is based on analysis and knowledge of its possible failure modalities and on the capability to individuate the first signs of aging or wear and, then, evaluate the magnitude of such damage (i.e. fault detection and identification FDI). The aforesaid data will be then used as input of a proper failure propagation model. Vachtsevanos et al [1] put in evidence as the use of this discipline in aeronautics, as in many other technological fields, could be very useful if applied to maintenance, since it lowers both costs and inspection time. In order to optimize these advantages, the discipline known as Prognostics and Health Management (PHM) originated: its purpose, as reported by Byington, Watson, Edwards, and Stoelting [2], is to provide real-time data on the current status of the system and to calculate the Remaining Useful Life (RUL) before a fault occurs or a component becomes unable to perform its functionalities at a desired level. Given that prognostics are typically related to mechatronic systems having a complex non-linear multidisciplinary behavior, literature proposes a wide range of fault detection and identification (FDI) strategies. Among these, it is possible to mention model-based techniques centered on the direct comparison between real and monitoring system [3], on the spectral analysis of well-defined system behaviors performed by Fast Fourier Transform [4-5], on appropriate combinations of these methods [6] or on algorithms based on several architectures of Artificial Neural Networks [7-11].

The advantages gained by means of PHM strategies are evident especially comparing the features of a system designed according to this discipline with the ones based upon a classical approach. The primary flight controls are a critical feature of the aircraft system and are therefore designed with a conservative safe-life approach which imposes to replace the related components subsequently to a certain number of flight hours (or operating cycles): clearly, this approach is not able to evaluate the effective status of the items (and, then, to assess their ability to continue to operate correctly) but, merely, requires the aforesaid maintenance operations.

In particular, the aforesaid design criterion is not able to evaluate possible initial flaws (occurred during manufacturing) that could generate a sudden fault which could compromise the safety of the aircraft and don't allow to replace only the really failed components (with the related inefficiencies and additional costs). Instead, in a system suitably conceived taking into account the PHM strategies, failures could be managed in a more proper way, obtaining the following advantages:

1. lower operating costs;
2. less maintenance interventions are required;
3. lower number of redundancies installed onboard;
4. aircraft safety and reliability are improved;
5. maintenance activities can be planned optimizing the necessary actions (limiting downtime and related costs and allowing a more effective organization of maintenance and management of spare parts warehouses) and reducing logistical difficulties resulting from these faults.

The research presented in the paper, referring to the considerations reported by Borello et al. [3] and by Maggiore et al. [12], is focused on the development of a fault detection/identification (FDI) method able to identify failure precursors (alerting that the system is degrading) and to evaluate the damage entity; in fact, a progressive degradation of a system component, which does not initially create an unacceptable behavior, often leads to a condition in which the efficiency of such component is impaired and hence the whole actuation system operation could be compromised. In order to develop this research, a typical aircraft primary command electro hydraulic actuator has been modelled in the MATLAB Simulink® environment and several sets of simulations (in nominal conditions or with various failures) have been run.

2 Aim of Work

The aim of this paper is to present an innovative way to perform the diagnosis of an electro-hydraulic servo-actuator with flapper-nozzle valve. To this purpose, a new FDI algorithm based on the Genetic Algorithms (GA) is proposed, optimized and then validated through the comparison between the behavior of the real system (affected by progressive faults) and the corresponding numerical EMA virtual test-bench, conceived and modeled for the purpose. In particular, the proposed method merges together deterministic and GA algorithms to guide the iterative combination of simulated faults to the one that, compatibly with the accuracy of the monitoring model and its capacity to evaluate faults, represent the actual state of health of the actuator.

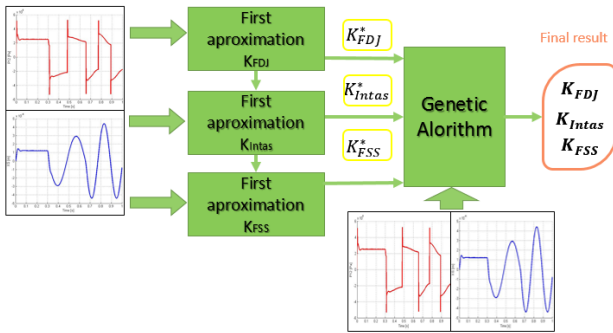

Fig. 1: Concept schematic of the proposed FDI method

In order to evaluate the accuracy of the prediction at the different conditions and to assess the field of validity of this method, several combinations of progressive faults have been considered. According to hypothesis reported in [13], authors evaluate the following progressive faults: clogging of the SV first stage, dry friction acting between spool and sleeve and dry friction acting on the linear actuator. Operatively speaking, the proposed FDI procedure is made up of two steps (schematically represented in Fig. 1): in the first step, the solver finds a first approximation of the damage combination by minimizing several fitness functions basing the research on peculiar aspects of the dynamic response to a certain command (open-loop or close-loop test command), whereas, in the second step, the founded combination is used as basic information to initialize the heuristic process. This aims to minimize the fitness function that calculates the discordance between the reference response and the one provided in each iterative simulation by the monitoring model. The parameters representing the amount of the considered faults ($K_{FDJ}, K_{Intas}, K_{FSS}$)¹ are normalized in order to vary linearly from zero (original fully integral or ideal condition) to one (limit fully damaged condition).

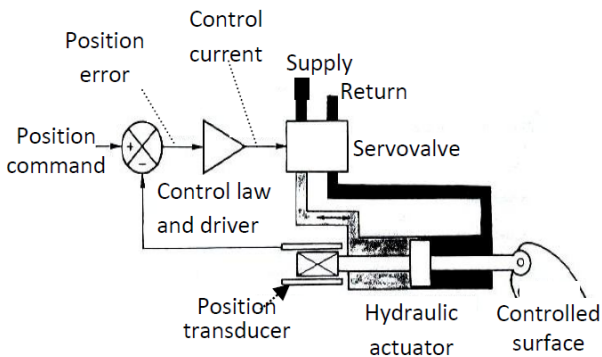

Fig. 2: Schematic of the considered EHA actuator

¹ Respectively: dry friction acting on the linear actuator (K_{FDJ}), clogging of the SV first stage (K_{Intas}) and dry friction acting between SV second stage spool and sleeve (K_{FSS}).

3 Reference EHA Numerical Model

The purpose of flight controls is to modify the shape of aerodynamic surfaces (both wing and empennage) in order to obtain control torques or forces that permit pilot to manage the aircraft. A distinction occurs between primary and secondary flight controls. Primary flight controls are proportional controls with continuous activation: they must return a force feedback related to command intensity and a high frequency response. Since their loss is a critical issue, their reliability must be very high. Their purpose is to modify the trajectory of the aircraft by generating unbalanced forces that rotate the plane. Conventional controls are made to obtain a rotation about one of the three body axis when one control surface is activated, with small coupling effects due to their position on the airplane; other non-conventional configurations might rely on a single control surface to achieve control around more than one axis. Traditional primary flight controls are ailerons (generating a rolling momentum to achieve roll control), elevator (utilized to obtain pitch control) and rudder (necessary to perform yaw control). Secondary flight controls do not modify flight attitude; they are employed to change aerodynamic coefficients (drag and/or lift coefficient), even if some types of unconventional control surfaces, often located on military jets, act as both primary and secondary flight controls, like F-16's flaperons. Unlike for primary controls, these ones have an ON/OFF activation or a degree increment deployment maintained until a new command is given (so irreversible systems are suitable to activate them); their usage is not continuous and a high frequency response is not required. Flaps, slats and spoilers are the conventional secondary flight controls. These mechatronic devices, controlling the deflection of the said aerodynamic control surfaces, are commonly named servomechanisms and constitute the airplane flight control actuation system. In general, all these actuators are commanded by a computer, which is demanded to elaborate the command provided by the pilot and transfer it to the actuators depending on a wide variety of settings; the series of transformation of the command depends on the entire logic of the controlling on flight. The state of the art relatively to actuation of aircraft flight controls is mainly using Hydraulic Actuators, i.e. formerly hydro-mechanical devices and, in the recent years, electro-hydraulic actuators (EHA), and/or more recently using Electro-Hydrostatic Actuators (EHA) as backup, which generates locally some hydraulic power from an electrical source.

The introduction of more performing and reliable electrical actuation solutions is the new tendency: in few applications, electromechanical actuators (EMA) have been implemented, mainly for the so-called secondary flight controls, like flaps and slats, and more recently for a spoiler surface, on the B787.

The examined system, as shown in Fig. 2, is a typical electrohydraulic position servomechanism (SM) widely used both in primary and secondary aircraft flight controls; this SM consists of:

1. a controller subsystem made of a control electronics and a servoamplifier (SA); the control electronics may be a computer, microprocessor or guidance system and creates a command input signal; the SA provides a low power electrical actuating signal which is the difference between the command input signal and the feedback signal generated by the feedback transducer. The SA usually implements an embedded PID control logic (proportional-integral-derivative); some-times it could only use a PI or a PD logic, or a further simplified proportional logic with a velocity loop; the present work refers exactly to a pure proportional control logic;
2. an electrohydraulic SV which amplifies this low power electrical input regulating a high power flow of hydraulic fluid to the actuation element;
3. a hydraulic piston (symmetrical double acting linear cylinder subjected to Coulomb friction [14]), provided by a position transducer, which positions the device being controlled.

The description of the considered system and its mathematical model are widely shown in [3, 13]. The aforesaid servomechanism belongs to the fly-by-wire paradigm: the pilot's command depends upon transducers that express the pilot wishes by an electric or a digital reference signal; this signal is continuously compared via a feedback loop with the actual position of the control surface generating the instantaneous position error as input to the control law. So, the error is processed and transformed into an electric current operating the electrohydraulic servovalve; this valve drives an actuator that moves the control surface continuously pursuing, by a proper control law, the reduction of the error between pilot's commanded position and flight surface actual position. The servovalve is a high performance two-stage valve (Fig. 3); its output stage is a closed center, four-way, sliding spool, while the pilot stage is a symmetrical double nozzle and flapper, driven by a torque motor. Since its natural frequency is supposed to be orders of magnitude higher than the desired closed loop bandwidth of the whole SM, only its orifices resistive effects was taken into account.

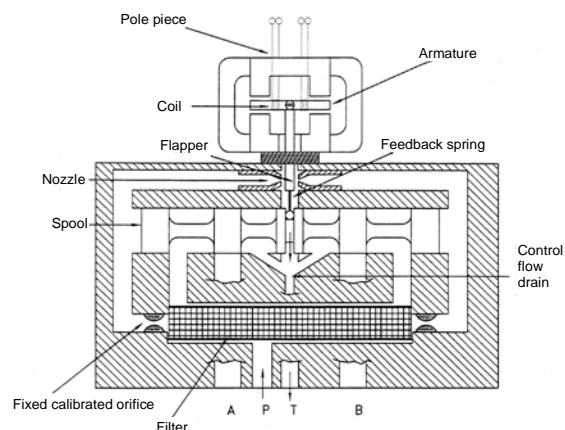

Fig. 3: Schematic of the flapper-nozzle servovalve

Its behavior could be efficiently described, for the purpose of the paper, with a lumped parameters second order electromechanical model for the pilot stage (first stage) and a second order for the sliding spool (second stage) and the related feedback spring. It should be noted that the second-stage dynamic model takes into account the effects due to the Coulomb friction forces acting on the spool (by means of the numerical model proposed in [3]). Moreover, a feedback from the second stage toward the first one, a saturation of the second stage output differential pressure and the effect of working flow and leakage on the differential pressure itself are considered; the abovementioned model is conceived to take into account the effect of time dependent supply pressure. The hydraulic linear actuator considered in the present paper is a double acting symmetrical one: its model includes inertia, Coulomb and viscous friction and leakage effects through the piston seals developing a not working flow; it is also able to take in account the effects due to its interactions with the eventual mechanical ends of travel as well as the external load acting on the flight surface. This type of simulation algorithm, widely explained in [13], is also able to evaluate the dry friction force effects, taking into account its dependency on mechanical actuator efficiencies and also on external loads acting on the EHA.

3.1 Analytical Model of the EHA

The considered EHA has been modelled by means of the Simulink block diagram shown in Fig. 4: as shown in [15], the position error (Err), coming from the comparison of the instantaneous value of commanded position (Com) with the actual one (XJ), is processed by means of a PID logic giving the suitable current input (Cor) acting on the servovalve first stage torque generator.

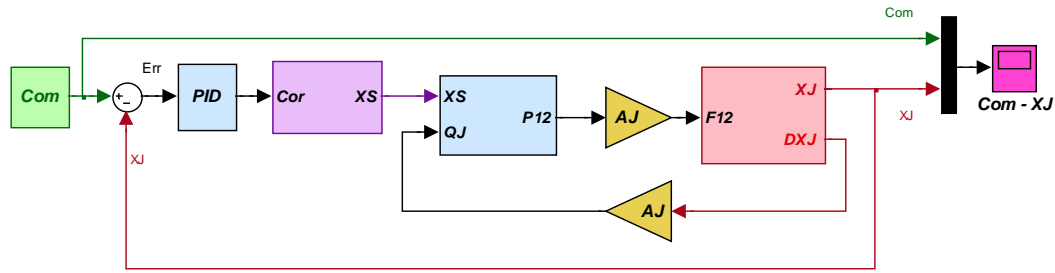

Fig. 4: Simulink block diagram of the considered EHA

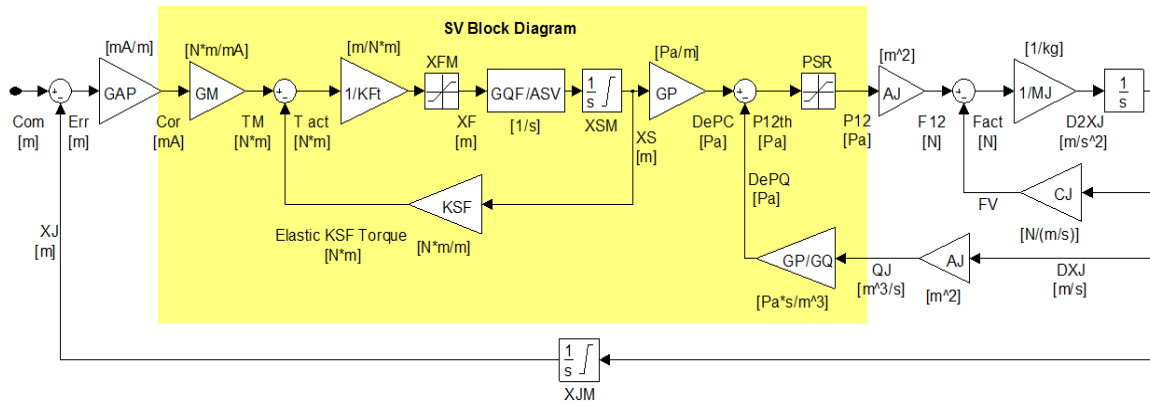

Fig. 5: Block diagram of the EHA mathematical model used for the prognostic algorithm

The aforesaid engine torque (expressed as a function of Cor through the torque gain GM), reduced by the feedback effect due to the second stage position (XS), acts on the first stage second order dynamic model giving the related flapper position (XF). The flapper position (limited by double translational hard stops) causes a spool velocity and, by time-integrating, gives the displacement XS (limited by double translational hard stops $\pm XSM$); the second stage dynamics is modelled by means of a second order numerical model able to take into account the dry friction forces acting on the spool. From XS , the differential pressure $P12$ (pressure gain GP taking into account the saturation effects) effectively acting on the piston is obtained by the flows through the hydraulic motors QJ (valve flow gain GQ). The differential pressure $P12$, through the piston active area (AJ) and the equivalent total inertia of the surface-motor assembly (MJ), taking into account the total load (FR), the viscous (coefficient CJ) and dry friction force (FF), gives the assembly acceleration ($D2XJ$); its integration gives the velocity (DXJ), affecting the viscous and dry frictions and the linear actuator working flow QJ that, summed to the leakage one, gives the above mentioned pressure losses through the valve passageways. The velocity integration gives the actual jack position (XJ) which returns as a feedback on the command comparison element.

The proposed numerical model is also able to simulate the effects due to conversion from analogic to digital of the feedback signals (ADC), electrical noise acting on the signal lines and electrical offset.

3.2 EHA Monitoring Model

The proposed detailed EHA Simulink model is able to simulate the dynamic behavior of an actual EHA taking into account the effects due to command inputs, environmental conditions and some failures. So, even with proper limitations, this model allows simulating the dynamic response of the real system in order to evaluate the effects of different faults and designs, analyses and tests different diagnostic and prognostic monitoring strategies. In order to conceive a smart system able to identify and evaluate the progressive failures, it is necessary to compare its dynamic behaviors with those provided by an ideal system operating in nominal conditions (in order to neglect the effects due to these failures). To this purpose, a new numerical model, dedicated to monitoring, has been developed (Fig. 5). This model represents a simplified version of the detailed EHA numerical model having the same logical and functional structure; such a model, with respect to the detailed one, is able to give similar performance, although less detailed, requiring less computational effort and reduced computational time.

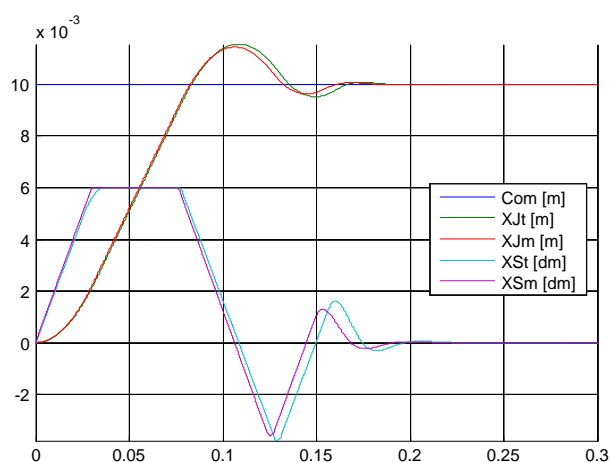

Fig. 6: Comparison between the dynamic responses of EHA and monitoring model - step position command

For example, in Fig. 6 the dynamic behaviors produced by the numerical model of the EHA in response to a step position command (respectively jack XJt and spool XSt positions) are compared with the corresponding monitoring system ones (XJm and XSm). While considering nominal conditions, it is possible to observe a certain discrepancy between the behaviors of EHA and monitoring system: this is due to the simplifications characterizing the mathematical model of the monitoring system (e.g. the dry or viscous friction forces acting on the SV spool, which introduce a certain response delay, and some EHA nonlinearities are neglected).

4 EHA Failures and Degradations

The electrohydraulic actuator, and in particular the servovalves regulating their hydraulic power, are complex devices and can fail in several ways. In this regard, it is however appropriate to highlight that some SV failures are sudden occurrences and, at the moment, there is no conceivable way of predicting them. Failures of this type are the interruption of the electrical coils, the breaking of the internal feedback spring, the clogging of a nozzle or of the jet-pipe due to large size debris in the oil, or a spool seizure resulting from a large metallic chip stuck in the radial clearance between spool and sleeve. All these failures are unpredictable events leading to a servovalve lack of operation, or uncommanded movement that are recognized by a dedicated monitoring logic which eventually removes the hydraulic power supply from the servovalve and inhibits any further operation.

In general, servovalves are provided with linear variable differential transformer (LVDT) type position transducers sensing the spool position.

By comparing the servovalve current input with the spool position provided by the said LVDT sensors, a eventual lack of response or an uncommanded movement is detected.

According to the above considerations, in this work authors focused on some of the typical faults that affect the servovalve (with the exception of friction acting on the hydraulic linear actuator).

The first progressive fault considered is the clogging of the servo valve first stage filter.

As proved by the failure mode analysis, the maximum spool velocity and the initial overshoot peak (generated in the case of a ramp command to the jack in close loop logic) represent measurable parameters explicatory of the occlusion state of the first stage filter. These are considered as terms of comparison useful to lead the first approximation evaluation of the state of health of the SV filter.

The second progressive fault analyzed is the augmentation of the friction coefficient of the sliding contact between spool and sleeve due to the wear of their contact surfaces. In particular, as the sliding contact increases its wear, the period and the amplitude of the steady state oscillation due to limit cycle tends to rise too. An alternative way to esteem the friction condition is also to analyze the spool breakaway condition (e.g. evaluating its time response or the corresponding breakaway error), which puts in evidence a good dependence with the increasing of the friction amount.

The third fault mode analyzed is the progressive augmentation of the friction forces acting on the sliding contact of the hydraulic linear actuator (in particular, the friction between jack and cylinder). This dissipative force caused by the cylinder sealing and guiding elements, has been considered because of its influence on dynamic behavior of the actuation system: this results in a reduction of the EHA position accuracy and breakaway resolution and, eventually, generates stick-slip conditions. The amount of pressure needed is a direct consequence of the friction conditions, on condition that the viscose contribution is unaltered. Eventually, the phase of fail modes analysis led to the detection of a robust way to perform an approximate estimation of the three progressive faults using the information derived from the observation of just two physic parameters: the position of the spool and the differential pressure to the actuator. In order to take advantage of this correspondence between cause and effect in an efficient way, two test cases were developed: one in open loop and the other in close loop, with the relative time history command.

5 Fault Detection and Identification

Several optimization techniques are used for model parameter estimation tasks; they can be classified into two main categories: deterministic (direct or indirect) and probabilistic (stochastic, as Monte Carlo method, simulated annealing and genetic algorithms). As reported in [5], a large part of these methods are local minima search algorithms and often do not find the global solution (i.e. they are highly dependent on a good initial setting). Local-minima approaches would not be robust and may provide a false indication of parameter changes in an on-line system (i.e. a wrong selection of starting settings could determinate problems of convergence or global minima). Otherwise, as reported in [15-16], global search methods, such as genetic algorithms and simulated annealing, provide more promising options for on-line model identification. Genetic Algorithms (GAs) have been used in science and engineering as adaptive algorithms for solving practical problems and as computational models of natural evolutionary systems [17]. About that, it must also be noted that, especially in order to implement a model-based FDI algorithm able to perform the health diagnosis of a real EHA evaluating several variables (typically five or more), the method based upon GAs are usually more effective and reliable with respect to other approaches (e.g. deterministic methods). In recent years the applications of GAs in the development of diagnostic systems based on numerical models have found wide interest in the scientific world and have led to several technical applications. In particular, in the field of mechatronics and electromechanical systems, have been published many researches about new diagnostic and prognostic algorithms which integrate GAs optimization and model-based approach [18]. For example, Raie and Rashtchi in [15] proposed a GA-based parameter identification approach (i.e. a parameter identification method applied to a simplified fault-sensing model), able to detect and evaluate the magnitude of progressive stator turn-to-turn coil faults. Operatively speaking, the FDI procedure uses the monitoring model and its ideal dynamic response in a certain fault condition. Consequentially, the response of the monitoring model is used by the fitness function in order to get a scalar evaluation of how much the monitoring response differs from the reference one. Obviously, this comparing step is iteratively repeated with different fault combinations in order to explore the entire domain of research and to find the ideal combination of fault condition that minimizes, as efficiently as possible, the fitness function and so represents the state of health of the actuator.

This task is performed by the optimization tool, which leads the iterative generation of new fault combinations to a progressive decrease of the fitness function in order to get as close as possible to the real solution (Fig. 7). The parameters that represent the amount of the considered progressive faults (K_{FDJ} , K_{Intas} , K_{FSS}) are normalized to the border state of usage in operative condition, therefore vary linearly from zero (original fully integral condition) to one (limit fully damaged condition).

The effectiveness of the diagnostic procedure highly depends on several aspects, such as the definition of the test time-history command, the insensibility to the external disturbances and the robustness of the optimization tool chosen (i.e. often different problems may require different optimization tools). In general, deterministic solvers are often used for this kind of tasks, but in recent years the application of GAs in diagnostic systems based on numerical models has met wide interest, thus leading to several technical applications. Indeed, even though the deterministic process has a mathematical validation of the absolute minimal point research procedure, it results particularly ineffective if the objective function presents relative minima, since the solver could tend to fall into a relative minimum, ignoring the other parts of the domain. As the number of considered fault modes increases, the objective function becomes ever more irregular and the deterministic research loses in reliability. Heuristic solvers provide a suitable solution for this problem; indeed, they are less accurate in finding the optimal solution than the deterministic approach, but, on the contrary, they are considerably more robust, thus decreasing the probability of falling into a relative minimum of the fitness function.

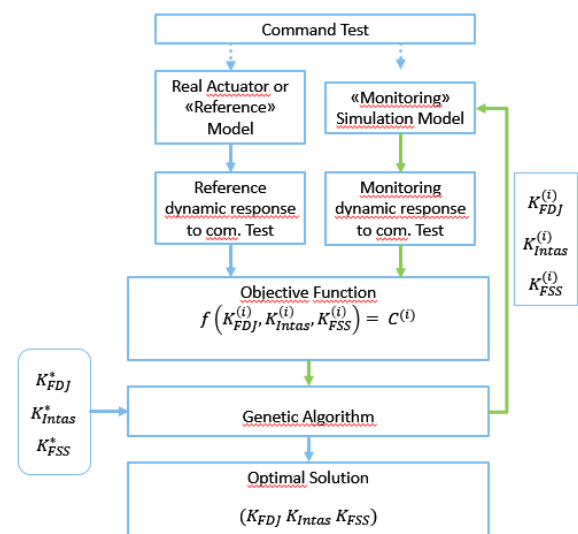

Fig. 7: schematic of the proposed FDI procedure

The GA, which makes use of the evolutionary principles of mutation and reproduction, applies Darwin's theory of natural selection to the minimization task, satisfying the necessary conditions of exploration and exploitation of the domain of research. The peculiarity of the heuristic process is that it has a general validity in any case and that does not have any particular guideline to follow. In particular, the genetic algorithm can be applied to the genetics or to the dynamics of the evolution without specific reference to other sectors, such as engineering. In other words, this process is potentially successful but it needs to be set in the correct way to transform this potentiality into effective results. It must be noted that the proposed FDI procedure makes use of the information provided by first approximation analysis, consisting in a preliminary evaluation of the condition of fault of the actuator (as shown in Fig. 1). This initial step of the FDI procedure, based on three phases of research (corresponding to each fault mode) performed by means of deterministic methods provides an approximate value of the fault state and it is mainly used to initialize the GA procedure (i.e. to find initial values of K_{FDI} , K_{intas} , and K_{FSS}). Every singular approximation task follows the loop procedure similarly to the one discussed above and represented in Fig. 7. Eventually, the success in finding correct answers to the proposed problem with the GA depends on the ability to correctly regulate the solver criteria and to make it as compatible as possible to given problem.

6 FDI Procedure and Results

In order to improve the chances of usage of the diagnostic procedure, two different tests were developed which refer to an open-loop and a close-loop procedure. In fact, both procedures have the same operative principle: they consist in using the first period of the command response to approximately foresee the fault constants and in using the second period to validate and make the prevision more accurate. During the first analysis, three deterministic procedures are used; these resort to three specific objective functions, which compare the main tangible aspects of the response, in order to find a solution that minimizes the aforementioned objective function, in the best possible way.

The approximation procedure sequence also consists in the esteem of the jack-cylinder sliding surfaces friction condition, of the filter clog constant and finally of the spool-sleeve sliding surfaces friction. Once an approximate prevision of the fault constants is obtained, this fault combination is used

as a starting point for the heuristic refinement and validation of the result. The second part of the test command is used by a genetic solver in order to improve the precision and the robustness of the conclusive fault combination.

This operation is carried out following the integer indication of the objective function, aiming to evaluate the difference of response between the monitoring and the reference model. The objective functions only take the displacement of the spool and the differential pressure into consideration, thus estimating the gap between the reference response and the simulated response in the monitoring model. For this purpose, the scalar result of the objective function is used, to search the absolute minimum of the objective function. The latter would correspond to the correct fault combination. The operating principle of the final objective function is in fact to integrate the gap between the spool responses into each sampling step, by summing the amount of the quadratic difference between the monitoring response and the corresponding reference response.

The time-history command plays an essential role in the achievement of a good FDI analysis (i.e. a proper selection of these command inputs could produce a more accurate and efficient evaluation of the EMA health conditions). The first period of the input signal, both in open-loop and in close-loop test, is defined according to what is necessary to highlight, basing on the cause-effect studies of the faults, discussed in paragraph 4. Instead, the second part of the time response is used as a matter of study by the GA solver to do the final evaluation. In particular, the second part of the time history, for both the test cases, consists in two sinusoidal commands with a different frequency.

The command is so defined because in this way there is less chance for the right combination to be confused with another one. In fact, it could happen that two fault combinations get the same gain and phase of system response for a given frequency of sinusoidal input. However, it is nearly impossible that the two combinations have the same frequency response (evaluated in terms of gain and phase) for two different input frequencies. In the following of the paragraph are reported two tables that refer to the solution founded by the proposed algorithm, considering the response provided by the reference model in various fault conditions analysed in the open loop (OL) test and in the close loop (CL) test.

Table 1 shows the open loop test prevision; in this table, Value 1 contains the first approximation results and Value 2 the final solutions provided by the genetic algorithm. *err1* and *err2* are the percent errors compared to the correct constant.

Table 1: Result of the FDI procedure for open loop test

				Open loop test results			
Cases	Parameters			Value1	Value2	err1	err2
1	K1	Kintas	0,3	0,315347	0,298426	1,534677	0,157381
	K2	FSS	0,3	0,293906	0,303541	0,609375	0,354085
	K3	FDJ	0,3	0,299304	0,299304	2,78E-14	0,069618
				0	0	0,714684	0,193695
2	K1	Kintas	0,3	0,419308	0,295381	11,93079	0,461934
	K2	FSS	0,6	0,485938	0,610053	11,40625	1,005346
	K3	FDJ	0,3	0,3	0,3	2,78E-14	2,78E-14
				0	0	7,779014	0,489093
3	K1	Kintas	0,6	0,707749	0,598059	10,77491	0,194063
	K2	FSS	0,6	0,419844	0,606258	18,01562	0,625801
	K3	FDJ	0,3	0,30025	0,30025	0,025	2,50E-02
				0	0	9,605179	0,281621
4	K1	Kintas	0,6	0,707749	0,598062	10,77491	0,193846
	K2	FSS	0,6	0,419844	0,606253	18,01562	0,62527
	K3	FDJ	0,6	0,599928	0,599928	0,00715	0,00715
						9,599229	0,275422
							9,323558

Table 2: Result of the FDI procedure for closed loop test

				Close loop test			
Cases	Parameters			Value1	Value2	err1	err2
1	K1	Kintas	0,3	0,294593	0,302977	0,540715	0,297695
	K2	FSS	0,3	0,303581	0,294149	0,358053	0,585067
	K3	FDJ	0,3	0,300026	0,299999	0,002639	6,44E-05
						0,300469	0,294275
2	K1	Kintas	0,3	0,294778	0,300862	0,522175	0,086175
	K2	FSS	0,6	0,468279	0,59343	13,17215	0,657039
	K3	FDJ	0,3	0,299984	0,300004	0,001572	0,000369
						4,565299	0,247861
3	K1	Kintas	0,6	0,679822	0,597723	7,98223	0,227672
	K2	FSS	0,6	0,525945	0,607861	7,405464	0,786098
	K3	FDJ	0,3	0,300042	0,300002	0,004237	0,000221
						5,130644	0,337997
4	K1	Kintas	0,6	0,6035	0,601521	0,350046	0,152124
	K2	FSS	0,6	0,534835	0,594485	6,51646	0,551489
	K3	FDJ	0,6	0,60004	0,600002	0,003979	0,000242
						2,290162	0,234619
							2,055543

The blue cells show the mean error for each prevision and the green cells the reduction of the mean percent error between the first approximation combination and the final combination.

Table 2 shows the results of the closed loop test: it must be noted that the considered test cases are the same as the previous study and the format of the table is the same too. As evidenced in red in Table 1 and Table 2, the results given by first approximation analysis sometimes are too inaccurate and, without the further improvements provided by the GA, cannot give effective and reliable previsions.

7 Conclusions

This work analyses the effects of progressive faults on the dynamic behavior of EHA in order to identify system-representative parameters which are suitable for prognostic activities and to propose a new model-based fault detection and identification method (FDI) that makes use of deterministic and heuristic solvers in order to converge to the actual state of wear of the tested actuator.

This method allows a prompt detection of gradually-increasing failures on aircraft actuators. The study has been performed on a numeric test bench (simulating the behavior of a real EHA actuator) that implements several kinds of failure; by means of proper simplifications, the aforesaid numerical model was then reduced obtaining the monitoring model. Looking at the experimental campaign, the amount of mean error in a general diagnostic test is less than 1%. It is an acceptable value, considering the complexity of the problem.

Accuracies are all over 90%, so we can conclude that the method converges appropriately. Moreover, it must be said that, even if the method is probabilistic, every simulation converges at the same result almost in the 100% of attempts, making the method suitable in terms of repeatability.

The proposed FDI method has reached satisfying performances, but it could be further improved by considering the effects due, for instance, to the electrical hysteresis in the first stage torque motor and the variation of its gain. Another type of fault to implement may concern the modification of the geometry of the elements due to wear, as in the backlash between the spool and the feedback spring sphere. In authors' opinion, it would be also appropriate to make the system robust to variations in the physical characteristics of the hydraulic oil (e.g. oil viscosity and temperature) by inserting, for example, a probe for the detection of the aforesaid temperature, in order to allow the appropriate corrections of the corresponding numerical model.

In conclusion, it is authors' opinion that the so obtained results are encouraging and that they give hope to obtaining good outcomes also in further developing of the procedure and by analyzing new combinations of progressive faults.

8 Acknowledgement

In conclusion, the authors wish to extend a heartfelt thanks to Professor Lorenzo Borello and to Dr. Licia Masoero for their essential support in this research.

References:

- [1] G. Vachtsevanos, F. Lewis, M. Roemer, A. Hess, B. Wu, *Intelligent Fault Diagnosis and Prognosis for Engineering Systems*, Wiley, 2006, ISBN: 978-0-471-72999-0.
- [2] C. S. Byington, W. Watson, D. Edwards, P. Stoelting, *A Model-Based Approach to Prognostics and Health Management for Flight Control Actuators*, *IEEE Aerospace Conference Proceedings*, 2014, USA.

- [3] L. Borello, M.D.L. Dalla Vedova, G. Jacazio, M. Sorli, A Prognostic Model for Electro hydraulic Servovalves, *Annual Conference of the Prognostics and Health Management Society*, San Diego, CA, 2009.
- [4] M.S. Mamis, M. Arkan, C. Keles, Transmission lines fault location using transient signal spectrum, *Int. Journal of Electrical Power and Energy Systems*, Vol.53, pp. 714-718, 2013.
- [5] M.D.L. Dalla Vedova, P. Maggiore, L. Pace, Proposal of Prognostic Parametric Method Applied to an Electrohydraulic Servo mechanism Affected by Multiple Failures, *WSEAS Transactions on Environment and Development*, Vol.10, pp. 478-490, 2014.
- [6] M.D.L. Dalla Vedova, P. Maggiore, L. Pace, A New Prognostic Method Based on Simulated Annealing Algorithm to Deal with the Effects of Dry Friction on Electromechanical Actuators, *International Journal of Mechanics*, Vol.9, 2015. ISSN: 1998-4448.
- [7] H. Su, K.T. Chong, Induction machine condition monitoring using neural network modelling, *IEEE Transactions on Industrial Electronics*, Vol.54, No.1, pp. 241-249, 2007.
- [8] S. Hamdani, O. Touhami, R. Ibtouen, M. Fadel, Neural network technique for induction motor rotor faults classification - dynamic eccentricity and broken bar faults, *IEEE International Symposium on Diagnostics for Electric Machines, Power Electronics & Drives (SDEMPED)*, pp. 626-631, 2011.
- [9] S.S. Refaat, H. Abu-Rub, M.S. Saad, E.M. Aboul-Zahab, A. Iqbal, ANN-based for detection, diagnosis the bearing fault for three phase induction motors using current signal, *IEEE International Conference on Industrial Technology (ICIT)*, pp. 253-258, 2013.
- [10] I. Chopra, R. Ganguli, D.J. Haas, Detection of Helicopter Rotor System Simulated Faults Using Neural Networks, *37th Structures, Structural Dynamics and Materials Conf.*, 1996
- [11] M.D.L. Dalla Vedova, D. De Fano, P. Maggiore, Neural Network Design for Incipient Failure Detection on Aircraft EM Actuator, *International Journal of Mechanics and Control (JoMaC)*, Vol.17, No.1, June 2016, pp. 77-83, ISSN: 1590-8844.
- [12] P. Maggiore, M.D.L. Dalla Vedova, L. Pace, A Desando, Proposal of fault analysis parametric method applied to an electromechanical servo mechanisms affected by failures, *Int. Journal of Prognostics and Health Management*, Vol.6, No.1, 2015, ISSN: 2153-2648.
- [13] L. Borello, M.D.L. Dalla Vedova, A Dry Friction Model and Robust Computational Algorithm for Reversible or Irreversible Motion Transmission, *International Journal of Mechanics and Control (JoMaC)*, Vol.13, No.2, 2012, pp. 37-48.
- [14] G. Jacazio, L. Borello, Mathematical Models of Electrohydraulic Servovalves for Fly-by-Wire Flight Control Systems, *Mathematical Computational Modelling*, Vol.11, pp. 563-569, Pergamon Press, 1988.
- [15] A. Raie, V. Rashtchi, Using a genetic algorithm for detection and magnitude determination of turn faults in an induction motor, *Electrical Engineering*, Vol.84, No.5, 2002, pp. 275-279.
- [16] M. Alamyal, S.M. Gadoue, B. Zahawi, Detection of induction machine winding faults using genetic algorithm, *9th IEEE Int. Symp. on Diagnostics for Electric Machines, Power Electronics and Drives (SDEMPED)*, 2013.
- [17] M. Mitchell, *An introduction to genetic algorithms*, Cambridge, MIT press, 1996, ISBN: 978-0-262-13316-6.
- [18] M.D.L. Dalla Vedova, A. Germanà, P. Maggiore, Proposal of a model-based fault identification genetic technique for more-electric aircraft flight control EM actuators, *Proceedings of the Third European Conference of the Prognostics and Health Management Society 2016*, Bilbao, 5-8 July 2016.