

POLITECNICO DI TORINO
Repository ISTITUZIONALE

E-SCAPE New tools and new opportunities for the localization of Expo 2015 general interest services along the Canale Cavour, a backbone of the Milan-Turin urban region

Original

E-SCAPE New tools and new opportunities for the localization of Expo 2015 general interest services along the Canale Cavour, a backbone of the Milan-Turin urban region / Castaldo, G.; Djordjevic, T.; Giudice, Benedetta; Giusto, M.; Mezzino, Davide; Oggero, C. - In: Multidisciplinarity and innovation. ASP projects 7STAMPA. - [s.l.] : Polipress, 2013. - ISBN 9788873980797. - pp. 140-143

Availability:

This version is available at: 11583/2675188 since: 2017-06-27T13:23:14Z

Publisher:

Polipress

Published

DOI:

Terms of use:

This article is made available under terms and conditions as specified in the corresponding bibliographic description in the repository

Publisher copyright

(Article begins on next page)

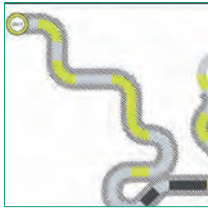

Multidisciplinarity and innovation ASP projects **7**

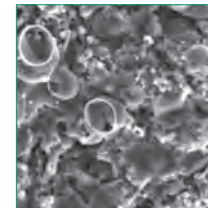
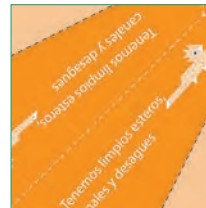
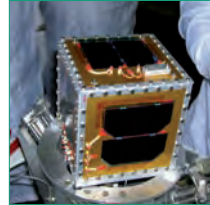
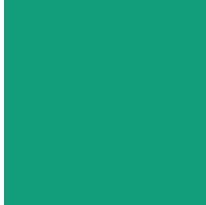

POLITECNICO DI MILANO
POLITECNICO DI TORINO

**Multidisciplinarity
and innovation**
ASP projects **7**

Preface

This book marks the seventh cycle of students that have completed their course of studies in the Alta Scuola Politecnica.

Created in 2004, the Alta Scuola Politecnica programme draws on the experience of the Politecnico di Milano and the Politecnico di Torino, two universities with different histories, conditions and methods, but that share the desire to offer to selected and talented students with an interest on multi-disciplinarity a highly-innovative course of studies.

From the outset, this ambitious project aimed to create an axis of learning between Turin and Milan. Today, as we witness the growing economic and social bonds between these two cities – both of which are key to the Italian economy – we are increasingly confident that we made the right decision nine years ago, a decision that during this time has come to fruition and has evolved and improved.

The world is witnessing a very fast technological and social development that is leading to the emergence of new paradigms; therefore, technical professionals of the future should not only be specialists in a given discipline, but also capable of building innovative solutions that are most suitable to be transferred to the products and services of the future. At the same time, when dealing with particularly talented students, we believe that universities should do more than simply issue degrees - they should also prepare these students to become future leaders and meet the specific demands that prospective employers cast on this particular segment of graduates. In this sense, the Alta Scuola Politecnica provides an added value with respect to the traditional academic approach. ASP students are given the opportunity to continuously gain insight from one another, from courses offered by both universities, and from projects at the leading edge of technology proposed by companies. Due to this unique learning experience, they develop the managerial skills and the comprehensive training that employers are increasingly seeking from top graduates in technical disciplines. Students have the opportunity to work in teams, managing complex projects which require multi-disciplinary contribution (as illustrated in this book), and follow residential courses, thereby enjoying a stimulating learning experience. The significant presence of industrial sponsors in the last ASP nine cycles gives evidence to the fact that industry appreciates the mix of specialized skills, coming from the Master programs, and interdisciplinary skills, coming from ASP.

This important achievement confirms that the path we chose to follow in 2004 is still very promising, and we are encouraged in continuing and improving this endeavour with the same enthusiasm shown by our ASP students.

Prof. Giovanni Azzone, Rector, Politecnico di Milano

Prof. Marco Gilli, Rector, Politecnico di Torino

ASP Sponsors



ASP is partially financially supported by external institutions which share our vision of educating talented students and promoting interdisciplinary innovation. Following a three-year initial financial support from the Italian Ministry of University Education and Research, the main supporters of ASP are currently Compagnia di San Paolo and Fondazione Cariplo. Other institutions, both private and public, have joined in by providing financial support as well as a relation aimed at developing projects and opportunities for the career development of our students. The logo of each of our sponsors is presented below and their valuable support is hereby gratefully acknowledged.



The Compagnia di San Paolo, founded in 1563 as a charitable brotherhood, is today one of the largest private-law foundations in Europe.

It pursues aims of public interest and social use, in order to foster the civil, cultural and economic development of the community in which it operates. The Compagnia is active in the sectors of scientific, economic and juridical research; education; art; preservation and valorization of cultural heritage and activities and of environmental assets; health; assistance to the socially deprived categories.

In 2011 the Compagnia awarded 842 grants in its areas of activity, amounting to 124.9 million euros. Notably, 145 grants were awarded in the Research and Higher Education sector, amounting to 43.8 million euros.

The Compagnia pays particular attention to advanced research and to the development of scientific and technological centres of excellence, seen both as catalysts and multipliers of research and higher education initiatives. It supports the reinforcement of Torino's university system, especially through the promotion of excellence at Politecnico di Torino and the University.

The commitment of the Compagnia in the field of Education is focused on university and postgraduate education, starting from the growth of human capital, internationalization and the provision of infrastructures, with special attention to the conditions that assure equal access. The agreement on a long-term framework characterizes the Compagnia's relations concerning university and postgraduate education with the universities in Piedmont (Università di Torino, Politecnico di Torino, Università del Piemonte orientale "Amedeo Avogadro").

In this context, the ASP's focus on excellence and innovation – besides characterizing it as a valuable initiative per se – gives this programme the capacity to enhance the global attractiveness of the Universities involved and foster, within the leaders of the future, a specific attention to the interdisciplinary and international dimension of nowadays society. The programme also represents an interesting and successful synergy among educational institutions located in the north-western region of Italy such as the Torino and Milano Politecnici.

The Compagnia has supported ASP since 2007: the grants are aimed at funding scholarships for the ASP course beginning in the year, requiring a special attention to students not based in Piedmont, or with an immigrant origin.



fondazione
cariplo

Fondazione Cariplo, established in 1991 as a nonprofit organization with the purpose of furthering the common interest and the public good in various fields, is today – thanks to the sheer size of its assets (over 5.97 billions euro) - one of the world’s leading philanthropic entities annually funding grants to organizations for the fulfillment of selected projects and initiatives.

The Foundation’s assets, which are the fruit of the labour of generations of men and women, though considerable, are not sufficient to solve the many problems afflicting the civil society in Lombardy, Italy and the entire world. Therefore, Fondazione Cariplo efforts focus on the improvement of the living conditions in the local community. To Fondazione Cariplo this means improving the living standards of individuals as well as their social, cultural and economic environment.

Fondazione Cariplo nurtures those conditions which enable individuals to achieve their potential, express their personality, freely pursue their inclination and fulfill themselves.

Fondazione Cariplo gives priority to financing specific projects rather than providing general aid to organizations. This is, in fact, the only way to precisely assess whether a program is innovative and responds to the needs of the community.

The Foundation nurtures a breeding ground for scientific research, technology transfer and the development of applied research findings, by backing synergic actions geared to the creation of networks and partnerships, the participation in international projects, the development of human capital, the production of better knowledge and improved scientific communication, as well as the dissemination and enhancement of applied research findings.

In 2012 Fondazione Cariplo awarded 997 grants in its various areas of activity, amounting to 141 millions euro. 74 grants were awarded in the scientific research and technology transfer area, totaling 24 millions euro. Between 2010 and 2012 the scientific research sector of Fondazione Cariplo received about 1.500 applications, processed 1.200 funding requests, and funded 311 projects. Fondazione Cariplo pays particular attention to the support and promotion of human capital development, particularly by focusing on a limited number of projects whose purpose is to start activities capable of achieving excellence in university and post-university studies. Furthermore the Foundation is also firmly convinced that actions supporting “excellence human capital” must entail a close connection between training and teaching activities, on one hand, and research and exposure to an advanced international scene, on the other.

These are the reasons underlying Fondazione Cariplo decision to support the ASP, an advanced international Faculty able to attract the best young foreign students and capable of Italian high profile graduates education.



Along with an ever diversely assorted graduate education offer with over 15,000 new degrees or diplomas granted every year, an excellent post graduate training system makes Piedmont and the province of Torino a centre of attraction for young talents. Moreover, thanks to the presence of more than 200 research centers, today Piemonte Region investment in R&D accounts for 1,8% of GDP. With over 2.000 mln Euro invested, Piedmont is the third Italian region as for total investment in research, with 76% of private funded research.

Partnership with public and private institutions, network between territories, support to innovation and research are main objectives for the Torino Chamber of Commerce which promotes the economic development and the local businesses growth.

The Chamber offers a wide range of services to almost 235,000 companies working in the province and listed in the public Register of Enterprises: training, technological innovation, collection and distribution of information, fostering of business relations at home and abroad, creation of services and financing of projects designed to assist new businesses, promotion and organization of events, access to financing, information and consultancy for companies involved in foreign trade.

A particular attention is dedicated to the different levels of education, from professional courses to post-university Masters, with a special focus on high education systems and international training, which represent a significant tool for the attractiveness and worldwide relations, together with the solidity of the industrial fabric, the pro-business mood of the public administration, the quality of life in a creative, cultural and artistic context.

This is the reason why the Torino Chamber of Commerce, years ago, decided to cooperate with the ASP, the advanced international Faculty, founded by Politecnico di Torino and Politecnico di Milano, to enhance links between the two cities.

Italian Chambers of Commerce work to build local area networks between research centers and enterprises, individual enterprises, institutions, territories and cities, as well as technological networks.

Torino, Milan and Genoa Chambers of Commerce support the development of North-western macro-economic region by means of projects.

Figures are significant: north-western Italy (Piemonte, Lombardia, Val d'Aosta and Liguria) is one of the European biggest areas, with a population that overcomes 16 million people and nearly 1.600.000 enterprises. It is an integrated territory that can proudly compete with the other European polycentric regions.

The North-western region needs economical and infrastructural actions, as the new railway connection between Torino and Milan, but also stronger cultural relations, focusing in particular on contemporary art, education and organization of international events, as Milano Expo 2015.

In addition Torino Chamber of commerce awarded the bid to host the 9° World Chambers Congress in 2015. The Congress is the only global event gathering Chambers' chief executives and businessmen worldwide to exchange best practice, to widen network and develop projects to support SMEs. A new challenge for the Torino Chamber of commerce and for the city itself.

Torino Chamber of Commerce: working with businesses to build the future

www.to.camcom.it



Barilla, originally established in 1877 as a bread and pasta shop in Parma, is today one of the top Italian food groups: a leader in the pasta business worldwide, in the pasta sauces business in continental Europe, in the bakery products business in Italy and in the crispbread business in Scandinavia.

The Group employs more than 13,000 people and in 2011 had net sales of euro 3,9 billion.

The Company has been managed for over 130 years by the Barilla family and is now run by the fourth generation of entrepreneurs. Always oriented toward a healthy daily diet through tasty and nutritionally balanced products intended for daily use, Barilla became popular worldwide due to its attention to the quality of its products, the result of significant investments in research, innovation and technology, as well as communication.

Barilla owns 42 production sites in 9 countries, of which 9 are directly managed mills that provide most of the raw materials for the production of its pasta and bakery products.

Barilla exports to more than 100 countries. Every year about 2,300,000 tons of food products, with the brands Barilla, Mulino Bianco, Voiello, Pavesi, Wasa, Harry's (France and Russia), Lieken Urkorn and Golden Toast (Germany), Alixir, Academia Barilla, Misko (Greece), Filiz (Turkey), Yemina and Vesta (Mexico), are featured on dining tables all over the world.

By respecting its own traditional principles and values, which still feel current today, by considering employees a fundamental asset and by developing leading-edge production systems, Barilla has become one of the world's most esteemed food companies, and one that is recognized worldwide as a symbol of Italian know-how.

it.barilla.com



THE BOSTON CONSULTING GROUP

The Boston Consulting Group is a global management consulting firm and the world's leading advisor on business strategy. Founded in 1963, BCG has 78 offices in 43 countries.

We partner with clients in all sectors and regions to identify their highest-value opportunities, address their most critical challenges, and transform their businesses. Our customized approach combines deep insight into the dynamics of companies and markets with close collaboration at all levels of the client organization. This ensures that our clients achieve sustainable competitive advantage, build more capable organizations, and secure lasting results. In our client work, we aspire to make a difference, and we succeed because we are different. We help our clients change the rules of the game, not just play better.

The BCG difference lies in the power of individuals: challenged by mentors, supported in teams, motivated by results. We look for outstanding talents and people who have the curiosity and drive to find innovative solutions. Our consultants work with clients to define the problem and determine the best approach. BCG offers to all its employees to grow further challenging their mind, partnering with leaders, making a difference and ultimately charting a career that fits them.

Our goal is therefore to help ASP students better understand the challenges and opportunities of a consulting career. We are highly committed to develop initiatives to meet, interact and support ASP students in their growth.

BCG. Grow Further! Shaping Your Future. Together.

www.bcg.com

McKinsey & Company

McKinsey & Company, global leader in management consulting, is proud to be sponsor of Alta Scuola Politecnica (ASP), a prestigious source of excellence within the Italian academic landscape.

We firmly believe that students at Alta Scuola Politecnica have the opportunity to develop a unique mix of skills and experiences that makes them mature and open-minded; furthermore, this distinctive combination strengthens their talent and directs them towards a focused management approach grounded on a “project-based” methodology that entails the development of highly valuable finished products and a real bent for meeting deadlines and experiencing team work.

These attitudes, together with their analytical and problem solving capabilities, fit particularly well with McKinsey’s culture and values. These are, moreover, the qualities that McKinsey looks for in its consultants and prospect candidates.

Thanks to these features, all ASP Alumni who had joined McKinsey have proved very successful and have embarked on a career path of excellence and exponential growth.

Communication design

Bottega dei Segni

Graphic editing

Simone Castiglioni

Proof reading

Trans Edit Group

Photos

We would like to thank all students for their photos.

Project Coordinator

Maria Grazia Comini

Copyright © Polipress 2013 - Alta Scuola Politecnica

Printed in June 2013

www.polipresseditore.it

Printed by Arti Grafiche Fiorin

Via del Tecchione, 32

20098 Sesto Ulteriano, Milano

All right reserved.

No part of this book can be reproduced in any form or by any means – electronic or mechanical, including photocopying, recording – or by any information storage and retrieval system, without previous Publisher's authorization. The Publisher is at disposal to anyone who might have any right relative to the contents of this book.

ISBN 978 88 7398 0766

Summary

Creating Innovation Leaders White Paper - The 2012 Como Summit Group	16	SustHealth	78	E-SCAPE	138
ASP Alumni – Overview	23	<i>Sustainable High Quality Healthcare</i>		<i>New tools and new opportunities for the localization of Expo 2015 general interest services along the Canale Cavour, a backbone of the Milan–Turin urban region</i>	
DeCoSe	30	Making Operative Hospitals Sustainable	80	[e]-scApp	140
<i>Designing Collaborative Services to boost social innovation in Smart Cities</i>		Designing Sustainable Hospitals	84	[e]X-cape	144
TocToc Movement	32	ARAM-AOCS	90	EXploring the landsCAPE	
&CO	36	<i>Development of innovative attitude and orbit control for low-cost and low-mass spacecrafts</i>		Green Move	150
Use everything, waste nothing		ARAM-AOCS Hardware	92	<i>Design and testing of an innovative transport system for vehicle sharing</i>	
SME 2.0	42	ARAM-AOCS Software	96	The technology behind a car sharing	152
<i>“Software as a service” as a breakthrough change for Small and Medium Enterprises</i>		Spider Silk	102	The service idea	156
SME 2.0	44	<i>Inspired super-tough nanoarmours</i>		Proper	162
“Software as a service” as a breakthrough change for Small and Medium Enterprises		MoDe	104	<i>Future perspectives of joint prostheses</i>	
FUSE	50	Model & Design		SSP	170
<i>Future Scenarios in Banking: new Services and sustainability</i>		SaFe	108	<i>Switched Positive Dynamical Systems for Cloud Computing Load Balancing</i>	
CoSpaR	58	Safety & Feasibility		Cloud Computing Load Balancing: a model-based approach through Switched Positive Dynamical Systems	172
<i>Components for Space Robotics</i>		TSC4 MiTo	114		
Exoskeleton for Extra Vehicular Activities	60	<i>The Social Computer for Milano and Torino</i>			
Soft solutions for hard problems	64	IMPARAR	122		
NEST	70	<i>Improving access to resources at reduced risk for urban areas with strong informal settlements: towards sustainable growth for the town of Guayaquil and major social inclusion of citizens</i>			
<i>NEw Services for Teaching and learning</i>		Housing Policy and Planning	124		
NEST	72	Resource Management and Natural Hazards	128		
NEw Services for Teaching and learning		Community Information System and living conditions	132		

The Alta Scuola Politecnica promoted a summit on creating innovation leaders, gathering 25 innovation experts and stakeholders chosen among the core members of a highly leveraged global innovation community. The summit took place on September 12-13 2012 in Como, at Villa del Grumello, with the patronage of the Ministry of Education of Italy, and sponsorship of the Boston Consulting Group (BCG) and of Procter & Gamble (P&G). After the summit, the participant community has delivered a white paper describing the collective strategic vision for giving shape to the emerging field of innovation leadership. More information about the summit and its forthcoming events can be found in www.comosummit.org.

Creating Innovation Leaders White Paper - The 2012 Como Summit Group

Attendees

- Marco AURISICCHIO, Lecturer in Engineering Design, Imperial College London
- Banny BANERJEE, Director Stanford ChangeLabs, Stanford University
- Paola BERTOLA, Board Member, Alta Scuola Politecnica
- John BODY, Principal, Thinkplace, Kingston AU, John
- Mario CALDERINI, Counselor, Ministry of Education, Politecnico di Torino
- Marco CANTAMESSA, Vice Director, Alta Scuola Politecnica
- Stefano CERI, Director, Alta Scuola Politecnica
- Luisa COLLINA, Rector's Delegate Expo 2015, Politecnico di Milano
- Kees DORST, Dean of Research, UT Sidney
- Anne DORTHE JOSIASSEN, FORA Project Leader, Danish Design Center
- Fawwaz HABBAL, Dean, Harvard University
- Veronique HILLEN, Director, EU Fund for D-School in Paris, Ecole du Pons
- Ronald JONES, Professor of Interdisciplinary Studies, Konstfack, Sweden
- Willem JONKER, CTO, EIT ICT KICK
- Gitte JUST, CEO, Copenhagen Co-Creation
- Nick KAYE, Professor, Stockholm School of Entrepreneurship
- Darren PETRUCCI, Professor, Arizona State University
- Francesco PROFUMO, Minister of Education, University and Research, Roma, Italy
- Yoram REICH, President, Israel Institute for Empowering Ingenuity, Tel Aviv University
- Jeffrey SCHNAPP, Co-director, Berkman Center for Internet and Society, Harvard University
- Giacomo SILVESTRI, Principal, BCG
- Giuseppe SIRIANNI, Associate Director, R&D, P&G
- Richard SOMMER, Dean, University of Toronto
- Randy SWEARER, Provost, Philadelphia University
- Antonio TURRONI, Principal, BCG

Introduction

On September 12th and 13th, 2012, a remarkable gathering took place in Como, Italy, bringing together a number of experts on

innovation and innovation leadership from around the world. This forum was initiated with the vision that innovation is one of the most important factors in dealing with complex challenges across domains, and thus it is necessary to create an international community for giving shape to the emerging field of innovation leadership.

The group spent two days working on analyzing best practices, identifying obstacles, and creating strategic vision for advancing and scaling innovation leadership. Discussions also included thoughts on creating a platform to shape the philosophy and give direction for transformative impact in our economies and our global challenges through enabling the growth of innovation initiatives worldwide and advancing the ability to scale innovation leadership.

The collective vision of this group led to some conclusions that are summarized below.

What is “Innovation Leadership”?

We believe that innovation is a major avenue for dealing with the societal challenges that confront the world we live in. However, innovation is not the simple proposal of something novel, and it is not a spontaneous reaction to a situation. It is a deliberate theoretical basis, process, and practice, that can yield changes to social and corporate systems, capacity in an ecosystem, and paradigms that have the capability to bring about new outcomes, impact, and altered system behavior in a manner that outperforms normative modes. Innovation leaders are the people who are equipped with the right competencies and skills to make this happen. Innovation Leaders have *agency* and are in a position to influence points of view, practices, decisions and actions. Traditional culture of leadership has grown around the norms of hierarchical decision-making, risk-averse decision-making, and managing resources. However, innovation is emerging as a new mode of leadership, one that imagines and crafts alternative futures rather than managing the present with normative methods. Innovation leadership needs to emerge as a discipline that embodies transdisciplinarity, cre-

ating new cultures, and catalyzing synergy across institutions and organizations in ways that generate new possibilities rather than create gridlocks. Both deep and broad knowledge are implied in a leadership that nurtures disparate thinking, modes of inquiry, and conceptual basis.

The Innovation Mindset

Innovation Leadership requires a different mindset, constitutes a depth in itself, and is a capacity that can be added to any specialization. The ability to create a bridge between an open ended question and an implementable solution requires a mindset that combines inquiry with action, sensitivity with gumption, analysis with synthesis, critical thinking with a hands-on ability, theoretical thinking with a spirit of iterative exploration. The innovation mindset requires a willingness to “see” possibilities and imagine scenarios that are different from the current ones. It requires a drive for impact, while maintaining a comfort with ambiguity. Innovators play at the nexus of concerns, so they must understand the implications of research content, how technology might be leveraged, how to unpack unstated human needs, see ways in which business or market opportunities can be leveraged, understand the implications of broad socio-economic backdrops, and know how to “make it happen”. Above all, the innovation leader drives change from the status quo to a better state, and hence of the fundamental roles of an innovation leader is to be a change agent and a catalyst for change agency. This implies that an innovator’s worldview, and ethical stance is as relevant as the capacity to innovate.

Why is “Innovation Leadership” Important?

The importance of innovation leadership stems from the tremendous demand for innovation in a wide array of contexts, social, technical and organizational. Driving this demand for innovation is unprecedented change in the business environments and social challenges. Rapid economic growth in Asia, especially China and India, radically new business models ena-

bled by disruptive technologies, increasing extreme weather events and accelerated social change are some drivers demanding innovative response. Within the education sector itself there is a democratization of knowledge at levels never seen before.

These drivers require a step change in the concept of leadership, moving beyond the traditional references to military-like hierarchy or centralized business management. Today's leaders must not only be brilliant strategists, creative decision-makers, and effective motivators regardless of the field they are engaged in, they must be also able to imagine new scenarios and creatively conceive solutions that go beyond established ideas and norms. They must identify the right questions. Moreover, they must be able to achieve their leadership on the field, through an ability to interact with project teams and by successfully promoting their ideas in the context of open and co-operative processes which go beyond hierarchical lines-of-command. Furthermore, innovative leaders must be sensitive to the complex social and environmental issues that now represent the grand challenges, and develop the means of co-creating solutions with members from different disciplinary or agency domains. We believe that, by actively nurturing and fostering the growth of innovation leaders, a better, more dynamic and well-directed innovation ecosystem will emerge.

Innovation Leadership as a Modality

Innovation leadership is the capacity to drive innovation and a *culture of innovation* in an ecosystem. This leadership is not only embodied in a role in an organizational system that is dedicated to innovation, but a *modality* that can be assumed irrespective of rank and seniority. It is our view, that while innovation is a capacity to create and implement novel ideas, Innovation Leadership is the capacity to lead through innovation, catalyze change-agency, and create the propensity for teams and organization to participate in creating cultures of innovation. More so than other fields of leadership, innovation leaders have a significant impact on the level of innovation through their ac-

tions. The innovation leader's openness to divergent thinking, inquiry and experimentation as well as their social outlook directly impacts the innovation propensity of those around them as well as the outcome of the activity. And whereas academic institutions have traditionally rewarded people for their understanding and creation of deep knowledge in a narrow field, Innovation Leadership recognizes that there is an increasing need to value those of broad and interconnected knowledge because it is at often at the interstices between fields of knowledge that innovation occurs.

An Ecosystem of Innovation

An ecosystem of innovation is one that is created as a result of convolution among pedagogy, practical processes and delivery systems and services. Educational institutions, strongly endorsing innovation leadership, with partner stakeholders, such as government agencies, industry, start-ups, venture capitalists, and non-profits organizations, work together can build new types of platforms and relationships that create impactful outcomes. A culture that fosters innovation, entrepreneurship, tackling complex challenges, and creating new thinking to address emerging issues, such as social or environmental issues, would be served by and would serve the creation of innovation leadership. Ultimately, students emerging as innovation leaders would require the environment that leverages their potentials. In addition to building the *supply chain* and the training grounds for innovation leaders, significant efforts need to focus on advocating and changing the mind-sets and cultures of

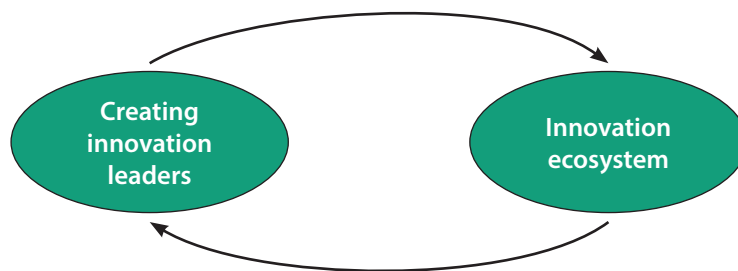

potential employers to create jobs at all level such as innovation is honored and rewarded.

How Can Research-led Education Support Innovation?

Currently, the education system at the graduate level is focused on forming excellence in specific topic of research. Typically, the best PhD students are the world's best experts on a quite narrow topic, many of who end up being educators supporting this methodology. Excellence in innovation requires a very different mindset. In addition to the depth of specialization, a student must learn 'holistic skills' that are enabling to:

- Understand the socio-technical implications of their research
- “See” the most promising options for the exploitation of research
- Foresee how to interact with the infrastructure in the ecosystem for transforming research results into market opportunities
- Understand how research results interact with a broader spectrum of technologies that are required to “make it happen”.

Students should be required to have interdisciplinary experiences as well as learn “translation” abilities for coping with the diversity of technical languages in use by different communities. Furthermore, students should understand and realize how their efforts relate and meet social needs.

What are the Main Aspects of Innovation Leadership?

Innovation leadership is a capability that organizations must have. It is a capacity that is needed at all tiers of management, from C-level managers to junior team leaders, and must therefore be recognized by organizations. Currently the business system has a gap: organizations do not have positions as ‘Chief Innovation Officer’ and there are no professional certifications for innovators. This gap must be bridged with new roles and expectations around innovation modalities.

Key attributes for an innovation leader can be specified and assessed. These include:

- Comfort with ambiguity and ill defined challenges
- Ability to identify innovative direction and navigate in complex scenarios
- An ability to frame problems in holistic ways
- Systems thinking
- An ability to imagine alternative futures and keep multiple possibilities alive
- An ability to create a culture of innovative and bring innovation to any situation
- Ability to create collaborative environments that provide the right initial conditions for innovation
- Multi-stakeholder thinking
- An intuition for implicit social needs and broader global challenges
- Ability to generate co-creation among people from different disciplines
- An ability to combine top-down with bottom-up approaches
- A bias to action, with an ability to “make it happen”
- An ability to shape the strategic phases with an deep intuition of implementation
- An ability to bring an idea to life, make it compelling and communicate it's true potential
- An ability to combine multiple cognitive approaches (deductive, inductive & abductive)
- Drive win-win situations

However, we do not expect that persons serving at all levels of the organization would have to acquire all these characteristics. One can envisage three levels of innovation leadership (see following table), which require different sets of skills, knowledge and attitudes. These can respectively be viewed as guidelines for hiring profiles and for training programs.

On a deeper level, we believe that innovation leaders have cognitive qualities that must still be better understood before they can become ingredients of targeted training programs.

	Skills	Knowledge	Attitudes
Gurus (able to generate compelling ideas and visions)	Thought leaders Imagination of alternative futures and solutions Creating compelling ideas Multiple cognitive approaches (inductive, deductive, abductive) Intuition for implicit needs/empathy Critical Thinking at a high level Experts at process-design Ability to identify context Capability of coping with risk, uncertainty, ambiguity An ability to teach/transfer Design Thinking and innovation Strong communicators and compelling story-tellers	T or PI-shaped Capability of coping with risk, uncertainty, ambiguity	Future mindedness Out of the box thinking Intuition for implicit needs/empathy Fast learner Passion for winning Capability of coping with risk, uncertainty, ambiguity, thought leadership
Leaders (able to implement change in activities, processes and behavior)	Influencing behavior Innovation culture mavens Multiple cognitive approaches (inductive, deductive, abductive) Intuition for implicit needs/empathy Innovation process experts Ability to identify context, frame, synthesize, conceptualize, prototype, communicate Ability to identify context Capability to execute Capability of coping with risk, uncertainty, ambiguity	T or PI-shaped Capability of coping with risk, uncertainty, ambiguity	Passion for winning Intuition for implicit needs/empathy Fast learner Capability to execute Capability of coping with risk, uncertainty, ambiguity
Agents (able to enact innovation at a more local level)	Innovation process experts Ability to identify context, frame, synthesize, conceptualize, prototype, communicate Capability to execute concepts Capability of coping with risk, uncertainty, ambiguity	T or PI-shaped Capability of coping with risk, uncertainty, ambiguity	Fast learner Capability to execute Capability of coping with risk, uncertainty, ambiguity

What should an Educational Institution Inculcate to Foster Innovation Leadership?

Institutional cultures, pedagogic styles, and curricula will have to be restructured to encourage a multi-disciplinary and system thinking, provide environments for interactions, and open space and mindset for hands-on practical activities that would shape the innovation leaders skills, mind-sets, and identities. Promoting such new characteristics is not easy, and will take

experimentations and assessments. One can envision some of the topics to be promoted, but not all. In the following we provide some:

- The ability to create environments where people can operate in teams and networks to cope with constant organizational change. Such teams would engage in creative actions that connect with diverse disciplines as well as with the society.
- Teams and networks are not “givens”, but co-evolve dynami-

cally along with the innovation process, and according to an intentional frame. The concept of ‘team’ is also dynamic in the sense that the focus of the process must constantly move between different tiers, from the individual to the “closer” team and up to broader connections and networks of teams. Innovation leaders must be able to exploit and lean not to be overwhelmed by the heterogeneity of roles and competencies included in the team and in the broader network. In fact, this not only provides greater richness of information, but also a variety of perspectives and ways of thinking that can increase the resilience of the solutions being developed.

- The confidence to uncover and champion purposeful intent for change that takes into account the strategic complexities

of a situation and minimizes unintended consequences. At the same time the innovation leader questions and challenges to ensure the continued appropriateness of the intent.

- The ability to understand and perform the appropriate action in the appropriate time frame (“keep pace”). Innovation leaders must be able to work on both short-term and long-term perspectives, managing the tradeoff between delivering something that works now and something that has a stronger meaning in the long term. Similarly, they must be able to iterate between the phases of thinking of acting, of planning and executing in a hands-on manner, dispelling the notion that “brainy innovators must come up with ideas and implementers will work to make them real”

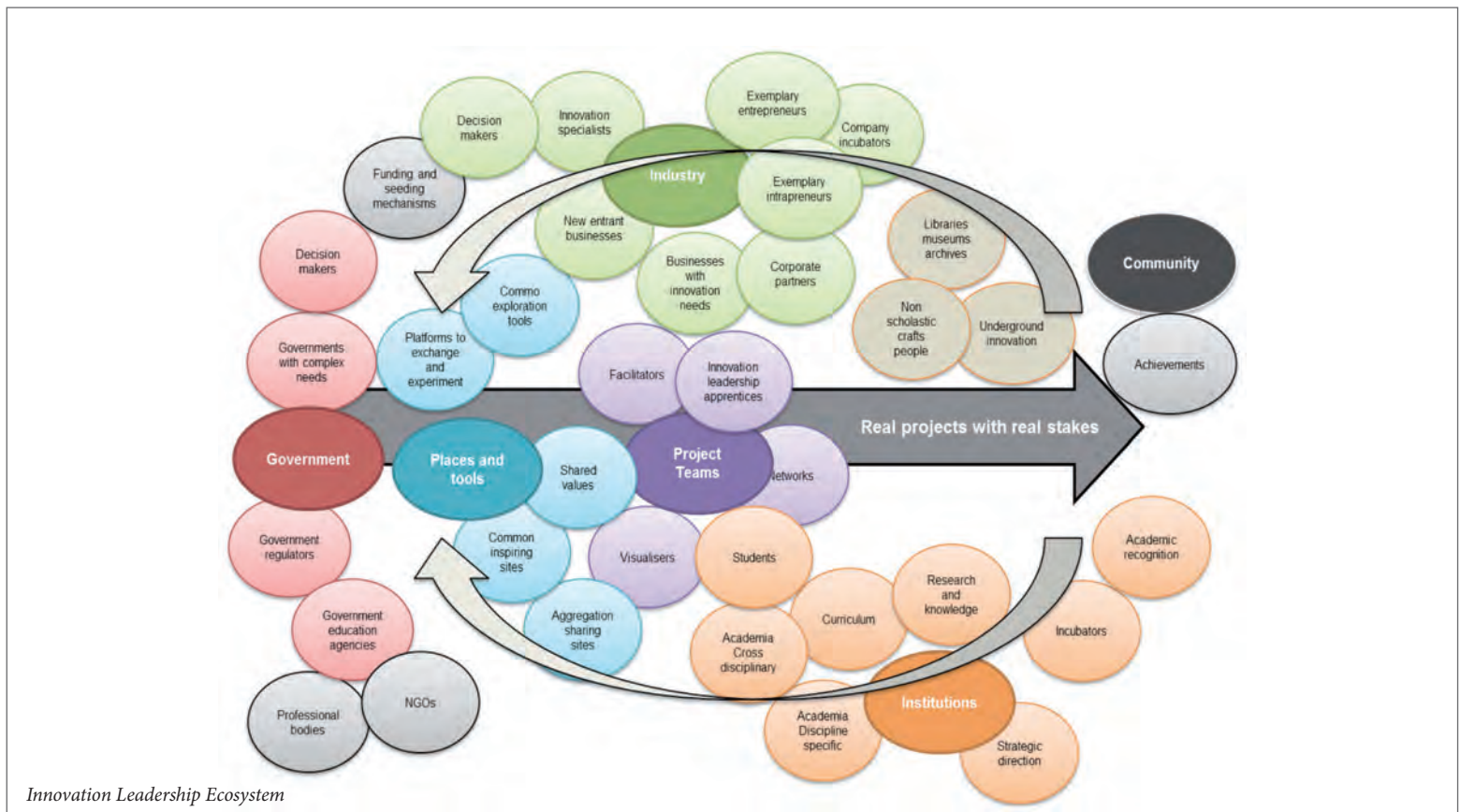

- The capability to manage the tension between process and content. As in all creative activities, the actors involved must deal with both the content of the problem being tackled and with the path to be followed, understanding to what extent they should deviate from customary solutions and processes. Common questions in any design problem are “What should we choose?” are “What should we do next?” The innovation leader is able to lead the team through this itinerary, finding the right balance between visions and objectives, “What is the right thing?” and “How to do the right thing?”
- The capability to constructively deal with radical and disruptive change. We believe that radical innovation based on a vision should not be feared and can be a compass to follow, but it can also become a blind religion. On the one side, innovation leaders must be able to facilitate the emergence of radically innovative solutions, challenging established norms, envisaging disruptive and paradigm-shifting solutions which - for stakeholders - may represent unfamiliar territories in which it is difficult to cope and act. However, a true innovation leader must also be able to draw a path through these territories, showing how the innovation can be implemented and the related risks managed, gaining initial acceptance for the solution, and then leading through its execution.

What could be done in order to actively support the emergence of Innovation Leadership?

Developing innovation leaders is not a purely academic or theoretical pursuit. We believe that innovation leadership cannot be developed in a vacuum, but only if active engagement and dialogue with the “innovation ecosystem” is established, monitored and actively reinforced by all the stakeholders in the ecosystem. We therefore think that an important role is to look across the ecosystem to identify opportunities to intervene to increase the recognition and professionalism of innovation leadership. Reward systems, common language, curriculum, relationships, knowledge bases and opportunities for innovation leadership experience are some of the interventions that could be considered. A primary role is to strengthen the links between the actors and stakeholders interested in innovation and, within this context, to identify ways with which innovation leaders can be appropriately trained and supported in their role. At the same time, we recognize that wider benefits can be achieved if this “innovation ecosystem” is not limited to the immediate surroundings of each institution, and wider links are drawn, spanning communities, industries, academic disciplines, and geographical boundaries.



What is the Como Summit Group Going to Do in This Context?

The Como Summit community comprises a diverse group of stakeholders interested in innovation and, more specifically, in understanding and actively fostering the development of innovation leadership. It is composed of senior academics in charge of educational programs, corporations and public institutions.

The first Como Summit took place on September 12th and 13th, 2012. The forum, initiated by Prof. Stefano Ceri and Prof. Marco Cantamessa from Alta Scuola Politecnica and by Prof. Banny Banerjee from Stanford University, was created with the vision that it is necessary to create an international community of thought leaders on innovation leadership; the Italian minister of Education, Francesco Profumo, also attended the event.

The group spent two days in workshop fashion, on characterizing best practices, identifying obstacles, and creating a strategic vision for advancing and scaling innovation leadership. The collective vision of such a unique group of thinkers also led to the conclusion that it is necessary to develop an international community able to give strategic direction to the future of innovation leadership. So, it was decided to turn the workshop into an annual event to be held at Como, to be known as the Como Summit. The first 2012 Summit allowed gaining a better understanding of the concept of innovation leadership.



This white paper is a first step in fulfilling the objectives defined at the end of the summit, i.e. to define and promote the concept.



ASP Alumni – Overview

The ASP Alumni Association was founded on June 28, 2007, the day of the graduation ceremony of the 1st cycle of the ASP students, with the aim of promoting opportunities for personal and professional growth and becoming a frame of reference for all future Alumni.

The association is a global network of highly qualified professionals who wish to share experiences and growth opportunities. Indeed, in the first 5 years, the association has grown rapidly and now boasts a community recognized in the academic and business world, with a network of over 700 members located across 20 countries and operating in the most widely recognized international companies and research organizations.

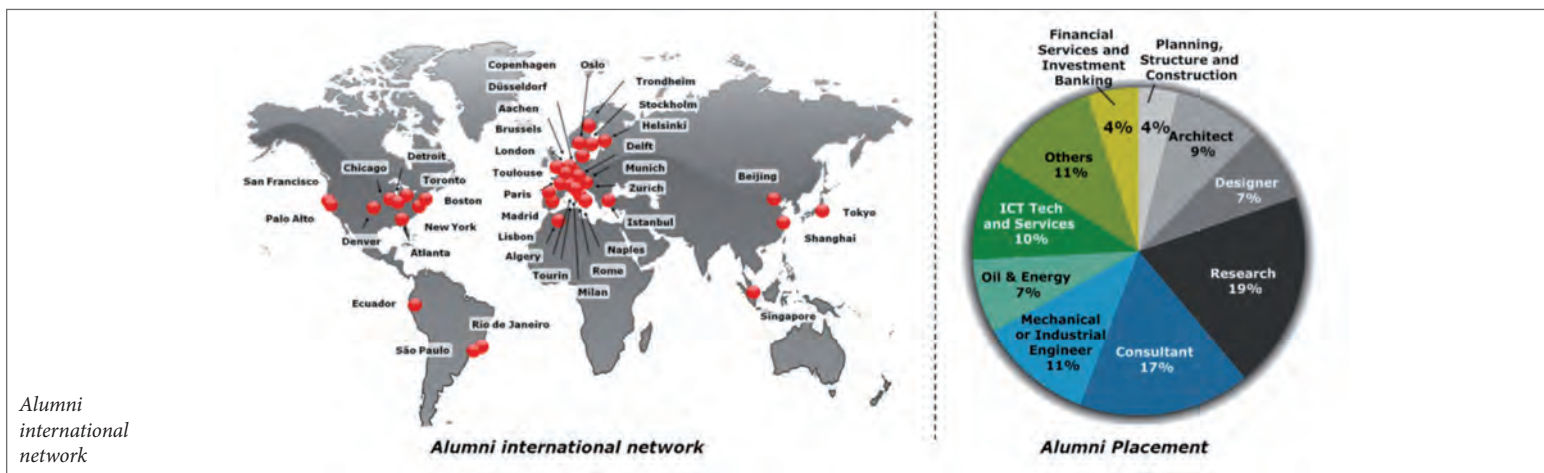

Alumni international network

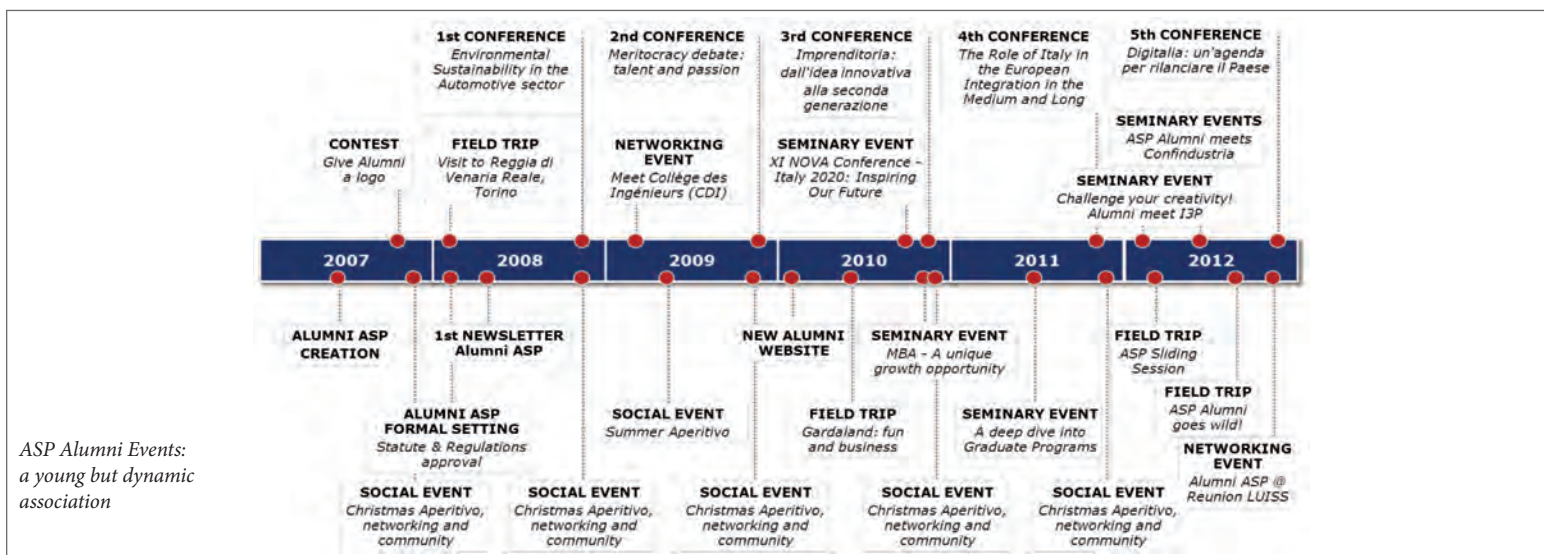

ASP Alumni Events: a young but dynamic association

The association, led by a board of 10 volunteers, organizes annual conferences, workshops to foster the alumni professional careers, and social events and aperitifs. Moreover, an official website and social channels help the community to share opinions, updates but also interesting job opportunities.

In 2012 the ASP Alumni introduced two new developments. First, collaboration with Confindustria through the organization of a conference on the topic of Open Innovation, also with the aim of providing additional networking opportunities with other alumni associations (including LUISS); the second change consists in a 1:1 mentoring project involving, in the first year, 50 Alumni as mentors, and 50 mentees among the current ASP students.

Alta Scuola Politecnica Alumni – Mentoring Project: together to build a bridge for cooperation

50 Mentors, 50 Mentees, the ASP Alumni Education team and the desire to create a project of excellence! These are the ingredients of the innovative Mentoring project launched by ASP Alumni association in December 2012. The aim is to create a bridge for cooperation between Alumni and the ASP students to help them enter the job market, because quality people deserve quality opportunities.

The project started with a simple question: “Did you finish university without knowing which way to go in the job world? Would it be helpful to have someone at your side to help you go in the right direction and tackle the first interviews in the best possible way?” After experiencing these needs as students, the ASP Alumni decided to provide some answers to current ASP students.

The protagonists are the mentors, ASP Alumni with several years of experience working in all areas, such as research, marketing, finance, consulting, design, etc. together with the mentees, the ASP students. Mentees and mentors were paired according to the professional preferences expressed by each mentee.



Starting from the fourth year of university, the first year of the MSc at ASP, mentees are entitled to a minimum of four meetings with their mentor, both face-to-face or by videoconference to address topics such as the choice of the sector or geographical area, how to write a CV and the cover letter, preparation for the interview and much more. From the second meeting, the mentee is able to meet additional mentors who can offer experience in another field of work. “The mentor community is truly global; present in five continents, they can bring a perspective of what it means to work in a function or in a business segment.

Along the way, mentors are aided by a guide, to be used as a reference when helping the mentees. All participants have agreed to a code of ethics that seeks to ensure that mentors will honor their commitment and provide the service free of charge, as a token of gratitude, with the idea that mentors will be giving back something of what they have received, by passing it on to younger friends.

At a very challenging time for Italy, the ASP Alumni wish to bring a new spirit of solidarity, an initiative which springs from the involvement and contribution of many towards the success of meritocracy.



ASP Alumni meet Confindustria

On April 14th, more than 100 ASP Alumni, students and professors got together to attend the conference “Riconoscere e premiare l’eccellenza e l’innovazione. Una sfida per l’Italia che crede nel futuro” (*Identifying and rewarding excellence and innovation - a challenge for Italians who believe in the future*), co-organized with Sistemi Formativi Confindustria. The aim of the conference was to present the six best ASP multidisciplinary projects and to promote the culture of open innovation, as a way to foster collaboration between research and companies. This session was a first occasion for teamwork between the ASP and Confindustria, paving the way to future prolific collaborations.

A prestigious table of authorities opened up the event. The Dean of Politecnico di Milano, Giovanni Azzone, and the Dean of Politecnico di Torino, Marco Gilli, started the discussion by talking about the ASP as a concrete example of high quality education, stressing the importance of education programs dedicated to talents for the shaping of Italy’s future leaders. Giusy Cannone, President of the ASP Alumni Association, explained how meritocracy is to some extent perceived as some-

thing to be afraid of as a synonym of inequality; on the contrary, it is the lack of meritocracy which leads to inequality and to a low level of social mobility. The welcome speeches were end by Luigi Serra, President of Confindustria – Sistemi Formativi, who presented data to underline the difficult situation that young people are facing and to suggest challenges and opportunities

they may exploit. Finally, Giorgio Squinzi, President of Confindustria, joined us to show his support towards young talents who are the key to restarting our economic system.

After the welcome speeches, the six finalist teams took the stage and presented their interesting and fascinating projects. The first place went to *Helios*, a robotic desk lamp that defines a new paradigm in the way human beings interact with light, the second place went to *Polipante*, a device for the generation of marine energy and the third place to *Maps, Medical advances through Proteomic Solutions*.

The day ended with an outstanding roundtable on the topic of Open Innovation moderated by Sergio Nava from Radio24. Professor Mario Calderini, Politecnico di Torino, pointed out that until industrial policy focusses on high technology sectors, integration between research and industry will continue to be very limited and difficult. Alberto Truzzi, President Confindustria Mantova, expressed his confidence on the willingness of firms to lower some barriers and to cooperate through open innovation. Lucia Chierchia, Open Innovation Manager Electrolux, stated that companies which have adopted the Open Innovation model work by aligning the interests and the incentives of the company and the researcher to generate a win-win



relationship between the two parties. Giorgia Bucchioni, Vice-President at Giovani Imprenditori di Confindustria, reinforced the concept by underlining how a company is a homogeneous group made up of many people who, with definition of the business as their goal, pursue the same project to create wealth for the good of the company, the entrepreneur and the workers. Finally Matteo Bonardello, Board Member of the Alumni ASP Association, confirmed the importance of a multidisciplinary education such as the one the ASP provides in order to gain the skills to work on innovatory tasks.

Giusy Cannone, Matteo Bonardello, Enrico Prunotto
ASP Alumni Executive Board



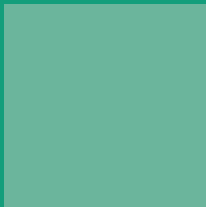
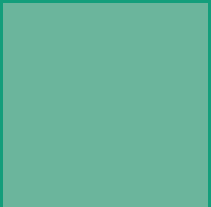

PROJECT 1

PROJECT

DeCoSe



**DESIGNING COLLABORATIVE SERVICES TO BOOST SOCIAL
INNOVATION IN SMART CITIES**



DeCoSe

Designing Collaborative Services to boost social innovation in Smart Cities

PRINCIPAL ACADEMIC TUTOR

Francesca Rizzo

Industrial Design, Arts, Communication and Fashion, Politecnico di Milano

ACADEMIC TUTORS

Alessandro Balducci

Deputy Rector, Politecnico di Milano

Elena Baralis

Control and Computer Engineering, Politecnico di Torino

Grazia Concilio

Architecture and Planning, Politecnico di Milano

Piero Fraternali

Electronics and Information, Politecnico di Milano

Ezio Manzini

Industrial Design, Arts, Communication and Fashion, Politecnico di Milano

Maristella Matera

Electronics and Information, Politecnico di Milano

Alfredo Mela

Human Settlements Science and Technology, Politecnico di Torino

EXTERNAL INSTITUTIONS

Atelier Studio Associato

TxT e-Solutions

Malmö University

EXTERNAL TUTORS

Per Linde

Malmö University - School of Arts and Communication

Jesse Marsh

Atelier Studio Associato

Francesco Molinari

TxT e-Solutions

TEAM A

Francesco Corazza

Computer Engineering

Carolina Gomez Naranjo

Environmentally Friendly Product Design

project 1

Envisioning collaborative service ideas to stimulate social innovation in 5 different urban components: Neighborhood, Street, Square, Museum, City Hall

Andrea Pollio [Team controller]

Architecture

Lucia Rampanti

Architecture

Ida Telalbasic

Product Service Systems Design

TEAM B

Chiara Basile

Architecture

Marcella Bonanomi

Architecture

Federica Manenti

Urban Planning and Policy Design

Roberta Moretti

[Project Communication Coordinator]

Industrial Design

PROJECT DESCRIPTION

Rather than just focusing on the installation and control of network hardware, city governments, technology companies and their urban-planning advisers can exploit a more bottom-up approach to creating smarter cities in which people become the agents of change (C. Ratti, 2011).

Many cities are recently developing “Smart” agendas, many of which managed as a strategic selection from among a range of ICT infrastructures and equipment offered by the technology industry and/or being discovered by observing other cities. Yet is ICT infrastructure a key condition for smart innovation? Do heavily “wired” environments and services match the concrete needs of people in real urban places? Is the technology driven approach to urban innovation the best way to develop smart agendas?

A different, more human-oriented perspective is slowly emerging, also inspired by the Territorial Living Lab approach, which identifies citizens as the key agents of change in a “smart path” towards innovation. People in cities, from within their specific urban spaces, can be the “authors” of a new city smartness in which technologies can be seen as innovation enabling infrastructures more than innovation drivers. In this sense, “smart” (perhaps “wise”?) is a city that learns how to self-organize its smartness; which is aware of its rich capital of people able to shift resources back and forth from cyberspace to “cityspace”; which is aware that citizens are not only “intelligent” but also accessible and able to make their city a place with an infinite variety of choices. In such a smart city people are the engines of innovation.

The aim of the DeCoSe project was to envisage collaborative service ideas to stimulate social innovation in the context. The project was developed in conjunction with European Research funded in the framework of the 7FR called Periphéria (in which

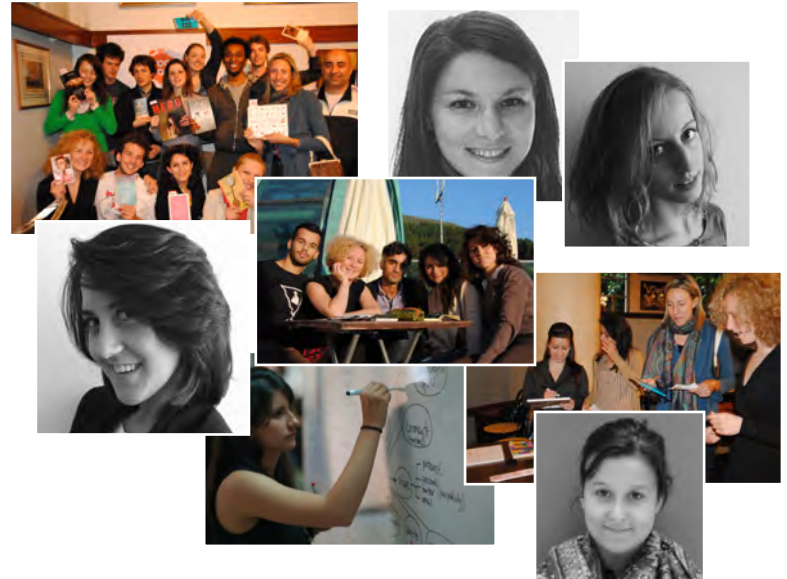

Politecnico di Milano is involved as partner) whose aim was to conceive, develop and prototype digital services to exploit future and emerging Internet technologies to promote new ways of living and new forms of consumption. The project was developed with the living lab approach, according to the definition that a living lab is a user-centered, open-innovation ecosystem, often operating in a territorial context (e.g. city, agglomeration, region, integrating concurrent research and innovation processes within a public-private people partnership). The DeCoSe team focused attention on designing future collaborative services through the combination of the potential of Internet of Things, Internet of Services and Internet of People. These types of collaborative services are based on socio-digital innovation and are capable of supporting social innovation, intended as new and sustainable ways to organize new forms of everyday life. Both teams worked on the specific context of the Politecnico di Milano arena and in order to enhance it as a smart campus, elaborated smart solutions, Toc Toc and &Co to stimulate people from the neighborhood and people from the campus.



TocToc Movement

TASKS & SKILLS

Francesco Corazza worked on development of the application, dealing with technical feasibility of the software. His research activity was focused on case studies and business model optimization. He was also in charge of the group work scheduling.

Carolina Gomez Naranjo dealt with the user interface of the application. She worked on experiment communication strategies and collaborated with Ida Telalbasic for project branding activities, particularly development of the logo and presentation styles.

Andrea Pollio coordinated the group work and organized preliminary research activities, both with regard to background knowledge and to fieldwork. His main task was content management.

Lucia Rampanti was the spokesperson for the group, maintaining contact with external stakeholders and institutions, organizing meetings and experiments. During the research phase, she was the key fieldwork person.

Ida Telalbasic was the project branding manager. Her research contribution mainly dealt with co-design processes and experiments but she was also crucial during field analysis. During the final phase of the project she joined Lucia Rampanti in organizing public relation.

ABSTRACT

A short text highlighting the main issues of the team's project presenting the proposed solution and its advantages.

With the goal of fostering sustainable lifestyles, taking advantage of the participative web and the mobile Internet, the challenge of the group was to build a collaborative service which could also address one of the main urban issues in the area of Città Studi: the weak integration between campus users and neighboring residents.

Therefore, team A's project explores the possibility of reducing wastage and consumerism, while building a local community which can mutually benefit all citizens, from residents in the area to temporary students.

Starting from in-depth field research - based on interactive design techniques - the idea was to propose a new social service that enables mutual exchange. TocToc, the name of the service, is the onomatopoeic word for knock knock and represents the simple act of knocking on a neighbor's door to ask for something needed. The service consists of a web application where people can offer what they do not need anymore, what they are willing to exchange or simply avoiding that an object ends its life in a dump when someone else can still make a use of it.

From a technical point of view, the application runs in an html5 framework, being completely interoperable between computers and smart devices such as tablets and smartphones. It allows users to register and create a personal profile, scrape, browse and interact with other users' offers, as well as launch an offer, giving it a character through geotagging and adding photos of the object to be exchanged.

Such an application presents the advantages of creating both a service that fosters sustainable behaviors and an opportunity to build a local community. As far as the latter is concerned, the entire project was developed in such a way as to involve locals in the application co-design process through experiments and interviews. Once the application is up and running, exchange can bring together different categories, for example students and residents, who can benefit from what they have to share.



1 Logo

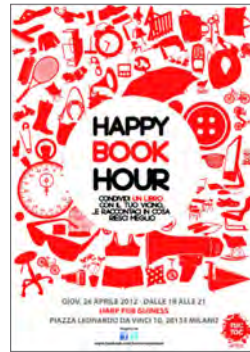

2 Flyer promoting the HappyBookHour event



3 Stickers for the viral strategies



4 Business card promoting the movement

UNDERSTANDING THE PROBLEM

The first phase of the analysis involved people experiencing the campus, since the project objective was to build a service to promote sustainable lifestyles, and at the same time stimulate a local community, a kind of urban laboratory. The framework for this investigation was Persona Analysis, an interaction design technique to depict fictional profiles, precisely personas, of hypothetical users who might become targets of the project process. Building personas starting from real users is the crucial key to achieve profiles that are as true to reality as possible. For this reason, field research included several activities that focused on people, in order to identify issues and possibilities of experiencing Città Studi. Ranging from guerrilla observation to online questionnaires, from statistical facts to face-to-face interviews, the field study was characterized by in-depth interaction with all categories of people (students, professors, residents, workers, shop owners, etc.). Working in a Living Lab approach, even the initial contact with users is already a crucial part of the implementation process. The profiles created through the analysis helped to define a number of key points, i.e. rules to follow to assemble a successful marketing strategy. One major input, for example, was that focusing on passive participation, which means changing people's behaviors, is easier than focusing on active participation. Besides, inclusive strategies appeared to be less effective, while focusing on existing groups seemed a good way to increase participation. The Persona

Analysis, with its direct user involvement, was also a good way to identify issues and the needs of people living in the area. Apparently, a strongly perceived issue is the absence of patterns of interplay between campus users and residents, i.e. lack of an identity that could stimulate a sense of community belonging. From this starting point, and with the objective of creating a service to foster re-use rather than consumerism, the idea of the TOCTOC service came into being.

EXPLORING THE OPPORTUNITIES

Our challenge soon became to combat fragmentation of the local community (i.e. students and residents in Città Studi), avoiding excessive consumption and growing marginalization of people impoverished by the crisis. Hence the aim was to create a service with real utility for its users and which could achieve all our goals, despite their belonging to two different - social and sustainable - spheres.

The Toc Toc Movement was the answer: a platform for exchanging objects that people no longer need, in which sociability is fostered by a web based living community that helps reduce consumption through re-use and exchange.

Thanks to the group's participation in the Social Innovation Camp (SI Camp) at The Hub Milano, a social innovation award which led to an intensive workshop (from 8th to 10th June 2012), the group was able to benefit from the support of business ex-



5 Working on the application during the Social Innovation Camp, Ph: The Hub Milano, 2012/06/09, Milan



6 TocToc application icon on the smartphone home screen



7 Splashscreen visualized when loading the app



8 First view of the app



9 Login form

perts and startups. The experts were crucial in helping the group decide to build an application which concerned only physical assets and not intangible objects or skills. Although this idea remains a possibility for future implementation, the suggestion of skilled specialists was to start with the simplest possible pattern of interaction.

The SI Camp, and later on participation in Tavoli Tematici per l'Expo 2015, were crucial in confirming that the goal which the group was addressing had a vital role in the contemporary search for socially driven innovation. Participation in workshops and social innovation camps was also pivotal as a first stage for the creation of a critical mass of people aware of the service.

Since the framework was a living lab approach, the first steps had to be experiments with an expressly created small community. Experiments were fundamental to understand, in an analog context, what were the issues and critical points of the exchange pattern, for example, how barter takes place between people who do not know each other. Within this kind of approach, experiments were the way in which the group could explore the possible alternatives.

But how to stimulate the first community of swappers? As a consequence of the Persona Analysis, the general guideline was to implement focused and not inclusive marketing strategies. Thus, word was initially spread through a peer-to-peer communication strategy focused on students of Città Studi. A new page was

created on facebook and on twitter (Toc Toc Movement) and the accounts were used as the main channels for advertising the event. On Youtube, a teaser video (aimed at creating curiosity) was launched during the first experiment. The viral phase also continued with physical urban actions, putting up posters in strategic places on the campus so as to generate curiosity; a second phase of guerrilla marketing was addressed to elderly people, waiting for them outside the supermarket, outside the metro station and handing out flyers to explain the project. Thanks to this marketing strategy, which also addressed parents of local school children, the group was able to explore the possibilities offered by a collaborative service based on exchange, though different kinds of experiments. Some were more successful, others less. Nevertheless, they all represented an opportunity to make contact with the local community, also to show mock-ups of the application that were being developed in the meanwhile.

GENERATING A SOLUTION

To assist the process of exchanging objects and to create a physical/virtual social network on top of this process, the solution converged on a web application. Therefore, the service develops a hybrid user experience which is accomplished through two stages: first, construction of a community; second, the exchange itself (i.e., through physical interaction).



10 User profile (I), showing the main user information

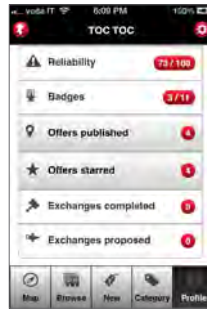

11 User profile (II), showing the user details information

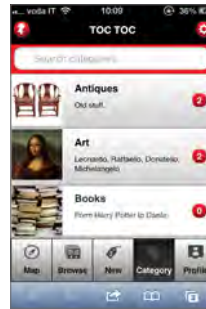

12 Browsing offers by categories

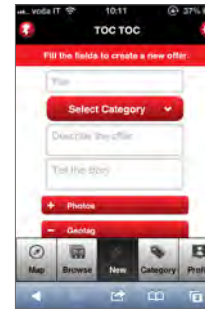

13 Insertion of a new offer (I), empty fields



14 Insertion of a new offer (II), with example

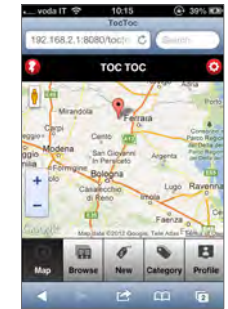

15 Geolocation, browsing offers by location

The service, from a structural point of view, comprises two components. The former being the exchange guide/support : in other words, the exchange itself, bookmarking of offers, uploading of new objects in the service, automatic suggestions of possible exchanges, offer browsing through categories and map browsing to see local offers. The latter concerns the development of communities of shared interests on the platform. To achieve this result, the application merges interaction styles typical of common social networks: folksonomy, searching by tags, following people, commenting offers or performing exchanges, liking or messaging (with) other users.

The application design addresses both parts in a transversal approach that tries to incorporate the two in a single interface (following the approach taken by Google Plus), with a timeline enabling virtual sociality and a dedicated toolbox which, on the other hand, enables all the fundamental instruments to perform the exchange process.

The innovative vision behind this application concerns the application features and components, which are not a mere virtual characteristic of the program but correspond to the physical world. When an exchange takes place – as a result of a virtual interaction in the application – it produces real interplay, which overlaps the virtual interplay, and can also create spatial/urban hot spots. In this overlapping of virtual/physical interactions

lies the driver of the communities which the service creates. Secondly, the physical part of the interaction increases service reliability, providing users with a sense of trustworthiness. As mentioned before, existing services choose to focus on one rather than the other feature of the service: either the virtual (e.g. the Ebay side) or the community (e.g. Freecycle, in which the web application is merely a support to an existing exchange community). Thus, the innovation resides in merging, both structurally and technically, these two approaches.

MAIN BIBLIOGRAPHICAL REFERENCES

- [1] Binder, T. - Ehn, P. - De Michelis, G. - Jacucci G. - Linde P. - Wagner, I. (2011) Design Things, The MIT Press, Cambridge (MA).
- [2] Manzini, E. - Rizzo, F. (2011) Small projects/large changes: Participatory design as an open participated process, in CoDesign, Vol. 7, Iss. 3-4, 2011.
- [3] Von Hippel, E. (2003) Democratizing Innovation, The MIT Press, Cambridge (MA).

WEB REFERENCES

- [1] http://www.youtube.com/watch?v=_cj4WXIw8Gg
- [2] <https://www.facebook.com/toctocmovement>
- [3] <https://twitter.com/toctocmovement>



&CO

Use everything, waste nothing

TASKS & SKILLS

During the two years, the team members worked together on the definition of the project that consists of:

- creation of an active and participating community in the Milanese district of *Città Studi*;
- design of a collaborative and innovative service on waste reduction;
- dissemination of the project through a scaling-up strategy.

In particular,

CHIARA BASILE | Architect, carried out preliminary research on the state of art of the topics concerned and wrote reports and documents for &CO participation in several calls and competitions.

MARCELLA BONANOMI | Architect, dealt with the creative concept of the service and the entire organization of &CO events.

FEDERICA MANENTI | Urban planner, conducted on-site surveys and questionnaires and managed contacts with authorities, companies and associations.

ROBERTA MORETTI | Designer, conceived the service and events and managed the &CO communication strategy and design, supervising its overall graphic presentation.

ABSTRACT

Nowadays unsustainable behaviors are widespread. The huge waste of goods, which the current consumption model imposes on us, is the most serious. Everyday kilos and kilos of goods, which might have an economic and useful value, are thrown away. Here comes &CO!

&CO aims to significantly reduce this useless waste by extending the life cycle of goods and their period of use through an up-cycling process.

The conceptual core of the project arises from the idea that one person's waste is another person's raw material. As our saying declares, transforming a problem into a value is possible: "&CO | *Use everything, waste nothing*".

The final goal was identified thanks to a CO-design and people engagement process. Following a Living Lab¹ methodology, all the different social actors, who are present on a daily basis in *Città Studi*, have been involved in every "action" carried out by the &CO team.

In this way a sustainable network, which links together different activities, has been created: those with waste materials to be disposed with those who need them. A free application for smartphones, based on a geo-tagging system, links together supply and demand of these superfluous materials. App users can both upload their availability of waste materials and search for them.

The goal of stimulating social innovation has been achieved by activation of this sustainable network. According to the collaborative nature of the service, the challenge lies in enlarging the community to a macro-scale through a scaling-up strategy.

¹ A Living Lab is a user-driven open innovation ecosystem based on a business-citizens-government partnership which enables users to take an active part in the research, development and innovation process: bringing the users early into the creative process in order to better discover new and emerging behaviours and user patterns (source: <http://www.peripheria.eu/>)



1 Politecnico di Milano, PoliPrint, 22nd March 2012. Please Turn Over event, a sample of the notepads produced. Ph. Roberta Moretti

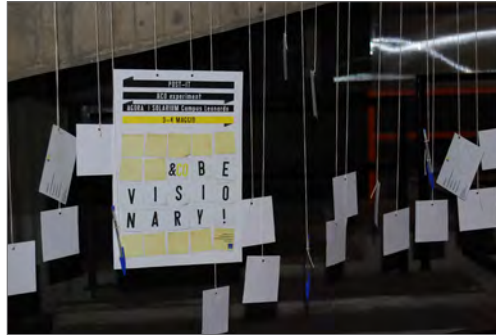

2 Politecnico di Milano, Patio Campus Leonardo, 3rd May 2012. Post-it event, recycled post-it installation. Ph. Roberta Moretti

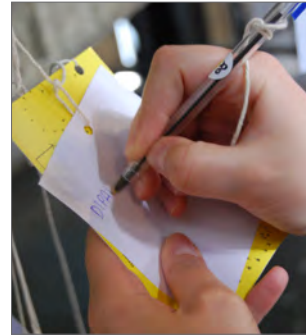

3 Politecnico di Milano, Patio Campus Leonardo, 3rd May 2012. Post-it event, a student's wish (I). Ph. Roberta Moretti

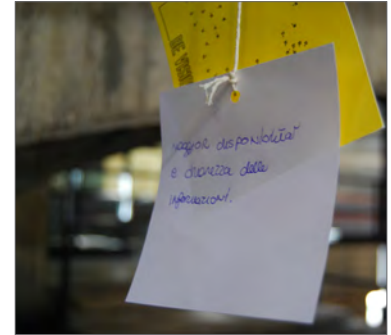

4 Politecnico di Milano, Patio Campus Leonardo, 4rd May 2012. Post-it event, a student's wish (II). Ph. Marcella Bonanomi

UNDERSTANDING THE PROBLEM

Campus Leonardo is the place where the &CO project began and where the *Behaviors* were first analyzed.

What, however, did people really consider unacceptable recurring habits?

A list of unsustainable behaviors has been created through interviews and questionnaires. Each hypothesis has been tested through on site surveys and investigations, together with realistic feedbacks.

It emerges that the more frequent unsustainable behavior relates to the management of waste, but not from a recycling point of view. For example, all bins in the Campus are equipped with differentiated boxes and people are very conscious of the waste separation issue.

The real problem is represented by waste of materials that could still have a potential value in both environmental and economic terms.

In every city there are many activities which produce waste materials (supermarkets, copy centers, industries, etc.) and which have to manage the difficult and costly problem of their disposal. In the meanwhile, many other activities (schools, universities, cooperatives, associations, etc.) need materials at low cost. This supply and demand of materials needs to meet in order to create value for themselves and the entire city.

EXPLORING THE OPPORTUNITIES

In order to obtain results on people behaviors and to design an effective service based on active engagement, &CO decided to define a strategy strongly focused on participation of final users in the design process.

The team applied a CO-design strategy by involving stakeholders in a number of experiments and by launching an on-line questionnaire on the use and reuse of materials in order to test service feasibility.

Three thematic events were organized and an equal number of slogans were created in order to launch them: *Be Creative*, *Be Visionary*, *Be Active*.

The first one, *Be Creative*, was focused on the idea that certain materials, such as paper and cardboard, which are considered just waste by some people, can become free raw materials for others. In this sense, &CO organized an event called "Please Turn Over-PTO", during which people were asked to create their own notepads with waste paper thrown away by copy-centers in the area around the Campus.

The second, *Be Visionary*, asked people to express ideas to create a better Campus. It tried to overcome the indifference of students and professors in relation to the possibility of change. The event related to this goal was called "POST-IT" and consisted in two recycled post-it installations, located in strategic places for



5 Politecnico di Milano, 10th May 2012. Shut it Down event, guerrilla communication sample



6 Politecnico di Milano, 7th October 2012. A shut it Down sticker on a student's laptop. Ph. Marcella Bonanomi



7 Medea Malmö University, 24th May 2012. Roberta entering the workshop. Ph. Lucia Rampanti



8 Politecnico di Milano, Giornate della Sostenibilità, 12th October 2012. Roberta preparing the installation. Ph. Federica Manenti

students' daily-life, on which people could write down their ideas, wishes and suggestions for a Sustainable Campus. To stimulate people to leave their comments, an “&COperitivo” was also organized turning out to be a great success.

The last, *Be Active*, tried to drive people towards change by an event called “Shut It Down”. The idea was to hang, in a sort of “urban guerrilla”, a number of yellow postcards near electric sockets and lifts in university buildings. On one side of the postcards amusing slogans such as “Keep calm and shut it down” were written, on the other interesting information on daily energy consumption.

GENERATING A SOLUTION

Shaping of the &CO collaborative service derives from these thematic experiments and from the response of the *Città Studi* community.

As a matter of fact, it appeared clear that the strongest, as well as the most attractive proposals were those of giving materials for free at the “PTO” event, having significant interaction at the “&COperitivo” experiment, stimulating claims for an efficient exchange network at the “Post-IT” event and always having digital components in every experiment.

All of them were included in the collaborative service project which aims **to network, through a digital platform (a free Application for smartphones) all possible suppliers of waste ma-**

terials (copy centers, box factories, supermarkets, carpentries etc.) to those willing to reuse them (universities, cultural associations, art schools etc.).

What has no use for somebody can be necessary and useful for someone else!

Thanks to geographic proximity between users and suppliers, the app will generate a sustainable network that can work both at the neighborhood micro-scale and at the urban macro-scale, based on the offer of waste materials at zero cost and kilometer. In order to ensure economic sustainability of the project, the &CO team envisages extension of the service consisting of three main activities:

- consulting for those users (industries, municipalities etc.) who are willing to set up an up-cycling process for their own production of waste materials;
- creative *officina*, accessible through a membership system, where waste materials are made available to users willing to reuse them.
- awareness campaign on waste reduction organized through workshops and thematic events.

Currently the team is continuing to look for useful contacts and possible partnerships and to advertise and market the service through its web channels (&COmmunity blog, Facebook and Twitter pages).

In order to scale-up the project and enlarge the community,

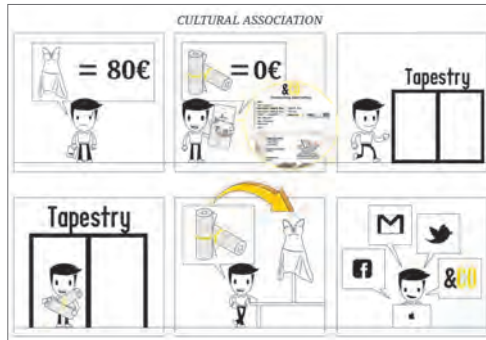

6 Scenario (I): service for a cultural association.

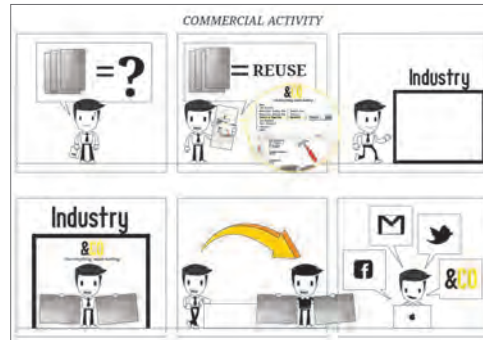

6 Scenario (II): service for a commercial activity

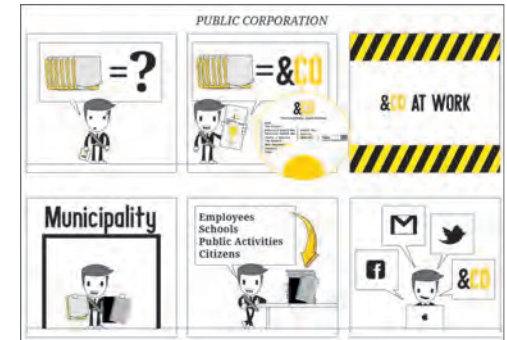

6 Scenario (III): service for a public corporation

&CO participated in many events.

The &CO team presentation during the Periphèria Workshop in Milan, as well as the previous one in Malmö (Sweden), represented the first opportunity to discuss the service with experts and receive useful feedback for its improvement.

Another opportunity to provide &CO visibility and to share know-how with other projects was offered by ASP attendance of “SCE 2012 - Smart City Exhibition 2012” in Bologna, during which the project was invited to be presented to many potential users and partners.

Participation in the “Giornate della Sostenibilità”, a two-day open festival organized at the Politecnico di Milano within the framework of *Città Studi Campus Sostenibile* and in the four-day “Recycle Sustainable Exhibition”, at the *Ex Spazio Ansaldo* in Milan, was a way to advertise &CO at an urban scale and to continue with people engagement. During the former, an awareness campaign on waste reduction was implemented through an installation called “This is not a box” which asked people to imagine a new life for waste materials. During the latter, instead, three thematic workshops were organized in order to involve people in a change of view on superfluous materials. In this sense, also the creative workshop on paper reuse which &CO organized at the end of November 2012 in a Milan primary school with the patronage of “SERR 2012- Settimana Europea Riduzione dei Rifiuti 2012” should be analysed.

As depicted by the DeCoSe multidisciplinary project, &CO is the

outcome of a design process with the objective of achieving a collaborative service in order to stimulate social innovation in Smart Cities.

It has been conceived to return, through a networked and smart service, to the initial issue, namely the need for a more sensitive awareness of REUSE possibilities, highlighted both through the vision of the designers in the problem seeking-phase and the responses of Campus users to interviews.

MAIN BIBLIOGRAPHIC REFERENCES

- [1] Von Hippel E. (2005). “Democratizing Innovation”, MIT press, Cambridge, MA, USA
- [2] Leadbeater Charles (2009). “We-Think. Mass innovation, not mass production”, CPI Bookmarque, Croydon, UK
- [3] Manzini Ezio (2010). “Design and social innovation. A catalyst of sustainable changes”, Politecnico di Milano - DIS, DESIS Network
- [4] Thackara John (2006). “In the bubble. Designing in a complex world”, MIT press, Cambridge

WEB REFERENCES

- [1] <http://www.andcoproject.wordpress.com/>
- [2] <https://www.facebook.com/andCOproject>
- [3] <https://www.twitter.com/andCOproject>
- [4] <https://www.youtube.com/user/ecomunitypolimi>

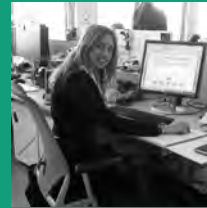
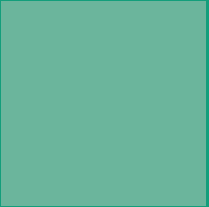
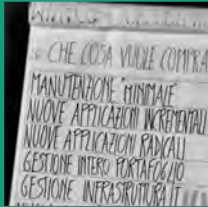
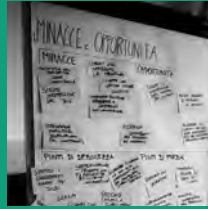

PROJECT 2

PROJECT

SME 2.0



**"SOFTWARE AS A SERVICE" AS A BREAKTHROUGH CHANGE
FOR SMALL AND MEDIUM ENTERPRISES**



SME 2.0

“Software as a service” as a breakthrough change for Small and Medium Enterprises

The SME 2.0 Project, developed in cooperation with Dylog Italia S.p.a. – Gruppo Buffetti, aims to investigate the EMS market and design an innovative solution for Italian SMEs exploiting Cloud technologies

PRINCIPAL ACADEMIC TUTOR

Emilio Paolucci

Management and Production Engineering,
Politecnico di Torino

ACADEMIC TUTORS

Mariano Corso

Management Economics and Industrial
Engineering, Politecnico di Milano

Chiara Francalanci

Electronics and Information, Politecnico di
Milano

Paolo Neirotti

Production Systems and Business Economics,
Politecnico di Torino

EXTERNAL INSTITUTION

Dylog Italia S.p.a. – Gruppo Buffetti

EXTERNAL TUTOR

Riccardo Ocleppo

Dylog Italia S.p.a.

TEAM A

Monica Beccaria [Team Controller and
Project Communication Coordinator]
Industrial Engineering and Management

Mirko Antonino Biondo

Industrial Engineering and Management

Claudia Colombo

Management Engineering

Alessandra Ronsini

Engineering for Cinema and Methods
of Communications

PROJECT DESCRIPTION

THE CHALLENGE

The software market for Small and Medium Enterprises (SMEs) is today facing a technological breakthrough and growing importance of distribution methods represented by “Cloud Computing” and “Software as a Service” (SaaS).

Existing technologies, software packages and vendor business models are rapidly changing, and future market leadership will be based both on new software adoption models and emerging technologies.

The heterogeneity of SMEs makes it difficult to have a clear view of the changes in progress, and it is hard for Enterprise Management Software (EMS) vendors to make plans concerning how and when they should embrace the new paradigm.

Meanwhile, new competitors, such as International software producers and Telecoms are entering his market, with effects on the structure and competition level.

The objective of the team was to identify the future scenario and conceive a solution for national EMS producers to deal with this disruptive innovation.

A multiple viewpoint analysis of the current situation was carried out, according to the various stakeholders involved.

THE RESULTS

Literature research, empirical case studies regarding all the actors of the supply chain and two Focus Groups with a number of Italian EMS producers provided the team with a complete overview of the current market situation.

As a first result, the team recognized that each kind of vendor has a different approach to the market. Traditional EMS producers supply software “on premises” enhanced by significant customization and full IT assistance. Meanwhile, pure Internet players, coming from the consumer market, have started proposing many different apps targeted to basic enterprise needs, evolving towards a real EMS.

Besides these, Telecoms, exploiting their infrastructures, are en-



larging their enterprise offer with Cloud services.

Starting from all the information gathered so far, the team conceptualized three steps for EMS producers to address the Cloud Innovation:

1. Enlarge the offer, including new general purpose products, exploiting the traditional distribution channel.
2. Integrate the products with enterprise Information Systems (IS).
3. Transform EMS for Cloud-based distribution.

Concerning the immediate step, the team developed the innovative idea of Cloud office, a 2.0 software suite targeted at Italian SMEs. This is a set of general purpose tools with special focus on cooperation and communication features. It comprises four modules interfaced with EMS: Data Management, Knowledge Management, Communication and Productivity. This solution will allow Italian software producers and their distribution partners to defend their position against new competitors and a pure Internet offer. Moreover it will help SMEs increase productivity and their familiarity with Cloud applications. It can be considered the starting point for SMEs to innovate their IS, exploiting all Web 2.0 potential and Cloud benefits.



SME 2.0

“Software as a service” as a breakthrough change for Small and Medium Enterprises

SME 2.0 — “SOFTWARE AS A SERVICE” AS A BREAKTHROUGH CHANGE FOR SMALL AND MEDIUM ENTERPRISES

TASKS & SKILLS

Monica Beccaria focused on the study of the market in order to formalize the needs of all the involved stakeholders, organising meetings and interviews.

Mirko Biondo mainly studied the interactions along the supply chain. Hence his main aim was to define the actors involved and their role in the software market.

Claudia Colombo analysed the level of ICT adoption among Italian SMEs, its underlying dynamics and different sources of influence.

Alessandra Ronsini worked on the state of the art of Cloud Computing related to SMEs, attending conferences and exhibitions in Italy and abroad.

ABSTRACT

The project is a multiple viewpoint analysis of upcoming technological innovations in the Enterprise Management Software (EMS) market. It was mainly carried out from the software producers perspective, but the team also dwelled on the role of distributors as a source of added value and on SME awareness of ICT benefits.

The objective of the team was to understand the future scenario and conceive a solution for national EMS producers to deal with innovative technologies such as Cloud Computing, Software as a Service (SaaS) and Web 2.0.

Team work is highly innovative because of the scant literature in this field and challenging because it addresses the entire SME ecosystem which is deeply heterogeneous and rapidly changing. Moreover, technology evolution is confused and the project will contribute to foreseeing what future trends could be. Interest is roused by the nationwide economic significance of SMEs, deriving from their numerosity, and their potential for EMS producers due to their low and unstructured ICT adoption.

The team found it meaningful to provide a general overview of the main changes foreseen in the market and, coherently, which actions should be taken by software producers and vendors in order to deal with them. The current situation shows that each kind of vendor has a different approach to the market: traditional EMS producers supply software “on premises” enhanced by significant customization and full IT assistance, while pure Internet players, coming from the consumer market, have started proposing many different apps targeted to basic enterprise needs, evolving towards a real EMS. Incumbents have to deal with the risk of new competitors from the lower end of the market.

Starting from all the information gathered so far and the foreseen scenario, the team suggested a solution to EMS vendors in order to exploit the potential of Cloud and contrast new entrants. Considering it necessary to include new kinds of products, the team conceived the innovative idea of *Cloud office*, a 2.0 software suite targeted at Italian SMEs. As far as the product concept is concerned, a description of functionalities, main technological features, collateral services which should be provided, business model and best fit distribution system are presented.

Cloud office includes a set of general purpose tools with special focus on cooperation and communication features. It is subdivided into four modules: Data Management, Knowledge Management, Communication and Productivity, all interfacing with an enterprise IS.

The first expected result, in firms adopting *Cloud office*, is an increase in productivity and of their familiarity with Cloud applications. It can be considered the starting point for SMEs to innovate their Information System, exploiting all Web 2.0 potential and Cloud benefits. Moreover, it will allow Italian software producers and their distribution partners to defend their position from new competitors and a pure internet offer.

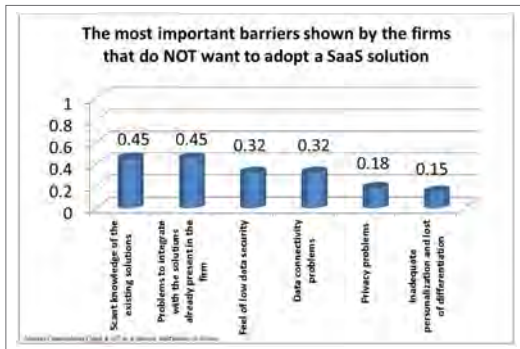

1 The most important barriers shown the firms not intending to adopt a SaaS solution



2 Cloud Office logo

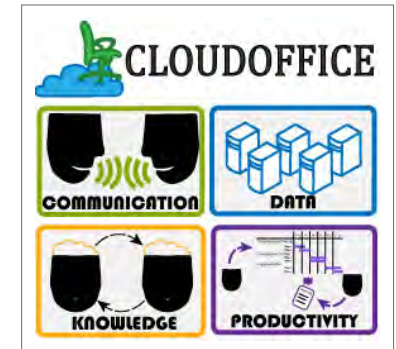

3 Cloud Office modules

UNDERSTANDING THE PROBLEM

The complexity of the market required a broad and multidisciplinary investigation of the economic, technical, social and legal issues involved. All these aspects were taken into account throughout the four phases of the project.

During the first phase the team acquired the necessary background knowledge on the EMS market and its stakeholders, ICT adoption by SMEs, the latest developments and the current hot topics. This analysis was supported by analyzing the academic literature, case studies, newspaper articles and attendance of academic conferences.

The second phase was an empirical study of SME knowledge and adoption of Cloud and its forthcoming evolutions. For this purpose, team members visited industry exhibitions such as TOSM (<http://www.tosm.it>), SMAU and Cloud Computing World Forum, attended a number of meetings with Dylog and Buffetti staff and finally implemented a number of case studies on SMEs and software dealers in Piedmont and Lombardy. The result was a detailed picture of supply chain requirements and conflicts, along with an overview of current ICT usage, perception and obstacles to innovation.

The outcome shows that SME interest in Cloud mainly concerns productivity and communication tools, rather than complete enterprise management software. Besides that, new actors are interested in SMEs. Pure Internet players are readapting their

consumer products for enterprises. Telecoms, exploiting their Internet infrastructures and broad customers network, aim to include also web-based services in their offer. Finally, for traditional EMS producers, Cloud Computing represents a disruptive and competence destroying innovation, forcing them to compete with these new competitors and rethink their business model.

The final aim of the third phase was to reconcile the customizations required by SMEs, EMS producers aim not to be left behind in the Cloud revolution and dealer disintermediation concerns. This was supported by an SME survey in Piedmont and Lombardy and two Focus Groups attended by a number of Piedmont software producers and ICT consultancy companies. Comparing the situation of medium and small enterprises, the team discovered that the latter can derive the most significant benefits from Cloud, due to their less structured ICT adoption and scant ICT skills. Mainly for this reason, the product conceptualized in the last phase was targeted at small enterprises, in order to design the most useful product concept.

EXPLORING THE OPPORTUNITIES

The first studies carried out showed that the management software market has entered a consolidation phase, since products are mature, poorly differentiated and all software producers already provide the majority of functionalities. Moreover, SMEs



4 Cloud Office: overview of modules and functionalities

lack funds for ICT investments and show inertia to innovation. In such a context, it had to be established whether a future scenario including Cloud was feasible or not.

The team discovered that IT innovation has until now typically been a push process and that nowadays increasing pressure towards Cloud Computing is exerted by key stakeholders such as Governments, large IT companies and Telecoms. Indeed, they understood the economy of scale which could be achieved with such a model and the success of Cloud services in the consumer market. Given this situation it is likely to that migration to the Cloud is just a matter of time.

The team then identified three possible ways for software producers to approach a Cloud solution:

- move to Cloud already supplied EMS;
- adapt existing management software to interact with dominant 2.0 applications;
- propose new enterprise tools based on Cloud.

Currently, the first alternative has been adopted by a number of national software producers but SMEs seem not to perceive true added value in this since they consider the shift to Cloud to be merely a new way of distributing the product, often less reliable due to its dependency on connectivity. The second alternative is the least probable to succeed, since it requires agreement among

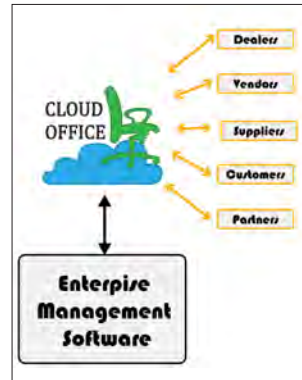

5 Cloud Office – Communication module screenshot: Advanced call conference with application sharing

4 The image shows Cloud office interfacing with EMS and enhancing cooperation with external entities



various software producers, often not in a balanced bargaining power condition. Big players, such as Google with its product Google Enterprise, are betting on the third approach but their tools, born in the consumer market, are not tailored to SME requirements. However, this hypothesis is the most attractive for national software producers due to their deeper knowledge of the Italian SME business, and for this reason the team studied which kind of applications could provide the best benefits for SMEs.

The team explored the Italian context in depth, discovering that there is poor perception of IT benefits and dealer intervention is the main discriminating factor for new IT investments, especially in small enterprises which usually entrust them with everything. Moreover most explicit and unvoiced SME requirements could be satisfied by horizontal and general purpose applications offered in Cloud. They could facilitate communication and co-working, which have been found to be the most common problems for SMEs. Furthermore, due to the current context, it would be necessary to push these products, exploiting all well-established distribution channels and mainly the dealer.

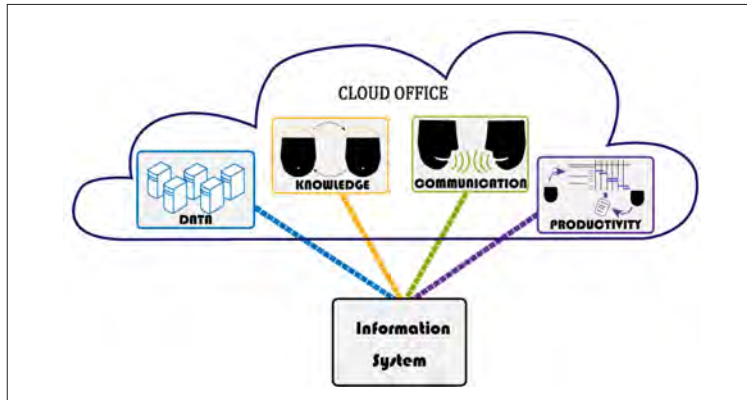

6 *Cloud office Modules*

GENERATING A SOLUTION

The solution suggested to national EMS producers, in order to contrast entrance to the market of big players and Telecoms, involves four steps:

1. Enlarge the offer, including new general purpose products, exploiting the traditional distribution channel.
2. Integrate the products with enterprise IS.
3. Transform EMS for Cloud-based distribution.

The team formalized the tools required to enlarge the offer of EMS producers, conceiving *Cloud office*. The product includes four modules best suited to SME requirements, emerging mainly from the survey results.

1. Data Management Module

To store, share, manage documents and different data formats, with extra functionalities such as search, versioning management and synchronization.

2. Knowledge Management Module

Organized in a Wiki-like structure and aimed at sharing and disseminating knowledge within the enterprise through storage, structured display and update of meeting and conference reports, manuals, company information, best practices and much more.

3. Communication Module

Designed to facilitate co-working within the enterprise and with external partners thanks to its advanced collaboration functionalities managing real time and asynchronous communication (e.g. audio and video conferences, messaging).

4. Productivity Module

Tool set supporting everyday employee work. In fact it provides features such as planning tools (e.g. Gantt), interactive agenda and contact book.

The team believes this solution has the advantage of being rapidly implemented by software producers without excessive investments and easily accepted by SMEs in the short term.

The product will be distributed through existing delivery systems with the support of a virtual store where SMEs could buy additional apps and add-ons, in order to allow them to autonomously customize their *Cloud office*.

As a five year market forecast, the members of the group believe that good diffusion of *Cloud office* will help SMEs in overcoming the inertia for 2.0 tools and accepting a totally Cloud offer, including management software sold through the on-line store. At the same time the role played by the dealer will change from sales to assistance and consulting. Hence, in the future scenario, the dealer will continue to be an essential figure for the industry. In conclusion, the strength of *Cloud office* is to allow software producers to escape from traditional management product competition, anticipating big players and maintaining the advantage represented by market knowledge and a distribution channel closer to the customer.

MAIN BIBLIOGRAPHIC REFERENCES

- [1] P. Neirotti and E. Paolucci, “Environmental influence on the development of it-based capabilities in SMEs: empirical evidence from Italy,” *Euram*, 2011.
- [2] Rapporto 2010 Osservatorio PMI, “ICT as a Service: ennesima moda o reale opportunità per le PMI?,” School of Management, Politecnico di Milano, April 2010.

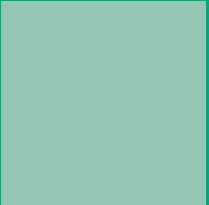

PROJECT **3**

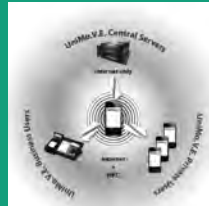
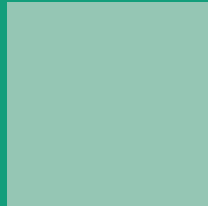

FUSE



**FUTURE SCENARIOS IN BANKING:
NEW SERVICES AND SUSTAINABILITY**



FUSE Future Scenarios in Banking: new Services and sustainability

PRINCIPAL ACADEMIC TUTOR

Chiara Francalanci

Electronics and Information,
Politecnico di Milano

ACADEMIC TUTORS

Marta Corubolo

Industrial Design, Arts, Communication
and Fashion, Politecnico di Milano

Emilio Paolucci

Management and Production Engineering,
Politecnico di Torino

REFERENCE EXTERNAL TUTOR

Giuseppe Salomoni

Unicredit Group

EXTERNAL INSTITUTION

UBIS - Unicredit Group

TEAM A

Shuhua Cao

Telecommunication Engineering

Martina Dell'Anna [Project

Communication Coordinator]

Industrial Engineering and Management

Aida Mansouri

Electronic Engineering

Alessio Montrella

Industrial Production and Technological
Innovation Engineering

Hanumad Vasanth Munnamgi [Team

Controller]

Management, Economics and Industrial
Engineering

Laura Russo

Industrial Production and Technological
Innovation Engineering

project
3

The FUSE (Future Scenarios in Banking: new Services and Sustainability) project, developed in cooperation with UBIS (UniCredit Business Integrated Solutions), aims to understand the state of the art of technology in the banking sector to propose innovative and sustainable services

PROJECT DESCRIPTION

THE CHALLENGE

The banking sector has always been facing a big challenge: coping with continuous and fast-evolving financial services. Nowadays, financial institutions need to be not only promoters of innovation but also of sustainable services. The concept of sustainability is intended from the economic, environmental and social viewpoints. As a result, the financial service industry is ahead of the game in both innovation and sustainability.

Following these guidelines, the main objectives of the FUSE team was, first of all, to understand the current financial services panorama and, then, to design and implement an innovative solution, particularly promising in creating long-lasting value for the bank and its customers.

The first objective was reached through in-depth investigation and selection of the top sustainable banking innovations in recent years. A key challenge encountered in this step was the difficulty in finding the necessary data, practices and initiatives for each of UniCredit's competitors in the world, due to the scope of research and to competitors' secrecy which restricted any access to the details of the topics of interest.

Following conclusion of the first phase, a new challenge of the team was to summarize the results in order to be consistent with both UBIS business strategies and to cater for market requirements.

THE TEAM

This project needed to be viewed from several standpoints, including banking and financial services, technological aspects, sustainability perspectives, voices of the various stakeholders, etc. This in turn called for different skills and competences. The FUSE team was composed of members with different academic backgrounds who contributed their core skills by working in collaboration with each other, paving the way for a multidisciplinary and complex solution design.

The work was mainly divided into two phases: the first phase,



which focused on understanding the state of the art of banking practices, needed more generic competences to analyze the market, set research boundaries and summarize and present findings; the second phase, which focused on solution design and evaluation, required specialized skills, such as business expertise to study solution sustainability and technical knowledge to define the architecture and assess service feasibility.

The team composition satisfied these requirements since it was composed of engineers from Business Management and IT who adopted a top-down approach, collaborating in the strategy design and progressively detailing the solution according to their academic background.

THE RESULTS

Project deliverables met the objectives of both UBIS and the FUSE team. Two main results were achieved: firstly, a 360 degree study was carried out on the state of the art of the banking sector (from the technological, social and financial perspective), which highlighted the best banking initiatives around the world. Secondly, the FUSE team's idea led to the design and proposal of an innovative solution for UniCredit through a new service called 'UniMo.V.E' – a platform which has the potential to enable virtual money transactions implementing contemporary technology.

UniMo.V.E is a conceptual innovation that aspires to provide a new technological banking service to a large number of customers. It regards small-medium money transactions and is meant to 'fuse' the two current realities in payment methods: cash and digital money.



FUSE

Future Scenarios in Banking: new Services and sustainability

TASKS & SKILLS

Martina Dell'Anna conducted the economic sustainability study and designed the architecture of solution. She also was in charge of verifying the consistency between business and technical aspects and solutions, making them converge toward a valuable product for stakeholders.

Laura Russo defined and explored bank ranking and initiative classification and designed the main framework of solution.

Alessio Montrella explored the meaning of sustainability and its relevance in different fields and sectors. He also described and detailed UniMo.V.E services starting from customer requirement analysis and modeled the business case.

Cao Shuhua was the expert in the design of the solution, supporting the architectural study, detailing technical requirements and exploring technological alternatives. He offered support in bank benchmarking for Chinese banks.

Aida Mansouri was in charge of studying the market environment and of upgrading competitor releases during the two years. She was also the expert in the design of the solution, supporting the architectural study and detailing technical requirements. She offered support in bank benchmarking for Asian banks.

Vasanth Munnangi analyzed stakeholder requirements. He explored and detailed functionalities and the solution architecture, focusing on compliance with UniCredit standards. He offered support in bank benchmarking for American banks. Moreover, as Team Controller, he checked and reviewed team progresses and was the team interface with tutors.

ABSTRACT

Technological innovations have greatly influenced financial services. The breadth and extent of financial services, which have been continuously evolving in the recent past, owes credit to technological breakthroughs. Banking is one such sector which has always exploited these trends, both as a means of gaining internal efficiency through increased performance and as an instrument of growth and differentiation through provision of unique and high quality services to its customers. Indeed, we cannot imagine the current financial system without electronic fund transfers, auto teller machines and internet banking among many other innovative implementations. In financial services, innovation has shown a positive impact on sustainability. Service innovation and sustainability represent fundamental objectives of all organizations and underlying goals of interdisciplinary research. Technology has long been an essential behind-the-scenes partner in the financial services industry, providing the innovative incremental advances necessary for the industry to upgrade and expand its services.

The FUSE project, an endeavour carried out in collaboration with UBIS, UniCredit Business Integrated Solutions, aims to deepen the concept of sustainability and interpret new technological trends in order to arrange them in a customer oriented service that may be of a great significance to banking in years to come. In short, our project proposes the implementation of a useful software application called *UniMo.V.E* – UniCredit Money Virtual Exchange, providing a set of smartphone (and other mobile & electronic device) based payment related services that enable customers to carry out day to day transactions with great convenience and ease.

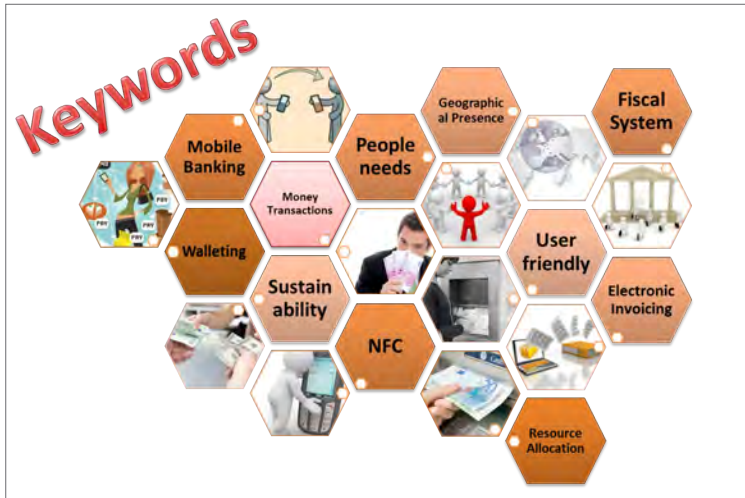

1 *Keywords of the solution*

UNDERSTANDING THE PROBLEM

A lot of pressure is exerted on the retail banking sector. Competition is increasing and margins are being squeezed and the presence of a large number of small and medium sized banks and financial institutions in Italy is further complicating this trend. Disruptive innovations, whether these focus on new technology, new business processes or completely new business models, are posing a threat to established banks. On the other hand, banks nowadays are operating in a very turbulent economic context. The situation demands that banks profitably develop new products, services and channels to market, in order to first survive against the competition and then to grow and prosper. Thus the role of Innovation as the key to success is increasing. In a virtuous circle, innovation underpins success and success generates innovation. Through attractive and compelling products and services, long term customer loyalty can be attained and thus sustained competitive positioning.

To start screening the difficult and complex pool of information and areas of investigation, an analysis was carried out on banks of similar or comparable dimensions around the world.

	SUSTAINABILITY								
	Environment		Economic			Social			
	Green Tech	Procedures	Infrastructures	Branches	Payments	Channels	HR	Financial Products	Community
Virtualization and Cloud Computing	✓		✓						
NFC and mobile payments		✓			✓				
LEED	✓		✓	✓					
Microfinance and "Green Loans"	✓							✓	
Eco-Branches	✓		✓	✓	✓	✓	✓		
Commercial Development Sustainability Tool	✓					✓			
Paperless Procedures		✓			✓		✓	✓	
Electronic Invoicing		✓			✓				
Telecommuting	✓	✓					✓		
Car Pooling	✓	✓	✓	✓			✓		
Social Programs									✓

2 *Sustainable practices classification*

Banks chosen for the analysis were with regard to customer base, geographical presence, market value etc. in geographies of – Europe, America, Asia and Italy (in particular). An in-depth study of the initiatives of these banks falling under 3 dimensions – Environment, Economic and Social – was carried out. Concurrently, an appraisal of the role of technological innovations as contributing factors in realizing sustainability was also performed.

Further to the above, interactions with various levels of management at UniCredit, and insights thus gained, gave a clear picture what the bank already has and the untapped yet high potential areas.

As technology was the key lever identified, a brainstorming on the possible areas of innovation was carried out, keeping in mind technology that is – feasible for the bank to use and/or ‘sufficiently penetrated’ among prospective users.

EXPLORING THE OPPORTUNITIES

The preliminary studies regarding the market and the classification of top bank initiatives were the starting points to design

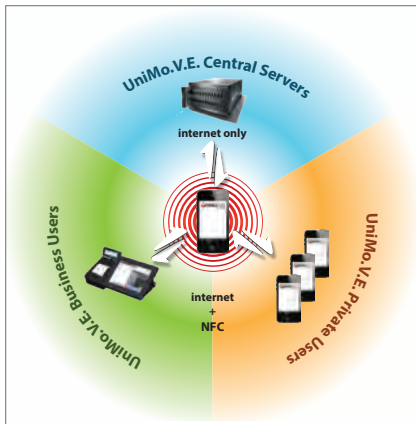

3 Solution architecture (technical specifications)



4 UniMo.V.E Business Model (economic study)



4 Visual Description of UniMo.V.E Services

a new solution for UniCredit. The project focuses on technological innovations, exploring different fields of application. Sustainability is the key word of the research, embracing social, economic and environmental issues. Therefore, innovations and resulting solutions have been selected and explored in multiple fields: the objective was to funnel all findings and the most attractive ideas into one service, which could be customer-oriented and profitable for UniCredit.

External inputs must match the company’s internal resources and long-term goals, defining and exploiting different business scenarios: UniCredit is nowadays facing the need to penetrate new markets lacking infrastructure, to reacquire customer confidence following the financial crisis and to increase and target new customers.

Besides this, banks have realized the necessity to lower costs: this goal can be reached in the short-term by careful resource and personnel management, but in the long term a complete reen-

gineering process is required, starting from exploitation of new channels and financial innovations. Mobile banking appears to be the most promising asset to meet the interests of cost-cutting and market-share increase. It can be considered a complementary but also substitute channel, pushing the so-called “cash-less branch” model.

FUSE research particularly enhanced the role of virtualization: the attempt of the team was to orient their ideas and proposals to an innovation which could lead to cash usage minimization. Many benefits can be listed: *fewer coins* means savings from various perspectives but most of all, for the bank, the chance to renew retailing practices towards efficient and cost-cutting use of internet and mobile banking.

GENERATING A SOLUTION

The idea aims to fulfill many requirements: most emphasis was placed on the team’s interest in finding an innovative solution



6 UniCredit Building photographed during visit to the branch



7 External consultant card

addressing customer requirements and UniCredit's keenness on the 'sustainability' issue. Previous project analyses had highlighted the lack of a payment infrastructure enabling final users to exchange money virtually. This is the core of the project: creating a mobile banking system that facilitates people in exchanging money with fast and simple transactions.

UniMo.V.E is an architecture which implements a payment system consisting mainly of:

1. UniMoVE Mobile App, which implements Short-distance money transfer (NFC or QR code) or Remote money transfer and Electronic Wallet and E-invoicing functionalities.
2. UniMoVE "Central" Management and administrative application to manage the service, create/edit virtual account data, perform money transactions between two virtual accounts.

The system works with a database recording virtual user accounts, which aims to substitute traditional bank accounts in order to simplify operations and on the other hand reduce legal

constraints and render the system usable, even for users with bank accounts with competitors. The ambition of UniMo.V.E is to fill the gap of current forms of payment: it emulates cash by adding credit card functionalities but without charging additional costs to users. The real innovation lies mainly in the virtualization of money, maintaining its natural availability and liquidity for trade, together with the convenience of having everything in a single device: the smartphone app in fact works as a wallet, handling money and tracking transactions and bills. Last but not least, the platform benefits UniCredit because it allows the bank to broaden data collection to better understand its customers and their needs.

Finally, the financial study showed that services are sustainable with very low (even zero) fees for final users: it aims to reach and quickly conquer the masses, accelerating the diffusion of mobile banking.

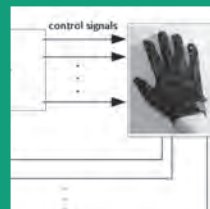
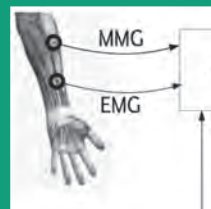
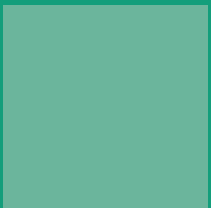
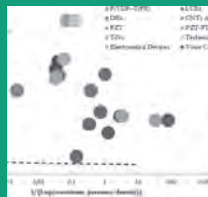

PROJECT 4

CoSpaR



COMPONENTS FOR SPACE ROBOTICS

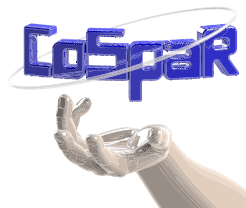

CoSpaR Components for Space Robotics

PRINCIPAL ACADEMIC TUTOR

Candido Fabrizio Pirri

Applied Science and Technology,
Politecnico di Torino

ACADEMIC TUTOR

Paolo Fino

Applied Science and Technology,
Politecnico di Torino

EXTERNAL INSTITUTION

IIT – Istituto Italiano di Tecnologia

EXTERNAL TUTORS

Silvia Appendino

IIT – Istituto Italiano di Tecnologia

Paolo Ariano

IIT – Istituto Italiano di Tecnologia

Giancarlo Canavese

IIT – Istituto Italiano di Tecnologia

Eleonora Canesi

IIT – Istituto Italiano di Tecnologia

Mariangela Lombardi

IIT – Istituto Italiano di Tecnologia

Francesco Pescarmona

IIT – Istituto Italiano di Tecnologia

TEAM A

Alain Caltieri

Computer Engineering

Matteo De Nitto

Aerospace Engineering

Daniel Grivon

Mechatronic Engineering

Cesare Pini [Team controller]

Mechanical Engineering

Riccardo Tarelli

Electronic Engineering

project
4

CoSpaR aims at proposing novel components for space robotics. IIT supports the development of innovative solutions and the proper choice of smart materials

TEAM B

Eleonora Marina Botta

Space Engineering

Pierluigi Freni [Team controller]

Materials Engineering

Ippazio Martella [Project Communication
Coordinator]

Computer Engineering

Federico Radici

Biomedical Engineering

Luca Randazzo

Mechatronics Engineering

Roberto Rossi

Mechanical Engineering

PROJECT DESCRIPTION

THE CHALLENGE

In the next decades, planetary exploration will play an important role in directing global technological development and at the same time will provide an extensive application and testing field for many innovative technologies. In support of exploration missions, new space systems must be developed requiring research on many new technologies involving robotics, automation, bio-engineering, artificial intelligence and nanotechnology skills. The extravehicular pressurized suit imposes severe limitations on the astronaut's mobility, impacting particularly on dexterity, force and endurance of the hands.

One of the main problems limiting the overall duration of a spacewalk is the astronaut's hand fatigue.

A device able to mitigate hand fatigue during EVA would be a significant improvement for astronauts, allowing them to accomplish their tasks more efficiently, more comfortably and for a longer time. The project is a preliminary approach towards a possible technological solution able to reduce the fatigue of the astronaut's hand, while avoiding hindering its natural movements. The challenge was the implementation of one or more prototypes of a lightweight hand exoskeleton to be embedded in the astronaut's glove, in order to overcome the stiffness of the pressurized suit. Both the high complexity of the human hand, in terms of degrees of freedom and working space, and the extreme environment in which the exoskeleton must work create a series of different constraints increasing the complexity of the project.

THE TEAMS

Team A studied the kinematics of the hand and its ergonomic characteristics. This work provided the design data and constraints enabling conception of a rigid body exoskeleton capable of assisting the astronaut in a grasping movement. The kinematic characteristics of this structure are particularly complex and interesting. At the same time, it achieves the goal of complying with the human kinematics and ergonomics of a circular grasp, while transmitting

the forces and torques required to compensate the stiffness of the EVA glove. A mechanical prototype, created using 3D printing, is presented. Actuation, sensing and transmission have been studied theoretically.

Team B focused on innovative and high-risk solutions designed from scratch for a soft glove. Speculations have been made on forearm signals detected by surface Electromyography and from Mechanomyography. Many types of actuators are available but, due to the constraints, only a few solutions are feasible and Electromechanical Active Polymers are the possible solution selected by the team. The design solutions proposed by the team represent an innovative response, making it possible to foresee subsequent stages of prototyping and development.



Exoskeleton for Extra Vehicular Activities

TASKS & SKILLS

Alain Caltieri (Computer Engineering): actuation system and actuation system control strategy

Matteo De Nitto (Aerospace Engineering): prototype development, FEM analysis, Aerospace Engineering expertise

Daniel Grivon (Mechatronic Engineering): prototype requirements and concept, CAD drawings and prototype assembly

Cesare Pini (Mechanical Engineering): prototype requirements and concept, Team Controller

Riccardo Tarelli (Electronic Engineering): actuation system and actuation system control strategy

ABSTRACT

The environment in which astronauts operate during extra vehicular activities (EVA) is critical and the effects it has on the ability of the astronaut to operate are negative, in that they normally experience a loss of dexterity and early fatigue phenomena, thus impairing their actions. The aim of the project was therefore to design and develop a new concept for a robotic hand exoskeleton to be used by astronauts in order to diminish the aforesaid effects of operating in such an extreme environment. The project was therefore divided in two parts, one regarding the mechanics, i.e. conceptualization of the exoskeleton, and the other regarding the exoskeleton actuation system and actuation control strategy. After having accomplished a survey of the humanoid robotics market and having carried out trade off studies between existing solutions, we focused on the design of a hardware exoskeleton hand. It was conceived in order to provide astronauts with functional support while performing EVA. Its major innovation is represented by its modular conception and assembly as well as the single finger actuation scheme. Reliability, adaptability also to further applications (elderly assistance, army, prosthesis), ease of manufacturing and control as well as compliancy with any grasped object shape are the main advantages of our mechanical model. Furthermore, its structural concept minimizes as much as possible any hand dexterity interference and ensures utmost user safety, in the event of external strains overlapping human capabilities. As far as the actuation system and actuation control are concerned, various possibilities have been taken into consideration, and the choice was based on the stringent safety, reliability and bulkiness requirements. Actuators must also be powerful enough to move the exoskeleton in the critical operative conditions in which it will be used and, on the other hand, ensure safety of the user. Actuation control has been achieved through a microcontroller and a simple and reliable algorithm based on capacitive pressure sensors.



1 Example of bulky existent solution

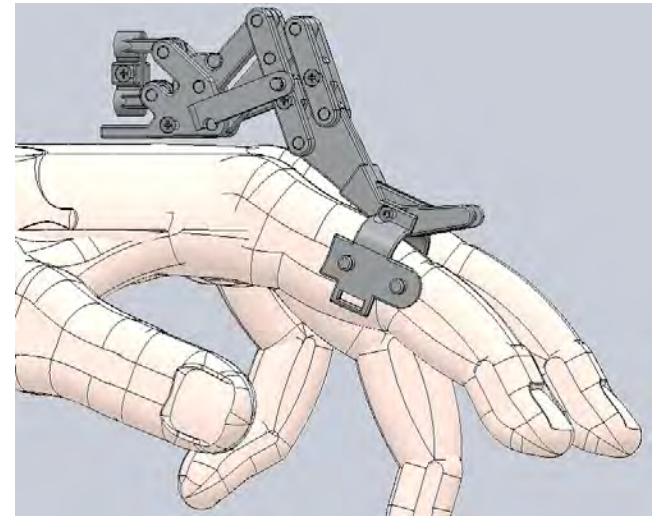

2 A particular of the mechanism used for the transposition of the MCP (MethaCarpal - Phalanx) joint

UNDERSTANDING THE PROBLEM

One of the most challenging aspects of the project was certainly the fact that the exoskeleton had to be designed to be used by astronauts in extra vehicular activities and, therefore, in deep space. The extreme environmental conditions, such as extremely low temperature, absence of atmosphere and solar radiation, safety requirements, avoiding damage to the human body and the need not to excessively impair mobility of the human hand all pose serious problems.

There were therefore several issues that had to be taken into consideration in order to proceed with the project and develop a conceptual design. Both in the mechanical part as well as in the control and automation part, different solutions were considered, for each weighing the pros and cons and then trying to find an integrated solution.

EXPLORING THE OPPORTUNITIES

The expertise of the most important Labs worldwide on engineering problems have addressed the issue of augmenting the performance and safety of astronauts during Extra Vehicular Activities (EVA). Hence, we mainly focused on the hand due to the key-role it plays in every human activity.

In order to understand market trends and come up with an innovative solution, among a thorough state of the art analysis of humanoid robotics, we evaluated two main solutions addressing the fundamental issue of improving astronaut hand dexterity:

- a “soft” structure usually implemented using soft materials such as rubber,...
- a “hard” structure that uses hard materials such as plastics, steel, alloys, etc.

We performed a trade-off analysis of these solutions, before proposing and developing our innovative concept. Although a *soft* design usually does not involve a massive structure and enhances comfort and wearability, it typically implies certain difficulties in ensuring correct kinematics and safety for the user, especially if the forces involved are particularly high. On the contrary, even if a *hard* solution requires more space to be implemented, involving problems related to bulkiness and loss of dexterity, it prevents the risk of damage to the user and at the same time provides a chassis that can be used as a support to implement a transmission system ensuring correct kinematics. Furthermore, among hard solutions, two types of robotic systems can be exploited corresponding to two different concepts:

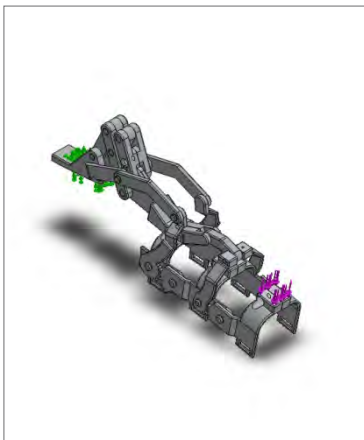

3 The index CAD model with loads (purple) and boundary conditions (green)

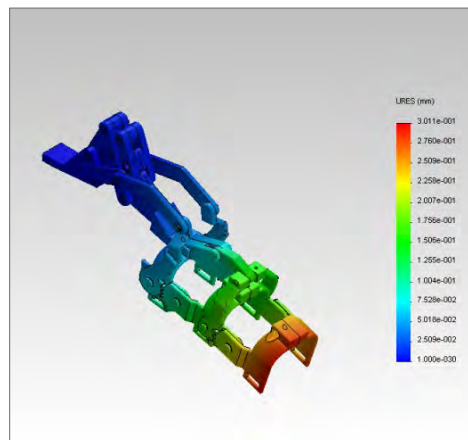

4 A colour map showing the strain distribution for a charge applied at the finger tip

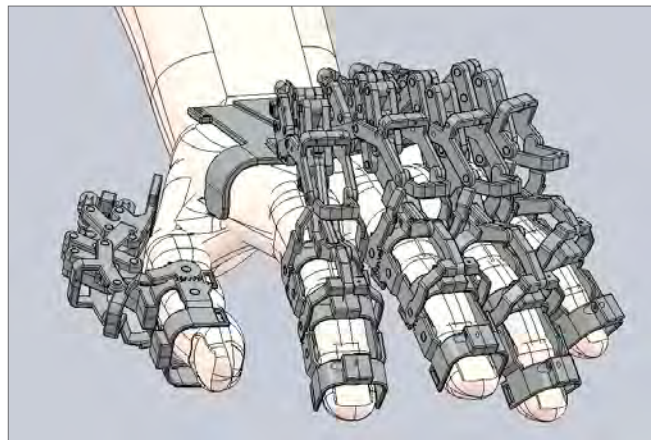

5 The overall exoskeleton structure

1. **Functional support:** A robotic system supporting and even augmenting grasping and manipulation capabilities of the astronaut in performing EVA tasks;
2. **Functional replacement:** A robotic hand replacing the astronaut's hand/arm in performing the EVA tasks which the astronaut operates remotely from a pressurized module.

As far as the actuation technology is concerned, four main solutions were taken into consideration regarding actuator technology:

3. **DC motors**, a very reliable technology, used in most robotic applications. The main drawback is that usually this kind of actuator is bulky and that brush DC motors can create sparks when actuated;
4. **Piezoelectric actuators**, innovative solution based on the piezoelectric effect to actuate a motor or linear actuator. They are extremely precise, but their stroke is too short;
5. **Electro-Active Polymers**, polymers that can change size and shape in response to electric fields. Despite the innovative character, this solution is difficult to control in a safe way due to lateral shifts occurring during actuation. Moreover, they are in an early stage of development and difficult to imple-

ment in complex projects;

6. **Carbon Nano Tubes**, a very innovative solution, based on smart materials. However, this technology is far too young: at the current stage of development it requires a complex control strategy, also due to safety problems related to the high voltages needed in actuation. However, we believe that it can be widely used in the future thanks to the similarity with human muscles.

Finally, regarding the electronic control circuit, small, light and reliable components are required, since they must be shock-resistant as well as operate in extreme and hazardous environments in difficult situations.

GENERATING A SOLUTION

The innovative CoSpaR solution consists of a hard functional supporting hand exoskeleton, with one actuator to curl a single finger. This concept allows a much more simplified control scheme compared to traditional fully actuated multi-finger hands. The joint compliance and multi-fingered configuration also ensures the beneficial property of being able to successfully grasp complex objects of unknown shape and orientation as well

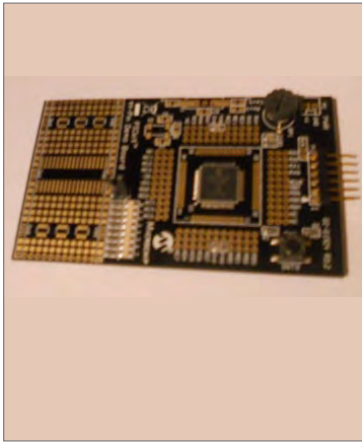

6 Prototype test PCB schematic



7 Prototype stepper motor



8 Prototype finger with sensors' positions indicated

as to be easily integrated into larger systems, such as an arm, to interact with the environment. Low cost, simple design and the potential for mass marketability all make under-actuating hands quite promising for current and future development in robotic prostheses and humanoid robotics.

The first step of the project was the design of an exoskeleton which could be adaptive as well as exploitable for further applications. This could best be accomplished by a modular design, exploiting mechanical components of the same shape for all fingers and simply changing their size from one to the other.

Once defined the type of structure to be developed, it was necessary to simplify the model kinematics in order to achieve a compromise between technical feasibility and hand dexterity. According to the study proposed in [1] we aimed to constrain finger movements, taking into account the kinematics of the hand defined for circular grasping.

Furthermore, we identified the best placement of the structure on the back of the hand, taking into account issues related to the overall dimensions and the need to avoid as much as possible loss of dexterity for the operator. Finally, having assigned the mechanical loads and boundary conditions, we carried out a Fi-

nite Element Method analysis of the designed structure in order to verify the exoskeleton structural strength.

In choosing the actuation system, brushless stepper DC motors are clearly the best compromise, in that they are reliable, create no sparks and are relatively simple to control.

Three capacitive pressure sensors, placed at strategic positions, were used:

1. Inside the glove on the inner part of the hand to receive the input for closing the hand;
2. Inside the glove on the outer part of the hand to capture inputs for opening the hand;
3. Outside the glove, in order to receive feedback on the strength applied to an object and avoid damaging it.

We developed a prototype control circuit using a PIC 16F887 microcontroller. The control algorithm is very simple and robust, based on the inputs of very few sensors. This is a positive aspect, since errors in actuator control could damage both the exoskeleton and the astronaut.

The final solution must be miniaturized in order to fit in the space suit.

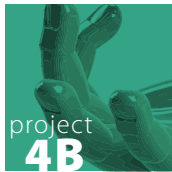

Soft solutions for hard problems

TASKS & SKILLS

Eleonora Marina Botta was responsible for user requirement definition and space-related condition analysis; she contributed to the design of the final solution. (Master degree in Space Engineering)

Pierluigi Freni focused on material selection for the actuation system, contributing to the concept design and coordinating work progress. (Master degree in Materials Engineering)

Ippazio Martella collaborated in the implementation of the different control strategies and helped define the final concept. (Master degree in Embedded Systems - Computer Engineering)

Federico Radici carried out the state of the art analysis and collaborated in concept development, focusing on feasibility studies. (Master degree in Biomedical Engineering – Cells, Tissues and Biotechnology)

Luca Randazzo (Master degree in Mechatronics Engineering) focused on the study of the exoskeleton control strategies and algorithms. Some of these algorithms have also been tested on two prototypes he built.

Roberto Rossi focused on the measuring system, acquisition strategy definition and exoskeleton mechanical design. (Master degree in Mechanical Engineering - Mechatronics and Robotics)

ABSTRACT

The aim of the project was to design a hand exoskeleton that could help astronauts in performing Extra-Vehicular Activities (EVAs). The requirement definition phase involved a comprehensive study of EVAs with the goal of identifying the typical working conditions and possible problems. In this context, a user-driven design approach was also employed by interviewing and meeting astronauts and trainers. Once the requirements had been defined, it was clear that most exoskeleton designs available in the literature were inappropriate for the problem at hand. The most suitable alternative was the use of smart materials (materials with integrated sensors and actuators). By using such materials, global encumbrance can be reduced (both in terms of volume and weight) and more degrees of freedom can be preserved (with respect to traditional rigid structures). Among the different smart materials currently available for research Electroactive Polymers (EAPs) proved to be the most suitable choice.

In order to complete the design concept, an interface between the exoskeleton and the astronaut had to be designed. Since use of the exoskeleton should feel as natural as possible, a combination of Surface Electromyography (sEMG) and Mechanomyogram (MMG) was used for detecting the intention of the user.

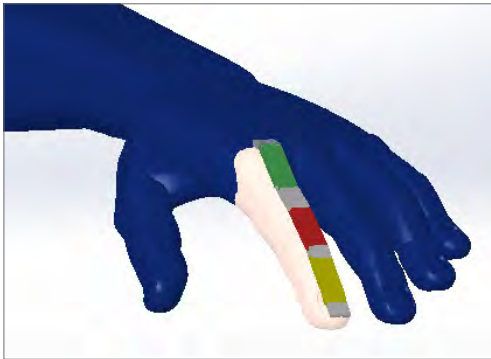

1 Final glove-exoskelton concept (index finger is shown in detail)

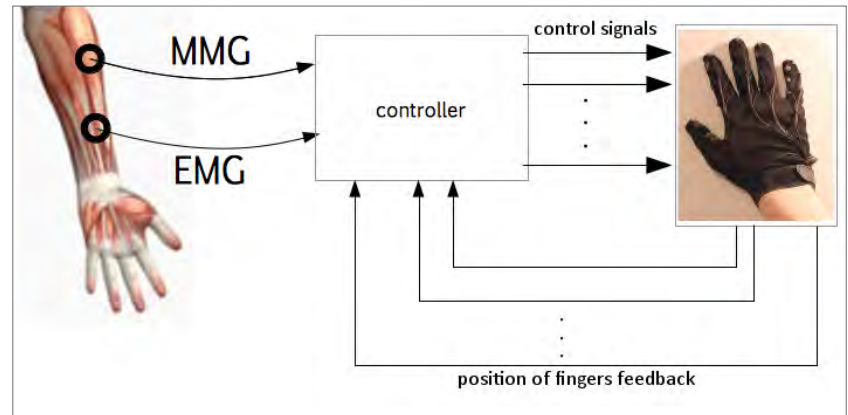

2 Control system architecture

UNDERSTANDING THE PROBLEM

Extra-Vehicular Activities are fundamental for human exploration of space. Environmental conditions and pressurized spacesuits expose astronauts to fatigue problems during lengthy EVAs, especially to their arms and hands. The aim of the project was to design a hand exoskeleton that could enhance crewmembers' performance during these operations.

The team exploited a user-driven design approach, to understand the problems to be solved and the goals to be reached. The user-driven design process was challenging since it was not simple to meet users, the astronauts. Thanks to Politecnico of Milano, the group met Paolo Nespoli and, with the support from Loredana Bessone (an ESA astronaut instructor), was able to visit the European Astronaut Center in Cologne. Bibliographic research of NASA and ESA standards filled the information gaps. The main outcome of this first phase was the identification of a set of functional, safety and environmental requirements to be met by the helping device.

The analysis of typical Extra-Vehicular Activities tasks, problems and conditions made it evident that traditional exoskeletons were not convenient and the problem required the generation of a breakthrough solution addressing the EVA fatigue problem. Even though astronauts move slowly in space, the device should not decrease their dexterity or hinder any move-

ments, which is best provided by elastic materials. Temperature, radiation and humidity conditions inside the spacesuit during EVAs were estimated in order to obtain the environmental requirements the selected material should comply with. Finally, the leading requirement was to support movements according to the user's intention, without prevailing on it: a seamless interface was therefore found to be unavoidable.

EXPLORING THE OPPORTUNITIES

As a starting point, the state of the art in the field of hand exoskeletons was explored.

Several studies and researches were carried out and, although the literature is quite rich in exoskeleton prototypes, most of them are totally unsuitable for space application.

As far as actuation is concerned, one interesting solution found in the literature is provided by piezoelectric motors, due to their reduced size (i.e. millimeters) and high controllability and tunability. Other types of actuation usually imply much larger sizes and require alternative solutions.

Among the possible sensing systems, a number of promising possibilities include strain gauge based electrogoniometers, piezoresistive sensors and Electromyography (EMG) sensors.

The latter represent one of the most promising solutions with regard to interpretation of the user's intention. They are already

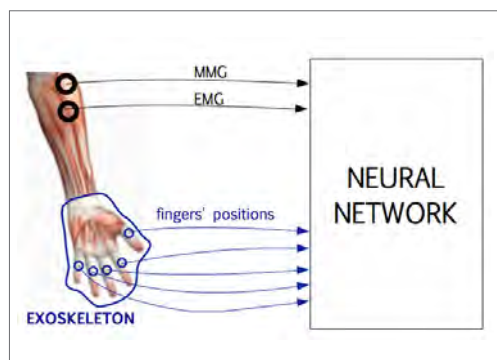

3 Control algorithm training phase

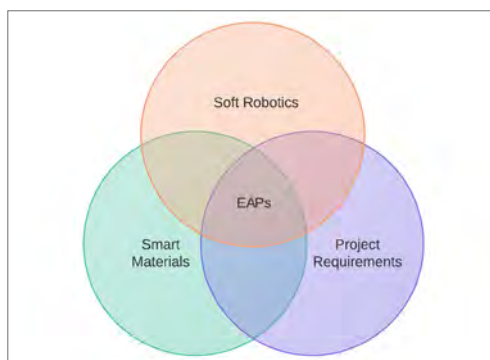

4 Selection process

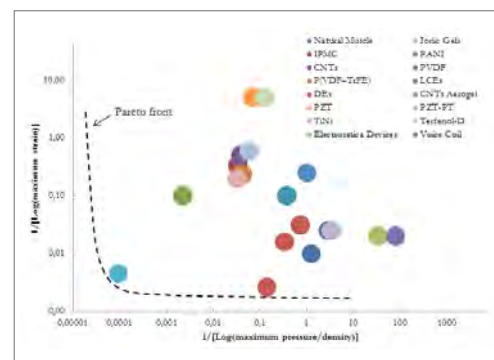

5 Materials bubble chart with Pareto front

widely studied and used in biomedical applications and are based on acquisition of the muscular activity by analyzing the controlling neural electrical signals.

A set of experiments was carried out to assess capabilities and limitations of the use of EMG signals as control signals. The goal of these experiments was to develop a basic EMG-based control algorithm that could serve as a proof of concept for our ideas.

Our experiments required few tools: a set of EMG electrodes, the “EMG acquisition equipment” and a normal PC. Since we wanted to test our work in real-time a robotic hand mockup was also built.

Once the EMG signals had been correctly acquired by the sensing equipment, a basic movement recognition algorithm was designed. After a few design iterations, the hand clenching movement (full or partial) was recognized by using an appropriate weighted average of the different input signals.

The final development step consisted of controlling the robotic hand mock-up using the output from the recognition algorithm.

GENERATING A SOLUTION

According to the project requirements, soft robotics proved to be the best solution for this application. As the name suggests, systems built with this approach are soft, flexible and compliant. Furthermore, it is possible to reduce the total weight of the exoskeleton and eliminate rigid element constraints. One of the

key points of soft robotics is biomimicry: in place of heavy, rigid and noisy motors, artificial muscles are in charge of making the soft structure move, allowing a number of degrees of freedom unthinkable with traditional mechanics.

Mechanical design:

The shift from hard to soft robotics brings the focus on materials: actuators and sensors are embedded in the material itself, which becomes smart.

Smart materials represent a broad class of materials, belonging to different families (polymers, metal alloys and ceramics) and characterized by a large number of control mechanisms.

In the framework of soft robotics, and taking into account the requirements of the project, polymeric smart materials are the most suitable choice for the application in question. In particular, attention was focused on Electroactive Polymers (EAPs): these polymeric materials work as transducers, converting electrical inputs into mechanical outputs, and vice versa. They exhibit features that cannot be found in other traditional functional materials (e.g. piezoelectric ceramics) such as large active strains, high energy density, mechanical compliance and flexibility, low weight, simple and scalable structures and tailorable properties. All these characteristics make EAPs the actuation system closest to natural muscles.

Control strategy:

Exoskeleton control and monitoring need a complete and com-

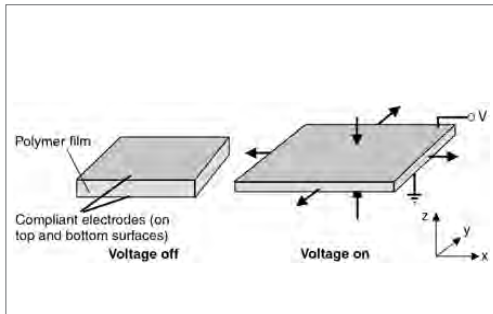

6 The dielectric elastomers actuate by means of electrostatic forces applied via compliant electrodes on the elastomer film (Bar-Cohen,2004)



7 First hand mock-up made with Lego

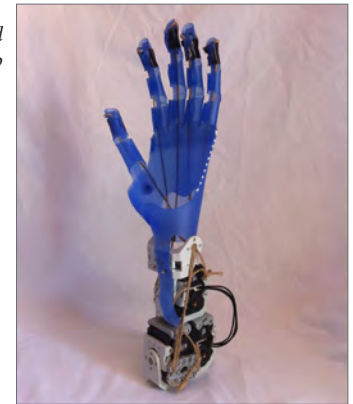

8 Second hand mock-up

plex measuring system, addressed to detect the intention of the astronaut and effective functioning of the hand.

Hand movements are monitored by means of pressure and position sensors. The latter are obtained with the same material used for actuation (EAPs), complying with the soft exoskeleton paradigm and allowing use of the same energy supply and controlling technology for both aspects.

Instead, detection of the astronaut's intention is delegated to a complementary strategy combining Surface Electromyography (sEMG) and Mechanomyography (MMG) on the forearm. They measure two different forms, electrical and mechanical, of the same physical activity due to the activation of muscle motor units.

Mainstream EMG technology is innovatively aided by its mechanical equivalent to provide more stable information on muscle fatigue and to provide redundancy to the system.

A prototype of a microphone has been built to test the innovative MMG solution and results are encouraging.

Pressure sensors are fundamental for closing the control loop that uses EMG/MMG signals as input reference. Position sensors assure redundant safety to the astronauts, controlling that movement limit ranges are not exceeded.

The control strategy is based both on the use of EMG and MMG signals and on the feedback signals coming from the EAPs on the user's hand.

The controller is in charge of accomplishing various tasks:

- Reading and processing the EMG and MMG on the user's forearm: acquisition of physiological signals from the electrodes and their electrical processing (amplification and noise filtering).
- Decoding of acquired signals: control signals are decoded, by means of neural networks, so that they can be translated into input signals for the exoskeleton and fed to it.
- Exoskeleton feedback signal acquisition: feedback signals coming from the exoskeleton are continuously read, both to make sure that the desired force is achieved on each finger, as well as for safety.

MAIN BIBLIOGRAPHIC REFERENCES

- [1] NASA-STD-3001 Space Flight Human-System Standard Volumes 1 (Crew Health), Section 14 (Extravehicular Activity). Retrieved at <http://msis.jsc.nasa.gov/sections/section14.htm>
- [2] Y. Bar-Cohen, Electroactive polymer (EAP) actuators as artificial muscles: reality, potential and challenges, Bellingham, Washington, USA: SPIE - The International Society for Optical Engineering, 2004.

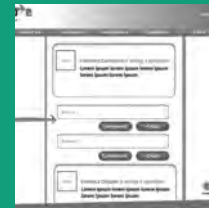
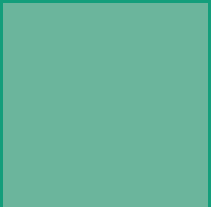

PROJECT 5

NEST



NEW SERVICES FOR TEACHING AND LEARNING



NEST NEw Services for Teaching and learning

PRINCIPAL ACADEMIC TUTOR

Susanna Sancassani

METID,
Politecnico di Milano

ACADEMIC TUTORS

Alberto Colorni

Industrial Design, Arts, Communication
and Fashion, Politecnico di Milano

Tommaso Agasisti

Management, Economics and Industrial
Engineering, Politecnico di Milano

Alessandro Campi

Electronics, Information and Bioengineering,
Politecnico di Milano

Angelo Tartaglia

Applied Science and Technology,
Politecnico di Torino

Daniela Casiraghi

METID,
Politecnico di Milano

Nicoletta Trentinaglia

METID,
Politecnico di Milano

Valeria Baudo

METID,
Politecnico di Milano

EXTERNAL INSTITUTION

Accenture

EXTERNAL TUTORS

Giuseppe Gorla

Accenture

Cristiano Agostini

Accenture

project
5

*The project is aimed to design
innovative didactical services for
teaching and learning processes*

TEAM A

Federica Ciccullo [Project Communication
Coordinator]
Management Engineering

Giantommaso D'Astolto [Team
Controller]
Management Engineering

Marija Petkovic

Product-Service-Systems Design

PROJECT DESCRIPTION

THE CHALLENGE

Nowadays the learning scenario can be defined as “fragmented”, due to the many different specific services or courses related to the specific needs of different learner targets, but also as “global”, in terms of the broad potential audience it can reach. Searching on the web, it is easy to find every kind of opportunity, “localized” on the web or in different countries, for improving skills and competences: online courses, real job challenges open to everyone (e.g. the online initiatives of open innovation in engineering or design fields such as *Innocentive* or *Openideo*, or the entire world of crowdsourcing), opportunities for developing international experience in volunteer programs, etc.

Furthermore, 2012 has been recognized as the “MOOCs year”, the rise of high quality massive open online courses provided for free by the best US Universities (e.g. Harvard, MIT, Stanford, Princeton). The opportunity for everyone to integrate competences and skills offered by a traditional degree by following self-designed paths that can combine face to face intensive courses selected from all over the world, top level online courses or job challenges is becoming increasingly concrete (also in coming years very accessible fairs are planned).

Moreover, as career services can observe day by day, evaluation of the competences of each person is no longer limited to official certifications but is connected with each person’s specific experiences rather than traditional courses attended.

Therefore, the project was centered on the design of value-added services which help individuals to orient themselves in an open view of the concept of “learning opportunities” to meet their specific goals. The learning scenario shows that there are a number of ideas developed in this manner which, however, have two main limitations: lack of a “wide vision” of learning opportunities and “crowd-answers”, namely the possibility of providing and receiving inputs from a larger community of interest which provides useful information in such a complex context.





NEST NEw Services for Teaching and learning

TASKS & SKILLS

Federica Ciccullo. She was involved in the user requirement analysis conducting interviews in Italy. As a team communication coordinator she organized the work of group members acting as interface with the external tutor. She prepared and conducted the final Focus Group.

Giantommaso D'Astolto. He dealt with the state of the art analysis through comparative research, contributed with interviews, implemented the internal business model analysis and, as Team Controller, ensured consistency of contents for progress reports and the final poster.

Marija Petkovic. She was involved in the user requirement analysis conducting interviews in Serbia. She provided creative insights for concept generation, implemented the mock-up and final detailed design of graphic pages. She prepared and conducted the final Focus Group.

ABSTRACT

In the context of the most relevant definition for “lifelong learning” (LLL) we read:

(...) all learning activity undertaken throughout life, with the aim of improving knowledge, skills and competences within a personal, civic, social and/or employment-related perspective (...)

(European Commission. 2001).

We drew from this definition the emerging trend for a “new generation of learners”: looking for all-round knowledge-based experience throughout the life time. The objective we engaged in in developing our project consists of helping individuals to reach their ultimate goal for the future, guiding them through “the magma” of fragmented learning and, in the broadest sense, experience offers. Life Long Learning, Web 2.0 technologies and the related paradigms of sharing and individual development within a community represent the roots of the service we, as the NESt team, proposed. The path leading to the final version of the project followed different stages, which all revealed to be useful in both shaping our understanding of the current fast-changing learning panorama and in guiding us to move from our original orientation (focused only on the world on learning) to broaden our view and to include in the key points of the service particular attention on the experience dimension. In the last two years we have seen constant changes in learning offerings and we shaped our ideas accordingly, incorporating features from various new services currently establishing themselves in the e-learning environment. We structured the project development in various phases, starting from building a theoretical basis (user requirements and state of the art analysis in both Italian and foreign contexts), subsequently addressing the concept development phase with creative techniques, the system design phase and the detailed design phase (graphic pages). To conclude, we conducted a focus group for stakeholder analysis to obtain final insights and to be aware of both strengths and weaknesses of our service. That is how “WannaB-e Long Life experience” was born.

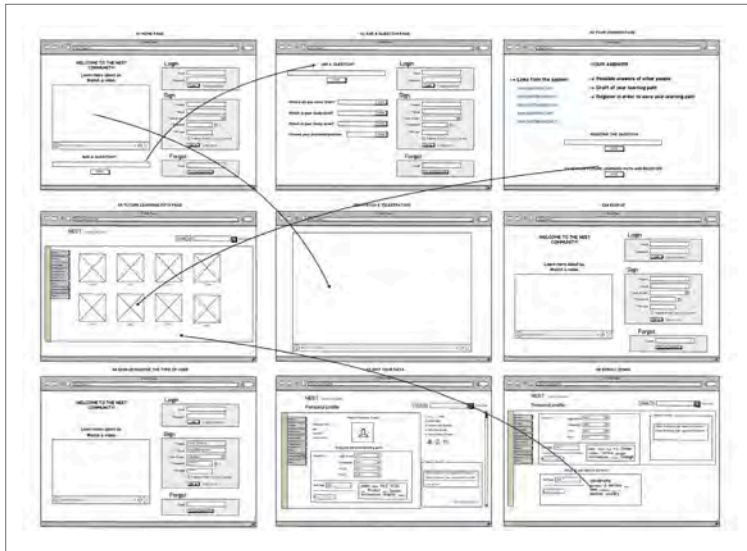

1 First graphic mock up of the main pages(work in progress)

2,3,4 Examples of the first draft version of graphic pages

Homepage

Profile Page

"Main street" page

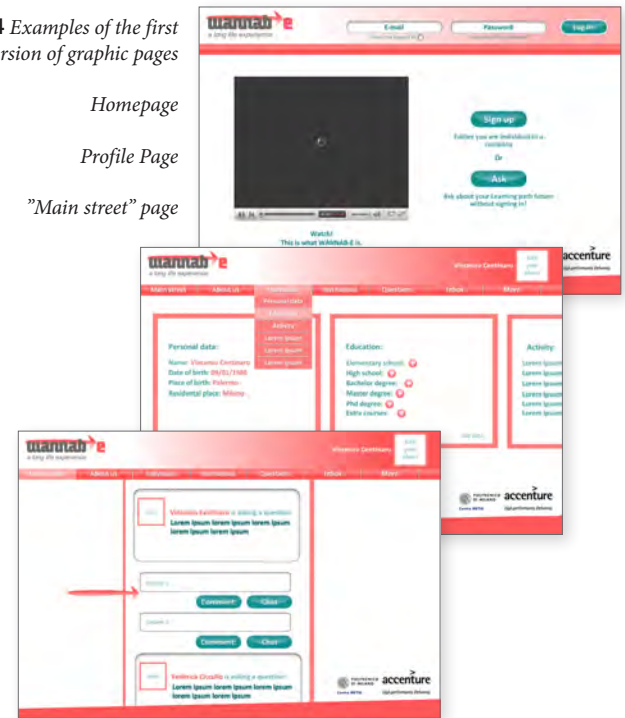

EXPLORING THE OPPORTUNITIES

The following step in our agenda was to generate potential ideas for a new service in the field. Thanks to the help of our academic and professional tutors, we had been introduced to creative techniques, such as “*Random Inputs*” and “*Crossing*”, which we eventually used in our brainstorming sessions.

These meetings led to 5 final proposals, which included the most valuable elements we found in the initial state-of-the-art analysis. These propositions were then broadened by including brand new functionalities, with the purpose of enhancing the user experience and making the offer as appealing as possible.

The ideas were various and included: a game-based social network which could be used as a platform for students and teachers to jointly design the learning experience and strengthen the relationships among the members of the community; a tutoring service which allowed the usage of teaching tools (graph

and formula editors, calculators, simulation tools, screen sharing and so on), videoconferences and chats; an on-line store for learning games which allowed the users to pick only the contents they needed and to customise their experience; a wiki platform, based on the concepts of community and voluntary participation (since all the contents provided are to be revised and evaluated by members), whose aim is to provide all the necessary information regarding a selected range of topics; a new teaching tool which enabled distance-learning through the use of interactive blackboards and video-calling.

At the end of this process, we found four working dimensions to work on: **learning path consultancy**, **content and resource sharing**, **on-line tutoring** and **real experiences** (both on-line and in person). By merging these aspects, we came up with a final offer that included most of the features we had gleaned from the initial stages of the project.



5 Logo

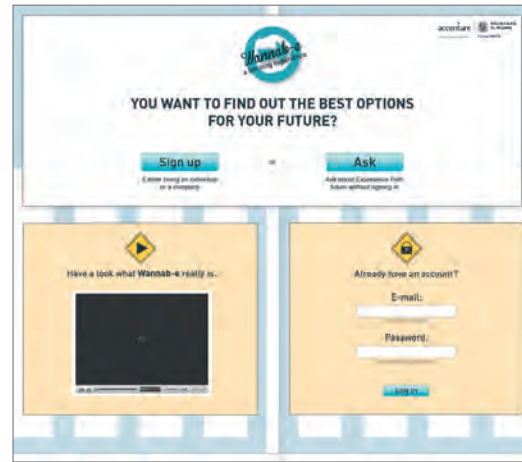

6 Homepage



7 Trail Question Page

GENERATING THE FINAL SOLUTIONS

The key aspect of the final service we intend to develop is the two-fold nature of the users we would like to address. As a matter of fact, we decided to broaden our offer in order to include professionals together with students and institutions, as well as broaden the goal of the service we aimed to create: not only focusing on the learning dimension but looking at life-long experiences.

The final solution is therefore to be intended as a guidance for users throughout what we called the entire “experience path”. The concept behind the proposal is that of providing a decision-making tool for those who would like to undertake a new experience, rather than delivering new content on the Internet. The “WannaB-e Life Long Experience” service consists of a platform in which the members of the community can upload information regarding their past experiences, help others in choosing the best direction to achieve personal goals and promote themselves as experts in a certain field.

In particular, young professionals can glean information to improve their CVs, enlarge their acquaintances or explore their personal passions; institutions can use the platform for promoting their offer and advertising their events; students and their families will need it for guidance in scholastic careers (not only for choosing a future university but also to improve their skills in certain topics or to obtain information on certifications and tests), teachers can use it to strengthen their professional background, tutoring their pupils or promoting themselves as professionals for private institutions.

Currently, the team has already created the service mock-up and the graphic drafts for the webpages, in order for the tutors to get a feeling of how the platform operates and what functionalities are useful to help customers achieve their goal. Meanwhile, a business model has been developed and a value offer has been proposed. From the studies on different existing business models on similar services, we opted for a “freemium” model, which



8 Building my Profile Page



9 My Profile Page



10 Answers Page

enables our broad range of potential customers to choose the profile that suits them best. The communication channels we will be using vary from social networks to professional magazines and key partnerships. Since we aim at delivering high quality, it is our main interest to keep our customers satisfied at all times, therefore customer retention will be one of the core activities in the implementation phase and human resources and IT infrastructure will be considered as the core elements than can create a sustainable competitive advantage.

The main features of the service have then been highlighted, with particular focus on the query system for interviewing the database containing the members' info.

The last steps of the project included a focus group in which we collected the feedback of the different categories involved in the project, particularly young professionals and students.

The outcome of this activity resulted in a set of questions on the critical points of the service, ranging from the marketing lever-

ages and promotion of the offer to technical issues concerning the different roles and profiles in the database or the speed of the system in answering the questions posed by the users.

The main strengths that emerged from the discussion were mostly linked to the flexibility of the system, to its interactivity and the opportunity of pursuing a long-term objective, such as the learning path. The offer is in general perceived as younger(?) and broader than comparable services already on the market.

Potential improvements can include organisation of the profile structure, a more "user-friendly" answer page and strengthening of the feedback system, so that the more active and reliable users can gain points and be recognised as experts in a specific field.

MAIN BIBLIOGRAPHIC REFERENCES

- [1] European Commission (2001), *Making a European Area of Lifelong Learning a Reality*, COM Brussels, Commission of European Communities, p. 9

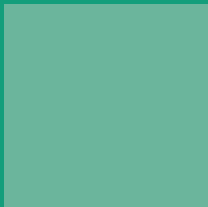
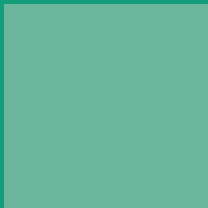
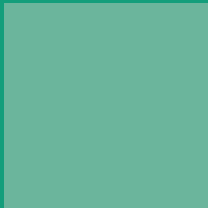

PROJECT 6

SustHealth



SUSTAINABLE HIGH QUALITY HEALTHCARE



SustHealth

Sustainable High Quality Healthcare

PRINCIPAL ACADEMIC TUTOR

Stefano Capolongo

Architecture, Built Environment, Construction Engineering, Politecnico di Milano

ACADEMIC TUTOR

Marta Bottero

Interuniversity Department of Regional and Urban Studies and Planning, Politecnico di Torino

Emilio Pizzi

Architecture, Built Environment, Construction Engineering, Politecnico di Milano

Carlo Signorelli

Architecture, Built Environment, Construction Engineering, Politecnico di Milano
Dipartimento di Sanità Pubblica, Università di Parma

Cesare Stevan

Architecture and Planning, Politecnico di Milano

EXTERNAL INSTITUTION

Techint Engineering & Construction

A.O. Ospedale Civile di Legnano

A.O. Sant'Anna di Como

EXTERNAL TUTORS

Laura Chiappa

A.O. Sant'Anna di Como

Luigi Colombo

Techint Engineering & Construction

Carla Dotti

A.O. Ospedale Civile di Legnano

TEAM A

Andrea Bellagarda [Team controller]

Industrial Production and Technological Innovation Engineering

Arlind Dervishaj

Architecture (Construction)

Michela di Noia

Architecture

Marco Gola

Architecture for Sustainability

project 6

The project in collaboration with TECHINT, AO Legnano and AO Como is to develop new strategies that can make the Hospital more Energy Efficient and Sustainable

Salvatore Speranza

Energy Engineering

Lia Volpatti

Biomedical Engineering

TEAM B

Matteo Birocchi

Building Engineering

Elisa Cavagliato

Architecture (Construction)

Giulia Gherardi [Team controller]

Management, Economics and Industrial Engineering

Francesco Mantua

Energy and nuclear Engineering

Slobodan Miljatovic

Environmental and Land Planning Engineering

Maria Hristova Nickolova [Project

Communication Coordinator]

Architecture

Marco Rostagno

Architecture for Sustainability

PROJECT DESCRIPTION

THE CHALLENGE

One of the most significant problems of today's society is the unsustainable way of living. To guarantee a better future, people should change their habits and behavior in many fields, not neglecting the most difficult and complex issues.

Healthcare structures are by definition very complex realities, since they include numerous services, various kinds of facilities and combine people with very different needs and skills, in order to satisfy one of the basic rights of human beings: Health. Nevertheless, hospitals are buildings which can significantly affect environment and society: they have an energy consumption three times higher than that of a residential building of the same size, produce polluting emissions into the atmosphere, dangerous solid and liquid waste and have very high water consumption.

Public Health is recognized as a resource that must be preserved and improved. Therefore, the negative effects of healthcare structures on people's health should be reduced, since these are the places designated to protect and enhance it with the highest possible standards. Promoting health requires a sustainable and high quality system of healthcare structures (both existing and newly designed), able to meet future social demand and put emphasis on proper and sound architecture, technology and management solutions. To guarantee future generations the right to Health, with the high quality standards provided by scientific research, it is essential to develop effective and innovative strategies that can make the Hospital sustainable from a social, environmental and economic point of view.

TEAM A_MAKING OPERATIVE HOSPITALS SUSTAINABLE

Starting from the assumption that building a new hospital is an expensive and difficult task, and that western countries are characterized by hospitals which are often several dozens of years old, Team A developed a set of criteria and derived solutions to improve the sustainability of operative hospitals. Analyzing examples of average conditions (Niguarda and San Paolo



Hospitals, Milan) and best practices (Meyer Hospital, Florence; Hospital del Mar, Barcelona), an innovative evaluation system was implemented to provide existing structures with a simple and effective decisional tool, allowing them to increase their sustainability, while functioning at low cost.

TEAM B_DESIGNING SUSTAINABLE HOSPITALS

Team B was concerned with the most recent and innovative hospitals in Italy and Europe (Istituto Clinico Humanitas, Milan; New Hospital of Legnano; New Karolinska Hospital, Stockholm; Hospital de Sant Joan Despí Moisès Broggi, Barcelona) when examining the status quo. This experience enabled team members to focus more in detail on a rating system which may be implemented for new design projects that are to be implemented or are in progress. After completion of the evaluation tool, it should be tested on a new design project in order to measure the real level of sustainability, which should be as high as possible being a future hospital.

THE RESULTS

The study of the current conditions of healthcare structures, always using scientific methods, combined with a multidisciplinary approach and creativity, led the project teams to the development of two easy-to-use, innovative, versatile and almost universal tools, to enable hospital builders and managers to promote sustainability and therefore Health protection. Both the proposed evaluation systems were tested in two real hospitals, demonstrating their effectiveness and usefulness, even beyond expectations, raising strong consensus to the sustainable solutions presented among all the stakeholders involved.



Making Operative Hospitals Sustainable

TASKS & SKILLS

Andrea Bellagarda elected Team Controller at the beginning of the project, managed finances and visits and worked on economic sustainability studies, focusing on managerial solutions.

Arlind Dervishaj participated in the project developing architectural solutions, mainly concerning social sustainability, dealing in particular with comfort.

Michela di Noia guaranteed communication between tutors and students, as well as with project case study representatives; she dealt with humanization issues and social sustainability.

Marco Gola analyzed architectural and urban planning issues linked to both social and environmental sustainability and worked with Michela on the graphics of the various deliverables.

Salvatore Speranza focused on environmental sustainability, studying resource consumption and energy production but also enhanced group coordination, managing team organization and meetings.

Lia Volpatti handled the biomedical and clinical issues of the project, always maintaining an overall perspective to guarantee content consistency and completeness.

ABSTRACT

One of the main indicators able to describe the wellness status of a country is its national healthcare system. Scientific and technological progress has taken place in recent years allowing the discovery of effective treatments to cure diseases that before would have been terminal, increasing average life expectancy and giving the possibility to chronically ill people to have a high quality of life. In this scenario, healthcare systems have experienced deep changes, developing dynamic features to adequately respond to the new needs of people who suffer from chronic more frequently than from acute diseases. The challenge is even more arduous for existing healthcare structures, which due to their own nature, being often old fashioned, are not characterized by the flexibility required to face ceaseless innovation and continuous social changes. Therefore each operative healthcare structure, delivering its service, should be globally sustainable: socially, since it offers a service to people whose recovery does not depend on drugs or surgery alone, but also on human and psychological factors; *economically*, since it should couple limited financial resources with the duty to continuously satisfy the community's needs; *environmentally*, as a structure designated to protect health should not have a negative impact on the local environment.

Given these premises, the goal of SustHealth project was to define a multidisciplinary set of criteria for a quantitative evaluation concerning the sustainability of a hospital. In particular, Team A developed a set of criteria referring to existing operative hospitals, aiming to highlight their strengths and weaknesses and to provide them with a simple decision tool which helps to sort and prioritize future choices. The originally developed multidisciplinary tool was tested by applying it to a public acute care structure: **San Paolo Hospital in Milan**. The case study evaluation was associated with specific suggestions which, if implemented, could increase the hospital's sustainability, allowing it to improve its performance at low cost.



1 Hierarchical organization



2 Diagram

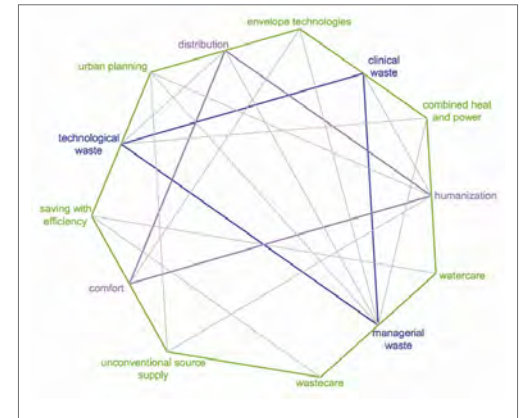

3 Directions

UNDERSTANDING THE PROBLEM

Existing and operative healthcare structures, to become truly sustainable, since they offer an essential service to society, should look at a correct definition of *sustainability*, not dependent on current common standards which see it as strictly related to environmental issues. These kinds of structure are often old but nevertheless they must continue to operate and are not replaced by new ones mainly due to their economic convenience in the short term, which is (often, but sometimes erroneously) imperative in periods of economic crisis such as that we are currently experiencing. It is therefore inconceivable to guarantee global sustainability to an existing hospital just by providing it with expensive plant for energy production from renewable resources. [1] The aim of the SustHealth project was therefore to define which indicators, belonging to the different facets of sustainability, to consider and to understand how to connect them in order to correctly evaluate the sustainability of an existing structure and be able to propose effective solutions for its improvement. The definition of a complex stakeholder network and the analysis of a controversial issue, such as that of the Italian national healthcare system, highlighted the following main user requirements:

- an increased level of *humanization* inside the hospital: effective

tive treatment cannot disregard comfortable spaces and a positive work environment;

- higher attention to available *resources*: the hospital is a high energy consuming structure and requires, also from the economic point of view, huge amounts of resources which are finite and limited in time;
- widespread *multidisciplinary*: sustainability is a holistic concept, consisting of several tightly intertwined elements; achievement of an objective therefore cannot be reached without understanding each single issue, but rather the entire complex matter needs to be analyzed.

User requirements, user suggestions and analysis, through interviews and visits, of the existing scenario, with its limitations, constituted the main building blocks to guide the activities carried out within the SustHealth project.

EXPLORING THE OPPORTUNITIES

As any complex system, the hospital is characterized by particular features, specific to the context in which it operates. Moreover, healthcare structures can significantly differ in terms of ownership, services offered, user base served and available resources. From this starting point, the definition and implemen-



4 Tables

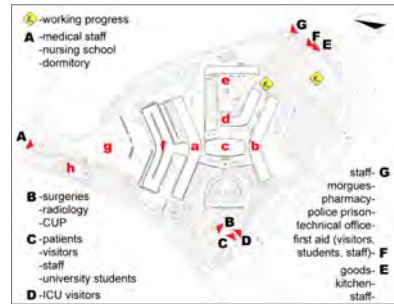

5 Project



6 Project

7 Project



tation of a detailed blueprint for sustainable hospitals seems to be very difficult, but a set of outcomes, toward which existing healthcare structures should be addressed in order to be sustainable, can be defined. Thus we tried to overcome, detail and specify the Piano – Veronesi Hospital Concept [2], which aims to be a blueprint for sustainability but remains a general meta-project. We accomplished this by identifying a set of concrete features that a sustainable hospital should have, also thanks to visiting and studying hospitals around Europe which have set sustainability best practices subsequent to their renovation, such as **Hospital Del Mar in Barcelona** and **Meyer Hospital in Florence**, but also typical old structures such as **Niguarda Hospital in Milan**. To be able to define proper solutions in such a dynamic and diverse context, it is necessary to start from the evaluation of the specific existing hospital and to explore its strengths and weaknesses. Therefore we analyzed the evaluation systems mainly used to assess sustainability of the built environment, such as BREEAM, LEED and ITACA. Though these systems are detailed and complete from the architectural and energetic point of view, they are cumbersome and complex, requiring huge efforts by professionals to be applied. Furthermore they do not always present a specific version for healthcare structures,

which differ significantly from housing or industrial scenarios, and even when such a category is provided, neither managerial, economic and clinical aspects nor user involvement is taken into consideration. So we eventually came up with the proposal of a new and easy-to-use evaluation system which is more practical and streamlined than existing models and specifically addresses sustainability for existing healthcare structures, approaching the issue in a multidisciplinary manner, without attempting to simplify its complexity, but rather considering the necessary trade-off among the three pillars of sustainability: *social, economic and environmental*.

GENERATING A SOLUTION

Improving the sustainability of an existing hospital is a challenging task, since implementing structural changes in an operating structure is expensive and not always possible. Therefore we developed a tool to allow prioritization of the most effective changes, facilitating simple and low cost solutions. It consists of a multidisciplinary set of criteria which embraces the three main areas of *sustainability: social, economic and environmental*, in an effort to identify critical issues and possible solutions, always having in mind the necessary balance among these crucial as-



8 Project

pects. This original evaluation system, which at a first stage aims to evaluate sustainability of operative healthcare structures, goes beyond the existing models, adding conceptual value and complexity. Compared to commonly used evaluation systems, ours is innovative since it includes various factors, rather than focusing on a limited area of expertise, with a very multidisciplinary approach. Given the high complexity of the problem and therefore of the solution, we tried to limit this by providing an easy-to-use tool, consisting of the combination of several (but not too many) simple, hierarchically organized elements. The 13 *criteria*, identified as being decisive in the particular case, are divided among the three above-mentioned *macro-areas* and each one is specified through different *indicators*. Hierarchy limitations are overcome through implementation of an appropriate weighting system, based on an Analytic Network Process [3], which takes into account interrelationships among the various components. Elements from different areas, at different levels, interact only indirectly in the system conceived, which could be refined developing a suitable mathematical model to reproduce mutual interactions.

From the hospital evaluation, obtained by applying the SustHealth assessment system, solutions to increase sustain-



9 Project

ability of the structure emerge already prioritized, considering the results achieved for each macro-area. So, as the final stage of application of our tool, effective and low cost solutions are developed, according to the content of each indicator, proposing a specific plan for sustainability improvement. The shift toward sustainability will not necessarily include structural renovation but will favor managerial and organizational changes or minor refurbishment and modernization works, thanks to the nature of the evaluation tool itself. The SustHealth system has been experimented by application to the **San Paolo Hospital in Milan** in order to test its ease of use and data availability and to understand whether exact or proxy measurements were needed.

MAIN BIBLIOGRAPHICAL REFERENCES

- [1] Capolongo, S., 2006. *Edilizia Ospedaliera*. Milano: Hoepli.
- [2] Mauri, M., 2003. Progetto di ricerca finalizzata (ex art. 12, Dlgs 502/92) Principi guida tecnici, organizzativi e gestionali per la realizzazione e gestione di ospedali ad alta tecnologia e assistenza. *Supplementi di Monitor*, 6.
- [3] Saaty, T. L., 2005. *Theory and Applications of the Analytic Network Process*. Pittsburgh: RWS Publications.

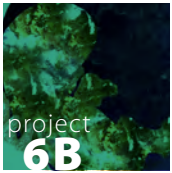

Designing Sustainable Hospitals

TASKS & SKILLS

Matteo Birocchi worked on the environmental sustainability part of the rating system and subsequent evaluation, focusing more on the building engineering aspects related to hospital envelope technologies and performance.

Elisa Cavagliato focused her attention on both the architectural features of the building with an impact on environmental sustainability and on interior factors which are responsible for the social sphere of sustainability.

Giulia Gherardi contributed to the evaluation system by creating and implementing the criteria to measure economic sustainability. Given her economics background, she was also responsible for the SustHealth budget.

Francesco Mantua explored and applied the energy components related to the environmental impact of a new designed healthcare facility.

Slobodan Miljatovic examined factors and solutions involving water and waste management, influencing the ecological footprint of a hospital.

Maria Hristova Nickolova was responsible for developing and implementing the social sustainability criteria for assessing the humanization of a future health structure.

Marco Rostagno developed and applied urban design and use of specific materials having an effect on the environmental performance of a new project.

ABSTRACT

Currently many challenges to move people's behavior towards a more sustainable life style are being faced. In fact, the impact of the human footprint on earth is increasing and a more sustainable attitude is necessary to preserve our world. At this stage, it is important to underline that sustainability is nowadays a common word that has lost its original meaning. Notwithstanding this, people generally think that it represents a respectful attitude towards the Planet, thus associating sustainability only with the environmental field. In the Bruntland Report (1987) this concept also includes the economic and social aspects. Unfortunately, all available sustainability evaluation systems still lack the broad prospective provided in the above mentioned report. In fact, they are limited to assessing in detail the environmental features that should be taken into account in designing a new building without considering neither the economic nor the social aspects. Starting from the need to assess sustainability in a comprehensive manner, the SustHealth team aims to provide the project's stakeholders with a simple and effective tool to understand hospital sustainability levels and the direction that should be followed to improve overall sustainability. To define the features of such a holistic but also operative system, the team used a method that follows both a theoretical and practical approach. Firstly, focus was placed on reading the most recent publications on hospitals, innovative healthcare centers and current sustainability evaluation systems. Subsequently, the group organized visits to some of the most recent and innovative hospitals, such as Istituto Clinico Humanitas and New Legnano Hospital in the vicinity of Milan, Italy and the New KarolinskaSolna Hospital in Stockholm, Sweden. This knowledge and experiences enabled us to enrich our multidisciplinary competences and work with a critical approach to develop the evaluation system presented in our ASP project.

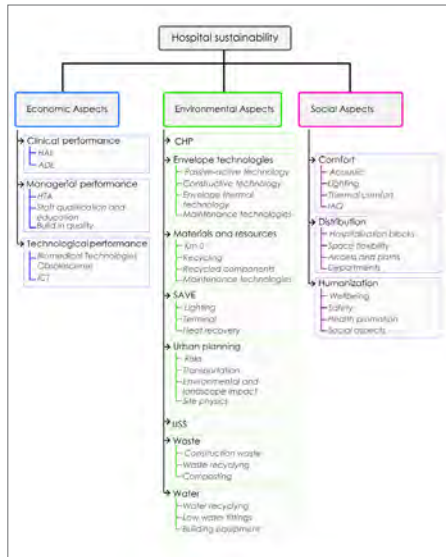

1 Indicators of hierarchy



2 Karolinska



3 Karolinska



4 Karolinska

UNDERSTANDING THE PROBLEM

In order to create a system that aims to foster sustainability in hospital design, the SustHeath team believed that effort was needed to analyze the essence of the sustainability concept and to understand the reason for its importance in the context of hospital design. By definition, a system or a process is sustainable if it can keep on running indefinitely. In the system in which society is included, achieving equilibrium would be ideal. Such equilibrium would result in consumption of resources which does not exceed the capacity of the ecosystem to regenerate them and pollution production which does not exceed the amount that can be absorbed. Unfortunately, this equilibrium is not reached in practice.

As presented above, the goal of making our species advance indefinitely can be achieved only if sustainability is holistically guaranteed from the environmental, social and economic points of view. At this stage, a question may arise: since every activity has social, environmental and economic implications, what is the role played by hospital design in the context of sus-

tainability? In order to answer this question it is important to consider that hospitals are very energy-consuming buildings. Furthermore, previous research has shown that one of the most important causes of health problems, together with an inappropriate lifestyle and genetic inheritance, is poor environmental conditions. Since hospitals have a very high environmental impact in terms of pollution and waste production, they became places where, instead of just providing care, they cause health problems as well. Hence, the reduction of the environmental impact of hospitals in terms of resource consumption and waste production is also important with a view to large-scale environmental sustainability.

In hospitals, good connections among the various areas, patient comfort and attentive social relations are very important factors in guaranteeing a high quality of life. Obviously, economic sustainability is a prerequisite for any hospital project to be implemented and managed over time, hence this has to be equally pursued. All considered, the SustHealth team B is convinced

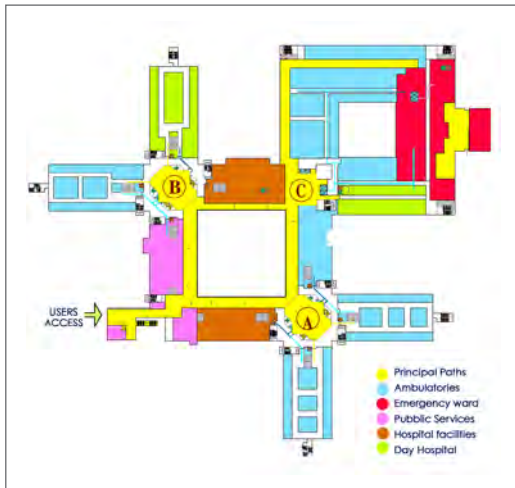

5 Plant of Legnano Hospital

6 Scheme of sustainability



that being able to assess the level of hospital sustainability during the design phase is of fundamental importance. In fact, in the design phase, improvement is still possible and represents a fundamental opportunity for hospital sustainability in the future. This practice attempts to avoid giving rise to already obsolete and unsustainable hospitals and to guarantee the flexibility of the structure for future improvements.

EXPLORING THE OPPORTUNITIES

Scholars in the field agree that many possible paths can be followed when developing a system that aims to foster sustainability in hospital design. Firstly, the team’s idea was to develop a set of rules for sustainable design in the attempt to improve the Piano-Veronesi Decalogue developed in 2001. According to the team, the Piano-Veronesi Decalogue was particularly theoretical and difficult to interpret. This idea of improvement could have been carried out through the creation of a series of suggestions to designers that could be used as concrete references related to the theoretical program mentioned above. However, the team de-

ecided not to follow this path and opted for creating a new evaluation system for hospital sustainability. The SustHealth team performed a thorough analysis of the literature and discussed multiple possibilities from which the evaluation system emerged. Focus was placed on studying the main evaluation systems such as BREEAM, LEED and ITACA. Here, the SustHealth team observed that they all limited their focus on assessing environmental sustainability without considering the social and economic points of view. Therefore, according to the group, the above-mentioned systems limited the effectiveness of the evaluation and were not considered suitable for rating hospital sustainability levels. In fact, in today’s world, patient experience and safety are central when designing a hospital. On the other hand, economic aspects are essential for efficient functioning of any healthcare structure and hence they too cannot be ignored.

GENERATING A SOLUTION

The purpose of the SustHealth project is to develop an evaluation system which aims to consider environmental, social and

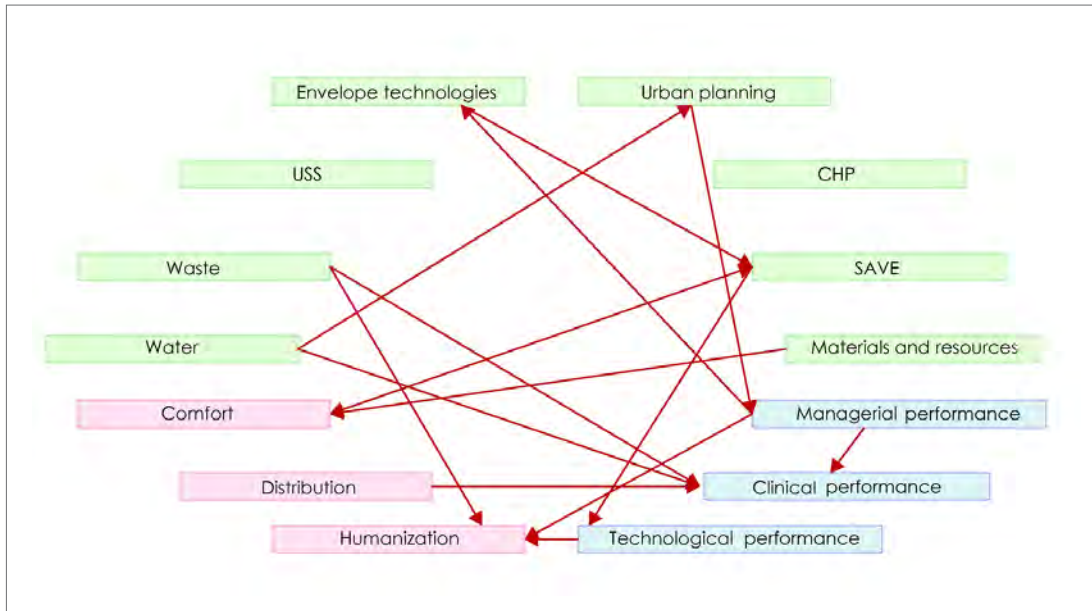

7 Scheme of influences

economic sustainability in order to provide practical guidance to be followed to achieve sustainability in the hospital design phase. Firstly, the team believed that given the complexity of the issue, a new evaluation system was useful if applicable by any hospital employee. Therefore, effort was placed on creating a complete yet simple tool. After some iteration, a hierarchical structure of three successive steps seemed the most suitable.

The Susthealth evaluation system is based on three macro areas that represent the three pillars of sustainability: social, economic and environmental. Each area is then composed of criteria and, at a lower level, of indicators. In order to complete the evaluation system, a weighting method was needed to highlight the different importance of each aspect of sustainability. At first the Analytic Hierarchy Process (AHP), which allows assigning weights to elements of the same level in the hierarchical structure, was analyzed. Experts in the field and focus groups were actors of this weighting process through pairwise comparison. According to the team, ignoring mutual influences among separate branches would have led to a less accurate outcome. There-

fore, the Susthealth group chose the Analytic Network Process (ANP) which, in contrast to AHP, presented a network-based approach. The team involved 15 experts in each field of sustainability in the development of the weighting procedure. Data collected were inserted and elaborated by the SuperDecision software. As a result, the importance of the environmental aspect equated to 55%, the social aspect to 24% while economic sustainability to 21%.

In order to identify both strengths and weaknesses of the hospital sustainability evaluation system developed in this project, it was decided to test the tool at Legnano Hospital. This analysis allowed the team to improve and further discuss each component to avoid misunderstandings and difficulties in the implementation phase.

To conclude, the solution which has been generated to foster sustainability in the hospital design phase consists of a lean and easy-to-use system that enables users to develop a comprehensive evaluation of economic, environmental, and social aspects of sustainability.

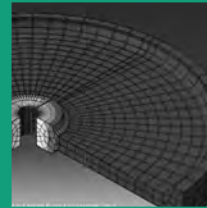
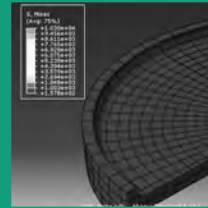
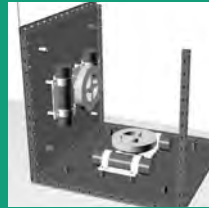
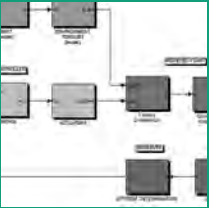
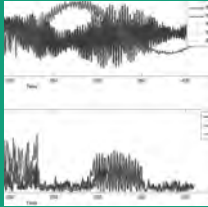
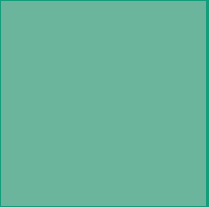
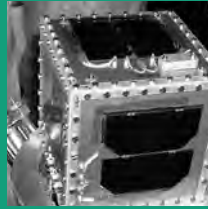

PROJECT

7

ARAM-AOCS



**DEVELOPMENT OF INNOVATIVE ATTITUDE AND ORBIT CONTROL
FOR LOW-COST AND LOW-MASS SPACECRAFTS**



ARAM-AOCS

Development of innovative attitude and orbit control for low-cost and low-mass spacecrafts

PRINCIPAL ACADEMIC TUTOR

Leonardo Maria Reyneri

Electronics, Politecnico di Torino

ACADEMIC TUTORS

Mario Calderini

Management and Production Engineering,
Politecnico di Torino

Emilio Pizzi

Management and Production Engineering,
Politecnico di Torino

Claudio Passerone

Electronics and Telecommunications,
Politecnico di Torino

Claudio Sansoè

Electronics and Telecommunications,
Politecnico di Torino

Alberto Vallan

Electronics and Telecommunications,
Politecnico di Torino

Massimo Violante

Control and Computer Engineering,
Politecnico di Torino

Lorenzo Casalino

Mechanical and Aerospace Engineering,
Politecnico di Torino

EXTERNAL INSTITUTIONS

SKY Technology

Neohm Componenti s.r.l.

SPIN Electronics s.r.l.

Universidad de Alicante

EXTERNAL TUTORS

Luca Senepa

SKY Technology

Guido Caronni

Neohm Componenti s.r.l.

Antonio Martinez Alvarez

Universidad de Alicante

project **7**

Developing the Attitude and Orbit Control Systems for ARAMIS, the programme aimed at designing a modular configurable platform for nano and microsatellites

TEAM A

Alessandro Valentino Matheoud

Electronic Engineering

Maria Piera Padula [Project communication coordinator]

Space Engineering

Roberto Pagano [Team controller]

Computer Engineering

Fabio Pontanari

Aerospace Engineering

Federico Secondi

Space Engineering

TEAM B

Matteo Causo

Electronic Engineering

Marco Maio [Team controller]

Mechanical Engineering

Mladen Mazuran

Computer Engineering

Michele Pilotto

Aerospace Engineering

Federico Rossi

Space Engineering

PROJECT DESCRIPTION

THE CHALLENGE

The aim of the ARAM-AOCS project was to design an Attitude and Orbit Control system for a new class of small, affordable and easy-to-use satellites.

The idea was proposed and supported by the Politecnico di Torino Electronics Department, that developed AraMiS, aiming to provide a modular satellite architecture in a very short period of time.

The Leitmotiv of this project was to address the rapid metamorphosis of the space market, from the big and complex to the small and cheap. AraMiS is part of the Italian response to the “Cubesat phenomenon”, a standard developed in the U.S. in order to enable students to lay their hands on real satellite hardware, as simple as the first Sputnik; in no time at all, many stakeholders showed their interest and new, unforeseen applications emerged.

AraMiS goes one step further: it is made of standard functional units that can be assembled arbitrarily to compose a more complex and flexible structure in a short lapse of time.

The project task was to investigate the potential of this new low cost design approach, giving AraMiS a specific path to follow in the satellite market and to upgrade the architecture with the ability of controlling orientation and specific direction in space. The main project innovation relies on the adoption of Commercial Off The Shelf components, while usually AOCS is performed by expensive, space qualified systems.

TEAMS

The first common activity was to explore this emerging class of satellites.

As a second step, the two teams approached this issue from different perspectives: on the one hand defining how to enter the market and the scientific community; on the other investigating new applications that could be fostered by this innovative approach, for new actors or for leading traditional space players.



This was the most challenging aspect of the project: students had to address a very technical problem from an innovative and multidisciplinary viewpoint and to form an opinion and decide on space related issues in a short period of time.

The following stage of the project was devoted to developing the technical concept: team A focused on the design of specific hardware that was chosen to be feasible, while team B implemented the AOCS software. The two works are meant to be standalone, but express maximum advantage in combination in the AraMiS architecture.

In this phase, very demanding competences in electronics, space technologies, mechanics and software were globally required, and students had to integrate their heterogeneous knowledge, learning from each other's work. The most ambitious challenge was to create something excellent relying only on simple abilities and low cost hardware.

RESULTS

The project represented an unique opportunity for a group of engineers to come out of their technical shells and discuss multidisciplinary topics, relying solely on their ideas and *modus operandi*.

The two teams were able to complete the design and implementation of the project and the work is expected to be launched on an academic satellite in 2014. It is intended to be used on different missions and to contribute to “lowering the barrier to space access, which was the project's main motto.



ARAM-AOCS Hardware

TASKS & SKILLS

Alessandro Valentino Matheoud chose the sensors and actuators and designed the control circuits for the proposed hardware.

Maria Piera Padula ran a technical simulation to validate the technical requirements, conducted a structural analysis and was our Project Communication Coordinator.

Roberto Pagano researched suitable processors, performed a technical market research and designed the actuator control software.

Fabio Pontanari defined reaction wheel requirements from AraMiS constraints and high level satellite requirements, designed the wheel support and made a cost analysis of the hardware unit.

Federico Secondi analyzed the AraMiS competitive advantages (such as modularity), conducted a market analysis and designed our reaction wheel.

ABSTRACT

The common denominator of students having selected the ARAM-AOCS project was the passion for space and technological challenges. This, along with the excitement of having the chance to shape something that will soon go into orbit, provided the impetus for the teams and drove our efforts when the challenge of the project seemed too ambitious.

We first approached the project with a market analysis, drafting a number of requirements for the attitude control of an AraMiS satellite. We then explored market possibilities and, finally, started our design. Our solution uses only C.O.T.S. (Commercial Off The Shelf) components to implement the attitude control and this can be considered an innovation: with redundancy and modularity we increase reliability of the components, thus demonstrating that expensive space qualified components are not indispensable. Moreover, when compared to other competitors, our satellites cost less and offer the AOCS feature: these represent our main competitive advantages.

In the following, we present all the steps of our work, starting from problem understanding and concluding with the proposed solution. If you are interested in discovering how a group of five engineers can design a system to make satellites face any direction in space, keep reading!

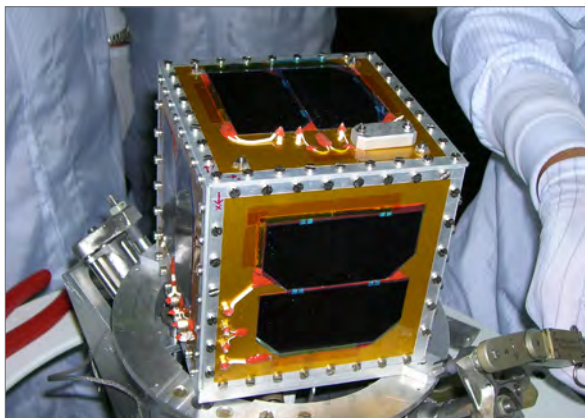

1 Photo of Aramis smallest, cubic configuration, Politecnico di Torino laboratories

2 Simulation representation of the reaction wheel designed by ARAM-AOCS team A, using Abaqus software

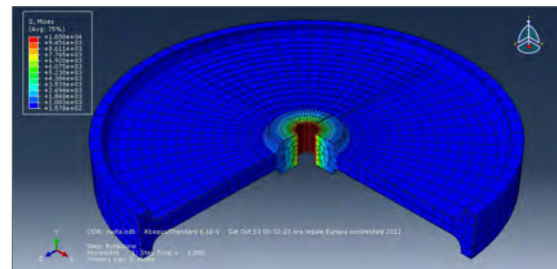

3 Representation of the tile including wheel and support designed by ARAM-AOCS team A, using Patran software

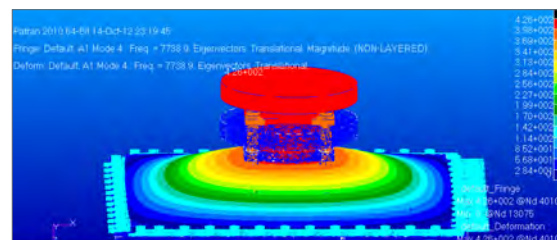

UNDERSTANDING THE PROBLEM

At first, the entire team believed that the project was technically oriented, as demonstrated by the fact that all the members are engineers. Eventually, it turned out, as one of our tutors, Mr. Calderini suggested, that it is not possible to develop a satellite without knowing anything about the satellite market and expect to sell it.

It is, instead, possible to conduct market research and develop the technology according to market requirements.

The project analysis carried out by the team started from the AraMiS documentation, reading papers and analyzing the project repository.

Subsequently, we conducted market research addressing the nano satellite state of the art and market requirements: it became increasingly clear that there is a trend towards smaller and less expensive satellites, targeted to a consumer market. A rapidly increasing number of universities and private companies are willing to send satellites into space. In this sense, the market requires modular and standard architectures, in order to fulfill their requirements without having in-depth knowledge of the satellite design process. From our research, it emerged that these smaller satellites often lack a vital feature: orbit and

attitude control systems. AraMiS is larger than a Cubesat, but it is more sophisticated and, for this reason, more targeted by universities and companies looking for imaging or in-space experiment applications. Besides that, there are many issues and controversies regarding low cost satellites to be taken into account: space junk, possibility of collision, privacy issues. All of them were considered in our analysis. From the market research a number of technical requirements that a satellite must have also emerged. We conducted a comparison between the AraMiS architecture and its competitors, identifying its advantages, such as modularity and low cost. We also drafted a number of scenarios and applications for the AraMiS satellite and identified the most interesting stakeholders.

EXPLORING THE OPPORTUNITIES

The challenge was a tough one: how to be competitive in the nano satellite market?

AraMiS is already competitive, but in order to be the best in terms of quality and price, in order to gain competitive advantage against the competition, it must at least have an attitude control system. So the question turned out to be: how to design

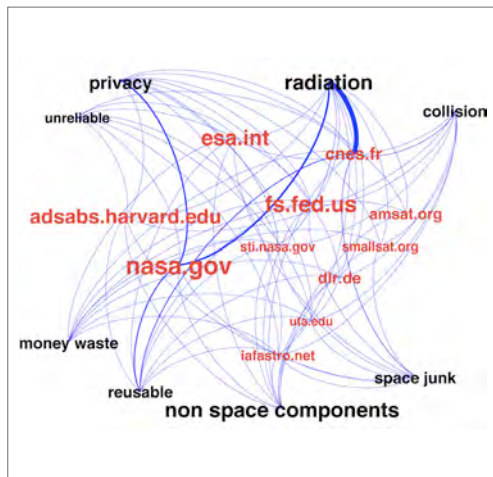

4 Representation of low cost satellite keywords and stakeholders proposed in March 2011, Belgirate Winter School

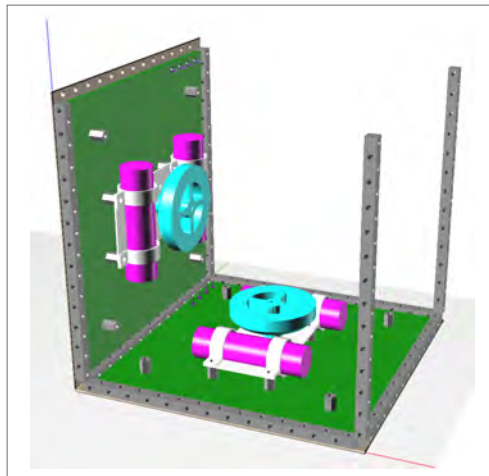

5 Simulation representation of the AraMiS satellite cubic structure, comprehensive of two basic AOCS tiles

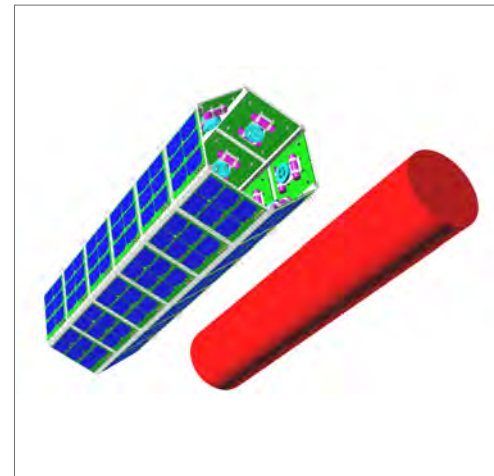

6 Simulation representation of the AraMiS satellite hexagonal structure and a typical cylindrical payload

an orbit control system that is reliable, fault tolerant and uses low cost hardware with non space qualified components?

Firstly, we looked at the actuation system state of the art : the choice at the beginning was whether to implement a passive or an active control system; a passive control system allows the satellite to be coherent with the Earth's electromagnetic field; in actual fact, it is a magnet allowing the satellite to align with the magnetic field of the Earth. The passive control system can also be achieved by means of a gravity gradient. An active control system, on the contrary, can allow the satellite to assume a generic Earth or space orientation. We soon realized that if we wanted to make our satellite "general purpose" and modular, we were obliged to design an active control system. Here the choices were few: thrusters were evaluated, but they are large and expensive, so they were discarded. Spin stabilization, control moment gyroscopes, magnetic torquers and gravity gradient stabilization were also taken into consideration, but were rejected both due to cost, dimensions, accuracy and power requirements as well as the possibility of providing multiaxial stabilization.

We therefore opted for momentum wheels: these are electric motors that spin in the opposite direction to that required to

re-orient the vehicle. They provide precise control and can be designed to be small, thus taking up a small fraction of the vehicle's space and mass. In addition to magnetic torquers, that were already present in the AraMiS project, wheels are essential to obtain triaxial control; the next step was therefore the wheel design.

The design took as inputs certain constraints coming from the AraMiS architecture and certain requirements consistent with the typical mission profile.

The main constraints were geometrical, motor-dependent and temperature dependent, in terms of operational temperature changes. Mission related requirements of agility, orbit and lifetime heavily influenced the design.

We made a number of crucial choices that impacted throughout the entire design phase: this process was highly iterative and influenced the scheduling and logistics of the project. We chose and designed the wheel configuration, the support, the motor and the related circuits, as well as the related software. We also ran a structural analysis to validate our design, since the satellite needs to resist to typical loads present during its entire life.

The main design drivers during these processes were minimiza-

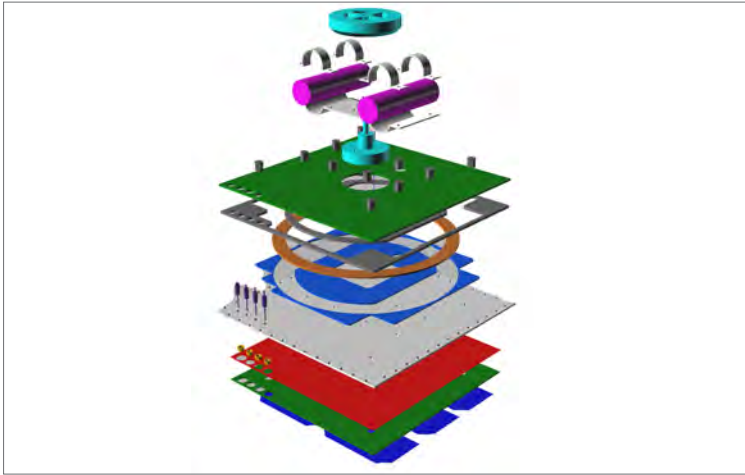

7 Split session representation of the AraMiS tile or module

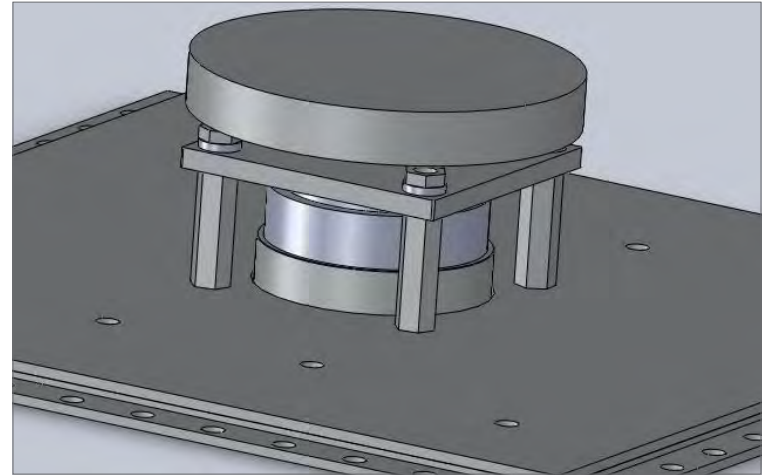

8 Simulation representation of the wheel mechanical support, designed by ARAM-AOCS team A

tion of weight and cost, attitude control performance, allocation inside the AraMiS structure, structural resistance, size of the payload and complexity of the structure.

The software was programmed using the Visual Paradigm framework that allows integration with the rest of the AraMiS architecture. The software is fairly simple and straightforward and takes care of receiving the rotation commands and forwarding them to the wheel. It also manages the velocity and is able to respond to commands asking information on the status of the wheel.

GENERATING A SOLUTION

Finally we generated a solution to our problem: after many choices we designed what the AOCS of the AraMiS architecture will be like. The innovation, in this sense, is that it is made of non space qualified components and is fault tolerant. Moreover, only few nano satellites have AOCS and this adds value to AraMiS and increases the number of ways it can be exploited; this also makes AraMiS more “appealing” to the market.

Together with our tutor, we decided not to design the orbit control system because this feature would have increased the over-

all cost of the satellite, making it no longer low cost; it would not have added significant value for the market. Validation of the results consists, obviously, of lab tests. Our group also participated in I.A.C. 2012 in Naples, the International Astronautical Congress: during this conference we had the possibility to compare our concept with the current state of the art of nano satellites: AraMiS has nothing to envy of other satellites, confirming its competitive advantage. The ultimate challenge and validation for the AraMiS concept and for our project’s contribution will take place in space, as soon as the next satellites will be launched.

MAIN BIBLIOGRAPHICAL REFERENCES

- [1] J. Wertz, W.J.Larson, Space Mission Analysis and Design, 3rd edition, 1999
- [2] M.J.Sidi, Spacecraft dynamics and control: a practical engineering approach, Cambridge University Press, 2000
- [3] ARAMIS, Heavily Modular Architecture for Low-cost Satellites, Politecnico di Torino Electronics Dept. and Space Avionics Technology Center, 2010

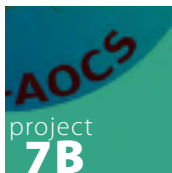

ARAM-AOCS Software

TASKS & SKILLS

Matteo Causo researched the state of the art of satellite sensors and actuation circuits; he developed the communication interface for the satellite software .

Marco Maio developed the satellite as service business plan and was responsible for the supervision algorithm. As Team Controller, he managed deliverables and communication.

Mladen Mazuran studied the possibility of filing patents. He made a remarkable effort in writing the software code, in particular the Extended Kalman Filter.

Michele Pilotto researched sensors and attitude determination modules. He looked for launch opportunities and prepared the Simulink simulation.

Federico Rossi analyzed the state of the Articles of Association and contacted stakeholders to understand possible market opportunities. He evaluated different control architectures and synthesized AraMiS's control algorithm.

ABSTRACT

Space is an attractive environment inasmuch as it is the extreme challenge to knowledge. This was the major motivation of all team members for joining this project at the beginning of the ASP program: everyone wanted to demonstrate their technical skills in an interdisciplinary context under the common denominator of engineering.

The opportunity of a space experience for team B of the ARAM-AOCS project was to work on the satellite software. The starting point was the AraMiS satellite project of the Politecnico di Torino, for which a control algorithm had not already been developed. The team was invited to answer this request by implementing the attitude determination and control (ADC) software.

This report recounts the history of this project which was technical only at a first glance: after a state of the art investigation on space technology, the group had to deal with a strategic and business analysis. Only subsequent to this could a technical solution be produced. During the work it was necessary to continuously redefine the objective since as limitations arose.

Finally, the choice fell on a high standard solution. The proposed software is better than CubeSat standard solutions and can be used and reused on different platforms: this also matches the AraMiS goals.

The top level objectives of the educational experience were to manage a multidisciplinary and heterogeneous group, to open the engineers' minds and to make them excellent team players. Despite certain difficulties, during the project everyone turned out to be a passionate hard worker, capable of building a strong network.

The team was able to successfully implement the software and integrate it into the AraMiS architecture. Among team members, the conviction was that, even though we may split up, this experience had changed our way of being engineers, giving us new perspectives.

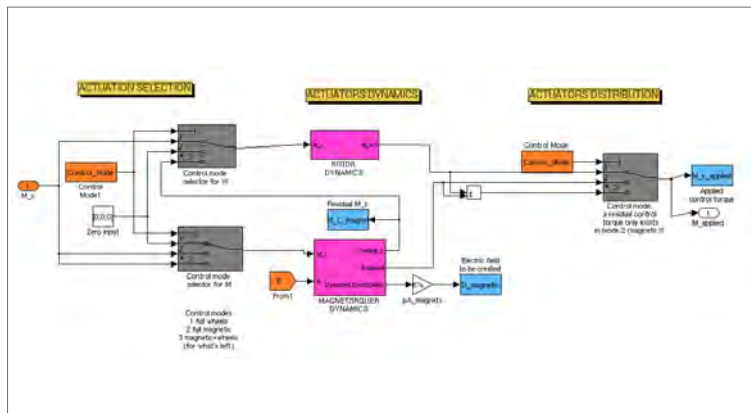

3 Illustration of attitude actuation distribution in the simulator built using Simulink®

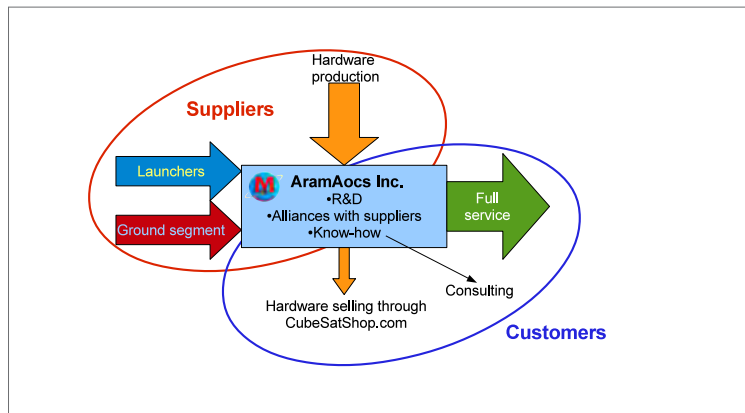

4 Schematic of the “fully integrated satellite” solution proposed as an alternative to the AraMiS business model

The first refers to service companies where the customer buys a solution; building a reputation is, in this case, of paramount importance. The company, which has strong alliances with suppliers, can handle the full process from hardware production to integration, testing, launch and operations.

The second alternative is a company that sells a product to an expert user competing on costs and responsiveness. In this case, interested purchasers may be governments and the military with the limitation that when possible they prefer national rather than foreign companies.

The merging of the two positions could be a company starting selling products (for example on CubesatShop) and then evolving to a consultancy-based model, targeting private players, universities or even emerging country space agencies, as its expertise increases. In this vision, the core business is composed of professional users, while the interest towards hobbyists should be minimal.

This analysis was concluded with research on launch opportunities for small satellites considering the technological requests of vectors and their costs.

In October 2012 several members of the group attended the International Astronautical Congress in Naples where the 19th symposium on small satellites took place. There the team had

the chance to meet the stakeholders identified in previous phases and found many suggestions from current trends and requirements: assembling together more CubeSat (6 or 12 units) to have more space and higher performance, interest of emerging countries in consultancy concerning technical training, operations, design and launch. Finally, several members got in touch with spinoffs and entrepreneurs gathering precious suggestions and ideas for future project developments.

GENERATING A SOLUTION

The step following the strategic analysis was implementation of the satellite software.

In this phase, which can really be considered the proposed solution, certain points were of highest importance in driving all the choices: (i) the software must be compatible with different hardware (ii) and independent from geometries, (iii) modularity and standardization are desirable and (iv) the AraMiS standard should be kept as a reference, in particular, the limited computational power of this standard must be addressed.

The focus was on the ADC system, which is responsible for guiding the satellite.

At first the attitude (orientation) of the satellite is estimated relying on the measurement information provided by the many

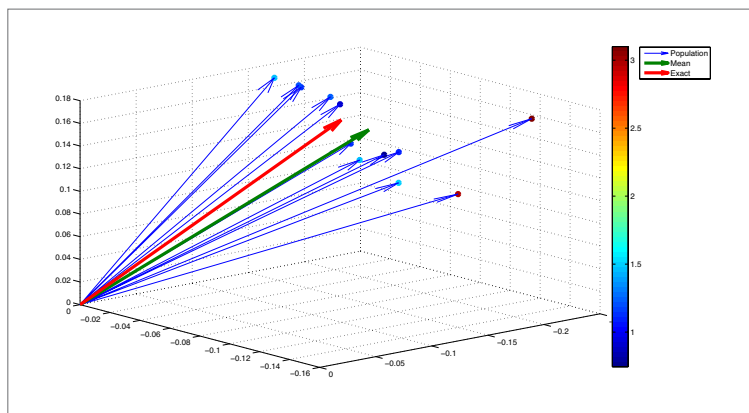

5 Matlab® reconstruction of magnetic field measurements: sample mean and sensor dispersion, evaluated by means of Malanobis distance (software Supervision module)

sensors (magnetometers, gyroscopes and sun sensors). The code includes an Extended Kalman Filter (EKF), which was found to be the best trade off in terms of computational speed and accuracy of the estimate. A very detailed technical analysis was performed with the best known techniques to ensure system functionality.

Once an estimation of the orientation is available the control law computes a command to make the satellite move in the desired manner using reaction wheels and magnetorquers. The innovation is not the technical solution itself (quaternion feedback) but rather application of this method in the field of nanosatellites. From our analysis it emerges that this solution has hardly ever been applied in a CubeSat.

To interface the pre existing AraMiS work and the ADC system, a command interpreter was also required. This is also essential for making the ADCS adaptable to other standards.

Finally an algorithm supervises the ADCS, preventing failure situations by switching the satellite to a safe mode in case of danger. A completely new function proposed by our team tries to estimate the coherence between different measurements and to identify faulty sensors by means of statistical tests.

During the design phase, a number of critical issues were the limited resources of AraMiS, the need to develop a system that

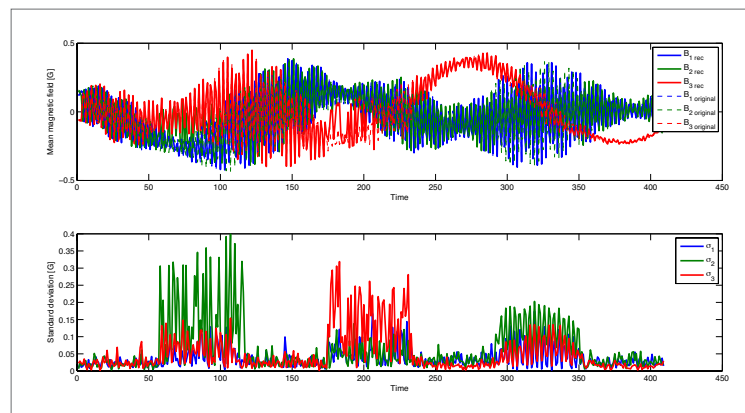

6 Matlab® sensor performance evaluation and hardware failure identification (software Supervision module)

could interact with different sensors and actuators and address the problems related to magnetic control. Therefore, a simulation was necessary at the end to validate its behavior. It was also useful to refine certain software parameters. Following this brief review, in which everything was assembled together, it was possible to perform a number of preliminary tests on real satellite hardware.

With these we proved that integration with the work of team A could be successfully achieved. The goal of the team was to create control software for a generic satellite, which was independent of the chosen hardware and could be reused in different contexts.

MAIN BIBLIOGRAPHIC REFERENCES

- [1] S. Speretta, L. M. Reyneri, M. Tranchero, C. Passerone, D. Del Corso, *Modular architecture for satellites*, 58th International Astronautical Congress, Hyderabad, India, 24 - 28 September 2007
- [2] M. Porter, *Competitive Advantage: creating and sustaining superior performance*, Free Press, New York, 1985.
- [3] J. Wertz (Editor), *Spacecraft attitude determination and control*, Kluwer Academic Publishers.

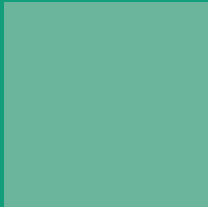
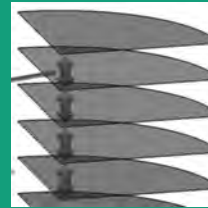
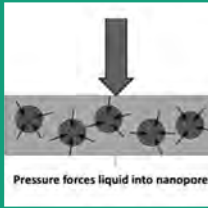
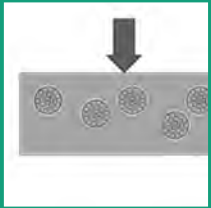
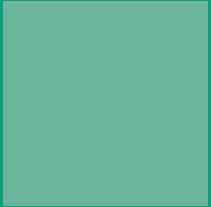
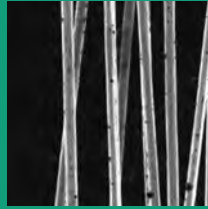
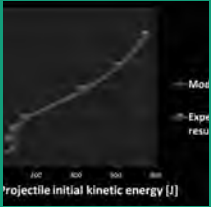

PROJECT 8

Spider Silk



INSPIRED SUPER-TOUGH NANOARMOURS



Spider Silk

Inspired super-tough nanoarmours

project 8

The aim of the Spider silk project is to design a lightweight nanoarmour able to resist penetration of high energy fragments through its bio-inspired toughness

PRINCIPAL ACADEMIC TUTOR

Nicola Pugno

Structural, Geotechnical and Building Engineering, Politecnico di Torino

ACADEMIC TUTORS

Alberto Corigliano

Structural Engineering, Politecnico di Milano

Barbara Del Curto

Chemistry, Materials and Chemical Engineering "Giulio Natta", Politecnico di Milano

EXTERNAL INSTITUTION

AMET S.r.l.

EXTERNAL TUTOR

Paolo Cavallo

AMET S.r.l.

TEAM A

Bethany Neigebauer [Team Controller]

Architecture

Sara Baronetto

Building Engineering

Stefano Bosetti

Mechanical Engineering

Flavio Caciuffo

Energy and Nuclear Engineering

Anna Gabriella Ciriolo

Physics Engineering

Gianni Robert Rehkopf

Design

TEAM B

Stefano Signetti [Team controller and

Project Communication Coordinator]
Civil Engineering

Francesco Buonora

Energy and Nuclear Engineering

Vito Mario De Leonardis

Mechanical Engineering

Lorenzo Rossini

Aerospace Engineering

PROJECT DESCRIPTION

THE CHALLENGE

Over the last few decades, the search for bio-inspired solutions has been widely accepted in many engineering and technological fields as the best way for optimizing and taking advantage of available resources. Nature over the ages has found its optimal solution for survival and our teams therefore looked at Nature for the design of device nanoarmour whose scope is essentially to save lives. Existing materials and technologies allow current engineering solutions to stop projectiles of different kinds but these existing devices do not safeguard against the penetration of minute fragments. The need for unconventional toughness suggests that we need to look for inspiration, for example, from spider silk or bombardier beetles. What follows is research at the leading edge of current material science and computational mechanics.

THE TEAMS

The two teams addressed the challenge of designing bio-inspired lightweight nanoarmour through alternative and complementary methods: an analytical/theoretic approach by the *MoDe* team, implementing and elaborating current theories of impact mechanics, and a numerical predictive approach by the *SaFe* team, using the most advanced multi-physics simulation codes currently available. As a case study we focused on military helmets. The “Giuseppe Maria Pugno” Laboratory of Bio-Inspired Nanomechanics at the Politecnico di Torino is an authority in the field of Nano-Bio-Inspiration (papers in *Nature* and *Nature Materials* and ERC Starting Grant Winner 2011) and supervised the two teams.

THE RESULTS

The *MoDe* and *SaFe* teams collaborated with one another in order to conceive and design an innovative and feasible protective armour concept. Based on the *MoDe* team’s analytical models of impacting projectiles and the *SaFe* team’s numerical



simulations, a new-generation of a bio-inspired, undulated and multi-layered helmets is proposed. The *MoDe* team focused on the design of the internal safety system, especially looking at ergonomics, and how to integrate and implement the innovative external shape, while the *SaFe* team (in collaboration with AMET) verified the protective effectiveness and reliability of such a new design, carried out studies aimed at finding the best solution in terms of multi-layered structures and, last but not least, the feasibility of the production process. The proposed new concept has applications in several other fields: spin-offs could be directly or indirectly involved in the future and new stakeholders might be interested in it, from sport safety to hail resistant architectural roofs or to protective shells for strategic structures and plants.



MoDe Model & Design

SPIDER SILK — INSPIRED SUPER-TOUGH NANOARMOURS

TASKS & SKILLS

Sara Baronetto studied analytical models to understand how material characteristics affect bullet penetration; using these models, she compared different materials and layer configurations.

Stefano Bosetti built an analytical model to study the penetration of a projectile against a homogeneous target. He applied Cavity Expansion Analysis for the characterization of experimental parameters.

Flavio Caciuffo studied the effects of melting during bullet penetration and built an analytical model to describe bullet penetration in composite material targets. Finally he made a comparison of different materials using this model.

Anna Gabriella Ciriolo contributed by studying oblique impact mechanisms and proposed channeling as an alternative solution to reduce projectile penetration.

Bethany Neigebauer researched and explored alternative disciplines for the use of spider silk inspired materials, specifically looking at American football helmets and hail damaged architectural roofing.

Gianni Robert Rehkopf performed the material and state of the art research. He then defined the helmet ergonomics and shape, modelling the undulated surfaces and the overall geometry.

ABSTRACT

Protective armours, such as helmets, have undergone a continuous process of evolution over the ages, following the paths paved by technological progress. Ancient Greek and Romans developed bronze and iron models to defend their soldiers from swords and spears. These helmets were partially abandoned around 1200 A.D. because of their inefficiency against new firearms. Helmets, primarily composed of steel, reappeared during World War I to protect infantrymen from fragments generated during explosions. A new era started in 1972 with PASGT, the first helmet composed of high strength synthetic fibres. Today the majority of the shells are composed of woven layers of high resistance fibre immersed in a polymeric matrix, however a substantial amount of work has yet to be done in order to improve their performance. New directions in research have been opened by bio-sciences, allowing Nature to become a fundamental source of inspiration.

The general task of the MoDe team was to propose and develop innovative solutions in order to make armour both lighter and more resistant to fragment penetration, exploiting the objectiveness of analytical approaches in providing general guidelines. Starting from study of the literature, we focused on the analytical aspects of the specific physical phenomenon under investigation, i.e. bullet penetration into a target. Models were then developed and enhanced, until a satisfactory match with experimental results was reached, in order to obtain tools to study how to improve the performance of a target by modifying its main characteristics. These models were then exploited to test the mechanical performance of potential materials currently available on the market or in the advanced study phase, without forgetting issues related to feasibility in terms of total weight of the helmet. Bio-inspired solutions were integrated: we developed a shell shape inspired by the interior explosion chambers of the bombardier beetle.

Our efforts also polarized on:

- developing a new ergonomic and safe padding system design;
- studying the possibility to improve ballistic performance in reducing fragment penetration by means of a configuration of inclined layers;
- researching and proposing other disciplines in which innovative helmet materials could be useful, in order to discover possible future applications for the work presented by the group.

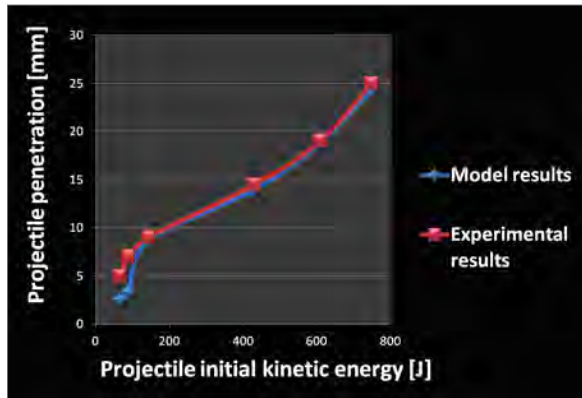

1 Projectile penetration vs. initial kinetic energy

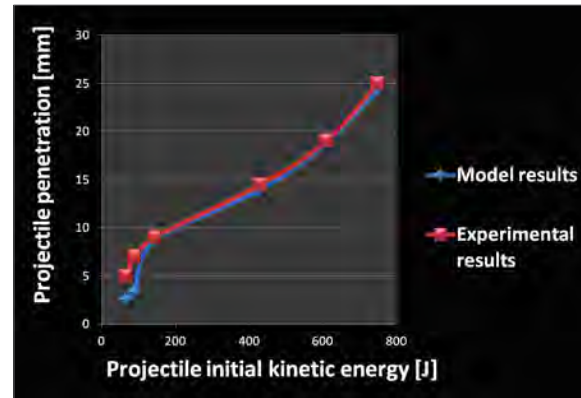

2 Projectile penetration in different materials

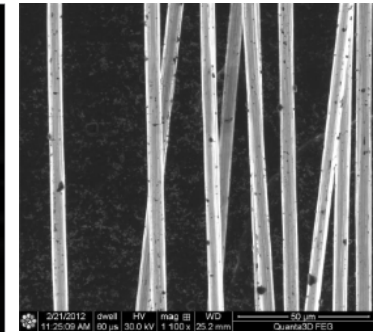

3 SEM capture of carbon fibres

UNDERSTANDING THE PROBLEM

Nowadays, protective devices and armours are heavy and cumbersome in order to defend against penetration. However, preventing the penetration of fragments and chips remains a difficult issue. Our starting point as a source of inspiration was Nature. Exploring materials, we found spider silk to be stronger by weight than steel and to be one of the toughest materials that exists. Creating a body armour or a helmet with a similar material would lead to an ultra-light and super strong protective outfit. Exploring different shapes, we found that the structure of the multi-layer undulating walls of the bombardier beetle's interior body chambers efficiently absorb impact energy from explosions.

Therefore, our aim was to investigate, from an analytical perspective, the possibility of improving the mechanical behaviour of military helmets, making them lighter, and at the same time more comfortable and easier to handle, taking Nature as a constant point of reference. To achieve this goal, in-depth knowledge of ballistic impacts is required, since only understanding how they work is it possible to devise an efficient strategy and act on the parameters that mostly influence helmet resistance.

Also ergonomics is important when designing a helmet. Studying the history of helmet design and the pad systems currently in use, we tried to understand the requirements to achieve the best possible comfort and safety. Army helmets are usually planned to resist potential injuries, such as skull fractures and injuries due to shrapnel, fragments or bullet strikes. On the other hand, current army helmets do not offer enough safety against shock waves caused by IEDs (improvised explosive devices). In fact more than 150,000 soldiers (59%) have been diagnosed with TBIs (traumatic brain injuries) since 2001, mainly in conflicts in Iraq and Afghanistan.

Finally, other fields of application were analysed. In particular, we focused on problems deriving from head collisions in American football players and similar athletic helmets. In addition, we studied the issue of impacts of hail on architectural roofing. In fact, apart from the specific objective of our project, other stakeholders can be identified as potentially interested in the production of efficient protective systems, such as manufacturers of motorcycle helmets, Formula 1TM helmets or protective coverings for the preservation of buildings and structures.

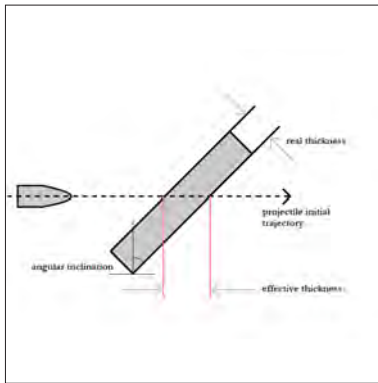

4 Oblique impact: effective thickness enhancement



5 Frontal view of the helmet



6 Back view of the helmet

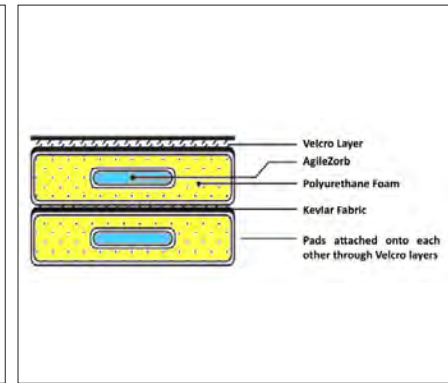

7 Removable pad structure

EXPLORING THE OPPORTUNITIES

The process of bullet penetration in a target is influenced by several variables, among which bullet shape and resistance of the target material are only the most obvious. During the first phase of the project, research on existing studies of bullet penetration in a target were carried out. Since these studies did not exactly meet our requirements, it was necessary to create new analytical models starting from very simple ballistic situations and specifically basic formulas found in literature.

To adapt our results to real tests, research on NATO ballistic tests were conducted. As projectile shape affects the depth of penetration, it was decided to use NATO bullets and fragments for our analysis. In particular, more attention was paid to the behaviour of targets struck by fragments, since these have proven to be more difficult to stop.

Furthermore, studies on multi-layer targets were investigated, in particular on the issue of delamination between layers. Materials composed of different layers bonded together can dissipate energy during ballistic impacts, also thanks to parting of the adhesive. In this way, the velocity of the projectile and the penetration depth can be reduced. However, to examine this issue properly, ballistic tests turned out to be necessary. To overcome this obstacle, estimated values were used.

Since the evolution of military helmets is interrelated with the

development of weapon technologies, to absorb the increasing energy of bullets, fragments and blasts, helmets have become thicker and, as a consequence, heavier and less comfortable. In order to improve comfort and safety, padding systems and ergonomic measures of motorcycle and NFL helmets have been investigated. As a result, it turned out that many existing materials and technologies already used in other disciplines could be directly implemented in the design process.

GENERATING A SOLUTION

Our first step was to expand a model describing bullet perforation in a homogeneous material. Through appropriate calculations, coefficients for quantification of the projectile shape influence in penetration dynamics were determined. Furthermore, the potential presence of multiple layers was included.

Subsequently, another model concerning composite materials was developed, formalizing aspects related to the mechanism of partial dissipation of a bullet's kinetic energy into thermal energy and adding the component of viscous friction. This second result was used to compare the mechanical performance of different materials already present on the market, without neglecting the final weight of the shell. Thanks to this comparative analysis we were able to identify the best material solution currently feasible. Among the materials considered, glass and



8 AgileZorb® peculiar behaviour under compression

9 Inner view of the helmet (pad system) 1

10 Inner view of the helmet (pad system) 2

11 Building application of the MoDe concept

ceramic fibres showed great resistance to penetration but had an excessive final weight. On the contrary, UHMWP fibres exhibited optimum performance in terms of shell weight but maintained low penetration resistance. Carbon fibres provided good responses in both cases, even though the optimal material solutions were represented by Kevlar®, M5® and Zylon®. Within the latter three compound subsets we must specify that Kevlar® is already widely used in protective applications but is still in a refinement phase.

This material analysis accompanied the design of the outer and inner shell shape for optimization purposes. Starting from the internal shape, an appropriate padding system was designed. This mainly consists of a first layer of force deflecting material, directly under the outer shell, to efficiently disperse the impact energy. Attached to it, a Velcro® layer ensures the customizable positioning of various pads. These pads are made of up to three polyurethane layers (positioned one on top of the other using Velcro® layers according to user comfort), including a very effective energy absorbing filler material called AgileZorb™. They are also interspersed with Kevlar® fabrics to add the anisotropic component and thus further deflect the shock wave along the in-plane directions. For the outer shell, through FEM analyses carried out by the SaFe team, the performance of a particular undulating geometry inspired by bombardier beetle armour [2] was compared

to a flat one, revealing better impact energy absorption by distributing it over a larger area. This particular shape was therefore selected. Taking into account all of these results and analyses, a new helmet concept was designed.

In parallel, alternative configurations for the internal architecture of anti-penetration systems was analytically studied. This led to the idea of inducing structural modifications to the standard juxtaposed multilayer solution, inserting an inhomogeneous layer, characterized by inclined layer components, to deflect and consequently reduce fragment penetration depth. In this sense, however, further studies are required in order to prove numerically and experimentally the significance and feasibility of results. Finally we explored the possible fields of application that our protective armour design strategy could directly or indirectly affect. In fact, not only body defence, but also a number of other disciplines, such as building preservation, could benefit from advances in penetration resistance technology. On the one hand, American football helmets and similar athletic helmets were considered. On the other, an architectural study specifically regarding the protection of roofs from hail storms, a phenomenon which has impact statistics similar to ballistics, was carried out. Even in these completely different scenarios, the potential application of bio-inspired materials can lead to the discovery of additional multidisciplinary opportunities.



SaFe Safety & Feasibility

TASKS & SKILLS

Francesco Buonora analysed the resistance properties of a multi-layered surface. He also studied the applicability of bio-inspired solutions and materials. He also coordinated collaboration both inside and outside the team.

Vito Mario De Leonardis studied the effects of geometric modifications on the impact performance of isotropic materials and helped create a model to predict penetration depth in metal targets.

Lorenzo Rossini analysed different manufacturing processes for composite materials and worked on a possible production cycle.

Stefano Signetti studied numerical techniques and issues in modelling composite materials subjected to high-velocity impact and performed sensitivity analyses on the main material model parameters.

ABSTRACT

The problem of protective devices, especially armours, has been treated so far by a “rough” empirical approach, following the philosophy “add material until it stops”. Over the last decades the invention of new materials such as Kevlar® has driven armours towards resistance levels previously unimaginable. However, the current request for lightweight devices and the desire for a solution age-old problems, such as high penetration of minute fragments, question the ability of this approach to produce an effective device. Military helmets, since their issues in terms of design, resistance and production processes are extreme, were chosen as a case study.

Computer-Aided Engineering (CAE) is the exploitation of computer software to aid in engineering tasks. Its use has enabled many industry fields to reduce product development costs and time while improving safety, comfort, and durability. The predictive capability of CAE tools has progressed to the point where a large part of design and verification is done using numerical simulations rather than physical prototype testing. Our team focused on this engineering approach in the structural design of the helmet, through the use of the most advanced FEM codes for non-linear problems currently available. Studies were also performed in order to establish how performance could be improved by optimising dissipative phenomena and adopting an unconventional profile for the helmet surface.

The productive collaboration with AMET S.r.l., a high-tech CAE company, and with an external composite producer, allowed us to optimize our analyses, to verify our results by experimental testing and to highlight new issues at the forefront of the capability of numerical simulation techniques. This collaboration also helped manage the basic product requirements, both in terms of safety, ergonomics and production feasibility, in order for an innovative production chain to be conceived and proposed.



1 Headquarters of AMET, Environment Park - Torino

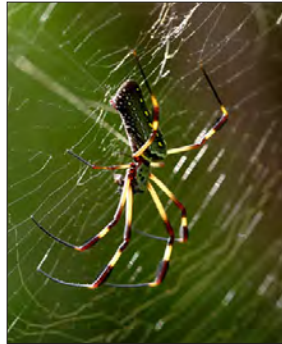

2 *Nephila clavipes* and its web

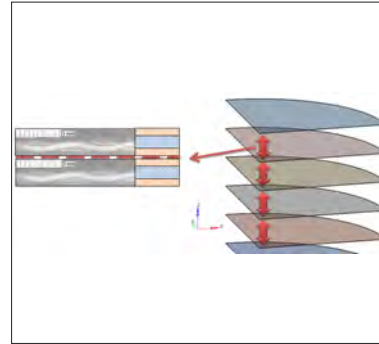

3 Numerical model of multi-layered composite material

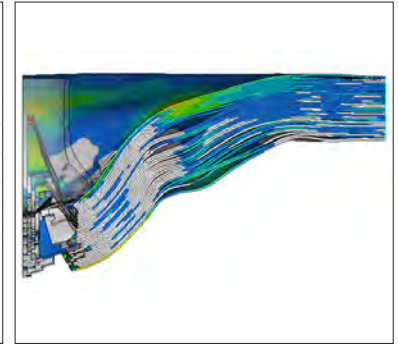

4 Side view of impacted plate, contour of maximum principal stresses

UNDERSTANDING THE PROBLEM

The SaFe team decided to investigate the effectiveness and feasibility of a bio-inspired solution by use of numerical analysis tools, focusing in particular on performance improvement of multi-layered composite panels.

The use of composites is the first fixed point of the solution: since a “perfect” material does not exist, their strength derives from the combination of two or more materials that can combine very different (and in many cases incompatible) properties in the same material, each enhancing its own characteristics and compensating the deficiencies of the others. The second point of the solution is the multi-layer ply: delamination energy is proportional to the fracture surface, and therefore to the number of available interfaces, and not to the helmet thickness (except for the capability to insert a given number of layers in a certain thickness); this aspect is strategic in reducing helmet weight and making it more ergonomic.

Starting from these considerations, spider silk toughness and non-linear hyper-elastic behaviour were borrowed for improvement of material properties and structural behaviour, while the example of the bombardier beetle [2] suggested adoption of an unconventional corrugated surface as a first level defensive mechanism.

Generation of an innovative solution for armour, as any other engineering problem, does not take place in a vacuum. Collabora-

tion with an external company was therefore essential. Besides validation of our models, this also provided an understanding of the technical feasibility of the proposed solution. Current production processes of multi-layer composite panels present certain issues that can affect the real effectiveness of the optimal solution. It is therefore a necessity to adjust initial forecasts or discover new production solutions to move from “idea” to “innovation”.

EXPLORING THE OPPORTUNITIES

The parameter that establishes the capability of materials to dissipate energy at failure is the work to fracture. Spider silk is the toughest material known in nature with a specific work to fracture of the order of 170 J/g. Only recently, with the advent of nanotubes, carbon nanotube/polyvinyl alcohol gel composites have been produced, achieving the world record with a work to fracture per unit mass of 570 J/g. However, toughness is not the only goal to be achieved. The helmet must maintain its resistance properties in the most adverse climatic conditions and therefore thermal resistance and low humidity absorption are key requirements; the material must be stable under processing that involves high pressure and temperature; toughness itself is not sufficient but rather high performances with low level of deformation must be guaranteed, since extreme buckling of the helmet is just as dangerous. Along this direction, a wide range of

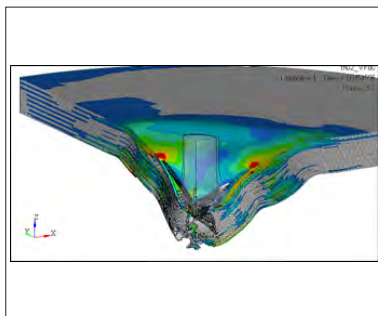

5 Isometric view of impacted plate, contour of maximum principal stresses



6 Ballistic test on Kevlar® composite panel: full penetration



7 Ballistic test on polyethylene composite panel: no penetration with delamination visualisation

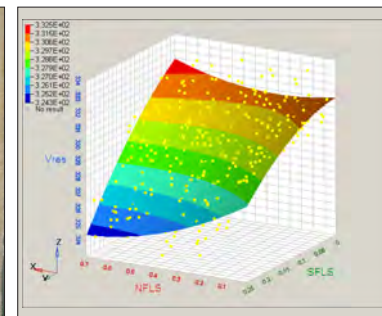

8 DOE results: sensitivity on residual velocity of normal (NFLS) and shear (SFLS) delamination strengths

available traditional and unconventional materials were examined in order to find the best balance of the required properties. Where it is not possible to further improve material performance, Nature teaches us to use it in the best way: the choice of fibre orientation in the successive layers, the alternation of different materials and the presence of strategic voids are all aspects subjected to the optimization process. The reaction chamber of the bombardier beetle [2] provided us with a second inspiration: even if its purpose is not to resist impact penetration, we decided to investigate the performance of undulating shapes in our problem, finding unexpected results.

Correct representation of the real problem through a numerical model then becomes a central issue. The aim is to represent the phenomenon as realistically as possible, always bearing in mind that the model has its own intrinsic limitations and requires a certain level of simplification due to the compromise between complexity of available models and computational costs. The collaboration with AMET guaranteed the necessary know-how for starting the analysis and, following implementation of this unconventional problem, new numerical techniques and methodologies were explored.

Production of this kind of helmet is quite a complex process and would require significant changes in the industrial process, challenging economic and technical feasibility: this led to the study and proposal of a new production process to actually manufacture our product in acceptable terms.

GENERATING A SOLUTION

A new concept of a multi-layered undulating helmet is proposed and developed in holistic complementary collaboration with the MoDe team. Several procedures may be adopted to model the composite material layers: woven fibre can be represented in both its constituents by use of solid or beam elements which assign both the fibre and matrix properties. On the other hand, the ply can be translated into a homogeneous equivalent continuum and the composite properties result from the weighted average of its fractions. This option can be implemented by modelling each layer with shell elements or with one or more solid elements throughout its thickness. Following this direction, the choice fell on the new LS-DYNA® thick shell element (TSHELL) [3], provided that its efficiency in describing the problem could be proved.

As also confirmed by experimental tests, delamination was shown to be important but not as dominant as expected: rather the adhesive strength has to be carefully balanced because it can cause transition from ductile and dissipative behaviour, due to the material plastic work, to local punching fragile failure. As plastic deformation is the key for dissipation, the material must guarantee high toughness even at low deformations, and high post-peak residual strength.

Inspired by the resistance to high pressure shock waves of the bombardier beetle endoskeleton, the team decided to evaluate whether macro-geometric changes to the exterior surface of the



9 The undulated shell of the bombardier beetle (*Brachinus crepitans*)

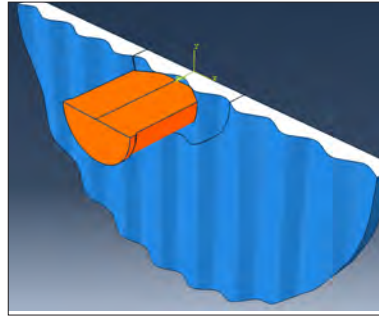

10 FEM model of fragment impacting on the corrugated surface

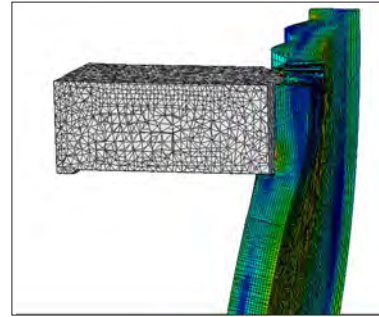

11 Projectile inversion caused by the corrugated surface



12 The resultant surface of the helmet

helmet could lead to better ballistic performance without increasing its weight. Numerical simulations were therefore conducted to compare the behaviour of undulating and flat targets. Several sinusoidal surfaces were designed, changing wavelength and amplitude. Simulations showed that a fragment with a specific initial velocity completely penetrates the flat plate, while corrugated surfaces can block the projectile. This holds true only if the diameter of the fragment is larger than the wavelength of the sinusoidal function, since otherwise the projectile might hit an area with a reduced cross section. The behaviour of plates with a triangular wave profile were also tested, but the V-notch discontinuities caused decreasing performance due to local intensification of the stress field, especially in the case of thin targets.

These optimised structural solutions must find effective feasibility with regard to composite materials and production processes. So far, helmets have generally been produced with a lay-up technique consisting of adding one layer on top of another. However, in order to generate the complex undulated outer surface, this composite manufacturing process appears to be not fully suitable. To overcome this limitation, Resin Transfer Molding (RTM) was chosen as an alternative method. This solution consists of using a closed mold in which the dry reinforcement fibres (including those providing the wave shapes) are placed in the chosen direction. In turn the resin is injected into the mold and allowed to flow over the fibres until fully impregnated. The

helmet is cured in a single operation, allowing the product to achieve the highest quality standards and obtain the desired undulated surface. This production method requires a precisely shaped mold and analysis of the resin flow in order to perform at its best. However, the process can be highly automated with high production rates, requiring limited manual work, no autoclave for curing and no refrigeration system, as opposed to other composite manufacturing processes.

Finally, the proposed concepts could be extensible and applicable to a wide range of fields in which sandwich/laminated composite panels are used, such as other parts of protective armours, underwater structures, protective shells for nuclear plants and road retaining devices.

MAIN BIBLIOGRAPHICAL REFERENCES

- [1] Abrate S., *Ballistic impact on composite*, 16th international conference on composite materials, Kyoto, 2007
- [2] Lai C., Ortiz C., *Potential applications of the natural design of internal explosion chambers in the Bombardier Beetle (Carabidae, Brachinus)*, Massachusetts Institute of Technology Master Thesis, Boston, 2010
- [3] Chatiri M., Güll T., Matzenmiller A., *An assessment on the new LS-DYNA layered solid element: basics, patch simulation and its potential for thick composite structure analysis*, 7th European LS-Dyna Conference, Salzburg, 2009

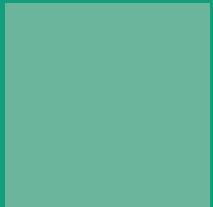

PROJECT

9

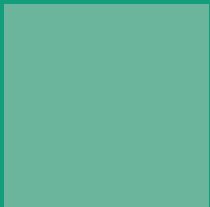
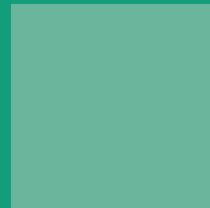

TSC4 MiTo



THE SOCIAL COMPUTER FOR MILANO AND TORINO



TSC4 MiTo

The Social Computer for Milano and Torino

project 9

Finding an urban scale problem interesting for Milan and Turin that can be formulated as a social computer computation

PRINCIPAL ACADEMIC TUTOR

Emanuele Della Valle

Electronics and Information,
Politecnico di Milano

ACADEMIC TUTORS

Tommaso Buganza

Management Economics and Industrial
Engineering Politecnico di Milano

Fulvio Corno

Control and Computer Engineering,
Politecnico di Torino

Marta Corubolo

Industrial Design, Arts, Communication and
Fashion, Politecnico di Milano

Matteo Matteucci

Electronics and Information,
Politecnico di Milano

EXTERNAL INSTITUTIONS

CEFRIEL

SenseAble City Lab(MIT)

CamCom Milano

EXTERNAL TUTORS

Irene Celino

CEFRIEL

Giampiero Masera

Camera di Commercio di Torino

Carlo Ratti

MIT - SENSEable City Lab

TEAM A

Pasquale Ambrosio

Mechanical Engineering, Politecnico di Milano

Mattia Fazzini

Computer Engineering, Politecnico di Milano

Marco Maria Pedrazzo [Team Controller
and Project Communication Coordinator]

Architecture for Sustainability, Politecnico di
Torino

Alfonso Raimo

Aeronautical Engineering, Politecnico di
Milano

PROJECT DESCRIPTION

How long does it take to locate 10 red weather balloons in 10 secret locations in the continental United States? 8 hours and 52 minutes, harnessing the Internet and social networks! This is the incredible result of the DARPA Network Challenge that was launched on December 2009. The MIT team that won the challenge designed and launched an internet-based recursive incentive recruiting method that reached almost 5400 individuals in approximately 36 hours. Finding red weather balloons may sound as a dumb problem. However, what if we could use this timely communication, team-building and mobilization techniques to solve wide-ranging, time-critical problems? People know what works well and what does not. This knowledge is not in the formal shape that can enable a computation, but it can be harnessed by means of the right combination of computational infrastructure and social incentives.

Social and Human Computation are currently being proposed by scientists in ICT and socio-economic sciences with the objective of shaping basic research in these disciplines for the next decade. They aim at extending the ICT concept of computer programming to incorporate human tasks.

Preliminary experience of Social and Human Computation includes the protein folding project (Foldit) published in Nature and Wired in 2010, while the Amazon Mechanical Turk is a preliminary setting allowing Internet users to produce tasks that are then consumed by volunteer or paid work for small-scale experiments.

Urban-scale problems are the most challenging for Social and Human Computation, due to the intrinsic presence of heterogeneous stakeholders and of complex interplays and controversies among them. The ASP project described here aimed at finding an urban scale problem of interest to Milan and Turin that could be formulated as a social and human computation and at proposing a feasible socio-technical solution that seamlessly includes social and human tasks within an ICT solution.

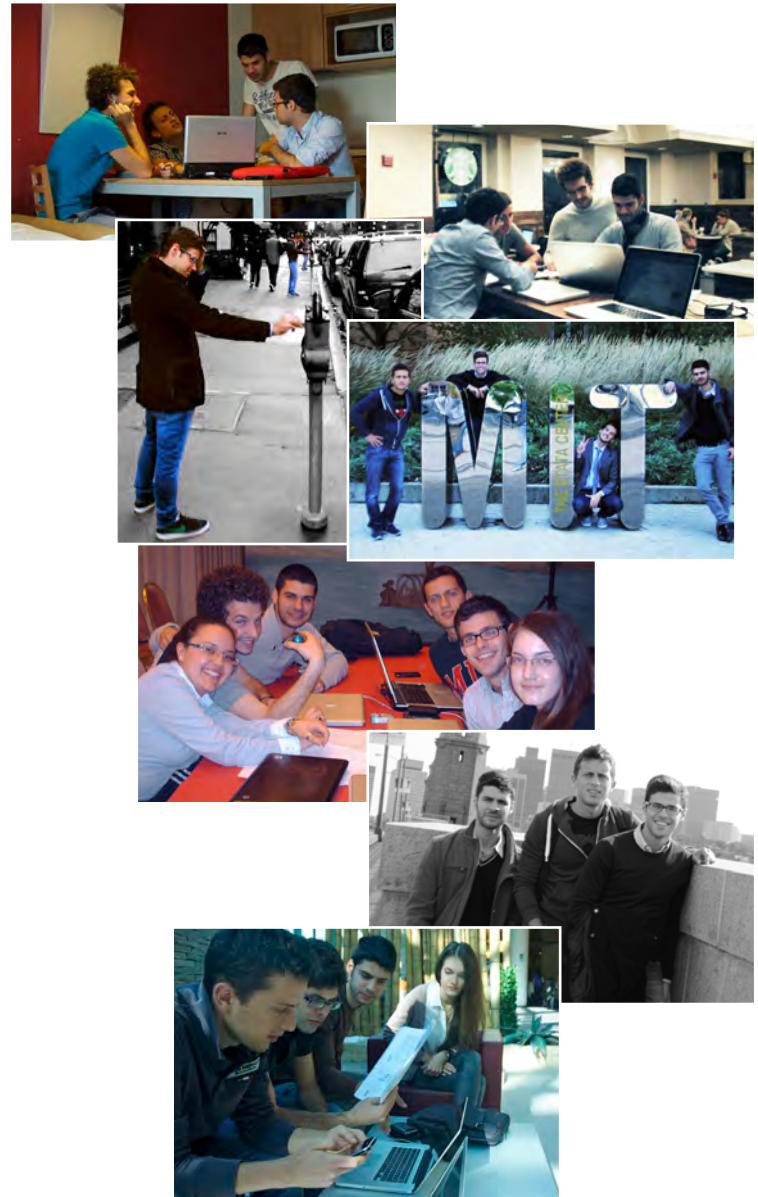



TASKS & SKILLS

Pasquale Ambrosio, after having developed a deep understanding of social computation in the SmartCity framework, contributed to turn the ParkIt concept into a technologically and economically sustainable system.

Mattia Fazzini analyzed the connections between social computing theory and urban scale problems; he contributed to the conceptualization and design of ParkItSystem and evaluated its applicability to the real world environment according to technical feasibility.

Marco Maria Pedrazzo managed the main problems of city assessment; following the withdrawal of two members of the group, he was forced to become a designer, taking care of interface design and service appeal.

Alfonso Raimo explored the opportunities offered by social computation techniques to tackle the urban problems identified and contributed to development of the business plan.

ABSTRACT

People's knowledge and capabilities can be of inestimable value when used to support computational tasks. Usually these qualities are not in the formal shape that can enable computation, but can be harnessed by means of the right combination of computational infrastructure and social incentives. The project aim was to find and propose a solution to an urban scale problem of interest to Milan and Turin that could be formulated as a social computer computation and be tested in the context of the suggested social computation technologies currently are under development, leveraging on the concepts of urban games, game with a purpose (GWAP) and social computing. The path to achievement of the project goal started by understanding the theoretical framework behind GWAPs and urban games (Figure 1-4). Through this analysis we identified what makes a game attractive and useful in the context of social computation (see Figure 1-4). The analysis culminated, with the support of the tutors, in the conceptualization of an Urban-GWAP, which combines the features of an urban game and a GWAP in a unique perspective. After having acquired a deep understanding of the technologies of interest, the team focused on identifying relevant large scale problems, specific to the cities of Milan and Turin, whose nature would match the scattering of this method of computation. The convergence of our analysis and the fields of interest of external institutions resulted in three main topics of interest:

The large concentration of small and medium enterprises with innovation potential that rarely communicate with each other

- The scarce resources available to evaluate and enhance the urban cultural heritage
- Vehicle traffic and its related problems, such as congestion, pollution and time consumption.

Through a series of meetings with project tutors, the main stakeholders and by analyzing surveys, newspapers and blogs, we identified that the most pressing and critical urban-scale problem was air pollution related to traffic congestion. For this reason, we decided to tackle the private vehicle parking problem and tried to optimize it by creating a social computer. The concept we propose is ParkItSystem, a service designed to improve current parking management practices by means of a hardware-free payment system and optimized parking search by providing directions to the nearest available parking space by means of technical innovations and an Urban-GWAP. Its feasibility was tested by participating in the Startcup Milano Lombardia, where it was selected as one of the five finalists in the area of ICT and industrial technologies.

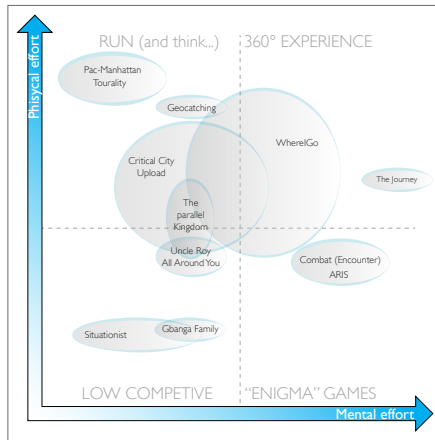

1

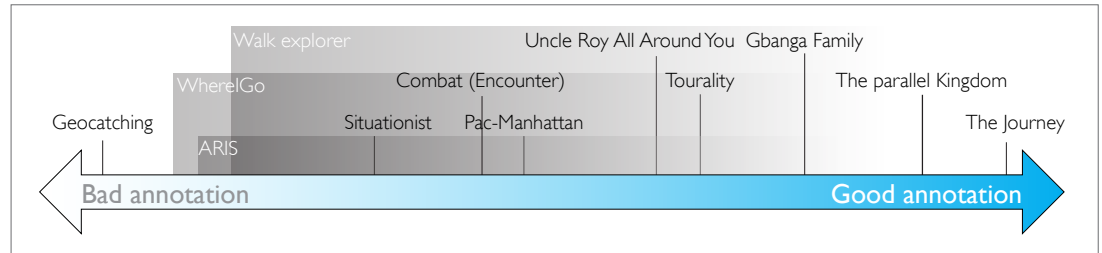

2

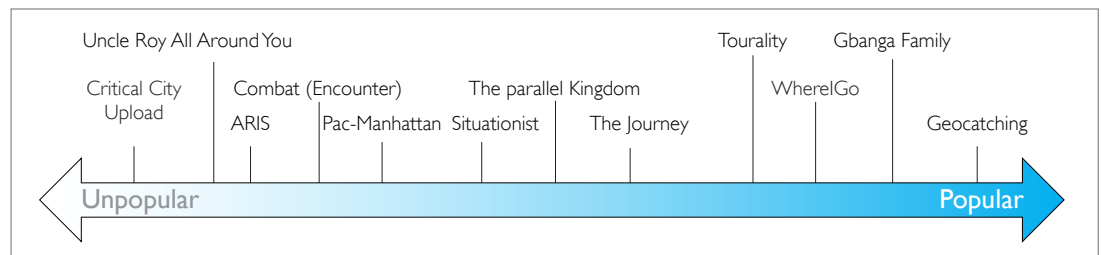

3

UNDERSTANDING THE PROBLEM

A social computer is described as a computational system which uses problem solving and information gathering powers of humans in order to tackle and solve problems which usually cannot be addressed by conventional operating systems and algorithms. Social computing is the area of computer science which deals with the interactions between social behavior and computational systems [1]. The technology at the heart of social computing must support the computations which are carried out by groups of people. There are two main ways in which people take part in such a mechanism: exchange and voluntary participation.

In our work toward exchange we focused on analysis of the technologies that leverage and support exchange of information. The technology that best represents these characteristics is smartphones. This is a direct consequence of the tight connection existing between these devices and their users. In order to leverage voluntary participation we directed our attention to games, since these can easily attract human participation and

therefore exploit the human computation ability [2]. We focused our attention on the category of games defined as GWAPs. These are human-based computation techniques, in which a computational process accomplishes its function by outsourcing specific steps to humans through amusing tasks. In this case human computation results from the interaction between players and the game platform. In order to be able to understand the relations between human interaction and data extraction, we and our tutors developed a model which can be seen in Figure 5. The model emphasizes the flow of data during a gaming experience and the interaction between the human and the game. The key steps of this model are: *pre-process*, *sense*, *think*, *act* and *post-process*. Subsequently, in order to understand how games could perform in an urban context, we decided to analyze the category represented by urban games and designed a model useful for a general analysis of urban games, as shown in Figure 6. The analysis brought us to conceive the *Urban-GWAP*. An *Urban GWAP* is a game which merges the key features of an urban game with those of a GWAP.

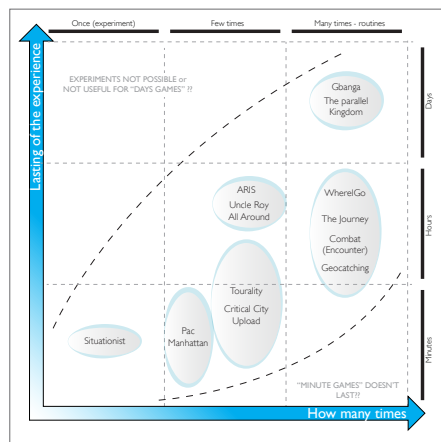

4

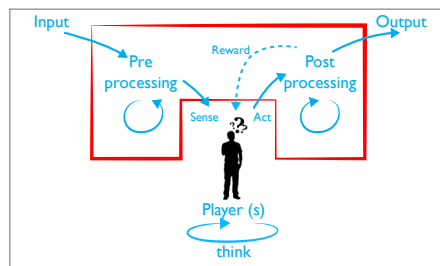

5

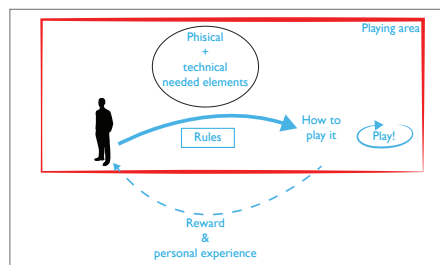

6

EXPLORING THE OPPORTUNITIES

In order to explore the opportunities offered by social computation technologies in the context of urban problems, the main features of the Milan-Turin (Mi-To) district were analyzed, resulting in identification of three main areas of interest. For each of these areas a first concept of an *Urban-GWAP* was proposed. The Mi-To district is characterized by a strong presence of small and medium enterprises (SMEs), which however lack of connections, a fundamental requirement in the highly dynamical market of recent years. The concept proposed, *BeYourManager*, is a multi-player online role-playing game which tries to simulate the industrial environment of the Mi-To district, in which each player is asked to run a virtual company that reflects the characteristics of a real company in order to exploit connection among SMEs. The second concept concerned the evaluation and exploitation of the cultural heritage typical of Milan and Turin by means of a single player, real-time, urban based image annotation game. The aim was to provide public administration with useful data to better target its scarce economic resources and a first prototype of such a game was developed (<http://www.hacku.shauvik.com>, Figure 7). In addition, we explored issues related to traffic congestion. Transportation has direct effects

on sustainability and in fact, according to [3], pollution itself is perceived as a result of traffic congestion. The data analyzed show that Turin and Milan are among the most motorized cities in Europe with its citizens not using the public transport system as in other European cities (Figure 8), despite the good service, very reasonable prices and general appreciation regarding its efficiency. Even if it is difficult to determine so scientifically, the transportation problem turns out to be the most pressing problem in Milan and Turin. Since we have to work with people and leverage their attention, we decided to tackle it by designing a social computation system called *ParkItSystem*.

GENERATING A SOLUTION

ParkItSystem (see Figure 9) is a social computer system designed to optimize the parking dynamics of large cities. The system facilitates parking tasks by taking advantage of the possibilities offered by social computational technologies related to the usage of smartphones. *ParkItSystem* integrates, in a single application, three sub-systems: *iPayIt*, *iSearchIt* and *iFindIt*. *iPayIt* is a fare payment system that removes hardware components from parking management infrastructures by allowing drivers to pay parking fees through their smartphones. When parking, users

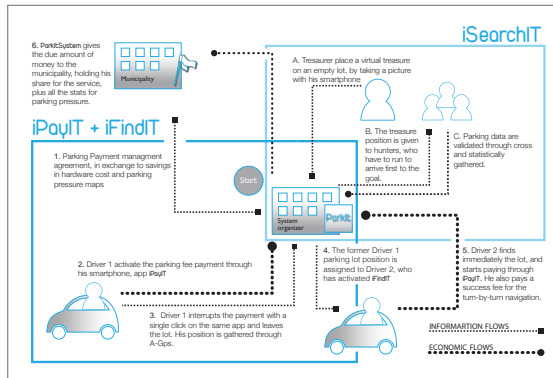

9



10

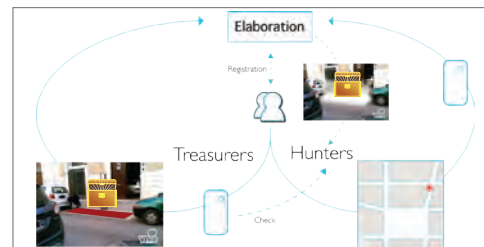

11



12

of the system can associate their cars with the parking area by using the A-GPS technology in their smartphones. Users, leveraging the same technology, express the intention of leaving a parking place and as a consequence the parking fee timer stops immediately. The payment system is categorized as fair since it allows payment of only the effective parking duration. In addition, this part of the system, relying on the mass of its users, can provide a map of available payment parking places across the city (see Figure 10). iSearchIt is the Urban-GWAP component of *ParkItSystem* and is useful to both create an initial map of non-payment parking places and provide real-time information regarding available parking places. The game resembles the gameplay of treasure hunting and is based on the constant interaction between users and a centralized computational system. Players are pedestrians who walk around the city and, using their phone cameras and positioning system, create a real-world hunting mission for other game players. There are two categories of players: treasurers and hunters. Treasurers locate virtual treasures in available parking places and create a visual representation of the location by taking a picture (see Figure 11). The aim of the hunters is to find the treasure before their competitors by taking a photo of the same parking slot in the shortest time possible.

Intrinsic rewards such as climbing the ranking and collecting virtual treasures are the drivers and incentives behind the game. The data generated by both *iPayIt* and *iSearchIt* are the source for *iFindIt*, the system designed to direct car drivers to the nearest available parking places (see Figure 11). A business plan was developed in order to investigate the economic sustainability of the entire system. The analysis suggested that the break-even point is reached during the second year of activity. The feasibility of the project was tested by participating in the start-up competition Startcup Milano-Lombardia 2012. The project won the call for ideas and, after submission of a business plan, was selected among the five finalists of the ICT and industrial technologies category.

MAIN BIBLIOGRAPHIC REFERENCES

- [1] Giunchiglia, Fausto, and Dave Robertson. "The Social Computer: combining machine and human computation." (2010).
- [2] McGonigal, Jane. "Reality Is Broken: Why Games Make Us Better and How They Can Change the World"
- [3] Panorama Siemens, Istituto Piepoli. Siemens survey: il check up alla tua città. 2011.

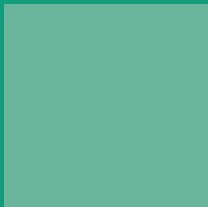
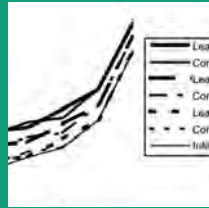
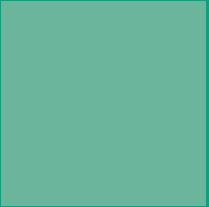

PROJECT 10

IMPARAR



**IMPROVING ACCESS TO RESOURCES AT REDUCED RISK
FOR URBAN AREAS WITH STRONG INFORMAL SETTLEMENTS:
TOWARDS SUSTAINABLE GROWTH FOR THE TOWN OF GUAYAQUIL
AND MAJOR SOCIAL INCLUSION OF CITIZENS**



IMP PARAR

Improving access to resources at reduced risk for urban areas with strong informal settlements: towards sustainable growth for the town of Guayaquil and major social inclusion of citizens

PRINCIPAL ACADEMIC TUTOR

Marina Molon

Architecture and Urban Studies,
Politecnico di Milano

ACADEMIC TUTORS

Paola Bellaviti

Architecture and Urban Studies,
Politecnico di Milano

Emanuela Colombo

Energy, Politecnico di Milano

Piero Fraternali

Electronics, Information and Bioengineering,
Politecnico di Milano

Fabio Inzoli

Energy, Politecnico di Milano

Maurizio Tiepolo

Interuniversity Department of Regional and
Urban Studies and Planning,
Politecnico di Torino

EXTERNAL INSTITUTION

Municipality of Guayaquil

Universidad Catolica de Santiago de Guayaquil (UCSG)

Escuela Politecnica del Litoral (ESPOL)

La Consolata association

Ingegneria Senza Frontiere Milano (ISF-MI)

Italian Network of Universities for Cooperation and Development (CUCS)

UN Regional Information Center for Italy (UNRIC)

Ministry of Foreign Affairs - Italian Cooperation

EXTERNAL TUTORS

Enrico Ponte

PhD student, Interuniversity Department of
Regional and Urban Studies and Planning,
Politecnico di Torino

Riccardo Mereu

Progetto Rocca Post-Doc Fellow at MIT
Politecnico di Milano and ISF-MI vice
president

TEAM A

Matteo Bolognesi [Team controller]

Management, Economics and Industrial
Engineering

Zlatina Kalaydzhieva

Architecture

Luca Maccarinelli

Architecture

project 10

The project works on a Awareness Model and an ICT Architecture for the Municipality of Guayaquil to allow participation of citizens to public problem solving

TEAM B

Giulia Borghi

Architecture

Raffaella Cocchi [Team controller and Project Communication Coordinator]

Architecture

Stefano Gallazzi

Mechanical Engineering

Francesca Mapelli

Energy Engineering

Vittoria Paramithiotti

Environmental and Land Planning
Engineering

Dimitrije Radosavljevic

Urban Planning and Policy Design

Elisabetta Rossi

Interior Design

TEAM C

Ambra Romano

Architecture for restoration and preservation
of architectural and environmental heritage

Veronica Vasilescu

Architecture for Sustainability

Stella Cattani [Team controller]

Interior Design

Andrea Cominola

Environmental and Land Planning
Engineering

Francesca Vigotti

Architecture

PROJECT DESCRIPTION

THE CHALLENGE

Resource protection management and increasing access to public services is today perceived as a precondition to human promotion and social development, especially in low income economies. The project focused on the municipality of Guayaquil (EC) which, with its 3 million inhabitants, 2 of which living in informal settlements, is the economic capital of the country. The achievements of the 2007 ASP project were used by the Municipality to start its interventions in one of the informal urban settlements. After 5 years, quality of life has been slightly improved, despite citizen inclusion is not yet fully assured. Many complexities need to be addressed and any solution identified needs to be tailored to the specific economic, political, cultural and technical context. The true challenge here lies in a creative change: assess local knowledge, increase involvement, commitment and sense of ownership within the local people.

THE TEAMS

The assessment phase was conducted with the Guayaquil Municipality. Among the problems identified with the PCM approach, only a certain number were selected as the main focus of activities.

Housing Policy and Planning

Team A focused on the impossibility for poor people to access the legal housing market, due to the high cost of bare land, high cost of infrastructures, high cost of building construction and no access to credit, affecting the quality of life and rights. The main causes are: monopolistic ownership of land, low density of settlements (also progressively destroying the natural environment), cost of materials, inelasticity of offer; no guaranty system in the relation with banks. Team A identified the most appropriate mix of strategies and practices to be included in a policy aimed at tackling the housing need of the poorest inhabitants.

Resource Management and Natural Hazards

Team B focused on waste management and risk: the inadequate collection and disposal of waste produces a sanitary risk and af-



fects the natural environment with consequences on living conditions. The project was developed in two main directions: (i) high risk of flooding and (ii) low access to public services in informal neighborhoods, mainly related to solid waste management. The main achievements are based on a sensitization campaign focused on recycling and reducing the flood risk. A risk map was built and a business plan for a social cooperative was completely designed.

Community Information System and living conditions

Team C concentrated on approaches to foster empowerment of local communities and to enhance citizen participation in the public management of their living environment. Two were the main tasks: an assessment of public services and an aggregate evaluation of the quality of life in the suburbs, focused on a number of informal services and usability of ICT and IT-supported social network tools. The main achievement is the identification of the Community Based Organization (Digital CBO) as an appropriate approach to empower local communities and improve their living conditions.

THE RESULTS

The main results of the project conducted in the informal suburbs of Guayaquil are:

- appropriate direction for future housing policy;
- creation of income generating activities for waste management while reducing the associated natural risk;
- a community based approach to foster local involvement in self-management of living conditions.

These results indicate a positive direction which ASP projects may contribute to designing in the informal suburbs of Guayaquil, while providing our ASP students with the chance to understand the complexity of Development in low income economies.



Housing Policy and Planning

IMPARAR – IMPROVING ACCESS TO RESOURCES AT REDUCED RISK FOR URBAN AREAS WITH STRONG INFORMAL SETTLEMENTS: TOWARDS SUSTAINABLE GROWTH FOR THE TOWN OF GUAYAQUIL AND MAJOR SOCIAL INCLUSION OF CITIZENS

TASKS & SKILLS

Matteo Bolognesi focused on the analysis of the housing market, the role of public institutions and, in addition, on financial strategies.

Zlatina Kalaydzhieva focused on the housing deficit at a national and local level and on low-cost construction technologies and construction strategies.

Luca Maccarinelli focused on the socio-economic causes of the housing problem and strategies to reduce the cost of land and infrastructures.

ABSTRACT

In Guayaquil (official population: 2.5 million inhabitants), according to the statistics, around 2/3 of the population live in houses that have one or more issues, which include – among others – overcrowding, lack of access to basic infrastructures (sewerage, drinking water, paved roads, etc.), low quality of construction materials and illegal house construction and tenure. These issues have been determined by a long-standing disparity between the needs of low-income families and that actually offered by the housing market. Over the course of the past decades, public institutions, such as the Ecuadorian Ministry of Housing and the Municipality of Guayaquil, have launched a number of policies to address the housing problem, but investments have been low and incorrectly addressed to wealthier families rather than those in real need.

Therefore, the focus of our team was the housing problem and the proposal of a set of strategies that could be potentially adopted by public institutions to address it. In the first part of the work, we proceeded with a preliminary research, supported also by the two missions in Guayaquil, aimed at identifying the main factors determining the issues, the principal actors involved and the measures that could highlight the significance of the issues previously illustrated. This provided a sufficiently clear picture of the current scenario – supported by quantitative data – and of the main factors that could improve the affordability of housing solutions offered by the market. Finally, we did not suggest a single optimal solution, which probably does not exist, given the political, legal and social implications concerning interventions in housing-related markets and the lack of true cooperation with the actors involved. We therefore provided a range of possible strategies that could be adopted by new housing policies in Ecuador in order to address the housing problem in a more efficient and effective manner.



1 Isla Trinitaria, Flooded Streets



2 Isla Trinitaria, Bamboo House



3 Isla Trinitaria, Shacks

UNDERSTANDING THE PROBLEM

The first step of the project consisted of understanding the different aspects of the “housing problem” and how it affects the life of the people living in Ecuador and, in particular, in the city of Guayaquil. To reach this objective, our team attended a number of seminars organized by the Tutors and other experts, collected socio-economic data from international and local sources and researched relevant literature on the topic. During the two missions to Guayaquil – in October 2011 and April 2012 – we also had the opportunity to collect other important data that would have been difficult to collect otherwise and, more importantly, feel directly observe the problem and how public institutions are addressing it.

This provided an understanding of the main aspects of the housing problem:

- Overcrowding. It is estimated that at least 50% of the houses in Guayaquil are affected by this problem;
- Low quality of construction materials and techniques. For instance, in the suburbs of Guayaquil, the houses made of concrete/iron frames and blocks would not be solid enough to resist earthquakes, which is a problem in a seismic area such as

Guayaquil;

- Illegal house construction and tenure. In the outskirts of Guayaquil, houses have been informally built on land sold by illegal land dealers. This situation is slowly changing, but it still represents a source of concern for the inhabitants.
- Lack of infrastructures, in particular regarding acceptable roads, legal and safe access to drainage, sewerage, electricity and drinking water. In particular, only 40% of houses in Guayaquil have access to the sewerage system.
- Lack of services.
- Unsafe context. In addition to the previous problems, which have a quantitative dimension, other issues affecting the quality of life of the citizens are related to housing, such as the social segregation of the inhabitants of the informal settlements from the rest of the city or other environmental issues, such as the air contamination and flooding during the rainy season.

EXPLORING THE OPPORTUNITIES

Looking at the housing market in Guayaquil, the picture does not look good. First of all, land is very expensive since it is con-

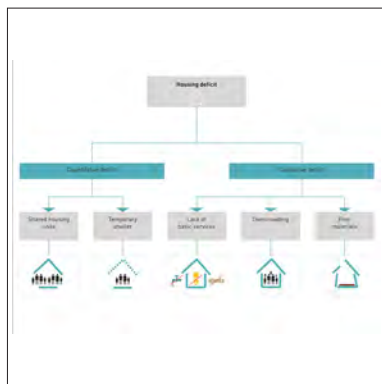

4 Housing Deficit 1



5 Housing Deficit 2

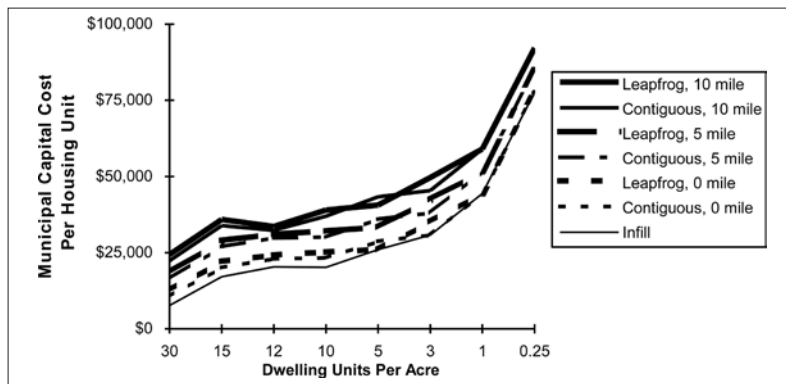

6 Scheme of municipal costs

trolled by a handful of families. Secondly, private construction companies are not interested in offering low-cost housing units since they are already serving a growing demand coming from wealthier market segments, which certainly provide more profitability than the lowest segments. Furthermore, access to credit in Ecuador is quite difficult, especially for the poorer families, who usually do not have a constant source of income and do not have any assets to guarantee their loans. Moreover, real interest rates applied by Ecuadorian banks are around 12%, which would in any case make any loan economically unsustainable for a poor family.

With the aim to bridge this gap between supply and demand, public housing policies in Ecuador have been created in recent decades, but have failed to reach the poorest strata of the population, since they have mostly provided benefits to the middle class. What is more, average government spending in housing over recent decades has been extremely low in comparison to other Latin American countries. In addition, the existing mechanisms of dealing with the housing problem in Guayaquil are such that the Municipality dedicates a significant part of its budget to bringing infrastructures to the informal settlements, while this is money could be spent more effectively with properly planned policies. In addition, it is the illegal land dealers and landowners who have usually benefited the most from mu-

nicipal investments.

These characteristics of the current scenario have therefore allowed us to understand the opportunities that could be exploited to improve the situation and the corresponding objectives, which are:

1. increase the supply of low-cost land in the housing market;
 2. reduce the cost of infrastructures;
 3. increase the supply of solutions that reduce construction-related costs;
 4. increase access to credit of housing market agents, in particular low-income home buyers;
 5. improve the quality of settlements (services, public spaces, etc.).
- Some relevant examples of strategies and technologies adopted in other countries related to these aspects were studied, in particular regarding the potential benefits which could be achieved. Other types of policies that have been experimented or recently implemented in other countries, such as policies promoting rent, appear to be difficult to apply in Ecuador at the moment.

GENERATING A SOLUTION

The concept representing the starting point of our proposal is a housing policy whose offer can be economically competitive with those available in the illegal market, which are currently the only affordable solutions for families below the poverty line.



7 Ciudad Victoria



8 Mucho Lote



9 Socio Vivienda school

The city of Guayaquil could be a useful case study for identifying strategies able to modify housing and land market mechanisms. These strategies also could work for other big cities in Ecuador, where similar mechanisms are in place, albeit with the necessary specificity.

Since it would be meaningless to provide a single “optimal” solution without true cooperation with the public institutions and the other stakeholders involved, as well as due to all the other implications that may affect the feasibility and the effectiveness of the strategies, it was decided to propose a number of possible options, or scenarios, on how to address the housing problem. All of these options comprise of a series of strategies that affect the aforementioned aspects, i.e. land, construction and access to the credit market.

These strategies call for mixed approaches, comprising both direct public interventions and market regulations, with the aim to bring low-income families back to the legal market, thanks to a flexible process mirroring what currently takes place in the illegal market.

In particular, the proposed strategies include:

- norms that force landowners to increase the supply of low-cost land in the market;
- selection of areas for new settlements that are suitable for reducing infrastructure costs and are fit for increasing density;

- actions aimed at increasing the offer of low-cost materials, especially by encouraging the use of local products;
- projects that offer houses that can be expanded over time, with technical support to guarantee construction safety;
- support to self-help, progressive and collaborative construction;
- public coverage of low-income family loans;

A cost-benefit analysis of the different options was performed considering the points of view of all the main stakeholders involved, not just the low-income families, since economic feasibility (for public institutions) and profitability (for private companies) significantly affect the level of commitment of these actors and thus the success of these policies.

MAIN BIBLIOGRAPHIC REFERENCES

- [1] World Bank, World Development Indicators 2012. Manchester, UK: ESDS International, 2012.
- [2] G. A. Mera, “Illegal settlements in Guayaquil, and the proposal to compete with them” 2009.(http://www.hdm.lth.se/alumni/alumni_papers/by_region_and_country/latin_america/ecuador/)
- [3] L. Marcano, “La Política de Vivienda Social y su Impacto en el Bienestar: el caso de Ecuador”, Technical report, Inter-American Development Bank, 2010.

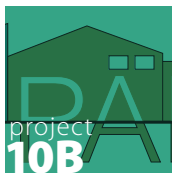

Resource Management and Natural Hazards

IMPARAR – IMPROVING ACCESS TO RESOURCES AT REDUCED RISK FOR URBAN AREAS WITH STRONG INFORMAL SETTLEMENTS: TOWARDS SUSTAINABLE GROWTH FOR THE TOWN OF GUAYAQUIL AND MAJOR SOCIAL INCLUSION OF CITIZENS

TASKS & SKILLS

Giulia Borghi carried out the general assessment of resources (energy, water and waste) and also worked on the design of the sensitization campaign.

Raffaella Cocchi coordinated the flood risk assessment and carried out the graphic processing of the Guayaquil Risk Map using Geographic Information Systems.

Stefano Gallazzi developed the business models for the recycling cooperative; his knowledge was essential for the corresponding technical-economic feasibility study.

Francesca Mapelli studied problems and objectives with the aid of Project Cycle Management tools. She also contributed to the energy assessment of the areas analyzed.

Dimitrije Radosavljevic carried out the methodology assessment for the flood risk analysis and participated in the design of the sensitization campaign.

Elisabetta Rossi coordinated the sensitization campaign during the entire project development. She was also responsible for the general layout of the report.

Vittoria Paramithiotti mainly worked on the flood risk analysis, gathering and evaluating data in order to create the Guayaquil Risk Map.

ABSTRACT

IMPARAR project (Team B) focused on the management of energy, water and waste resources and natural hazards. Complex multidisciplinary problems are addressed and narrowed down by isolating three key target areas of intervention: (i) rain flood risk management, (ii) solid waste disposal and (iii) sensitization campaign.

With regard to rain flood risk management, this addresses the problem of extreme rainfall events in combination with the issues of the fast growing informal settlements in the municipal outskirts. Since the presence and performance of infrastructures has proved to be insufficient for the current flood risk level, a risk management strategy must be improved. A participative risk assessment model is therefore proposed in order to help increase overall awareness and support the decision making processes in future.

As far as natural resources are concerned, the project focused on the management of solid municipal waste, which in turn appears to be particularly interlinked with the socio-economic conditions at the specific small territorial scale. Today only 8% of solid waste is recycled in Guayaquil by municipal recycling centers, which mainly rely on the informal (and mostly illegal) network of “*recicladores*” solid waste suppliers. The IMPARAR project proposes a neighborhood-based recycling cooperative, whose goal is to provide a formal organization, avoiding the obvious problems related to an informal approach, and to increase the level of benefits for the community itself (e.g., clean the neighborhood, make a profit).

The sensitization campaign is aimed at an upper level goal, to which both the previous parts contribute, which is related to the input for creation of a “community sense” (an issue developed by IMPARAR team C) by simultaneously (i) working on dissemination and participation methods in order to raise awareness and (ii) working on prevention measures. It both responds to the demands of local public actors and creates the necessary background for the previous two project components.

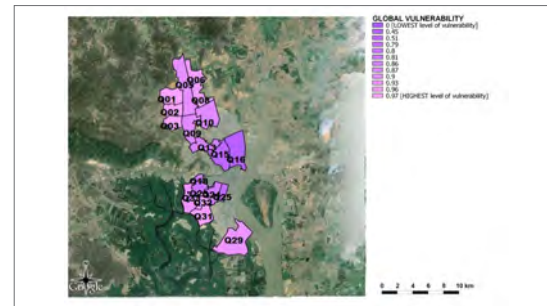
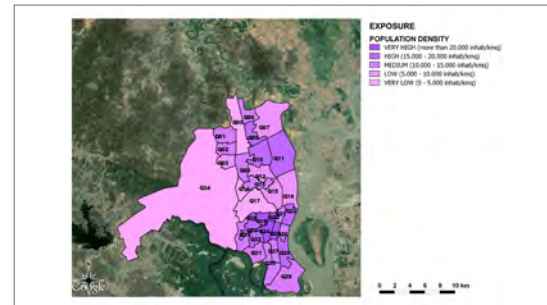
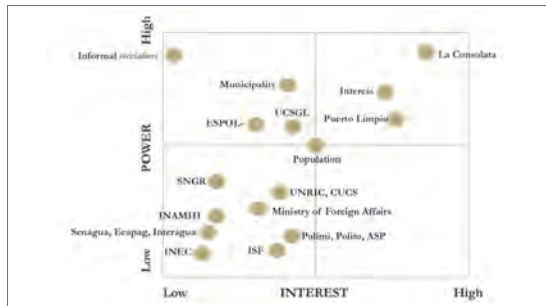
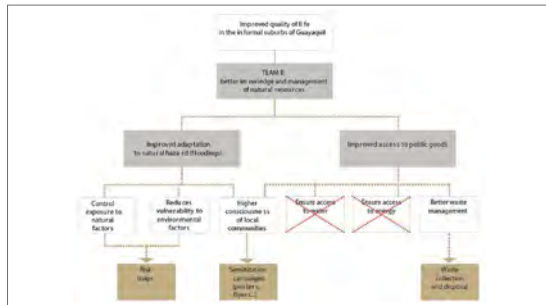

UNDERSTANDING THE PROBLEM

The team worked on the “poor knowledge and management of natural resources”. Following full identification of the causes of the problem, two were evaluated as being manageable by the team: “high risk of natural hazard”, mainly related to flooding, and “low access to public resources”, in particular energy, water and waste.

Moreover, since the two causes are still very broad, the team decided to refer specifically to those which are considered to be significant by the local population in their daily life.

As far as natural hazards are considered, the **rain-flood hazard** is analyzed in depth, since it affects the entire city of Guayaquil, including the poorest neighborhoods such as *El Fortin*, where the project was carried out. In such areas, the situation is worsened by the informal nature of the settlement, which prevents significant interventions and control by the Municipality.

As far as natural resources are concerned, preliminary and field analysis showed that water and energy are already available to the population, or that the Municipality is planning to guarantee access by the entire city by the end of 2013. On the

other hand, **waste** is poorly managed in the informal neighborhoods: people often dispose of garbage in the streets or burn it, while the collection trucks do not reach all the areas, due to the poor conditions of the streets. Moreover, waste represents an hygienic problem, as well as an obstacle to water drainage and therefore also an increased risk of flooding.

From a broader point of view, a common problem is the low general **awareness** of the population which is not used to act as a community with common interests: field surveys showed that people do not perceive water flooding and waste management as real problems, since they are used to their poor living conditions. As a consequence, they do not react to tackle these issues and therefore a sensitization process is required.

EXPLORING THE OPPORTUNITIES

In order to assess the risk related to natural events (such as heavy rain), it was necessary to use a quantitative approach, including different elements (social, environmental, infrastructural...) in one single solution. Therefore, **risk maps were created**, based on four factors: hazard, vulnerability, exposure and adaptation.

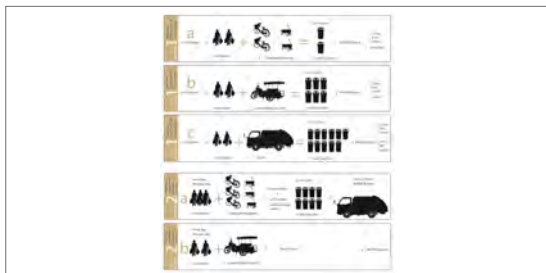
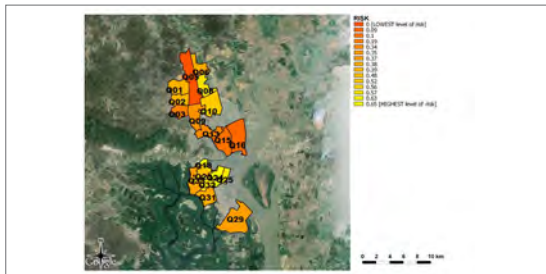

Similar maps already exist and are used by the Municipality’s Department for disasters and prevention. As an innovative contribution, IMPARAR provided a more transparent methodology, evaluating a broader variety of natural and socio-economic aspects and creating the possibility for the population to interact, since maps are open-source and could be improved at the local level.

As far as waste management is concerned, cleaning the neighborhood requires scalable solutions involving local people and able to sensitize them. Since the problem is strongly related to the population’s behavior, social participation is key to the success of the project. Similar problems have been faced in other Latin American developing countries, where **associations for collecting and recycling waste** improved the collection system and also created job opportunities and generated income.

Increasing people’s awareness is another important challenge that affects all the other problems under analysis and the entire IMPARAR project. A variety of case studies were analyzed: mascots and activities in schools (to educate the younger generations); associations of citizens organizing voluntary cleaning; “motivators” (workers who distribute flyers to inform families

Scenario 1				Scenario 2			
	a	b	c	a	b	c	
Number of bins	2	6	31	8	0	0	
Cost of bin	60	180	330	240	0	0	
Number of bikes/wheelbarrows	2	0	0	3	0	0	
Cost of bikes/wheelbarrows	80	0	0	130	0	0	
Number of powered bikes (tricycles)	0	1	0	0	1	0	
Cost of powered bikes (tricycles)	0	1000	0	0	1000	0	
Total investment (\$)	140	1180	330	370	1000	0	
Number of workers	2	2	2	2	2	2	
Workers' wage (\$/month)	300	300	300	600	400	400	
Number of trucks	0	0	1	1	0	0	
Cost of trucks (\$/month)	0	0	416,6667	416,6667	0	0	
Consumption of gasoline (l/month)	0	12	2,25	7,5	0	0	
Gasoline (\$/month)	0	204	3,825	12,75	0	0	
Cost O&M (\$/month)	0	30	50	50	30	30	
Variable costs (\$)	300	350,4	770,4917	1079,417	557,5	0	

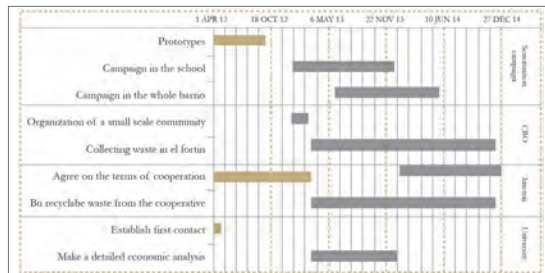

about garbage disposal). Some of these solutions have been also developed in Guayaquil and all of them share the common goal of increasing the **direct involvement of the population in order to empower their capacity as a community**.

GENERATING A SOLUTION

Three main solutions were proposed:

- **Risk maps:** a participative risk assessment tool was built using a straightforward equation. A general risk factor combining different indicators is calculated:

$$R=V \times E \times H/A$$

The Global risk factor (R) is estimated for each area proportionally to its level of Vulnerability (V), Exposure (E), and Hazard (H). The level of global risk is then reduced based on the presence and quality of Adaptation measures (A). A spatial analysis of Vulnerability and Exposure factors was carried out using the available relevant information. Poverty level, household conditions, sanitary services, and waste disposal practices are representative of the level of Vulnerability, while population density is used as the unique Exposure indicator. The Hazard factor consists essentially of a statistical analysis



9



10

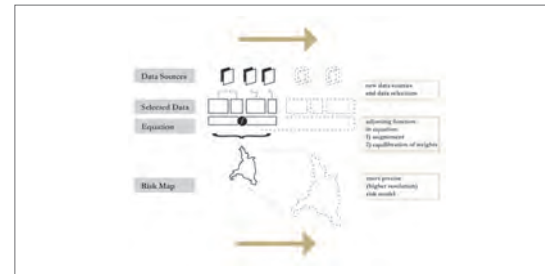

11

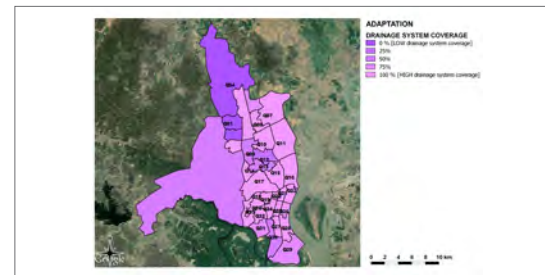

12

of rainfall occurrence and magnitude at the city scale. Finally, the Adaptation factor is spatially evaluated through the presence of the drainage system. Building the model and acquiring new data through participation of local actors is crucial. As an example, more detailed information on the capacity and quality of the drainage infrastructure could significantly increase the model's precision in the years to come.

- **Recycling cooperative:** the idea of creating a small business through a social cooperative, based at *La Consolata* school in *El Fortin*, whose role is to collect recyclable waste and sell it to a local recycling company, is considered. In particular, plastic bottles will be collected; the initial investment will be very low and the solution may be highly flexible and expandable to the entire neighborhood. Two business scenarios are studied in detail: waste collection only at the level of the local school, thanks to students collecting plastic bottles every day, or collection in the whole *El Fortin* area, thanks to two waste-collectors that collect waste door-to-door. In both cases, the economic analysis shows that this activity might be convenient, also taking into account the costs of the tools required (e.g., truck, storage containers) and workers' wages (which

are fair in relation to the context). Indeed, the evaluated Pay Back Time is only a few months for both models (less than one month for the first, and roughly three months for the second). Advantages include not only cleaning the streets but also generating jobs, income and sensitizing local people.

- **Sensitization campaigns:** in order to increase awareness of the local population of the many problems of the informal settlements, sensitization campaigns were designed. A participatory design is required, since it guarantees a more efficient campaign, as well as a comprehensive educational strategy. Therefore, the methodology used during the entire project was based on continuous interaction with the local population, for instance by means of focus groups. The title of the campaign was "*Mejorando El Fortin*" (Improving *El Fortin*), a friendly iguana was chosen as mascot and gadgets (origami, pins, pencils...) were created. During the second trip to Guayaquil, all these ideas were directly discussed and tested with the children, their families and teachers and the feedback was positive. Future developments may include the creation of new slogans and inclusion of other issues affecting the informal settlements.



Community Information System and living conditions

IMPARAR – IMPROVING ACCESS TO RESOURCES AT REDUCED RISK FOR URBAN AREAS WITH STRONG INFORMAL SETTLEMENTS: TOWARDS SUSTAINABLE GROWTH FOR THE TOWN OF GUAYAQUIL AND MAJOR SOCIAL INCLUSION OF CITIZENS

TASKS & SKILLS

Stella Cattani mainly worked on the Stakeholder analysis, Digital Tool and Time Banking graphic design of interfaces and project logo. She interacted with local stakeholders in October 2011.

Andrea Cominola mainly worked on the living conditions and services analysis and on the Time Banking system design. He interacted with local stakeholders in April 2012.

Ambra Romano worked on existing the state of the art approaches and on integration of the different solutions, developing a general feasibility of the project. She interacted with local stakeholders in April 2012.

Veronica Vasilescu mainly worked on open software, communication tools and human computation analysis and on Digital Tool design. She interacted with local stakeholders in October 2011.

Francesca Vigotti worked on data collection analysis and CBO system design. She interacted with local stakeholders in October 2011 and conducted the in-situ bibliographical research on living conditions.

ABSTRACT

Living conditions in informal settlements, such as that where the IMPARAR Team C project was developed (*El Fortin*, Guayaquil) provide several challenges. For this reason, analysis of the existing complex context proved essential in order to acquire awareness of the most urgent issues related to the low quality of the environment, reduced availability of public services and lack of social inclusion. Team C invested the first and part of the second year on the analysis phase; during the two missions to Guayaquil, the interactions with the main local stakeholders were fundamental in order to identify and comprehend the general problems to be investigated: lack of management strategies for informal settlements, which led to the absence of specific information systems and intervention plans, and deficiency of effective communication between the Municipality and the population of the barrio.

Hence, at the end of the analysis phase, taking into account the specific topics addressed by the project, Living Conditions and Open Source Technologies, Team C identified the following specific objectives:

- increase citizen awareness on their living environment, its problems and resources, and improve accessibility to public services through social mobilization initiatives;
- increase territorial data availability and improve communication and participation for management of the informal district using ICT technologies.

Thus, the team proposed different solutions that are strictly inter-related and require mutual cooperation: a Community Based Organization (CBO) approach which exploits a Time Banking system and a Digital Tool system for communication and data availability through social mobilization.

The possible results that could be achieved through implementation of these proposals are the creation of a two-way communication-intervention system between institutions and the population, which will also lead to the enhancement of social awareness and data availability, taking into consideration the specific requirements of all stakeholders.

Moreover, the solutions presented could be considered as innovative in the context of an informal settlement in a Latin American developing country, since similar experiences require involvement of the local population in very complex areas, from the social, cultural and economic point of view.



1 The poorest part of the informal 'El Fortin' neighborhood, 'La Cordillera del Condor'
The image shows a "tricycle", one of the most popular vehicles used in informal settlements. The poorest houses are made of bamboo panels and clay bricks



2 One of the main streets of 'El Fortin' in the morning with mothers and children.
The public spaces are almost absent in the barrio, except for small pieces of land in front of the houses



3 The informal market of "El Fortin" in one of the main streets called 'La Ocho'.
The market is the most important commercial activity in informal settlements

UNDERSTANDING THE PROBLEM

The objective of the project was to study the living conditions and availability of territorial data for the informal districts of Guayaquil, highlighting the relevant problems and proposing improvements. Starting from a general analysis of the living conditions in Guayaquil, mainly based on literature review, statistic datasets and data retrieved during the first mission to Guayaquil (October 2011), the team defined the spatial boundaries of interest for the project, identifying the El Fortin district as the project area, as well as the main stakeholders. The Project Cycle Management framework was then adopted in order to hierarchically identify the main problems to be addressed in the project, and consequently list the objectives and elaborate an appropriate strategy for their achievement.

The previous analysis and interaction with local stakeholders (both institutional and not), performed during the first year of the project, allowed the team to identify the general problems to be explored, i.e. low access to services and low data availability for informal districts such as El Fortin.

Specific additional activities and analyses were then carried out,

in order to investigate each of the problems mentioned, identifying the causes. In particular, the following analysis activities were performed:

- Focus groups on sensitive issues with the local community and meetings with institutional stakeholders;
- Analysis of existing data collection systems for territorial data, with corresponding cost of usage;
- Analysis of use of the Internet and social networks in the local community.

As a result of these activities, the causes of the general problems addressed by the project were identified to be the primarily low public awareness on services and low interaction between institutions and the community, high cost of field activities for data collection and low exploitation of new media.

The problem setting phase was carried out in parallel with a stakeholder analysis, the result of which was a complete listing of stakeholders affected by the project issues, described in terms of their needs, level of interest and level of influence and power (i.e. possibility of action for project solution implementation).



4 Logo of Team C's project

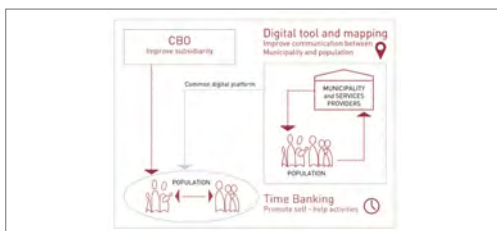

5 The scheme shows the relation between the different tools of the project developed by Team C. The CBO and Digital tool with digital mapping are the main tools, while Time Banking is a specific instrument of the CBO

EXPLORING THE OPPORTUNITIES

A strategy was elaborated in order to propose a number of improvements as an answer to the problems, based on the following elements:

- Involvement of local entities, such as La Consolata School;
- Promotion of mutual exchange of personal skills and capabilities;
- Exploration of the potential of new media for social mobilization;
- Participatory approach for implementation of project solutions, in order to involve local stakeholders, both institutional (such as the Municipality) and not, such as citizens.

A state of the art of existing solutions to problems similar to those of the project, and with principles similar to the strategy, was built; in particular, attention was focused on experiences for social empowerment, such as Community Based Organizations (CBOs), “Contratto di Quartiere” and Time Banking Systems, or digital community management systems, both for digital mapping (e.g. Map Kibera project) and reporting (e.g. Waze).

Despite the large number of experiences investigated in the state of the art, the team faced a number of important challenges in order to propose a project solution. In particular:

- Given the peculiarity of the context, significant effort was dedicated to adapting some of the possible solutions to the

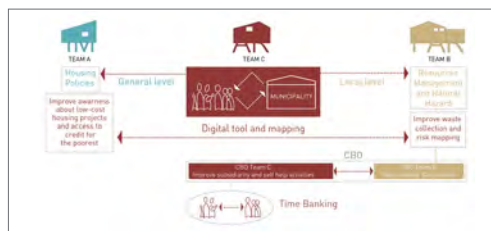

6 The scheme shows the relation between the solution proposed by Team C and those developed by the other IMPARAR Teams



7 The picture shows the home page of the interface of the Digital Tool that allows users to choose between the Digital Tool and mapping or the Time Bank activities. The image also shows the name of the Tool, "imparAPP"

El Fortin environment, since existing solutions are related to Developed, or Underdeveloped Countries, but with different situations compared to El Fortin;

- Even though the design of a unique solution for all the problems considered was not possible, the team tried to propose harmonious solutions that could integrate well with each other and, by acting on specific problems, provide improvements to the general problem faced by the team, i.e. improved awareness and management of environmental and social conditions in the informal district of El Fortin.

PROPOSING A SOLUTION

The improvements proposed by the team comprise the design of three elements:

- Digital Tool System for empowerment of communication and data availability;
- Community Based Organization (CBO);
- Time Banking system.

In particular:

- The Digital Tool is a web application designed to support the CBO work by supporting two different functions: data collection and information diffusion. As for the first function, the local population provides important data to the Municipality, saving human and economic resources. Data comprises warn-



8 The image shows the relation between the main interfaces of the Digital Tool and mapping instrument. It is a scheme of the most important activities that the user can perform



9 The image shows the relation between the main interfaces of the Time Banking instrument. It is a scheme of the most important activities that the user can perform

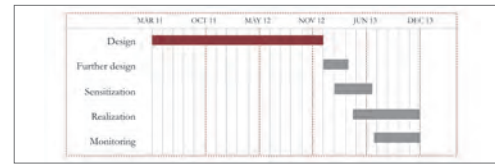

10 The table shows the timeline of project activities

ings on risky situations in the barrio (e.g.: flooded streets), information supporting the *recicladores* cooperative activity (e.g.: mapping waste collection points) and data on activities and initiatives of existing community organizations. Public Administration can use the second function in order to interactively communicate with the community. The tool will also provide a digital interface to the Time Banking system;

- CBO is a non-profit organization that acts at a local level in order to enhance the quality of life of citizens by meeting their needs, since it assumes a bottom-up approach. The main objective of CBO is to create and empower social equality, improving representativity and promoting exchange of services and knowledge. It would be both a reference for the inhabitants of the districts, who are the real components of the organization, and also a warehouse of information, data and local issues, which will be successively catalogued, arranged and then made available to the Municipality;
- The Time Banking system is structured like a bank in which every member has an account: the only difference resides in the fact that, instead of money, the credit deposited is time. Such a system would allow its members to share their personal skills and capabilities, being time the measure of the exchange. It would improve human resource sharing and availability and contribute to building the CBO spirit.

The three proposals address the problems taken into account, since social awareness and communication are empowered and an advantageous alternative system for data collection is provided. The main innovative feature of these three proposals is the fact they are adopted in the informal context of a Developing Country in Latin America, while in particular for the Time Banking system and the Digital Tool, similar experiences exist mainly in Developed Countries or in few other developing countries with different contexts. Moreover, an element which is at the same time a challenge and a base for the solution is provided by the bottom-up approach, since local stakeholders, and in particular the local community, are directly responsible for implementation of the proposed approaches.

MAIN BIBLIOGRAPHIC REFERENCES

- [1] European Commission, Project Cycle Management Guidelines, EuropeAid Cooperation Office, Development DG, Brussels, 2004.
- [2] Un-Habitat, The challenge of slums, global report on human settlement 2003, Earthscan, London, 2003
- [3] Fraternali P., Castelletti A., Soncini-Sessa R., Vaca Ruiz C., Rizzoli A.E., *Putting Humans in the Loop: Social Computing for Water Resources Management*, Elsevier, 2012.

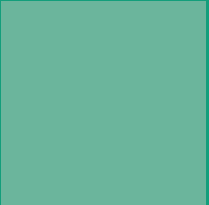
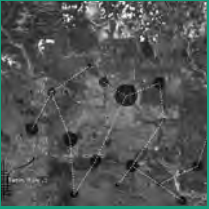

PROJECT

11

E-SCAPE



**NEW TOOLS AND NEW OPPORTUNITIES
FOR THE LOCALIZATION OF EXPO 2015 GENERAL INTEREST
SERVICES ALONG THE CANALE CAVOUR,
A BACKBONE OF THE MILAN-TURIN URBAN REGION**



E-SCAPE

New tools and new opportunities for the localization of Expo 2015 general interest services along the Canale Cavour, a backbone of the Milan–Turin urban region

PRINCIPAL ACADEMIC TUTOR

Andrea Rolando

Architecture and Urban Studies,
Politecnico di Milano

ACADEMIC TUTORS

Flavio Boscacci

Architecture and Urban Studies,
Politecnico di Milano

Alberto Colorni

Industrial Design, Arts, Communication and
Fashion, Politecnico di Milano

Alberto De Marco

Management and Production Engineering,
Politecnico di Torino

Fabrizio Leoni

Architecture and Urban Studies,
Politecnico di Milano

Corinna Morandi

Architecture and Urban Studies,
Politecnico di Milano

Chiara Ocelli

Architecture and Design, Politecnico di Torino

Riccardo Palma

Architecture and Design, Politecnico di Torino

Mario Sassone

Architecture and Design, Politecnico di Torino

EXTERNAL INSTITUTION

Telecom Italia

CoMoDo - Confederazione per la Mobilità Dolce

Coutenza Canale Cavour

Ente Parco fluviale del Po tratto torinese

EXTERNAL TUTORS

Claudia Baratti,

Coutenza Canale Cavour

Andrea Bragagnini

Telecom Italia

Albano Marcarini

CoMoDo

Ippolito Ostellino

Ente Parco fluviale del Po Torinese

TEAM A

Benedetta Giudice [Team controller]

Territorial, Urban and Environmental Planning

Davide Mezzino

Architecture for Sustainability

Cristiana Oggero

Territorial, Urban and Environmental Planning

Giovanni Castaldo

Architecture

project 11

E-SCAPE: Telecom provided services to transform the Milano-Torino territories crossed by Canale Cavour into a Smart Region for Expo 2015

Tijana Djordjevic

Urban Planning and Policy Design

Michele Giusto

Computer Engineering

TEAM B

Federica Bonavero [Team controller]

Territorial, Urban and Environmental Planning

Simona Valenti

Architecture for Sustainability

Lucia D'Amato [Project Communication

Coordinator]

Architecture

Doaa Ismail

Architecture

Federica Remondi

Environmental and Land Planning

Engineering

Bogdan Stojanovic

Architecture

PROJECT DESCRIPTION

THE CHALLENGE

The recent completion of the high speed railway in the north west of Italy is producing significant changes in the entire territorial system, establishing a difference between the nodes of Milan and Turin, positively connected to the “long” (and fast) networks of mobility, and the intermediate places that suffer from disadvantages due to their location on the pre existing “short” (and slow) networks.

Innovative uses of communication technologies and of personal mobile devices can contribute to re-balancing the territory, providing new services especially addressed to permanent and temporary users of the in-between territories, which could in this way regain advantage from the fact of being characterized by high spatial quality and positively slow life style.

The cities and the territories related to the rice fields along the Canale Cavour, particularly in the area around the city of Novara, have therefore been chosen as a physical and symbolic case in order to study the problems of a unique agricultural landscape, perfect context to experiment the role of innovative services to enhance the relationship between people and places, according to the theme of the Expo 2015 event “feeding the planet, energy for life”.

Within this framework, the E-scape project studied possible solutions to verify how interfaces (such as NFC devices and other sensors) located in significant places in the territory can provide useful information and promote a better relationship between people and places, provide new opportunities for work and leisure, in particular in medium-size cities (Ivrea, Vercelli, Biella, Novara and others) and therefore produce an effective complementary integration with the main centers (Milan and Turin).

The project therefore aims to understand and manage two main issues:

- Define a number of significant sites located along the Canale Cavour, with a view to enhancing the relationship between people and landscape, also developing slow mobility paths and nodes that can play a role as services of general interest. The general aim is to work on the “slow” territories related to the Canale, in order to connect them to the sites and networks that are the subject of Expo 2015, following the idea of a diffused event based on the direct experience of places.
- Explore how the use of innovative technologies could produce new behaviors, support and (possibly) even drive physical territorial change, in a vision where the sites (and the people) located along and somehow attached to the geographic “backbone” of the Canal can play an active role.

THE TEAMS

The project was developed by two teams, who worked in close cooperation while focusing their work on two distinct issues:

- Team A “EscApp”
Design an application for mobile terminals that can re-elaborate the idea of interface between people and places, using an innovative idea of a map that is adaptable to user needs and can be implemented by the users themselves,

also by recording (according to a bottom-up process) new places of interests and tracks corresponding to new and unexpected routes.

- Team B “Escape”
Propose an innovative approach to mapping (on a top-down basis) to allow and enhance interaction between people and places, considering that people are moving in a changing landscape, with specific characteristics which vary according to internal (i.e. presence of water in the rice fields) and external (i.e. weather conditions and visibility) factors, also using sensors and information provided by users.

THE RESULTS

The result is a service, consisting of an innovative mapping procedure to be used as an interface for personal mobile terminals and which enables, in this actual case, the production of customized information, adapting the data related to a changing landscape to the personal needs of mobile users. A secondary but not less important result is the attempt to use ICT as a tool that can contribute to reestablishing the value of direct experience (and exploration) of places that might be left of the beaten track of the main directions of development.

CONTRIBUTIONS

Andrea Bragagnini of Telecom supported the students of both teams in understanding the use of Near Field Communication devices, their interaction with mobile communication terminals and the issues related to smartphone application design.

Ana and Cesare Tromellini of Cascina San Maiolo in Novara provided most useful information about their Cascina, its relationship with the urban and agricultural landscape and the essential role that such places and activities could play, in particular considering the experience of the Expo 2015 themes.

Claudia Baratti of Consorzio di Irrigazione Est Sesia, supported the project with in-depth knowledge on the Canale Cavour and the complexity of the rice field landscape.

Albano Marcarini and Ippolito Ostellino contributed with seminars on the development of the project.

An important input for the project was provided by a study tour to the Ruhr region and to the Netherlands, where we had the opportunity to meet actors from important institutions:

Gerhard Seltmann of GSE Prokject - Flechtingen, Michael Schwarze-Rodrian of RVR-Regionalverband Ruhrgebiet - Essen, Martina Berends of WMR-Wirtschaftsförderung metropol Ruhr - Mülheim an der Ruhr, Bert Tjhie of Tekton Architekten - Amsterdam, Tom Kuhlman of LEI - Den Haag.



[e]-scApp

E-SCAPE" _ NEW TOOLS AND NEW OPPORTUNITIES FOR THE LOCALIZATION OF Expo 2015 GENERAL INTEREST SERVICES ALONG THE CANALE CAVOUR, A BACKBONE OF THE MILAN-TURIN URBAN REGION

TASKS & SKILLS

Giovanni Castaldo dealt with exploration of the current state of the art. He was also involved in determining user requirements by analyzing survey results.

Tijana Djordjevic working on research related to technology in urban context within the Telecom Innovation Lab. She studied several solutions and developed the project concept.

Benedetta Giudice analyzed different aspects of the territory in order to understand how to enhance its opportunities; she developed the reward system of the app.

Michele Giusto developed the technical implementations by introducing the current state of the art and describing the possible technical solutions for the project.

Davide Mezzino analyzed the strategic dynamics of the territory in relation to the possible stakeholders who could be involved in the project and developed the user requirements section.

Cristiana Oggero dealt with exploring the planning and project opportunities and defined territorial marketing; she developed the reward system of the app.

ABSTRACT

Is a Mi-To smart region worth talking about or indeed possible today ?

Our [e]-scApp project aims to offer new kinds of location-based services in order to develop and connect the diverse, broad and unbalanced territory between Milan and Turin.

To reach our goal we consider the significant event of Expo 2015, with its worldwide impact, as a possible link to enhance and re-elaborate connections in the area between Milan and Turin, characterized by a productive-agricultural landscape. Indeed this event is an ideal opportunity to exploit the intense influx of people, to promote new services both for tourists and local inhabitants and thus participate in the smart-region process.

The service deals with data and information flows and is based on two main elements: on the one hand, enhancement of places in the landscape and on the other user participation in collecting data.

Furthermore the service is built on a sociological approach in order to understand and interpret user interests, giving them the opportunity to play an active role in enhancement of the territory, through a participative (bottom-up) approach.

After considering these issues, our team developed an app for mobile devices and smartphones that allows users to have POIs recommended on the basis of the interests of the avatar and created by users themselves. The app then provides a navigation phase through a geo-referred mapping system (provided by team B) to reach the specific (of each user avatar) point-place of interest.

Finally, we define that users can upload information only if they are physically at the point of interest (through NFC technology) to verify the truthfulness of the information provided and to obtain effective feedback on the territory.

In conclusion, the E-scape project aims to address the contemporary trend of user estrangement from physical space due to the use of ICT and to offer a new kind of interactive experience with the territory by using technologies in a new and innovative manner.

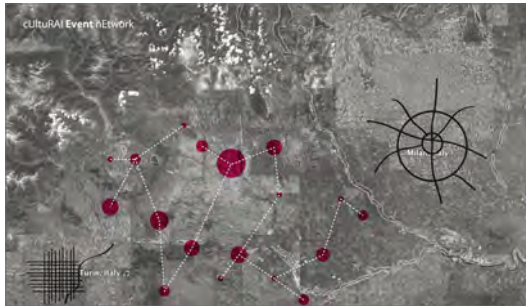

1 The territory in between Milano – Torino



3 Landscape along Canale Cavour

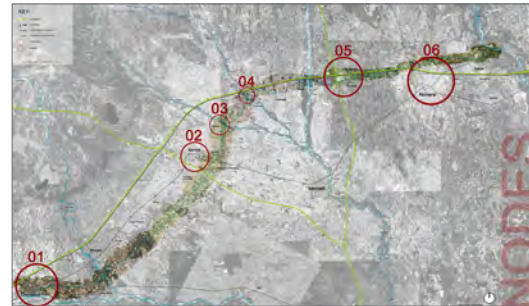

2 Main nodes along Canale Cavour

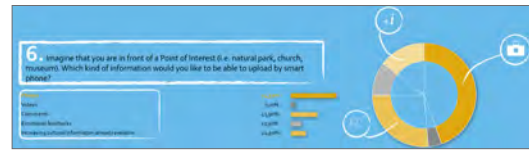

4 Example of one of the on line survey's questions

UNDERSTANDING THE PROBLEM

[e]-scApp is a project designed to identify certain marginalization problems and offer a number of solutions, based on social and territorial analysis. This includes how new technologies can interact with the territory and users at the same time. Our study area is the territory between Turin and Milan, characterized by a flat rural landscape which owes its international importance to its role as the highest producer of rice in Europe.

This is partly due to an impressive water system, made up of natural rivers and artificial canals. In particular, the presence of the Canale Cavour, the most famous canal connecting Piedmont to Lombardy, was considered to be the symbolic and physical backbone of this complex territory due to its 'linear' characteristic, in addition to its historical, territorial and social features.

However, this area is also characterized by a complex infrastructural system including both long/fast connections (high-speed railways and highways) between the main centers of Turin and Milan and short/slow connections between the minor towns (Chivasso, Santhià, Biella, Vercelli and Novara), based on old railways and secondary roads. Thus, this unbalanced infrastructure has produced a strong bipolar system across the study

area leading to the marginalization of intermediate territories. Nowadays this isolation is also underlined by the current trend of using innovative communication technologies (ICT's) which generally tend to isolate people from the territory. Another issue is the possibility to exploit the Expo 2015 project, whose main theme is "Feeding the planet, Energy for life", a topic that is strictly connected to the agricultural characteristics of our territory.

EXPLORING THE OPPORTUNITIES

Having seen that the main issue was the lack of services capable of connecting territories and users, we wanted to create an innovative service which could fill this gap. To this end, we carried out many analyses of existing state of the art smartphone apps. Starting with user requirements, we identified 3 main categories:

- social community: virtual platforms where people can interact by adding status, comments, photos and providing opinions on specific topics;
- accessibility/navigation: smartphone apps concerning different means of transport, sometimes with the possibility for users to add information;



5 *Flag in concept inside our app. App is allowing to avatars to be part of social game. With flagging a new suggestion of interest on the territory users are collecting points for the prize that will come at the end of the app cycle*



6 *Virtual instant community (automatically done by touching the tag) avatar is allowed to upload some information. Recognized forms of upload are diverse: additional information, suggestions and comments, photos and videos*

- territorial opportunities: services, mobile apps and projects related to the relationship between users and territories even though they do not promote enjoyable visit experiences within the territory.

Although most of them are well organized, they share common problems: they offer more or less the same kind of services, are focused on just one topic and sometimes have privacy problems. An important element is also the fact that users are not always able or allowed to add new information and data to that already provided.

Bearing past experiences in mind, [e]-scApp aims to exploit the opportunities provided by new technologies (we consider them as drivers of urbanization processes) and the important Expo 2015 event, extending its vision and boundaries to the surroundings which offer important products, such as rice.

Of all the technologies considered, the most suitable were proximity devices, since they encourage interaction between users and physical places. In particular, we analyzed in-depth Near Field Communication (NFC) technology as a best practice in this field, since it allows data flow while preserving privacy and security.

How to verify our ideas?

We conducted an on-line survey to investigate possible user needs in terms of preferences, interests and habits when exploring new places, in order to provide them with the most efficient solution. The results also pointed to the necessity to increase physical experiences in the context of immaterial services.

GENERATING A SOLUTION

Bearing in mind the needs pointed out in the previous section, the [e]-scApp smart-phone app is designed to provide users with various experiences of the territory and allow them to discover all its opportunities in a smart way. The app has two main features. The first connects users with the territorial offer for a personalized experience. The second opportunity allows users to contribute to the territorial intelligence system by suggesting new areas that they believe to be relevant. This interaction enables the creation of a bottom-up system, based on a smart social community, focused on user perception of the territory.

A fundamental aspect of the app is its exclusively location-based character, requiring a user to be in the territory to be able to entirely benefit from the app functions. Accordingly, the approach chosen is that of increasing the relevance of the physical space and contributing to its enhancement, through the use of proximity technologies.



7 App rewarding system. To accomplish the prize the avatar is obliged to full the evaluation of the space -state if they like/ dislike the space and check the table with predefined general criteria for spaces. After compilation of evaluation form, coupon file will be automatically opened and downloaded to phone memory, also explaining the instructions to be used in the neighborhood according to categories (shopping/service/leisure discounts)

The possibility of downloading the app would be facilitated also through various app stores/web sites, but only entirely accessible when a user certifies his/her presence in the territory by checking in through the various NFC tags. Furthermore, tags are divided into two categories (both managed by team B). The first is located at busy “hubs” (train stations, airports, etc.) and is the starting point for the system. At these points, the user can discover the app, install it and create his virtual character-avatar, according to personal parameters (interests, transportation mode, exploration time available, etc.). Instantly, the avatar receives suggestions on POI he might want to explore and how to reach them. Once the POI is reached, the app will require presence confirmation, thus triggering the second type of NFC check-in tag. This action provides certain information on the POI and in addition instant community status is enabled for the avatar. This community status enables posting of reviews, comments, photos, videos and the display of previously inserted information. At any time during navigation or territorial exploration, the avatar is allowed to flag a new POI suggestion (active mode). Following positive comments by others, eXcape (Team B) can recognize it as a new POI and assign a new NFC tag. It is also possible to discover new POI by analyzing GPS tracks of users moving around the territory (passive mode); also in this case, Team B provides the NFC tag. User interaction in the



8 App architectural diagram

form of suggestions, comments or pictures plays a crucial role in the cartography process. Finally, avatars could interact among themselves, viewing the location status, profiles, interests and previously visited places of other avatars. [e]-scApp enables participation in temporary social games, such as treasure hunts or bicycle races. Evaluation of avatar participation is based on the level of user interaction with the system. The higher the participation, the higher the avatar’s virtual status. As he/she becomes more important, he/she also wins prizes in the form of discounts for local products or events.

MAIN BIBLIOGRAPHIC REFERENCES

- [1] King, JJ., *The Node Knows, in Else/Where: Mapping - New Cartographies of Networks and Territories*, edited by Janet Abrams and Peter Hall, University of Minnesota Design Institute, 2006.
- [2] Kuniavsky M., *Smart Things: Ubiquitous Computing User Experience Design*, Morgan Kaufmann Editor, San Francisco, 2010.
- [3] Perulli P., *Northern Italy as a global-city region, in Società degli Ingegneri e degli Architetti in Torino, A&RT, Turin - Milan: territorial perspectives for a competitive cooperation*, Anno 144, LXV 3-4, Torino, 2011.



[e]X-cape EXploring the landsCAPE

E-SCAPE" _ NEW TOOLS AND NEW OPPORTUNITIES FOR THE LOCALIZATION OF Expo 2015 GENERAL INTEREST SERVICES ALONG THE CANALE CAVOUR, A BACKBONE OF THE MILAN-TURIN URBAN REGION

TASKS & SKILLS

Federica Bonavero contributed to the problem-setting phase and to the solution proposal developing the “buffer map” concept and carrying out the feasibility evaluation.

Doaa Salah Eldin contributed in conducting preliminary research, gathering information on the territorial context and related theoretical concepts.

Lucia D’Amato contributed to the definition of the final proposal, focusing attention on the interface and on territorial heritage.

Federica Remondi contributed to the state-of-the-art analysis, mainly dealing with the aspects related to water management.

Bogdan Stojanovic contributed to the final project output and to development of the mobile application graphic interface and visual output of the maps.

Simona Valenti contributed to the problem-setting phase and to the solution design, matching users needs with map requirements.

ABSTRACT

The project consists of the enhancement of innovative proximity technologies through the use of smartphone applications with the aim of promoting the development of a smart region in the territory between Milan and Turin. The huge presence of infrastructures, the Canale Cavour and the water-infrastructures with a strong historical value and the particular character of the territory due to the presence of rice fields generate a potential the project aims to explore, taking advantage of the Expo 2015 event and of the huge influx of people. Use of the above-mentioned tools is believed to be able to generate new behaviors and to support territorial changes, making places and people play an active role.

Innovative communication technologies are the pivot of the project: NFC - Near Field Communication tags are distributed along the backbone of the Canale Cavour where users will start their active exploration of the territory with the guidance of the smartphone application. The latter is implemented through the integration of two different approaches: top-down and bottom-up.

The sub-project deals with the top-down characteristics of the application: a set of pre-determined information is offered to users with a complete array of smart maps showing details of the territory according to the kind of user and his position, the means of transport and the climatic conditions and seasons.

The choice of using NFC to access the app is necessary to verify that the user is present in the territory he is exploring, necessary condition to actively add new data through the bottom-up approach. In this way, maps and information become dynamic, being constantly updated and improved, also through GPS tracing of users and highlighting which highly explored places should be given new NFCs.

Adaptation to individual users will be possible by exploiting the data provided by team A that will integrate and populate this system with the information uploaded by users on new places of interest.



1 Title of the subproject

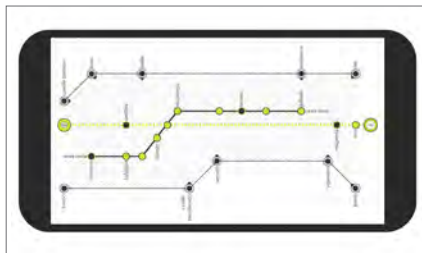

2 Schematic map of metropolitan region of MI-TO with the NFC's position

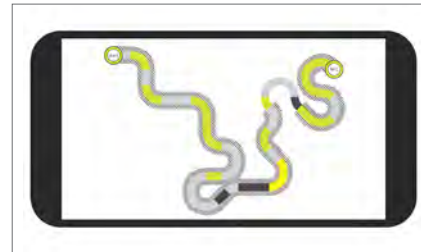

3 The GPS map that guides the user to the nearest NFC

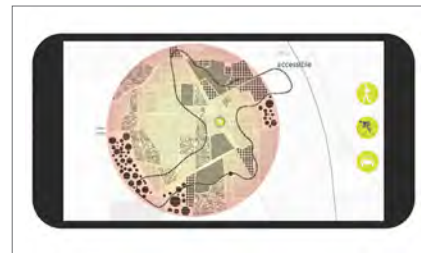

4 The BUFFER MAP, that activates when user reaches the NFC point, showing accessibility and visibility [ex. cyclist on a sunny day]

UNDERSTANDING THE PROBLEM

The project refers to a territory offering an interesting challenge due to the presence of the corridor that is naturally generated by the huge network of infrastructures connecting the two cities of Milan and Turin.

In general, the presence of large infrastructural elements, i.e. highways and high speed railways, rarely brings beneficial effects to the territory, since they create ambiguous situations between the main metropolitan areas and the secondary territories travelled through and divided by the huge traffic flows. On the other hand, the Canale Cavour could lead to positive externalities from being the central element of the corridor in the Mi-To region, that can be identified as urban development and regional cohesion. To date, however, only negative aspects have emerged due to the isolation of this area and overlapping of the above mentioned infrastructures that have caused disorderly urbanization and congestion. Moreover the territories travelled through suffer from isolation due to the natural tendency to consider these places as transit landscapes and to naturally go toward the macroscopic metropolitan areas.

Therefore, the problem is to plan strategic actions for these in-between territories in order to limit the tunnel effect by increas-

ing their attractiveness by attracting economies and functions that would naturally tend to be located in the metropolitan areas. Expo 2015 is a clear example of this tendency: it is located in the city of Milan, somehow excluding the surrounding territories from its 'attraction effect'.

This project's aim is to exploit the universal exposition event, in order to distribute the positive fallout on the areas along the Canale Cavour, by enhancing the potential of this territory as an element to be explored rather than a simple means of connection.

EXPLORING THE OPPORTUNITIES

Given these premises, the [e]-Xcape project focused its attention on the opportunity to leverage on the little known and underestimated values of the Canale Cavour surroundings. Considering it as the ideal backbone of the MI-TO region, we started to investigate the opportunity of exploiting its linear path as the privileged starting point for promoting the in-between territories.

An artificial canal built just after proclamation of the Italian Kingdom, the Canale Cavour and its tributaries have historically played the role of "landscape creation elements". The extensive network of irrigation infrastructures, the slow mobility routes that run alongside them, the chromatic effects related to

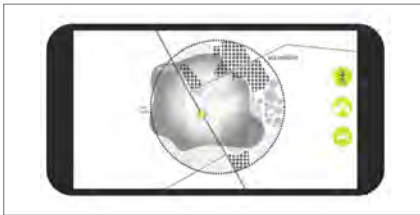

5 The BUFFER MAP, that activates when user reaches the NFC point, showing accessibility and visibility [ex. pedestrian on a foggy day]



6 The metropolitan map of the MI-TO region with 3 levels of NFC's



7 The logo of the TEAM B, will be used as well like the NFC marker



8 View of the cascina San Maiolo during a sunny day, showing information through augmented reality

the changing seasons, the sight offered by small rural centers emerging from flooded lands, etc., constitute assets well worth not only maintaining and protecting from the anthropogenic pressures which have been discussed in the paragraph above, but also promoting from a touristic point of view.

A particular feature of our study area, the rice fields represent a productive landscape whose uniqueness is internationally renowned and which could greatly benefit from inclusion in the Expo 2015 calendar (even more so given the theme *Feeding the planet, Energy for life*).

At the moment, however, the temporary nature of their flooding makes it complicated to enjoy an effective experience of this extraordinary event. Thanks to the combination of data coming from Coutenza Canale Cavour water management sensors with innovative communication technologies under development by Telecom Italia labs (both external stakeholders in the E-Scape project), the opportunity to overcome this issue is just around the corner.

GENERATING A SOLUTION

Our proposal consists of the creation of a dynamic map constituting the interface of a smartphone application with the aim of enhancing landscape exploration practices. The sub-project title, "E-Xscape", highlights our willingness to motivate users to

experience the Canale Cavour region, empowering their personal awareness of the value of the in-between territories and their relation with the physical space. Through the design of an innovative digital device interface, we seek to provide a new location-based service able to display real-time information for the benefit of mobile customers surrounded by changing contextual conditions.

In this regard, the core of our vision is an original way of conceiving map representation. During the state-of-the-art analysis, we discovered that the traditional cartographic model is affected by a series of shortcomings that are not taken into proper consideration even by some of the latest smartphone applications. For example, conventional maps are static and non-interactive, sometimes they are thematic but certainly not user-defined and, moreover, the updating and upgrading process of hard copies is too demanding to be undertaken at reasonable time intervals. Exploiting the possibilities offered by Web 2.0 and in the attempt to overcome the above mentioned issues, a multi-dimensional, incremental and dynamic map has been developed:

- **multi-dimensional**, since it combines time and space into a single representation of small and big "localized" events;
- **incremental**, since it is based on an NFC tag network that grows and consolidates over time, thanks to the integration of [e]-scApp (team A) *tracks* and *flags*;



9 View of the cascina San Maiolo during a foggy day: the application helps you to find the place of interest through augmented reality



10 The BUFFER MAPS in different seasons showing landscape's changes. Rice fields, for example, change the perception and the relation between users and territory



11 View of the agricultural landscape with the NFC point



12 View of the Canal Cavour with incorporated NFC in the bridge

- **dynamic**, since it is constantly updated with real-time information coming from cloud resources, official databases, sensors, etc.

The proposed system is actually designed to work as a sort of “spatial filter” which selects and combines ready-to-use data in an innovative manner.

According to our concept, it will be based on the two different kinds of NFC “touchpoints”. The first includes those tags that are located in certain strategic nodes and that may represent important “gateways” to the region. In these places, users can discover the app and select the nearest NFC point to be guided to in order to receive useful information to start the exploration. The second, instead, provides a general interest service, such as the opportunity to be a sort of map dispenser: when users tap them with an NFC-enabled smartphone or hold it in close proximity (approximately 5 cm or less), their physical presence in the territory will be certified and what has been called the “buffer map” launched.

Starting from this moment, two virtual radii will be superimposed on the base map and the customer will be able to access a tailored environment where in-depth information on what is literally happening around him is provided. Usually, maps are downloaded in order to know where you are and how you could reach your final destination: the [e]-Xcape map, on the other

hand, tries to build a stronger relationship between users and the physical landscape, showing its changes and its POI - Places of Interests in a customized manner.

Thanks to a mix of pre-defined parameters and instant data, the surrounding landscape will in fact be represented according to two different variables: visibility and accessibility. Far from being perfect circles, these shapes will become isochronous curves whose borders expand and shrink depending, the former, on weather conditions and, the latter, on the chosen means of transport (with particular emphasis on sustainable mobility). Finally, the possible ease of integration of Team A bottom-up tracks and flags will then offer the opportunity to improve the initial map and detect which are the most appreciated and visited places, where future NFC tags would be placed to enlarge the area of relevance of the application.

MAIN BIBLIOGRAPHIC REFERENCES

- [1] Careri F. (2006), *Walkscapes: camminare come pratica estetica*, Einaudi, Torino.
- [2] Kloeck K., Senn O., Di Lorenzo G., Ratti C. (2011), *Live Singapore! An urban platform for real-time data to program the city*, MIT Senseable City Lab.
- [3] Krishna G. (2012), *The best interface is no interface*, available on the web at <http://www.cooper.com/journal/>.

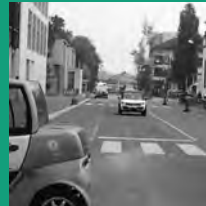
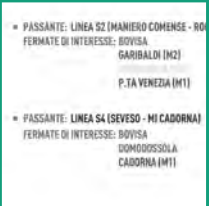
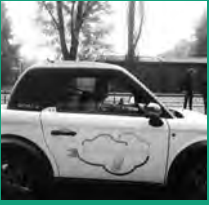

PROJECT

12

Green Move

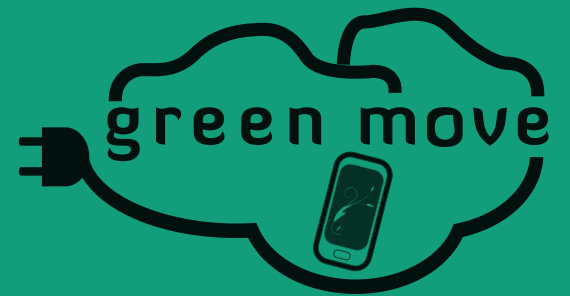

**DESIGN AND TESTING OF AN INNOVATIVE TRANSPORT SYSTEM
FOR VEHICLE SHARING**



Green Move

Design and testing of an innovative transport system for vehicle sharing

PRINCIPAL ACADEMIC TUTOR

Alberto Colorni

Industrial Design, Arts, Communication and Fashion, Politecnico di Milano

ACADEMIC TUTORS

Francesca Montagna

Management and Production Engineering, Politecnico di Torino

Angelo Morzenti

Electronics, Information and Bioengineering, Politecnico di Milano

Marco Guido Ponti

Industrial Design, Arts, Communication and Fashion, Politecnico di Milano

Sergio Savaresi

Electronics, Information and Bioengineering, Politecnico di Milano

EXTERNAL INSTITUTIONS

Finlombarda SpA

Consorzio Poliedra

Regione Lombardia

EXTERNAL TUTORS

Alessandro Luè

Consorzio Poliedra

TEAM A

Francesco Borghesan [Team controller]

Automation Engineering, Politecnico di Milano

Giovanni Causapruno

Electronic Engineering, Politecnico di Torino

Fabrizio Chiesa [Project communication coordinator]

Mechanical Engineering, Politecnico di Milano

Antonio De Bellis

Industrial Design, Politecnico di Milano

project 12

The project GreenMove, financed by Regione Lombardia, involves 8 research centers of PoliMi to design and test an innovative electric vehicle sharing system

TEAM B

Jacopo Bonacci

Product-Service-Systems Design

Roberta Motter

Product-Service-Systems Design

Merve Murathanoglu

Management Engineering

Tommaso Taddei

Mathematical Engineering

Giovanni Villani [Team controller]

Management, Economics and Industrial Engineering

PROJECT DESCRIPTION

Green Move is a new project for an innovative electric vehicle sharing system in Milan founded by Regione Lombardia and developed by 8 departments and centers of the Politecnico di Milano.

Vehicle sharing consists of the use of a shared car, taken from the user in a special parking area and left in the same (or in another) area. The service is similar to car rental but is differentiated by the short duration of trips: for this reasons it is well-suited to metropolitan areas.

Vehicle sharing systems address those who use the car for sporadic trips and travel on average less than 10,000 km per year: taking advantage of an appropriate – in terms of costs and accessibility – service, they can renounce a second car. On the one hand, this generates considerable financial savings (the cost of a private car is approx. 5,000 euro per year) for the user and, on the other, significant social improvements for the city in terms of pollution. It has been demonstrated that car sharing significantly decreases use of the car: if, in addition, the vehicles are electric, the impact of the service on pollution reduction can be significant.

For these reasons, vehicle sharing can be included among sustainable mobility systems in the same way as carpooling, bike sharing and Public Transport.

The Green Move project aims to overcome existing vehicle sharing services through a new and dynamic approach: *standardization, inter-modality, multi-ownership, multi-business and social networking*.

As regards *inter-modality*, the service is defined as a vehicle-sharing system offering users multi-modal fleets. One of the more evident limitations of traditional sharing systems is to offer users a single type of vehicle (usually car or bike). This approach is not flexible enough to supply a wide range of mobility needs.

Multi-ownership consists of the opportunity for single users, private companies or associations to join the service, not only using vehicles provided by the service itself but also sharing



their personal electric car or fleet. In this way the paradigm of “buying a car” is substituted by “buying mobility services”.

Thanks to its flexibility and openness, the system provides the opportunity to design alternative services and mobility solutions (*Multi-business*): a mini-van used during the day as a company vehicle can become a collective taxi during the night.

All these features are feasible only through development of a suitable *standardized interface* capable of managing differences among users and among fleet vehicles.

As a final point, the project intends to take advantage of the potential of social networking to design a service responding to the real expectations of users, to dynamically understand the evolution of user needs, to disseminate the service and to create solid and loyal user communities and clusters, also thanks to feedback and rating systems.



The technology behind a car sharing

TASKS & SKILLS

Francesco Borghesan the team controller, dealt with the technical analysis of the docking and charging stations, data exchange between the cars and the green box and the technical systems used by competitors.

Giovanni Causaprino dealt with the technical analysis of unlocking the doors, the RFID system and the security protocols of the car's mobile communication system.

Fabrizio Chiesa, the project communication coordinator, dealt with the analysis of the features of the different car sharing systems and design of the smartphone holder.

Antonio De Bellis, the team designer, was responsible for the system service design, design of the smartphone holder and all images and slideshows.

ABSTRACT

Financed by the Lombardy Region, the Green Move project aimed to create new ideas and possible solutions for a new form of car sharing in which the fleet is composed of public as well private vehicles, in particular electric vehicles. The expected advantages for both parties are financial return from car rental which could lower initial vehicle investments, a lower number of vehicles and less congestion on the roads, as well as promotion of more ecological vehicles such as electric vehicles.

The project was followed by eight departments of Politecnico di Milano, each with the different competences required for this multidisciplinary project. The team of ASP students working on this project was divided into two groups: team B worked with the INDACO department (department of industrial design, arts, communication and fashion) for service analysis and design. Team A, our team, worked with the Information technology department in order to analyze the technical aspects of the project. In support of the project, the team analyzed the:

- type of infrastructure to be used for vehicle charging
- technology to be used to be used for user identification
- technology to be used to interface the car with the Green Box
- interface as well the services provided by the Green Box and design of a universal smartphone support device to be installed inside the car

Due to the lack of defined standards in electric vehicles and secrecy on signals exchanged inside cars by manufacturers, it was not been to interface all types of vehicles with the Green Box. All other topics mentioned were instead solved.

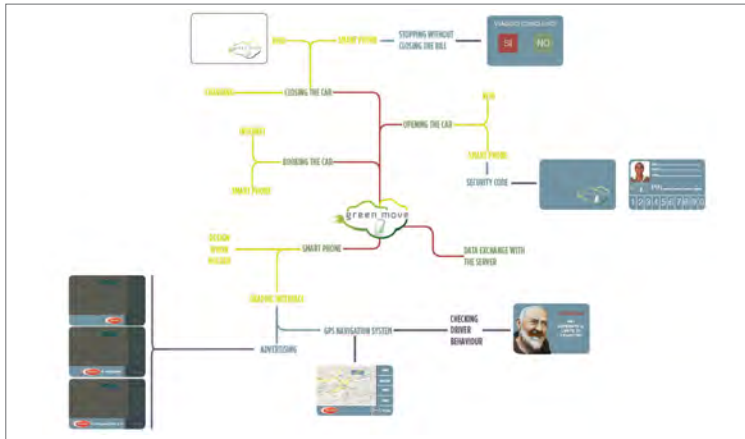

1

UNDERSTANDING THE PROBLEM

The aim of the Green Move project is to create a highly innovative, third generation vehicle sharing system. To achieve this result many improvements, with respect to second and first generation systems, were conceived, designed and implemented, from both the service and technical points of view. The principal innovations of Green Move, which defines the identity of the project and were set during the preliminary project design phase are: possibility to host a different system number of ZELS (electrically driven, light-weight and small) vehicles, interoperability of the entire system which must comply with a standard protocol in order to ensure that different nodes of the system can flawlessly interact in the network, different ownership of vehicles and docking stations which can belong to the Green Move project, private users or private firms and possibility to implement different business models in the same system.

Furthermore, to be specifically closer to the objectives of our team, a number of other requirements were gathered during the competition analysis phase: these new requirements created problems with regard to both the user level, i.e. which kind of services we should be implemented for users to effectively and smoothly use the service, and the technical level, i.e. how to technically implement such services.



2

In fact, in our car sharing systems we would like to offer users a plethora of different methods to carry out the different steps, i.e. possibility of booking the car using the Green Move website, a mobile application or directly taking a free car, possibility of unlocking the car using an RFID card or the user's smartphone, possibility of not having to do a round-trip, which is a typical constraint for most car sharing systems and implementation of a multi-functional interface which is part of the Green Box, embedded in the car.

All of these options entail many technical constraints, such as how to interface the Green Box with the communication systems of the different cars, how to develop a security protocol to unlock the car doors with the smartphone etc.

EXPLORING THE OPPORTUNITIES

The charging stations

When the project started, significant commercialization of electric vehicles has also started, but without a clear definition of standards to be used for charging stations. We therefore analyzed the Electric Vehicle market, electrical component suppliers and the decisions taken by utility companies in order to understand which standard would emerge as the de facto standard.

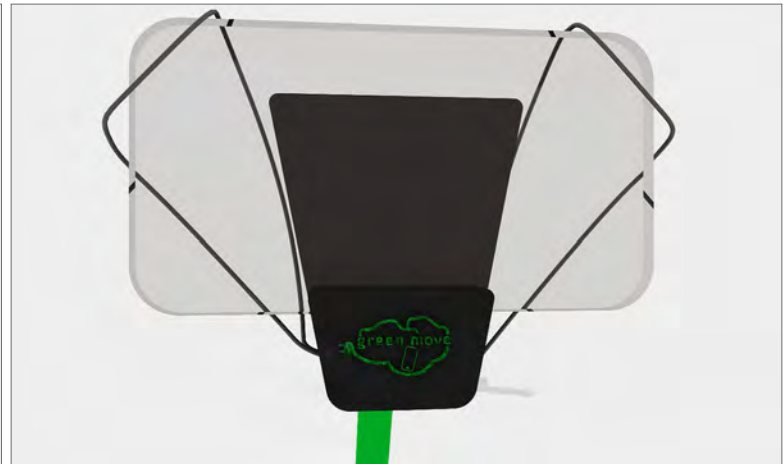
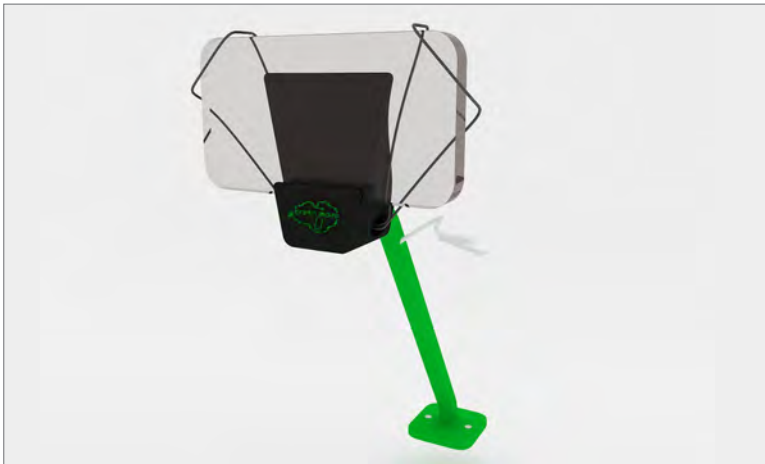

3 Two imagines of the holder

Entering the car

A highly innovative aspect of Green Move also resides in the mechanisms provided to enter the car. We studied tens of car-sharing systems worldwide: the simplest ones just use the car key; other more sophisticated systems use a smart card to let the user unlock and lock the car at the beginning and at the end of the trip, while for intermediate stops the car key is used. The most advanced systems also provide limited smartphone functionalities. Our system is a breakthrough in this sense: we intend to provide the best experience ever with the smartphone, which means being able to book, unlock, lock and release the car. We identified three ways to provide communication between the car (through the Green Box) and the user's smartphone: through the cellular network, using NFC or using Bluetooth. The NFC module is present only in a limited number of smartphones and could represent a solution only in the next few years. Bluetooth guarantees certain advantages over the cellular network which led us to choose this solution.

Signal interface between the green box and cars

The most challenging requirement for Green Move was the required flexibility: compatibility with a wide range of vehicles,

possibility to record all data coming from the car in order to display the location as well as the state of charge and, perhaps, the possibility to allow users one way trips and therefore the ability to track the position.

We focused mainly on car battery management systems, on various available communication protocols and on opportunities for retrieving information on the health status of cars.

The main difficulties still hindering the initial requirements of the project are the large variety of protocols, which does not facilitate creation of drivers for all the different cars, and secrecy of manufacturers, unwilling to release protocol specifications and data.

GENERATING A SOLUTION

Charging stations

We identified in the German Mennekes plug the de facto standard for the coming years in the EV field. The association of European car manufacturers (ACEA) indicated this as the standard to be used and most charging station manufacturers use it. Alongside this standard is also the French-Italian Scame plug, which is still provided in A2A and Enel charging stations, but all manufacturers are abandoning it as a standard.



4

Entering the car

The Bluetooth interface is provided through an integrated Bluetooth reader. Data is exchanged locally and in this way it is guaranteed that the user is in the proximity of the car when he unlocks it.

With the intention of ensuring a service that is accessible to anyone, we need to provide an entering mechanism for those without a smartphone; this is also required since a smartphone could accidentally run out of battery power and therefore another way of entering the car must be guaranteed for those who still do not have a smartphone. We chose to go for the most common and yet versatile solution which is the RFID smart card. With a smart card, the user can open and close the car, unlock and release it, but also request authorization to charge the car with different energy provider charging stations and also use city public transport.

The Green Box is equipped with a 3G module used to communicate with the central server and a GPS module to track the position. Moreover, it acquires data from the car through a Vehicle Signal Acquisition Board.

Signal interface between Green Box and Cars

While some light electric vehicle manufacturers agreed in providing the necessary data to use the vehicle with the Green Move platform, larger car manufacturer refused to provide such data. Lacking a real standard for electric vehicles such as that for fuel-powered vehicles, full compatibility with different models is not easily achievable at the moment. The current perspective of the project is to rely on existing car sharing platforms in Milan and in the Lombardy region which have already acquired the rights to access the data of cars present in their portfolio.

Smartphone holder & system interface

In parallel with the technical studies we also addressed two design challenges: the first was the design of a new smartphone holder concept, custom designed for the Green Move project, which is able to accommodate a large number of new generation smartphones (whose dimensions may vary considerably), while the second was the design of a mock-up of the system interface to be implemented in the Green Move smartphone application or in the Green Box program, considering both aesthetic and user interaction issues.



The service idea

TASKS & SKILLS

Jacopo Bonacci focused on social networks and credit systems and was responsible for all the graphic aspects of the project.

Merve Murathanoglu worked mainly on the conjoint analysis survey and its results. She also contributed to the generation of alternatives.

Roberta Motter was the Scarsellini condominium prototyping phase coordinator and also worked on project communication.

Tommaso Taddei worked mainly on the definition and evaluation of alternatives. Moreover, he contributed to the credit system design.

Giovanni Villani, in his role as team controller, coordinated team work and focused on creating the test kits.

ABSTRACT

Green Move aims to create a car sharing system, in the city of Milan, based on electric vehicles and new innovations such as social networks and smart phones. As Team B, our role in the project was focused on the service idea, which is composed of two challenges: configuration of the service and the social network idea.

For the first aspect, service configuration, we started by analyzing best practices worldwide. We analyzed different car sharing and rental services in major cities to understand the best solutions adopted in different contexts. After this step, we contributed to the design of four major alternatives for the service, targeting different profiles of use: Condosharing, Firmsharing, World of Services and Peer to Peer Plus.

To create a better solution, we wanted to understand how configuration parameters (tariff, range of available cars etc.) were perceived by and affect users of the service. For this reason we made a survey and a conjoint analysis on a sample of 200 people focusing only on Condosharing and World of Services alternatives.

As the last part of our work on the service, we tested the Condosharing alternative in order to understand the behavior of users in a pilot area, the condominium of Via Scarsellini, and then scaled up the results to the larger context of the city of Milan. To do this, we analyzed general characteristics of the area around Via Scarsellini 17, made a survey of condominium inhabitants and created the test access kit.

Also for the second branch, the social network, we started with the analysis of social networks linked with services. After understanding the major trends in this field, we designed a credit system to be utilized in the Green Move system.

The strength of our work is its user oriented approach in proposing solutions and the actual testing of the project.



1

UNDERSTANDING THE PROBLEM

GreenMove is a project which addresses the design of an innovative electric car sharing service based on social networks able to provide a new sustainable method of transportation in the city of Milan. Within the context of the project, we, as Team B, addressed the service idea.

The two main problems relating to the service idea are service configuration and the social network to be implemented in the system.

As regards service configuration, we encountered a number of difficulties connected with the lifestyle of citizens in Milan: in general, families own one or more cars and are not willing to share them with others. Adding to this, we had to address the issue related to electric cars: when compared to the traditional internal combustion engine, the electric car has certain problems in terms of performance. Moreover, the city lacks the infrastructures required for electric vehicles. Bearing in mind these problems, we aimed to identify the profile of potential users interested in car sharing and design the service in a user-oriented way in order to make the service as attractive as possible.

As regards the social network aspect, to promote the peer to peer paradigm, Green Move intends to introduce a social net-



2

work model where users can participate in the content on the platform, unlike traditional car rental services. For this reason, we had to identify the social network elements suitable for a car sharing service and encourage users to actively participate.

EXPLORING THE OPPORTUNITIES

As a first step, we identified a number of “mobility profiles” of users potentially interested in a vehicle sharing service.

From analysis of the literature and of best practices (Autolib, GuidaMi, ZipCar etc.) we observed that traditional vehicle sharing configurations do not fully address the needs of mobility profiles identified by the literature.

Starting from this observation, Green Move aims to offer a flexible structure and a variety of additional, highly customizable services in order to address several mobility profiles.

Therefore, the GM keyword must be **inter-operability**: as in the World Wide Web, each node and each vehicle can be different in terms of dimension, cost and structure but share a general protocol that works as an interface with the rest of the system.

The choice of configurations was made by looking at the following criteria:



3

- Degree of innovation and differentiation compared to existing initiatives.
- Opportunity for Milan.
- Ability to satisfy specific needs of Milan users.

At the end of the analysis, four different configurations were chosen:

- **Condosharing:** GM vehicles are shared among one or more condominiums for the exclusive use of inhabitants. All the benefits of car sharing (bus lanes, free parking and free access to area C) are preserved.
- **World of Services:** certain crucial infrastructures (hospitals, large commercial centers, etc.) are conceived as central nodes of the system and the service aims to guarantee one way trips between them.
- **Firmsharing:** aims at substituting the company fleet with a specific mobility package that can be adapted to the company needs. Thanks to the special structure of GM, the standard service during working hours can be coupled with certain special mobility packages for employees during their free-time.
- **Peer to Peer Plus:** the service is based on the idea that private users share their own cars with the rest of the system com-



4

munity. We observe that this mechanism can be applied even in Condosharing and Firmsharing where an implicit sharing radius exists, represented by the condominium and by the company, respectively.

In order to find best practices on the topics related to the Green Move project, we found a number of experiences both in the mobility (Waze) and in the social field (Foursquare). Through analysis of these examples, we discovered several points that will be crucial in enhancing the user experience: user generated content and credit system.

GENERATING A SOLUTION

After defining the macro alternatives, we furthered our analysis to adapt the configuration to the context of Milan. Two different kinds of analysis were performed: conjoint analysis and in-field analysis at Via Scarsellini for Condosharing.

For a better understanding of how different parameters affect people and are considered the most important by them, we conducted a conjoint analysis. In order to perform it, we prepared a survey which was filled in by those aged between 20 and 27. We considered only two out of the four configurations, condoshar-



5



6

ing and world of services, due to age limitations of the group. As regards the nature of conjoint analysis, alternatives are created within each configuration, varying the parameters for participants to choose from. In this way, we were able to create a weighted score for attributes which showed us their relative importance. Also, participants were directly asked to rank all the different factors in terms of their preferences. The second analysis concerned a field test of the condosharing configuration in a large condominium of approx. 100 apartments. Even if to date the simulation has not yet started, we carried out preliminary tasks that will be used in test evaluation. Firstly we performed a territory analysis, in order to understand local issues from the mobility point of view. We then prepared an explanatory kit which included the key to the box, an RFID card interface with the car system, a rule book and a video tutorial. As the final step, we created a survey to study the characteristics and reaction of test users. As far as the social network aspect is concerned, we paid particular attention to the “Credit System”. In a social network the “Credit System” is a virtual system in which users earn “credits” to be spent in the social network itself.

Our task consisted of detecting how to apply the Credit System to the Green Move system. To reach this goal, we analyzed a number of credit system best practices worldwide (for instance, Fubles and Foursquare), defining a possible framework. We divided the methods of earning and spending points into two main categories that correspond to the different types of actors in the GM system: vehicle users and providers.

MAIN BIBLIOGRAPHY

[1] R. Katzev (2003), car-sharing: A New Approach to Urban Transportation Problems, *Analyses of Social Issues and Public Policy*, 3: 65-86.
 [2] Green, P.E. and Srinivasan V. (1978). Conjoint Analysis in Consumer Research: Issues and Outlook. *Journal of Consumer Research*, Vol. 5, No. 2 (Sep., 1978), pp. 103-123.
 [3] S. Shaheen, D. Sperling, C. Wagner (1998), car-sharing in Europe and North America: Past, present, and future, *Transportation Quarterly*, 52: 35-52.

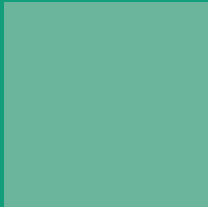
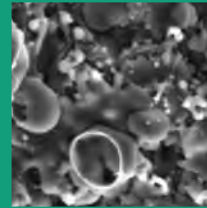
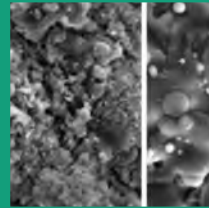
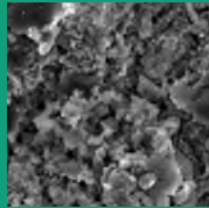
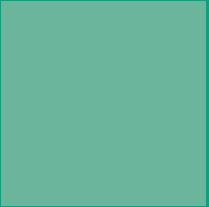

PROJECT 13



PROPER

Future perspectives of joint prostheses

PRINCIPAL ACADEMIC TUTOR

Silvia Spriano

Applied Science and Technology,
Politecnico di Torino

ACADEMIC TUTORS

Roberto Chiesa

Chemistry, Materials and Chemical
Engineering “Giulio Natta”,
Politecnico di Milano

Luigi De Nardo

Chemistry, Materials and Chemical
Engineering “Giulio Natta”,
Politecnico di Milano

Enrica Vernè

Applied Science and Technology,
Politecnico di Torino

EXTERNAL INSTITUTIONS

EPoS S.r.l.

**Azienda Ospedaliera CTO - Maria
Adelaide, Torino**
Azienda Ospedaliero-Universitaria

San Luigi Gonzaga, Orbassano (TO)

Bionica Tech S.r.l.

**CNR – ISTEC; KTH Royal Institute of
Technology (Sweden)**

**VTT – Technical Research Centre of
Finland**

EXTERNAL TUTORS

Maria Giulia Faga

CNR - ISTEC Torino

Alessandro Fais

EPoS S.r.l.

Giacomo Fucale

Azienda Ospedaliera CTO - Maria Adelaide,
Torino

Giovanni Maina

Azienda Ospedaliera CTO - Maria Adelaide,
Torino

Alessandro Massè

Azienda Ospedaliero-Universitaria San Luigi
Gonzaga

project 13

*Open problems and perspectives
of joint prostheses: wear of bearing
surfaces, infection at the damaged
site, a better understanding of
pressing patient needs*

Maria Oksa

VTT - Technical Research Centre of Finland

Jinshan Pan

KTH Royal Institute of Technology

Luca Ravera

Bionica Tech S.r.l.

TEAM A

Marina Carmela Curci

Biomedical Engineering

Giorgia De Guido [Project communication
coordinator]

Chemical Engineering

Federico Mazzucco

Mechanical Engineering

Alessandra Molteni [Team controller]

Biomedical Engineering

Andrea Sosio

Mechanical Engineering

Federica Vaccari

Management, Economics and Industrial
Engineering

PROJECT DESCRIPTION

The project deals with the open issues and future perspectives of joint prostheses.

The main topic of the project concerns wear of the bearing surfaces. Cobalt-chromium-molybdenum alloys are widely used in total hip and knee joint replacement. They are able to form efficient artificial joints by means of coupling metal-on-polymer or metal-on-metal contacts. However, a high concentration of stress and direct friction between surfaces lead to the formation of polyethylene wear debris and the release of toxic metal ions in the human body, limiting, as a consequence, the lifetime of the implant. The aim of the project is the investigation of innovative surface/bulk materials in order to improve implant performance. The study mainly involved disciplines such as materials science and biomedical engineering, as well as process industrialization aspects, with attention to commercial applications and the market (with a “bench to bed” approach). Moreover, the project includes management skills to evaluate business ideas and define the production process (from materials to devices). A further topic of the project consists of a better understanding of the more pressing patient needs.

The main steps of the project were the following:

- A good level of knowledge on the state of the art of hip and knee prostheses was achieved by the team. Bibliographical research was performed in order to understand the current open issues.
- A market analysis was performed in order to closely examine current solutions proposed by several companies (manufacturers of orthopaedic implants).
- Preparation and submission of questionnaires to the main companies involved in the prosthesis market.
- Preparation and submission of questionnaires to a number of orthopaedic clinicians.
- Preparation and submission of questionnaires to a number of physiotherapists of patients with hip/knee prostheses.
- Analysis of the answers to the questionnaires.
- The high velocity oxy-fuel (HVOF) thermal spray process developed by VTT (Technical Research Centre of Finland) was considered as a potential innovative technology.
- A number of lab samples of coatings prepared by VTT were characterized.
- Assessment of a business plan concerning a hypothetical company applying VTT technology to the orthopaedic implant sector and support biomedical companies in scouting innovative technologies.
- Team attendance at an International conference concerning orthopaedic implants (Implants 2012 – Lyon).





TASKS & SKILLS

Marina Carmela Curci participated in the research activity, worked on one of the questionnaires prepared to investigate open technical issues related to hip and knee prostheses and did a great job on research of data required for the strategic plan.

Giorgia De Guido acted as Communication Coordinator between the team and tutors and ensured accuracy and quality of project materials. She also worked on one of the questionnaires prepared by the team, joined the laboratory activity and collected the information needed to write the operational plan.

Federico Mazzucco played a significant role in the laboratory activity aimed at characterizing samples from a chemical, structural and morphological point of view. He also provided a significant contribution to preparation of the business plan.

Alessandra Molteni, as Team Controller, participated in the project development, taking responsibility for administering the project budget. She played a key role in identifying an external institution to cooperate with in order to investigate the applicability of a ceramic coating on metallic substrates. She also worked on the questionnaires, joined the laboratory activity and found useful information for preparation of the business plan.

Andrea Sosio was in charge of research on the release of metal particles from total knee arthroplasty implants, dealt with questionnaire processing and the section of the business plan related to the organizational form of the proposed business.

Federica Vaccari, with her management skills, did a great job in evaluating business ideas for elaboration of a future scenario. She guided the entire team in creating the business plan, but also worked on elaboration of the questionnaire to identify the needs and main issues encountered by companies in the orthopaedic field.

ABSTRACT

The *PROPER* project arises from the interest in solving open issues and future perspectives of joint prostheses, with particular attention to hip and knee implants. The first topic concerns wear of the bearing surfaces. Although friction and wear are part of everyday life and are required for several activities, they must be reduced in certain applications, such as total hip and knee replacements. It is well known that a number of coating deposition techniques can strengthen the surface structure and reduce both friction and wear. The idea developed consists of application of a dense ceramic coating on a metallic substrate aimed at combining the low friction coefficient of ceramic with the mechanical properties of metallic materials. Deposition of the coating on the substrate can be accomplished through the high velocity oxy-fuel (HVOF) thermal spray process: thermally sprayed coatings have been developed for improving wear resistance while leaving great freedom in material composition. Application of the coating reduces wear of the sliding surfaces and also helps to solve the second topic addressed by the *PROPER* project: development of infection at the damaged site, which can be caused by wear and release of small particles, as well as by bacterial colonization of implanted materials.

The team's methodology relied on identification of the needs of the main stakeholders in the project (orthopaedic firms, surgeons and patients), followed by evaluation of their technological and strategic decisions. This led the team to consider the possibility of applying ceramic coatings on metallic substrates through the HVOF process. This required performing laboratory tests on a number of samples in order to characterize them from a chemical, structural and morphological point of view. The goal of the final part of the activity was the evaluation of a future scenario via preparation of an appropriate business plan. Starting from the problems to be solved and the solution, consisting of thermally sprayed coatings, a business idea was proposed. This involved a start-up to support companies in scouting technologies to solve the above-mentioned issues related to hip and knee prostheses. This activity also involved optimization of the process for specific application to the biomedical field and research activity which dealt with patentability issues.

Thanks to a multidisciplinary approach involving disciplines such as material science, biomedical engineering and management, the activity arrived at a solution in terms of technological, social and economic implications.

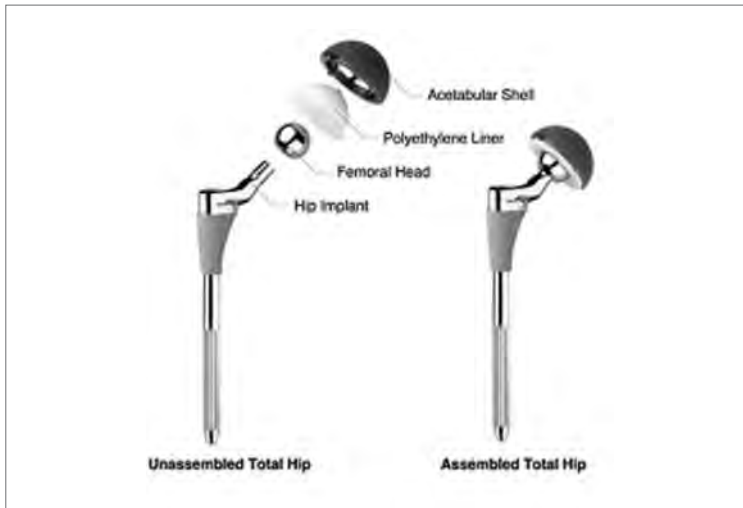

1 HIP prosthesis. Components of a hip prosthesis. Source: <http://www.zimmer.com/ctl?op=global&action=1&id=8140&template=PC>

UNDERSTANDING THE PROBLEM

Joint replacement surgery is becoming more common, in particular as regards hips and knees which are replaced most often to improve and enhance the function of the joint. The life of any joint prosthesis is related to certain complications, one of which is represented by wear of the bearing surfaces which may lead to complications such as osteolysis or component loosening. This problem occurs more frequently in younger, more active patients. The importance of controlling friction and wear resulted in the creation a new scientific discipline called tribology. In the orthopaedic field, all surgeons are familiar with wear issues associated with metal-on-polyethylene, ceramic-on-polyethylene, ceramic-on-ceramic and metal-on-metal articulations. Despite this, they do not always want to take risks by adopting prostheses which involve major changes in terms of materials and design in an attempt to further reduce wear.

Another complication is represented by infection: the risk for orthopaedic device-related infection is increasing as the number of patients requiring orthopaedic implants grows. Certain materials can generate a lot of debris which induces a macrophagic



2 KNEE prosthesis. Components of a knee prosthesis. Source: <http://www.zimmer.com/z/ctl/op/global/action/1/id/8138/template/PC/navid/10415>

reaction and in some cases may contribute to the development of pseudotumors. This can become a serious problem since bacteria cannot be easily eliminated from a joint replacement implant. Despite excellent antibiotics and preventative treatments, patients with a joint replacement infection will often require removal of the implanted joint in order to cure the infection.

EXPLORING THE OPPORTUNITIES

Arthroplasty of the hip began to develop in the 1960s, thanks to Sir John Charnely, a British orthopaedic surgeon who pioneered the hip replacement operation. The hip joint is called a ball-and-socket joint because the spherical head of the thighbone (femur) moves inside the cup-shaped hollow socket (acetabulum) of the pelvis. To duplicate this action, a Total Hip Replacement (THR) implant has three main parts: the stem which fits into the femur, the ball which replaces the spherical head of the femur and the cup which replaces the worn out hip socket. The implant Sir John Charnely conceived comprised a stainless steel stem and a 22-mm head fitting into a polymer socket; both parts were fixed into position by PMMA cement. The femoral stem is al-

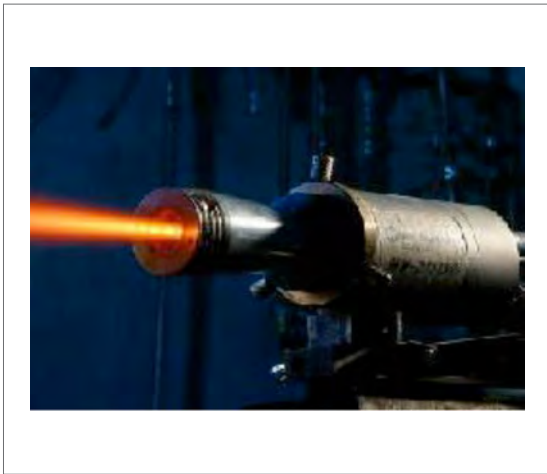

3 High velocity oxy-fuel (HVOF) coating spraying. Coating processing via thermal spray technologies. June 23, 2011. Source: presentation sent by the VTT Technical research Centre of Finland

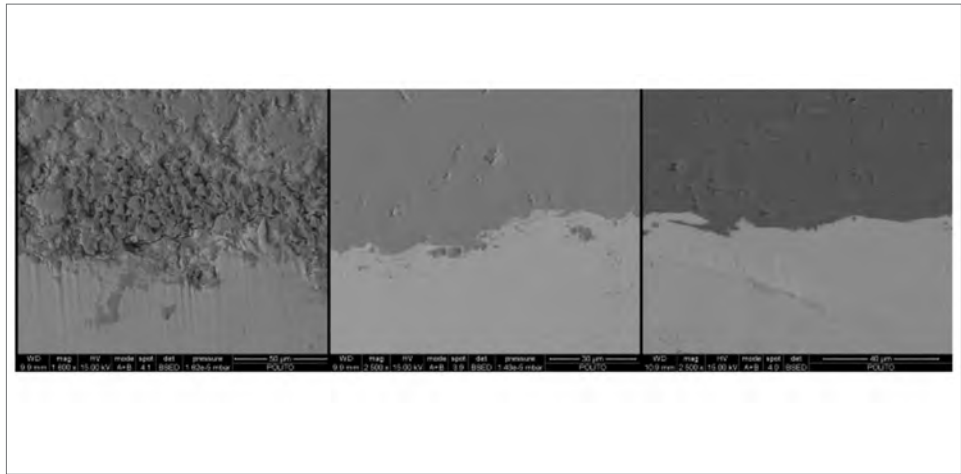

4 Interface of the three samples. Interface analysis using EDS-SEM. April 2, 2012. Author: laboratory technicians from Politecnico di Torino, where characterization tests were performed

ways made of metal; on the other hand, the femoral head can be made of either metallic or ceramic material, while the acetabular socket is usually made of ultra-high molecular weight polyethylene (UHMWPE). Thus, referring to the head-cup coupling, it is possible to deal with metal-on-UHMWPE or ceramic-on-UHMWPE. Other possible combinations used for articulating surfaces include metal-on-metal and ceramic-on-ceramic.

In the early invention era, metals were widely used in THR applications because of their excellent mechanical characteristics and fatigue performance. Three main classes of metallic materials are used: stainless steel, cobalt alloys and titanium alloys. However, the reported failure of the metal-on-metal articulation due to high wear rate (0,1-0,3 mm/year) resulted in a decline of this type of bearing combination and many other material combinations were investigated.

Due to the wear resistance and ease of alignment of polyethylene, it has been widely used.

Ceramic hip replacements were also explored because of their high strength and excellent biocompatibility. Alumina and zirconia are the most preferable ceramics in THR applications. The ceramic-on-ceramic articulation was tested in an effort to de-

crease wear of hip implants, since it has a friction coefficient much lower than metal-on-metal and metal-on-polyethylene combinations, meaning that it generates very little debris and minimizes the chance of macrophagic reactions. Nevertheless, there are problems associated with the use of total ceramic hips: when they were first introduced, there were concerns regarding the incidence of fracture due to their properties which required manufacturing improvements.

Ultra-high molecular weight polyethylene has been recently used in total hip and knee replacements due to its lower friction coefficient, higher biocompatibility and toughness. To further improve wear resistance, highly cross-linked UHMWPE has also been developed.

Knee prostheses have a more complex shape than hip implants, but involve the same issues with regard to the only type of coupling used in this case, that is metal-on-UHMWPE.

GENERATING A SOLUTION

The solution developed aims at reducing the wear of hip prostheses and the release of metallic debris from knee prostheses. The idea consists of the application of high density ceramic

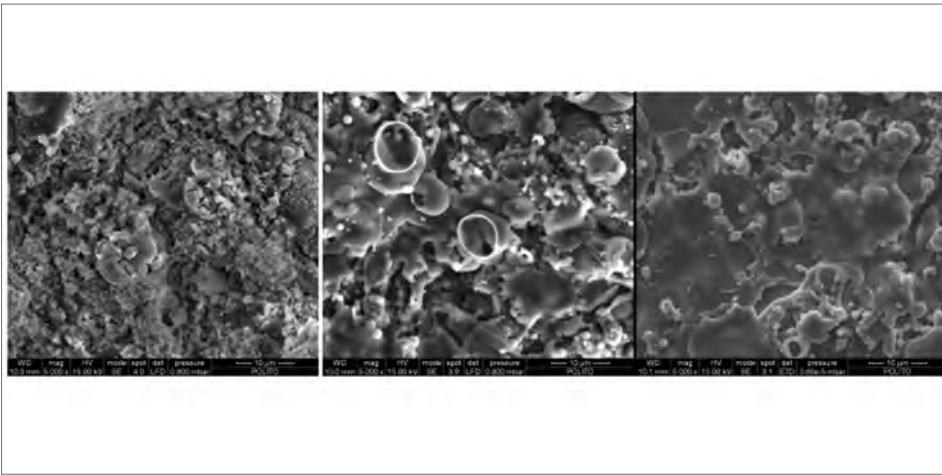

5 Surface of the three samples. Surface analysis using EDS-SEM. March 12, 2012. Author: laboratory technicians from Politecnico di Torino, where characterization tests were performed

coatings on metallic substrates in order to improve the mechanical properties of joint implants. Application of the ceramic coating on the metallic substrate can be accomplished through the high velocity oxy-fuel (HVOF) thermal spray process: it has been used by the Finnish research centre VTT, which has taken a pioneering role in developing a novel concept for the development of low-friction and wear-resistant materials. Indeed, thermal sprayed ceramic coatings offer a cost-effective alternative in modifying component surface properties and are widely applied as wear resistant coatings. The innovation of the proposed idea lies in the application of this particular thermal spray technique to the medical field: in medicine thermal spraying techniques have been used to make coatings on prostheses essentially to replace the cement previously used to ensure a reliable contact between the implant surface and the living bone tissue. To evaluate the feasibility of the proposed idea, a number of characterization tests were performed and a business plan was prepared with the aim of building a start-up company. Such company would be in charge of procurement of implant components to be thermally sprayed and carry out technology scouting with the aim of identifying companies having already developed certain technolo-

gies (such as the HVOF process) that could be applied to solve the wear and infection problem. This activity would also involve optimization of the technology for application to the biomedical field and patentability research.

MAIN BIBLIOGRAPHIC REFERENCES

- [1] Bhatt, H., Goswami, T., 2008. Implant wear mechanism-basic approach. *Biomedical Materials*, 3, 042001 (9pp).
- [2] Rimondini, L., Fini, M., Giardini, R., 2005. The microbial infection of biomaterials: a challenge for clinicians and researchers. A short review. *Journal of Applied Biomaterials & Biomechanics*, 3 (1), 1-10.
- [3] Turunen, E., Varis, T., Hannula, S.P., Vaidya, A., Kulkarni, A., Gutleber, J., Sampath, S., Herman, H., 2006. On the role of particle state and deposition procedure on mechanical tribological and dielectric response of high velocity oxy-fuel sprayed alumina coatings. *Material Science and Engineering A*, 415, 1-11.

SSP



**SWITCHED POSITIVE DYNAMICAL SYSTEMS
FOR CLOUD COMPUTING LOAD BALANCING**



SSP

Switched Positive Dynamical Systems for Cloud Computing Load Balancing

project **14**

*SSP studies optimal allocation for
Cloud Computing load balancing
exploiting the control theory for
switched positive dynamical systems*

PRINCIPAL ACADEMIC TUTOR

Patrizio Colaneri

Electronics, Information and Bioengineering,
Politecnico di Milano

ACADEMIC TUTORS

Paolo Bolzern

Electronics, Information and Bioengineering,
Politecnico di Milano

Marco Gribaudo

Electronics, Information and Bioengineering,
Politecnico di Milano

EXTERNAL INSTITUTION

**CNR, Istituto Nazionale di Fisica
Nucleare**

TEAM A

Marco Agnese [Team Controller]

Mathematical Engineering

Riccardo Cipolleschi [Project

Communication Coordinator]

Computer Engineering

Luigi Colangelo

Aerospace Engineering

Daniele Cozzi

Mathematical Engineering

PROJECT DESCRIPTION

THE CHALLENGE

The project focuses on a very important challenge currently arising in Cloud infrastructure design, namely the problem of optimal allocation of load among virtual machines. Efficient load balancing in a Cloud environment can indeed lead to important benefits for both end users and service providers. In particular, end users can experience a better quality of service in terms of shorter response time and higher availability, whereas service providers can more efficiently exploit their software/hardware resources and reduce costs by energy saving. This latter observation perfectly fits the characteristics of so-called green ICT.

The scenario considered in the project consists of a cluster of servers which have to perform a set of jobs according to a time-varying input flow of requests. The number of active servers is variable since they might be switched on in order to cope with sudden peaks of requests and turned off to reduce energy consumption during idle periods. In addition, jobs should be uniformly allocated among active servers so as to provide a fair and balanced use of resources from the users' viewpoint.

The queue dynamics of service requests lends itself to be described by differential equations involving positive variables. Moreover, the changes in system configuration call for a description in terms of switched dynamical systems. The performance index to be optimized is a trade-off between the number of active servers (which should be kept small to reduce energy consumption) and response time (which might lead to penalties in case of violation of Service Level Agreements).

The project considered a simplified, yet realistic, mathematical model of the overall system. This model is described by a feedback solution which provides, at each time point, the number of active servers and their load share. The proposed solution was simulated in MATLAB®, implemented as a *Software as a Ser-*

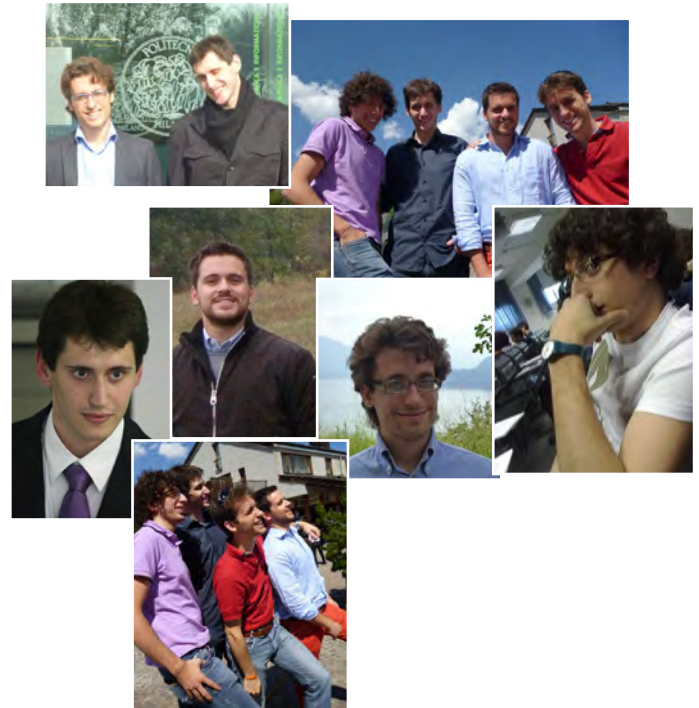

vice on the Microsoft Azure Cloud infrastructure, and tested through a set of benchmarks. The numerical and experimental results showed a good level of agreement. Moreover, measurements resulting from the proposed algorithm were compared with other (classical) resource allocation strategies. As a result, it is possible to affirm that the model-based approach offers a promising alternative to the present state of the art.

Besides the technical aspects, the team worked hard on tackling all the different aspects of the problem, including market analysis and research on current trends in Cloud computing technologies. The various educational backgrounds of members, integrating modeling, simulation, control and computer science, contributed to the success of the project.



Cloud Computing Load Balancing: a model-based approach through Switched Positive Dynamical Systems

— PROPER — FUTURE PERSPECTIVES OF JOINT PROSTHESES

TASKS & SKILLS

Marco Agnese worked on the market analysis focusing on Cloud computing vendors and on a MATLAB® simulation of the designed solution.

Riccardo Cipolleschi studied the state of the art, designed a case study in Azure® and developed the prototype of the designed solution, testing it in a real environment.

Luigi Colangelo worked on Cloud computing controversies and on the definition of user requirements. He interviewed members of the Cloud project group of Telecom Italia®.

Daniele Cozzi developed a preliminary analysis on market forecasts and environmental issues of Cloud Computing and then focused on mathematical formulation of the model.

ABSTRACT

Cloud Computing technologies are the future of the IT world. Every day, a large amount of data is exchanged among every type of electronic device. Our smartphones and computers interact with several services hosted on the Cloud environment, which is becoming larger and larger. Thus, efficiency is a mandatory feature for management of these services.

Our project was born as a technology driven project. However, firstly we performed a broad analysis which provided us with an in-depth understanding of user requirements and also a range of clear objectives. We then defined the main goal of our project as the development of a mathematical model, able to forecast the number of requests that will arrive at the hosted services. From this estimate, the algorithm chooses which service the request should go to and, if needed, switches on a new service or, otherwise, switches off an active service. In this way, it is possible for service providers to save costs, since they pay only for what they use, and optimize resource allocation.

Studying every aspect of the problem, we realized that our framework is quite general and can be applied to both *Infrastructure as a Service and Software as a Service* scenarios. The algorithm we developed is able to choose between services and machines, and can equally start or stop virtual machines and services. Thus, the innovation is twofold. On the one hand, the solution is quite flexible and general since it can be applied at different levels with little effort. On the other hand, the effects it produces in the Cloud environment are definitely something new. In fact, technologies which are able to start and stop services in the Cloud are only now becoming common.

Finally, we developed a prototype of the algorithm, hosted it on a real Cloud environment and gathered some data using a small benchmarking program. We then used this data to validate our ideas. The results seem to confirm that the algorithm is truly able to resize the target service and can save costs in an effective manner.

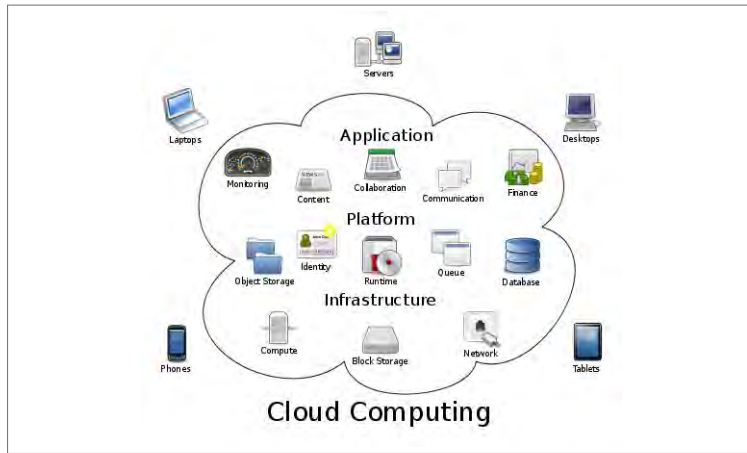

1

UNDERSTANDING THE PROBLEM

In the first phase of the work, following the content of ASP courses, we carried out a broad analysis on Cloud Computing. In this way we achieved a clear understanding of the entire problem. Firstly, we performed a preliminary market and technology analysis in order to understand the current perception of both users and providers towards Cloud Computing. We then considered the controversies affecting stakeholders. Indeed, this innovative technology has great potential but a number of significant drawbacks as well, such as lack of control by software service providers and user concerns regarding their data. In fact, they all have to rely on Cloud Computing providers.

However, one of the key concepts of the Cloud is abolition of any upfront infrastructure investment. It is possible to use resources on demand, simply by paying monthly for what has been used. Small and medium enterprises, which usually do not have enough money to invest in infrastructure, can build their own IT department thanks to this new technology. On this issue, we performed a market diffusion forecast focusing on these companies. The Cloud market is quite young and there is still a lot of room for growth.



2

To deepen our analysis and define user requirements, we gathered some direct information. In particular, we interviewed managers and engineers from “Nuvola Italiana”, the Cloud project of Telecom Italia® and attended several conferences offered by Telecom®, Microsoft® and Google®. This helped us to validate our own analysis. The conferences and interviews showed that the main issue was to provide a service which could satisfy users in terms of quality and cost. Indeed, the final purpose of the project was to find an optimal allocation of Cloud resources, providing, in this way, a better and cheaper service.

EXPLORING THE OPPORTUNITIES

Once having defined the problem, we tried to explore possible solutions. The first step was to study the current state of the art: from load balancing to resource allocation. These are two of the most important enabling technologies of Cloud Computing, together with virtualization. We then studied how several algorithms, already in place, worked. The range of their complexity is very broad. They span from model-free solutions, which simply take a random decision, to rather complex solutions, which leverage concepts from Artificial Intelligence and Queue Theory fields.

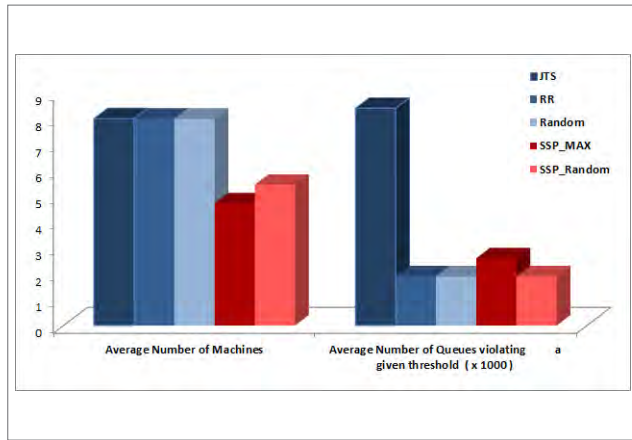

3

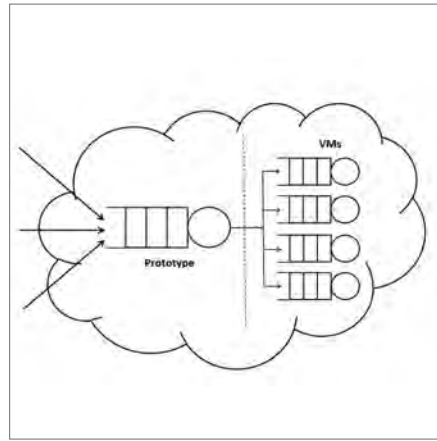

4

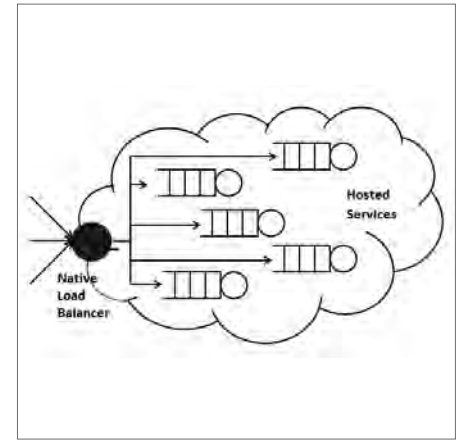

5

To deepen our knowledge, we developed a small experiment which interacted directly with a Cloud service. The experiment was composed of two modules, a traffic generator and a benchmark service. The benchmark was hosted on the Cloud environment of Microsoft Windows Azure® and was targeted by the traffic generator. We gathered some important statistics, for instance which virtual machine handled the single request, and thanks to these we understood how Windows Azure® works. We saw that there was significant margin for improvement.

Analyzing the state of the art, we did not find anything which relied on Control Theory. Thus we developed the very first application of Control Theory to optimal Cloud Computing load balancing. The key feature of this approach is the opportunity to rapidly react to sudden variations in the variables of interest. We believed this to be a desirable feature for an efficient solution. The drawback of this approach is the problem modeling complexity. To successfully apply a control system, the model must be as accurate as possible and, often in a Cloud environment, it is not possible to know exactly the evolution of requests submitted by clients.

We also considered other possible solutions, for instance a model based on Queue Theory, but the key point of rapid adaptation

to sudden change was missing. Finally, we decided that a mixed Control and Queue theory model would have been an interesting solution. In this way, this mixed model would be able to benefit from both the basic theories.

GENERATING A SOLUTION

Generation of the solution followed three main steps: a theoretical phase, a simulation phase and, finally, development of a prototype. During the theoretical phase, the teamwork with tutors first focused on the definition of a mathematical framework to model the problem. The teamwork then studied possible techniques to find a solution. Starting from a simple instance of the problem, we added several details generalizing the model up to a more realistic version. The model developed describes a set of Cloud services as a system of queues, whose sizes change over time. By monitoring the evolution of the queues, it is possible to forecast how many requests are expected at a given time. Thus, the algorithm can decide to switch a new service on, or to switch an existing service off. This completely changes the values the estimate relies on, because now we can have a new queue in the system and all the values must change accordingly. In the literature and in practice there are no solutions which are able to resize their dimensions in such a fully autonomous manner.

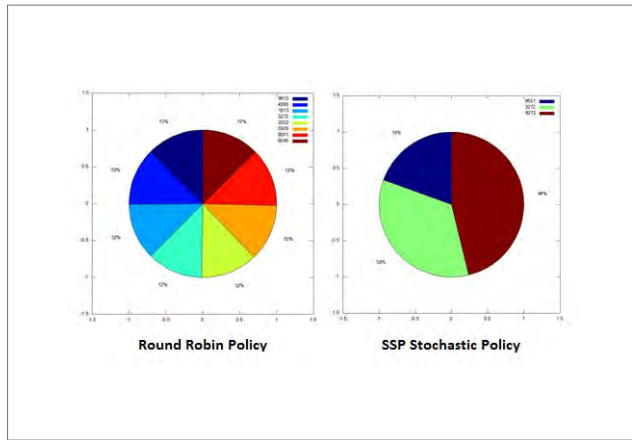

6

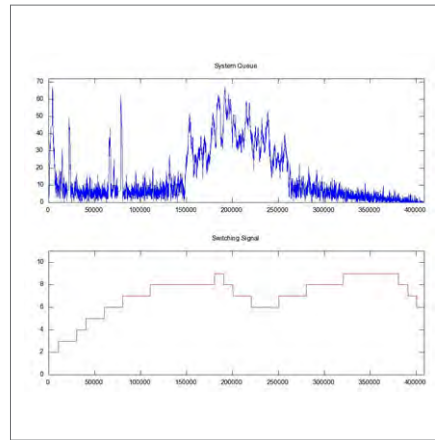

7

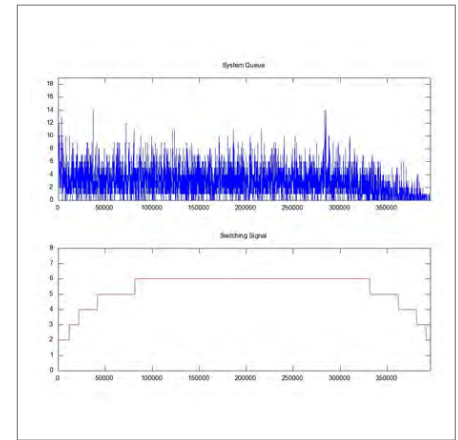

8

The simulation, developed with MATLAB®, was a first important confirmation of model feasibility. It also helped us in dimensioning a number of its parameters and provided certain suggestions concerning the behavior of the model in a real application. From the simulation, we developed two measures of costs, in order to check whether the model was working well, and adopted them in the final prototype.

The prototype consists of a software module written in Java, leveraging the Servlet framework, which works as a dispatcher between user requests and the target services. It was designed to be adaptable and extendable, since it can be easily configured and new control policies can be added. Its task is very simple: it receives a request from a client, observes queue status and estimates and, evaluating all this information, decides which service the request should be addressed to. At the same time, it keeps an estimate of request arrivals and, when these become too high, switches on new services to handle the peak.

The strength of this solution is that it is fully autonomous and requires a very low configuration effort. Moreover, as the experimental results show, it provides a real cost saving. The main

drawback of this approach is that it adds a new layer between the requests and the service: if not properly tuned, it could generate delays in the service. The work we have accomplished is a first important step in the direction of efficient load balancing. Of course, there is still ample margin for improvement at various levels. For instance, implementation of the dispatcher at a lower level could improve performances or schedule the switching on and off of services at particular times. Thus, it is not surprising that a large corporation such as Microsoft® is working on a similar solution, called WASABi [2], which tries to accomplish the same result we were striving for, but in a less automatic manner and which works only within its own Cloud solution.

MAIN BIBLIOGRAPHIC REFERENCES

[1] Armbrust, M. et al. (2009) “Above the Clouds: A Berkeley View of Cloud Computing”, Technical Report No. UCB/EECS-2009-28, University of California at Berkley, USA.
 [2] Microsoft, Pattern and Practice, “The Autoscaling Application Block” Microsoft, 7 June 2012, [http://msdn.microsoft.com/en-us/library/hh680892\(v=pandp.50\).aspx](http://msdn.microsoft.com/en-us/library/hh680892(v=pandp.50).aspx)