

Cascading Hazard Analysis of a Hospital Building

*Original*

Cascading Hazard Analysis of a Hospital Building / Marasco, Sebastiano; ZAMANI NOORI, Ali; Cimellaro, GIAN PAOLO.  
- In: JOURNAL OF STRUCTURAL ENGINEERING. - ISSN 0733-9445. - ELETTRONICO. - 143:9(2017), p. 04017100.  
[10.1061/(ASCE)ST.1943-541X.0001808]

*Availability:*

This version is available at: 11583/2674896 since: 2018-03-21T11:32:04Z

*Publisher:*

American Society of Civil Engineers (ASCE)

*Published*

DOI:10.1061/(ASCE)ST.1943-541X.0001808

*Terms of use:*

This article is made available under terms and conditions as specified in the corresponding bibliographic description in the repository

*Publisher copyright*

(Article begins on next page)

## CASCADING HAZARD ANALYSIS OF A HOSPITAL BUILDING

Sebastiano Marasco<sup>1</sup>, Ali Zamani Noori<sup>2</sup>, and Gian Paolo Cimellaro<sup>3</sup>

### ABSTRACT

Recently, multi-hazards engineering has received more attention to analyzing the behavior of a system exposed to different types of hazards and to estimate the loss data from cascading events attributed to the primary hazard. In this paper, the principle of multi-hazards was investigated and a new methodology was developed to assess the total damage of structural elements caused by cascading hazards. For each hazard, a physical model is used to assess the conditional probability of exceeding a certain intensity level due to the occurrence of the previous hazard. The method was applied to a hospital located in California, US, subjected to the three cascading hazards (earthquake, blast, and fire). Non-linear time-history analyses were performed using seven ground motions scaled to five different earthquake levels and the seismic response of the structure was evaluated. The seismic input produces damage to the hospital's power supply (Liquid Propane Gas reservoir tank) which may cause a blast. The probability of explosion was estimated by taking into account the probabilities of fuel leakage, fuel concentration, and ignition. A set of nine blast intensity levels was considered in the analyses, corresponding to different quantities of fuel content inside the tank. Afterward, a fire hazard is generated following the explosion, whose intensity level was evaluated using the compartmental heat flux. The fire effects were modeled assuming an increment of temperature in the steel frames. The proposed multi-hazard approach can be used for both improving the structural safety and reducing the building life cycle costs to enhance in the end, the resilience of

---

<sup>1</sup>Ph.D. Student, Department of Structural, Geotechnical and Building Engineering, Politecnico di Torino, Italy, E-mail: [sebastiano.marasco@polito.it](mailto:sebastiano.marasco@polito.it).

<sup>2</sup>Ph.D. Student, Department of Structural, Geotechnical and Building Engineering, Politecnico di Torino, Italy, E-mail: [ali.zamani@polito.it](mailto:ali.zamani@polito.it).

<sup>3</sup>Visiting Professor, Department of Structural & Environmental Engineering, University of California, Berkeley, Berkeley, USA, E-mail: [gianpaolo.cimellaro@polito.it](mailto:gianpaolo.cimellaro@polito.it).

23 the hospital. Results show that this methodology can be used to provide risk mitigation measures  
24 within a more general resilience framework.

25 **Keywords:** Cascading hazards; Earthquake; Fire; Blast; Damage; Resilience.

## 26 INTRODUCTION

27 Latest disasters have shown that large parts of the world are subjected to multiple natural, manmade,  
28 and artificial hazards. The rising of global population and the massive economic development in  
29 areas prone to disasters have increased the chance of multiple catastrophic incidents, which lead to  
30 disruption of buildings and infrastructures. After realizing that multi-hazard cannot be averted,  
31 modern societies are trying to enhance their capacity to withstand and to minimize the impact of  
32 multi-hazard on community infrastructure and human beings. Therefore, multi-hazard engineering  
33 and related mitigation risks are prompting attention in the topic of design and retrofitting of buildings  
34 and infrastructures.

35 The concept of multi-hazard is defined as the “implementation of methodologies and approaches  
36 aimed at assessing and mapping the potential occurrence of different types of natural hazards in a  
37 given area. The employed methods have to take into account the characteristics of the single  
38 hazardous events as well as their mutual interactions and interrelations” (Delmonaco et al. 2006).

39 Multi-hazard design starts with the structural and non-structural analysis for individual hazard. The  
40 location, magnitude, and frequency of occurrence of each hazard have to be estimated through a  
41 probabilistic approach. Several probabilistic approaches have been proposed for multi-hazard risk  
42 assessment. A quantitative risk analysis of industrial facilities in a seismic area was carried out by  
43 Fabbrocino et al. (2005) taking properly into account the multi-hazard effects. An oil storage plant  
44 with several atmospheric steel tanks containing flammable materials was considered as a case study.  
45 The vulnerability of the steel tanks was estimated through a quantitative probabilistic seismic risk  
46 analysis. The response of the industrial equipment was expressed in terms of limit states defined in  
47 accordance with the post-earthquake damage observations and the consequence analysis was

48 performed. Asprone et al. (2010) assessed the blast damage for a four-story reinforced concrete  
49 building in addition to seismic fragility. A possible blast scenario was assumed during the service life  
50 of a building located in a seismic zone, and then the probability of progressive collapse was  
51 calculated using a Monte Carlo simulation procedure.

52 Recent evaluation of post-disaster effects has led to the implementation of significant changes in the  
53 modeling and numerical assessment of multi-hazards. Padgett et al. (2010) evaluated hazard  
54 intensities to accurately predict the vulnerability of bridges using a multivariate regression analysis  
55 of the data obtained by surveys after Hurricane Katrina.

56 More specifically, when considering multi-hazard, the assessment has to be performed by comparing  
57 risks of cascading mechanisms related to the triggered hazard event. For instance, the impact of an  
58 earthquake on a gas pipeline may initiate gas leakage, which may likely cause an explosion. There  
59 are several examples of sequential hazards initiated by earthquakes which have caused fire such as  
60 San Francisco (1906), Tokyo (1923), Kobe (1995), and Northridge (1994) earthquakes (Usmani  
61 2008). The risk assessment of structures that are exposed to more than one hazard is determined by  
62 adopting the performance-based approach. Bruneau et al. (2006) investigated the performance of  
63 steel piers under seismic action. The simulation of large-magnitude earthquakes and the consequent  
64 explosions confirmed the capacity of the materials to resist to earthquakes and blast separately, but  
65 not a simultaneous combination of the two hazards (Bruneau et al. 2006). A novel assessment  
66 method was suggested by Barbato et al. (2013) to evaluate the individual impacts of the interaction  
67 among hurricane wind, flood, windborne debris, and rainfall hazards in the Performance-Based  
68 Hurricane Engineering (PBHE) framework.

69 Furthermore, disasters are catastrophic to the socio-economic activities and affected communities  
70 (Lindell et al. 2006). Federal Emergency Management Agency (FEMA) developed HAZUS-MH  
71 (2011) to perform multi-hazard analysis. It is capable of estimating economic, physical and social  
72 effects by providing access to the average annualized loss and probabilistic results from the hurricane  
73 wind, flood and earthquake models and combining them.

74 The combination of cascading hazards to evaluate the real performance of a structure is among the  
75 most difficult tasks due to the intricacy involved in the process. Although the use of current  
76 probabilistic approaches is perceived as an important instrument to quantify the total loss, developing  
77 a simplified probabilistic methodology is clearly challenging. In this paper, a new approach to  
78 estimate the total amount of structural damage caused by series of cascading hazards is proposed.  
79 Earthquake, blast, and fire were considered as sequential hazards and numerical analyses were  
80 performed to assess the fragility functions for each hazard. The combination of the structural damage  
81 for cascading hazards was evaluated according to Bayes' theorem. The conditional probability of  
82 exceeding a certain intensity level due to the occurrence of triggered hazard with a given intensity  
83 level was estimated by using physical models that take into account the vulnerability of a structural  
84 component. The methodology was applied to a steel structure hospital located in California, US.  
85 The first section of the paper will provide a detailed description of the proposed methodology, while  
86 the second part will illustrate its applicability through a case study building. Lastly, a numerical  
87 example of total structural damage estimation is performed.

## 88 **PROPOSED METHODOLOGY**

89 The application of the multi-hazard approach can improve the safety of structures and minimize life  
90 cycle costs and human losses. In the Performance-Based Earthquake Engineering (PBEE) framework  
91 (Porter 2003), the structural performance is conventionally expressed in terms of probability to  
92 exceed a stated performance objective when the structure is subjected to a certain level of hazard as  
93 follow:

$$94 \quad P(DV) = \iiint p(DV | DM) \cdot p(DM | EDP) \cdot p(EDP | IM) \cdot p(IM) \cdot dDM \cdot dEDP \cdot dIM \quad (1)$$

95 where  $DV$  identifies the Decision Variable,  $DM$  represents the Damage Measure,  $EDP$  is the  
96 Engineering Demand Parameter, and  $IM$  is the Intensity Measure that characterizes the hazard.

97 The term  $p(IM)$  represents the density probability function of exceeding a certain IM for a given  
 98 hazard. In the case of cascading events, the correlation in terms of total exceedance probability of a  
 99 given IM ( $P(IM_i \geq im_i)$ ) has to be estimated through the associated conditional probability (see Fig. 1).  
 100  $P(IM_i \geq im_i | IM_{i-1} \geq im_{i-1})$  represents the conditional probability of exceeding an IM for the  $i^{th}$  hazard  
 101 ( $IM_i \geq im_i$ ) due to a given IM for the  $(i-1)^{th}$  hazard ( $IM_{i-1} \geq im_{i-1}$ ).

102 In a multi-hazard scenario, the effects of different hazards combination (chain effects) have to be  
 103 considered. The damage caused by the occurrence of a hazard generates a degradation of the  
 104 Structural Parameters (SP) that influences the response of the structure subjected to the next  
 105 sequential hazard. The PBEE framework for multiple cascading hazards is shown in Fig. 2. To  
 106 consider the multi-hazard cascading effects, Eq. (1) can be rewritten as

$$107 \quad P(DV) = \iiint p(DV | DM) \cdot p(DM | EDP) \cdot p(EDP | IM, SP) \cdot \left[ \prod_2^n p(IM_i | IM_{i-1}) \right] \cdot p(IM_1) \cdot p(SP) \cdot dDM \cdot dEDP \cdot dIM_1 \cdot dSP$$

108 (2)

109 where  $IM_1$  indicates the intensity measure parameter associated with the main hazard (triggered  
 110 hazard), the index  $i$  refers to  $i^{th}$  hazard, and  $n$  is the total numbers of cascading hazards.

111 Considering a multi-story building, the degradation of their structural characteristics (stiffness,  
 112 strength, and damping) is evaluated according to FEMA P440A (FEMA 2009) (see Fig. 3).

113 Assuming a rigid horizontal diaphragm, the general component of the reduced stiffness matrix is  
 114 calculated by

$$115 \quad k_{f,jj} = 12 \cdot \frac{E_{f,j} \cdot I_j}{h_j^3} \quad (3)$$

116 where  $k_{f,jj}$  is the reduced stiffness component,  $E_{f,j}$  is the reduced elastic modulus, and  $I_j$  and  $h_j$  are the  
 117 inertia and height for the  $j^{th}$  story, respectively. The damping matrix is evaluated according to the  
 118 Rayleigh formulation considering the reduced stiffness matrix.

119 The estimation of the probability of exceeding an IM for a hazard due to a given IM for the previous  
 120 hazard is provided by using specific physical models. As an example, a steel tank containing  
 121 flammable materials located in a seismic zone is considered. The probability to have an explosion of

122 the tank due to an earthquake with a given intensity level depends on the ignition mechanism of the  
123 fuel content and on the failure modes of the tank. A physical model has to be capable of describing  
124 the seismic fragility of the tank by identifying the most probable failure modes and the consequent  
125 fuel release mechanism.

## 126 **CASE STUDY**

127 The case study considered earthquake, blast, and fire as series of cascading hazards. A five-story  
128 steel building, located in Oakland, California, was designed according to the requirements of ASCE  
129 7-10 (ASCE 2010). The basic building plan dimensions are 82.3 m (270 ft) by 33.7 m (110.5 ft),  
130 with bays spanning of 9.1 m (30 ft) and 12.3 m (40.3 ft) in X and Y directions, respectively (see Fig.  
131 4 and Fig. 5). The stories height is equal to 4.6 m (15 ft) and the structure was classified as regular in  
132 both plan and elevation. The building is located on the relatively soft rock (site class C with  
133 reference shear wave velocity ranging from 365.8 m/s (1200 ft/s) to 762 m/s (2500 ft/s) according to  
134 ASCE 7-10 (ASCE 2010). The building has special steel moment resisting frame in the longest  
135 direction (X-direction) and bracing system in the other direction (Y-direction). The designs of the  
136 two considered lateral resisting systems are compliant with the code standards for design according  
137 to the equivalent lateral force method (ASCE 2010). The W shape were used for beams and columns  
138 while hollow structural sections (HSS) were designed for the bracing system (see Fig. 4 and Fig. 5).  
139 The building's design comply with the occupancy category IV allowing the building to serve as a  
140 hospital and accordingly an importance factor equals to 1.5 was considered in the seismic design.  
141 The special steel moment resisting frame was designed with considering a response modification  
142 factor (R) of 8 while the bracing system was designed with a response modification factor (R) of 6  
143 considering the special steel concentrically braced frame according to ASCE 7-10 (ASCE 2010). The  
144 P- $\Delta$  effects from the gravity columns were considered and the effects of large deformations of beam  
145 and column elements were accounted for utilizing P- $\Delta$  nonlinear geometric transformation.

146 A standby power system was designed for providing an alternative source of electrical power for the  
147 building and facilities in case of power outage. This system includes an above ground Liquid  
148 Propane Gas (LPG) tank equipped with power sources, transfer equipment, controls, supervisory  
149 equipment and accessory which are located outdoor. The tank was designed to provide a total power  
150 of 2500 kVA and to maintain full capacity about 8 hours. The fuel capacity of the tank was assumed  
151 equals to 718 l (190 gal) per hour at full load. Thus, the total LPG tank has a capacity of 3597 l (950  
152 gal). The tank is 9.2 m (30 ft) away from the building according to National Fire Protection  
153 Association (NFPA 2013). The Fig. 6 illustrates the geometric configuration of the LPG tank and  
154 Fig. 7 shows its orientation with respect to the building.

155 The sequence of hazards triggered by the earthquake is not known and depends on the localization of  
156 the high-risk potential elements inside and/or outside the analyzed structural system as well as their  
157 level of damages. As an example, Fig. 8 represents the logical tree of multi-hazard sequence for  
158 healthcare facilities.

159 The earthquake occurs and it causes damage to both building elements and external fuel tank. The  
160 damaged tank may start fuel leakage and continues for a while in which gas ignites and causes  
161 deflagration of the fuel inside the tank. Then, the explosion of the tank could generate an impulsive  
162 air pressure load on the building façade which would cause localized damage to structural  
163 components. The heat released by the tank explosion may cause the ignition of the inflammable  
164 materials inside the buildings. In a short time, the ignition generates flashover and fire propagates  
165 through the building compartment.

## 166 **HAZARD ANALYSIS**

### 167 **Earthquake**

168 The case study building is located in Oakland, California, US (Lat: 37.7792, Long: -122.1620).

169 Three hazard levels: 2%, 10%, and 50% probabilities of exceedance in 100 years were selected,  
170 representing Collapse Prevention (CP), Life Safety (LS), and Immediate Occupancy (IO),



171 respectively (FEMA 2000). To better characterize the seismic hazard at the site, two additional sets  
172 of records representative of hazard levels at 5% and 20% probabilities of exceedance are also used in  
173 the analysis. The mean value of moment magnitude ( $M_{w,mean}$ ) and epicenter distance ( $R_{mean}$ ) with the  
174 logarithmic spectral offset at reference period ( $\varepsilon(T_{ref})$ ) were evaluated according to Boore-Atkinson  
175 attenuation law (Boore and Atkinson 2008) for each Hazard Level (HL). All data can be found  
176 through the interactive de-aggregation of USGS (<http://geohazards.usgs.gov/deaggint/2008/>) (USGS  
177 2013). The shear wave velocity at the uppermost 30 m has been assumed equal to 736 m/s (2415 ft/s)  
178 according to Global Vs30 Map Server (<http://earthquake.usgs.gov/hazards/apps/vs30/>) (USGS 2013).  
179 A new Ground Motion Selection and Modification (GMSM) procedure (Marasco and Cimellaro  
180 2017) was used to minimize the dispersion values of the Engineering Demand Parameter (EDP)  
181 calculated through dynamic analyses. The new GMSM is based on the energy content in the  
182 frequency domain of the motions and it was carried out for the five HL. Seven groups of acceleration  
183 histories (for both horizontal directions) were selected for each HL in such a way to match the target  
184 spectrum at reference period of the building according to ATC P-58 (FEMA 2012). The Conditional  
185 Mean Spectrum (CMS- $\varepsilon$ ) obtained from the de-aggregation study was considered as target spectrum  
186 (Baker 2010). The Boore-Atkinson attenuation model (Boore and Atkinson 2008) was used to define  
187 the predicted spectral accelerations at the site (USGS 2013), while the Baker and Jayaram model was  
188 considered as correlation law (Baker and Jayaram 2010). Since the building is regular, the first  
189 period was selected as conditioning period ( $T_{ref}$ ). The five CMS and the thirty-five groups of motions  
190 were obtained through the software OPENSIGNAL 4.1 (Cimellaro and Marasco 2015). A  
191 comparison between the target spectrum and the mean spectrum for HL of 2% and 5% in 100 years  
192 is depicted in Fig. 9 . For each HL, the mean spectrum was obtained as an average of the seven  
193 groups of spectra. The mean spectrum-compatibility is satisfied into the reference range of period  
194 (highlighted in grey in Fig. 9).

195 Furthermore, the spectral acceleration at reference period ( $S_a(T_{ref})$ ) was considered as seismic IM  
196 parameter in the analyses. Table 1 resumes the values of the IM parameters for each HL obtained

197 from the CMS- $\varepsilon$  spectra. The maximum value of spectral acceleration denotes a strong seismic action  
198 that may occur with a 2% of probability of exceedance in 100 years.

## 199 **Blast**

200 After an earthquake, the supply system (fuel tank, electrical components, etc.) may be slightly or  
201 severely damaged. Damage in the valves, connections or pipes of a fuel tank generates a fuel leakage  
202 that may cause an explosion. If the fuel concentration is less than the flammable concentration range  
203 or if the ignition sources are lacking, the explosion cannot occur. The three main factors influencing  
204 the explosion occurrence are the fuel leakage, concentration of fuel, and ignition source. Thus,  
205 considering the three parameters as stochastic variables, the total conditional probability of  
206 exceeding an IM for blast ( $IM_B \geq im_B$ ) due to a given IM for earthquake ( $IM_E \geq im_E$ ) is expressed as

$$207 \quad P(IM_B \geq im_B | IM_E \geq im_E) = P_L \cdot P_{FC} \cdot P_I \quad (4)$$

208 where  $P_L$  represents the probability of fuel leakage,  $P_{FC}$  is the probability to have maximum fuel  
209 concentration and  $P_I$  defines the probability of ignition.

210 Since the tank is relatively small in size, it is reasonable to assume that the damage occurs in the pipe  
211 connected to the tank. According to ATC P-58-2 (FEMA 2012), the probability to have large gas  
212 leakage for small diameter piping system ( $D < 2.5$  in) is given in terms of a fragility function with  
213 accelerations as EDP ( $\mu = 1.1g$ ,  $\beta = 0.5$ ). The probability to have maximum gas concentration was  
214 estimated considering the pipe failure relative to the rigid joint connection. A simplified dynamic  
215 model was developed to assess the maximum horizontal drift of the pipe.

216 The tank was considered as a rigid body upon shear flexible legs. The tank is fully restrained at the  
217 base by the anchor bolts designed according to ASCE 7-10 (ASCE 2010).

218 The dynamic behavior of the tank depends on the Fuel Quantity ( $F_Q$ ) inside the tank. This parameter  
219 was considered as a stochastic variable normally distributed and nine different exceedance  
220 probabilities were considered as shown in Table 2. Since the LPG tank has to supply energy in the  
221 emergency conditions, its fuel quantity during an earthquake may not be less than a given minimum

222 threshold. In the case study, a normal distribution of the fuel quantity was assumed with a mean  
 223 value of 70% of the maximum quantity and standard deviation of 10. These parameters were selected  
 224 to accomplish a reasonable functionality of the supplying tank in case of emergencies. Since the tank  
 225 was designed to supply energy to the hospital in the case of power outage, the probability to have  
 226 low fuel volume was assumed close to zero. Furthermore, the exceedance probability to have 100%  
 227 of fuel quantity was fixed to 1.

228 Maximum fuel concentration ( $FC_{max}$ ) is assumed to happen when the shear failure occurs in the  
 229 vertical pipe. According to this hypothesis and considering the maximum shear stress value on the  
 230 cross section of the pipe, the failure spectral acceleration ( $S_{a, failure}$ ) is calculated by

$$231 \quad S_{a, failure} = \frac{45.44}{g} \cdot \left( \frac{f_{u,d}}{E} \right) \cdot \left[ \frac{L_v^3}{(D_e^2 - D_i^2)(D_e^2 + D_e \cdot D_i + D_i^2)} \right] \cdot \frac{1}{T_{tank}^2} \quad (5)$$

232 where  $f_{u,d}$  and  $E$  represent the ultimate stress and elastic modulus of the steel, respectively,  $D_e$  and  $D_i$   
 233 are the external and internal pipe diameter, and  $L_v$  is the length of the vertical pipe, and  $g$  is the  
 234 gravity acceleration.

235 The spectral acceleration at the reference period of the tank ( $S_a(T_{tank})$ ) related to each selected ground  
 236 motion was considered as the first IM parameter ( $IM_1$ ) and fuel quantity as the second IM parameter  
 237 ( $IM_2$ ). Then, for each IM value, the spectral acceleration at the reference period of the tank was  
 238 compared with failure spectral acceleration. When  $S_a(T_{tank})$  is greater than  $S_{a, failure}$ , the failure of the  
 239 pipe occurs and the probability to have maximum fuel concentration is assumed equal to 1 and 0  
 240 otherwise. Then, a tridimensional fragility surface was developed by fitting a lognormal distribution  
 241 of the obtained results.

242 Ignition probability is estimated according to the maximum released fuel quantity. The charts  
 243 provided by International Association of Oil and Gas Producers (IAOGP 2010) were used to estimate  
 244 the probabilities of hydrocarbon releases ignition for several scenarios. The total ignition probability  
 245 is considered as the sum of immediate and delayed ignition. Only delayed ignition probability was  
 246 considered in the case study since immediate ignition needs sources close to the fuel leakage point.

247 The release of flammable gases from small onshore LPG plant was considered as ignition scenario  
248 according to IAOGP (IAOGP 2010) and the related probability function was assumed (see Fig.  
249 10(c)).

250 The probability of gas leakage, maximum gas concentration, and ignition are shown in Fig. 10.  
251 Maximum gas concentration ( $FC_{max}$ ) was calculated according to the Bernoulli's principle assuming  
252 failure of the pipe ( $FC_{max}=29.70 \text{ kg/s}$ ) and the related probability was derived (see Fig. 10(c)).  
253 Finally, the conditional probability of exceeding an IM for blast ( $IM_B \geq im_B$ ) due to a given IM for  
254 earthquake ( $IM_1=Sa(T_{tank}) \geq im_1$ ,  $IM_2=F_Q \geq im_2$ ) is calculated by using Eq. (2) (see Fig. 11).

255 The fuel quantity does not have a considerable influence while the spectral acceleration at the period  
256 of the tank provides a sensitive contribution especially for values greater than 0.5 g.

## 257 **Fire**

258 The probability to have fire inside the building is related to the heat transmission due to the tank  
259 blast. Assuming the nine different exceedance probabilities for the fuel quantity, the heat flux ( $q_f$ ) for  
260 each point of the building in front of the tank was calculated according to the Stefan Boltzmann's  
261 law. The combustion temperature of LPG was assumed equal to 2300 K° (Costin 2014), the  
262 transmissivity coefficient in the atmosphere as 0.66, and the transfer configuration factor was  
263 calculated for the entire external panel of the building (meshed with 0.5×0.5 m elements). Only the  
264 opening surfaces (windows, doors, etc.) on the façade were considered as susceptible to trigger fire  
265 inside the building. The internal walls are located between each two adjacent columns. Furthermore,  
266 the ceiling and the internal walls of the building are composed by fireproof gypsum plasterboard  
267 with steel studs. Thus, each fire compartment was identified as the volume confined between  
268 adjacent columns (see Fig. 12) and ceiling.

269 The minimum value of heat flux capable of igniting the common flammable materials in a room was  
270 assumed equal to 30 MJ/m<sup>2</sup> (Babrauskas and Krasny 1985). For each considered fuel quantity, the  
271 surfaces of the building façade having a heat flux greater than 30 MJ/m<sup>2</sup> is identified (see Fig. 13).

272 The fire may propagate through the opening surfaces located within the heat flux surface for a given  
273 fuel quantity (see Fig. 13) and the number and localization of the compartments under fire were  
274 identified (see Table 3).

275 When the calculated heat flux is greater than the considered limit, the estimated conditional  
276 probability to have ignition of elements inside the building was assumed equal to 1, and 0 otherwise.

277 The conditional probability of exceeding an IM for fire ( $IM_F \geq im_F$ ) due to a given IM for blast  
278 ( $IM_B = F_Q \geq im_B$ ) was estimated ( $P(IM_F \geq im_F / IM_B \geq im_B)$ ) by fitting a lognormal distribution of the  
279 obtained results (see Fig. 14). A mean  $\mu=40\%$  and standard deviation  $\beta=0.95$  were estimated for the  
280 lognormal cumulative density probability (see Fig. 14).

## 281 282 **SRTUCTURAL ANALYSIS**

### 283 **Earthquake**

284 The time history analyses were performed on a three-dimensional steel structure utilizing SAP2000  
285 (Computers and Structures, Inc.). The nonlinearity of the structural elements was taken into account  
286 according to concentrated plasticity model. According to FEMA 356 (FEMA 2000), *Steel-beams*  
287 *Flexural Hinge* (type *Moment M3*) was used for beam elements while *Steel-column Flexural Hinge*  
288 (type *P-M2-M3* with  $M-\chi$  cylindrical domain) was applied for columns. The plastic hinges for brace  
289 elements were modeled as *Steel-braces Axial Hinges*. 3% of damping ratio was assigned to the  
290 frames using Rayleigh damping formulation with control frequency of 1.00 and 2.85 rad/s. The  
291 nonlinear dynamic analyses were performed using non-linear direct integration method, taking into  
292 account P- $\Delta$  effects and applying the horizontal acceleration time histories in the two principal plan  
293 directions of the building model.

### 294 **Blast**

295 Estimation of blast load parameters was focused in the number of studies during the last decades and  
296 several methods were proposed to determine the explosion wave properties. U.S. Army Technical  
297 Manual (TM5-1300 1990) is a widely used standard which presents a series of charts to determine

298 the basic parameters of blast loads. Charts provided by TM5-1300 were used in order to establish the  
 299 blast load parameters required in structural analysis. As a general practice, the magnitude and  
 300 distribution of the blast load are a function of the quantity of output energy released by detonation,  
 301 charge weight ( $W$ ), and the stand-off distance of explosive relative to the particular target ( $R$ ).  $W$  is  
 302 expressed as an equivalent weight of trinitrotoluene (TNT) and blast wave demands were determined  
 303 in a function of universal scaled distance parameter ( $Z = R / W^{1/3}$ ). TNT equivalent charge weight of  
 304 LPG fuel is given by (Sutton et al. 1975)

$$305 \quad W_{TNT} = \varepsilon \frac{\Delta H_{C_{LPG}} W_{LPG}}{\Delta H_{C_{TNT}}} \quad (6)$$

306 where  $W_{TNT}$  is TNT equivalent charge weight of LPG (kg),  $W_{LPG}$  is weight of LPG (kg), and  $\Delta H_{C_{LPG}}$  is  
 307 LPG heat of combustion equals to  $1.099 \times 10^7$  (cal/kg),  $\Delta H_{C_{TNT}}$  is TNT heat of combustion equals to  
 308  $1.109 \times 10^6$  (cal/kg). The unitless parameter  $\varepsilon$  is a term empirically equals to 0.1, and takes in account  
 309 the partial combustion and physical difference between TNT and gaseous explosion. In addition, an  
 310 empirical weight equivalency factor to consider the effect of the tank shell was considered as  
 311 (SBEDS 2008).

$$312 \quad W_b = \left[ 0.2 + \frac{0.8}{(1 + W_c / W)} \right] W \quad (7)$$

313 where  $W_b$  is equivalent bare charge weight (kg),  $W$  is charge weight inside casing (kg), and  $W_c$   
 314 represents the weight of casing (kg). The spectral accelerations of the tank for each HL were  
 315 considered as first IM (IM<sub>1</sub>), while nine different fuel quantities representative of the second IM  
 316 (IM<sub>2</sub>) (ranging from 55% to 100%) were assumed for performing blast analyses were considered (see  
 317 Table 2).

318 Detonation of an explosive releases a large-scale of energy in terms of compressed air in a short  
 319 period of time (blast wave). Blast wave generates an instantaneous rise to the value of pressure ( $P_{so}$ )  
 320 above ambient pressure ( $P_o$ ). Then blast shock expands with very high velocity outward from the

321 explosion source into the surrounding areas (positive-pressure phase). As the blast wave travels into  
322 increasingly larger areas, the energy of blast wave is dissipated and positive incident pressure at the  
323 front decays. Within milliseconds of time, the air front pressure may drop below the normal  
324 atmospheric pressure over the time period ( $t_o$ ) which creates partial vacuums (negative-pressure  
325 phase). The negative phase is usually of a longer duration ( $t_o^-$ ) than the positive phase and its  
326 amplitude ( $P_{so}^-$ ) is less than the ambient atmosphere pressure. When the blast wave encounters  
327 structure, reflection increases the overpressure to a maximum pressure ( $P_r$ ) which is greater than the  
328 peak incident pressure ( $P_{so}$ ) (see Fig. 15(a)).

329 The reflected pressure is a function of the incident angle (between the shock wave and the line  
330 perpendicular to the target surface) and the incident pressure. The maximum reflected pressure and  
331 corresponding total reflected impulse ( $i_r$ ) were calculated through provided charts by TM5-1300. For  
332 design purpose, the blast time history overpressure was idealized by rising of an equivalent triangular  
333 pulse of maximum reflected pressure at an arrival time ( $t_A$ ) after the explosion (see Fig. 15(b)). The  
334 actual positive duration was replaced by a fictitious duration ( $t_{rf}$ ) assuming the linear decay of  
335 overpressure is given by (TM5-1300 1990)

$$336 \quad t_{rf} = 2i_r / P_r \quad (8)$$

337 A similar procedure for determining the negative fictitious duration ( $t_{rf}^-$ ) was used whereas rising  
338 time of negative peak pressure is considered equal to  $0.25 \cdot t_{rf}^-$ . Different blast pressure time histories  
339 specific to each member were established corresponding to the different scaled distance parameter  
340 ( $Z$ ) and potential charge weight for each blast IM.

341 The blast load was applied to beams, columns and exterior walls on the exposed structural area on  
342 the front face of the explosion. The reflection areas of the building were assumed big enough in order  
343 that there is no blast wave diffraction around the structure. Exterior walls were considered as typical  
344 concrete masonry wall reinforced with vertical bars. Since the vertical span of the wall is less than  
345 the horizontal span, and also the connection between the wall and adjacent columns are typically  
346 weak, the most of the wall strength and stiffness is provided by the vertical direction. Hence the wall

347 components were considered as one-way spanning elements that can transfer only the equivalent  
348 static reaction load to the adjacent beams.

349 To do blast analysis, each wall was simplified as a Single Degree Of Freedom (SDOF) system. The  
350 mass, stiffness and actual force of the wall were transformed into an equivalent system so that the  
351 deflection of the concentrated mass is the same as the mid-span of the actual wall (Biggs 1964). An  
352 elasto-perfectly plastic behavior for the wall was considered taking into account its dynamic  
353 characteristics under the high-velocity impacts (TM5-1300). The dynamic responses of the mid-span  
354 of the wall, considering the plastic hinge development (yield rotation capacity), were determined.  
355 Resulted time history reactions were calculated and directly applied to the adjacent beams in  
356 SAP2000 models (Computers and Structures Inc.) considering the rigid diaphragm for each floor.  
357 For the columns and beams, blast pressure time histories were determined and the corresponding  
358 pressures-time functions were applied directly on framing elements. The structural stiffness  
359 reduction caused by the earthquake was assessed according to FEMA P440A (FEMA 2009)  
360 degradation model. For each seismic IM, the mean values of stiffness reduction for the selected  
361 seven groups of ground motions were considered.

362 Mechanical properties of steel materials were enhanced by means of Dynamic Increased Factors  
363 (DIF) in order to take into account the effects of high rapid load environment compared to static  
364 loading conditions (TM5-1300 1990). Since the blast load duration is very short compared to the  
365 fundamental natural period of the structure, the structural damping effects were not considered in the  
366 analyses. Transmission of the ground shock induced by the explosion to the foundation of the  
367 structure was not considered in this study. Finally, nonlinear time history analyses were carried. In  
368 the cases of the loss of the load-bearing capacity of key structural components, the progressive  
369 collapse analyses were performed and the dynamic effects of removal of the failed elements were  
370 evaluated using time history analyses.

371 **Fire**



372 After ignition of inflammable materials inside the compartment, flashover occurs causing an increase  
 373 in temperature. Design-basis fire standards are based on the evaluation of post-flashover time-  
 374 temperature relationships (fire curve) for the compartment. Naturally, the fire curve depends on the  
 375 quantity of combustible materials (total calorific value), the velocity of combustion, and the  
 376 ventilation conditions. The first two parameters affect the total heat flux generated within the  
 377 compartment ( $q_f$ ). According to Euro Code 1 (EC1, 2002), the specific fire load is given in terms of  
 378 mean value and standard deviation of a normally distributed function for different building  
 379 categories. For hospitals, the mean specific fire load of 230 MJ/m<sup>2</sup> and the standard deviation of 69  
 380 are suggested. In the study case, the specific heat flux of the compartment was selected as first IM  
 381 (IM<sub>1</sub>) and eight different exceedance probabilities were considered as shown in Table 4.

382 The fuel quantity inside the tank was assumed as second IM parameter (IM<sub>2</sub>).

383 Since temperature-time relationships are not suitable to describe the real post-flashover behavior  
 384 (growth phase, steady-burning phase, and decay phase), several idealized temperature-time functions  
 385 were developed. In this study, the temperature-time relationship developed by Lie (Lie et al. 1974)  
 386 was considered as given below

$$\begin{cases}
 T = 250 \cdot (10 \cdot F)^{0.1/F^{0.3}} \cdot \exp(-F^2 \cdot t) \cdot [3 \cdot (1 - \exp(-0.6 \cdot t)) + \\
 -(1 - \exp(-3 \cdot t)) + 4 \cdot (1 - \exp(-12 \cdot t))] + C \cdot \left(\frac{600}{F}\right)^{0.5} \\
 T = -600 \cdot \left(\frac{t}{t_{peak}}\right) - 1 + T_{peak}
 \end{cases} \quad (9)$$

388 The first expression describes the heating phase, while the second one is referred to the cooling  
 389 phase. The ventilation conditions are considered by means of the opening factor  $F$   
 390 ( $F = A_v \cdot (H)^{0.5} / A_c$ ), where  $A_v$  is the total surface of vertical openings,  $H$  is the height of openings,  
 391 and  $A_c$  is the area of the compartment. Two vertical openings with 1.50 m×2.00 m were assumed for  
 392 each compartment (see Fig. 12) and the opening factor of 0.07 was calculated.

393 The constant  $C$  is associated with the type of burned materials and it is assumed equal to 1 for light  
394 materials and 0 for heavy ones. The top of the curve is described by peak time ( $t_{peak}$ ) and peak  
395 temperature ( $T_{peak}$ ). These two parameters define the fire severity inside the compartment. These  
396 parameters were defined according to the time equivalence concept, that relates the real fire exposure  
397 to the standard test fire (standard curve). EC1 (EC1 2002) proposes the calculation of the equivalent  
398 time  $t_e$  expressed as

$$399 \quad t_e = k_b \cdot w \cdot q_f \quad (10)$$

400 where  $q_f$  is the fire load in terms of heat flux and  $k_b$  is a parameter taking into account the different  
401 compartment lining (generally equal to 0.07 min m<sup>2</sup>/MJ). Considering only vertical openings in  
402 compartment, the ventilation factor  $w$  is given by

$$403 \quad w = \left( \frac{6}{H_c} \right)^{0.3} \cdot \left[ 0.62 + 90 \cdot \left( 0.4 - \frac{A_v}{A_c} \right)^4 \right] \quad (11)$$

404 where  $H_c$  defines the height of the compartment.

405

406

407

408

409

410

411

412 **Table 5** resumes the main parameters of the temperature-time curves for each generated heat flux.

413 According to the obtained results listed in

414

415

416

417

418

419

420 **Table 5**, the slope of the heating curve ( $T_{peak}/t_{peak}$ ) decreases with the increasing of the generated heat  
421 flux into the compartment.

422 Degradation of the physical and mechanical characteristics of the materials and the actions due to the  
423 fire were evaluated. According to Fourier's equation, the thermal distribution depends on the net  
424 transmitted heat flux ( $q_{f,n}$ ) in the time for a given fire scenario. Assuming all the structural elements  
425 as homogeneous and isotropic, the Fourier's problem can be integrated into the volume of the  
426 element and rewritten in the discrete form as (EC3 2005)

427 
$$\Delta T_{(i)} = k_{sh} \cdot \frac{A_m / V}{\rho \cdot c} \cdot q_{f,n(i)} \cdot \Delta t \quad (12)$$

428 where  $\Delta T_{(i)}$  defines the  $i^{\text{th}}$  increment of uniform temperature in the element cross section and  $A_m/V$  is  
429 the section factor given by the ratio between the area of the element exposed to fire ( $A_m$ ) and its total  
430 volume ( $V$ ). Density ( $\rho$ ) and specific heat ( $c$ ) are referred to the material composing structural  
431 element while  $\Delta t$  is the time step in which the increase of temperature occurs ( $\Delta t < 5s$ ). The fire  
432 protection system effect was neglected in the fire analysis. The current fire codes do not address the  
433 compound effects of hazards in a sequential manner. In fact, the damage to structural elements due to  
434 earthquake and blast, causes partial loss of fire protection (e.g. cracking of fireproof cladding,  
435 peeling of fireproof painting, etc.). Since in this case study, the fire load was applied on the structure  
436 damaged by sequential earthquake and blast, all the measures for fireproofing are deteriorated. The  
437 estimation of fire protection loss percentage is out of this study, then the total loss of fireproof  
438 system was considered as the worst case.

439 The coefficient  $k_{sh}$  takes into account the "shadow effects" that is responsible for a non-uniform  
440 thermal transversal distribution. In order to consider a pseudo-uniform transversal temperature  
441 distribution, the  $k_{sh}$  coefficient was considered according to the real fire exposure. Parameter  $k_{sh}=0.7$   
442 was assumed for beams (fire exposure on three sides) and  $k_{sh} = 0.9 \cdot (A_m / V)_b / (A_m / V)$  was

443 considered for columns according to Eurocode 3 (EC3 2005). The ratio  $(A_m/V)_b$  is the section factor  
444 of the element that was assumed as bin section and  $(A_m/V)$  is the real section factor of the column.  
445 The fire exposure for the column was supposed for one side of the web and for both flanges. Three  
446 different section of beams and columns have been identified for the compartment. Table 6  
447 summarizes the uniform temperature on the steel cross sections of the compartment at  $t_{peak}$  time for  
448 each heat flux value where the sections W12x136 and W14x109 identify the columns and the section  
449 W21x44 is related to the beams inside the compartments.

450 Fire resistance of steel elements inside the compartment was evaluated considering the maximum  
451 uniform thermal loads for each heat flux value. The software SAP2000 (Computers and Structures  
452 Inc.) was used to perform the analyses. The mechanical and physical materials properties were  
453 modified according to AISC (AISC 2005) depending on the temperature value. The nonlinearity of  
454 the structural elements was taken into account according to concentrated plasticity model and the  
455 progressive nonlinear analyses were performed. The structural stiffness reduction caused by the  
456 earthquake and blast was assessed according to FEMA P440A (FEMA 2009) degradation model. For  
457 each seismic IM the mean values of stiffness reduction for the selected seven groups of ground  
458 motions were considered. The reduced stiffness, strength, and damping were also calculated for each  
459 selected fuel quantity value.

## 460 **DAMAGE ANALYSIS**

### 461 **Earthquake**

462 A common approach is to correlate the performance of structural elements to one or more EDPs  
463 based on peak inter-story drifts. Peak inter-story drifts are capable of providing information about  
464 the damage state of the elements. According to ATC P-58 (FEMA 2012), four Earthquake Damage  
465 States ( $DS_E$ ) (slight, moderate, extensive, and complete) have been identified for the steel building  
466 depending on the transient drift ratio. The associated fragility curves are provided for both horizontal  
467 directions using the four  $DS_E$  (see Fig. 16).

## 468 **Blast**

469 In blast analyses, the evaluation of the structural building performance based on inter-story drifts  
470 limits the investigation to maximum local damage. The blast causes a damaged localized on the  
471 structural components depending on the distance to the blast source. In the case of intense blast load,  
472 a partial collapse may occur causing a redistribution of the actions in the slightly damaged  
473 components. Thus, the estimation of the damage on a building has to take into account the global  
474 behavior of the structure. In order to accurately assess the global response of a building under blast  
475 load, the loss of horizontal stiffness was assumed as EDP. The evaluation of the structural global  
476 response requires the maximum lateral displacements shape of the building due to the blast and the  
477 total induced elastic action. In the case study, the response of the structure in Y direction (see Fig. 5)  
478 was assimilated to a SDOF dynamic response given by

$$479 \quad K_{eq} = \frac{\delta_{eq}}{V_{eq}} = \frac{\delta_{top} \cdot \sum_{i=1}^{N=5} (\phi_i - \phi_{i-1})^2}{V_b \cdot \sum_{i=1}^{N=5} \phi_i} \quad (13)$$

480 where  $\delta_{top}$  is the maximum top floor displacement and  $V_b$  is the base shear resulted at the same time  
481 of the maximum displacement. The real distribution of floor displacements was taken into account  
482 through the shape coefficients  $\phi_i$  that represents the  $i^{th}$  floor displacement normalized with respect  
483 the top one. Table 7 resumes the horizontal stiffness reduction for each selected fuel quantity level  
484 derived from the performed progressive collapse analyses. The lateral stiffness reduction was  
485 calculated for each selected earthquake scenario considering the chain effects. Thus, the degradation  
486 of the structural parameters was evaluated and the blast load was applied on the structure with  
487 modified mechanical characteristics. The first column of Table 7 represents the five different HLs for  
488 earthquake while the first row identifies the nine HLs selected for the fuel quantity.

489 The yield drift for the braced system was calculated according to ATC P-58 (FEMA 2012) and the  
490 maximum drift threshold was assumed for four different damage states. The stiffness reduction limits  
491 were calculated assuming an elasto-perfectly plastic global behavior of the steel frame (see Table 7).

492 According to the estimated stiffness reduction values for each damage state, the associated  
493 exceedance probability ( $P(DS_B \geq ds_B)$ ) surfaces were evaluated (see Fig. 17).

#### 494 **Fire**

495 The structural capacity assessment was carried out considering maximum deflection for beams and  
496 columns as EDP. Two different damage states were assumed:

- 497 - Fire Damage State 1 ( $DS_{F,1}$ ): irreversible damage on the beam with maximum response;
- 498 - Fire Damage State 2 ( $DS_{F,2}$ ): irreversible damage in the column with maximum response.

499 The first damage state gives information about the maximum flexural capacity of the beam. The  
500 threshold vertical deflection ( $v_b$ ) for this damage state was assumed equal to the deflection causing  
501 an uncontrolled vertical displacement (Gernay et al. 2016). The second damage state is related to the  
502 maximum drift of the column ( $\delta_c$ ) under multiple stresses due to compression and bending moment,  
503 taking into account the P- $\Delta$  effects. The maximum limit for the drift was assumed coincident with the  
504 horizontal displacement that produces uncontrolled unstable displacement (Gernay et al. 2016).

505 Several analyses were performed considering the different fuel quantity and heat ratio as HLs. The  
506 degradation of the structural parameters was evaluated and the fire load was applied on the structure.  
507 For each analysis, the probability to have irreversible damage to the structural elements was assumed  
508 equal to 1 if the response parameter is greater than the associated limit and 0 otherwise.

509 The probability of exceeding certain damage state due to the fire hazard ( $P(DS_F \geq ds_F)$ ) was developed  
510 fitting lognormal distribution to the obtained data (see Fig. 18).

#### 511 **NUMERICAL EXAMPLE**

512 The total probability of exceeding a given damage state was derived according to Eq.(2). In a  
513 cascading multi-hazard scenario, the probability of exceeding a given damage state has to be  
514 calculated considering the conditional probability of exceeding a certain intensity level due to the  
515 occurrence of the previous hazard. For the case study, earthquake-blast-fire was considered as  
516 cascading hazards. According to the numerical analyses performed and considering a complete

517 damage to the columns of the building as damage state, the probabilities of exceeding the selected  
518 level of damage was estimated for the three hazards.

519 The spectral acceleration at the period of the structure, fuel quantity inside the tank, spectral  
520 acceleration at the period of the tank, and heat flux generated in the compartment were assumed as  
521 IM parameters. A numerical example was carried out with reference to the five different HL for the  
522 earthquake, 80% of the full capacity of the tank and heat flux equal to the average value. Table 9  
523 shows exceedance damage probability values for the case study building and the conditional  
524 probability of exceeding an IM for the one hazard due to a given IM for the previous hazard. The  
525 complete damage on the columns was selected as damage state and then the associated exceedance  
526 damage probability ( $P(DS > ds)$ ) was estimated.

527 It is clear that the probability to have blast after the earthquake is correlated to the size of the tank. In  
528 the case study, a low conditional probability of exceeding an IM for the blast due to a given IM for  
529 the earthquake was associated with the value of maximum gas concentration. But, for the cases of  
530 farm tanks, the conditional probability value may be considerable.

## 531 **CONCLUDING REMARKS**

532 Recent experiences have shown that buildings and infrastructures are significantly vulnerable to  
533 multi-hazard effects. The combination of cascading hazards is essential to evaluate the real  
534 performance of a structure and the respective economic losses. This study presented a new approach  
535 to assessing the conditional probability of exceeding a certain intensity level due to the occurrence of  
536 the previous hazard, estimating the exceedance damage probability and taking into account the  
537 interdependency between different hazards. The main novelty of this research is the estimation of  
538 exceedance damage probability for a given damage state due to earthquake, blast and fire hazard by  
539 considering the physical models. The method can be considered as an alternative to the Monte Carlo  
540 simulations, thus it reduces the computational time to perform the analyses, but it requires accurate  
541 calibration of the physical parameters which plays a key role in reducing the epistemic uncertainty of

542 the model. In addition, the degradation of the structural parameters was taken into account for  
543 correctly assessing the performance of a structure subjected to cascading hazards.  
544 The application of the proposed cascading multi-hazard approach can be used for both improving the  
545 structural safety and reducing the building life cycle costs to enhance the resilience of the structure.

546  
547 **ACKNOWLEDGEMENTS**

548 The research leading to these results has received funding from the European Research Council  
549 under the Grant Agreement n° ERC\_IDEAL RESCUE\_637842 of the project IDEAL RESCUE—  
550 Integrated Design and Control of Sustainable Communities during Emergencies.

551

552

553

554 **References**

- 555 AISC (2005). "Specification for Structural Steel Buildings." AISC 360, American Institute of Steel  
556 Construction, Chicago, IL.
- 557 ASCE. (2010). "Minimum design loads for buildings and other structures." 7-10, Reston, VA.
- 558 Asprone D., Jalayer F., Prota A., and Manfredi G. (2010). "Proposal of a probabilistic model for  
559 multi-hazard risk assessment of structures in seismic zones subjected to blast for the limit  
560 state of collapse." *Structural Safety*, Volume 32, Issue 1, Pages 25-34.
- 561 ATC (2012). "Seismic Performance Assessment of Buildings." ATC-58, *Applied Technology*  
562 *Council*, Redwood City, CA.
- 563 Babrauskas V., and Krasny J.F. (1985). "Fire Behaviour of Upholstered Furniture." *NBS*  
564 *Monograph 173* (U.S.), National Bureau of Standards.
- 565 Baker, J. W. (2010). "Conditional mean spectrum: Tool for ground-motion selection." *Journal of*  
566 *Structural Engineering*, 137(3), 322-331.



567 Baker, J. W., and Jayaram, N. (2008). "Correlation of spectral acceleration values from NGA ground  
568 motion models." *Earthquake Spectra*, 24(1), 299-317.

569 Barbato, M., Petrini, F., Unnikrishnan, V. U., and Ciampoli, M. (2013). "Performance-Based  
570 Hurricane Engineering (PBHE) framework." *Structural Safety*, 45, 24-35.

571 Biggs, J. M. (1964). *Introduction to structural dynamics*, McGraw-Hill, New York.

572 Boore, D. M., and Atkinson, G. M. (2008). "Ground-motion prediction equations for the average  
573 horizontal component of PGA, PGV, and 5%-damped PSA at spectral periods between 0.01 s  
574 and 10.0 s." *Earthquake Spectra*, 24(1), 99-138.

575 Bruneau, M., Lopez-Garcia, D., and Fujikura, S. "Multihazard-resistant highway bridge bent." *Proc.*,  
576 *Proc., Structures Congress*, ASCE New York, 1-4.

577 Cimellaro, G. P., and Marasco, S. (2015). "A computer-based environment for processing and  
578 selection of seismic ground motion records: Opensignal." *Frontiers in Built Environment*, 1,  
579 17.

580 Computer and Infrastructure Inc. SAP2000, Version 17.3, Berkeley, CA.

581 Costin, N. S. (2014). "Numerical simulation of detonation of an explosive atmosphere of liquefied  
582 petroleum gas in a confined space." *Defence Technology*, 10(3), 294-297.

583 Delmonaco, G., Margottini C., and Spizzichino D. (2006). "Report on new methodology for multi-  
584 risk assessment and the harmonisation of different natural risk maps." *Deliverable 3.1*,  
585 *ARMONIA*.

586 EC (2002). "Eurocode 1: Actions on structures." *Part 1-1: General actions - Densities, self-weight*,  
587 *imposed loads for buildings*, EC1, European Committee for Standardization, Bruxelles, BG.

588 EC (2005). "Design of steel structures - Part 1-2: General rules -Structural fire design." *EC3*,  
589 *European Committee for Standardization*, Bruxelles, BG.

590 Fabbrocino G., Iervolino I., Orlando F., and Salzano E. (2005). "Quantitative risk analysis of oil  
591 storage facilities in seismic areas." *Journal of Hazardous Materials*, Volume 123, Issues 1-3,  
592 Pages 61-69.

593 FEMA (2000). "Prestandard and Commentary for the Seismic Rehabilitation of Buildings." FEMA  
594 356, Federal Emergency Management Agency, Washington, D.C.

595 FEMA (2009). "Effects of Strength and Stiffness Degradation on Seismic Response." FEMA P440A,  
596 Federal Emergency Management Agency, Washington, D.C.

597 FEMA (2011). "Hazus FEMA's methodology for estimating potential losses from disasters ", FEMA  
598 Federal Emergency Management Agency, Washington, D.C.

599 Gernay, T., Khorasani, N. E., and Garlock, M. (2016). "Fire fragility curves for steel buildings in a  
600 community context: a methodology." *Engineering Structures*, 113, 259-276.

601 IAOGP (2010). "Ignition probabilities." *Risk Assessment Data Directory*, International Association  
602 of Oil & Gas Producers, Report No. 434-6.1.

603 Lie, T. T. (1974). "Characteristic temperature curves for various fire severities." *Fire Technology*,  
604 4pp. 315-326.

605 Lindell, M. K., Perry, R. W., Prater, C., and Nicholson, W. C. (2006). "Fundamentals of emergency  
606 management". Washington, DC: FEMA. Chicago.

607 Marasco, S., Cimellaro, G.P. (2017). "A new energetic based ground motion selection and  
608 modification algorithm.". Proc., 16th World Conference on Earthquake Engineering,  
609 Santiago, Chile.

610 NFPA 30 (2013). "Flammable and Combustible Liquids Code." Committee on Tank Storage and  
611 Piping Systems.

612 Padgett, J., Ghosh, J., and Ataei, N. (2010). "Sensitivity of dynamic response of bridges under  
613 multiple hazards to aging parameters." *Proc., 19th analysis and computation specialty  
614 conference. ASCE.*

615 Porter, K.A. (2003). "An overview of PEER's performance-based earthquake engineering  
616 methodology." *Proc. Ninth International Conference on Applications of Statistics and  
617 Probability in Civil Engineering (ICASP9)* July 6-9, 2003, San Francisco, CA. Civil

618 Engineering Risk and Reliability Association (CERRA), 973-980.  
619 <http://www.sparisk.com/pubs/Porter-2003-PBEE-Overview.pdf>.

620 SBEDS (2008). "Methodology Manual for the Single-Degree-of Freedom Blast Effects Design  
621 Spreadsheets." *PDC TR-06-01 Rev 1*, Protective Design Center Technical Report, U.S. Army  
622 Corps of Engineers.

623 Sutton, S. B., and McCauley, E. W. (1975). "Assessment of Hazards Resulting from Atmospheric  
624 Propane Explosions at Lll.", US Energy Research and Development Administration,  
625 California Univ., Livermore Lawrence Livermore Lab.

626 TM5-1300 (1990). "The Design of Structures to Resist the Effects of Accidental Explosions."US  
627 Department of the Army, Navy, and Air Force, Washington DC.

628 USGS (2013). "Seismic Hazard Analysis tools. U.S. Geological Survey." <  
629 <http://earthquake.usgs.gov/hazards/designmaps/grdmotion.php>>.

630 Usmani, A. S. (2008). "Research priorities for maintaining structural fire resistance after seismic  
631 damage". In Proceedings of the 14th world conference on earthquake engineering, Beijing.  
632  
633  
634

635 **Fig. 1.** Conditional probabilities for cascading hazards

636 **Fig. 2.** Performance-Based earthquake Engineering for cascading hazards scenario

637 **Fig. 3.** Cyclic degradation for structural elements (FEMA P440A 2009)

638 **Fig. 4.** Lateral moment resisting frame configuration

639 **Fig. 5.** Internal bracing frame configuration

640 **Fig. 6.** Geometric configuration of the LPG tank

641 **Fig. 7.** LPG tank orientation with respect to the building façade

642 **Fig. 8.** Example of hazard sequence: earthquake-blast-fire

643 **Fig. 9.** (a) mean spectrum compatibility for 2% of exceedance probability in 100 years, (b) 5% of  
644 exceedance probability in 100 years (reference range of period highlighted in grey)

645 **Fig. 10.** (a) probability to have leakage, (b) probability to have maximum fuel concentration, (c)  
646 probability of ignition (according to IAOGP, 2010)

647 **Fig. 11.** Conditional probability of exceeding an IM for blast ( $IM_B \geq im_B$ ) due to a given IM for  
648 earthquake ( $IM_1 = Sa(T_{tank}) \geq im_1$ ,  $IM_2 = F_Q \geq im_2$ )

649 **Fig. 12.** Fire compartments division for the building plan

650 **Fig. 13.** Building façade having a heat flux greater than 30 MJ/m<sup>2</sup> for each fuel quantity value

651 **Fig. 14.** Conditional probability of exceeding an IM for fire ( $IM_F \geq im_F$ ) due to a given IM for blast  
652 ( $IM_B = F_Q \geq im_B$ )

653 **Fig. 15.** (a) blast overpressure-time history for a face-on reflected wave; (b) idealized blast  
654 overpressure time history (adopted by TM5-1300 1990)

655 **Fig. 16.** (a) Probability of exceeding a given damage state for earthquake hazard ( $P(DS_E \geq ds_E)$ ) in X  
656 direction; (b) Y direction

657 **Fig. 17.** (a) Probability of exceeding a slight, (b) moderate, (c) extensive, (d) complete damage state  
658 for blast hazard ( $P(DS_B \geq ds_B)$ )

659 **Fig. 18.** (a) Probability of exceeding a irreversible damage on the beams, (b) irreversible damage on  
660 the columns for fire hazard ( $P(DS_F \geq ds_F)$ )

661

662

663

664

665

**Table 1.** IM parameters values for earthquake

$P_{VR,E}$ [%]	50	20	10	5	2
$Sa(T_{ref})$ [g]	0.20	0.41	0.58	0.76	1.00

Note:  $P_{VR,E}$  is the exceedance probability in 100 years for earthquake hazard.

666

**Table 2.** Selected exceedance probability for fuel quantity and associated values.

$P_{FQ}$ [%]	90	75	65	50	20	10	5	2	1
Fuel quantity [%]	55	62	67	70	77	80	86	92	100

Note:  $P_{FQ}$  is the fuel quantity exceedance probability.

**Table 3.** Number and localization of the compartments under fire for each fuel quantity value.

$P_{FQ}$ [%]	90	75	65	50	20	10	5	2	1
Fuel quantity [%]	55	62	67	70	77	80	86	92	100
Compartment area ID	C5 C14	C5 C14	C5 C14	C4 C5 C6 C13 C14 C15	C4 C5 C6 C13 C14 C15	C4 C5 C6 C13 C14 C15	C4 C5 C6 C13 C14 C15	C4 C5 C6 C13 C14 C15	C4 C5 C6 C13 C14 C15
Compartment height ID	H1	H1	H1	H1 H2	H1 H2	H1 H2	H1 H2	H1 H2	H1 H2

Note:  $P_{FQ}$  is the fuel quantity exceedance probability.

667

**Table 4.** Selected exceedance probability for each generated heat flux.

$P_{qf}$ [%]	90	85	80	50	20	10	5	2
$q_f$ [MJ/m <sup>2</sup> ]	135	160	180	230	281	322	360	400

Note:  $P_{qf}$  is the compartmental heat flux exceedance probability.

668

669

670

671

672

673

674

675

**Table 5.** Characteristic time-temperature curve parameters for each generated heat flux.

$P_{qf}$ [%]	90	85	80	50	20	10	5	2
$t_e$ [min]	23.50	25.00	26.19	33.46	40.83	46.85	52.2	58.2
$T_{peak}$ [K°]	1111	1131	1145	1173	1188	1205	1218	1228
$t_{peak}$ [min]	11.5	13.5	16	20.5	24.5	29.5	33.5	37

Note:  $P_{qf}$  is the compartmental heat flux exceedance probability.

676

**Table 6.** Uniform temperature in the cross section of the structural elements within the compartments.

677

		$P_{qf}$ [%]								
		Element	90	85	80	50	20	10	5	2
$\Delta T_{MAX}$ [K°]		W21x44	677	777	846	925	971	1,019	1057	1089
		W14x109	635	729	794	867	911	956	991	1021
		W12x136	560	643	700	765	804	843	875	901

Note:  $P_{qf}$  is the compartmental heat flux exceedance probability.

678

**Table 7.** Percentage of the stiffness reductions for each fuel quantity and earthquake HLs.

		$P_{FQ}$ [%]								
		90	75	65	50	20	10	5	2	1
$P_{VR,E}$ [%]	50	62.28	71.96	74.63	76.89	87.5	92.77	96.53	97.20	98.98
	20	65.32	74.12	77.03	78.29	89.13	94.73	97.66	98.22	100.00
	10	68.76	79.74	80.83	85.18	93.19	98.52	99.83	99.75	100.00
	5	72.33	84.16	87.44	91.28	98.36	99.79	100.00	100.00	100.00
	2	79.52	89.59	93.89	97.85	100.00	100.00	100.00	100.00	100.00

Note:  $P_{VR,E}$  is the exceedance probability in 100 years for earthquake hazard and  $P_{qf}$  is the compartmental heat flux exceedance probability.

679

**Table 8.** Blast Damage States and calculated stiffness reduction for blast analysis.

Blast Damage State ( $DS_B$ )	Slight	Moderate	Extensive	Complete
Drift [%]	1.00	1.80	2.80	4.80
Stiffness reduction [%]	30.00	61.00	75.00	85.00

680

681

682 **Table 9.** Numerical example for exceedance damage probability calculation due to earthquake, blast  
 683 and fire hazards, considering complete damage on the columns.

$P_{VR,E}$ [%]	Sa(T) [g]	Sa(T <sub>tank</sub> ) [g]	$P(IM_B > im_B   I_{M_E > im_E})$ [%]	$P(IM_F > im_F   I_{M_B > im_B})$ [%]	$P(DS_E > d_{SE})$ [%]	$P(DS_B > d_{SB})$ [%]	$P(DS_F > d_{SF})$ [%]	$P(DS > ds)$ [%]
2	1,00	0.95	3.80	80.00	100.00	100.00	82.00	100.00
5	0.75	0.85	1.60	80.00	80.00	98.00	82.00	82.62
10	0.55	0.75	1.00	80.00	50.00	95.00	82.00	51.61
20	0.4	0.65	0.80	80.00	22.00	86.00	82.00	23.21
50	0.2	0.4	0.45	80.00	1.50	55.00	82.00	2.04

Note:  $P_{VR,E}$  is the exceedance probability in 100 years for earthquake hazard.

684

## HAZARD

Hazard 1



Hazard 2



Hazard 3



## PROBABILITY OF EXCEEDING A GIVEN INTENSITY MEASURE

$$P(IM_1 \geq im_1)$$

$$P(IM_2 \geq im_2) = P(IM_2 \geq im_2 | IM_1 \geq im_1) \cdot P(IM_1 \geq im_1)$$

$$P(IM_3 \geq im_3) = P(IM_3 \geq im_3 | IM_2 \geq im_2) \cdot P(IM_2 \geq im_2 | IM_1 \geq im_1) \cdot P(IM_1 \geq im_1)$$



## Hazard analysis

$$p(IM)$$



**hazards interaction**

$$p(IM_i | IM_{i-1})$$

## Structural analysis

$$p(EDP | IM, SP)$$



$$p(EDP)$$

## Damage analysis

$$p(DM | EDP)$$



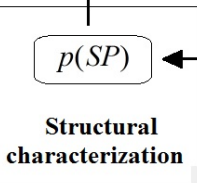
$$p(DM)$$

## Loss analysis

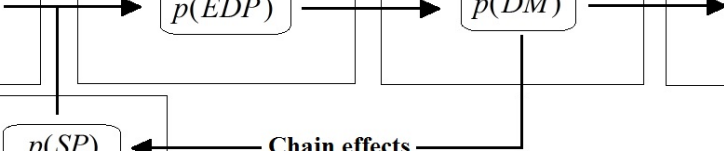
$$p(DV | DM)$$

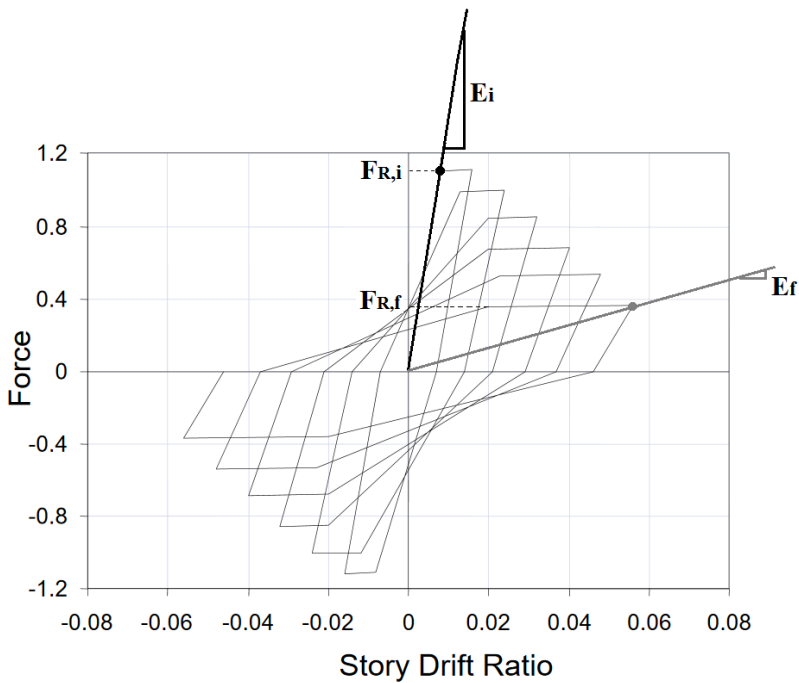


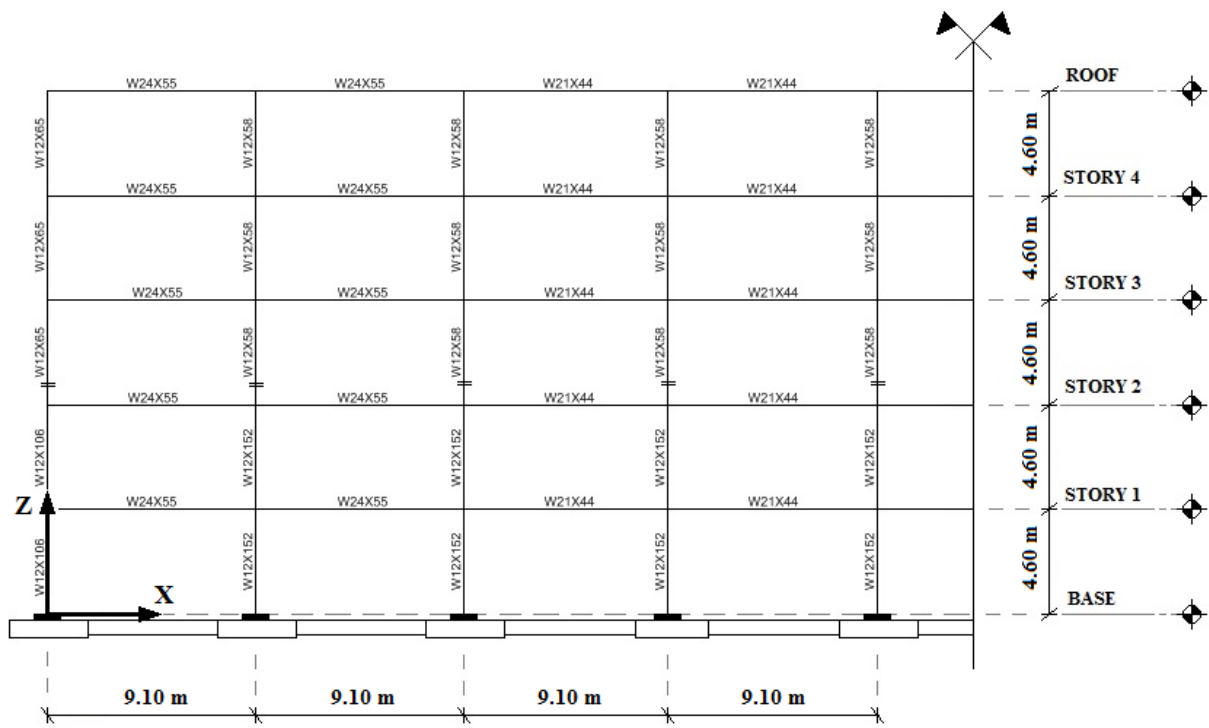
$$p(DV)$$

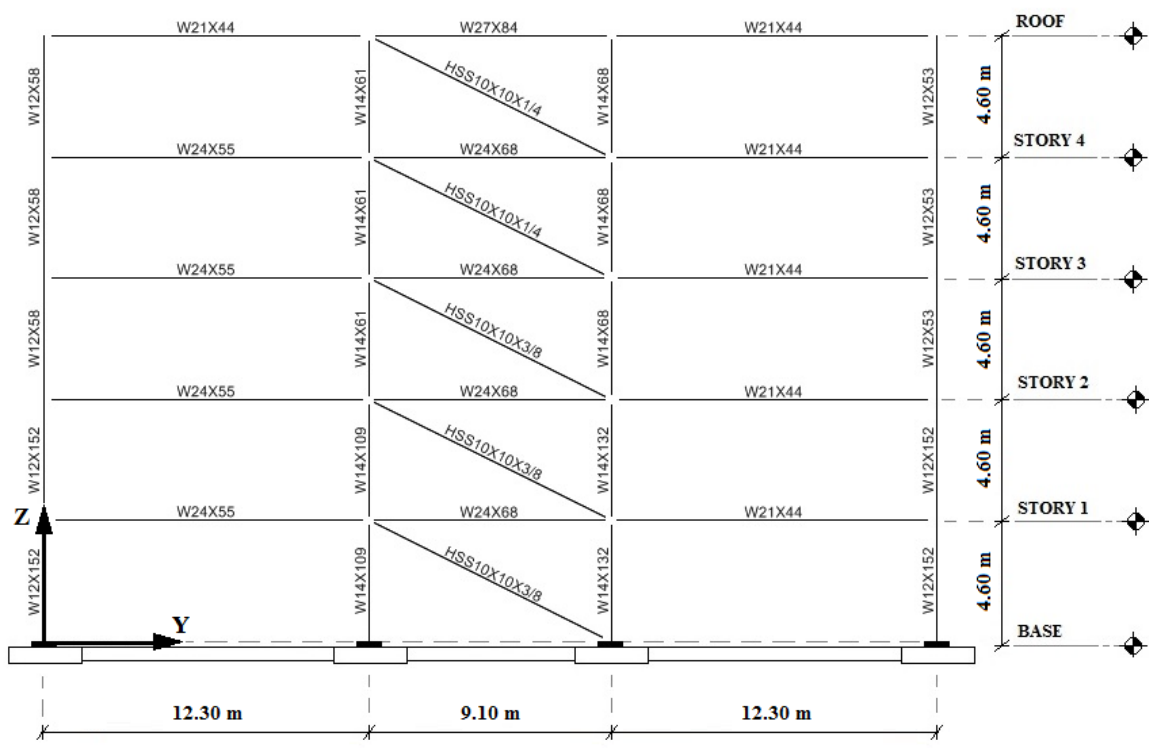


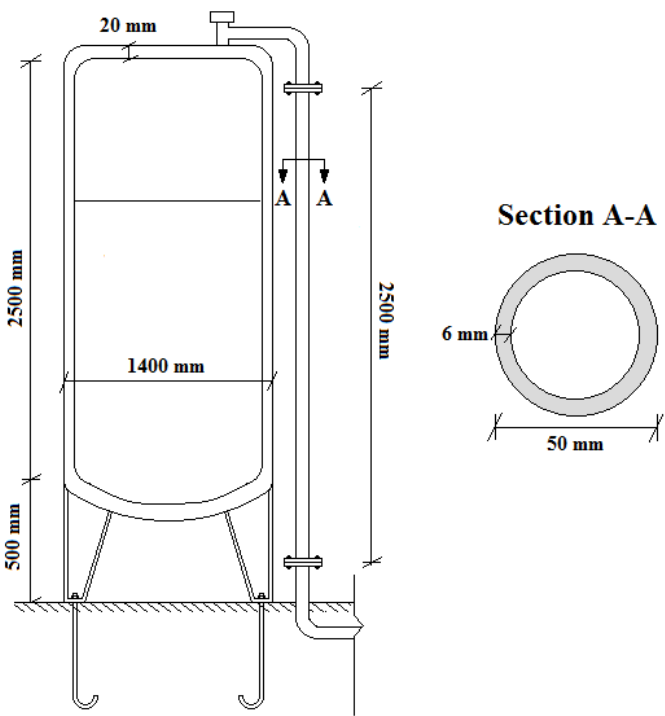
**Chain effects**

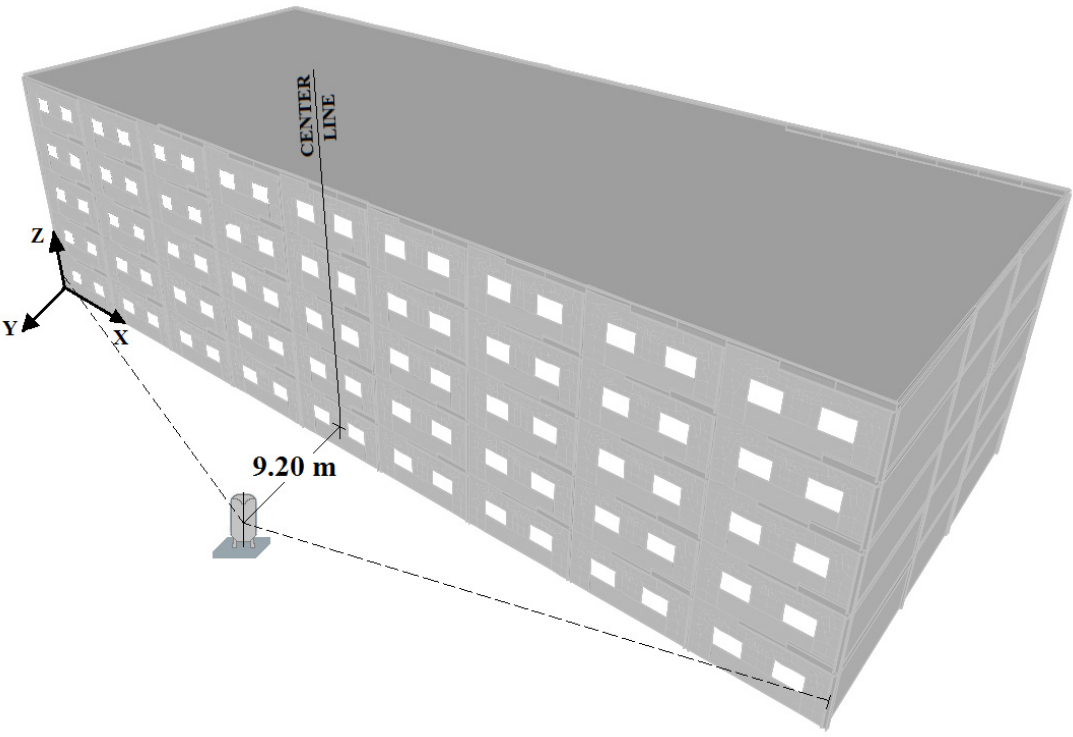


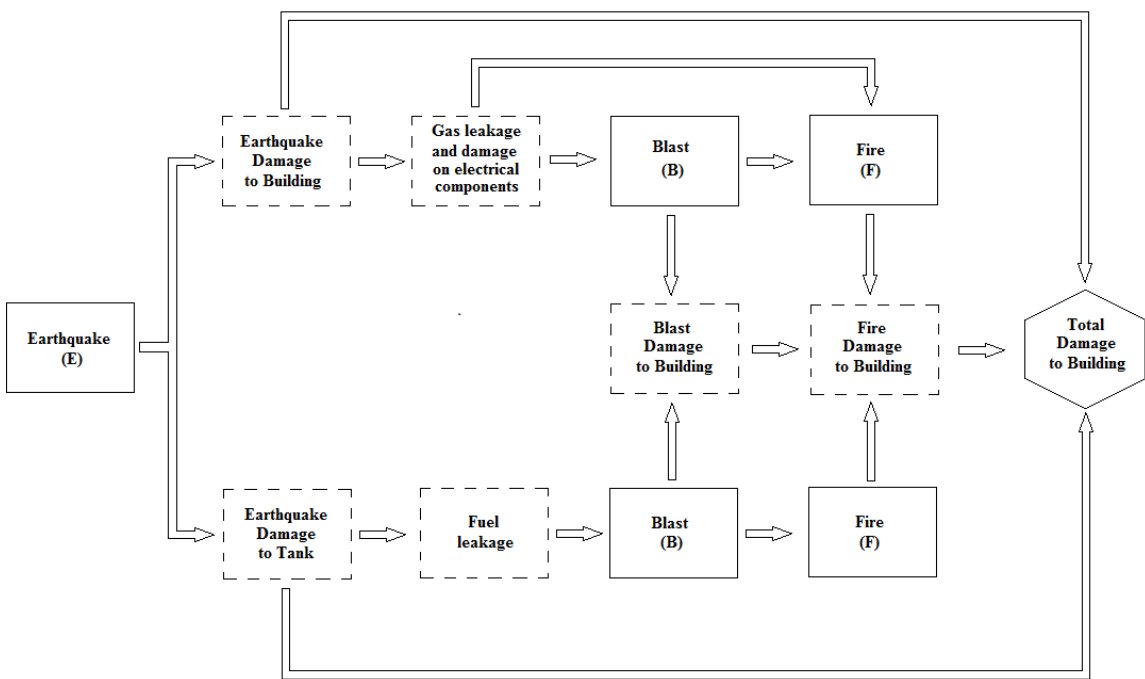


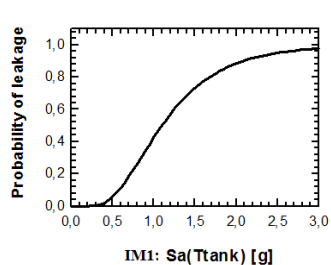




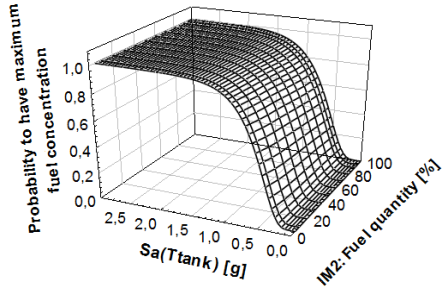




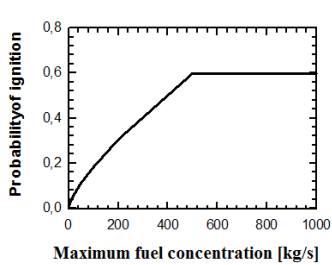




(a)

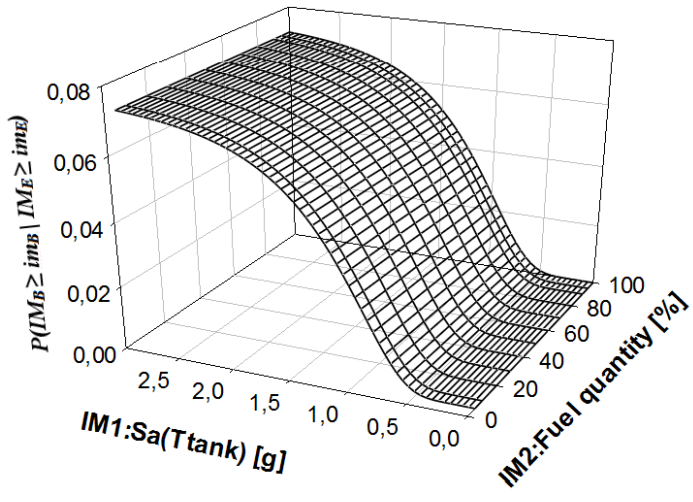


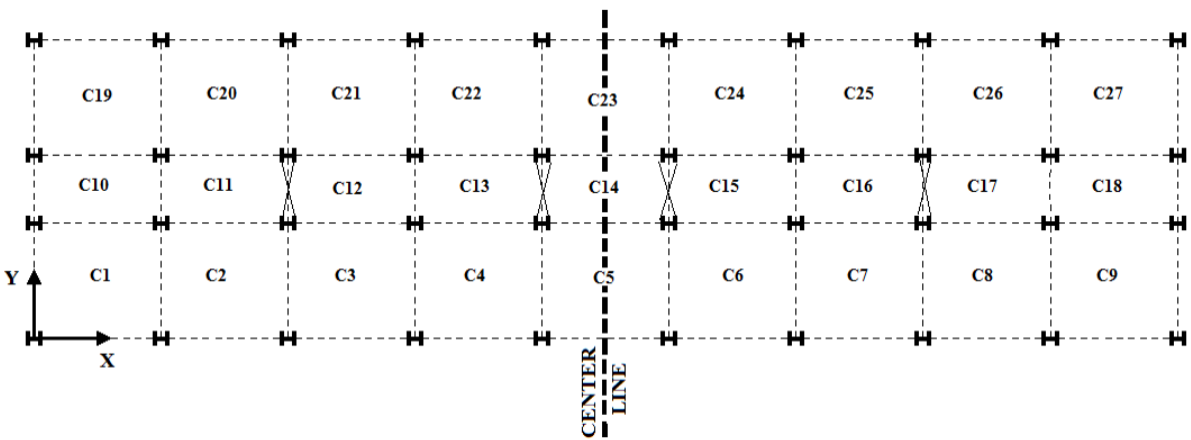
(b)

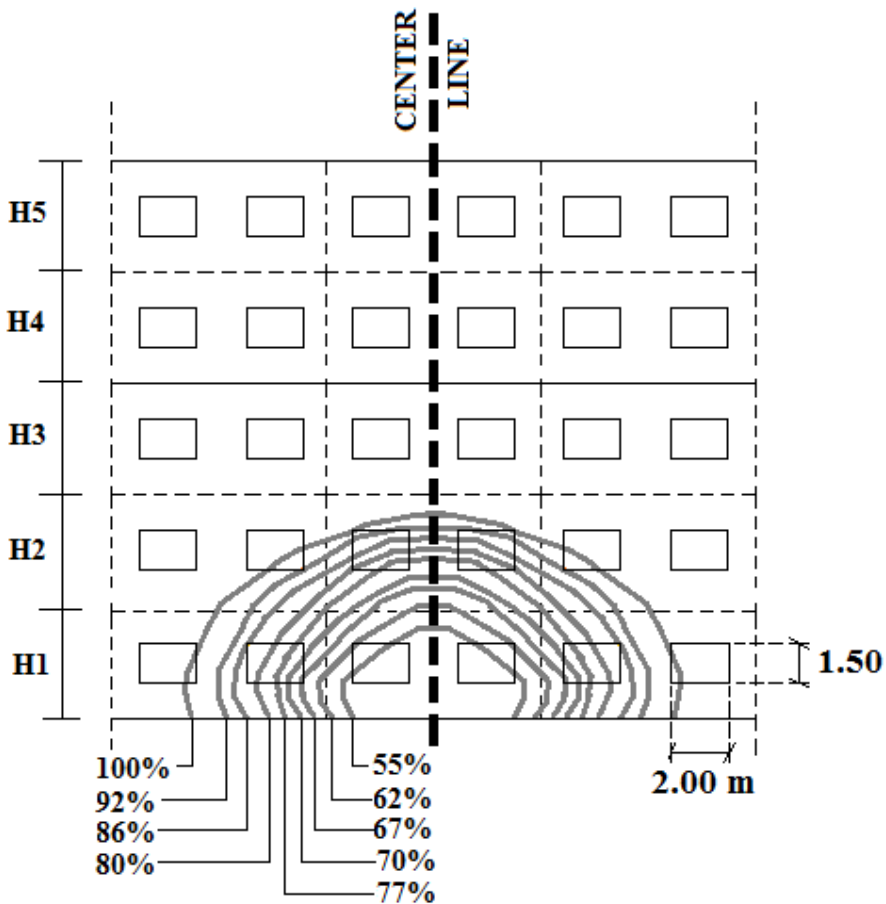


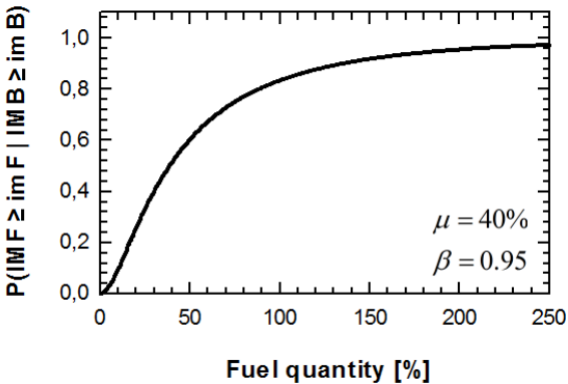
(c)

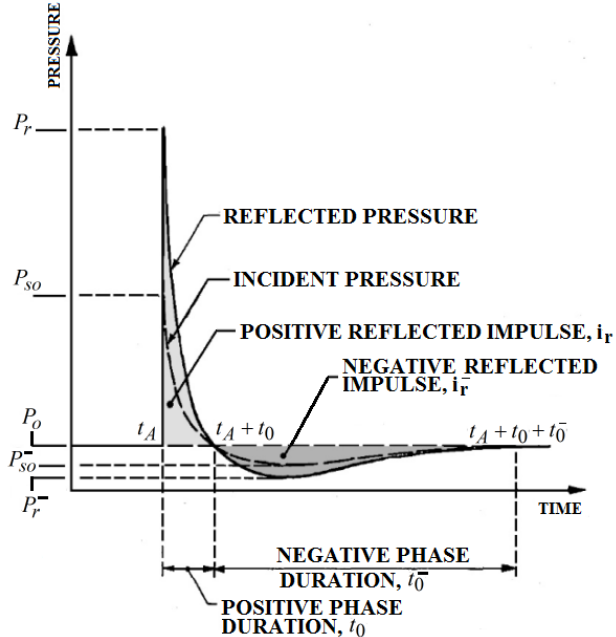




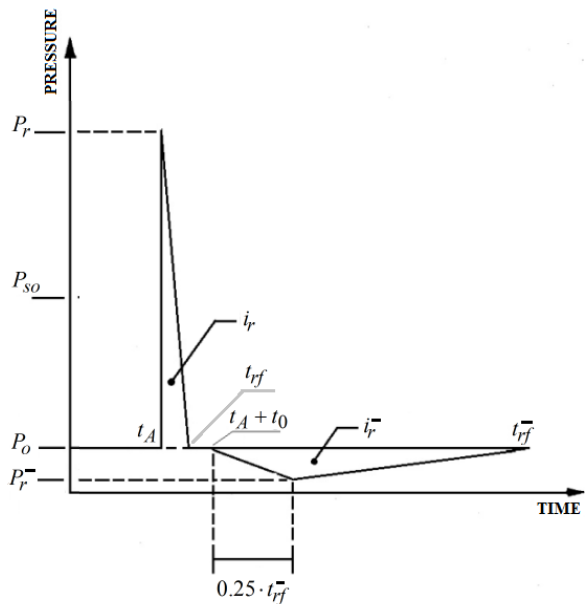




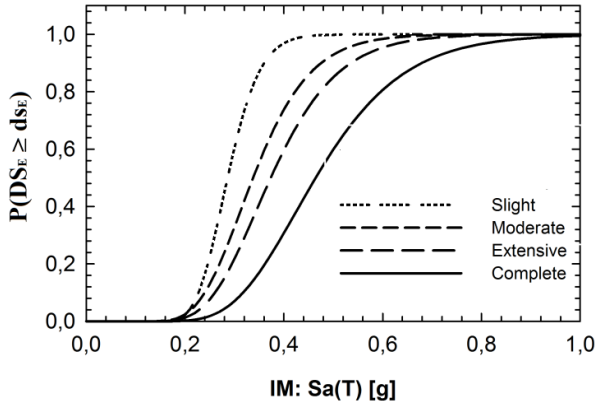




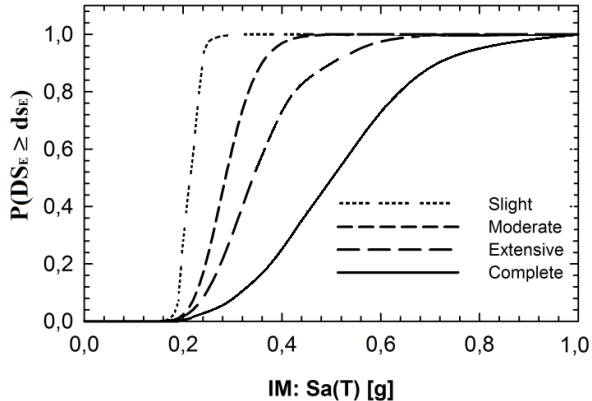
(a)



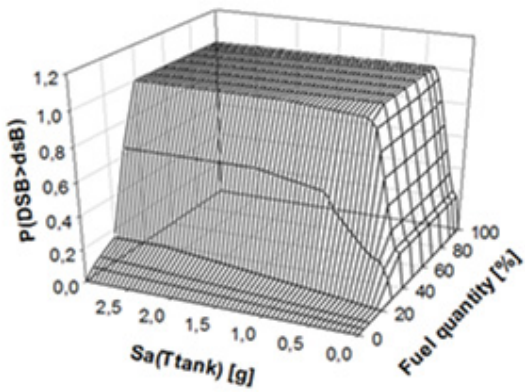
(b)



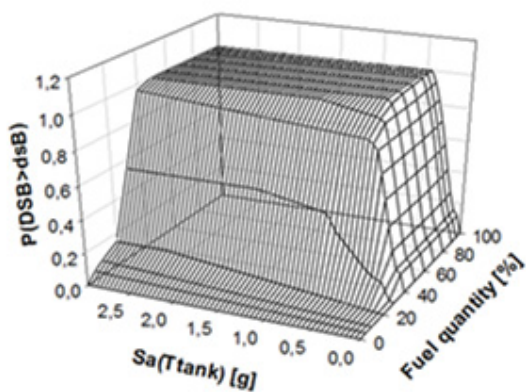
(a)



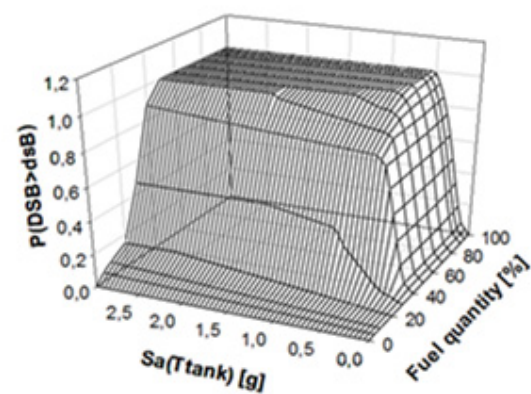
(b)



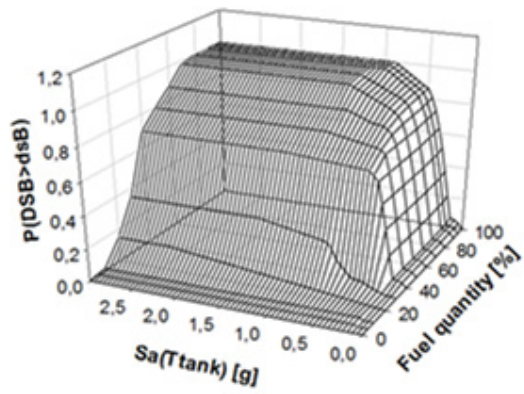
(a)



(b)



(c)



(d)

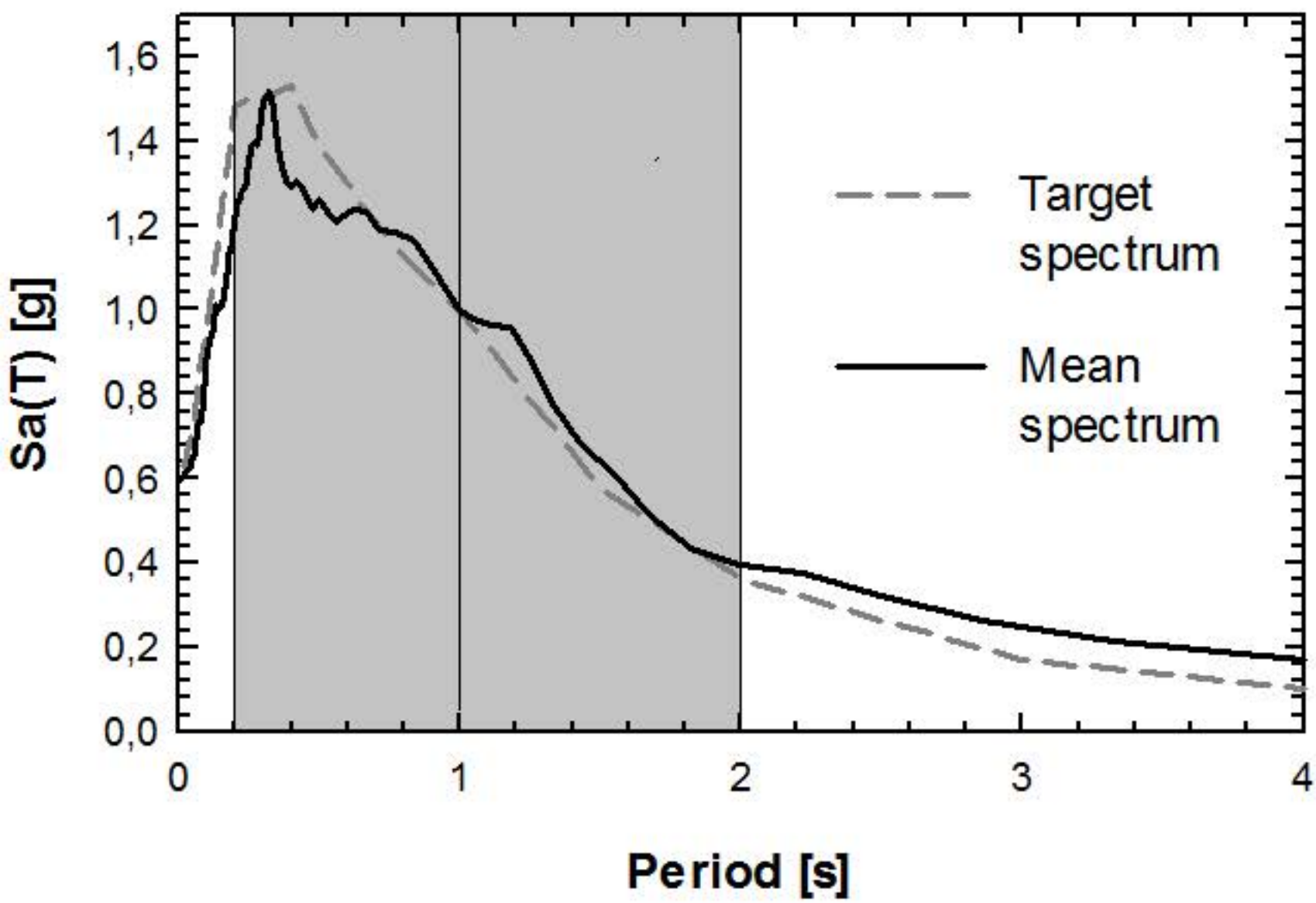
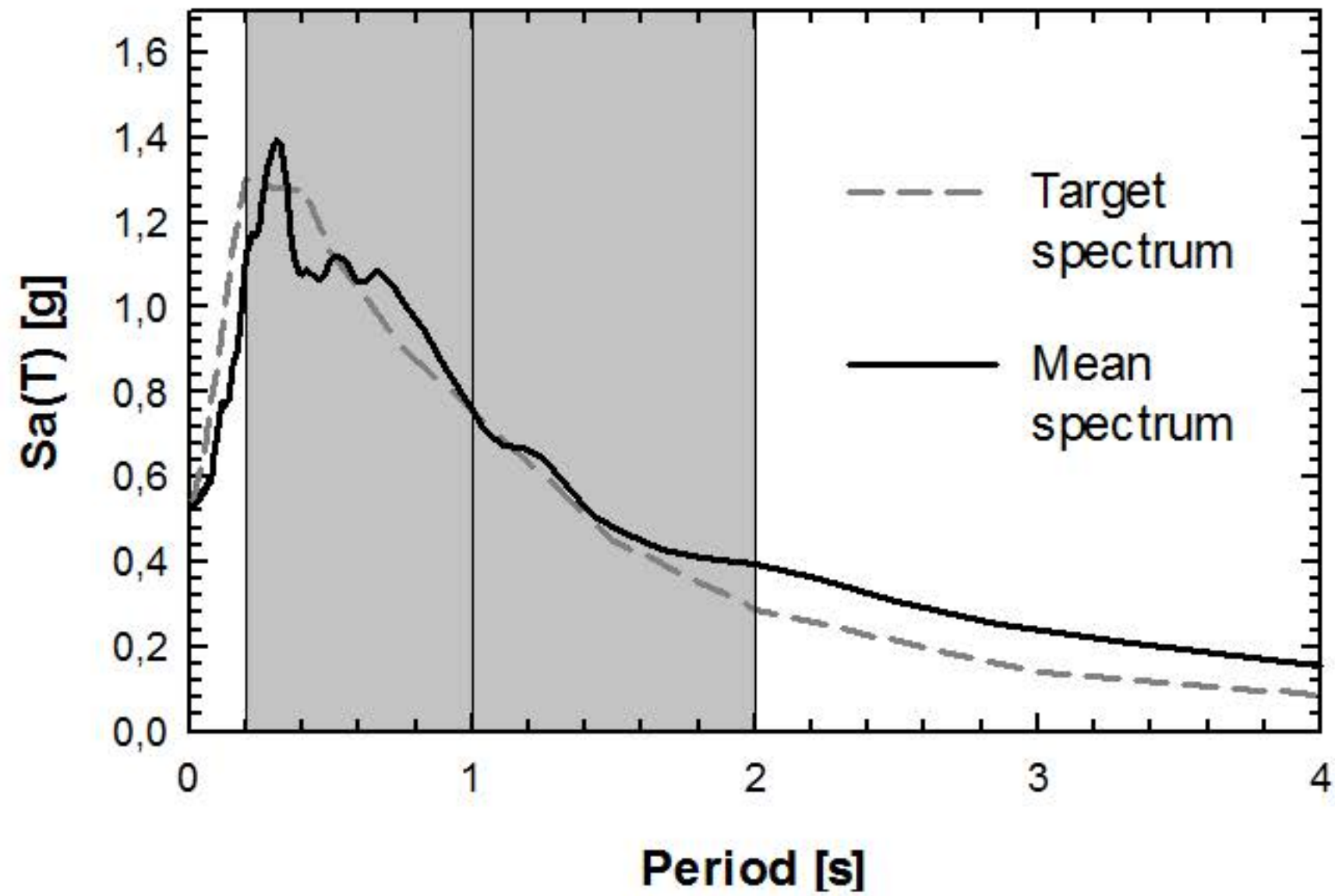
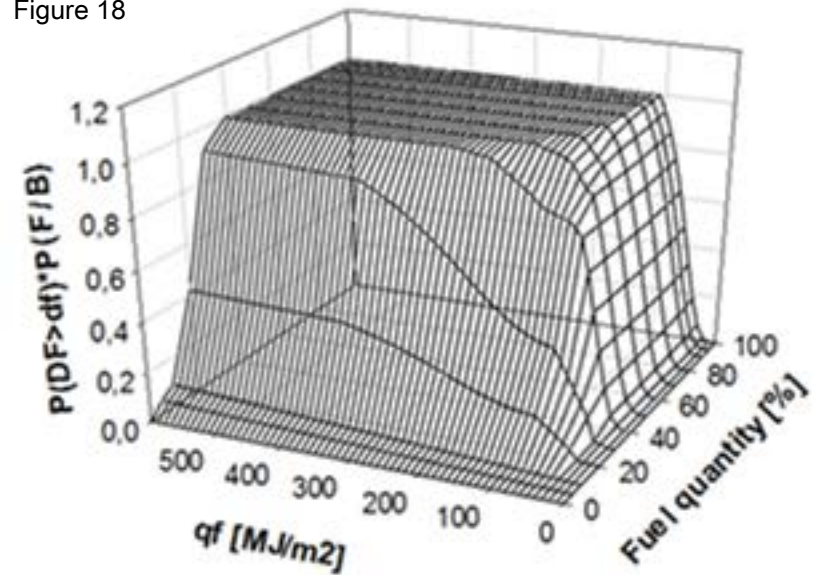
**2% / 100 years****(a)****5% / 100 years****(b)**

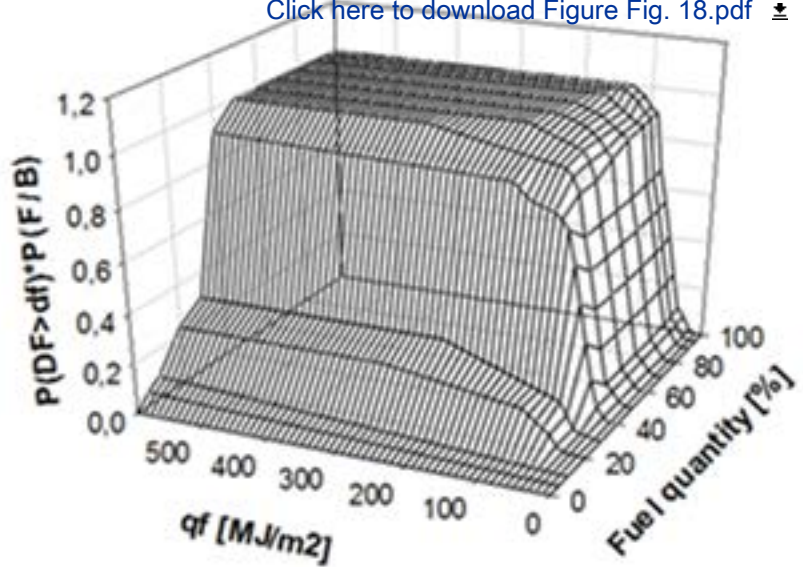


Figure 18

[Click here to download Figure Fig. 18.pdf](#)



(a)



(b)