

Bernard Rudofsky. A Humane Designer

*Original*

Bernard Rudofsky. A Humane Designer / Bocco, Andrea. - STAMPA. - (2003), pp. 1-320.

*Availability:*

This version is available at: 11583/1392972 since: 2021-02-19T10:12:09Z

*Publisher:*

Springer Verlag

*Published*

DOI:

*Terms of use:*

This article is made available under terms and conditions as specified in the corresponding bibliographic description in the repository

*Publisher copyright*

(Article begins on next page)

# Bernard Rudofsky A Humane Designer

Andrea Bocco Guarneri

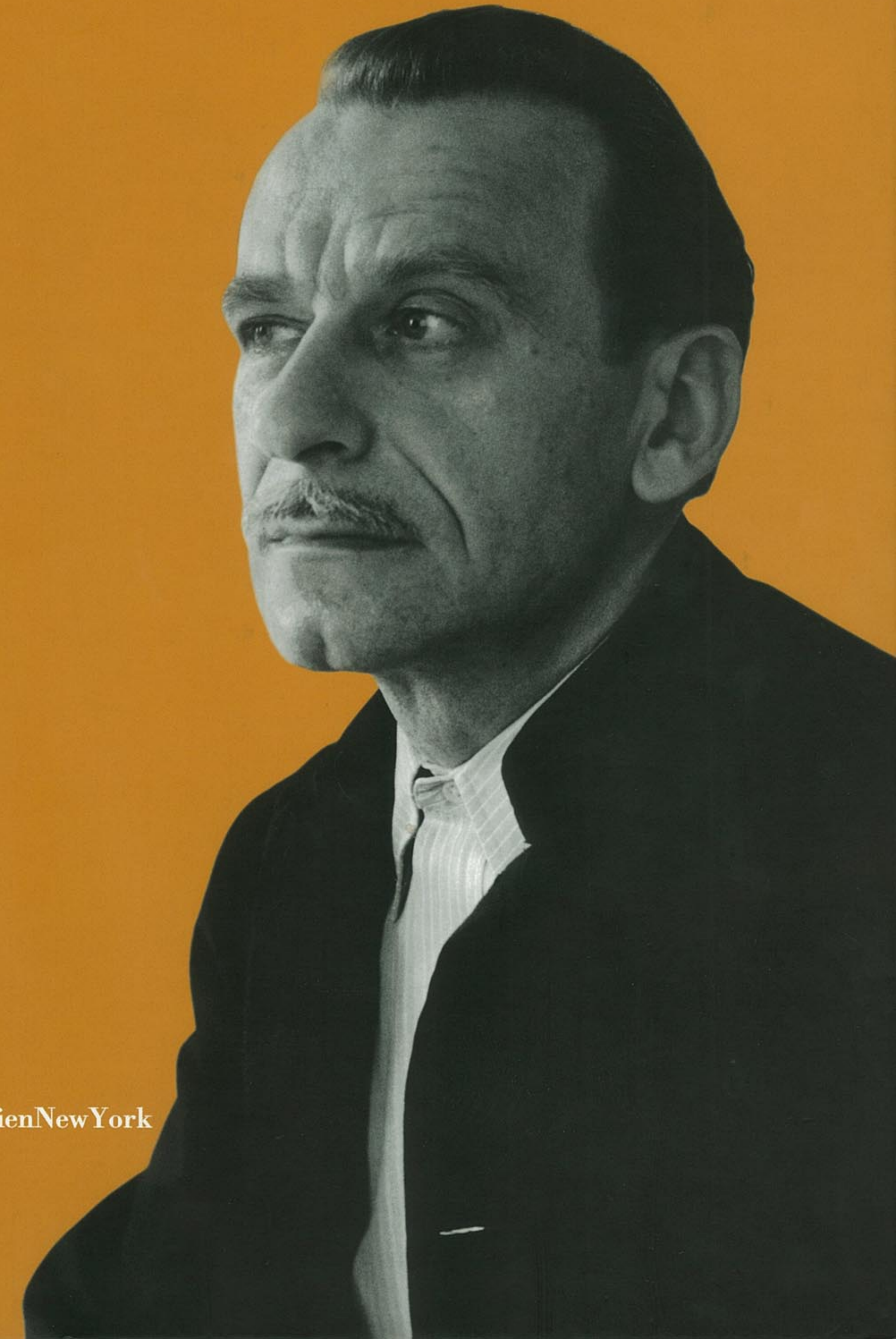

Andrea Bocco Guarneri

## Bernard Rudofsky A Humane Designer



Springer Wien New York

*"I would not be surprised, if you believed that basic problems were solved long ago. Besides, you may not consider them problems in the first place.*

*You probably think of food, clothes and shelter in terms of commodities - something that money can buy. What I see in them are the tangible criteria of a culture."*

Bernard Rudofsky

This is the very first book dedicated to Rudofsky. It deals with the work and thought of the Austrian-born architect and author who lived in Italy, Brazil, the USA, Japan, the UK, and finally Spain. In his life he produced interesting Modern buildings in the Thirties (e.g. villa Oro, Napoli; casa Frontini and casa Arnstein, São Paulo), new-concept apparel in the Forties (notably, Bernardo Sandals), and many provocative exhibitions in Europe and the USA (among which, Architecture without Architects at the MoMA in New York, 1964, and Sparta / Sybaris at the MAK in Wien, 1987).

Rudofsky's teachings were first of all directed to the layman, and books such as Architecture without Architects, only to mention the most famous, received tremendous critical and popular acclaim. The original edition sold more than 100,000 copies and was translated into Japanese and the major European languages. All those people who discovered Bernard Rudofsky through one of his many works, will find this a thorough, agreeable, and well documented portrait.

ISBN 3-211-83719-1

[www.springer.at](http://www.springer.at)



**Bernard Rudofsky** A Humane Designer

## Impressum

Text and research by Andrea Bocco Guarneri

Printing was supported by Bundeskanzleramt–Sektion Kunst, Bundesministerium für Bildung, Wissenschaft und Kultur and by Magistrat der Stadt Wien MA7 – Kultur

This work is subject to copyright.

All rights are reserved, whether the whole or part of the material is concerned, specifically those of translation, reprinting, re-use of illustrations, broadcasting, reproduction by photocopying machines or similar means, and storage in data banks.

Product Liability: The publisher can give no guarantee for all the information contained in this book. The use of registered names, trademarks, etc. in this publication does not imply, even in the absence of specific statement, that such names are exempt from the relevant protective laws and regulations and therefore free for general use.

© 2003 Springer-Verlag/Wien

Printed in Austria

Translation by David S. Tabbat

Drawings at pp. 36–39, 46–49, 60–61, 79, 82 by Massimiliano Stefàno

Photo acquisition and post-treatment by Luisa Montobbio

Translation of Biographical Notes (p. 15–29) and Catalogue (p. 254–310) by Michael Lavin

Graphic Design: Loys Egg, A-1180 Vienna

Printing and binding: A. Holzhausens Nfg., A-1140 Vienna

Cover illustration: Evelyn Hofer. Bernard Rudofsky as he appears on *Streets for People* cover, ca. 1969.

Le Corbusier – © FLC/VBK, Vienna, 2003

Ernst A. Plischke – © VBK, Vienna, 2003

Adolf Loos – © VBK, Vienna, 2003

Frank Lloyd Wright – © VBK, Vienna, 2003

Every reasonable attempt has been made to identify owners of copyrights.

The publisher is at disposal of people/bodies holding rights whom it has been impossible to identify or to get in touch with.

Author's note on the title

As we will discuss in the chapter "The Didactics of Curiosity," Rudofsky disdained the word "designer," mostly because of the frivolous implications it inevitably seems to carry. The word is used, here, signifying one who designs concrete solutions for houses, apparel, furniture or anything else, with the goal to improve the life of one's fellows.

Printed on acid-free and chlorine-free bleached paper

SPIN: 10849862

CIP data applied for

With 301 pictures (39 of which in color)

ISBN 3-211-83719-1 Springer-Verlag Wien New York

# **Bernard Rudofsky** A Humane Designer

Andrea Bocco Guarneri

SpringerWienNewYork

## Thanks

Stanley Abercrombie,  
Angela Althaler,  
Rüdiger Andorfer,  
Renato Anelli,  
Paola Antonelli,  
Betto Balzi,  
famiglia Bentes,  
Paolo Bercah,  
Antonella Bianco,  
Jill Bloomer,  
Rosanna Bocco Parasini,  
Matthias Boeckl,  
Giampiero Bosoni,  
Aldo Capasso,  
Gianfranco Cavaglià,  
Pierangelo Cavanna,  
Daniela Chiara,  
Christo and Jeanne-Claude,  
famiglia Cocozza di Montanara,  
Maria Grazia Conti Daprà,  
Giancarlo e Gianni Cosenza,  
Armendo Dal Molin,  
Cesare De Seta,  
Wim de Wit,  
Sabina Donetti,  
Roberto Dulio,  
Giovanni Durbiano,  
Piero Felisio,  
Beppe Finessi,  
Rosemary Furtak,  
Roberto Gabetti,  
Jacques Gubler,  
Beth Guynn,  
Ruth Hanisch,  
Timothy Heys Cerchio,  
Susanna Jaffei,  
Jeff Jennings,  
Dorothea F. Kidder Smith,  
Malcolm Kirk,  
Lucien Kroll,  
Ingrid Kummer,  
Marshall Lee,  
Jean-François Lejeune,  
Lisa Licitra Ponti,  
Daniela Limido,  
Italo Lupi,  
David Marold,  
Dario Matteoni,  
Andrea Mazzon,  
William Menking,  
Stefano Mirti,  
Luisa Montobbio,  
Andreas Müller,  
Antonio Niego,  
Ruth Nivola,  
Peter Noever,  
Sergio Pace,  
Joel Pereira,  
Francesca Pippia,  
Luca Reinerio,  
Valeria Rossetti,  
Charlie Rossow,  
Philippe Rotthier,  
Ascensión Sánchez Calvo,  
Georg Schwalm-Theiss,  
Hugo Segawa,  
Susan Siegle,  
Adolph Stiller,  
David S. Tabbat,  
Andrew Turner,  
Paolo Verzono,  
Daniel Wiedenhöfer.

The author wishes to express his gratitude and indebtedness to Mrs. Berta Rudofsky, for having generously conceded the publication of her husband's writings and visual materials here reproduced, and much more so for her precious counsel and information along a decade.

Anyway, the responsibility for every error or inaccuracy is to be attributed to the author alone.

## Table of Contents

<b>Table of Contents</b>	5
<b>Introduction</b> . . . . .	9
<b>Biographical Notes</b> . . . . .	15
Map of Rudofsky's Personal and Professional Contacts	30
<b>Essays</b>	
1. <b>On the Architectural Oeuvre</b> <i>(A Natural Philosophy of Architecture)</i> . . . . .	33
Table of Correspondences . . . . .	36
On Style . . . . .	41
Repertory of Compositional Elements . . . . .	46
Mineral vs. Organic . . . . .	50
Purposeless Architecture . . . . .	52
On the House . . . . .	53
Ein Rudofsky-Haus zu bauen? . . . . .	59
Intimacy and Articulation of Indoor and Outdoor Spaces . . . . .	60
The Room . . . . .	62
2. <b>On the Art of Living</b> <i>(A Natural Philosophy of Living)</i> . . . . .	67
Unsatisfactory Relationships . . . . .	71
Clothing . . . . .	75
Everyday Questions . . . . .	83
Some Hints for Enhancing the Quality of Domestic Life . . . . .	85
Furniture Design . . . . .	87
3. <b>The Didactics of Curiosity</b>	
Rudofsky as "un-teacher". . . . .	93
Learning by Confronting Diversity . . . . .	96
A Map of Rudofsky's Travels . . . . .	99
Catalogues . . . . .	101
Rhetoric . . . . .	108
The Dilettante . . . . .	113
<i>After Architecture without Architects, after Architects</i> . . . . .	121
The Ethical Function . . . . .	128
The Didactics of Curiosity . . . . .	134
A Map of Places Covered by <i>Architecture without Architects</i> and <i>The Prodigious Builders</i> . . . . .	140
<b>Rudofsky as a Photographer</b> . . . . .	144
<b>Portfolio</b>	146
<b>A Rudofsky Reader</b>	
What's Needed Is Not a New Way of Building, What's Needed Is a New Way of Life, 1938 . . . . .	175

Fashion: Inhuman Garment, 1938 . . . . .	180
Variations – On a Floor, 1938 . . . . .	183
The Origin of the Dwelling, 1938 . . . . .	184
Give Us Our Dining Room, 1942 . . . . .	189
Notes on Patios, 1943 . . . . .	192
The Bread of Architecture, 1952 . . . . .	196
Pocket Money, ca. 1954 . . . . .	202
Introduction to Japan, 1956–57 . . . . .	209
First Things First, 1961 . . . . .	226
Proposal for a Center for Environmental Studies, 1965 . . . . .	231
The Human Side of Architecture, 1966 . . . . .	236
The Indigenous Environment, 1980 . . . . .	242

### **Catalogue of Rudofsky's Non-Literary Work**

1. Stage Design . . . . .	254
2. Work as a collaborator of O.R. Salvisberg's Studio in Berlin . . . . .	255
3. Hochhaus Herrengasse . . . . .	255
4. Privat Mädchenrealgymnasium . . . . .	256
5. Deutsche Bauausstellung . . . . .	256
6. B. House . . . . .	256
7. Project for the competition for Florence Railway Station . . . . .	257
8. Work as a collaborator of Neapolitan professionals . . . . .	258
9. Project for the competition for the Palazzo del Littorio . . . . .	258
10. Project for the competition for Rome Auditorium . . . . .	259
11. Albergo Rio di Raia delle Rose . . . . .	260
12. House for Berta Doctor . . . . .	261
13. Furnishing of a derelict house in Procida . . . . .	262
14. Tennis Club . . . . .	262
15. Clothes . . . . .	263
16. Sandals . . . . .	264
17. Casa Oro . . . . .	264
18. Sandals and Split-Toes Stockings . . . . .	267
19. Chairs and armchairs. . . . .	268
20. "Theatrum Nudum" . . . . .	269
21. Villa Campanella . . . . .	269
22. Alberghetto a Positano . . . . .	270
23. Borletti apartment . . . . .	271
24. Hotel for Dalmatia . . . . .	271
25. Albergo di San Michele . . . . .	272
26. Furniture for the "Casa & Jardim" Studio . . . . .	274
27. Sandals . . . . .	275
28. "Jean Richard" Watch Shop . . . . .	275
29. Casa Hollenstein . . . . .	276
30. Casa Frontini . . . . .	277



31.	R House . . . . .	279
32.	Casa Arnstein . . . . .	279
33.	Casa Marsicano (?) . . . . .	281
34.	Fotóptica . . . . .	281
35.	Villa D . . . . .	282
36.	<i>Organic Design</i> competition entry . . . . .	282
37.	Sandals . . . . .	284
38.	John B. Salterini Co., Inc. Office . . . . .	284
39.	Split-toe stockings . . . . .	285
40.	<i>Are Clothes Modern?</i> exhibition . . . . .	285
41.	Bernardo Sandals . . . . .	287
42.	Accessories produced by Bernardo Sandals, Inc. . . . .	288
43.	House for Berta & Bernard in the County of Berkshire . . . . .	288
44.	Three-bedroom house . . . . .	289
45.	Master plan for a plot . . . . .	290
46.	Window Wall Cabinet . . . . .	290
47.	"Stimulus" fabrics . . . . .	291
48.	"Alpha" lamp . . . . .	292
49.	Nivola "house-garden" . . . . .	292
50.	House for Berta & Bernard in Amagansett . . . . .	293
51.	Latin cross-shaped house . . . . .	294
52.	Bernardo Separates . . . . .	294
53.	"Bernardo Bareskins" . . . . .	296
54.	Costumes for <i>Barefoot in Athens</i> . . . . .	296
55.	Bed plus storage – Extension tables . . . . .	296
56.	"Cookie-Chairs" . . . . .	296
57.	<i>Textiles USA</i> exhibition . . . . .	297
58.	Exhibitions in the USA Pavilion at Expo 1958 . . . . .	298
59.	Circulating Exhibitions for the Museum of Modern Art . . . . .	299
60.	TAP Offices . . . . .	300
61.	Carmel residence "Garden-house" . . . . .	301
62.	<i>Architecture Without Architects</i> exhibition . . . . .	302
63.	Yale Center for Environmental Studies . . . . .	303
64.	La Casa . . . . .	304
65.	House in Andalusia . . . . .	306
66.	<i>Now I lay me down to eat</i> exhibition . . . . .	306
67.	Ideal house (?) . . . . .	307
68.	<i>Golden Eye</i> . . . . .	308
69.	<i>Sparta/Sybaris</i> exhibition . . . . .	310

## Appendices

Literature by and on Rudofsky . . . . .	311
Credits . . . . .	318
Index . . . . .	319

## Introduction

I first came across the name of Bernard Rudofsky in the course of a study of the archetypes of human dwellings. I read whatever I was able to find by him in the libraries to which I had access; when I had grown so fascinated that I wanted to get to know the author, I discovered that it was too late. However, Lisa Licitra Ponti put me in touch with Rudofsky's wife, Berta, without whose indispensable help and constant support this book would not have been possible.

Over the ten succeeding years, I tried to follow some his traces in places that were important to him, and I had the opportunity to study firsthand the archives he left behind: his personal ones above all, but also those now preserved in various institutions in Europe and the United States.

The Mediterranean was Rudofsky's first great love. Its scents, its warmth, and the "truth" of its way of life attracted him when, as a student, he began the ceaseless and curious travels that furthered his exploration of the art of living. He moved there at the moment when modernist architects were reading its rural buildings in terms of affinities with their own intentions. Le Corbusier, guided by Anastassios Orlandos, was discovering the white cubes of the Greek isles and setting forth a Mediterranean ideology, a powerful tool for trying to get beyond the schematic functionalist bases of German rationalist architecture;<sup>1</sup> Sert was finding, in the minor architecture of the Balearic Islands, elements that could help make up for the delay with which the Catalan modernists had appeared on the international artistic scene; and the young Italian modernists were exalting the architecture of the Bay of Naples in an attempt to reconcile the new formal language with the rhetoric of autarchy. But while all this was happening, Rudofsky was going beyond stylistic questions: in his architectural training modernism had been an accepted point of departure, not a topic for discussion. He was seeking in the Mediterranean a way of life not yet ruined by the progress he so feared, for all that he was unable (and unwilling) to turn his back on it.

It was, once again, curiosity that led him, in the fifties, to spend two years in Japan, a country whose material culture he had admired while a student, and where he turned his attention — as he also did in Italy and elsewhere — to the way of life rather than to the monuments.

The life of Rudofsky — who was born and lived in many "places that belong not to geography but to time"<sup>2</sup> — intersected with a good

1 Josep M. Rovira, *José Luis Sert. 1901–1983*, Milano: Electa, 2000, p. 204, 220–221, 223. See also *Le Corbusier et la Méditerranée*, Marseille: Parenthèses – Musées de Marseille, 1987.

2 Saul Steinberg, *Riflessi e ombre*, Milano: Adelphi, 2001, p. 36.

number of the twentieth century's most decisive cultural events: the *Finis Austriae*; the heroic period of the "new architecture;" the cultural blossoming of Brazil, a land of great hopes; the pilgrimage of European artists and intellectuals towards the intense cultural climate of New York in the forties; the intensification of the relationship between the West and Japan; the critique of progress and of homogenization under Anglo-American cultural hegemony. Rudofsky experienced all this, encountering many of the period's leading intellectual and creative figures. But he never made it into the charmed circle of the elect, despite the worldwide success of his most famous show, *Architecture without Architects*.

Rudofsky could have become a celebrated architect, like some of his contemporaries who belonged to the so-called "second generation" of modernism.<sup>3</sup> His buildings in Italy and Brazil attracted extraordinary attention in the period around the war. But once he had moved to the United States, he didn't receive (or was incapable of obtaining) — despite credentials such as *Brazil Builds* and *Organic Design*, and notwithstanding the notable success of the show *Are Clothes Modern?* — opportunities for the development of a busy career as a designer of buildings. And because of his individualistic and stubborn character, he systematically broke off his academic activity in all the important schools where he had a chance to teach. Nevertheless, he found in New York the rich cultural environment he was looking for. What other place in the world could have offered similar opportunities for intellectual contacts? What other setting could have been so influential, so capable of giving rise to such a wide and intense debate and of spreading his ideas throughout the world?

Endowed with a taste for the polemical, he had an agreeably ironic manner of stigmatizing the American way of life, standardization and cultural oversimplification; having elected to become "the critical salt of modern living,"<sup>4</sup> he became — perhaps to a degree surpassing his own intentions — one of the putative fathers of social and intellectual movements offering an alternative to mass culture, standardization, and modernism itself.

Rudofsky knew how to look; he knew how to bring together experiences gathered over decades of living in different countries and set them forth in the form of books and shows. These were aimed at the general public, on account of his bitter lack of faith in architects' ability to fulfil their task of building houses in which real people might live a pleasant life. He knew

3 Vittorio Magnago Lampugnani, "Modern, Movement" and "Rationalism", in Vittorio Magnago Lampugnani (ed.), *Lexikon der Architektur des 20. Jahrhunderts*, Ostfildern-Ruit: Verlag Gerd Hatje, 1998.

4 AR88.1.

how to connect, with no academic restrictions, matters that seemed to him to be simply different aspects of the same problem: housing, clothing, the urban setting, food, the way of life.

This is, I believe, the deepest meaning of Rudofsky's work, and the fundamental reason for paying attention to him today: his life and work constitute an example — not the only one, to be sure, but nevertheless one of the twentieth century's most complete and convincing — of a person who reflects and creates in terms of the humanistic wholeness of life. His independent activity, detached from prevailing habits, offers an early example of attention to material culture and everyday life, presaging the contemporary cross-cultural attitude, with its readiness to learn from heterogeneous and fragmentary sources in order to recompose them into a whole that can no longer aspire to stability and absoluteness.

With respect to innovation, he was at once an insider (with his purist architectural vocabulary, his pursuit of "rationality" and simplification, his radicalism, his interest in spontaneous architecture as a primordial source, his belief in the singleness of human nature, etc.) and an outsider (with his distrust of progress, his refusal of materialism and of the reduction to a functional minimum, his emphasis on the quality of the vernacular, which ended up by providing arguments against modernity, his search for a relationship with each specific place, his rejection of standardized solutions, etc.). This stance, at once coherent and contradictory, makes him a figure worthy of particular critical attention.

Despite the numerous reasons for interest in his thought, for a long time Rudofsky remained somewhat neglected, to the point where, until quite recently, the literature on him amounted to just a few pages. Over the past ten years, various signs from within the architectural discipline in different countries have seemed to indicate a reawakening of critical interest in him.

At this point, I must offer two clarifications.

The first is that this book is intended both for those who already know some of Rudofsky's work and for those who are not yet acquainted with him. It provides a first introduction to his work and thought, in hopes of arousing the reader's curiosity and the desire to go more deeply into the subject through personal research. There are so many aspects to my subject that, even in a book of 320 pages, it has not been possible for me to explore them all thoroughly, in part because of the slightness of my familiarity with certain of them. Specific topics touched on only lightly here deserve to be more adequately developed in the future,

just as it would be worthwhile to publish certain of Rudofsky's unpublished texts.

The second is that, like Rudofsky himself, the author of this book is not a historian, but an architect; I have approached his work as a person with practical architectural experience. I am convinced that the study of Rudofsky not only constitutes one small tessera in the mosaic of twentieth-century cultural history, but that there can still be found in his work issues relevant to criticism and fruitful, usable elements, and that the questions to which he draws attention remain crucially important for thinking about architecture.

The book is structured as follows.

First of all, a short biographical note. Although I have been able to gather direct personal testimony and consult a large number of documents, I have tried not to linger too long over biographical details. A *vita mirabilis* would certainly not have pleased Rudofsky, who was committed to preserving the intimacy of the individual's private life. This has allowed me to devote more space to his work and thought, which I believe to be of greater importance to the reader.

There follows an essay by myself: a personal and selective reading structured around two themes that run through Rudofsky's work — two nuclei, as it were, around which I have condensed what seems to me his intellectual legacy. It is to the first of these themes, the dignity of material life, that the first two chapters of my critical essay are devoted: the first emphasizes aspects having to do most directly with architecture, while the second lays stress upon ways of life. The second theme, the teaching of curiosity and independence of judgment, forms the subject of the third and final chapter.

The essay is made up of brief texts, sometimes in the form of fragments, elsewhere connected in a more sequential manner; there are also some maps and boxed sections containing comparative readings and drawings made for this specific purpose.

I have made considerable use of published and unpublished texts by Rudofsky and other authors. For reasons of space and in order to prevent my argument's getting bogged down in too much detail, it has not been possible to explain on every occasion the reasoning behind the connections which are thus established. In general, the other figures cited are people with whom Rudofsky had a direct relationship, or the authors of sources which he consulted; in some instances, I discern in their work a direct relationship with his own. The most frequently quoted are Adolf Loos and Josef Frank, on account of the continuity of themes, critical commitment, and ways of understanding "modernity"

that links the three Viennese architects. Overall, the evocation of so many voices has served me as a way of trying to situate Rudofsky within the context of debate on culture as a whole and architecture in particular.

The frequent use of the historical present tense in my discussion is intended to suggest that a chronological treatment is not the most suitable for Rudofsky, given the surprising stability over time of his thought and work, for which I have nonetheless attempted to establish a temporal context.

Next comes a "reader" of 13 of Rudofsky's most important writings, selected from among hard-to-find articles, some of them never before translated into English, and from numerous unpublished pieces found in his files. I have included no selections from his books. The texts cover a period of around 50 years, from the early thirties to 1980. I have tried to give a broad idea of his literary output in terms both of genres (articles, lectures, projects, diaries) and topics (dwelling, architecture without architects, clothing, teaching, autobiography...). It has been my intention to let him speak for himself, so that the reader may appreciate directly his style and arguments.

This selection is followed by a catalogue of the 69 non-literary works of Rudofsky known to me. I have thought it best to avoid dividing them into the categories of architecture, furniture, and clothing, so as to draw attention to the unity of a corpus that is heterogeneous but coherent.

The book is completed by a bibliography of those of Rudofsky's writings that are known to me and of writings about him by others.

The catalogue and apparatus are meant to provide supporting information for further scholarly inquiry.

The whole text is accompanied by a generous selection of images, of which more than half are previously unpublished.

I hope that this book may offer the reader arguments in support of the idea that, independently of material resources, what matters is our knowing how to lead a full existence, one worthy of being lived.

As was custom at the time, Rudofsky often signed by translating his first name into the language of the country he was currently living in. In the original documents, therefore, we find Bernhard, Bernardo, Bernard and even Banado depending on whether he was living in Austria, Germany, Italy, Brazil, the U.S.A. and Japan. In this book, the pristine German spelling has been used up to Rudofsky's first trip to the U.S.A. (1935–36), after which the English version has been adopted.

(Author's remark)

The captions credit first the name of the material author(s) of the illustration – author of the photography (not of its subject), draughtsman (not author of the architectural design), etc. –; this is followed by a (?) if the attribution is uncertain. Then come the title (if known) or description of the illustration's subject, and the date. Proper credit references are given at page 318.

*This document derives largely from notes compiled by Rudofsky himself and from information by Berta Rudofsky over the course of the last 10 years. Anyway, I take the responsibility of any inaccuracy or omission. In particular, while precise internal verification has been attempted, it has often not been possible to check data from external sources.*

## Biographical Notes

1.

Bernhard Rudofsky was born on April 19, 1905 in Zauchtl (Suchdol), Moravia.<sup>1</sup> He was the eldest son of Bernhard Rudofsky, born in 1875, and of Elisabeth Primus. The couple were married in 1903. The family was Catholic on the father's side and Evangelical on the mother's.

Family records reach back as far as Johann Georg Rudowsky, who was born in 1653 in Rudow, Galizia, and who settled in Bischofteinitz (Horsovský Týn), Bohemia, in about 1680. The farm he founded is said still to exist. The original surname, Rudowsky, was changed to Rudofsky in 1898.

In 1906, the family moved to Vienna where Rudofsky's father, a veterinarian doctor, inspected imported cattle and swine at the Market Supervisory Board of the city.

His only sister, Elfriede, was born in 1909.

In 1915, he entered the Realschule XV.

<sup>1</sup> Due to a transcription error probably dating from 1936, the following documents bear the date April 13.

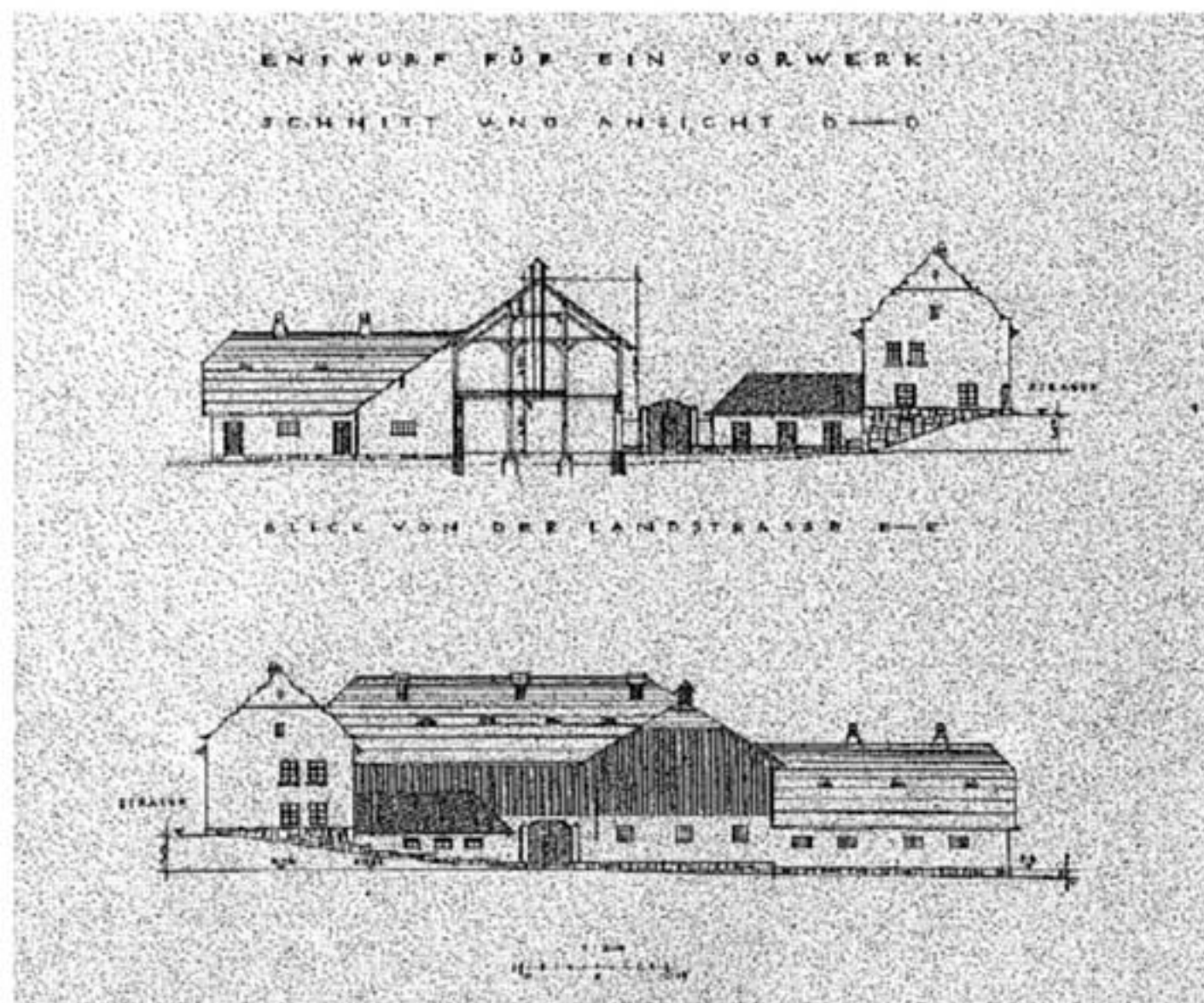

*Bernhard Rudofsky. Project for a high-class mansion and dairy annex, designed as a practical exercise for the Course in Construction Theory. The drawing bears the stamp of the Vienna Technische Hochschule, 1927. Section and elevation, 1:100 scale.*





Unknown photographer. Rudofsky (center) enjoying a snack of grapes and volcanic wine on a Santorini terrace, 1929.

See *The Indigenous Environment*, p. 242 ff.

Unknown draughtsman (Bernhard Rudofsky?). Study of architectural elements of traditional buildings on Santorini, ca. 1920s.

2.

After graduating from college in 1922, Rudofsky embarked on his studies at the Technische Hochschule. He did not attach much importance to his university training, nevertheless it stood him in good stead in the countries where he worked and constituted an effective visiting card: "The professors<sup>2</sup> who taught us the tricks of the trade were mostly aristocrats, snug in the shade of their stout family trees. In the course of their life they had bestowed upon the nation their quota of neo-baroque theaters, neo-gothic cathedrals and some such pseudomorphs. Of course, it wasn't their work that captivated us; the active leavening for the dough was only partly obtained at the university. Instead, the fermentation of architectural thought and feeling was furthered by, of all places, the stage."<sup>3</sup> As a student, Rudofsky preferred plays, concerts and lessons at the conservatory to his architecture lectures.

Of greater importance still was the knowledge he acquired through the extended travels he undertook every summer, including a 1923 journey to Germany where he visited Weimar and the Bauhaus exhibition, a voyage down the Danube to Istanbul and further into Asia Minor in 1925,<sup>4</sup> and trips to France in 1926, and Italy in 1927. He studied archaeological remains, traditional Mediterranean architecture, as well as recent Northern European buildings.

3.

In the last part of his university attendance, he worked with the film director G.W. Pabst as a set designer.

He took his finals at the Technische Hochschule between May and July 1928 and graduated with a degree in Architecture and Engineering. During the summer, he took a trip to Sweden. In September, he moved to Berlin to work in the office of Otto Rudolf Salvisberg. His mother died.

<sup>2</sup> See AR65.9.

<sup>3</sup> GYC.

<sup>4</sup> Bernard Rudofsky's letter to Luis Marsans, dated 11 November 1963.

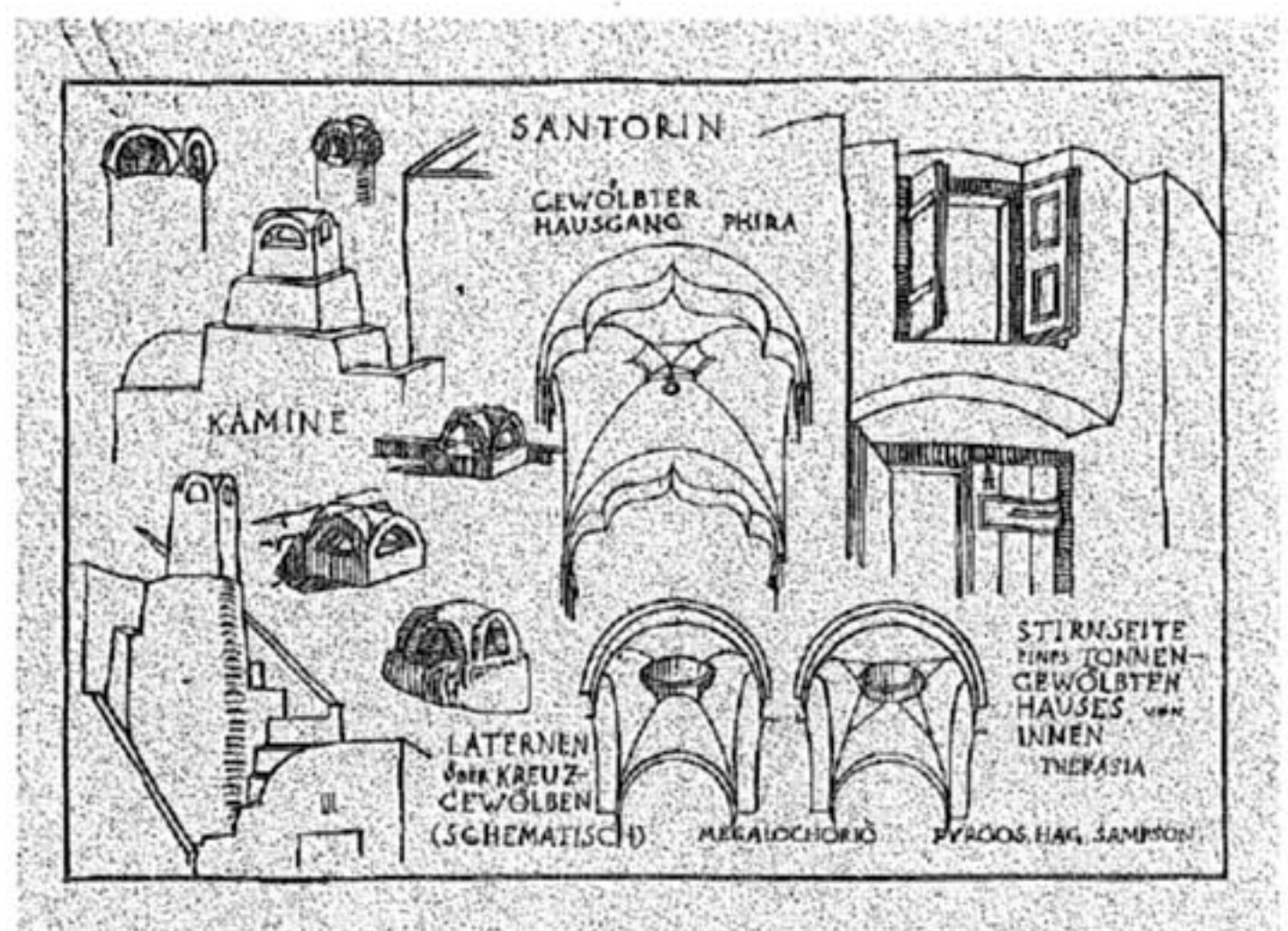

Bernhard Rudofsky. Caricatural drawing of the Island of Capri, ca. 1933. From the series Die Insel der Verrückten (The Isle of Crazy People).

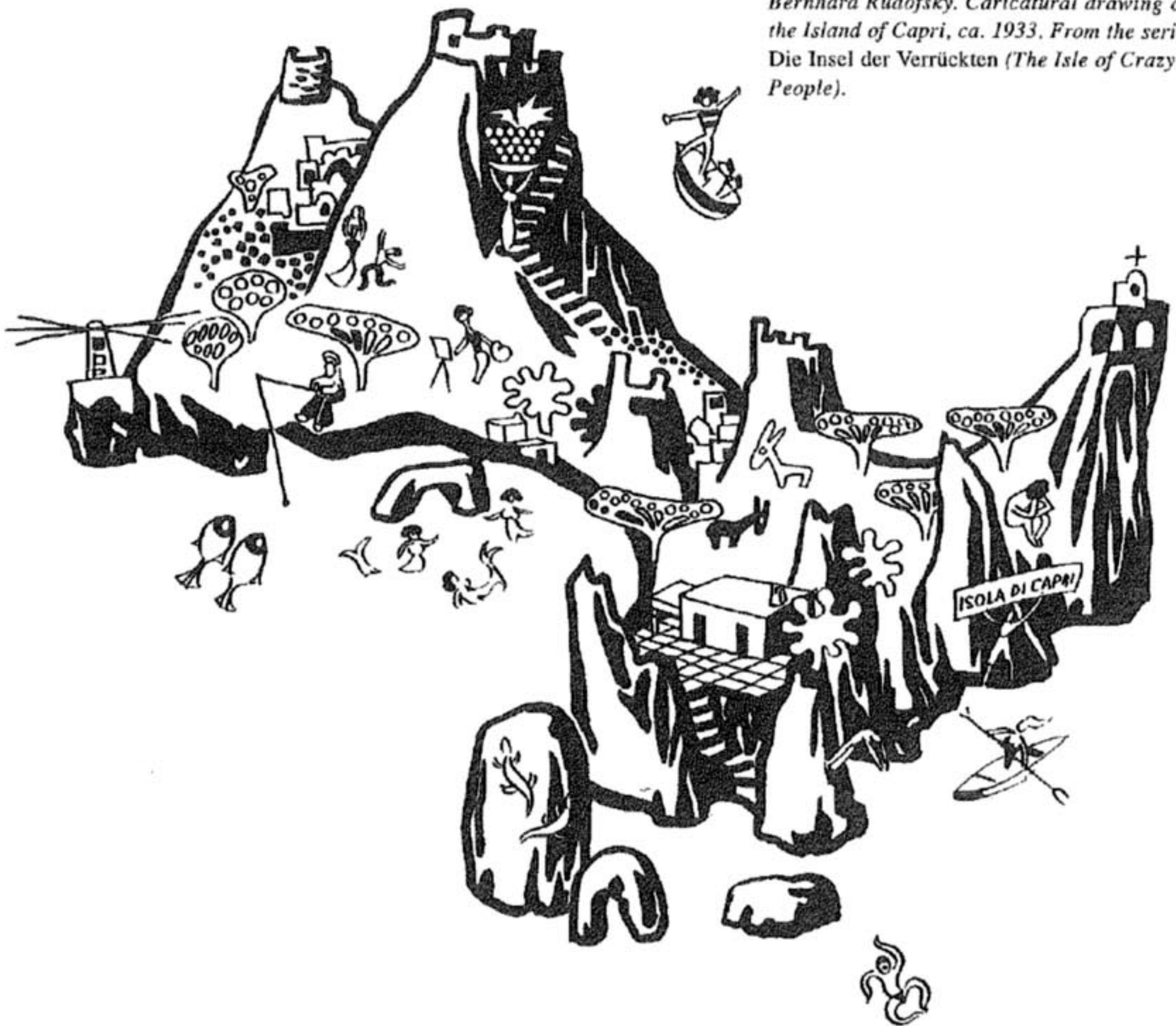

During the summer of 1929, Rudofsky went to Greece, spending some time on the island of Santorini.

He returned to Vienna in January 1930, and began working at the office of Theiß and Jaksch in March.

He designed the layout for the Austrian section of the *Deutsche Bauausstellung Berlin* where he exhibited photographs of examples of 'spontaneous' architecture, mostly taken on Santorini. Also on Santorini he wrote his doctoral dissertation, *Eine primitive Betonbauweise...*, which he successfully defended in 1931 at the Technische Hochschule to become a Doktor der Technischen Wissenschaften (Doctor of Technical Sciences). The thesis was an analysis of the logic and techniques of traditional cement construction in the Greek islands compared with modern concrete structures.<sup>5</sup>

In October, he exhibited 26 architectural landscapes of scenes from Italy, Turkey and the Greek Islands at the *Ausstellung der Aquarellisten – Vereinigung der Genossenschaft der bildenden Künstler Wiens* at the Künstlerhaus.

See *The Origin of the Dwelling*, p. 184 ff.

<sup>5</sup> TPB, p. 238.

4.

In March 1932, Rudofsky, who loved the sea and the sun, went to live in Capri, which he had previously visited in the summer of 1931. He stayed there for almost two years.

The Capri period was characterized by Rudofsky's having a good time and meeting people. He made ends meet by writing articles for the Viennese journal *die Bühne* and for the illustrated supplements of the *Berliner Tageblatt*, and as a draftsman for planners and building companies, as well as by teaching German.

He met Luigi Cosenza, who invited him to collaborate on a project for the competition for the Palazzo del Littorio in Rome.

5.

Rudofsky published his first article on architecture in the January 1934 issue of *Wasmuths Monatshefte für Baukunst*.

After he had established a more stable working relationship with Cosenza, he went to Naples. They worked together on a project for the Rome Auditorium competition, and visited Ischia and Procida, taking photographs and making sketches; they also went to Milan, to meet Gio Ponti.<sup>6</sup> During that same summer 1934, Rudofsky met Berta Doctor, a Viennese musicologist, who later became his wife.

In early 1935, he began the process of purchasing a plot of land in Procida to build a house for Berta. He went to live on the island. Working in Cosenza's office, he designed a Tennis Club and the Oro house, both in Naples.

*Bernhard Rudofsky. Marina Corricella, the fishermen's harbor on the island of Procida, 1934.*

<sup>6</sup> This is not confirmed in the diary, which does, however, mention frequent trips to Rome.

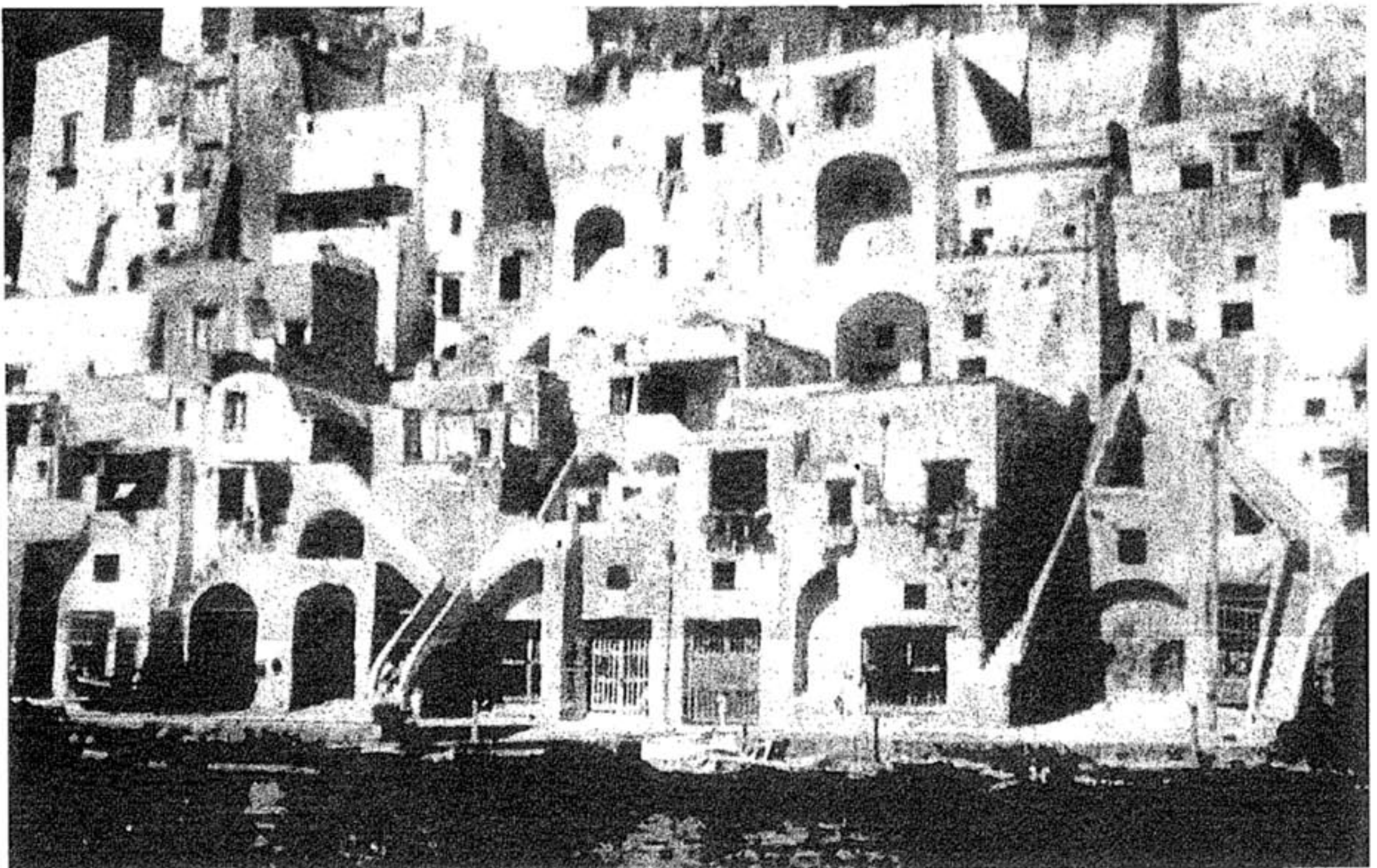

6.

Rudofsky had wanted to go to the United States for some time, but he finally took the decision to make the journey after having received the prize money from the Auditorium competition. He left Naples for Paris in September 1935, where he stayed nearly a month and met Le Corbusier. He arrived in New York on November 3. Three days later he married Berta Doctor at New York's City Hall.

In December 1935, while Rudofsky was in America, Cosenza met Pagano and Persico. As a result of some encounters, the April 1936 issue of *Casabella* was dedicated to him.<sup>7</sup>

Although Rudofsky's first sojourn in New York lasted only nine months, his desire to live there can be traced to the period. It was mainly due to the irresistible lure of the 42<sup>nd</sup> Street Public Library which gave him an unparalleled opportunity to continue his studies.<sup>8</sup>

In January 1936, Berta Rudofsky left the United States for Vienna. In May she gave birth to their only child, Peter.

Between May and July 1936, Bernhard Rudofsky commuted between Forest Hills and Pittsburgh where occasionally gave a helping hand to László Gábor, who a few months earlier had become art director at the Kaufmann Department Store.<sup>9</sup> There he met Frank Lloyd Wright and saw his fellow citizen Oskar Wlach again.

After the end of the Abyssinian war, Cosenza informed him that everything was in place to begin building the Oro house and asked him to return immediately to Naples.

7.

He resumed working with Cosenza in August 1936. The definitive drawings for the Oro house, and for the Campanella project, date from that period.

Rudofsky's father died in 1937. In Spring, he went to live for 6 months in Positano, taking his office equipment with him to continue working there. After the Oro house was almost completed, he let himself be persuaded by Gio Ponti to join him in Milan for working together. Ponti introduced him to the city's artistic and architectural milieu.

Their collaboration produced the plans for the San Michele Hotel at Anacapri, and the editing of the issues for February, March and April 1938 of the journal *Domus*, in which Rudofsky published his ideas about architecture and the way of life. His co-operation with the magazine founded and directed by Ponti lasted several decades.

In February 1938, his son Peter died at Camerlata, near Como.

In order to avoid becoming a citizen of the Reich and being called back to his native country following the Anschluss (1938), Rudofsky obtained a visa for Argentina. In April, he left Trieste aboard an Italian liner.

8.

He arrived at Buenos Aires in May equipped with letters of introduction by prominent Italian architects. But, after only six weeks, when a possibility arose to exchange Argentina for Brazil, he did not hesitate and took the next boat to Rio de Janeiro, where he lived for 6 months. In Rio, he met Ernesto De Fiori, who was working on a sculpture for the

7 AR36.1. Cf. also Luigi Cosenza's letter to Rudofsky, 25 December 1935.

8 Cf. Rudofsky's letter to Alberto Fernando Xavier, 24 October 1978.

9 We learn from Berta Rudofsky's interview with Maria Welzig that Kaufmann provided Rudofsky with financial assistance as well as helping him with the affidavit for his residence permit (AR95.4, p. 202).



The Architectural Review cover for June 1940, featuring a view of Rudofsky's Oro house in Naples.

Bernard Rudofsky. Portrait of his friend Saul Steinberg sporting one of his many hats, ca. 1950s.



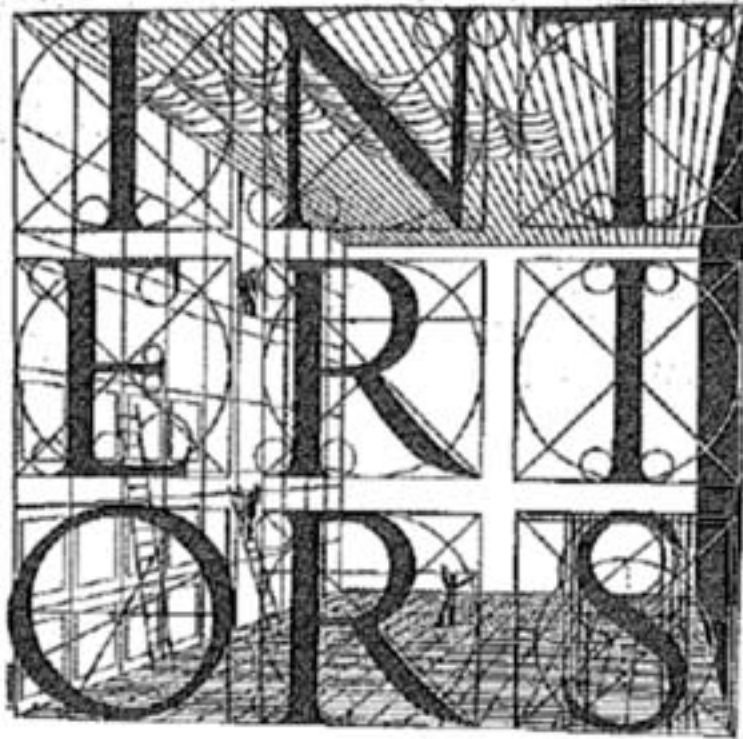

+ Industrial Design

Bernard Rudofsky. *Sketch for Interiors* magazine cover for January 1946.

George Barkentin. Bernardo Sandals style "The Net," 1947 (?).

The Net had a thin, flat leather sole, pierced at 7 points, to allow two strings of natural leather to pass through and tie in many different ways.



Ministry of Education which was being built at the time. Rudofsky possibly was the first to write about modern Brazilian architecture for an European magazine.

In December 1938, Rudofsky went to São Paulo to work at the newly opened subsidiary (Studio Casa e Jardim) of the Heuberger Gallery, founded and directed by the German immigrant, Theodor Heuberger.<sup>10</sup> He worked there as art director and independent designer. But as a foreigner with a foreign degree, his qualifications were not legally recognized in Brazil. He took an apartment in the recently finished Esther building (Alvaro Vital Brazil and Adhemar Marinho), a symbol of modern architecture in São Paulo.

Between 1939 and 1940, he designed and built for Europeans who had immigrated to Brazil the Hollenstein house at Itapeccerica; a number of shops, the Frontini and Arnstein houses in São Paulo; and designed houses and villas which were never built. (It seems that within the modern German and Italian élite, new building jobs and new professional contacts came quickly and easily).

He took part in the second Salão da Família Artística Paulista and in at least one Salão de Maio.

*The Architectural Review* published the Oro house and Rudofsky's photographs of popular architecture on Santorini.<sup>11</sup>

He went to New York in April 1941, after learning that he was one of the winners of the Museum of Modern Art's pan-American *Organic Design* competition. (Since his Austrian passport had become useless following the Anschluss and by refusing to accept a German passport, he was given a provisional document valid for this one trip only: entry to the USA.)

## 9.

Either directly or indirectly through the reception for the winners of the *Organic Design* competition, Rudofsky met Eames, Gropius, Johnson, and the Saarinens, as well as the future authors of *Brazil Builds*, Goodwin and Kidder Smith.

He made friends with the Italian artist Costantino Nivola, and met Sert, Texidor, Steinberg and Schawinsky.

Part of the *Organic Design* prize was a round trip across the United States, which Rudofsky took between July and September. In California, he met Chermayeff, Neutra, Wurster and a number of European film directors.<sup>12</sup>

Rudofsky recounted that "I was asked by Philip L. Goodwin, director of [MoMA's] Department of Architecture, to suggest some unhackneyed subjects for exhibitions."<sup>13</sup> It is possible that among the propositions he made were *Are Clothes Modern?* and *An Analogy Between Architecture and Clothes*,<sup>14</sup> as well as an exhibition on spontaneous architecture (which eventually became *Architecture without Architects*). In the wake of Pearl Harbor, the Rudofskys would have been considered enemy aliens in Brazil, while they could decide to stay in the USA, where Austrians were considered victims of Nazism, and apply for first papers. Rudofsky's choice of where to live was a determining factor in the subsequent development of his professional career. The possibilities offered by New York were very different from

10 See AR83.1.

11 AR40.3 and BR41.3.

12 While in Italy, Rudofsky had exchanged letters with Neutra in the ultimately forlorn hope of working with him.

13 TPB, p. 366.

14 Based on Gerald Heard, *Narcissus. An Anatomy of Clothes*, London, 1924.

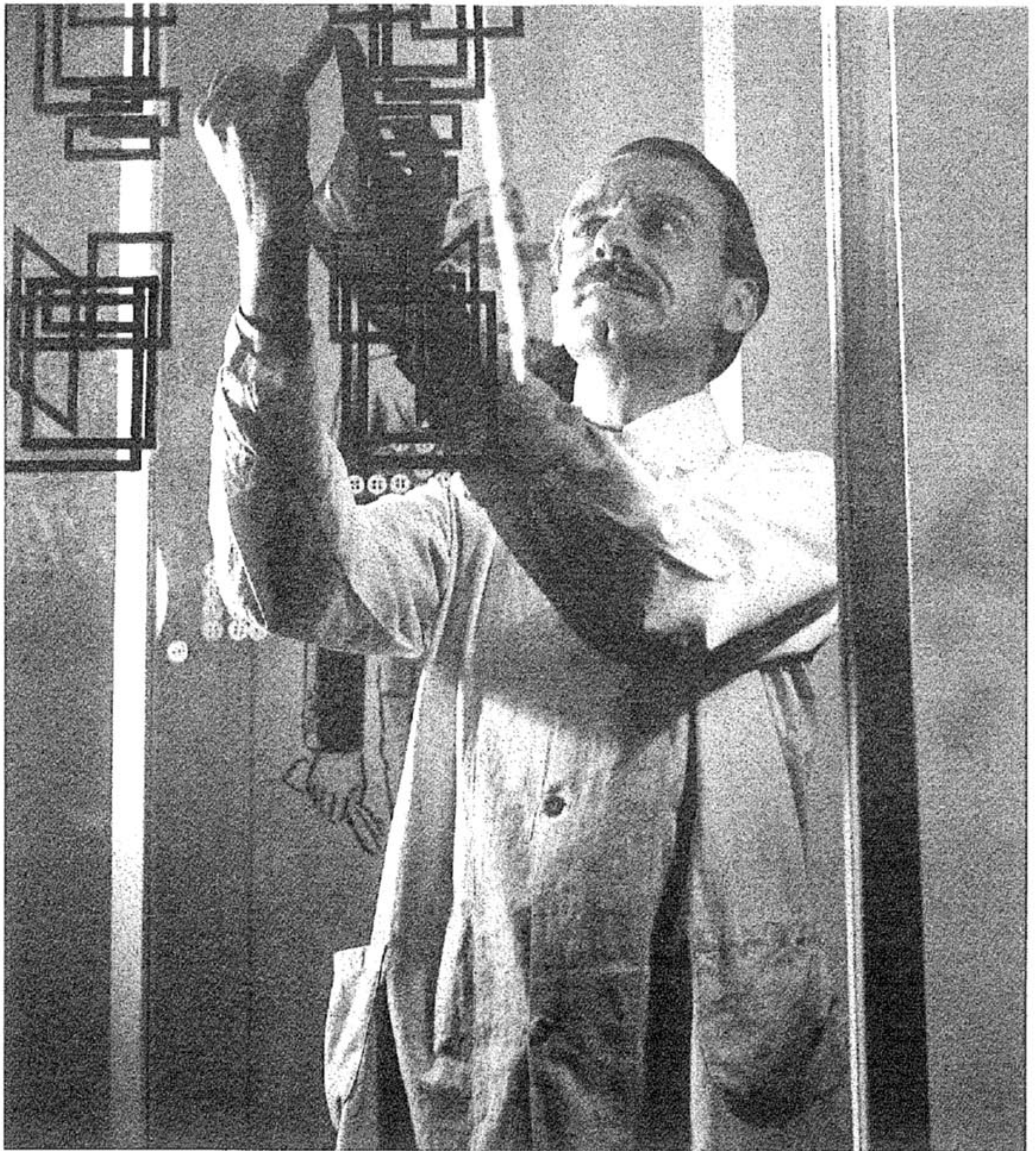

those in California (or Brazil).<sup>15</sup> In fact, even though the move to New York almost marked the end of his career as an architect, he found there a rich cultural life in the 1940s unparalleled anywhere in the world.

*Barbara Sutro. Rudofsky preparing a translucent board for his Are Clothes Modern? exhibition, 1944.*

<sup>15</sup> Siegfried Giedion observed that "had [Neutra] remained in New York like so many others, he would probably have been driven into the world of pure theory or into the teaching profession" (Willy Boesiger (ed.), *Richard Neutra, Bauten und Projekte Band I (1923-1950)*, Zürich: Editions Girsberger, 1951, p. 8).

10.

Rudofsky spent the 1940s in New York.

Due to the War, architectural jobs were hard to get even for native Americans. The only project Rudofsky completed was the office-cum-pied-à-terre for John B. Salterini in New York. Despite the fact that his Brazilian work was much remarked upon and had been widely reported in the specialized press, receiving enthusiastic response,<sup>16</sup> the houses he designed for himself and his wife and others remained at the conceptual stage. He worked for a short period in William Lescaze's studio, where Augenfeld was also employed.

From 1942 to 1943, Rudofsky was associate editor and art director of *New Pencil Points*, where he was responsible for layout, graphics, and magazine covers. In June 1946, he succeeded Nivola as art and architectural editor of *Interiors* magazine; in June 1947 he became its editorial director. He was responsible for layout and graphics. Since he had no budget, he made friends, including Steinberg, Albers, Le Corbusier, Ray Johnson, and himself, design the covers. The articles published in *Interiors* during this period bear witness to Modernism's victory in the USA. Their subjects included Fuller, Eames, Raymond, Harris, Breuer, Sert, Chermayeff, Augenfeld, Corbett, Neutra, Gruen, and Lapidus. Rudofsky published his own articles and edited reports on stage design, and interior architecture and furnishings in Italy. He left the magazine in January 1949.

The exhibition *Are Clothes Modern?* established Rudofsky as a member of the New York cultural élite. The show, which opened in 1944, was widely reported and gave rise to a virulent debate lasting several months. Three years later, Theobald published the eponymous book. The first *Bernardo Sandals* collection, designed by Rudofsky according to the principles he had illustrated in the Museum of Modern Art exhibition, was presented at the Ritz Carlton Hotel in April 1946. The sandals met with great success and were produced for twenty years. In 1948 he became an American citizen.

16 "[Kidder] Smith and I have been in São Paulo five days and want to write to you at once to tell you how great my pleasure and, I admit, my surprise at the Frontini and Arnstein houses [are]. Without question they are the best private modern houses in São Paulo and would stand up anywhere as architecture of exceptional charm and originality." (Letter from Goodwin to Rudofsky dated 25 June 1942).

*Bernard Rudofsky. Invitation card to the presentation of a new collection of Bernardo Sandals, 1953.*

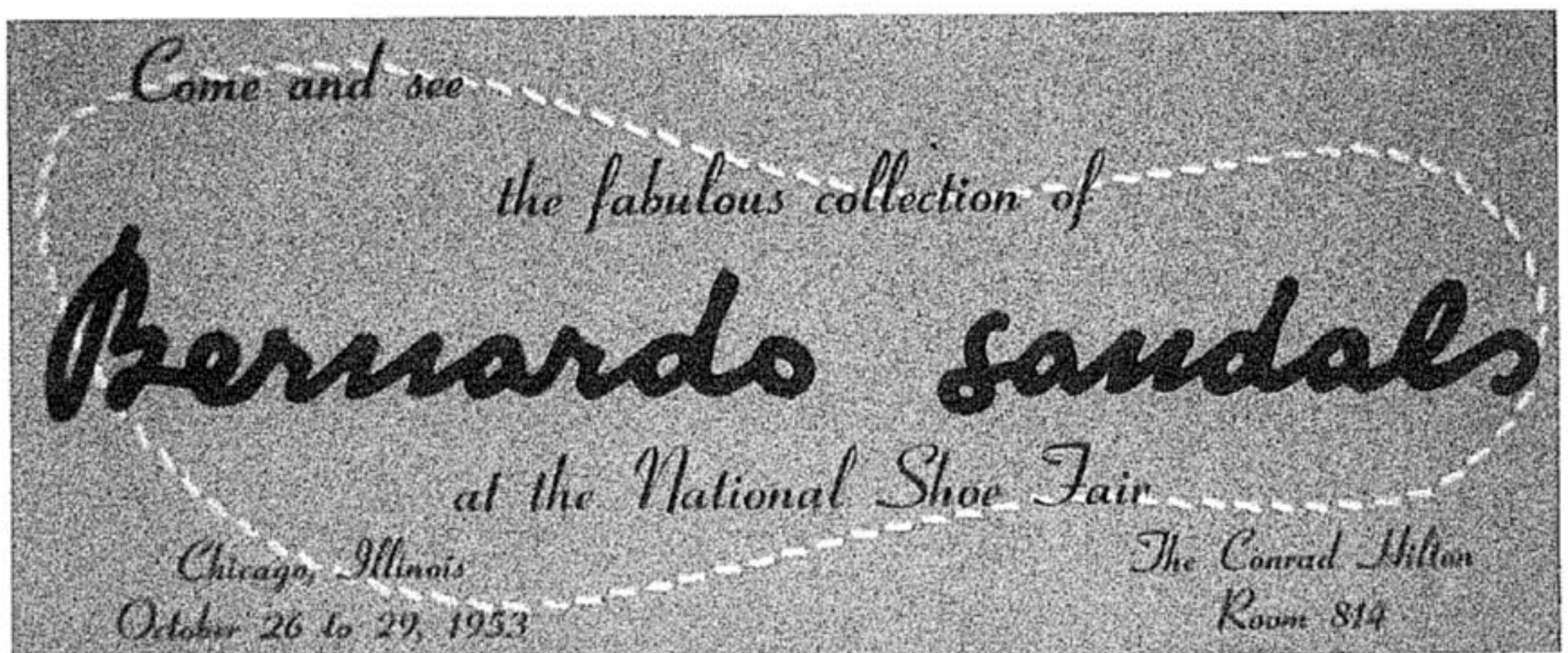

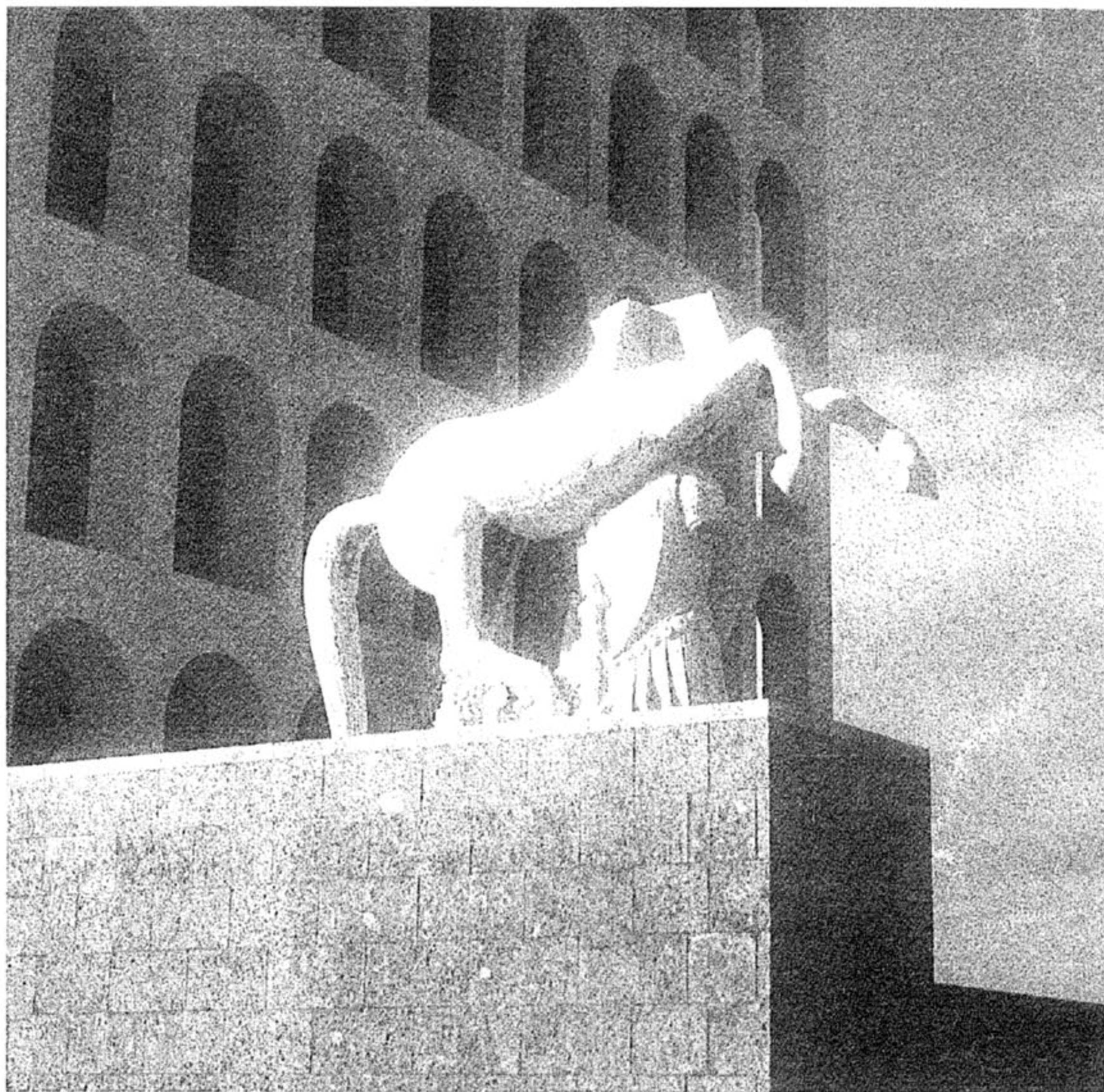

## 11.

As soon as he had acquired his American passport, Rudofsky began to visit Europe again. In 1948, he went to Italy, France and Switzerland; in 1949, Italy, France, Switzerland and Austria. These first trips took the form for almost all those that followed until his death; he would spend some months visiting highly civilized countries, making extensive notes and taking many photographs. The longest trip of this period was the one he took to Mexico in 1951–52.

He transformed some of the curious discoveries he made into articles for *Life* magazine.

From the late 1940s to the mid-1950s, Rudofsky designed drapery and upholstery fabrics (the *Stimulus* collection); the *Alpha* lamp, with Richard Blow; *Bernardo Separates*; costumes for Maxwell Anderson's play *Barefoot in Athens*; and furnishings for Hans Knoll International. During this period, his only completed architectural work was the Nivola

*Bernard Rudofsky. The Third Rome, 1949. This is just one out of a large series of photographs by Rudofsky, representing an amazing discovery of his: the abandoned incomplete buildings of Mussolini's "Third Rome" or EUR42, the satellite town meant to host Rome Universal Exhibition scheduled for 1942. At the time of his visit, the district looked like an archaeological site full of (neo)classical ruins; it was guarded by the military and the access was restricted. As an American citizen, Rudofsky could go in and shoot photographs, which were successively published both by Life and The Architectural Review.*



Unknown photographer. Peter Harnden (left) and Bernard Rudofsky (right) at work on the Brussels Expo project in Harnden's office at Orgeval, France, ca. 1957.

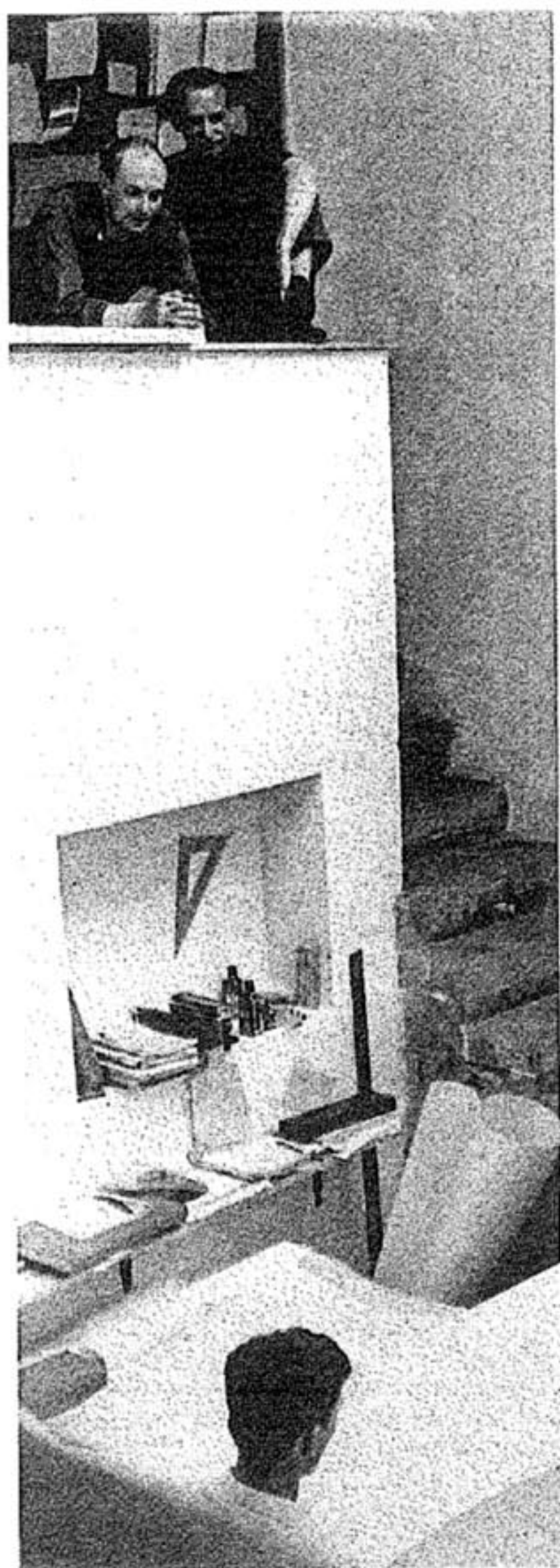

"house-garden" in Long Island, published in *The Architectural Review*, as well as in *Arts and Architecture*, *Domus*, and *Kokusai Kentiku*, accompanied by one of his theoretical articles.

He was one of the authors of the book *Seven Designers Look at Trademark Design* (1952). 1955 saw the publication of *Behind the Picture Window* (Oxford University Press), a book on domestic uses and functions.<sup>17</sup> The first dated notes for the unpublished book *Give Your Child a Chance (Letters of an Optimistic Father)* are from 1951. Also in 1951, his architectural works were published for the first time in Japan.<sup>18</sup> This marked the beginning of a long series: more of his books have been translated into Japanese than into any other language.

## 12.

Rudofsky's interest in Japan originated during his student days. The desire to visit it persisted for many years until he finally made up his mind to spend 3 months there in the summer of 1955. The trip was organizationally supported by Isamu Kenmochi.

Rudofsky was in New York from the fall of 1955 to the spring of 1957. During this period he was Bemis Visiting Lecturer and Critic at the MIT Graduate School of Architecture (at the invitation of Pietro Belluschi). He also designed the installation of the Museum of Modern Art exhibition, *Textiles USA*.

In 1957, he was named "Chief Architect and Originator of the U.S. Government Exhibits" and was given the job, with Peter Harnden, of designing the layout of the USA pavilion at Expo 1958. He did much of the work at Harnden's office in Orgeval, France, starting in May 1957. He stayed in Europe until April 1958, when he left for his second voyage to Japan. This was funded by a Fulbright Scholarship obtained also thanks to the recommendations of Neutra, Belluschi and Gropius.

He remained in Japan until January 1960. During the summer of 1959, he spent 5 months in Tsuda, in a house provided for him by the Governor of Kagawa Prefecture, Masanori Kaneko. He was Research Professor at Waseda University in Tokyo, where he gave lectures and conferences. Various ideas saw the light of day during his Japanese sojourn, including an exhibition on the *Everyday Art of Japan* ("an exhibition of Japanese ingenuity and taste — stripped to the bones, so to speak. I compiled a list of more than 100 objects — none of them arty or chichi;" an intuition that would have been the right thing at the right time);<sup>19</sup> two books, one of them on the Westernization of Japan; and a comparative study of Japanese and American domestic life.<sup>20</sup>

He left Japan with the desire of going back to architectural design.<sup>21</sup> He stayed in Hawaii until September, at which point he eventually returned to New York.

17 The project was conceived years before, and bore many different titles, including *Are Houses Modern?* and Rudofsky's favorite, *Uncle Sam's Cabin*.

18 I haven't been able to identify how Rudofsky got published in *Kokusai Kentiku*.

19 Letter from Rudofsky to René D'Harnoncourt.

20 Letter from Rudofsky to Isamu Kenmochi, 24 April 1955.

21 Letters from Rudofsky to Richard Neutra, 28 April 1959; to Walter Gropius, 15 August 1959; and to Pietro Belluschi, 12 March 1960.



13.

Having returned to New York, he took up residence in the Kips Bay apartments (Ieoh Ming Pei). His application to the AIA was rejected. The Museum of Modern Art asked him "to organize a number of didactic [traveling] exhibitions, their subjects left to my discretion."<sup>22</sup> Beginning in 1961, the following projects were completed: *Japanese Vernacular Graphics, Roads, Stairs, Antoni Gaudí*, and *Architecture without Architects*. The agreed list of exhibitions also included *The Outdoor Room* and, possibly, *Streets, Arcades and Galleries*, neither of which were actually produced.<sup>23</sup> Rudofsky also presented the Museum of Modern Art with a project for a "monumental" exhibition, entitled *The Japanese Culture*.<sup>24</sup>

From 1963 to 1964, Rudofsky won a Ford Foundation Scholarship, and two Guggenheim Memorial Foundation Fellowships.<sup>25</sup> He was thus able to make a journey to Europe in the summer of 1963 to complete documentation for *Architecture without Architects*. The exhibition met with great success and was shown in 84 different locations over

*Bernard Rudofsky. Garrovillas' porticoed square, 1963.*

*Just an example — documented by two photographs, similar to this one, which were published in the book — of the extensive photographic campaigns which Rudofsky undertook to prepare Architecture without Architects.*

22 TPB, p. 366.

23 AR98.4.

24 Letter from Rudofsky to Mrs. Maki, 28 June 1961.

25 Recommendations were produced by Neutra, Tange, Ponti, Sert, and Belluschi. Rudofsky called the latter the "godfather" of *Architecture without Architects*.

a period of about twelve years. It was probably the MoMA's Department of Architecture and Design's longest running exhibition ever.

It was planned to accompany each of the shows, with the exception of *Antoni Gaudí*, with a largely photographic book.<sup>26</sup> The book-catalogue *Architecture without Architects* was originally intended as a gift to be offered to the trustees and members of the Museum, but when the general public discovered it, it sold so well that it rapidly went out of print. When the different places where the exhibition was shown also ordered quantities of copies the situation got worse. Rudofsky decided to find another publisher; the Museum of Modern Art condition was a wait of 2 years before Doubleday could take over.<sup>27</sup> *The Road as a Work of Art*, which was to have been sponsored by Standard Oil Co., never saw the light of day, perhaps because Rudofsky did not accept that Arthur Drexler be credited as co-author.

The cancellation of the exhibition *The Outdoor Room*, disagreements concerning content and approach in *Streets, Arcades and Galleries*, as well as differences over money, all contributed to the breakdown of Rudofsky's relationship with Drexler in 1967.<sup>28</sup>

Two exhibition projects were thus converted into editorial ones: *The Outdoor Room* (or *The Conditioned Outdoor Room*), which was never produced; and *Streets, Arcades and Galleries*, which became *Streets for People* (1969).

#### 14.

Between 1962 and 1964, Rudofsky designed and built a "house-garden" near Detroit for James Carmel.

During the 1960s, Rudofsky worked intensively giving lectures and teaching university courses. In 1961, he was invited to give a talk in Aspen Design Conference, which he defined as "my very first conference." He was invited by Serge Chermayeff to be Visiting Critic at the Graduate School of Architecture at Yale. He was named member of the Advisory Screening Committee on Art and Architecture for the

26 Correspondence with Carroll Bowen (Director, MIT Press), 1962-63.

27 Berta Rudofsky's written recollections, 2002.

28 It would certainly be worthwhile to make a deeper study of the intellectually stimulating but sometimes personally conflictual relationship between Rudofsky and the MoMA.

The following comments by Rudofsky date from 1958: "The liveliest workshop for experimentation, today and in the years past, is the Museum of Modern Art in New York... That museum... is in a class by itself. It gives the exhibition director complete freedom... Once you have signed the contract, every decision is yours. From there on, nobody is going to question you, to advise you, to correct you. You are responsible to yourself only. This is as it should be, and I have never seen a good exhibition done by a man who was not free to do what he wanted to do." (*An Architect Looks at Exhibition Design*, unpublished manuscript, pp. 5-6).

But especially in the 1960s, an institution such as the MoMA found it increasingly difficult to deal with Rudofsky's independent position. One gets the impression that the one was eager to exploit the other - the MoMA, Rudofsky's brilliant ideas; and Rudofsky, a prestigious springboard and the opportunity of putting on his exhibitions without having to make compromises (he seemed to have been continually putting distance between himself and the MoMA and defending his position as an author-creator with the final say in all areas).

It should be mentioned in passing that the MoMA probably did not see much difference between projects such as *Roads* and as *Architecture without Architects*. Problems between Rudofsky and the MoMA started to occur a few months after D'Harnoncourt's sudden death in August 1968. It was he who had guaranteed Rudofsky considerable freedom of action (see Rudofsky's letter to D'Harnoncourt, 4 April 1962).

U.S. Government Awards (a role he honored for 3 years). In 1962, he edited a monographic issue of *Design Quarterly*, entitled "Japan: Book Design Yesterday," and gave a series of conferences on Japan at the Walker Art Center in Minneapolis. He became a free-lance contributor to the magazine *Horizon* (and continued to be so until 1976). In 1965, he finally published the book *The Kimono Mind*, the fruit of his long familiarity with Japan. Also in 1965, he was Visiting Professor of Art at Yale, perhaps with a five-year tenure. While at Yale, he suggested innovations in teaching methods and structures, amongst them the creation of a Center for Environmental Studies. The project was never undertaken, perhaps due to the death of its sponsor.<sup>29</sup> He left Yale after only one year. In 1966, he was one of the speakers at the 15<sup>th</sup> Annual Northwest Regional Conference of the AIA, held in Seattle. He spent some months of every year in the Old World. During the summer of 1969, he found in Andalusia what he had been looking for many years: the ideal site on which to build a house for himself and his wife.

See Proposal for a Center for Environmental Studies, p. 231 ff.

29 Letter from Rudofsky to Yehudi Menuhin, 15 December 1972.



*Antonio Niego. Bernard Rudofsky photographing the sandaled foot of the polychrome marble statue of the muse Citharoeda in Naples's National Archaeological Museum, 1983.*





Alex Gotfryd. Bernard Rudofsky as he appears on *Now I Lay Me Down to Eat* jacket, ca. 1980.

15.

The house was built in 1970–71. He went there every summer, using it as a retreat for his work and as a base for his trips in Europe. It was the last house Rudofsky built.

In 1971, he published the book *The Unfashionable Human Body*, in which he revisited the themes of *Are Clothes Modern?* In the same year, he received his third Guggenheim Memorial Foundation Fellowship. Encouraged by the success of the eponymous book, he attempted to put on *Streets for People* as an exhibition at the Whitney Museum of American Art.

In the fall of 1972, Yehudi Menuhin, one of the trustees of the Edward James Foundation, asked Rudofsky to set up a new school of architecture at West Dean College near Chichester, England. This gave him the opportunity to revisit the ideas he had been working on at Yale a few years earlier. In April 1973, he left his house in New York to go and live in London.<sup>30</sup>

However, his first course, set for 1974, was cancelled, as not enough students enrolled.

During the winter of 1974 he went to Copenhagen where, in 1975, he was Guest Professor of Architecture at the Royal Academy of Fine Arts.<sup>31</sup>

He spent winter 1975–76 in the Canaries, after which, he returned to the United States after an absence of almost three years.

By the end of 1975, 50,000 copies of *Architecture without Architects* had been sold in the United States alone. (*The Unfashionable Human Body* had sold 8,000 copies, *The Kimono Mind* 16,700, and *Streets for People* 22,000). A further 15,000 copies of *Architecture without Architects* had been sold in the United Kingdom. (By 1985, 100,000 copies had been sold just in the United States).

16.

In 1976, Rudofsky began working with Michael Blackwood on a documentary about traditional Spanish architecture. The project was abandoned in 1978, just before filming was set to begin.

In 1977, he published *The Prodigious Builders*, in which he gave detailed arguments in support of the ideas he had presented in *Architecture without Architects*. During the summer, he went to Vienna for the first time since the War. The Technische Universität, where he had been a student, awarded him the Prechtl-Medaille. In 1978, he was a member of the Advisory Board of the Japanese journal *Process Architecture*. In 1979, he received the AIA Medal for the Visual Arts. He continued to give lots of lectures. In 1980, he was speaker at the Aspen IDCA "Form and Purpose" conference, directed by Moshe Safdie.

The first outlines of an unpublished book on profane architecture, especially castles, between the 10<sup>th</sup> and 14<sup>th</sup> centuries — provisional titles: *Vintage Architecture*, *Private Reserve*, and *The Missing Link* —, date from 1978. The book was to have had the same layout as *Architecture without Architects*, *Roads*, and *Stairs*, with numerous photographs and little text.<sup>32</sup> The National Endowment for the Arts (two Research Grants in 1978 and 1982; two Senior Fellowships in 1983 and 1984) enabled him to conduct fresh research into one of his

30 Letter from Rudofsky to Richard White, 22 April 1973: "I am leaving the [USA] and if I come back it will be as a tourist only."

31 Dean Tobias Faber's invitation was relayed by Kyeholm.

32 Bernard Rudofsky, Manuscript of an *Outline for a Book on Architecture in the Form of a Letter to an Unknown Editor*, ca. 1978 (?).

favorite themes: the foot and footwear. The book resulting from this research, which was to have been entitled *Pieds Nus, Pieds Chaussés*, was never completed.

From 1979 to 1981, Rudofsky was Smithsonian Scholar in Residence at the Cooper-Hewitt Museum in New York. In 1980, aided and abetted by the enthusiasm of the Museum's director, Lisa Taylor, he organized the exhibition *Now I Lay Me Down to Eat* and published the book of the same name.

In 1984, he began his collaboration with the journal *Interior Design*, to which he contributed short articles accompanied by photographs taken on his travels. On his death, only seven of the thirty articles he had proposed to the magazine had been published.

In 1985, he traveled to India to take part in *Golden Eye*, a craftsmanship development program.

In 1986, he was awarded the Vienna Architecture Prize; the encomium was delivered by Hans Hollein. The following winter, he stayed in Vienna, where, on the invitation of Peter Noever, the director of the MAK, he organized *Sparta/Sybaris*. The exhibition opened in October 1987. The eponymous book — Rudofsky's only one in German — was published at the same time.

Bernard Rudofsky died in New York on March 12, 1988.

#### Some of the architects belonging to the same generation as Rudofsky:

- 1900 Chormayeff, Fathy
- 1901 Kahn, Sartoris, Sert, Wachsmann
- 1902 Barragán, Breuer, Costa, Jacobsen, Lapidus, Stone
- 1903 Backström, Figini, Gruen, Libera, Owings (SOM), Plischke, Pollini
- 1904 Goff, Ridolfi, Terragni, van der Laan
- 1905 Albini, Cosenza, Gardella, Maekawa, Mollino, O'Gorman, Rudofsky, Speer
- 1906 Johnson, Scarpa
- 1907 Bill, Eames, Munari, Niemeyer, Segal
- 1908 Nelson, Peressutti (BBPR)
- 1909 Belgiojoso (BBPR), Burle Marx, Reidy, Rogers (BBPR)
- 1910 Banfi (BBPR), Candela, Prouvé, Rainer, Saarinen

# Map of Rudofsky's Personal and Professional Contacts



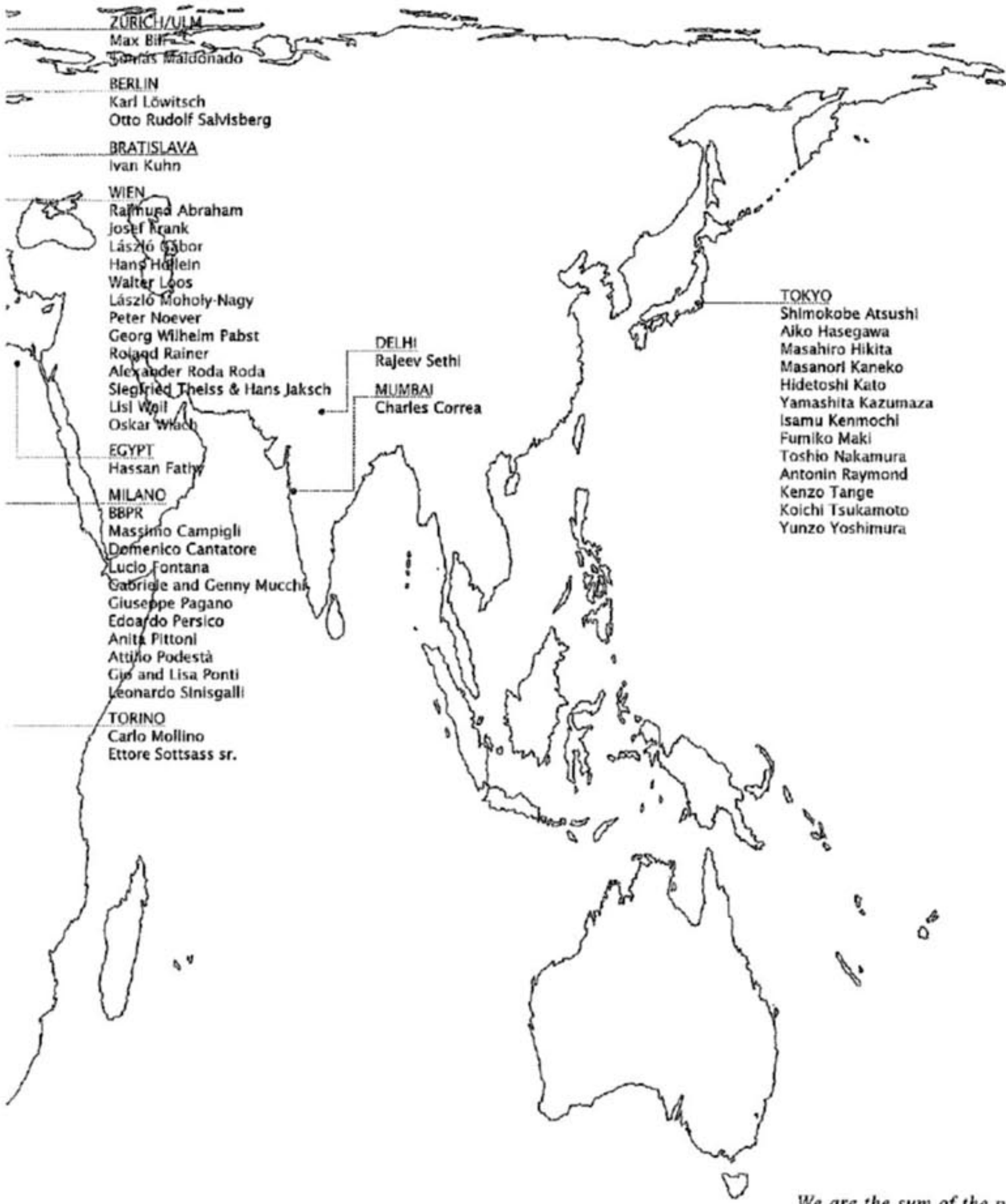

*We are the sum of the people we meet. The people we love, those who have brought something to us, who have appreciated us, from whom we have learned, with whom we have shared ideas, and with whom we have spent time. It would be vain and inappropriate, in this book, to attempt to describe the nature of the relations Rudofsky had with all the people he met, or to include an anecdotal or chronological reconstruction of them.*



*Bernard Rudofsky (?). The play of terraces on different levels at Oro house, with Berta Rudofsky and Maria Teresa Cosenza, 1937. In the foreground, the dining terrace with the protruding master bedroom on top; behind, the living room's roof serves as terrace for the child's bedroom.*

*The formal results achieved at the Oro house are close to the aesthetics of the purist, rationalist avant-garde. Unlike other Rudofsky designs, this one seems to stress how the white walls create a pure play of volumes in the stark sunlight.*

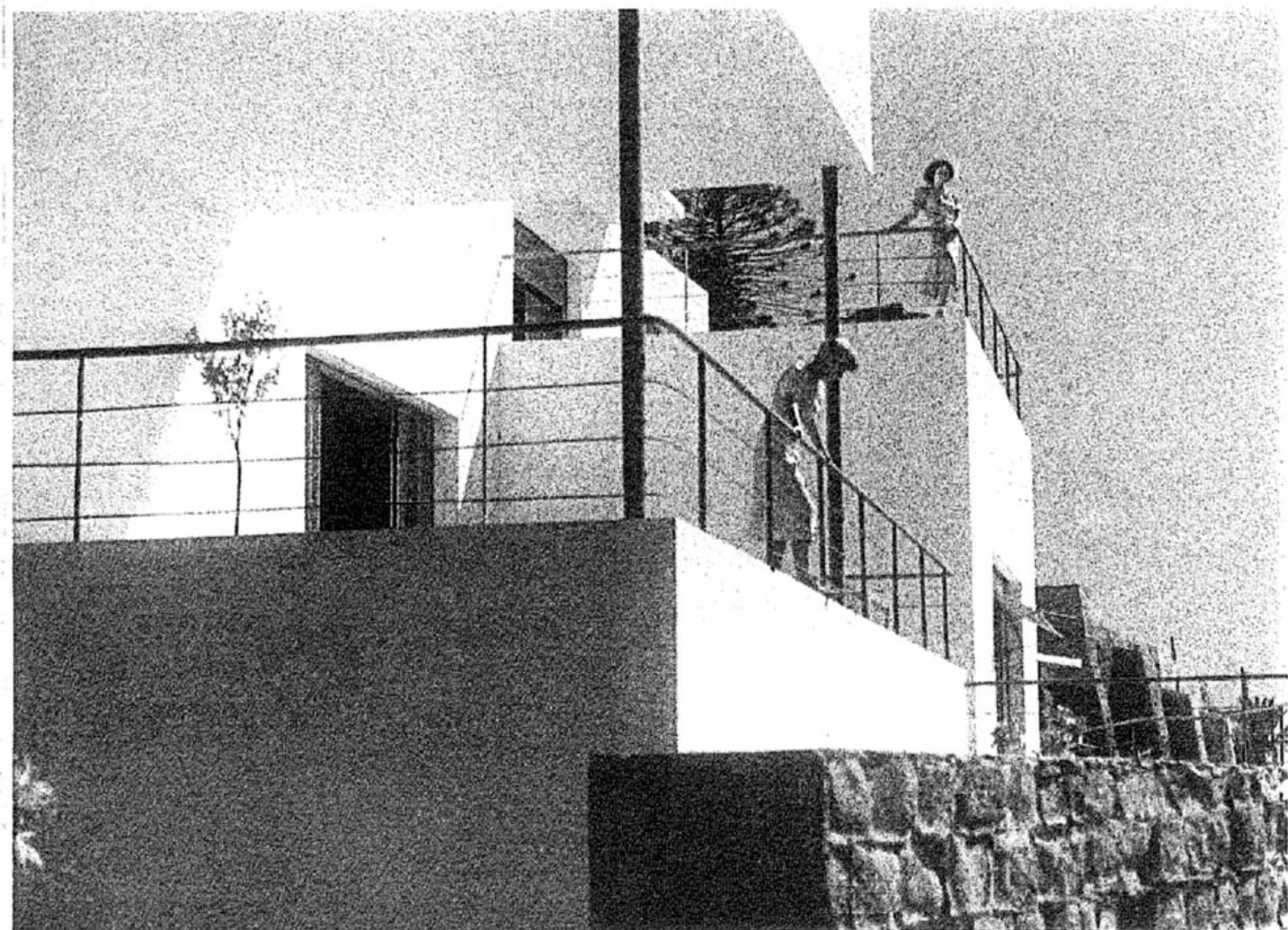

The greater part of Rudofsky's explorations in the field of architectural design is devoted to residential buildings. Like Loos, Schindler, and Neutra, he was primarily active as an "architect of villas."

This does not come about entirely by chance. Citing Palladio, Rudofsky insists upon the central role of the dwelling, from which every other type of architecture is descended. In this, he is certainly not alone: for many modern architects, including Frank Lloyd Wright, the single-family house seems to be the quintessential architectural theme.

Not only does Rudofsky design buildings on a limited scale; his professional output is restricted in quantitative terms, and his career as an architect ends early. It is perhaps for these reasons that his work has remained little-known, despite having enjoyed, in its day, favorable reviews and notable visibility: in the thirties, the magazine *Casabella* published six of his works, as well as an article by him about the Ministry of Education in Rio;<sup>2</sup> during the second World War, he appeared three times in *The Architectural Review*.<sup>3</sup>

The houses he built in Brazil were widely published and celebrated. One reads of them: "Call it a house, pavilion, or pleasure dome of Xanadu, the Arnstein family has as lovely a place to live in as could be found in the Americas. It is a splendid house... [T]here is no such homogenous and successful example of the modern house-garden in the Americas... During three years of architectural work in Brazil, Rudofsky built some houses which were considered the best on the American continent."<sup>4</sup> Sacheverell Sitwell wrote that, during the

## **On the Architectural Oeuvre (A Natural Philosophy of Architecture)<sup>1</sup>**

See Catalogue no. 30 (p. 277) and no. 32 (p. 279)

1 AR97.1, p. 34.

2 AR36.1, AR37.2, AR39, BR39.1. Rudofsky's works appeared also in AR34.2 and AR35.4.

3 AR40.1, AR40.3, BR41.2. I am not able to tell whether this happened thanks to Jim Richards, nor to ascertain how did Rudofsky's Oro house happen to appear in the limited selection of contemporary Italian works presented in the monographic article in *The Architectural Review*.

4 AR43.1.

architect's stay in Brazil, "Bernard Rudofsky built a pair of private houses that in their way are among the greatest successes of the whole modern movement. [T]he temple gardens of Daisen-In and Ryuanji in Kyoto... are among the greatest aesthetic masterpieces of Japan, while [the Arnstein and Frontini gardens] are the best modern architecture of our time." In the exhibition *Brazil Builds* and its catalogue (1943), not much less space was devoted to Rudofsky's buildings as to those of Niemeyer; in the lengthy article that *The Architectural Review* devoted to Italian architecture in 1940, the Oro house is set beside the work of Albini. In the early forties, Rudofsky stood a good chance of becoming one of the twentieth century's famous architects.

See Catalogue no. 17 (p. 264)

*Bernard Rudofsky. Preliminary perspective sketch of Oro house, 1935 (?)*

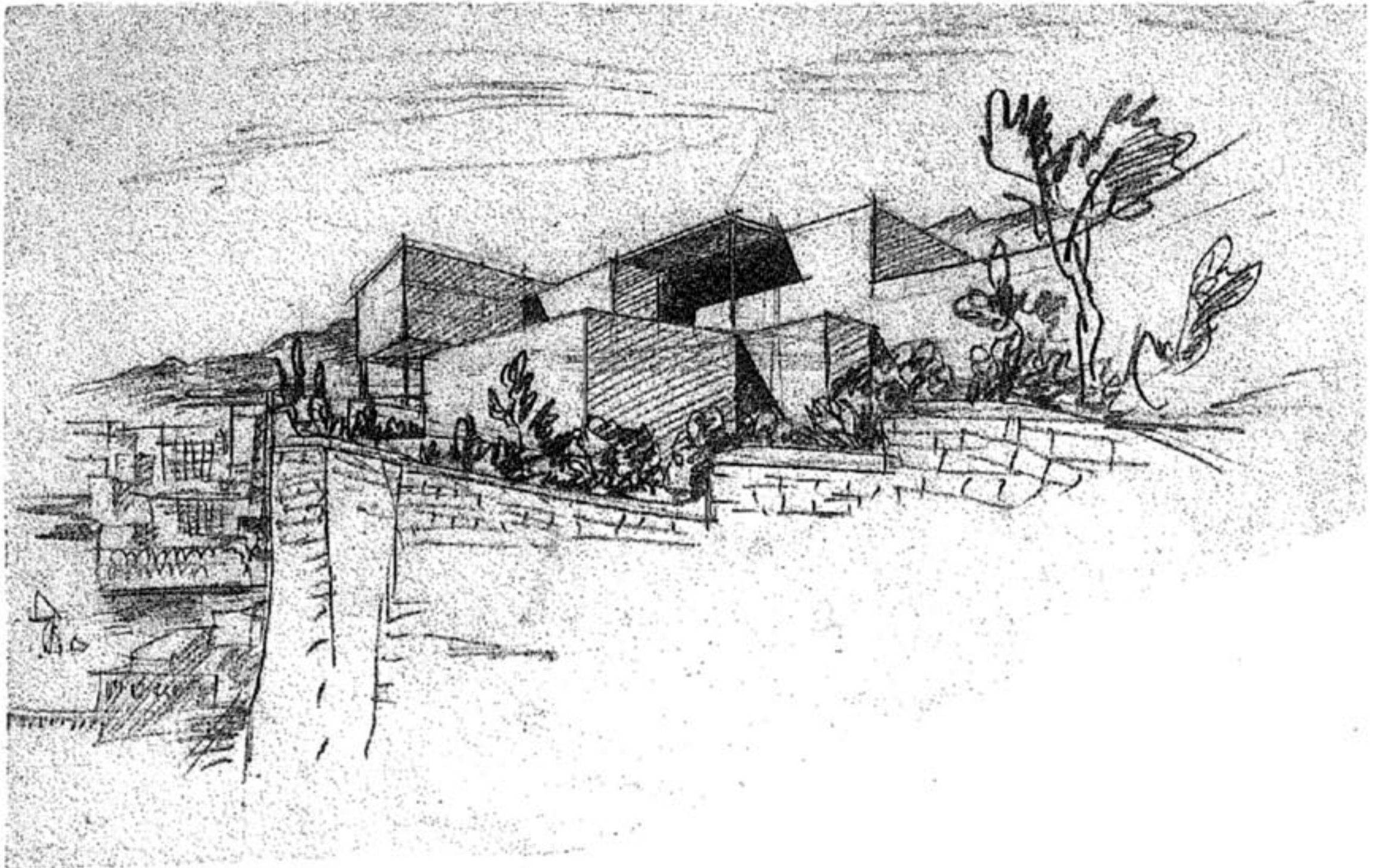

Page 254 ff.

My catalogue contains a description of the works known to me, whether or not they were actually built.

In this chapter, we shall analyze some of the recurrent design themes which run through Rudofsky's architectural output.

*Peter C. Scheier. House for Dr. Virgilio Frontini, seen from northern (front) garden, ca. 1941-42.*

*The wing to the left contains the playroom / living room (first floor) and the dressing rooms and one bedroom (second floor); the one to the right, the study and the master bedroom.*

*In their time the Frontini house and the Arnstein house, both in São Paulo, Brazil, were probably the most celebrated of Rudofsky's buildings.*

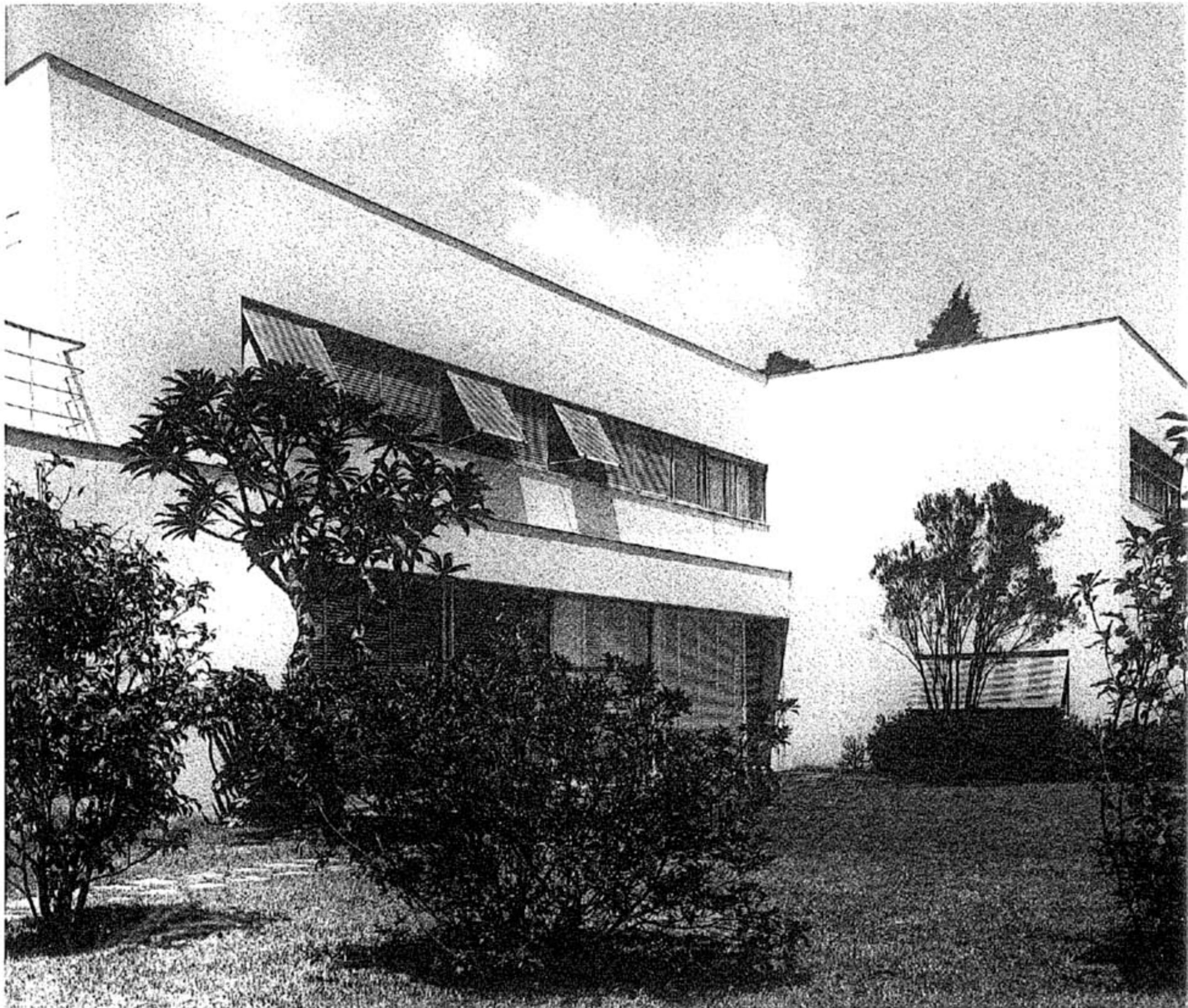

## Table of Correspondences

This table relates some of Rudofsky's architectural works to earlier buildings that may have formed part of the world of formal references within which he can be placed.<sup>5</sup> In most instances, Rudofsky's knowledge of the works cited is documented; in any event, these are all works which he very probably knew, either directly or through publications.

The table's purpose is to suggest a contextualization of his works with regard to a cultural and creative environment, without, however, implying any copying on his part.

5 Henri Focillon, *Vie des formes suivi de Eloge de la main*, Paris: PUF, 1943.

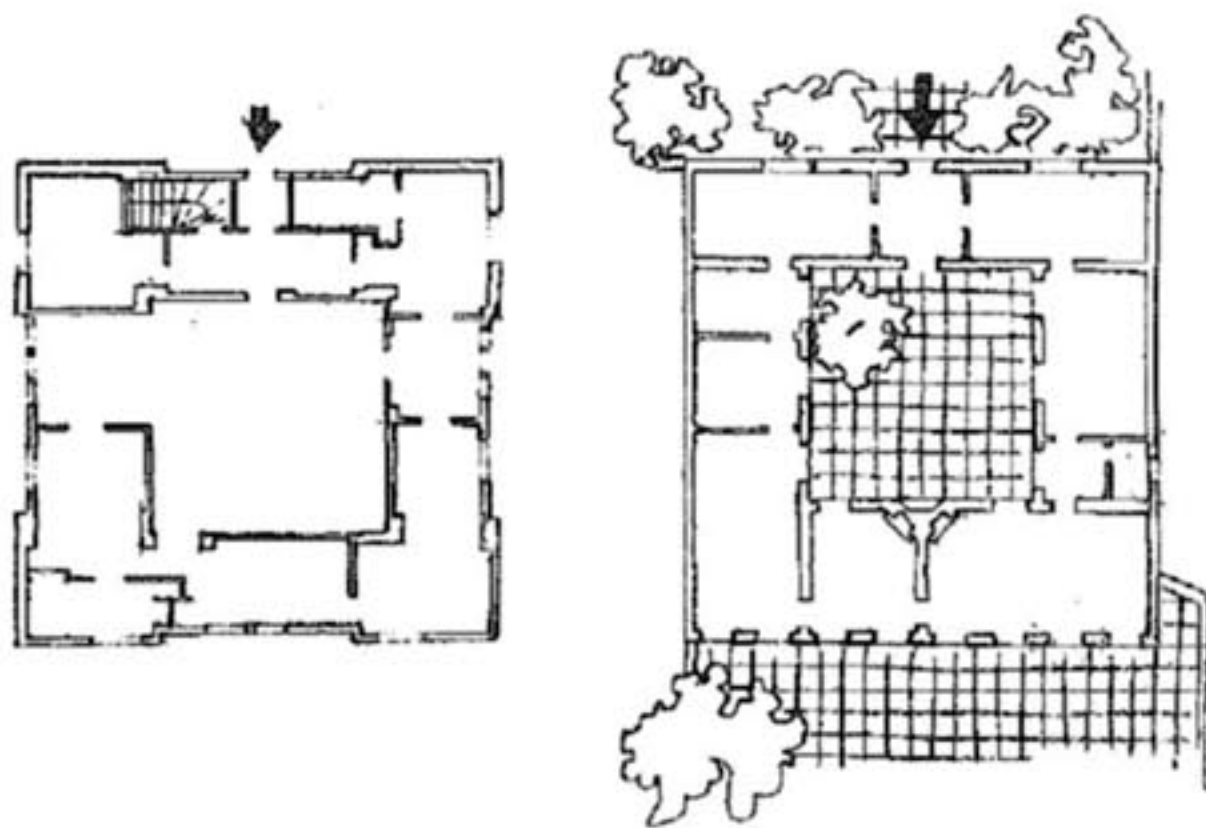

*Ground plan of the house am Horn at Weimar, by G. Mucbe and W. Gropius (1923) / Ground plan of B. house in Capri by Rudofsky (1932-33).*

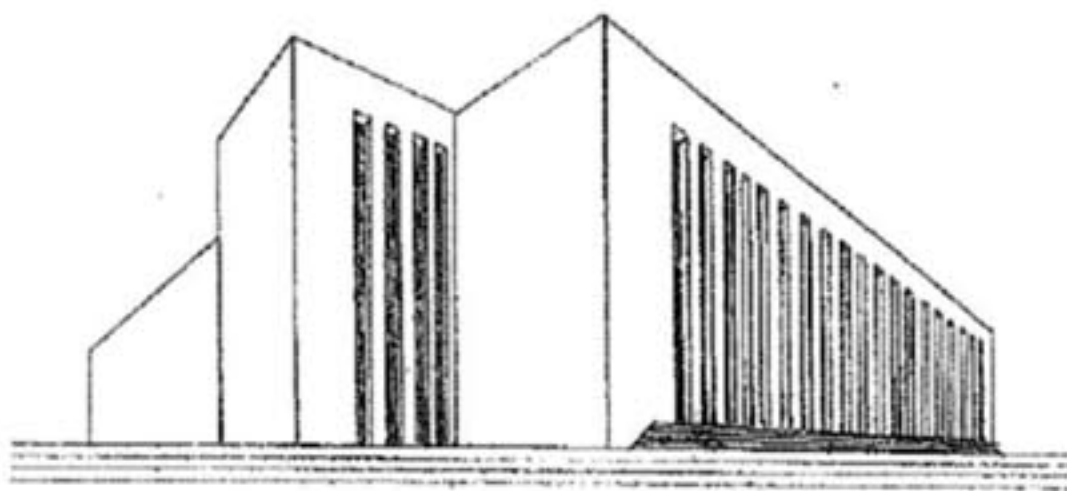

*Façade of a design for an auditorium by J. Hoffmann (1922) / Perspective view of the Palazzo del Littorio along the Via dell'Impero in Rome, looking towards the Colosseum (design by L. Cosenza and B. Rudofsky) (1934)*

*The ground plans in the two designs are quite different, but share a similar appearance of modernist monumentality in the main façade.*

*The composition of Rudofsky's drawing displays a visual culture reminiscent of the panels painted with perspective views on an "ideal city," now in Urbino and Baltimore.*

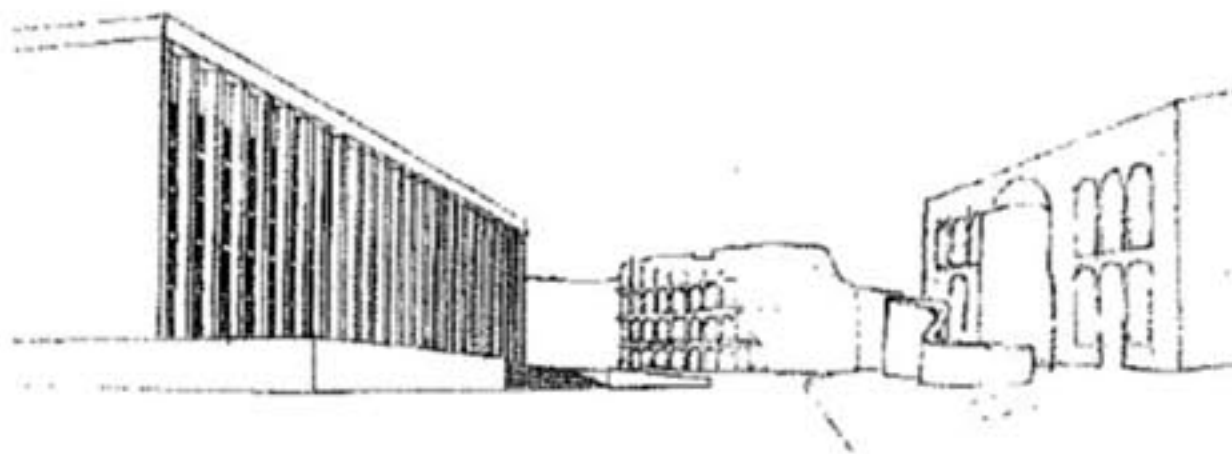

*Plan of the Society of Nations by Le Corbusier (1927) / Plan of the Auditorium 5 m above ground level (design by L. Cosenza and B. Rudofsky) (1934)*

*The piers that make it possible to pass beneath the auditorium are closer to Le Corbusier than the plan itself.*

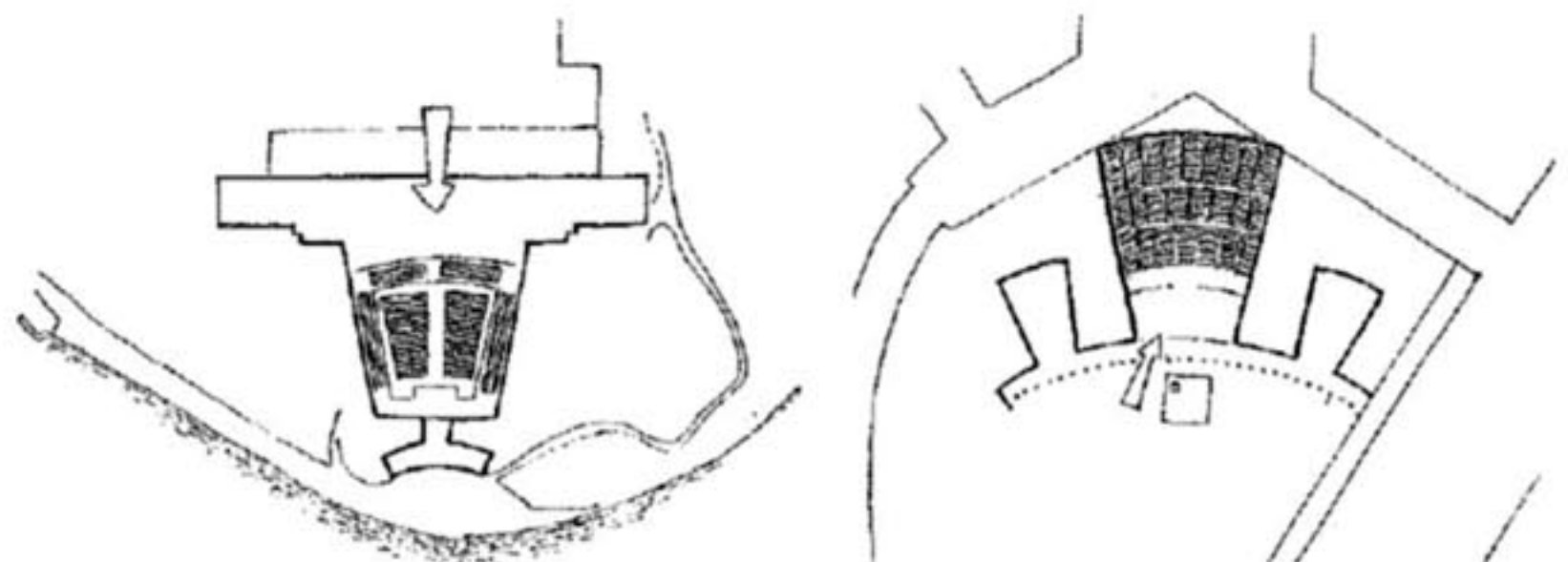

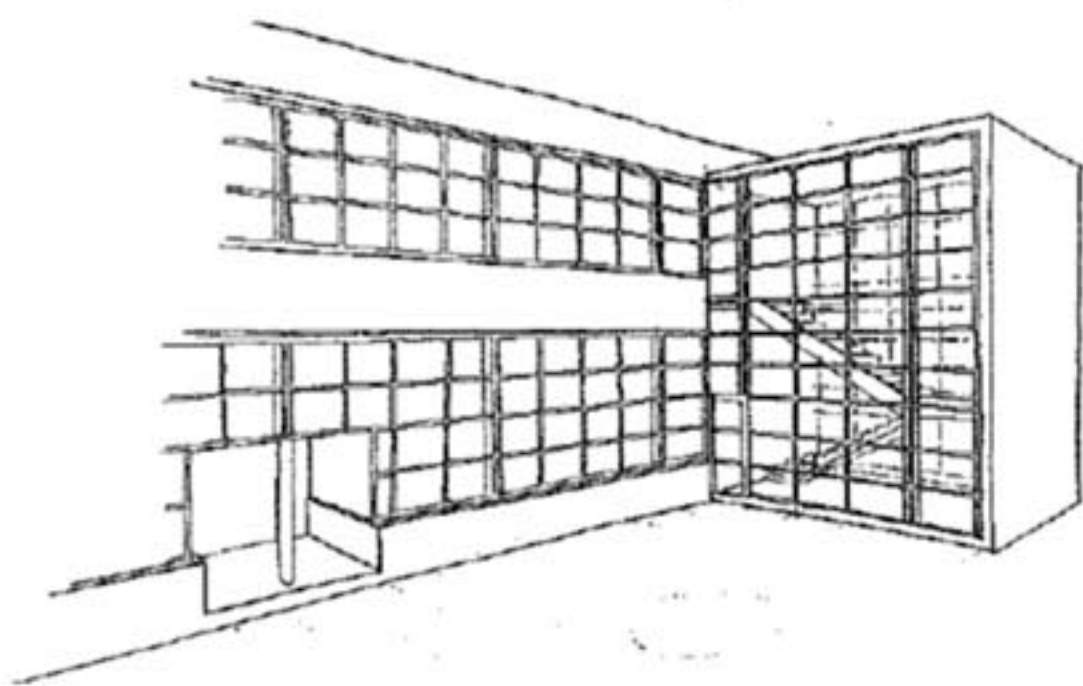

*Arbeitsamt Leising by E. A. Plischke (1930–31) / South front of the Naples Tennis Club (design by L. Cosenza and B. Rudofsky) (1935)*

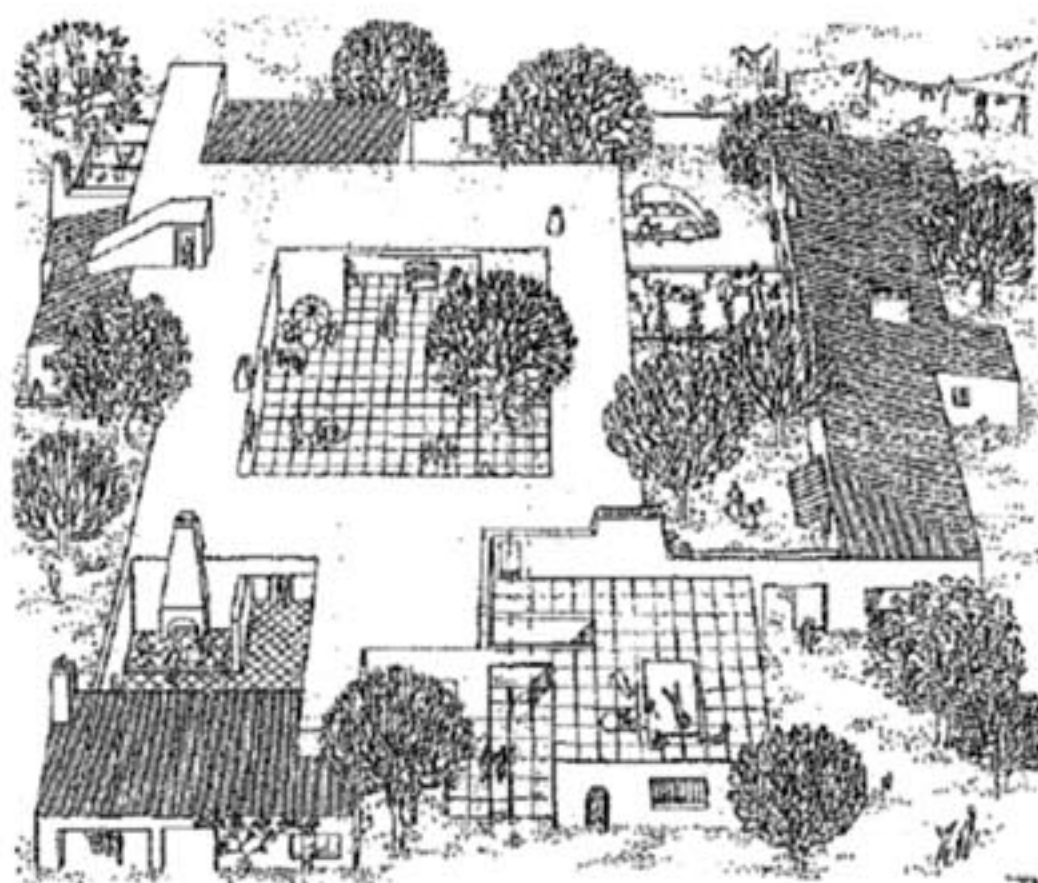
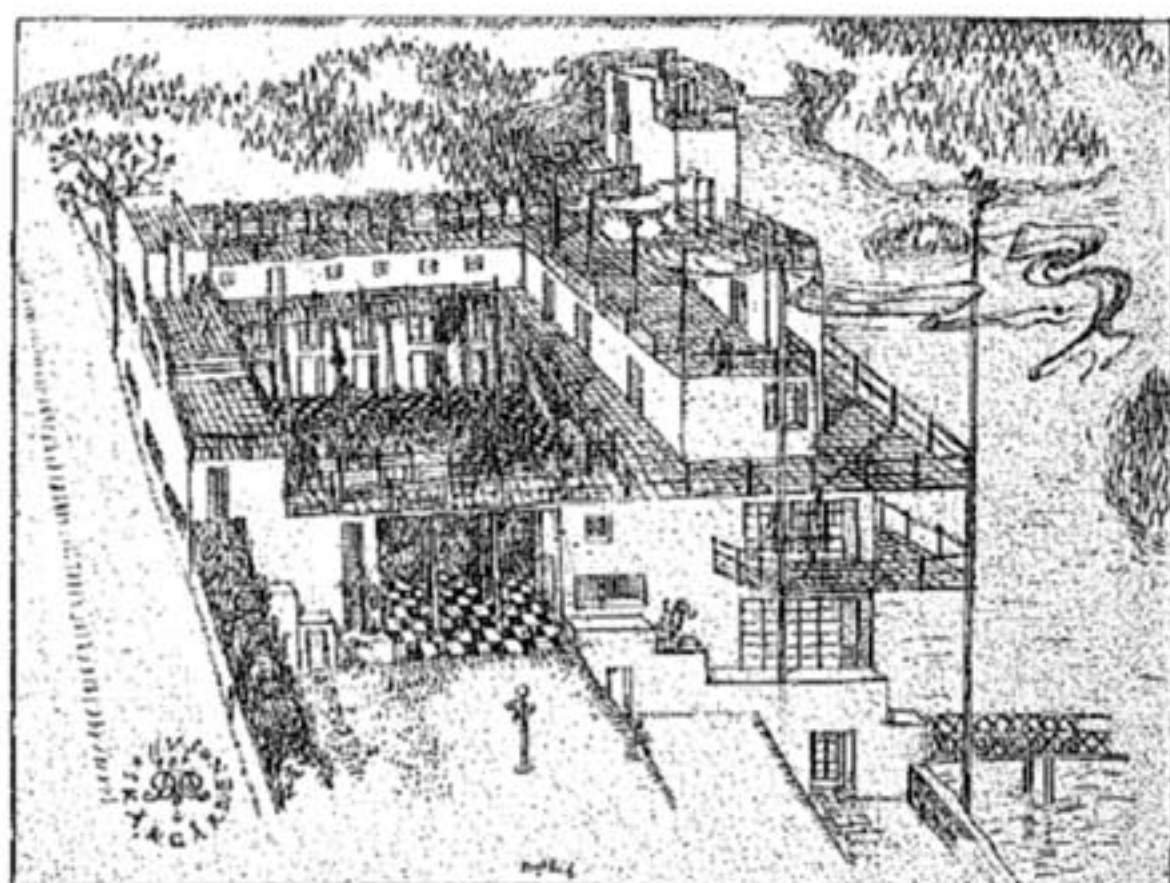

*Josef Frank. Ideal project for a courtyard house for Dagmar Grill in Skärgården, 1927 / Bernard Rudofsky. Imaginary house for Casa & Jardim brochure, 1938 (?).*

*If not among Rudofsky's sources, Frank's ideal project for Skärgården is, at the least, one of his points of reference; a large reproduction of it was to be found among his papers. In both houses, one may note a wide range of open-air rooms, but also a variety in the plans; both houses teem with life.*

*Haus Wenhold, near Bremen, by E. Fahrenkamp (1929): garden elevation / Oro house (by B. Rudofsky and L. Cosenza) (1935): garden elevation.*

*The spread of cultural innovations, like that of material goods, is neither immediate nor isotropic. In the Naples area the Oro house constitutes, in the mid-thirties, the first fully realized project in the rationalist style, felicitously cross-bred with elements from the local vernacular: a style that had constituted a common expressive language of the Northern European avant-garde for at least a decade.*

*The Wenhold house looks like a compact Oro house, not yet "set in motion."*

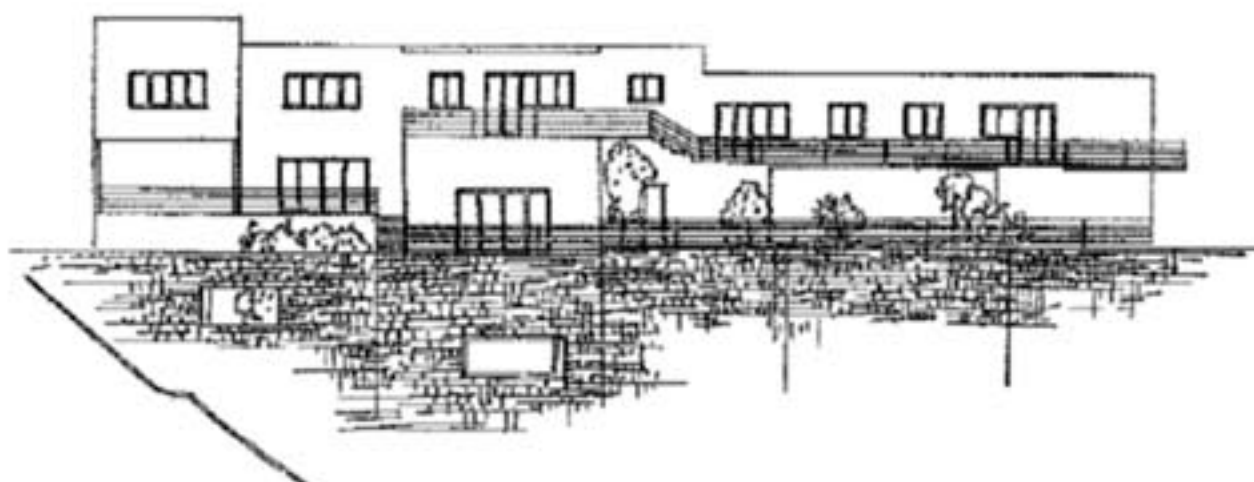
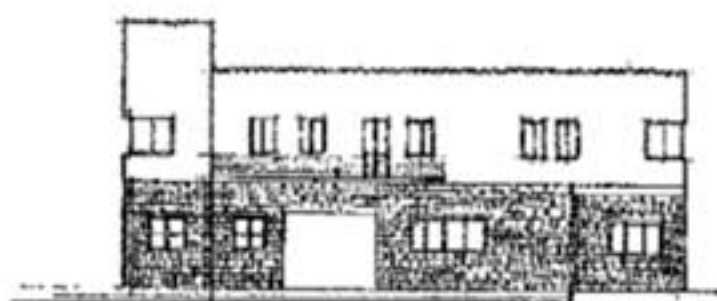

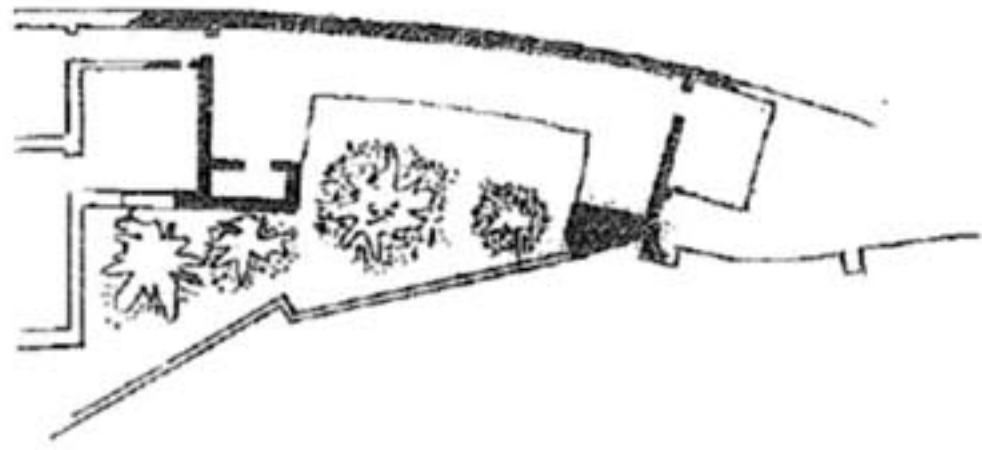
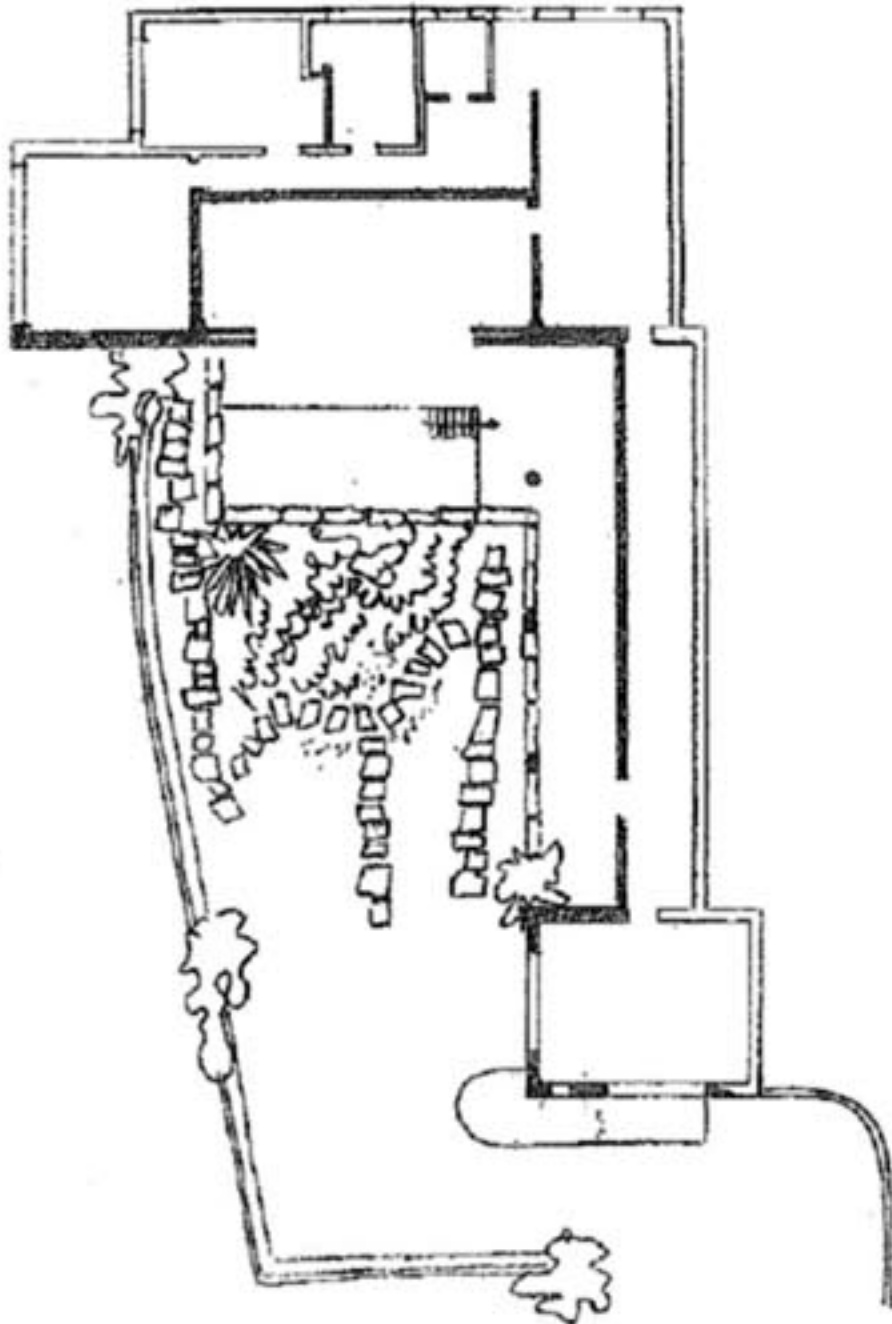

"Open room" in the Salvisberg II house in Zürich (1929) by O. R. Salvisberg / Room opening onto the garden in Oro house (by B. Rudofsky and L. Cosenza) (1935)

Both buildings are equipped with a summer living room, opening onto the garden like a broad portico.

In the Salvisberg II house — probably on account of the climate — the room, while having a floor uniform with that outdoors, can be closed by a sliding glass door that, when open, is accommodated within the walls; in the Oro house, the room cannot be closed off and, in fact, the projection of the upper floor runs through two flowerbeds.

In the Frontini house in São Paulo, Rudofsky will take up the theme of a living room opening completely onto the garden by means of a large sliding glass door.

Pavilion for L'Esprit Nouveau, by Le Corbusier (1925) / Villa Campanella (design by B. Rudofsky and L. Cosenza) (1936)

In both model buildings, the roof is pierced by a tree that passes through it. While the Esprit Nouveau pavilion was conditioned by the pre-existence of a tree that could not be cut down, in the Villa Campanella — which stands on a reef unsuitable for cultivation — the trees are the fruit of a symbolic intent.

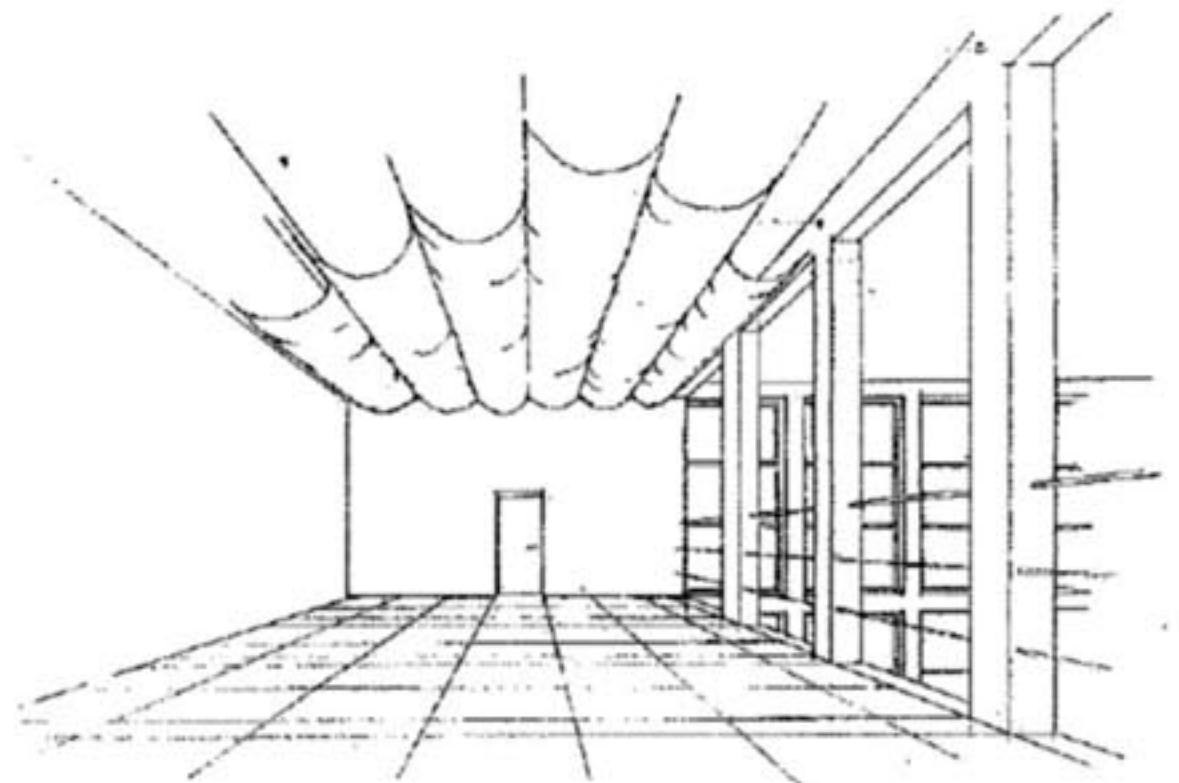
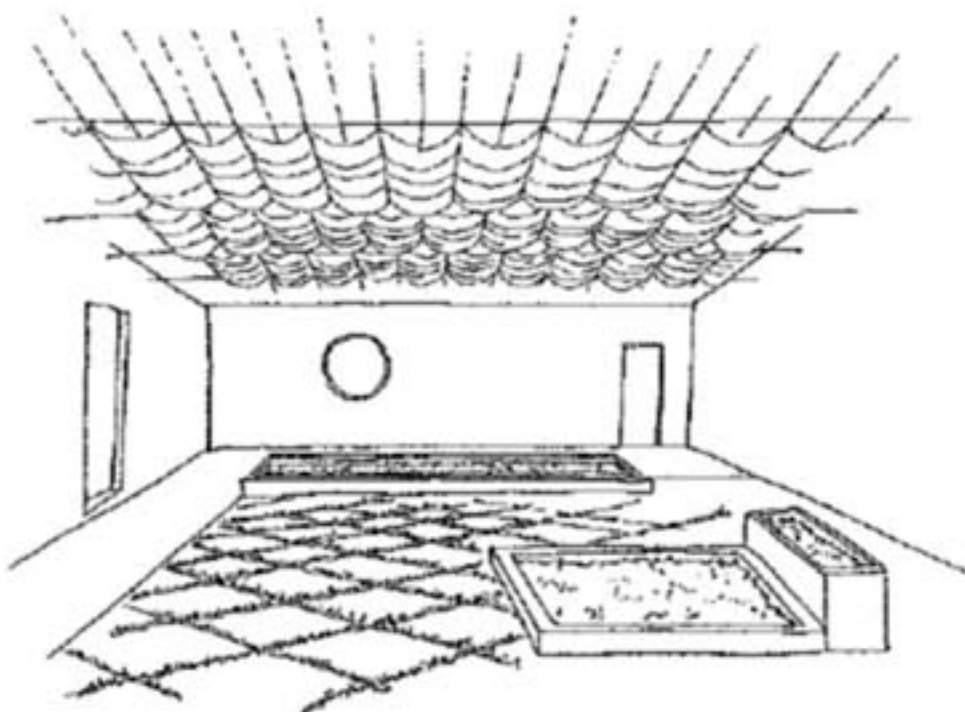
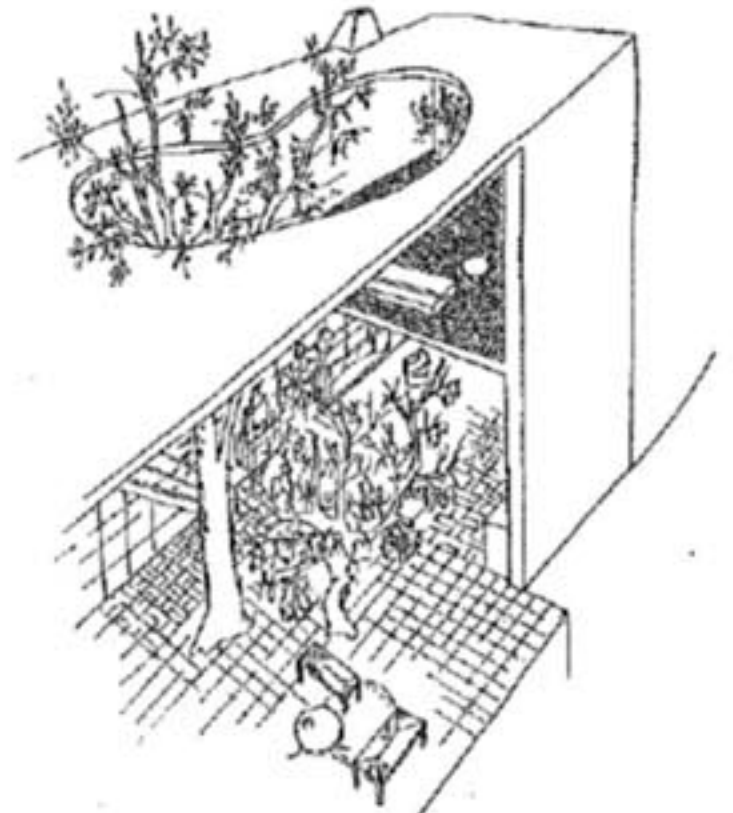

Casa Laporte roof garden, by G. Ponti (1935) / Second-floor solarium of Frontini house by Rudofsky (1940). Both top-floor outdoor rooms feature an awning similar to those of liners.

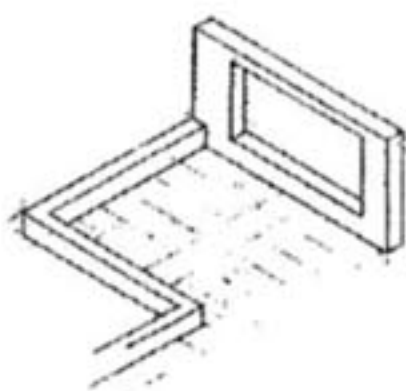
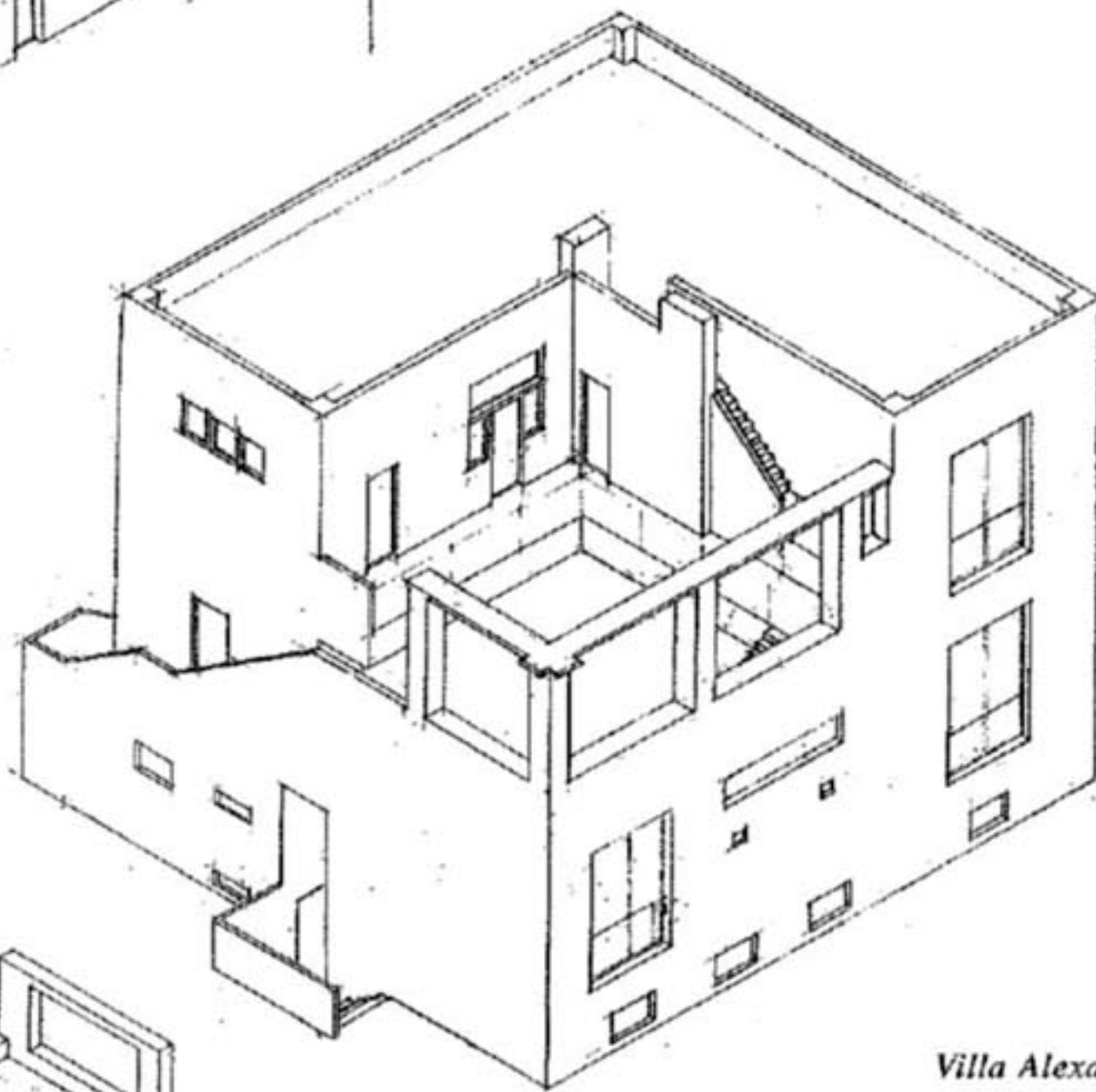
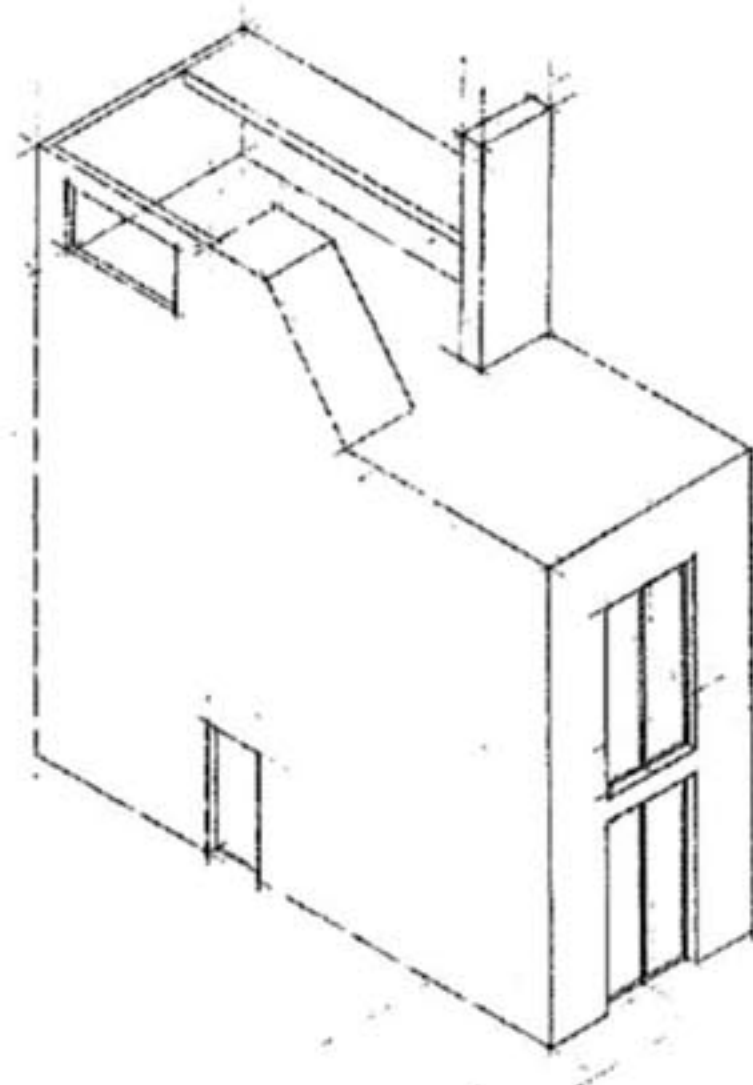
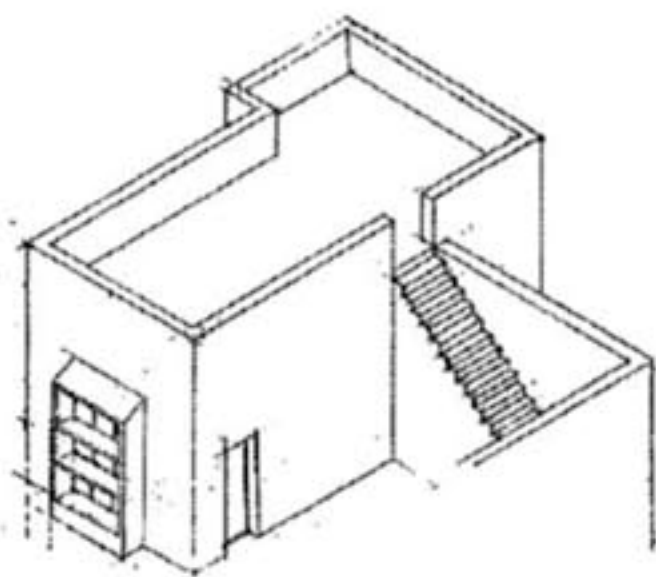

*Villa Alexander Moissi, Lido, Venezia, by Adolf Loos (1923) / Elements from diverse designs by Rudofsky (clockwise from upper left: house in Berkshire, Marsicano house, alberghetto at Positano)*

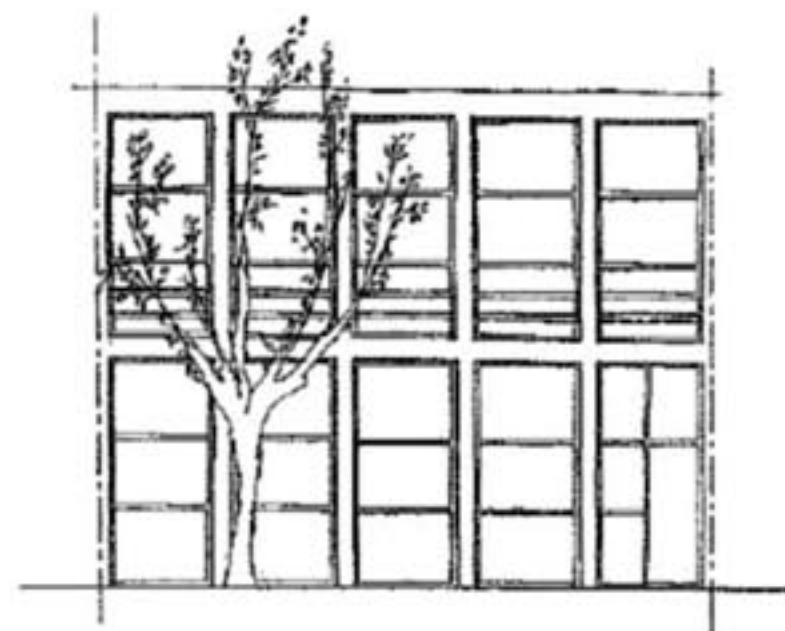
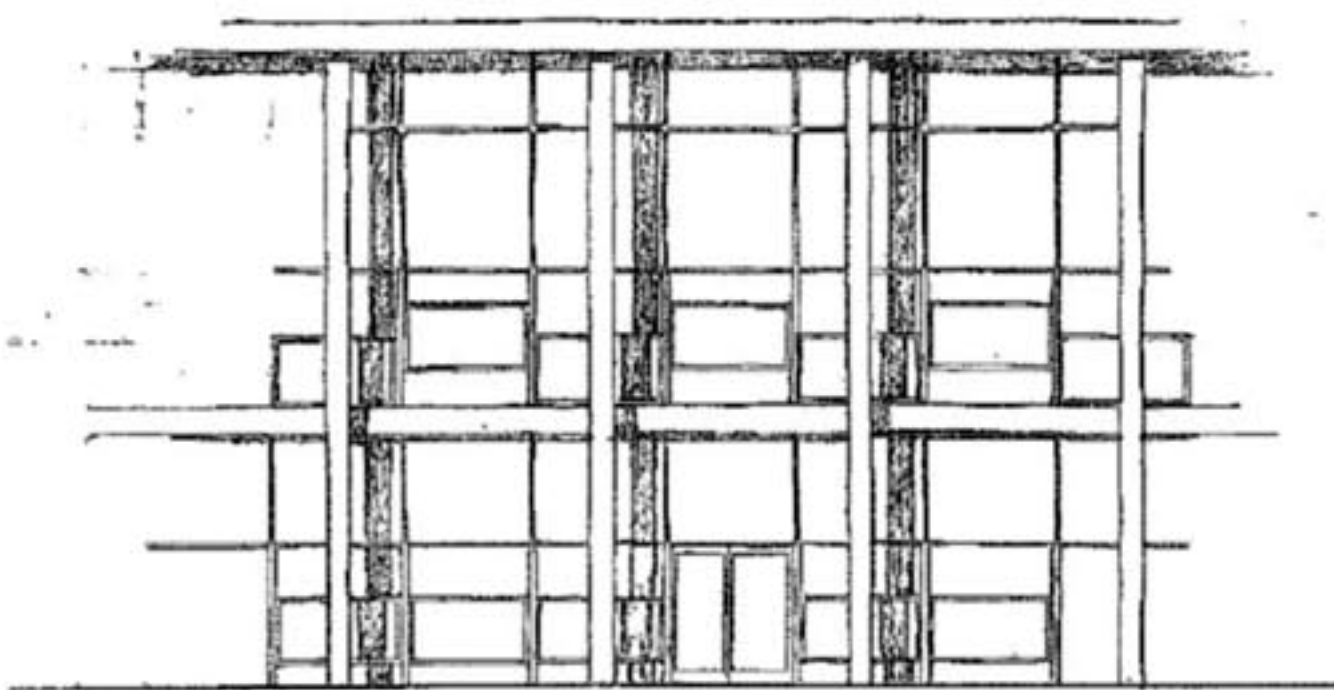

*Brazilian Pavilion by Costa and Niemeyer at the New York World's Fair (1939) / Courtyard of Frontini house (1940). In Costa and Niemeyer's pavilion, the glass walls are set a little ways back the reinforced concrete structure, while in Rudofsky's Frontini house the large plates of limpid glass are positioned between the pillars themselves. In both examples, a simplified, albeit monumental, structural rhythm is evident.*



*Unknown photographer. Mädchenschule des Kreuzschwestern (Girls' School of the Sisters of the Holy Cross) in Linz a.d.D. by Clemens Holzmeister (ca. 1928). Side view with kindergarten.*

*Like that of many other architects of his generation, Holzmeister's "rationalism" was the result of visual simplification and stripping-down of a professionally consolidated building layout.*

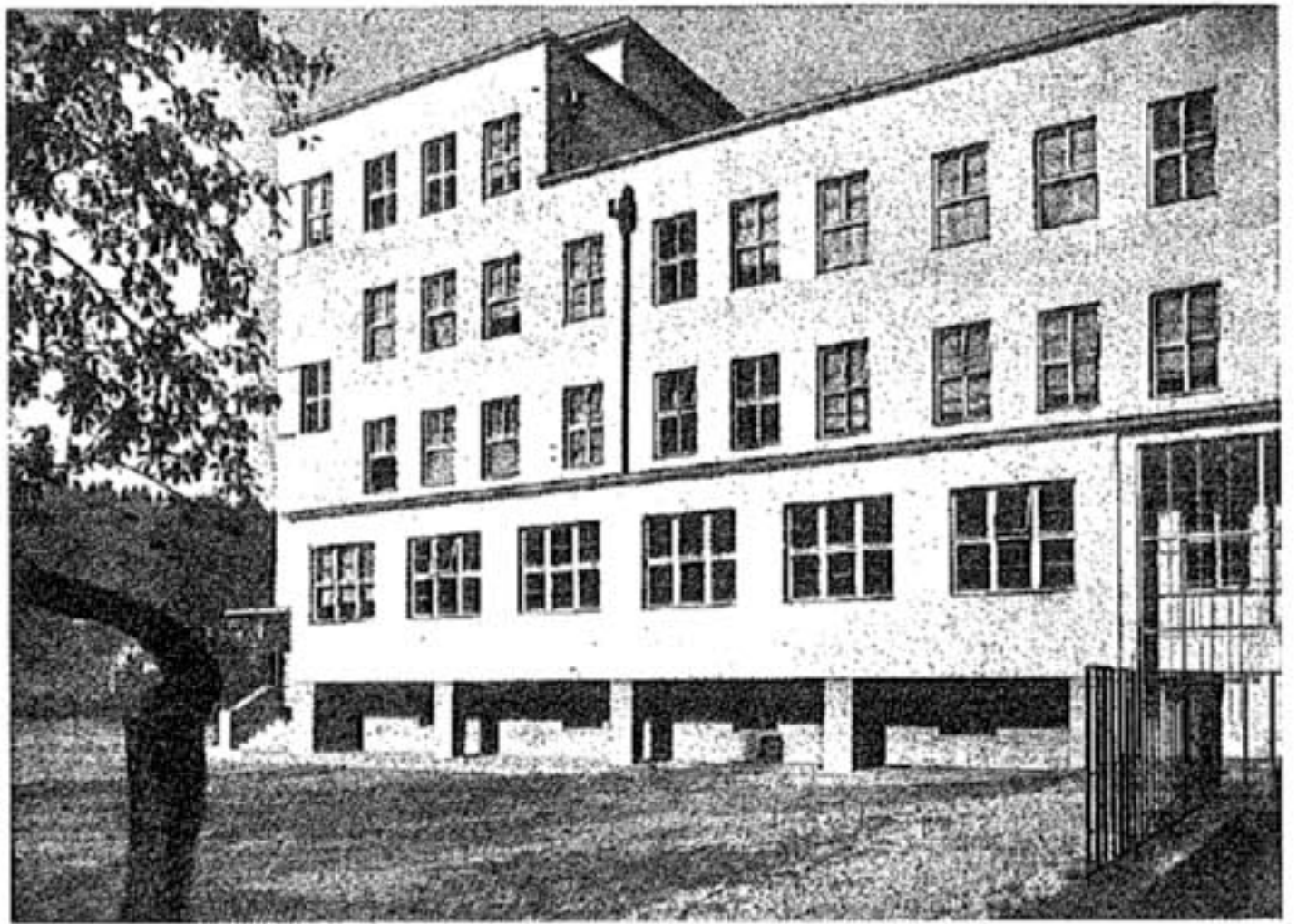

*Charlton House in Berlin-Dahlem (1929), by Otto Rudolf Salvisberg. View from the garden. In Rudofsky's work it is possible to trace elements — both constructive and compositional — already present in that of the architects under whom he had served his professional apprenticeship, such as protruding windows, "wagnerian" windows without labels, protruding rooms (cantilevered or not), winter gardens, porches open to the garden, sliding glass walls, helicoidal staircases, etc.*



*Bruno Reiffenstein. View from the Wenzgasse of Hietzing Mädchenrealgymnasium (completed 1931), by Siegfried Theiß & Hans Jaksch with the collaboration of B. Rudofsky and W. Fabian, 1931 (?).*

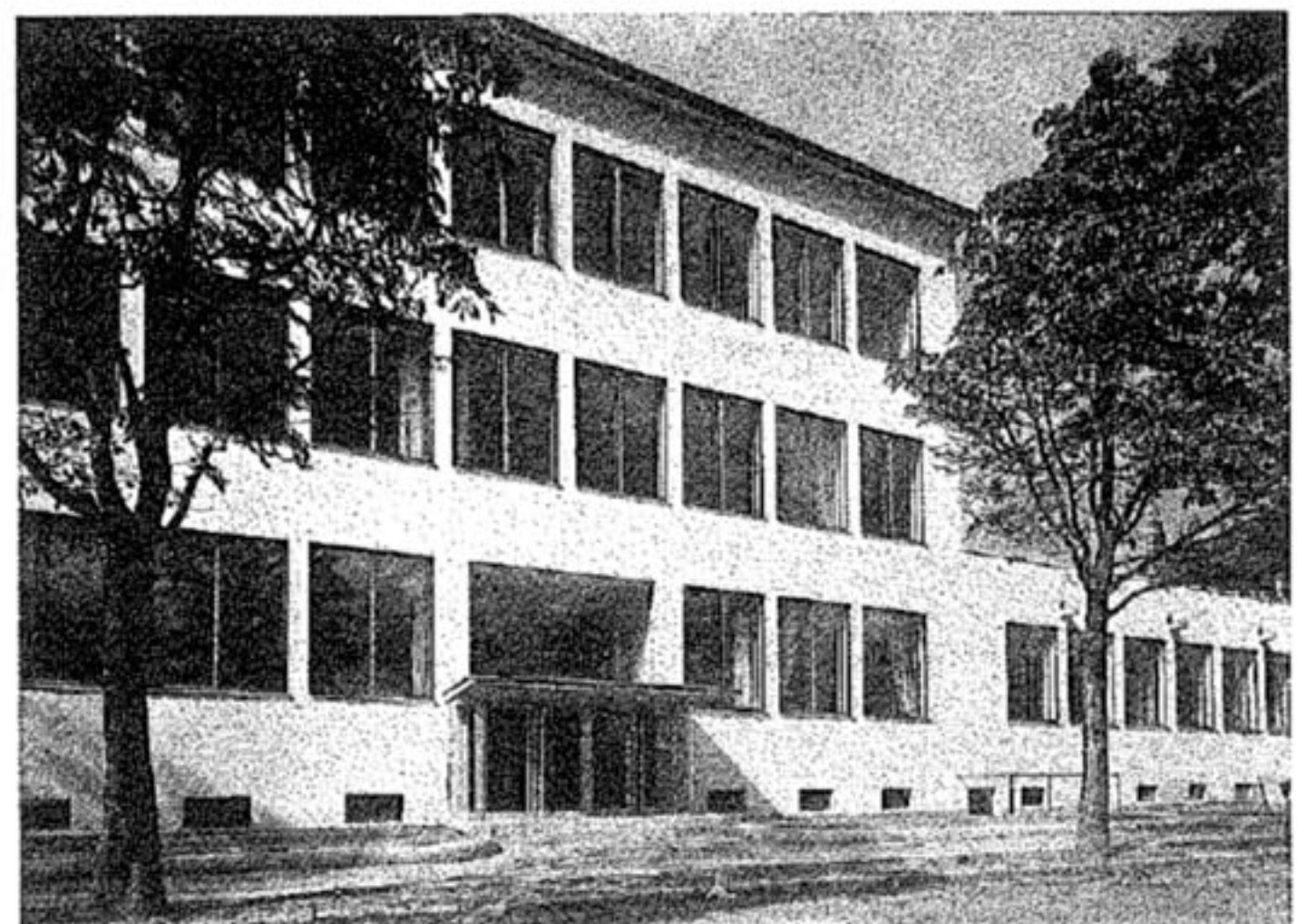

The works of Theiß & Jaksch on which Rudofsky collaborated, but also the plans he drew up with Cosenza for participation in competitions, can be related to the work of the architects of an "other modernism" (Salvisberg, Holzmeister); architects who, belonging to an earlier generation, had not played a pioneering role in modern architecture, but who had nonetheless opted, decisively and at a high level of quality, for the new way of building, giving it currency in the German context at the end of the twenties.<sup>6</sup> Theirs was a professional approach to modernism, one that did not cry out for attention, since it did not belong to an avant-garde infatuated with the myth of technology. Buildings such as the Oro house and the Naples Tennis Club can be more properly related to the aesthetics of the purist, rationalist avant-garde. In the collaborations with Ponti, and then in the Brazilian works, one may perhaps spot some of the seeds of the regionalist evolution of modern architecture. But these are nuances of the formal aspect. For Rudofsky, modernist compositional language is a given which he is capable of using with

## On Style

See Catalogue no. 3 (p. 255), 4 (p. 256), 9 (p. 258), and 10 (p. 259)

see Catalogue no. 14 (p. 262)

see Catalogue no. 24 (p. 271), 25 (p. 272), 29 to 33 (p. 276 ff.), and 35 (p. 282)

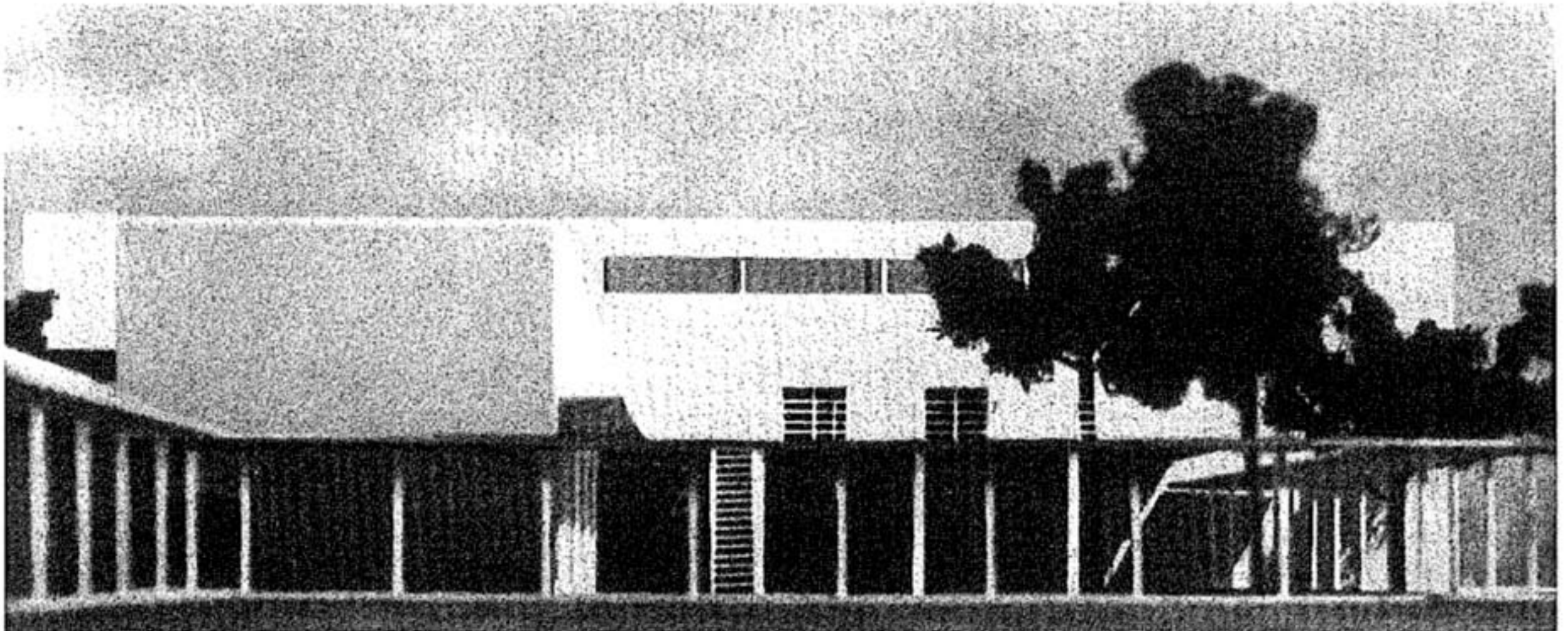

ease and freedom. This allows him to concentrate his attention on what is beyond style, without remaining a prisoner of the debates connected with the formal aspect of architecture.

Rudofsky's work and thought find their historical context in the story of rationalism. Even his subsequent rebellion against modernism and progress would be inexplicable without reference to the epic clash, in Central Europe in the first decades of the twentieth century, between innovation and conservatism in architecture.

In this conflict, Rudofsky's position was not unequivocal. His radicalism was such as to demand that every question be re-examined rationally from the beginning, seeking to free itself from the heritage of the most recent tradition (and the academic tradition in particular); but, like some

*Bernhard Rudofsky (?). Model of Naples Tennis Club (project by Luigi Cosenza and Bernhard Rudofsky) seen from the swimming pool, 1935.*

<sup>6</sup> See Claude Liechtenstein, *Otto Rudolf Salvisberg (1882–1940). Eine andere Moderne*, Zürich: GTA, 1995. To understand this way of doing architecture, it may be useful to browse some years of *Moderne Bauformen*.

Kurt Unger. Isometric view of Dr. Fleischner's House in Haifa (project by Adolf Loos), 1931. Rudofsky's domestic designs share certain traits with those of Adolf Loos, in the way the inhabitable volumes are put together, the terraced roofs, the double-height interiors, the cubical compactness of certain volumes, the clear-cut apertures—and, above all, in the "culture of dwelling" (Wohnkultur).

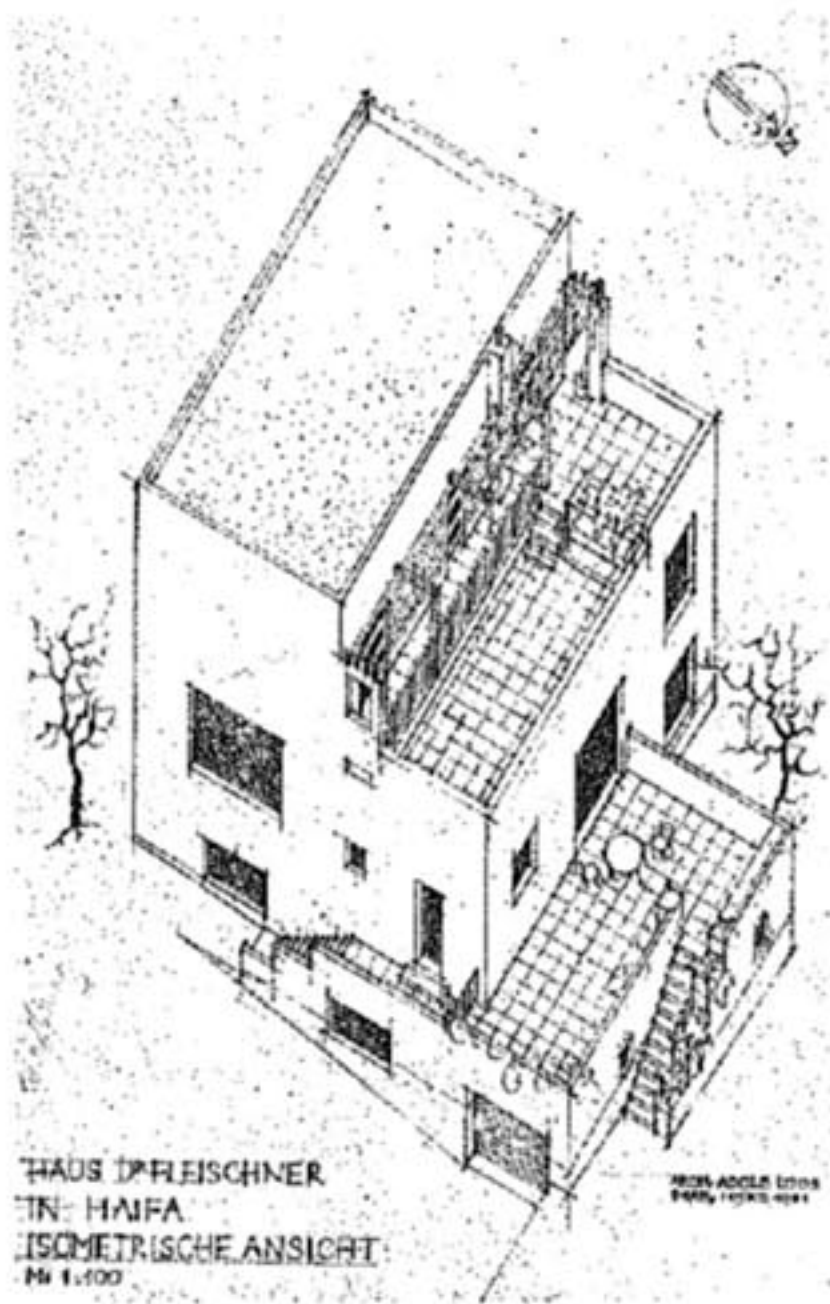

others of his period, Rudofsky maintained that it was possible to measure oneself against the basic principles which could be read in the traditions of building and dwelling of ancient civilizations and popular cultures. For him, "modern" meant: that which, thanks both to the overcoming of habitual limitations and to the possibilities offered by technology, permits a freedom never before experienced; that which is derived from a rational approach to questions, with no doctrinaire conditioning.

Already in the thirties Rudofsky was challenging, like Josef Frank before him, the betrayal of the idea of the modern by those who had won a powerful position within the modernist movement, which had rapidly turned into an aesthetic-stylistic trend content to create architecture that looked functional.<sup>7</sup>

His general approach to "modernity" brings Rudofsky closer than any other architect to Josef Frank and Adolf Loos. Loos had recommended the avoidance of formal novelties as an end in themselves, especially in "delicate" contexts: "Modifications of the traditional way of building are allowed only if they constitute an improvement; otherwise, stick to tradition."<sup>8</sup> What is more, Loos firmly excluded the house from the field of art: "The work of art is a private concern of the artist. Not so the house. The work of art is placed into the world, although there is no need for it. The house satisfies a need."<sup>9</sup> This means that the architect must moderate his drive to become the protagonist: a "total work of art" tends to condition its users' way of life excessively.<sup>10</sup>

In his mind, this applied not only to buildings' appearance. In the same way, Frank was convinced that: "If humankind in the course of its cultural history had developed certain tried-and-true solutions, then there could be no reason to replace them simply because of their age."<sup>11</sup> Frank's attack on the dogmas of "functionalism" as the justification for a new style, and on the negation of the spiritual and psychological values of architecture that it involves, is very lucid and very harsh: architecture cannot exhaust its potential merely by providing an answer to functional necessities.<sup>12</sup> The exteriors of Frank's houses show an obvious debt to Loos and modernism.<sup>13</sup> But their interiors, in both the disposition of the rooms and the furnishing, are not rigid and bare like those of the majority of his colleagues; instead, they reveal a more eclectic attitude towards form, and a greater tolerance of the tastes and real needs of the inhabitants.

7 Christopher Long, "The Wayward Heir: Josef Frank's Vienna Years, 1885–1933", in Nina Stritzler-Levine (ed.), *Josef Frank. Architect and Designer. An alternative vision of the modern home*, New Haven-London: Yale University Press, 1996, p. 55. Compare with BR38.10.

8 Adolf Loos, "Regeln für den, der in den bergen baut", *Trotzdem*, Innsbruck: Brenner-Verlag, 1931.

9 Adolf Loos, "Architektur", *Trotzdem*, op. cit.

10 AR97.1, p. 332.

11 Christian Witt-Döring, "'Steel is not a Raw Material: Steel is a Weltanschauung': The Early Furniture Designs of Josef Frank, 1910–1933", in Nina Stritzler-Levine (ed.), op. cit., p. 106.

12 Josef Frank, "Wohn", *Architektur als Symbol. Elemente deutschen neuen Bauens*, Wien: Schroll, 1931, p. 161 ff.

13 For a complete survey of Loos's work, see Burkhardt Rukschcio (ed.), *Adolf Loos*, Wien: Graphische Sammlung Albertina, 1989. About Frank's architectural oeuvre, see Maria Welzig, *Josef Frank 1885–1967. Das architektonische Werk*, Wien-Köln-Weimar: Böhlau, 1998.