

Free space optical communication flight mission: simulations and experimental results on ground level demonstrator

Original

Free space optical communication flight mission: simulations and experimental results on ground level demonstrator / Ferrero, Valter; RAMON MATA, Calvo; Stefano, Camatel; Valeria, Catalano; Luciana, Bonino; E., ITALO TOSELLI. - (2009). (Intervento presentato al convegno SPIE Symposium on Defense, Security + Sensing tenutosi a Orlando (USA) nel 13-17 April 2009.) [10.1117/12.820923].

Availability:

This version is available at: 11583/1957942 since: 2016-11-04T14:00:10Z

Publisher:

Published

DOI:10.1117/12.820923

Terms of use:

This article is made available under terms and conditions as specified in the corresponding bibliographic description in the repository

Publisher copyright

SPIE postprint/Author's Accepted Manuscript e/o postprint versione editoriale/Version of Record con

Copyright 2009 Society of PhotoOptical Instrumentation Engineers (SPIE). One print or electronic copy may be made for personal use only. Systematic reproduction and distribution, duplication of any material in this publication for a fee or for commercial purposes, and modification of the contents of the publication are prohibited.

(Article begins on next page)

Free Space Optical Communication Flight Mission: Simulations and experimental results on ground level demonstrator

Ramon Mata Calvo^{a,b} Valter Ferrero^{*a,b}, Stefano Camatel^b,
Valeria Catalano^c, Luciana Bonino^d, Italo Toselli^a

^aPhotonLab, Electrical Department Politecnico di Torino, cso Duca degli Abruzzi 24, Torino, Italy;

^bIstituto Superiore Mario Boella, via Boggio. 61, Torino Italy;

^cAgenzia Spaziale Italiana, Viale Liegi 26, Roma, Italy;

^dThales Alenia Space Italia, str. Antica di Collegno 253, Torino, Italy;

ABSTRACT

In the context of the increasing demand in high-speed data link for scientific, planetary exploration and earth observation missions, the Italian Space Agency (ASI), involving Thales Alenia Space **as prime**, the Polytechnic of Turin and other Italian partners, is developing a program for feasibility demonstration of optical communication system with the goal of a prototype flight mission in the next future.

We have designed and analyzed a ground level bidirectional Free Space Optical Communication (FSOC) Breadboard at 2.5Gbit/s working at 1550nm as an emulator of slant path link. The breadboard is full-working and we tested it back-to-back, at 500m and 2.3km during one month. The distances were chosen in order to get an equivalent slant path cumulative turbulence in a ground level link. The measurements campaign was done during the day and the night time and under several weather conditions, from sunny, rainy or windy. So we could work under very different turbulence conditions from weak to strong turbulence. We measured the scintillation both, on-axis and off-axis by introducing known misalignments at the terminals, transmission losses at both path lengths and BER at both receivers. We present simulations results considering slant and ground level links, where we took into account the atmospheric effects; scintillation, beam spread, beam wander and fade probability, and comparing them with the ground level experimental results, we find a good agreement between them. Finally we discuss the results obtained in the experimentation and in the flight mission simulations in order to apply our experimental results in the next project phases.

Keywords: Free space optics, Free space optical communications, scintillation, free space optical propagation

1. INTRODUCTION

The increasing demand in high-speed data link for scientific, planetary exploration and earth observation missions, calls for the improvement of free-space laser communication links.

In this context, the Italian Space Agency (ASI) is developing a program for feasibility demonstration of optical communication system with the goal of a prototype flight mission in the next future. [5][6]

The program is led by Thales Alenia Space Italia and involves the Italian company Space Light and the Russian company Myasishchev Design Bureau, the University: Politecnico di Torino – Electrical Department (PhotonLab) and the research institutes: Istituto Superiore Mario Boella (ISMB) and CORISTA.

FSOC has the following advantages with respect to Radio Frequency System (RFS): smaller antenna size, lower weight and lower power consumption. Working at optical frequencies (200 THz) allows much higher bit rate with respect to RF communications. It also presents immunity from intercept of data communication due to the small Field Of View (FOV) and to Electromagnetic Interferences. [7]

*valter.ferrero@polito.it; phone 0039 0110904158; www.optcom.polito.it

The major disadvantages are related to the large impact of atmospheric effects like fog, rain, etc. We must take into account that FSOC is a typical point to point communication and due to the narrower beam width it requires an accurate tracking acquisition and pointing system, increasing the FSOC architecture complexity with respect to the RF Systems.

In visible and IR wavelengths, light propagation through the atmosphere is affected by several phenomena: atmospheric turbulence (beam spread and scintillation), background radiation, absorption and scattering.

Atmospheric turbulence degrades the performance of free-space optical links, particularly over ranges of the order of 1 km or longer. Indeed, due to the refraction index variations along the transmission path, fluctuations in both the intensity and the phase of the optical received signal impact on the Bit Error Rate performance. [1]

The fog effect is a determinant factor in terms of the transmitted signal attenuation. In addition, the background radiation for a given wavelength, that is the unwanted light from celestial bodies: radiation from sun, moon, earth and stars, is another factor that may have a degrading effect on the system performance.

The goal of this work is the development of an experimental ground demonstrator that performs an horizontal optical free-space communications, on earth, under the same cumulated turbulence conditions as in the ground-airplane scenario.

The main experiments carried out on the ground system are used to evaluate, first of all, the system performance, then the link losses and the atmospheric impact on the beam transmission.

2. SIMULATIONS

2.1 The atmosphere model

We define several parameters to explain how atmosphere affects the optical beam; however their cause is always the refraction index fluctuations.

Scintillation describes the fluctuations of the received irradiance due to atmosphere and it is defined as the normalized variance of the irradiance.

Rytov variance is the scintillation defined for a plane wave as $\sigma_R^2 = 1.23C_n^2 k^{7/6} L^{11/6}$ [1][2], where C_n^2 is the structure parameter, k is the wave-number and L is the link path length. This parameter is used to discern between weak $\sigma_R^2 \ll 1$ and strong turbulence $\sigma_R^2 \gg 1$ conditions and we used it to compare simulations between uplink, downlink and horizontal path in equivalent turbulent conditions. [1][2]

In horizontal links, it is used to suppose that the structure parameter is constant [1], and we choose a parameter that can fit it meanly. When we consider uplink or downlink transmissions, an integral of the whole structure parameter profile along the path is needed. We have chosen in our simulations one of the most widely used models for the structure parameter profile, the Hufnagel-Valley (H-V) model. [1][7]

However scintillation in terms of system performance is more realistic when it takes into account the aperture averaging and the extended Rytov theory. [1]

Receiving telescope size can reduce scintillation when the aperture is larger than the correlation width associate with the receiving beam irradiance fluctuations [1].

Middle-size turbulence eddies become ineffective when cumulated turbulence increases and as can be found in literature, scintillation reaches a maximum and after it saturates. Extended Rytov theory introduces spatial filters that discard these eddies yielding Rytov theory valid also for moderate-to-strong turbulence. [4][1]

Spot size in a Gaussian beam is defined as the radius between the maximum and where field decreases 1/e. We define it in transmission on telescope plane as W_0 , in reception on telescope plane as W and in reception on image plane as W_{IP} . To get the image plane spot size radius we use the ABCD formulation.

Image jitter takes into account the displacement of the beam over the image plane due to angle-of-arrival fluctuations.

The effective beam size at the image plane has been obtained taking into account both the W_{IP} and the image jitter.

The long term beam spread parameter includes the enlargement due to small scale eddies (the beam spread) and the beam wander due to the large scale eddies. [1]

Long term loss describes the effective losses due to the the receiver telescope finite size aperture that cannot collect the overall received optical beam. We also define the losses without scintillation as the resulting amount of adding long term losses, optical transceiver losses, atmosphere attenuation and link margin.

The link is affected by an out-of-service probability, due to scintillation phenomenon, i.e the fluctuations in the received optical power. In order to guarantee a specific value of the out-of-service probability, we have to transmit more optical power corresponding to the fade level. Thus, the overall system power budget must also take in account this fade level..

2.2 Simulations

The mission scenario is a bidirectional link between a ground station and a flight terminal at 21km altitude. The zenith angles will vary between 0degrees and 45degrees. The wavelength is 1530nm uplink and 1560 nm downlink, the bit rate is 2.5Gbit/s for every direction.

From seeing measurements made during several weather conditions in the location where will where the following project experiments will take place, the structure parameter at ground level is estimated between $10^{-14}m^{-2/3}$ and $10^{-13}m^{-2/3}$.

The worst case in terms of cumulated turbulence happens when the zenith angle is 45degrees. The downlink transmission can be classified under weak turbulence conditions because the calculated Rytov variance falls under 1, while the uplink transmission can be classified under moderate-to-strong turbulence conditions because the Rytov variance is 3.8 at the expected structure parameter value. In order to emulate both turbulence conditions in a horizontal link, we need to use two horizontal link distances.

The simulations of the horizontal scenario will be used to design the ground system and to analyze the effects the beam will experiment. The terminals will perform a 2.5Gbit/s communication at a wavelength of 1530nm and 1560nm.

The structure parameter is considered constant with respect to the altitude. Obviously, this is not strictly true, but in horizontal links such an approximation is usually assumed; the atmosphere is modelled considering several layers with constant C_n^2 at constant height [1]. Since weather conditions change hour by hour and day by day we suppose a wide range of C_n^2 values are experienced. In our simulations we vary it from 10^{-16} to 10^{-12} as well as the distance from 100m to 30km to analyze the turbulence phenomena for several link distances.

Moreover we will consider 6dB for optical terminal losses, 3dB are from the transmitter and other 3dB are from the receiver. We will suppose 2dB of losses due to the atmosphere and 3dB for system link margin.

The main parameters considered in simulations are summed up in the next table.

Bit-rate	2.5Gbits
Telescope Diameter	20cm
Telescope Obscuration Ratio (diameter ratio)	37.5%
Wavelength	1550nm
Distance	100m-30km
C_n^2	10^{-16} to $10^{-12} m^{-2/3}$

The parameters to be simulated are the long term losses, the scintillation, the spot size at the focal plane and the total link losses. This last parameter will define the power budget needed to ensure a communication between both terminals.

First of all, in figure 1a, we show the simulated Rytov variance. In downlink simulations the Rytov parameter was under 1, thus from this graphic we can choose 500m that can emulate the downlink turbulence conditions, defined as weak turbulence by the theory ([1], [2]). A Rytov value of 3.8 was found in uplink simulations. The same value is obtained in horizontal link simulations at 2.3km and defines moderate-to-strong turbulence conditions. The atmosphere near ground is denser than the atmosphere at high altitude; therefore the impact on beam propagation is higher in uplink than in downlink. Furthermore the horizontal link length, needed to obtain the same impact of a vertical link, is lower. These two distances, 500m and 2.3km, emulate the same cumulated turbulence as the uplink and downlink respectively. However, changes on weather conditions may affect the structure parameter value.

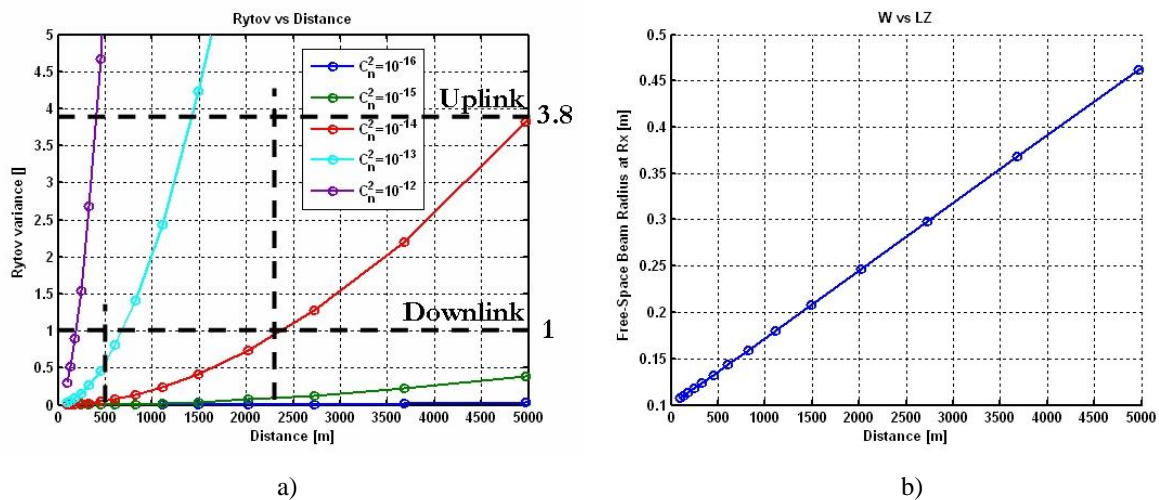

Fig. 1. a) Rytov variance in horizontal link and b) Gaussian free-space beam radius without atmosphere.

In graphic 1b, the beam radius at the telescope plane is plotted without considering the turbulence impact, i.e. without atmosphere. At 500m the beam is enlarged until 0.14m and at 2.3km until 0.27m. This graphic shows the propagation of the Gaussian beam wave, defined by the theory. [1][2][3]

The atmosphere produces further beam enlargement at the telescope plane due to the turbulence. The beam wander and the beam spread are then considered together in the long term beam radius parameter, represented in graphic 2a. Then the beam radius at 500m is around 0.14m and 0.3m at 2.3km with a structure parameter of $4 \cdot 10^{-14} \text{m}^{-2/3}$. At these distances the turbulence does not strongly impact on the spot enlargement, however the beam enlargement depends on the atmospheric conditions; if the structure parameter increases the beam can be further broadened until 0.7m at 2.3km.

In order to calculate the long term losses we solve the integral of the beam that reach the receiver over the telescope area, considering also the obscuration due to the telescope secondary mirror. Increasing the link distance, the beam is enlarged, thus the collected light by the telescope decreases, as shown in figure 2b.

Next simulation carried out was the scintillation at the focal plane. Its graph is shown in figure 3a. The typical scintillation saturation that happens under strong-turbulence conditions can be seen on the graphic; the scintillation increases till its maximum and then decreases to saturate at a smaller value. Depending on weather conditions, at 2.3km we can experiment scintillations under 0.2, under turbulence conditions from weak to strong. At 500m in contrast to 2.3km the maximum scintillation is roughly 10 times lower.

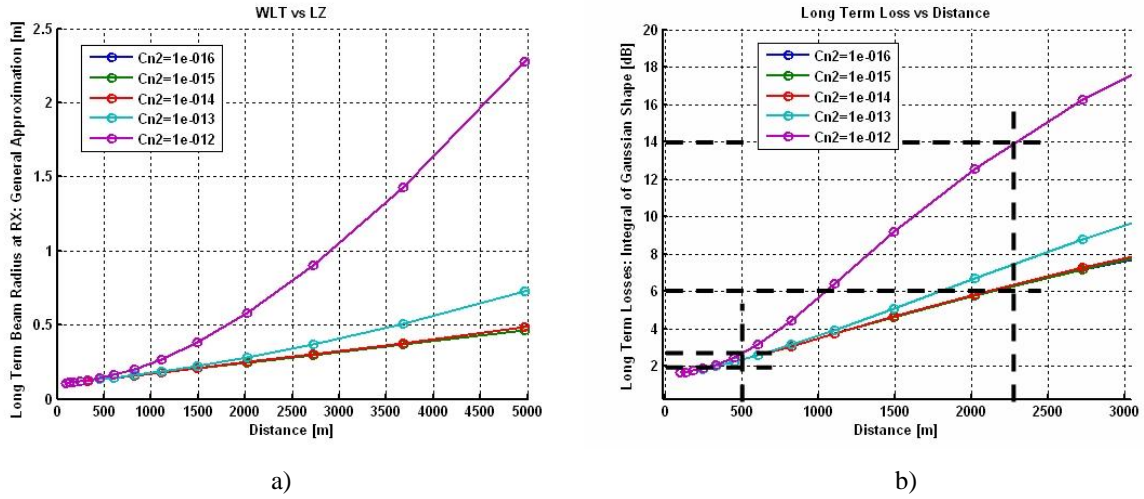

Fig. 2. a) Long term beam spread that takes into account beam wander and short-beam spread and b) long term losses due to the finite telescope aperture size.

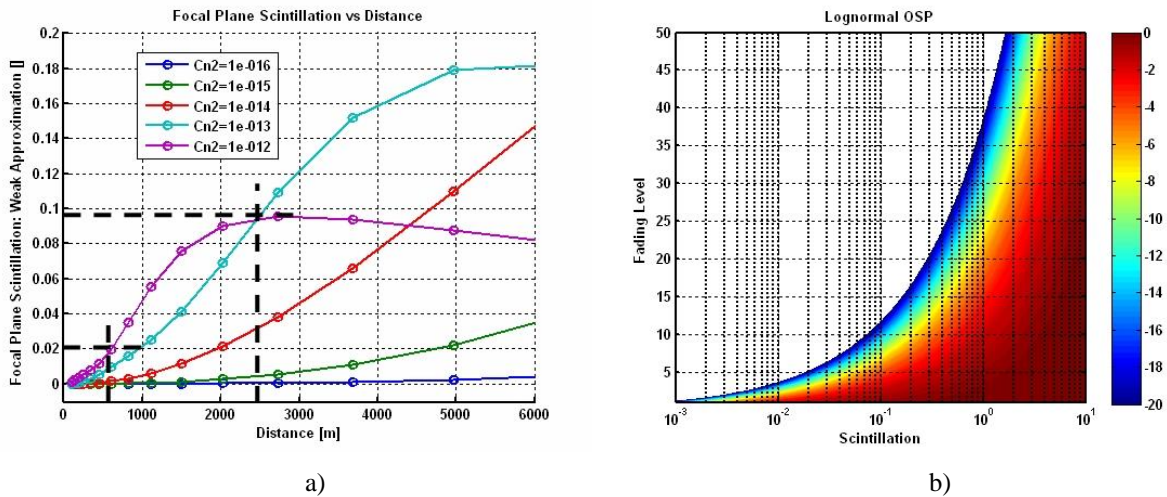

Fig. 3. a) Scintillation at the image plane and b) log normal fade level

The scintillation is a very important parameter because represents the irradiance fluctuations that causes power fluctuations at the optical receiver side. The power increases and decreases depending on the turbulence path encountered during the transmission through the atmosphere. It can produce fading, a loss of communication, because the power can fall under the receiver sensitivity. To compensate this phenomenon, the transmitted optical power can be increased in order to ensure that the minimum power is above the receiver sensitivity limit. Thus, the fade level is defined as the amount of power we have to increase at the transmitter in order to ensure a desired maximum fading probability. We use the log-normal model [1] and it is shown on the figure 3b. The color represents the out-of-service probability; then, given a scintillation value on the x-axis, the fade level needed to get the desired out-of-service probability at the receiver is returned. The fade levels, in order to obtain an out-of-service probability of 10^{-12} at the receiver, are 3dB at 500m and 9dB at 2.3km.

The spot size at the focal plane is considered together with the image jitter, namely the spot size movement on the focal plane due to the angle-of-arrival fluctuations of the optical wave, thus we can define an effective spot size that takes into account both effects: the enlargement and the movement. Both graphics are in figure 4.

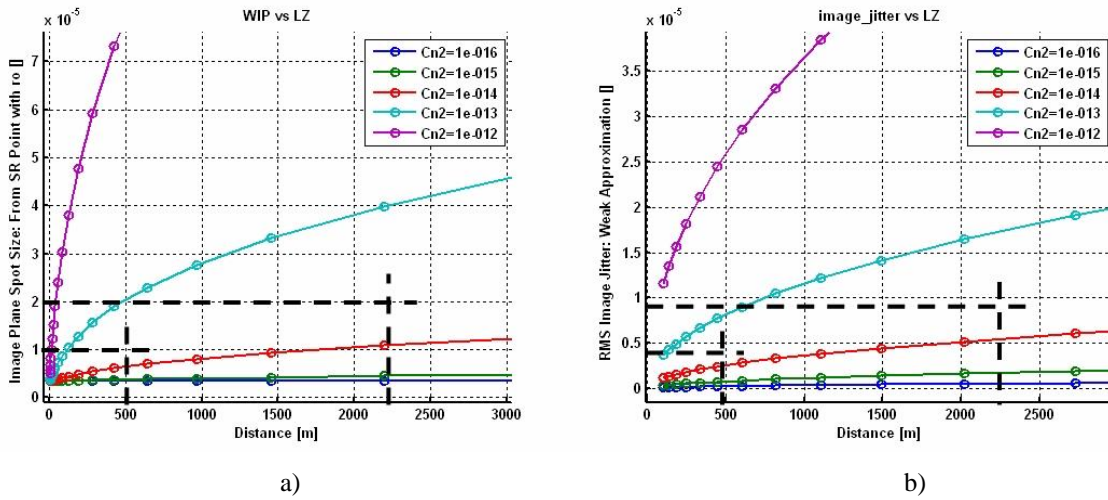

Fig. 4. a) Spot size radius at the image plane and b) rms jitter due to angle of arrival fluctuations.

At 500m the simulated spot radius is 10 μ m and the image jitter is 4 μ m, thus the effective spot size is 14 μ m, whereas it is 28 μ m at 2.3km, with 20 μ m of spot radius and 8 μ m of image jitter. From the simulated image plane spot size we can conclude that we need a multi-mode fiber in order to collect it. We chose a multi-mode fiber of 62.5 μ m of diameter at the receiver.

Finally the losses without the fade level can be shown together in figure 5. Here, all the losses we talked about above are taken into account: 6dB due to transmitter and receiver losses, 2dB due the atmosphere, 3dB link margin and long term losses. Adding then the fade level, we get the power budget needed to ensure the communication link. These values are shown on table 1.

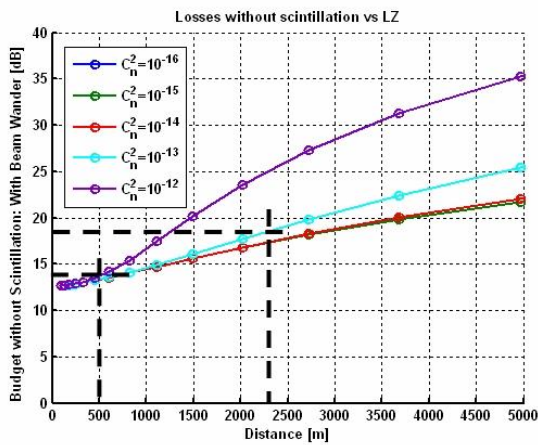

Table 1. Power Budget requirements on horizontal link.

Distance	Losses	Fade level	Power Budget
500m	13dB	4dB	18dB
2.3km	18dB	12dB	30dB

Fig. 5. Total losses, including long term losses, terminal optical losses, atmosphere losses and link margin.

2.3 Simulations discussion

From the cumulated turbulence point-of-view, two horizontal distances, that emulate the earth-aircraft scenario, are found. The equivalent link is performed by an optical horizontal communication between two ground terminals with two distances cases between terminals: 500m and 2.3km .

Horizontal simulations allowed us recognizing the main parameters on the communication. The long term losses are to be considered with the terminal internal losses in order to define the power budget needed to perform the link. Moreover we have seen that it is needed to take also into account the scintillation effect that represents the power fluctuations on the receiver due to the turbulence. Fade level parameter is introduced in the power budget to guarantee the communication under the desired out-of-service probability. From the simulation of the spot size at the focal plane we choose a multi-mode fiber in order to collect the light onto the photo-detector. Additional losses due to the differences between spot size, fiber diameter and optical misalignment are also expected.

Finally we found that the total budget needed at 500m is 18dB and at 2.3km is 30dB. These values are used as reference to be compared with the values obtained in the experimental activities.

3. EXPERIMENTAL ACTIVITY

3.1 Hardware

We performed the optical transceiver design and realization. The transceiver block scheme is shown on figure 6. The upper branch is the transmitting part of it. The electrical data is generated and converted to the optical domain by means of the optical transmitter. A 99/1 splitter allows monitoring the power. Then the signal is amplified using an EDFA and it is sent to the telescope to be transmitted.

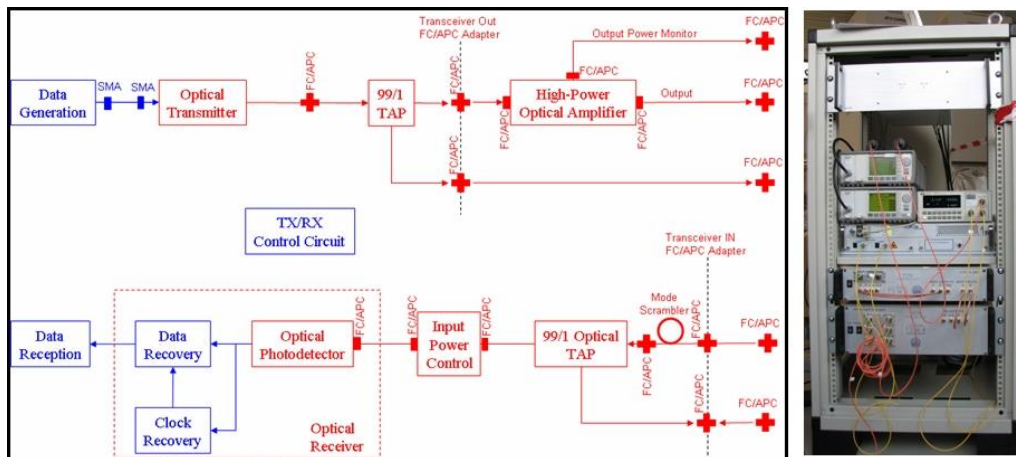

Fig. 6. Transceiver design.

The lower branch in figure 6 is the receiving part schema. The signal comes from the telescope, pass through a mode scrambler and encounters a 99/1 splitter. Then it is sent to the input power control. This element, based on a Variable Optical Attenuator (VOA), allows setting a desired optical power after it. It is based on a passive optical element, thus it can only attenuate the arriving photons. This input power control can fix the power after it if the power before it is higher than the requested value. It is very useful to compensate the power fluctuations due to the atmospheric turbulence, i.e. the scintillation. In practice, thanks to the input power control, the overall optical receiver dynamic range is enlarged approximately to 40dB.

After the input power control, the signal is sent to the optical receiver formed by the photodiode, the data and the clock recovery. Finally it is sent to the BER tester.

After assembling them, we tested the whole system back-to-back (a 40m link communication) in order to characterize it. The pointing and all measurements were also performed in order to have a reference in the next outdoor experiments.

Once both terminals were designed, we decided to mount them, one on a building's roof, and the other in a van that allowed moving one terminal to perform measurements at the two desired distances.

3.2 Measurements

Here we present the main results obtained performing experimental measurements during one month. First of all we analyzed the performance of our system; the main objective of the project. Measurements to quantify the losses and the scintillation due to the turbulence were also carried out. Finally we present also measurements introducing a known misalignment in one of the terminals. All experiments were performed under several weather conditions; snow, rain, sun and clouds.

The experimental results are compared with the simulations presented above in order to analyze the goodness of horizontal free space optical system realized. Nevertheless, several additional effects are not taken into consideration in the simulations. Therefore we cannot expect to retrieve exact values, but rather the trend of the analyzed parameters.

Performance was analyzed by means of BER measurements. The transmitter generates a pseudo-random sequence and the receiver calculates the bit error rate using a BER tester. Graphics on figure 7 are the BER measurements at both distances. This experiment consists on decreasing the received power by means of the Variable Optical Attenuator (VOA) at the receiver and measuring the BER of the received data. The received power at which we obtain a BER= 10^{-9} is the sensitivity of the receiver. Measurements back-to-back fixed the value around -20dBm and here we obtain the same results completely coherent between them.

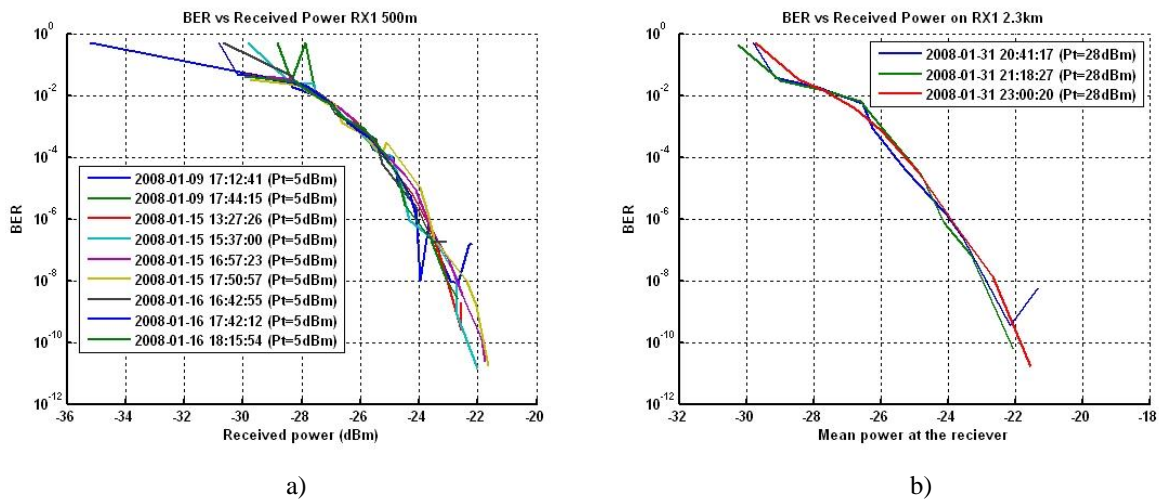

Fig. 7. Measured BER a) at 500m and b) at 2.3km.

Mean received power depends on the transmitted power, weather conditions and tracking operations, so the received optical power fluctuates in time. However during the day the values are coherent. We experimentally characterized the losses onto the communication link, obtaining the graphs shown in figure 8a, at 500m and figure 8b, at 2.3km.

These losses are due to the beam size enlargement when it is propagated through the atmosphere. The receiver finite aperture, 20cm of diameter, cannot collect all the power; what we defined as long term losses. Moreover losses due to the optical terminals must be taken into consideration. We measured them in back-to-back conditions; i.e. a 40m link communication. These initial measurements served to verify all the system components and to try the pointing system. Under these conditions we measured link losses around 12dB.

At 500m we observed losses around 20dB, whereas at 2.3km we observed losses around 30dB.

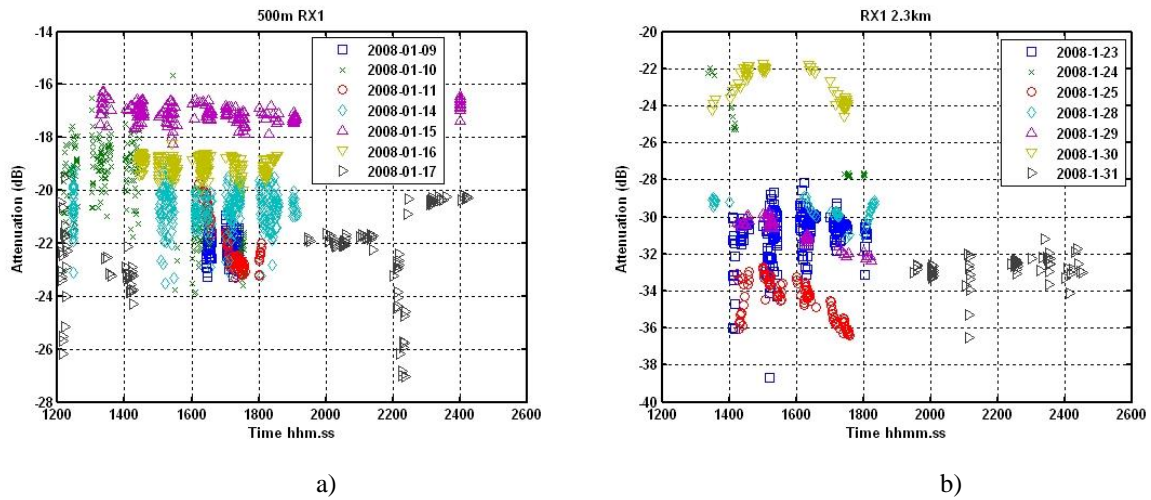

Fig. 8. Measured attenuation a) at 500m and b) at 2.3km.

We calculate the theoretical overall loss by adding the experimental measured back to back optical losses (12dB) to the simulated long term losses at the chosen distance, values already reported on graphic 2b. We compare this resulting value to the total measured value. The differences between both values are 5dB at 500m and 12dB at 2.3km.

Effects not taken into account are: not optical alignment repeatability penalty, not optimal tracking procedure and beam divergence mismatch. We can also consider an additional couple of dB due to misalignments. In fact, the link was optimized introducing some misalignments in order to get the same attenuation in both link directions.

However, the mismatch between simulated and measured values is higher at 2.3km than at 500m. The reason can be the loss of optical power due to the coupling efficiency with the fiber at the focal plane.

From power fluctuations we can measure scintillation. Here, it is clear that scintillation is higher when sun irradiance is higher and also depends on day weather conditions.

We measured scintillation calculating the variance of the fluctuating power at the receiver side. We report the graphics of both receivers at 500m in figure 9a and at 2.3km in figure 9b.

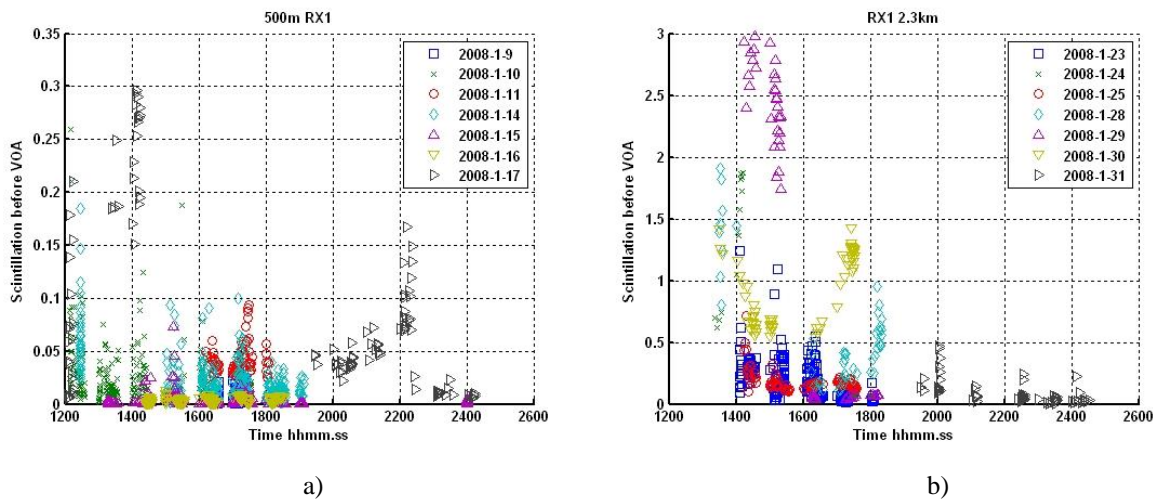

Fig. 9. Measured scintillation a) at 500m and b) at 2.3km.

At 500m the measured scintillation is around 0.01 and most of the measured values fall under 0.1. Some values reach 0.3. This behavior is observed in both receivers. The fade level that guarantees a 10^{-12} out-of-service probability is around 3dB with a scintillation of 0.01 and around 8dB with a scintillation of 0.1.

At 2.3km the measured scintillation is around 0.1 and most of them under 1. Some values reach 3. This behavior is observed in both receivers. The fade level that guarantees a 10^{-12} out-of-service probability is around 8dB.

Comparing the values with the simulations in graphic 3a, at 500m the simulated scintillation is around 0.01 under all turbulence conditions in contrast to the scintillation at 2.3km that falls under 0.1 and takes several values depending on the atmospheric structure parameter.

Simulations and experimental results are coherent between them. We suppose the main differences on the values are due to off-axis scintillation.

In fact, we performed also measurements with misalignments. These measurements were carried out keeping fixed one terminal and moving the other terminal in azimuth introducing a misalignment until 30arcsec (145.4 μ rad) in both directions with steps of 1arcsec (4.8 μ rad).

The main scope of these experiments was to measure the off-axis scintillation effects due to pointing misalignments. Literature supplies equations for off-axis scintillation at the telescope plane also under strong turbulence, but such equations do not take into account the effect of aperture averaging, i.e. the scintillation reached at the focal plane. Literature also tells that scintillation increases when we move away the beam axis until it is saturated and decreases. [1]

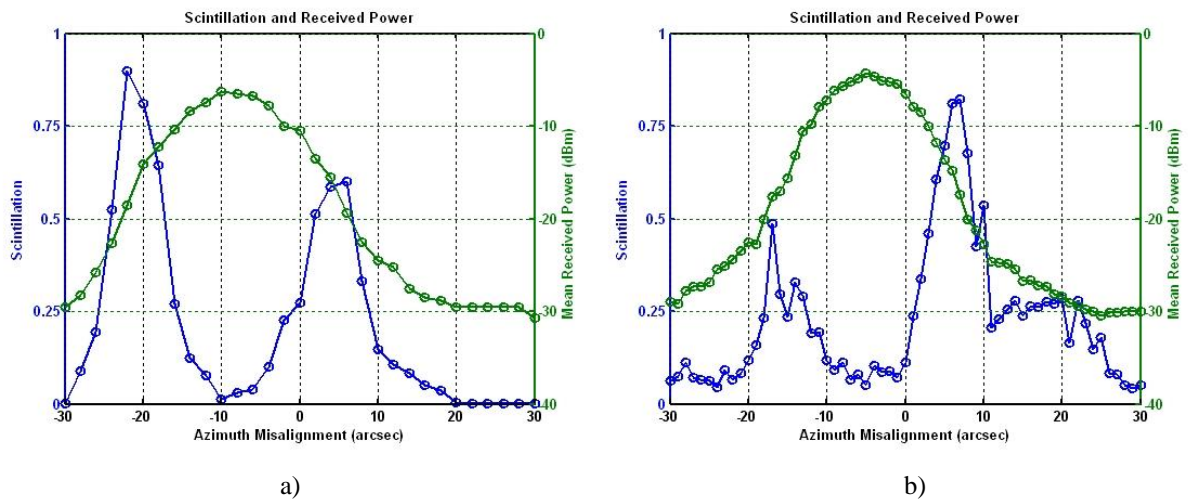

Fig. 10. Measured power and scintillation with known misalignments a) at 500m and b) at 2.3km.

The graphs obtained in both measurements are shown in figure 10. The scintillation and the received power are shown in both graphs. Here, it is clear that power decreases with the misalignment while the scintillation increases due to an off-axis scintillation component. The scintillation reaches peak values of 0.5 and 0.8, near ten times greater than the on-axis scintillation at 2.3km or near one hundred times greater than the on-axis scintillation at 500m. After reaching the maximum, increasing some more the misalignment, the attenuation on power is more than 10dB and the scintillation decreases towards zero.

Before, we told about the introduced beam misalignment on the pointing optimization procedure in order to get the same attenuation values in both link directions. This can be clearly observed in both graphics, where the maximum of power is obtained at -10arcsec (-48.5 μ rad) at 500m and -5arcsec (-24.2 μ rad) at 2.3km. The maximum of the received power coincides with the minimum of the scintillation as it is known from theory.

Here we find one possible reason why the experimental scintillation is higher than the simulated one. There is an off-axis scintillation component to be taken into account as well as an additional attenuation of the received power due to the misalignment.

Introducing an angular misalignment at the transmitter, two effects are produced. First, there is a shift of the received beam on the telescope plane that produces losses as far as not all power is collected by the aperture and second, there is an angle-of-arrival of the mean optical plane that produces a spot shift onto the focal plane, introducing additional losses because not all the focal beam is collected by the fiber.

3.3 Conclusions on experimental activity

The experiments confirmed the full performance of the ground terminals, carrying out free-error communications over -20dBm of received power.

The measured link losses are 20dB at 500m and 30dB at 2.3km. The expected losses at both distances are higher than the ones calculated in the simulations. We have seen that these differences can be explained due to a misalignment introduced during the pointing optimization in order to get the same attenuation in both link directions. Other factors like the non repeatability on the pointing alignment or differences on the considered divergence impact on it.

The scintillation values from experiments agree with simulations; at 500m we obtained values around 0.01 and at 2.3km around 0.1. However, higher values are obtained at both distances. One possible reason is the impact of the off-axis scintillation introduced by the misalignment between both terminals. The change on weather conditions can be clearly observed during the daytime and through all days in the variability of the measurements. An increase of the transmitting power is needed in order to avoid received power falling under the receiver sensitivity. Such scintillation values require 3dB and 8dB respectively of fade level to guarantee an out of service probability of 10^{-12} .

Finally, experiments with known misalignments allowed measuring the off-axis scintillation and received power. It confirmed the presence of a misalignment between both terminals due to pointing optimization, in order to obtain the same attenuation in both link directions. We observed the increase of the scintillation up to a maximum value and then as the misalignment increased, the decrease of the scintillation down to zero. Moreover, we observed two effects on angular misalignments of the transmitter: the spot displacement on the telescope plane and on the detector plane. The finite size of the fibre and of the telescope are the reasons why power decays, impacting more the fibre size at short distances and the telescope size at long distances.

4. CONCLUSIONS

The development of a ground link demonstrator is a part of a project funded by ASI to realize a link between a ground station and an airplane. The team was formed by Thales Alenia Space Italia (Torino site), coordinator of the project and in charge of the telescope and the pointing system, SpaceLight that performed adaptive optics simulations, CORISTA that performs a survey on the existing ground station, and finally ISMB and Politecnico di Torino that designed and built the transceiver hardware and dealt with the system simulations and the measurements campaign.

We developed a full-working system that emulates an uplink-downlink communication using two terminals at the ground level. The main scope of these experiments was to face the design and develop a FSOC system, probe the performance of such a system, analyze the effects of the atmosphere turbulence on the transmitted beam in terms of power budget and to individuate the main critical points to be taken into account in the slant path communications.

Pointing is one of the most critical aspects. Pointing is easier when the footprint on the airplane increase, but at the same time the losses increase because of the small aperture at the aerial vehicle. Moreover from experiments results we deduced that misalignments impacts on power losses and increasing of scintillation.

The atmosphere impacts on the beam, enlarging it and increasing the scintillation. The beam enlargement means more link losses because not all power is collected by the aperture, first at the telescope plane and then at the detector plane. Scintillation means irradiance fluctuations that from the detector point-of-view mean power fluctuations. If power falls under the sensitivity limit, a fade is produced and this means the loss of the communication. In order to avoid this effect and ensure a minimum power value with a certain out-of-service probability, the transmitted power is increased and an

input power control has been used in order to reduce power fluctuations and so, to extend the optical receiver dynamic range.

Beam enlargement and scintillation are two effects on the beam that point to the possibility of using an adaptive optics system in order to improve these parameters, i.e. the system performance.

In terms of power budget, we found in simulations that it is necessary to increase its value until 56 – 60 dB, in order to guarantee the stratospheric mission power budget communication [5], so it is necessary to increase the power budget horizontal demonstrator system of approximately 15 dB

Power budget increase may be obtained by the following options:

- Using 20 cm aircraft telescope diameter: + 6 dB.
- Increase the optical transmitted power at the ground station site up to 3 W: + 6 dB.
- Introduce a Semiconductor Optical Amplifier at the aircraft optical receiver: + 10 dB.
- To have the possibility to change the optical beam parameter transmitted by ground station site, in order to find a trade off between tracking procedure and long term loss on the optical link: from 0 to 12 dB.
- Adaptive optics correction on the transmitted beam: +6÷11 dB depending on the number of aberration terms removed (from 2 to 20).

ACKNOWLEDGEMENTS

The research activity was funded by Italian Space Agency, in the framework of the research project “Optical Telecommunication Payload” phase A2

REFERENCES

- [1] Larry C. Andrews, Ronald L. Phillips, Laser Beam Propagation through Random Media, SPIE Press, USA, 2005.
- [2] Larry C. Andrews, Ronald L. Phillips, Cynthia Y. Hopen, Laser Beam Scintillation with Applications, SPIE Press, USA, 2001.
- [3] Anthony E. Siegman, Lasers, University Science, USA, 2001.
- [4] W.B Miller, J.C.Ricklin, L.C. Andrews, Effects of the refractive index spectral model on the irradiance variance of a Gaussian beam, J. Opt. Soc. Am. A 11 (1994) 2719-2726.
- [5] Luciana Bonino, et al., The Italian optical telecommunications payload: breadboard results, DASIA, DATA Systems In Aerospace, Palma de Mallorca (Spain), 27-30 May 2008
- [6] Lamberto Zuliani, et al., A new optical telecommunications payload: results from phase A2 activities, 14th Ka and Broadband Communications conference Matera (Italia), September 2008
- [7] Edited by Hamid Hemmati, Deep Space Optical Communications, John Wiley & Sons, USA, 2006.