

Development of a front-end electronics for an innovative monitor chamber for high-intensity charged particle beams

*Original*

Development of a front-end electronics for an innovative monitor chamber for high-intensity charged particle beams / Guarachi, Leslie Karen Fanola; Fausti, Federico; Marchetto, Flavio; Giordanengo, Simona; Mazza, Giovanni; Anvar, Mohammad Varasteh; Monaco, Vincenzo; Sacchi, Roberto; Cirio, Roberto. - In: IEEE 21st, At Washington, USA. - ELETTRONICO. - IEEE Xplore NSS/MIC:(2014), pp. 1-4. (Intervento presentato al convegno IEEE NUCLEAR SCIENCE SYMPOSIUM & MEDICAL IMAGING CONFERENCE 21ST SYMPOSIUM ON ROOM-TEMPERATURE SEMICONDUCTOR X-RAY AND GAMMA-RAY DETECTORS tenutosi a Seattle, Washington, US nel 8-15 November 2014) 1109/NSSMIC.2014.7431101  
This version is available at: [11583/2653618](https://doi.org/10.1109/NSSMIC.2014.7431101) since: 2016-11-08T14:18:44Z

*Publisher:*

Institute of Electrical and Electronics Engineers Inc.

*Published*

DOI:10.1109/NSSMIC.2014.7431101

*Terms of use:*

This article is made available under terms and conditions as specified in the corresponding bibliographic description in the repository

*Publisher copyright*

(Article begins on next page)

# Development of a Front-End Electronics for an Innovative Monitor Chamber for High-Intensity Charged Particle Beams

Leslie Karen Fanola Guarachi, Federico Fausti, Flavio Marchetto, Simona Giordanengo, Giovanni Mazza, Mohammad Varasteh Anvar, Vincenzo Monaco, Roberto Sacchi, and Roberto Cirio

**Abstract**—A multi-gap ionization monitor chamber has been developed by INFN and Torino University, for monitoring of high intensity pulsed charged particle beams. The read-out of the chamber is based on a 64-channel ASIC, designed in CMOS 0.35 $\mu$ m technology which features for each channel an independent current-to-frequency converter followed by a synchronous counter. The chip was designed for connecting each channel to a different detector element. However, high beam intensities may lead to an input current above the saturation level of a single channel. A novel readout has been tested where all the input channels of the chip have been connected in parallel to the same detector element allowing to reach 64-times higher input current with only a modest deterioration of the resolution. Results will be presented in terms of linearity and noise, and will be compared to a simulation where the chip is modeled as a set of independent and uncorrelated channels.

**Index Terms**—Radiotherapy, Charged particles, Ionization chambers, Electronics read-out.

## I. INTRODUCTION

THE number of hadrontherapy centers for proton and carbon ions treatments is constantly increasing. Nowadays new compact accelerators for charged particles beam therapy have been proposed where high beam intensities occur in short pulses, as laser-driven accelerators [1], [2], cyclinac [3], synchrocyclotrons [4] and fixed field alternating gradient accelerators [5]. Therefore, new detectors need to be developed for high intensity pulsed beam structure.

The INFN, in collaboration with Torino University, is developing an innovative multi-gap ionization chamber designed to measure high-intensity-charged particle beams. This device includes three parallel ionization chamber with independent anodes and cathodes separated by gaps of different thicknesses filled with nitrogen gas. The charge produced in the gas is proportional to the gap width. However the charge collected by each chamber is expected to deviate from the gap width proportionality due to the high intensity beams and the consequent inefficiencies due to charge

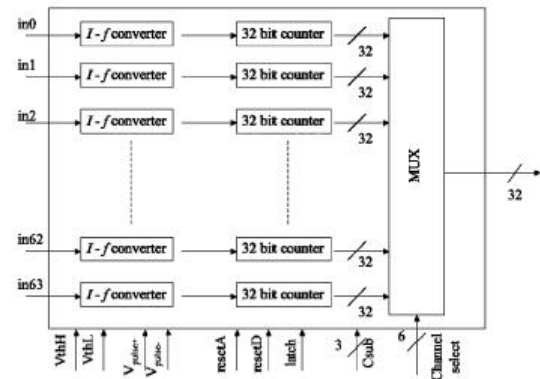

Fig. 1. Chip Tera08 architecture.

recombination. The deviation from proportionality can be used to determine the collection efficiency and to correct for it.

The read-out of the ionization chamber is a critical part of the project. The core of this front-end electronics is a 64-channel ASIC which converts the input current into a frequency of counts, each count corresponding to a charge quantum  $Q_c$ . The chip was designed for connecting each channel to a different detector element. However, high beam intensities may lead to an input current above the saturation level of a single channel. The innovation for the read-out in this project, is the development and characterization of parallel connection of all the input channels of the chip in order to get a saturation level 64 times higher than the single channel. After a brief description, the results of the tests are presented.

## II. BRIEF DESCRIPTION OF THE INTEGRATED CIRCUIT

The architecture of the chip (Tera08) is schematized in Fig. 1. The chip to read-out the current is a 64-channel ASIC designed in CMOS 0.35 $\mu$ m and consists for each channel in a current-to-frequency converter followed by a counter, the maximum frequency of the converter being 20MHz. It can measure inputs of both polarities, having 32 bit synchronous counters with up/down counting capability. In this way, both negative (positive) charges can be measured by determining the increment (decrement) of the counter in a given time interval. The operation principle can thus be represented both as a charge-to-pulse-count and as a current-to-pulse-frequency converter [6]. The converter of each channel is based on the recycling integrator principle.

Manuscript received October 31, 2014.

L. K. Fanola G., F. Fausti, M. Varasteh A., V. Monaco, R. Sacchi and R. Cirio are with Torino University and Istituto Nazionale di Fisica Nucleare, Torino 10125, Italy (telephone: +390116707326, e-mail: fanolag@to.infn.it, fausti@to.infn.it, varasteh@to.infn.it, vincenzo.monaco@to.infn.it, roberto.sacchi@to.infn.it, cirio@to.infn.it).

F. Marchetto, S. Giordanengo and G. Mazza are with Istituto Nazionale di Fisica Nucleare, Torino 10125, Italy (e-mail: fmarchet@to.infn.it, giordane@to.infn.it, mazza@to.infn.it).

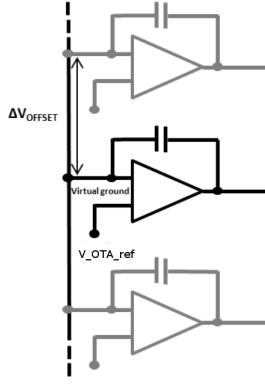

Fig. 2. Schematic of the binding connection of the Operational Transconductance Amplifier (OTA).

In order to measure high intensity beams the chip was set with a quantum charge  $Q_c = 200\text{fC}$ . It was shown [6] that this gain is fairly uniform across the channels, with an r.m.s of the channel-to-channel variation of 1.28%. Also, the channels of the chip were connected in parallel in order to split the input current into several channels; the total input current can be thus reconstructed by adding up the counts measured in each channel. Considering the maximum acquisition frequency of  $\nu_{max} = 20\text{MHz}$ , a single channel saturates at  $I_{sat} = Q_c \times \nu_{max} = \pm 4\mu\text{A}$  and with this configuration it is expected that the maximum input current would increase up to 64-times, before saturation occurs.

Each channel is connected to the common input using a series resistance  $R = 10\text{M}\Omega$ . In fact, the direct connection of two or more Operational Transconductance Amplifier (OTA) inputs would cause the misbehavior of some channels. Referring to Fig. 2, the connection forces the equalization of the input voltages. Small differences between the offsets of the input stages, combined with the OTA high gain, will bring some of them in saturation. However, if high value resistors are connected in series with the inputs before the common input node (see Fig. 3), the channels can work properly as long as the input current is significantly larger than the offset currents needed to keep each OTA input at its correct voltage  $OTA_{ref} + V_{OFFSET}(i)$ . Montecarlo simulations, performed with the Cadence Spectre simulator, have shown an average input offset voltage of  $0.281\text{mV}$ , with a sigma of  $1.763\text{mV}$ . A resistor value of  $10\text{M}\Omega$  will thus result in a maximum offset current of  $\pm 0.56\text{nA}$  in the  $\pm 3$  sigma offset range.

### III. CHIP CHARACTERIZATION

The experimental setup which has been used to characterize the chip, is based on a NI FlexRIO FPGA module DAQ card [7] and on the LabView software [8].

For most of the tests, to inject a precise constant current,  $I_{in}$ , into a given channel, a Keithley 2400 in current generator configuration was used. The current generator was connected with a coaxial cable to an upper board mounted above the test board. This upper board allows to connect in parallel the channels of the chip, each with its own input resistor. Scheme of the setup for the measurements is shown in Fig. 3.

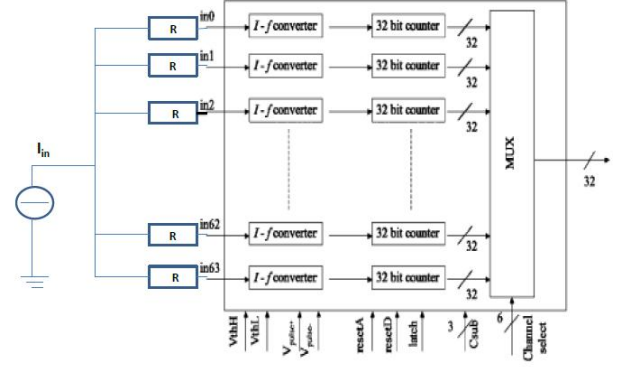

Fig. 3. Setup for the measurements.

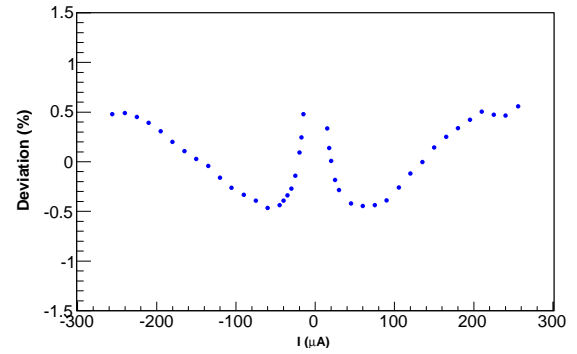
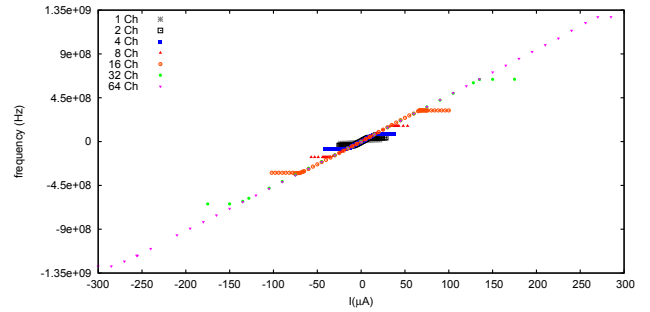

Fig. 4. Linearity of the pulse frequency as a function of the input current (top). Relative deviation from linearity as a function of the input current (bottom).

A small ripple was observed in the current produced by the Keithley 2400; for the determination of the uncertainty of the measurements, a more stable current provided by a battery was used.

#### A. Linearity test

The linearity of the pulse frequency as a function of the input current is shown in Fig. 4 (top) for different number of channels connected in parallel. The input current saturation limit increases as the number of channel  $N$ . The full range of  $\pm 256\mu\text{A}$  is reached for  $N = 64$ . The deviation from linearity is limited to  $\pm 0.6\%$  in the range between  $15\mu\text{A}$  to  $256\mu\text{A}$

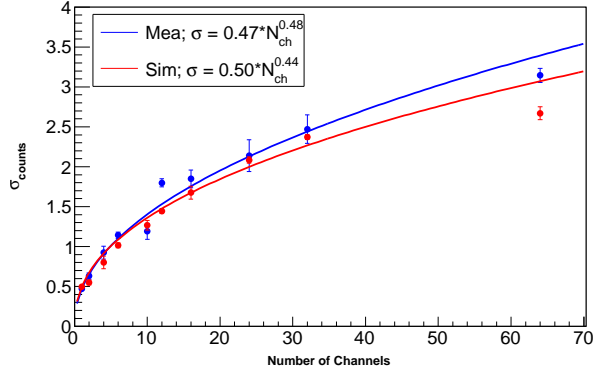

Fig. 5. Simulation (red) and measurement (blue) of the standard deviation of the total counts depending on the number of channels

and  $\pm 1\%$  in the range between  $5nA$  to  $256\mu A$ , which is considered quite acceptable for the application in radiotherapy. In figure 4 (bottom), the relative deviation from linearity as a function of the input current is shown.

### B. Resolution

To study the resolution, we determined the average value of the input current and its standard deviation for a time interval acquisition of 1ms. The measurements were performed as a function of the number of the channels connected in parallel.

Assuming that the counting rate of one channel, at a fixed input current, is not statistically correlated with the counting rate of the other channels, it is expected that the dependence of the standard deviation of the total number of counts on the number of channels equals to  $\sigma = \sigma_{1ch} \times \sqrt{N_{ch}}$ , where  $\sigma_{1ch}$  it is expected to be half a count. In order to test this assumption, a simple simulation of the behavior of the readout was developed to predict the statistical fluctuation in the number of counts for a given time interval as a function of the number of channels bounded together. The channels are modeled as statistically uncorrelated counters, the only correlation being the charge conservation, i.e. the sum of the currents integrated in each channel should equal the input current. The input impedances and the gains of the channel are assumed to randomly vary between channels by  $\pm 2\%$  and  $\pm 1\%$  respectively, and the initial charge integrated in each channel is sampled with uniform probability between 0 to the charge quantum  $Q_c$ . Then we verified this predicted behavior by measuring the standard deviation with the test setup. The comparison between the simulation and the measurement is shown in Fig. 5.

### C. Rest distributions

The distribution of the rest of the ratio between the total number of counts and an integer number allows to verify that the contribution of each channel to the total number counts is uncorrelated with the contribution of the other channels. If each channel counts independently, the rest of the division by N of the number of counts, obtained after any given data acquisition time, will be an integer number between 0 and N-1

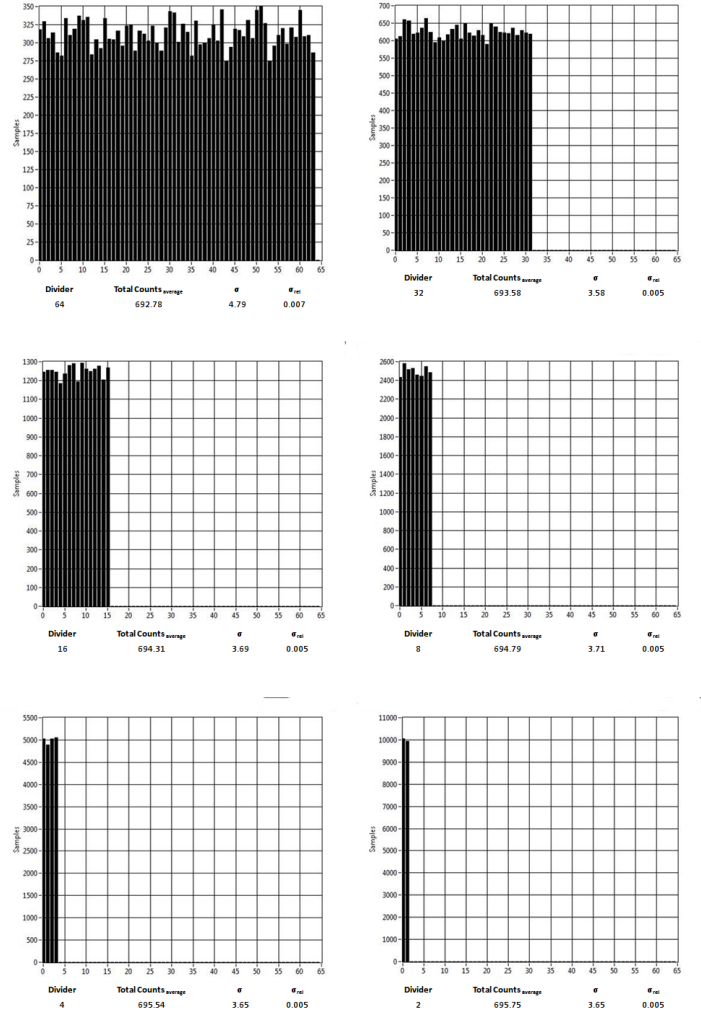

Fig. 6. Rest distribution of the number of counts divided by 64, 32, 16, 8, 4 and 2.

with a uniform probability distribution. On the other hand, if there are some recurring structures in the rest distribution, it means that some channels are correlated.

Fig. 6 shows the histogram of the rest values obtained from a large number of readout iteration loops. It can be seen that the rest distribution does not indicate structures with higher probabilities than others, suggesting that no correlation occurs in the readout between channels.

## IV. CONCLUSIONS

Evolvements of the accelerators for radiotherapeutic treatments with charged particles call for an increase of the accepted input current of the front-end electronics.

The behavior of an integrated 64-channel device in CMOS  $0.35\mu m$  technology developed by INFN and Torino University was characterized with the parallel connection of the channels in order to overcome the problem of current saturation in high intensity regime.

The measurements of the linearity of current-to-frequency of counts conversion shows a good linearity in a range up

to  $\pm 250\mu\text{A}$  when all 64 channels are connected to the same input.

The resolution of the readout was compared to the results of a Monte Carlo model that assumes that all the channels are behaving independently; a very good agreement was found.

The increase of the uncertainty is however contained and the linearity over the increased range is found to be within 1%, that is considered acceptable for the application in radiotherapy.

#### REFERENCES

- [1] M. Dunne, "Laser-driven particle accelerators", *Science* 21 April 2006: Vol 312 no 5772 pp. 374-376, doi: 10.1126/science.1126051, and references therein.
- [2] G.A.P. Cirrone et al., *Proc. SPIE 8779, Laser Acceleration of Electrons, Protons, and Ions II; and Medical Applications of Laser-Generated Beams of Particles II; and Harnessing Relativistic Plasma Waves III*, 87791 (May 9, 2013); doi: 10.1117/12.2026530, and references therein.
- [3] U. Amaldi et al., *NIMA*, Vol.620 (2-3), p.563-577, 2010.
- [4] W. Kleeven et al., "The IBA Superconducting Synchrocyclotron Project S2C2", *Proceedings of Cyclotrons'13 (20<sup>th</sup> International Conference on Cyclotrons and Their Applications)*, September 16-20, 2013, held in Vancouver, Canada.
- [5] B. Qin, Y. Mori, *NIMA*, Vol.648 (1), p.28-34, 2011.
- [6] A. La Rosa, et al., *Nuclear Instruments and Methods in Physics Research. A* 583 (2007) 461-468.
- [7] <http://www.ni.com/pdf/manuals/373047b.pdf>.
- [8] <http://www.ni.com/labview/>.