

Planning and operation of two small SDH plants as test site: Comparison between flat plate and vacuum collectors

Original

Planning and operation of two small SDH plants as test site: Comparison between flat plate and vacuum collectors / Degiorgis, Luca; Noussan, Michel; Jarre, Matteo; Poggio, Alberto. - ELETTRONICO. - (2016). (Intervento presentato al convegno 4th International Solar District Heating Conference tenutosi a Billund (Denmark) nel 21,22 September 2016).

Availability:

This version is available at: 11583/2650759 since: 2016-09-26T10:07:50Z

Publisher:

Published

DOI:

Terms of use:

This article is made available under terms and conditions as specified in the corresponding bibliographic description in the repository

Publisher copyright

(Article begins on next page)

PLANNING AND OPERATION OF TWO SMALL SDH PLANTS AS TEST SITE: COMPARISON BETWEEN FLAT PLATE AND VACUUM COLLECTORS

Luca Degiorgis, Michel Noussan, Matteo Jarre, Alberto Poggio

Department of Energy, Politecnico of Torino,
C.so Duca degli Abruzzi 24, 10125, Torino, Italy.
Phone number: +39 011 0904529; +39 3493566826;
e-mail address: luca.degiorgis@polito.it

Abstract – A small solar district heating plant has been built to provide heat to an existing district heating system supplied by natural gas CHP units. This test site, located at 1,600 m a.s.l., allows comparing the performances of evacuated solar collectors (ETC) with flat plate double glazed ones (FPC) in a mountain environment. The preliminary results of the first months of operation show a better performance of ETC than FPC. The daily heat production shows a good correlation with available radiation, with the FPC having a slightly larger variability. Moreover, while ETC system efficiency is comparable with the theoretic curve, the FPC system efficiency show lower values. The monitoring of the SDH is still ongoing, and some control logics of the system are being performed in order to optimize the heat production from FPC. The specific electricity consumption for pumping is in the range 5 – 20 kWh_{el}/MWh_{th}, in accordance with usual literature values. The specific pumping consumption decreases with increasing daily heat production, and no significant difference arises from the trends of the two systems.

1. INTRODUCTION

Solar district heating (SDH) systems are widely used in different countries in Europe (e.g. Denmark, Germany, Austria), while in others these systems are currently still under development. In Italy the first SDH system has been built last year in Varese.

This paper presents the operational analysis of two small solar collector fields connected to an existing DH system in a mountain village. The two fields have been built as test plants to monitor the performance of Double Glazed Flat Plate solar collectors (FPC) and Evacuated Tubes solar collectors (ETC).

The two main challenges are the weather conditions of the site (with a lower average outdoor temperature but at the same time a higher radiation w.r.t. traditional sites at the same latitude) and the higher temperatures of the DH network with respect to other SDH systems.

2. TEST SITE DESCRIPTION

2.1 Location

The existing plant is located in an alpine village, in the Susa Valley, 100 km North of Torino (ITA), at approximately 1,600 m above sea level. The village is a ski resort, and the buildings connected to the district heating net are mainly holiday houses and hotels.



Figure 1 – SanSicario: view from W (Google Maps)

The FPC solar system will be installed on a dedicated wood structure over the heat rejection system and the ETC will be installed on the existing roof of the building that hosts the thermal generators (internal combustion engines and boilers) and the pumping system for the DH network.



Figure 2 – Cogeneration Station and surroundings

2.2 Weather conditions

The weather conditions of the site are quite different from the ones usually considered for similar latitudes. The altitude has consequences both on outdoor temperature and available solar radiation. Moreover, the presence of the snow on the ground during the last month of winter and spring causes a significant increase of the albedo of the surrounding mountains. Figure 3 shows the average outdoor temperature and daily solar radiation in some locations nearby (year 2015, data from [1]). The temperature of Torino (the larger nearby city at the same latitude) is also reported as a dotted line for comparison.

Apart from the local temperature near the substations there were no measurements of weather conditions at the test site location, before the planning of the solar plant. A weather station has been installed on-site since January 2016, as described in Section 3.

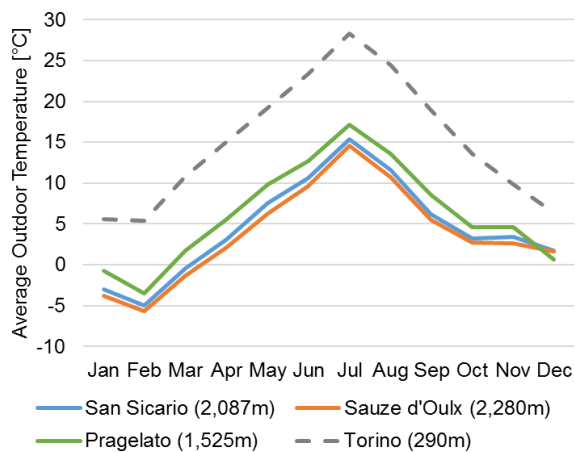

Figure 3 – Average outdoor temperatures for some locations in the Piedmont Region.

2.3 Solar collectors and generation system

Two solar collector systems have been installed to check and eventually compare the performances, in terms of thermal production, installation cost, maintenance, life duration and behavior in snow conditions.

Due to the particularly sensitive local environment (in Italy, above 1600 m a.s.l. a special legislation for environment protection is active), a long authorization process has been carried out. To obtain the permission from the local municipality and the Region, and keeping in consideration the ownership of the surrounding land parcels, it has been stated to install the solar systems on the roof and above the heat rejection system of the plant.

To maximize the available area for solar collectors, the two systems have been splitted:

- The evacuated tube are installed on the tilted roof of the building;
- The flat plate collectors are installed on a dedicated wood structure.

Both systems have the same orientation facing South (-20° W); the ETC system is parallel to the existing

pitched roof¹, with a tilt angle of 22° (from the horizontal); the FPC are installed with a tilt angle of 35°, to help the snow slip.

FPC are large collectors, with meander absorber, 7,9 m² gross area each. Three collectors are installed, for a total gross surface of 23,7 m² and an aperture area of 22,26 m². Due to the fact that the air temperature during winter can be extremely low (the average month temperature during January and February is below 0°C) and, at the same time, the flow temperature of the district heating network will raise to approx. 90°C, double glazed collectors with high insulation on the rear side are used.

The collectors are made with an aluminum frame, two layers of 3,2 mm tempered solar safety anti-reflective glass (95% of light transmittance), 70 mm of mineral wool as insulation on the rear and lateral surfaces, an aluminum absorber with high selective coating (95% absorption, 5% emission), 28 mm diameter copper manifolds and 8 mm diameter copper risers.

The collectors are installed in parallel, and are connected to a pumping station, with copper and corrugated inox piping.



Figure 4 – FPC installed



Figure 5 –FPC Pumping and heat transfer station

¹ Even if a increased tilt angle will be useful for snow slip, a local normative prohibit solar installations with orientation and tilt different from the roof ones: the collectors must be installed in adherence to the slope.

A heat exchanger is used to separate the solar circuit to the district heating network, high efficiency solar pumps are used. An overall maximum flow of 28,5 l/m² is defined, to balance the temperature raise in the collector loop, due to high return temperature from the DH, and to minimize the electric consumption for pumping. Primary and secondary side pumps are separately speed controlled. The fluid used in the solar loop is a mixture of water and an antifreeze fluid for solar thermal plants, based on propylene-glycol; at 50% in mixture the plant is protected from freezing until temperature of -32°C. The viscosity of the fluid is higher than that of pure water (@ 50% of antifreeze and water and 70°C, viscosity is 1,9 mm²/s, compared to 0,5 mm²/s) and specific heat capacity is lower (3.700 kJ/kgK, at 70°C). From the data sheet of the producer it is also possible to appreciate a 20% increase in pressure losses in piping, for the same mass flow, compared to pure water [2]. Evacuated tube collectors use the Dewar (or Sydney) technology for the glass: this is constructed as a thermos flask, with double walled concentric glass soldered together. Air is extracted from the internal volume and a selective surface is coated on the external glass surface of the inner tube: in such a way it is also protected from aging. A “U” pipe with steel fin is used to remove heat from the evacuated tubes. The solar collectors used are made with 21 tubes each, behind whom a highly reflective surface, parabolic shaped, is installed (Compound Parabolic Concentrator – CPC). This guarantees that as few tubes as possible are needed per unit area and yet the gross area is optimally used.



Figure 6 – ETC installed on the roof

Single collectors have a gross area of 4,94 m²; two rows of 4 collectors each are installed, for a total gross area of 39,28 m² and an aperture area of 36 m². The solar loop uses only water as a fluid and a dedicated controller is necessary to turn on the pumps to prevent freezing. A heat exchanger is used to separate hydraulics loops from solar to district heating piping, to preserve DH from potential leakage of the solar system and to separate the pressures in the circuits. Solar

components are tested for maximum pressure of 10 bar [3].

		FPC	ETC
Gross area	m ²	7,91	4,91
Aperture area	m ²	7,42	4,5
Net area	m ²	7,41	n.d.
Empty weight	kg	202	72
Liquid content	l	6,81	3,79
Dimensions LxBxH	mm	3557x2224 x135	2430x2030 x120
Max working pressure	bar	10	10
Stagnation temperature	°C	218	301
Recommended flow rate	l/m ² h	10-25	n.d.
η_0		0,814	0,644
a_1	W/(m ² K)	2,102	0,749
a_2	W/(m ² K ²)	0,015	0,005

Figure 7 –technical data of the FP and ET collectors

2.4 Existing District Heating System

The existing DH network is currently supplying heat to around 350,000 m³ of residential buildings, with an annual net production of 21,120 MWh. The larger part of the buildings are holiday houses and hotels, and therefore the consumption patterns can show different behaviors during the winter, depending on the day of the week.

The specific consumption is 60 kWh/m³, mainly due to the critical weather conditions of the site (1,600 m a.s.l. and 4,775 degree-days).

The DH network has a length of almost 5 km, and the operating temperatures are related to the season, reaching the nominal values of 95-65 in winter.

The heat generation is totally based on natural gas, with three natural gas engines (total power: 3 MW_{el} and 3.6 MW_{th}) and auxiliary heat boilers with a total capacity of 10.3 MW_{th}.

The total annual heat generation is 23,573 MWh, with approximately 10% of network losses. The share of heat provided by engines is 86%, which are also generating 16,135 MWh_{el} of electricity. The total gas consumption of the site is 45,054 MWh, and the average efficiencies are 0.88 (0.39 electric and 0.49 thermal) for the engines and 0.92 for the boilers (operation data from [4]).

3. METHODOLOGY

3.1 Available measurements

The site has been equipped with a meteorological station that can measure and log values, every 10 minutes, of outside temperature, humidity and pressure, wind speed and direction, rain rate. A solar radiation sensor measures global radiation (diffuse + direct), using

a silicon photodiode with spectral response from 400 to 1100 nanometers². The station can measure and calculate solar irradiance (W/m²) and integrates the irradiance values to display total incident energy over a period of time (Wh/m²). The sensor is provided with calibration against a secondary standard pyranometer [5].

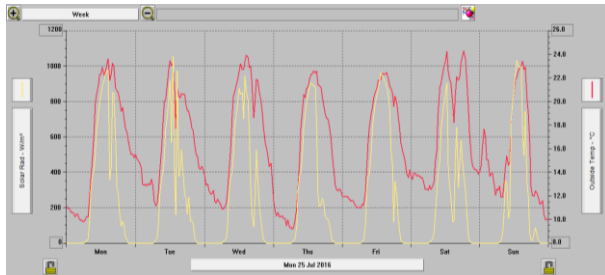

Figure 8 – meteorological data display

The controllers of both solar installations are equipped with a data acquisition and monitoring system.

In principle the monitored values are the same for FPC and ETC:

- Solar collector temperature;
- Return temperature from DH, before solar input
- Solar loop, heat exchanger, in;
- Solar loop, heat exchanger, out;
- Secondary side, heat exchanger, in;
- Secondary side, heat exchanger, out;
- Flow temperature to DH, after solar input;
- Volume flow in the solar loop;
- Speed solar pump %;
- Speed secondary side pump %;
- Heat quantity

Data are acquired and logged every minute for FPC and every 5 minutes for ETC.

Temperature probes are Pt1000 and Pt500 ones, and volume flow meter for FPC is based on Hall effect (magnetic).

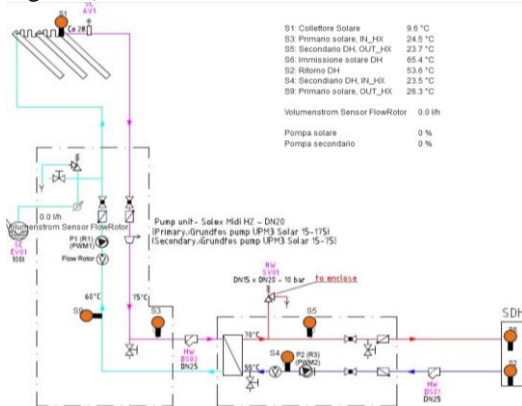

Figure 9 – layout of FPC and probe position

² This will lead to the impossibility to measure the total extent of solar radiation (250 -2500 nm), but the cost is lower than a thermocouple pyranometer.

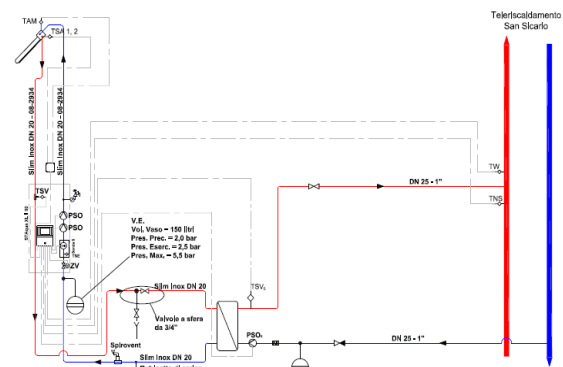

Figure 10 – layout of ETC and probe position

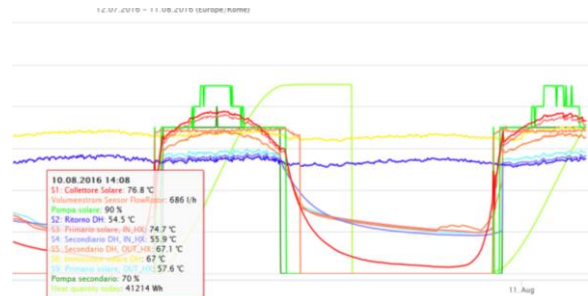

Figure 11 – example of data display for FPC

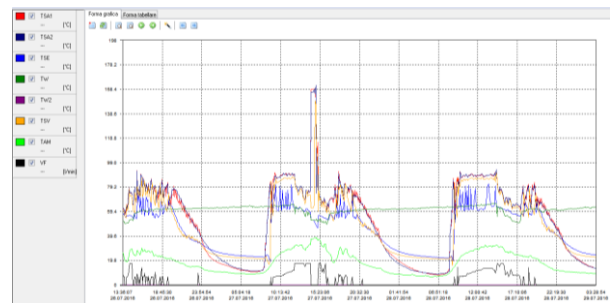

Figure 12 – example of data display for ETC

On the secondary side of the two solar systems (water), an ultrasonic flow meter is installed, equipped with inlet and flow temperature probes and an integration control unit. The overall equipments are MID certified in Class M1.

A power meter is installed for each solar system, to measure the electric energy for the functioning (pumping, valves and controller).

All the data from meteorological station, FPC controller, ETC controller and heat and power meters are equipped with a local memory and/or data can be remotely downloaded.

3.2 Performance analysis of solar collectors

The performance of the two solar collector fields has been calculated based on the available measurements of temperatures, volumetric flows and solar radiation (described in the previous section).

The characteristics of the fluid of the FPC system have been obtained from the datasheet of the specific mixture (50% water/50% Tyfocor®L [2])

The main quantities used for the performance evaluation are the specific heat production and the conversion efficiency.

The specific heat production has been calculated by dividing the heat produced by each of the systems by the gross aperture area of the panels. This choice has been made in order to account for the surface needed for the collector installation.

The conversion efficiency has been calculated by dividing the specific heat production by the available solar radiation (described in detail in section 3.4).

3.3 Pumping consumption

An additional aspect that is seldom considered is the power consumption of the pumping system of the collector field.

Two power meters have been installed in the two collector fields in order to compare the electricity consumption per unit of heat produced by solar systems. The meter data are currently stored on a daily basis, allowing to perform some average analysis based on the different daily operation of the two systems.

3.4 Radiation

The available radiation has been measured on site with a dedicated weather station. The station has been installed in January 2016, and therefore the data currently available are limited to the months of the current year. The station has measured the total solar radiation on the horizontal plane. Figure 13 shows a comparison with two other weather stations in nearby locations operated by ARPA Piemonte[1]. The figure is related to three days in last June (9-11 June 2016). The chart shows that the solar radiations are basically comparable, with some differences that can be related to the presence of clouds.

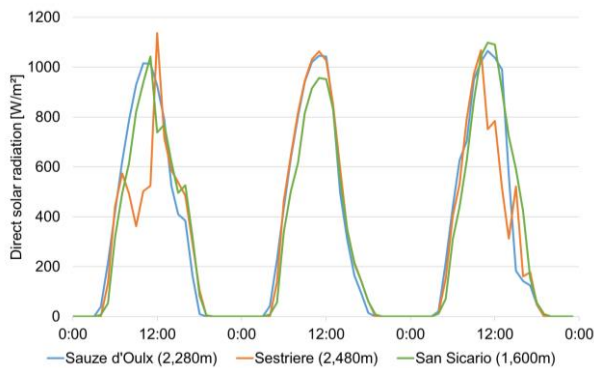

Figure 13 – Direct solar radiation for some sites compared with the test site (9-11 June 2016).

The horizontal radiation has been corrected by considering the actual slope and azimuth of the solar collectors, in accordance with the procedure in the Italian Standard UNI 8477 [6].

This correction considers monthly values, and it is therefore an approximation of the actual radiation on an inclined surface. This approximate correction could add a slight alteration in the hourly results, while the daily values should not be significantly. Moreover, the summer months are the less affected by this correction, especially in the central hours of the day that show higher radiation.

4. RESULTS

4.1 Heat production

The first output of the analysis is the heat production, which has been related to the available radiation. Figure 14 shows the daily specific heat production of the two collector fields with respect to the daily available radiation. The FPC had a low production in the first months of the summer, and therefore their operation settings have been deeply investigated. Thanks to the monitoring it has been possible to correct the operation problems (on 10th August) and therefore obtain a higher performance of the modules.

The same behavior, on an hourly basis, is reported in Figure 15: in this chart, it is possible to notice an increase in performances after the optimization actions, for the FPC system. With the new settings, the FPC show a performance close to the ETC.

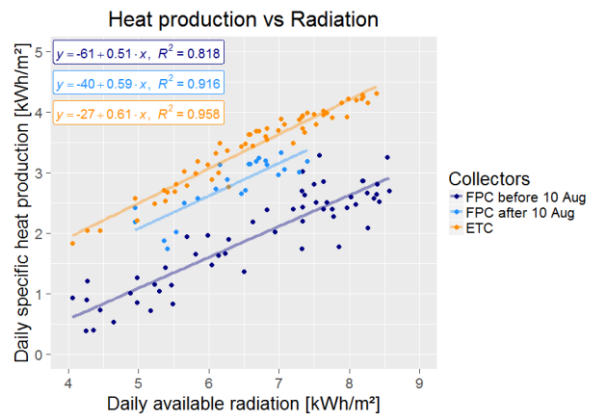

Figure 14 - Daily heat production vs Radiation

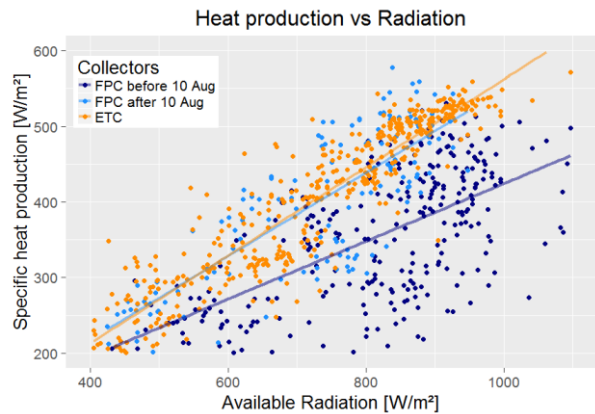

Figure 15 - Hourly heat production vs Radiation

4.2 Solar field efficiency

The efficiency of the solar field with respect to the theoretic behavior is shown in Figure 16.

It is necessary to underline that the performance test is related to the single collector, while we measure the overall performances of the entire system: collectors, piping and heat exchanger. The volume flow in the test is 72 l/h m^2 for both systems, while in field site the volume flow is variable and reaches a maximum of 28 and 21 l/hm^2 , respectively for FPC and ETC. These deviations can negatively affect the measured results.

The ETC field shows a good performance, generally in line with the expected efficiency [7]. Some points are higher than the curve, but some inertia phenomena could have affected the data measurement. In particular, in some cases the system had some stagnation due to maintenance needs, reaching up to 270°C .

The FPC seems to have a generalized lower performance. The solid blue line represents the tested efficiency [8], while the dotted line accounts for the lower performances of the glycol mixture with respect to pure water. In some hours the collectors reach the expected performance, but the general trend is lower.

The optimization of the control settings held from the 10th August has led to an increase of performance of the FP collectors.

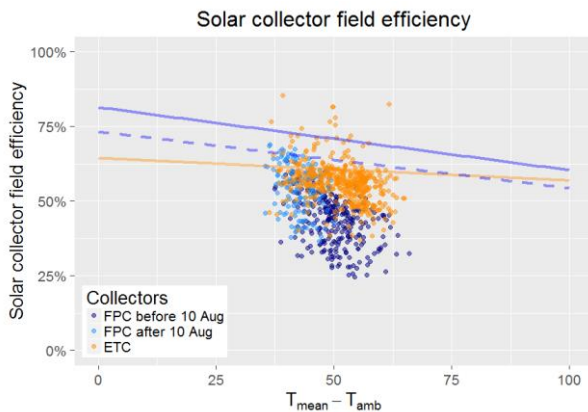

Figure 16 – Solar collector field efficiency

Main optimizations are still under test, but it has been possible to notice that the operation temperature of the FPC system was higher than needed, and that starting time of the FPC pump was late with respect of the ETC. Volume flow increase, modifications in the speed modulation of the pumps, reduction of temperature difference between collectors and district heating flow, forced start/stops of the solar pump in the morning have been implemented and their fallout are still under measurement.

Figure 17 shows the trend of collector temperature, where it is possible to appreciate the general reduction of the temperature, from first days of July, to the end of August, still in accordance with the requested flow temperature to DH.

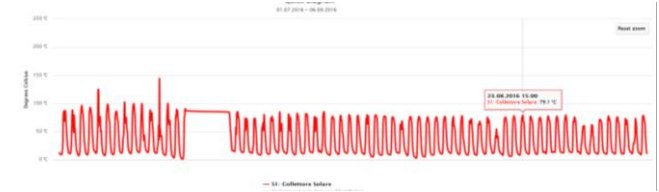

Figure 17 – Reduction of T coll

4.3 Electricity consumption for pumping

Finally, an analysis on the daily electricity consumption of the two systems has been performed (see Figure 18). In accordance with literature values, the average consumption is in the range $5 - 20 \text{ kWh}_{el}/\text{MWh}_{th}$, quite similar for the two systems. The ETC have generally a different distribution of the points (being their productivity generally higher) but the trend appears to be comparable, even if slightly lower.

These results are based on a daily reading of the meters performed each day at noon by the plant operator. As a result, the daily values for heat production of the solar panels are not directly related to the previous ones (i.e. their aggregation is shifted by 12 hours).

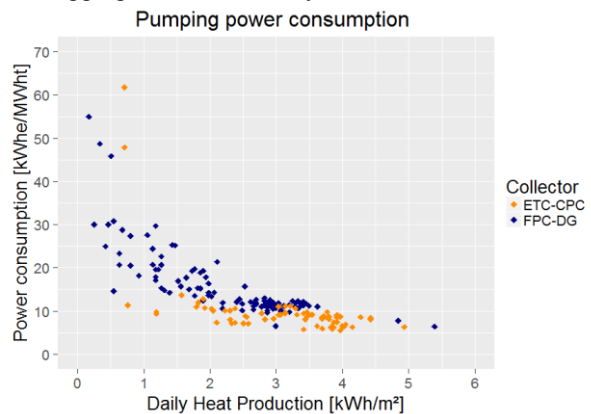

Figure 18 – Pumping power consumption

The results presented in the previous charts show some correlations between heat production and available radiation. However, the dispersion of the points suggest that some other variables have an impact on the solar collectors' heat production (e.g. outdoor temperature, radiation direction, wind, etc.), and a proper setting of the control system is fundamental to obtain the maximum performances. The remote data logging system is extremely useful to analyze trends and the effects of settings change. In particular, it has been essential to define the optimization of the FPC system and to have a feedback of the implemented modifications to the control system.

However, the amount of monitoring data is currently too low to perform further correlations. The availability of operation data over a larger time span and a broader range of weather conditions will allow carrying a wider analysis with an increased statistical significance.

5. CONCLUSIONS

This study has been focused on the operation analysis of two types of solar collectors in an existing DH system. The performance of ETC and FPC has been compared based on the heat produced with respect to available solar radiation.

The ETC show a better performance, with specific heat productions up to 500-600 W/m² on hourly basis and conversion efficiencies near to the theoretic curve.

The FPC have had a lower performance than expected in the beginning of its operation. Thanks to the monitoring activity it has been possible to try different operational solutions to fix the problem, and the production of the collectors is now close to that of the ETC field.

This result confirms the importance of performance monitoring in energy system, which is a key aspect to verify the actual energy production with respect to the performance expected from design.

REFERENCES

[1] ARPA Piemonte, "Banca dati meteorologica," [Online]. Available: <http://www.arpa.piemonte.gov.it>.

[Accessed 08 2016].

- [2] TYFOROP CHEMIE GmbH, "Tyfocor® L - Technical information," 2009.
- [3] D. CERTCO, "Summary of EN 12975 Test Results, annex to Solar Keymark Certificate, n. 011-7S089 R," DIN CERTCO, Berlin, 2015.
- [4] AIRU, "Il Riscaldamento Urbano - Annuario 2015".
- [5] DAVIES, "Solar Radiation Sensor 6450," Davis Instruments, Hayward, CA, 2010.
- [6] Ente Nazionale Italiano di Unificazione, "UNI 8477 - Energia solare. Calcolo degli apporti per applicazioni in edilizia. Valutazione dell' energia raggianti ricevuta.," 1983.
- [7] TÜV Rheinland, "Summary of EN12975 Test Results, annex to Solar KEYMARK Certificate - Licence Number 011-7S089R," 2015-11-30.
- [8] TÜV Rheinland, "Summary of EN12975 Test Results, annex to Solar KEYMARK Certificate - Licence Number 011-7S2565F," 2015-08-28.