

Linear Electromechanical Actuators Affected by Mechanical Backlash: a Fault Identification Method Based on Simulated Annealing Algorithm

Original

Linear Electromechanical Actuators Affected by Mechanical Backlash: a Fault Identification Method Based on Simulated Annealing Algorithm / DALLA VEDOVA, MATTEO DAVIDE LORENZO; Lauria, D.; Maggiore, Paolo; Pace, Lorenzo. - In: WSEAS TRANSACTIONS ON SYSTEMS. - ISSN 1109-2777. - ELETTRONICO. - 14:(2015), pp. 268-277.

Availability:

This version is available at: 11583/2642535 since: 2016-05-18T00:43:57Z

Publisher:

World Scientific and Engineering Academy and Society

Published

DOI:

Terms of use:

This article is made available under terms and conditions as specified in the corresponding bibliographic description in the repository

Publisher copyright

(Article begins on next page)

Linear Electromechanical Actuators affected by Mechanical Backlash: a Fault Identification Method based on Simulated Annealing Algorithm.

M. D. L. DALLA VEDOVA, D. LAURIA, P. MAGGIORE, L. PACE

Department of Mechanical and Aerospace Engineering

Politecnico di Torino

Corso Duca degli Abruzzi 24 – 10129, Turin

ITALY

matteo.dallavedova@polito.it

Abstract: - Several approaches can be employed in prognostics, to detect incipient failures of primary flight command electromechanical actuators (EMA), caused by progressive wear. The development of a prognostic algorithm capable of identifying the precursors of an electromechanical actuator failure is beneficial for the anticipation of the incoming faults: a correct interpretation of the fault degradation pattern, in fact, can trigger an early alert of the maintenance crew, who can properly schedule the servomechanism replacement. The research presented in this paper proposes a fault detection / identification technique, based on approaches derived from optimization methods, able to identify symptoms of EMA degradation before the actual exhibition of the anomalous behavior; in particular, the authors' work analyses the effects due to progressive backlashes acting on the mechanical transmission and evaluates the effectiveness of the proposed approach to correctly identify these faults. An experimental test bench was developed: results show that the method exhibits adequate robustness and a high degree of confidence in the ability to early identify an eventual fault, minimizing the risk of false alarms or not announced failures.

Key-Words: - Mechanical Backlash, Electromechanical Actuator, Prognostics, Simulated Annealing Algorithm.

1 Introduction

Actuators are devices capable of operate conversion of mechanical, electrical, hydraulic, or pneumatic power into mechanical power. In aircraft, actuators are commonly used for flight control surfaces and various utility systems. Flight control systems are considered flight critical and, although highly redundant, must meet reliability requirements of less than one catastrophic failure per 10^5 flight hours for the F-18 strike fighter and one per 18×10^6 flight hours for F-35AB [1]. Unanticipated and extreme operating scenarios are a major cause of unscheduled maintenance events, which may result into serious operational issues in terms of safety, mission completion, and cost. Often, when a monitor registers a fault, there is no information regarding the real cause and effect relationship between the failure mode and failure itself. All that is known is that a failure has occurred. Therefore, the identified need is for a robust health management solution capable of accurate and reliable early fault detection and failure prediction, covering multiple failure modes for flight control actuators (this is typically known as Prognostic and Health Management system or, in short, PHM) [2].

It must be noted that, typically, PHM is easier to implement on the electric actuators since no additional sensors are required, as the same sensors used to the control scheme and system monitors are also used in many PHM algorithms [2]. Enormous economic (maintenance and logistics) benefit is expected with the advance of the state of fault detection to failure prognosis for actuator systems, as high Can Not Duplicate (CND - inability to replicate field failures during lower level maintenance assessment) rates still plague many aircrafts. From collected field analyses, CND failures can make up more than 85% of all observed field failures in avionics and account for more than 90% of all maintenance costs. These statistics can be attributed to a limited understanding of root cause failure characteristics of complex systems, inappropriate means of diagnosing the condition of the system, and the inability to duplicate the field conditions in the lower level test environment [3]. Since the prognostic activities typically involve systems having a complex non-linear multidisciplinary nature, the fault detection and evaluation strategies proposed in the literature are various and extremely different each other.

For instance, during these years have been proposed model-based techniques based upon the direct comparison between real and monitoring system [4], on the spectral analysis of well-defined system behaviors (typically performed by Fast Fourier Transform FFT) [5], on appropriate combinations of the first two methods [6-7] or on Artificial Neural Networks [8]. The present work reports the results of a research activity focused on the diagnosis model-based approach and, in particular, on the parametric estimation task, having as a primary objective the design of a modern and fast damage estimator routine for a simple electromechanical actuation system. In particular, it is centered on the improvement of a developing method through the possibility to consider effectively the impact of mechanical backlash (BLK). The paper starts with the presentation of the intended objectives (Section 2), then provides an overview of the SA algorithm, used for the optimization (Section 3); Section 4 describes the considered EMA system, which numerical model is provided in Section 5; finally, in Section 6, the proposed prognostic algorithm is described and validated through experimental data.

2 Aims of Work

The aim of this work is to improve the EMA Numerical Model proposed by the authors in [9] and develop it into a PHM approach able to consider the impact of backlash variations on the EMA behavior. The proposed fault detection/identification process is achieved through the following steps:

1. define the optimization algorithm used for the parameter estimation task;
2. set up a real actuation system meeting as much as possible the aeronautical requirements and being capable of responding to different types of signals (step, sinusoidal, random sequence, ramp) as well as recording significant data (velocities, position, current);
3. build and validate a dedicated Matlab-Simulink numerical model of the considered actuation system (it must be noted that the aforesaid model, having to be run several times in the process of identification and evaluation of faults, must represent a compromise between the most reduced calculation effort and a satisfying representativeness of the actual EMA behaviors);
4. simulate different EMA fault conditions;
5. test the damage estimator in order to evaluate its speed and reliability on the simulated faulty response of the system.

In particular, this paper shows the results obtained applying the proposed prognostic method to an EMA affected by different level of backlashes acting on the mechanical transmission.

3 Optimization Algorithm

Different optimization techniques are commonly used also for model parameter estimation tasks. They can be divided into two main groups: deterministic (direct or indirect) and probabilistic (stochastic, as Monte Carlo method, simulated annealing and genetic algorithms). Most methods, are local minima search algorithms and often do not find the global solution. As a result, they are highly dependent on good initial guesses. While this is a viable solution in an off-line scenario, where initial guesses can be reiterated, these approaches are not suitable for an on-line automated identification process because a good initial guess for one data set may not be for the next identification. These approaches would not be robust and may provide a false indication of parameter changes in an on-line system. Alternatively, global search methods, such as genetic algorithms (GA) and simulated annealing (SA), are much better options for on-line model identification [10-11]. However, similarly as the simplest methods, GA does not always find the global minima [12]. Simulated annealing methods are more effective at finding the global minima, but at the cost of many more iterations [2].

The simulated annealing method originates, as the name suggests, from the study of thermal properties of solids (Metropolis et al. 1953 [13]). The Metropolis procedure was then an exact copy of the physical process which could be used to simulate a collection of atoms in thermodynamic equilibrium at a given temperature. In fact, the abstraction of this method in order to allow arbitrary problem spaces is straightforward. As reported in [14], there is a significant correlation between the terminology of thermodynamic annealing process (the behaviour of systems with many degrees of freedom in thermal equilibrium at a finite temperature) and combinatorial optimization (finding global minimum of a given function based on many parameters). A detailed analogy of annealing in solids provides frame work for optimization; in fact, the SA procedure copies the aforementioned physical process which could be used to simulate a collection of atoms in thermodynamic equilibrium at a given temperature. Indeed, the abstraction of this method in order to allow arbitrary problem spaces is straightforward. Table 1 shows the analogies between the physical process and the simulated one.

Thermodynamic Annealing	Combinatorial Optimization
System State	Feasible Solutions
Energy of a State	Cost of Solution ¹
Change of state	Neighbor solution ²
Temperature	Control parameter ³
Minimum Energy	Minimum Cost

Table 1: Association between physical thermodynamic simulation and combinatorial optimization

The operating logic of the SA algorithm and the way in which, at each iteration of calculation, it is evaluated the new state of the system (i.e. a new solution of the aforesaid optimization process) is schematically shown in Fig. 1

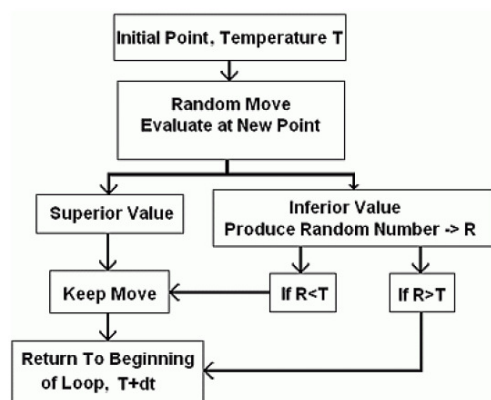

Fig. 1: Operating Logic of SA Method.

At a given temperature and energy, a new nearby geometry $i + 1$ is generated in each iteration as a random displacement from the current geometry i . The energy of the resulting new geometry is then computed and the **energetic difference** ΔE is determined with respect to preceding energy as:

$$\Delta E = E_{i+1} - E_i. \quad (1)$$

The probability that this new geometry will be accepted is:

$$P(\Delta E) = \begin{cases} e^{-\Delta E/(k_B T)} & \text{if } \Delta E > 0, \\ 1 & \text{if } \Delta E < 0 \end{cases} \quad (2)$$

1 The cost of a solution represents the corresponding objective function value (i.e. the function that the optimization algorithm attempts to minimize in order to identify the optimal solution).

2 A new system solution calculated by the optimization algorithm and evaluated, with respect to the previous one, using the said cost functions.

3 The system parameters iteratively modified by the optimization process so as to minimize its objective function.

This means that, if the new nearby geometry has a lower energy level (successful iteration), the transition is accepted. Otherwise (unsuccessful iteration), a uniformly distributed random number more or equal than 0 and less than 1 is drawn and the step will only be accepted in the simulation if it is less or equal the Boltzmann probability factor, i.e. $r \leq P(\Delta E)$. After a certain number of steps at the same temperature T , the latter is decreased following the specified cooling schedule scheme. It is worth noticing that the temperature does not take part directly to the optimization itself, but it acts merely as an exploration parameter. As at high temperatures T the factor $P(\Delta E)$ is very close to 1, most likely many up-hill steps are accepted, even if they are unsuccessful. In this way, a wide exploration of the search space can be performed (this is the main feature of this algorithm). Subsequently, as the temperature falls off, the search is confined in a more limited space since Boltzmann factor $P(\Delta E)$ collapses to very low values, thus decreasing the acceptance probability in case of $\Delta E > 0$ (the algorithm becomes more selective). Finally, the global optimum should be found as soon as the temperature reaches its minimum value but, in practice, reannealing is performed, raising the temperature after a certain number of new points have been accepted so that the search starts again at the higher temperature. Basically, it avoids be caught in local minima [9].

4 Actuation System

Until a few years ago, the actuators mainly used in aeronautical applications were generally hydraulic and precisely hydro-mechanical or, more recently, electrohydraulic. This kind of actuator, because of its great accuracy, high specific power and very high reliability, is often equipped on current aircrafts, even if on more modern airliners electrohydrostatic actuators (EHA) or electro-mechanical actuators (EMA) are installed. Especially in the last years, the trend towards the all-electric aircrafts brought to an extensive application of novel optimized electrical actuators, such as the electromechanical ones (EMA). To justify the fervent scientific activity in this field and the great interest shown by the aeronautical world, it must be noticed that, compared to the electrohydraulic actuations, the EMAs offer many advantages: overall weight is reduced, maintenance is simplified and hydraulic fluids, which is often contaminated, flammable or polluting, can be eliminated.

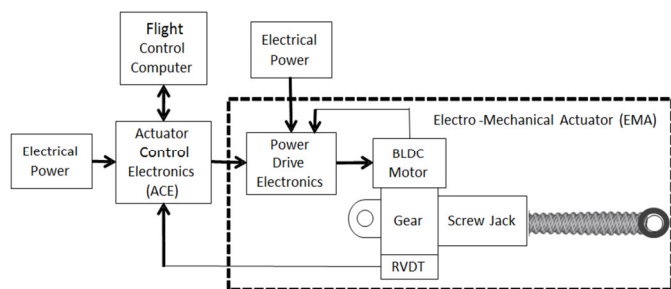

Fig. 2: Electromechanical actuator scheme.

As shown in Fig. 2, a typical EMA for primary flight control is composed by:

1. an actuator control electronics (ACE) that closes the feedback loop, by comparing the commanded position (FBW) with the actual one, elaborates the corrective actions and generates the reference current I_{ref} ;
2. a Power Drive Electronics (PDE) that regulates the three-phase electrical power;
3. an electrical motor, often Brushless Direct Current (BLDC) type;
4. a gear reducer having the function to decrease the motor angular speed (RPM) and increase its torque to desired values;
5. a system that transforms rotary motion into linear motion: ball screws or roller screws are usually preferred to acme screws because, having a higher efficiency, they can perform the conversion with lower friction;
6. a network of sensors used to close the feedback rings (current, angular speed and position) that control the whole actuation system (reported in Fig. 2, as RVDT).

In order to evaluate the behavior of the proposed prognostic method in case of EMA progressive failures, the authors developed an experimental test-bench [9]. By means of a tradeoff analysis among the available components, the different items composing the case study have been chosen:

- MecVel ALI-2 (version M01) actuator, powered by a brushed DC electrical motor and equipped with 24 VDC brake and encoder (Fig. 3);
- RoboteQ AX1500 controller (with encoder);
- Acopian unregulated power;
- RS-232 to USB converter.

Subsequently to a proper stage of setup and calibration of the EMA control logic (selection of the proper PID gains and anti-windup filters), the actuation system was fully ready to operate.

The abovementioned controller logic closes the control loops feeding the EM actuator with various type of input meaningful for the parameter estimation process (sinusoidal with/without linear frequency sweep, ramp, step and external commands, all of them both in open and closed loop). Every significant datum (RPM, rod position, controller current, motor power level, PID actions) could have been recorded and exported to Microsoft Excel or even to Matlab.

5 EMA Numerical Model

As previously reported, the subsequent step was to build an adequate Simulink model of the actuation system to be used as core of the damage estimator thus making it capable of recognizing the most representative actuator's failure modes according to some faulty experimental data achieved by the aforementioned software. In order to build an efficient model, two important (and often antithetical) aspects must be considered: the execution speed of the algorithm and the level of accuracy of the simulated results (with respect to the real ones). In the present work, a parameter estimation task is involved (as shown in previous sections) meaning that the numerical model will go through an optimization problem and thus the speed aspect must be privileged. The proposed numerical model is composed of six blocks representing the physical/functional components of the actual EMA.

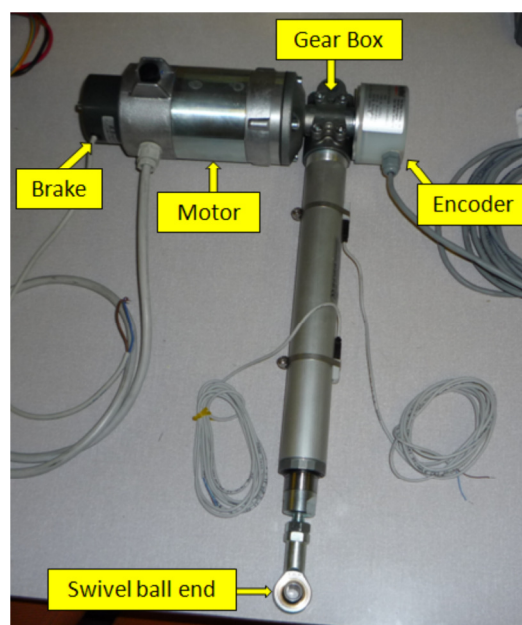

Fig. 3: Considered EMA actuator.

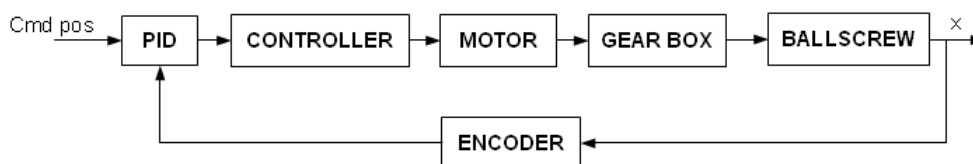

Fig. 4: Conceptual model scheme.

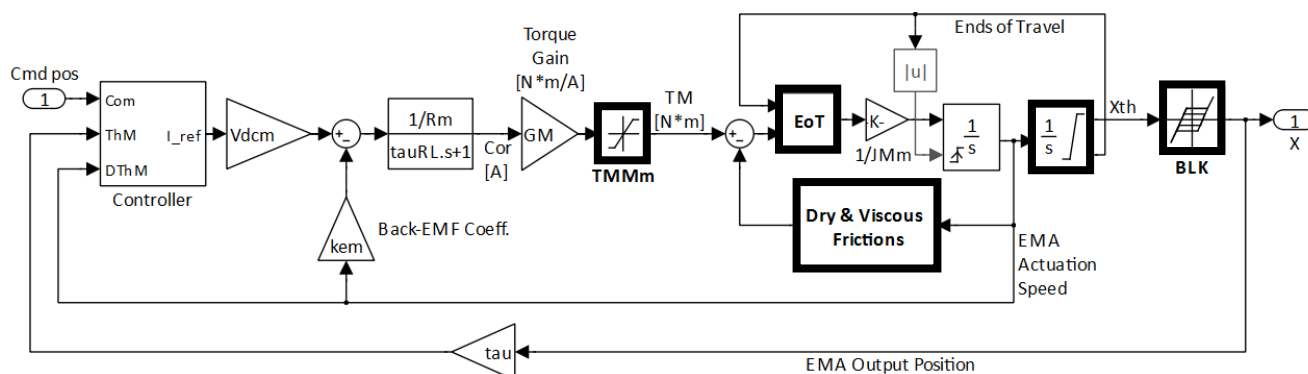

Fig. 5: Block Diagram of EMA numerical model; it must be noted that the blocks that implement the nonlinearities considered – saturation of the motor torque (TMMm), dry friction phenomena, ends-of-travels (EoT) and global mechanical backlash (BLK) acting on the final ballscrew actuator – are highlighted in the diagram by bold border.

The Simulink model includes following blocks:

- PID Control Logic (i.e. PID controller with saturated output and anti-windup);
- Controller (simulating the RoboteQ AX1500 controller behaviors);
- Motor (simplified electro-magneto-mechanical model of the considered DC motor);
- Gear box;
- Ball screw;
- Encoder.

As shown in [8], every block has been modelled starting from its basic electromechanical equations, but since the objective is to achieve a model capable to recognize defined actuator faults (e.g. dry friction or mechanical backlash), it was decided to model in a suitably simplified way the electromagnetic aspects and focus instead on mechanical ones.

The considered numerical model is developed from the monitoring model conceived by the authors for an EMA model-based prognostic application [6].

The electro-magneto-mechanical dynamics of the BDC motor is simulated by means of a classic resistive-inductive (RL) numerical model.

In particular, it is a 1st order linear model capable of calculating the moving torque TM as a function of the motor torque gain GM , of its power supply voltage ($V_{dcm} \cdot I_{ref}$), of the back-emf, of the dynamic characteristics of the RL circuit and of the saturation of magnetic induction flux.

The dynamics of the mechanical actuation system (rotor of BCD motor, gear box and ball screw) is represented by a simplified 1 degree-of-freedom system (obtained assuming an ideal rigid transmission without elastic deformations or backlashes). According to [6], it is modelled by means of a 2nd order non-linear numerical model able to simulate the EMA behavior taking into account the global effects due to inertia, viscous damping, ball screw ends-of-travel and dry frictions.

The dry friction torques acting on the EMA are simulated by a numerical algorithm implementing the classical Coulomb's model; this algorithm has been developed by means of a lumped parameter model based on the Karnopp friction model [15] and suitably modified as shown in [16]. The backlashes affecting the mechanical transmission, evaluated according to [17], have been simulated using a simplified approach by the backlash Simulink block.

6 Proposed Prognostic Algorithm

The outlined nonlinear third-order model can simulate the system response, taking into account both Coulomb friction and backlash, being then potentially able to reproduce seizure due to ball return jamming or bearing binding/sticking as well as the appearance of backlash in case of balls excessive wear.

Subsequently, its execution speed was tested in order to verify its suitability for optimization purposes. It must be noted that, despite being a relatively simplified numerical model, it shows a good accuracy, guaranteeing a satisfying correspondence with the experimental data (as reported in the following sections). The method performs the failure detection identification using an optimization process implemented by a simulated annealing algorithm; this process aims to minimize the value of appropriate objective functions (typically related to the magnitude of the error $E(t)$ calculated comparing together experimental and numerical data) by acting on well-defined parameters of the numerical model. In particular, by means of simulated annealing algorithm, the optimization process modifies the parameter CSJ and BKL, respectively representative of the dry frictions and the mechanical backlashes globally acting on the EMA numerical model, in order to identify their values that minimize the abovementioned objective functions.

It is clear that, in this case, the objective function of the optimization problem is the error generated, for a well-defined command input (*Cmd pos*), between the experimental data and the corresponding model output. Before verifying the actual ability of the proposed prognostic method to identify and evaluate failure precursors, the calibration of the numerical model parameters has been performed. The ideal values of these parameters have been identified by comparing the dynamic response of the real system in nominal conditions (NC: e.g. nominal dry friction and mechanical backlash levels and no other failures) with that generated by the numerical model, then, identifying the corresponding objective function (E_{int}) and, at last, applying the proposed optimization process to the above parameters.

For instance, in Fig. 6 and 7 the experimental response of the EMA test bench is compared with the corresponding dynamic behaviors of the numerical model, putting clearly in evidence the best match that occurs (between experimental and simulated data) following of this calibration. In this case the command position input is constituted to a chirp signal shown in Fig. 6. It should be noted that the beneficial effects due to calibration can be appreciated more clearly by directly comparing the EMA rod position residuals obtained before and after optimization (as shown in Fig. 8).

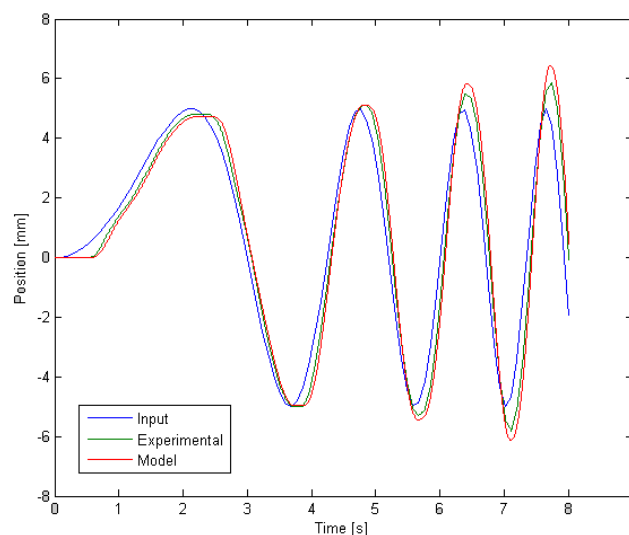

Fig. 6: EMA rod position before optimization.

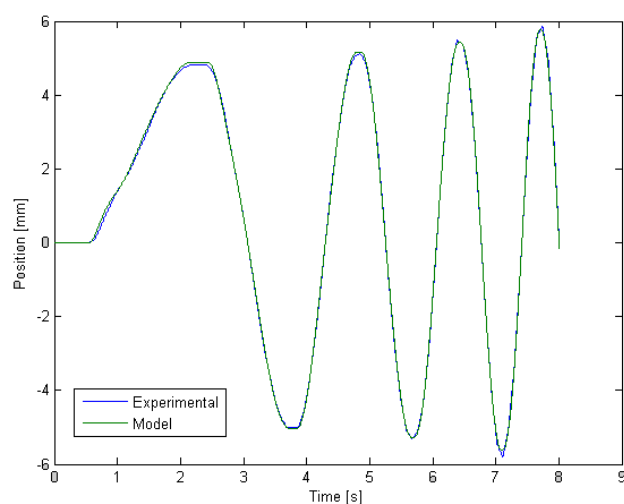

Fig. 7: EMA rod position after optimization.

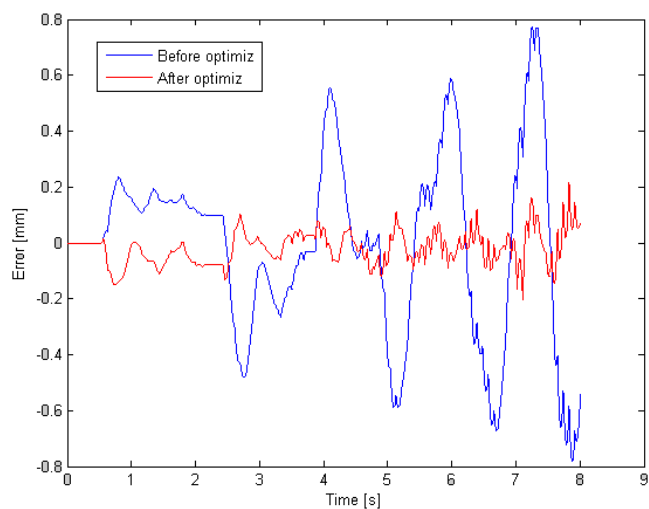

Fig. 8: Experimental vs simulated EMA rod position residuals before and after optimization.

The aforesaid model, properly calibrated in NC, was then used to estimate the global amount of the mechanical backlash acting on the real EMA; the dynamic response of the real EM actuation system (subjected to a well-defined system of backlashes affecting the mechanical transmission) is compared with that produced by the simulation model and, by means of the abovementioned optimization method, it is calculated the value of the parameter BLK^4 that minimizes the error between real and simulated.

The Simulated Annealing method used by the proposed prognostic routine to perform the fault estimation is implemented by means of Matlab Optimization Tool. It must be noted that these optimizations have been carried out in condition of unloaded actuator since, within an operational scenario, these kinds of tests could be performed on the ground, without any aerodynamic loads, but rather just with the control surface weight, which is usually negligible compared to the actuator's capabilities. The problem of what type of signal should have been used to test the optimization algorithm has not a precise solution and depends strongly by the system's application. In the case here examined, a sinusoidal linear frequency sweep wave was chosen as standard input position signal for the parameter estimation process. In fact, such a signal allows testing, at one time, a wide range of system response frequencies. For instance, in the low frequency range the stick-slip motion could be highlighted, enabling the optimization algorithm to finely tune the friction and backlash coefficients of the model and, at the same time, adapt the other parameters according also to the high frequency range, representing more significantly the system dynamic response. A simple step or ramp response could not comply with this necessity. In order to obtain accurate results and assure a suitable speed of convergence of the algorithm, the mechanical backlash BKL (which varies during the optimization process to minimize the error between experimental data and corresponding numerical simulations) has been limited between a lower and an upper bound (respectively LB and UB)⁵.

⁴ The parameter BLK takes into account the global effects of the backlashes affecting the EMA mechanical transmission by means of a very simplified model; in fact, the dynamic interactions between the different elements interested to the above mentioned backlashes are neglected. It is expressed in millimetres and represents the equivalent mechanical backlash (calculated as a sum of the backlash affecting the components of the transmission) acting on the whole EMA.

⁵ Similar considerations, regarding the friction coefficient CSJ , have been already developed by the authors in [9].

To this purpose, it is necessary identify some meaningful value regarding the aforesaid backlash phenomenon. By reading the MecVel ALI-2 maintenance handbook [18], it is possible to gain knowledge of the maximum acceptable backlash value of the ballscrew:

$$\Delta_b \leq 0.3 \cdot p = 1.5 \text{ mm} \quad (5)$$

where p is the ballscrew pitch (5 mm).

For higher values of Δ_b , the ballscrew should be replaced. Therefore the afore calculated backlash value can be considered as limit value and clearly it is very far from the healthy value related to the actual system. In this case, BLK can assume values from 0 [mm] (LB) to 0.1 [mm] (UB), which represent a quite large band given that the authors' goal is the proposal of a prognostic method (that is able to perform an early identification of the considered progressive faults) and the actual value of the mechanical backlash (in healthy conditions) is worth about 0.033 [mm].

Hence, it would be meaningful to increase the latter value by different percentage in order to test the algorithm's resolution and accuracy considering mechanical transmissions characterized to different fault magnitude (e.g. gears or screw suitably damaged) or modifying the experimental results in order to simulate the backlash effects.

To this purpose, this research evaluates three cases of backlash severity: High: 0.066 [mm]; Moderate: 0.0495 [mm]; Low: 0.04125 [mm].

Different experimental tests have been conducted (with different time-history input and different levels of failure) that were then used as input to the optimization process performing the failure analysis.

Figures 9 and 10 show the results gained by the authors in case of experimental system affected by a high mechanical backlash. Also in this case, the considered input is a position command evolving like a sinusoidal linear frequency sweep wave.

It must be noted that, in this case, the difference between the EMA dynamic response after and before the SA optimization (shown in Fig. 9 and 10 respectively), as well as the difference between the corresponding experimental (blue line signal called "High backlash") and simulated (green line signal called "Model") results are hardly detectable in these figures because the considered backlash values, even where particularly relevant, result nevertheless very small if compared to the corresponding amplitude of the EMA dynamic response.

Figure 11 allows to overcome this shortcoming evaluating the effects of the SA optimization method (acting on the dynamic response of the numerical model) comparing together the EMA position residuals of the curves shown in Fig. 9 and 10 (before and after SA optimization respectively): the blue curve reports the position residual calculated before optimization while the red curve puts in evidence how the SA optimization process, has significantly reduced the error between experimental and simulated data, increasing the accuracy of the numerical model with respect to the performance of the "faulty" test-bench. This means that the value of mechanical backlash estimated at the end of the optimization process is reasonably close to the corresponding real and that, at least for the considered typology of fault, this approach can be satisfactorily used to detect/identify the fault.

Comparing the results obtained with the proposed method it is possible to notice how, in this case, the Simulated Annealing algorithm has found a good solution, estimating a global backlash value equal to 0.06613 [mm] (and, therefore, very close to the assumed experimental value of 0.066 [mm]). Considering all the data collected during the tests, it must be noted that these results are rather satisfying and the proposed fault detection algorithm is suitably able to estimate, with a small error, the varying parameters that represent the faults.

These considerations are synthesized in Fig. 12 by means of the *diagnostic scalars* (i.e. a histogram representing the SA results performed in case of high, moderate and low backlash). The diagnostic scalars compare each other the estimated and the actual values of the considered parameters (in this case the BKL and CSJ) putting in evidence the corresponding errors; these values are expressed as a percentage of the related nominal values (NC).

These results could be used as input for a prognostic early fault identification algorithm which, associated with dedicated evolution models able to represent the progressive growth of the considered faults, allow estimating the Remaining Useful Life (RUL) of the system.

Additional investigations, performed taking into account also the effects due to electrical noises, analog to digital conversion (ADC) problems, signal transducers affected by offsets or electrical drifts or (reasonable) variations of the boundary conditions, have put in evidence the robustness and the accuracy of this algorithm.

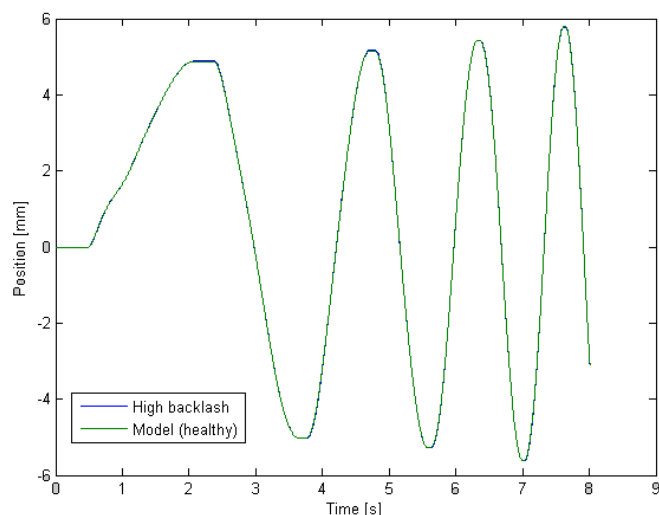

Fig. 9: Experimental vs. simulated EMA position calculated before SA optimization.

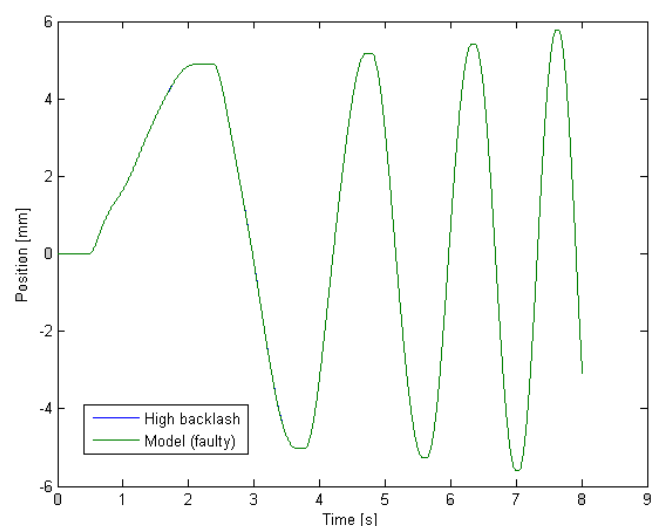

Fig. 10: Experimental vs. simulated EMA position calculated after SA optimization.

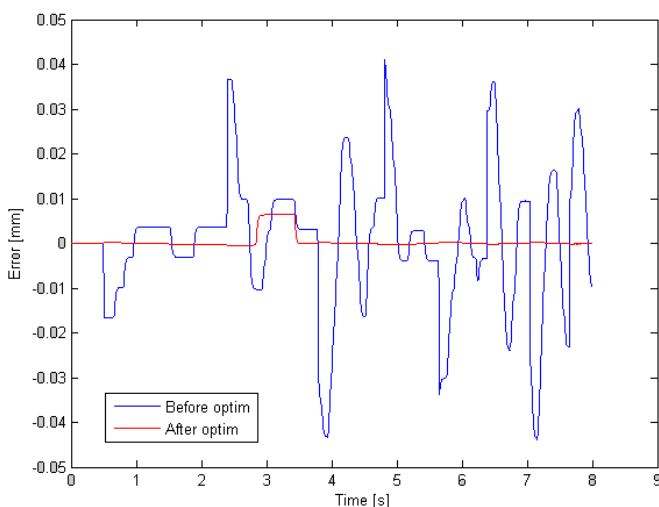

Fig. 11: Experimental vs simulated EMA position residuals before and after SA optimization.

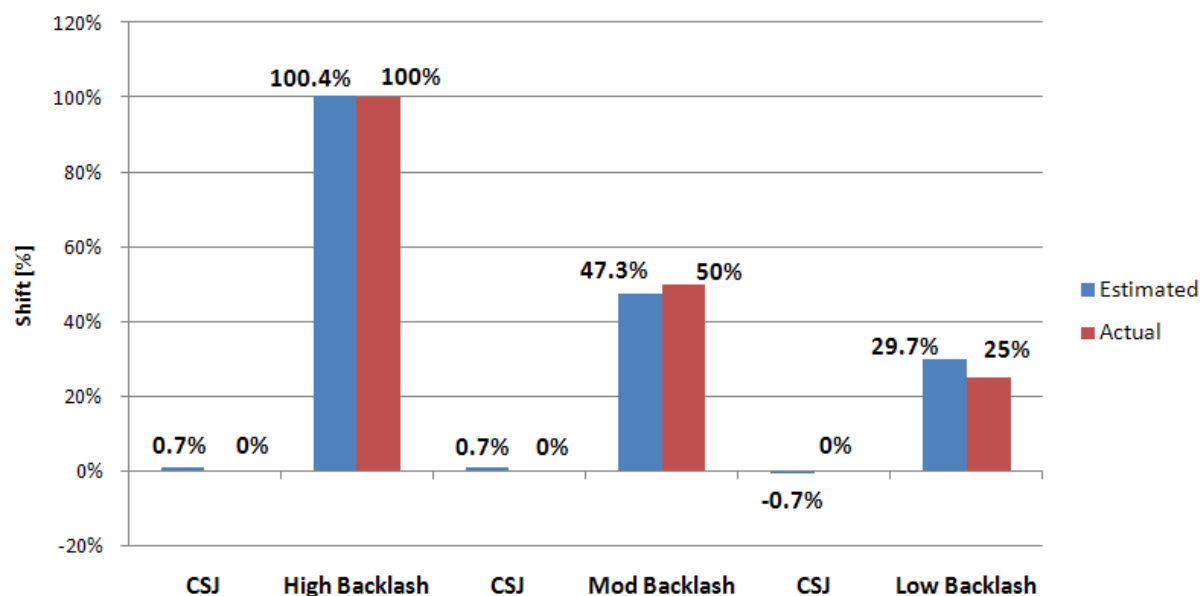

Fig. 12: Diagnostic scalars in case of EMA backlash.

7 Conclusions

A model-based damage estimator for an electromechanical actuation system has been developed and tested under different operational conditions using the Simulated Annealing (SA) optimization algorithm with a MATLAB Simulink model capable of reproducing the effects of progressive growth of mechanical backlash acting on transmission devices (this is simulated properly modifying the corresponding backlash coefficient BLK). The experimental data useful to demonstrate the damage estimator capabilities have been achieved by means of an electromechanical system developed for this purpose. This test-bench is able to feed the physical system with different type of signals (i.e. step, ramp, sinusoidal and generic external commands, both in open and closed loop mode), acquiring the position/speed response to a sinusoidal frequency sweep input which showed to be effective within the damage estimation process.

The SA proved to be very effective, as its execution times were fairly acceptable (a few minutes) for an operational scenario. However, this method showed a strong dependence of the results on its initialization settings (i.e. initial temperature, function tolerance, reannealing interval) and also on the variables bounds which have to be chosen carefully, making, for example, some considerations regarding their physical limits. Also in this case, in view of the achieved results, this kind of damage estimator can be considered a very powerful tool for PHM applications. Hence its developing should be further improved.

8 Acknowledgment

In conclusion, the authors wish to extend a heartfelt thanks to Professor Lorenzo Borello for his precious role in the definition of the concepts that have allowed the realization of this work.

References:

- [1] DoD Panel to Review the V-22 Program, Report of the Panel to Review the V-22 Program, April 2001.
- [2] C. S. Byington, M. Watson, D. Edwards & P. Stoelting, A Model-Based Approach to Prognostics and Health Management for Flight Control Actuators, *IEEE Aerospace Conference Proceedings*, USA, 2004.
- [3] Diagnostics and Prognostics Terms Related to Integrated Systems Diagnostics Design, <http://prognosticshealthmanagement.com>
- [4] L. Borello, M. D. L. Dalla Vedova, G. Jacazio, M. Sorli, A Prognostic Model for Electrohydraulic Servovalves, *Proceedings of the Annual Conference of the Prognostics and Health Management Society*, 2009.
- [5] M. D. L. Dalla Vedova, P. Maggiore, L. Pace. Proposal of Prognostic Parametric Method Applied to an Electrohydraulic Servomechanism Affected by Multiple Failures, *WSEAS Transactions on Environment and Development*, ISSN: 1790-5079, pp. 478-490.
- [6] P. Maggiore, M. D. L. Dalla Vedova, L. Pace, A Desando, Definition of parametric methods for fault analysis applied to an electromechanical servomechanism affected by

- multiple failures, *Proceedings of the Second European Conference of the Prognostics and Health Management Society*, 08-10 July 2014, pp. 561-571
- [7] M.D.L. Dalla Vedova, P. Maggiore, L. Pace, A. Desando, *Proposal of fault analysis parametric method applied to an electromechanical servomechanisms affected by failures*, *International Journal of Prognostics and Health Management (IJPHM)*, Vol. 6, No. 1, 2015, ISSN: 2153-2648.
- [8] 7 M. Battipede, M.D.L. Dalla Vedova, P. Maggiore, and S. Romeo, Model based analysis of precursors of electromechanical servomechanisms failures using an artificial neural network, *Proceedings of the AIAA SciTech Modeling and Simulation Technologies Conference*, Kissimmee, Florida, 5-9 January 2015.
- [9] M.D.L. Dalla Vedova, P. Maggiore, L. Pace – A New Prognostic Method Based on Simulated Annealing Algorithm to Deal with the Effects of Dry Friction on Electromechanical Actuators – *International Journal of Mechanics*, Vol. 9, 2015, pp. 236-245 – ISSN: 1998-4448.
- [10] 17 C.R. Yu, Y. Luo. An Improved Nested Partitions Algorithm Based on Simulated Annealing in Complex Decision Problem Optimization. *WSEAS Transactions on Computers*, Vol. 7, No. 3, March 2008, pp. 75-82.
- [11] 18 A. Sadegheih. Evolutionary Algorithms and Simulated Annealing in the Topological Configuration of the Spanning Tree. *WSEAS Transactions on Systems*, Vol. 7, No. 2, February 2008, pp. 114-124.
- [12] 8 M. Pirlot, General Local Search Methods, *European Journal of Operational Research*, Vol.92, 1996, pp. 493-511.
- [13] 9 N. Metropolis, A. N. Rosenbluth, M. N. Rosenbluth, A. H. Teller, and E. Teller, *Equation of state calculation by fast computing machines*, *Journal of Chemical Physics*, Vol.2, No.6, 1953, pp. 1087-1092.
- [14] 12 K.K. Vishwakarma, H.M. Dubey, M. Pandit, and B.K. Panigrahi, Simulated annealing approach for solving economic load dispatch problems with valve point loading effects, *International Journal of Engineering, Science and Technology*, Vol.4, No.4, 2012.
- [15] 10 D. Karnopp, Computer simulation of stick-slip friction in mechanical dynamic systems, *Journal of Dynamic Systems, Measurement, and Control*, Vol.107, No.1, 1985, pp. 100-103.
- [16] 11 L. Borello, and M. D. L. Dalla Vedova, A dry friction model and robust computational algorithm for reversible or irreversible motion transmission, *International Journal of Mechanics and Control (JoMaC)*, Vol.13, No.2, December 2012, pp. 37-48, ISSN: 1590-8844.
- [17] 19 L. Borello, G. Villero, and M. D. L. Dalla Vedova, New asymmetry monitoring technics, *Aerospace Science and Technology*, Vol.13, No.8, December 2009, pp. 475-497.
- [18] 13 MecVel, ALI2 / ALI2-P Use and maintenance handbook (Rev. 01), June 2012.