

Current and Voltage Behaviour During a Fault in a HV/MV System: Methods and Measurements

Original

Current and Voltage Behaviour During a Fault in a HV/MV System: Methods and Measurements / Colella, Pietro; Napoli, Roberto; Pons, Enrico; Tommasini, Riccardo; Barresi, A.; Cafaro, G.; De Simone, A.; Di Silvestre, M. L.; Martirano, L.; Montegiglio, P.; Morozova, E.; Pariseg, ; Parise, L.; Riva Sanseverino, E.; Torelli, F.; Tummolillo, F.; Valtorta, G.; Zizzo, G.. - CD-ROM. - (2015), pp. 404-409. (Intervento presentato al convegno 2015 IEEE 15th International Conference on Environment and Electrical Engineering tenutosi a Roma nel June 10-13, 2015) [10.1109/EEEIC.2015.7165196].

Availability:

This version is available at: 11583/2611957 since: 2020-01-24T09:26:11Z

Publisher:

IEEE

Published

DOI:10.1109/EEEIC.2015.7165196

Terms of use:

This article is made available under terms and conditions as specified in the corresponding bibliographic description in the repository

Publisher copyright

IEEE postprint/Author's Accepted Manuscript

©2015 IEEE. Personal use of this material is permitted. Permission from IEEE must be obtained for all other uses, in any current or future media, including reprinting/republishing this material for advertising or promotional purposes, creating new collecting works, for resale or lists, or reuse of any copyrighted component of this work in other works.

(Article begins on next page)

Current and Voltage Behaviour During a Fault in a HV/MV System: Methods and Measurements

P. Colella*, R. Napoli*, E. Pons*, R. Tommasini*, A. Barresi[‡], G. Cafaro[§], A. De Simone[†], M. L. Di Silvestre[¶], L. Martirano^{||}, P. Montegiglio[§], E. Morozova[†], G. Parise^{||}, L. Parise^{||}, E. Riva Sanseverino[¶], F. Torelli[§], F. Tummolillo[‡], G. Valtorta[†] and G. Zizzo[¶]

* Politecnico di Torino, Dipartimento Energia, Torino, Italy, pietro.colella@polito.it

[†] Enel Distribuzione SpA, Roma, Italy, angelo.desimone@enel.com

[‡] IMQ, Milano, Italy, filomena.tummolillo@imq.it

[§] Dipartimento di Elettrotecnica ed Elettronica, Politecnico di Bari, Bari, Italy, cafaro@poliba.it

[¶] Dipartimento di Energia, Ingegneria dell'Informazione e Modelli Matematici, Università degli Studi di Palermo, Palermo, Italy, gaetano.zizzo@unipa.it

^{||} Dipartimento di Ingegneria Astronautica, Elettrica ed Energetica,

Università degli Studi di Roma "La Sapienza", Roma, Italy, luigi.martirano@uniroma1.it

Abstract—When a single line to ground fault happens on the MV side of a HV/MV system, only a small portion of the fault current is injected into the ground by the ground-grid of the faulty substation. In fact the fault current is distributed between grounding electrodes and MV cables sheaths. In systems with isolated neutral or with resonant earthing this may be sufficient to provide safety from electric shock. Experimental measurements were performed on a real MV distribution network: a real single line to ground fault was made and fault currents were measured in the faulty substation and in four neighbouring substations. In this paper the problem of fault current distribution is introduced, the test system is described and the measurements results are presented.

Index Terms—Current distribution, Electrical safety, Global earthing systems, Grounding, Power distribution faults, Single line to ground fault.

I. NOMENCLATURE

CCSE	Cassa Conguaglio per il Settore Elettrico
CENELEC	European Committee for Electrotechnical Standardization
DSO	Distribution System Operator
EPR	Earth Potential Rise
ES	Earthing System
FFT	Fast Fourier Transform
GES	Global Earthing System
HV	High Voltage (>30 kV a.c.)
IEC	International Electrotechnical Commission
LV	Low Voltage (<1 kV a.c.)
MV	Medium Voltage (1 ÷ 30 kV a.c.)
NM	Not Measured
PMT	Pole Mounted Transformer
SLGF	Single Line to Ground Fault

II. INTRODUCTION

MV distribution systems in densely populated areas, such as residential and industrial zones, normally consist of a large number of MV/LV substations close to each other. Each substation is provided with a ground-grid characterized by a quite high ground resistance value. All these grounding

systems are interconnected through MV cables sheaths and, sometimes, through bare ground wires buried together with power cables or through LV neutral conductors. This tight interconnection of grounding systems to each other and to utility installations (water/gas pipelines, railway and tramway tracks, etc.) sets up an overall low resistance grounding system and provides two main results:

- a distribution of the fault current between grounding electrodes (of the faulty substation and of the neighbouring ones) and MV cables sheaths [1], [2];
- a smoothing of the ground surface potential profile, reducing the hazardous voltage gradients [3], [4].

For these reasons, the CENELEC Harmonization Document HD 637 S1, published in 1999 [5], and, later, the European EN 50522 [6] and International IEC EN 61936-1 [7] Standards (published in 2010-2011) introduced, with reference to MV distribution systems, the concept of global earthing system (GES), that is defined as “*equivalent earthing system created by the interconnection of local earthing systems that ensures, by the proximity of the earthing systems, that there are no dangerous touch voltages*”.

In fact, in interconnected MV distribution systems, the cases where the permissible earth potential rise (EPR) was exceeded in case of single line to ground fault (SLGF) in MV/LV substations are rare and concern only stand-alone substations (in antenna or situated at long distance from other substations) [8].

The Meterglob project, founded by the Italian CCSE (Cassa Conguaglio per il Settore Elettrico)¹, is studying different aspects related to GESs. In particular, the contribution of extraneous conductive parts and LV neutrals to the ground surface equipotentialization [9] and the problem of periodic testing of safety conditions of Earthing Systems (ESs) [10]

¹At the Meterglob project is working a consortium of six partners: Enel Distribuzione, Politecnico di Torino, Università di Roma La Sapienza, Politecnico di Bari, Università di Palermo and Istituto Italiano del Marchio di Qualità IMQ.

have been studied. In addition to this, one of the outcomes of the Meterglob project will be a set of guidelines for the definition of GESs [11].

In this paper the other main aspect, i.e. the fault current distribution between ESs and MV cables sheaths in a MV distribution system with interconnected grounding electrodes, is studied. Experimental tests have been performed, creating a real SLGF in a MV/LV substation and measuring the fault currents flowing to grounding electrodes and through MV cables sheaths.

In the following paragraphs the problem of SLGF in MV distribution systems is analysed, the structure of the MV distribution system used for the experimental measurements is described and, finally, the measurements results are presented.

III. SINGLE LINE TO GROUND FAULT IN HV/MV SYSTEMS

MV distribution systems are designed to carry electrical power from the HV transmission system to individual consumers. They are fed by HV/MV transformers located in distribution substations and feed LV users through MV/LV distribution transformers.

In Europe, in urban areas, most MV lines are constituted by buried cables. The neutral point of the MV distribution systems is isolated from ground or earthed through the so called Petersen coil for SLGF current reduction (resonant earthing). For this reason the fault can last for a certain time before being cleared [12].

Usually a single HV/MV substation feeds a few MV lines, which, on their path, feed 15 to 30 MV/LV substations each. Every MV line can be fed from both ends but a disconnector keeps the phases interrupted (not the cables sheaths, which are never interrupted) in one of the substations, making the meshed system a radially operating network.

The cables metal sheaths are grounded at each end, being connected to the ground-grid of each substation. The only exception can be at the HV/MV substation where, sometimes, to limit transferred potentials in case of SLGF on the HV side, an insulating joint is placed and the MV cable sheaths are not connected to the ground-grid.

The interconnection of the substations grounding electrodes is even more meshed, thanks to LV neutral conductors. LV consumers, in fact, can be fed alternatively by two different MV/LV substations in order to improve system reliability. As in the case of MV cables, also LV phases are disconnected in a distribution box along their path to make the LV network radially operated, but neutral conductors are never disconnected, creating a galvanic connection between ground-grids of different MV/LV substations, even belonging to different MV lines [13].

Some Distribution System Operators (DSOs), when installing new MV lines, are used to bury along the line a bare conductor together with the power cables. This bare conductor constitutes a further interconnection between the ground-grids of the substations, also contributing to the fault current leakage into the ground [14], [15].

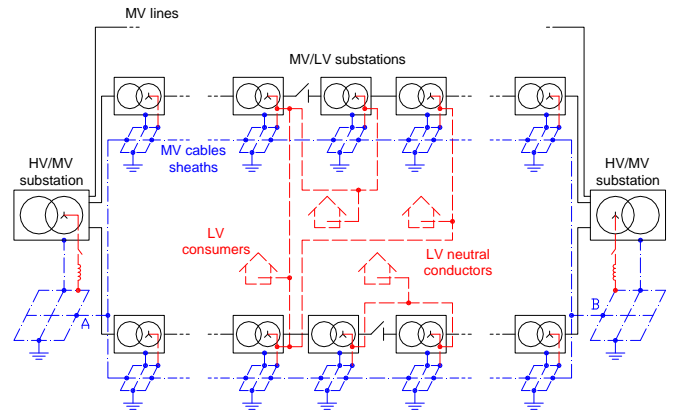

Fig. 1. Typical MV distribution system.

The described situation is showed in Fig. 1, where MV lines (continuous), cables sheaths (dash-point) and LV neutral conductors (broken-line) are highlighted.

In case of a SLGF, in general, the fault current I_F can be calculated as:

$$I_F = 3I_0 + I_N \quad (1)$$

where I_0 is the zero sequence current of the line and I_N is the current via the neutral earthing of the transformer [6]; the current I_0 can be calculated based on the network size (km of overhead and cable lines) and on lines parameters, while in systems with isolated neutral, $I_N = 0$. Thanks to all the interconnections between ground-grids, in the faulted substation the current I_F is split between the ground-grid itself (I_{RS}), the MV cables sheaths (I_S), the LV neutral conductors (I_{LVN}) and the bare buried conductors (I_{BC}), if present (Fig. 2).

IV. EXPERIMENTAL MEASUREMENTS

Experimental measurements were performed on a real MV distribution network, producing a SLGF and measuring the fault current distribution in 5 MV/LV substation: the faulted substation and the 4 neighbouring ones. In the following paragraphs the distribution network and the experimental setup are described. The measurements results are then presented.

A. The Enel distribution network in S. Gillio

The experimental measurements were carried out in a rural area called San Gillio (Torino, Piemonte, Italy), where a HV/MV substation, operated by Enel (the local DSO), feeds two separate MV networks with rated voltages 15 and 22 kV, through two HV/MV transformers. Both networks consist of 5 feeders and, totally, cover an area of about 120 km². A representation of the MV networks in the area is given in Fig. 3.

The tests were performed on the 22 kV network where the average number of the MV/LV substations for each feeder is 15 and the mean distance between two consecutive ones is 600 m.

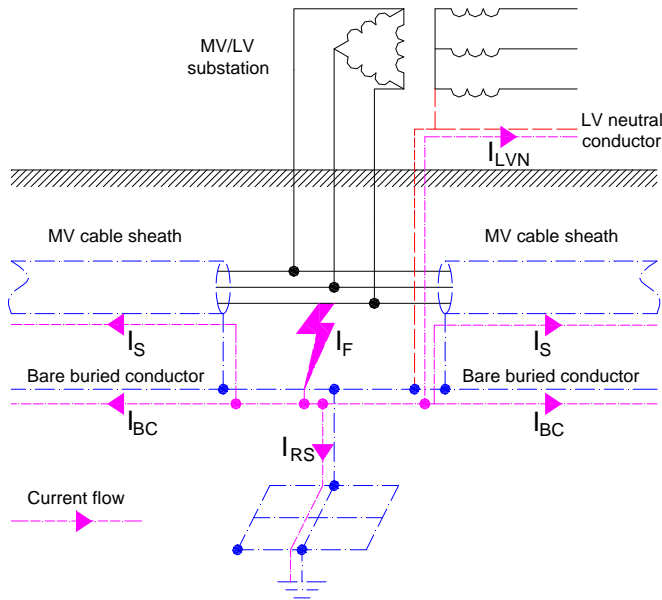

Fig. 2. SLGF current distribution

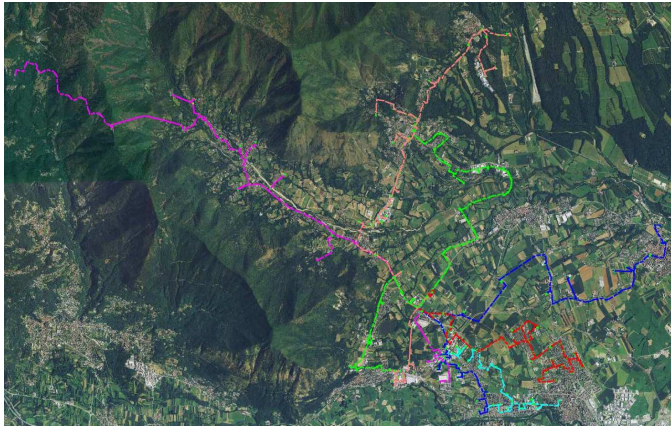

Fig. 3. MV networks in San Gillio

During the tests the system was operated with isolated neutral: in this condition the forecasted SLGF current, calculated by Enel, is 238 A.

The considered network is almost totally composed of underground cable lines. The characteristics of the most common MV cables used in S. Gillio (covering globally 95% of the network) are reported in Table I.

At the end of each feeder, as previously described (Fig. 1), an open disconnector separates the portion of network fed by the other HV/MV substation. In S. Gillio, on the average, after the disconnector, other 15 MV/LV substations follow, fed by another HV/MV substation.

The ES of a distribution substation is generally formed by a metallic ring and 4 earthing rods, all buried around the external perimeter. The average value for its resistance to earth is 5 Ω . As far as the ES of the HV/MV substation is concerned, its resistance to earth is 0.1 Ω . The MV cables sheaths of the line

TABLE I
TYPICAL CHARACTERISTICS OF THE MOST COMMON MV CABLES
IN S. GILLIO

Quantity per unit lenght	Cross section [mm ²]		
	95	150	185
phase resistance [Ω /km]	0.320	0.206	0.164
sheath resistance [Ω /km]	1.15	0.73	0.73
phase - sheath capacitance [μ F/km]	0.238	0.277	0.300
usage in the network [%]	8	61	26

TABLE II
ES RESISTANCE OF THE MV/LV SUBSTATIONS INVOLVED IN THE TEST

Substation name	R [Ω]
Grange	6.4
Sara	2.3
Bonino	7.6
Tucano	8.6
Cocchis	1.3

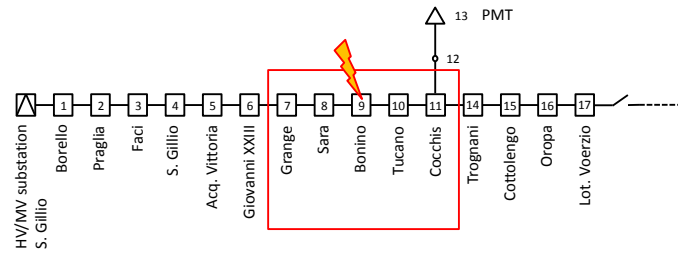

Fig. 4. Substations in the faulted MV feeder "Praglia"

where the SLGF is made are not connected to this ES.

B. Experimental setup

The tests were carried out on one of the 5 feeders, called "Praglia", of the 22 kV network in S. Gillio, which supplies 17 MV/LV substations; those involved in the tests are stressed with the red rectangle in Fig. 4. Their ES resistance to earth was measured and is reported in Table II.

In each of the 5 substations, an equipotential node was made connecting the MV cables sheaths and the earthing conductor together, in the same location (Fig. 5), to enable the installation of current clamps.

In "Bonino" substation, where the fault was made, a dedicated module was installed, Fig. 6, with a remotely controlled circuit breaker. One of the poles of the circuit breaker was connected to the equipotential node in order to create the SLGF.

In order to study the base case, in which the fault current is distributed only between ground-grids and MV cables sheaths, all LV lines were disconnected from the MV/LV transformers and LV neutrals were disconnected from the main earthing terminals.



Fig. 5. Equipotential node in the MV/LV substations



Fig. 6. MV switchgear in the faulted substation.

Digital high-speed waveform monitoring and recording devices were used to record the currents waveforms in the five MV/LV substations. In each monitored substation, one of the measured currents was used as trigger signal; a suitable pre-trigger time was also set to be sure of storing the whole fault event.

C. Measurement results and discussion

Several measurement campaigns, with different network configurations, have been done. In this paper, the results of the most significant, carried out in April 2013, are reported.

The registered waveforms (here, as an example, the current waveforms measured in substation “Bonino” are showed in Fig. 7) were processed to obtain the equivalent phasor representation.

Firstly, a synchronization of the waveforms measured by the different devices in the different substations was made, considering the instant in which the fault occurs as the initial

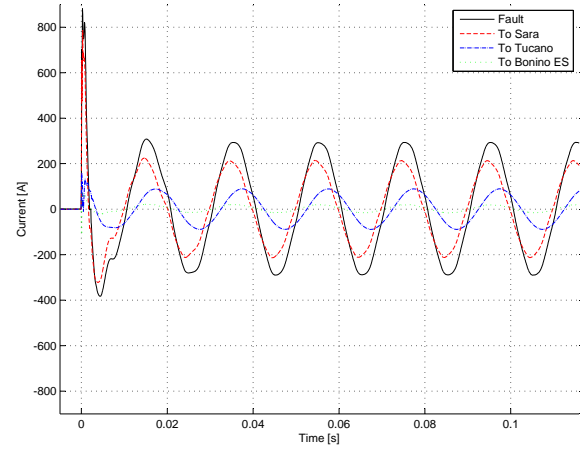

Fig. 7. Measured currents in substation “Bonino”

one ($t = 0$). In fact, in $t = 0^-$, the current is zero in each part of the circuit, while in $t = 0^+$ the current starts rising in all measurements. The instant $t = 0$ was therefore used for the synchronization in order to determine the exact phase relationship among all the currents.

The first part of the recorded data (corresponding to the transient phenomenon) was discarded; the portion of data corresponding to the steady state phenomenon was instead considered: the measured signals were decomposed using the FFT (Fast Fourier Transform).

The values of the measured currents are reported in Fig. 8, considering only the 50 Hz component. In “Bonino” substation, the current that flows through the ES was not measured because of a technical issue; it was computed based on the difference between the input and output currents. However, similar values were directly measured in the other measurement sessions.

The accuracy of the measurements is evaluated considering the Kirchhoff’s currents law: the sum of the measured currents flowing into the equipotential node in each MV/LV substation should be equal to the sum of measured currents flowing out of that node. In our case, because of the conventional direction chosen for currents, there is only one current flowing into each node and the relative error can be computed by means of eq. (2).

$$E_{\%} = \frac{I_{in} - \sum_n I_{out}}{I_{in}} \quad (2)$$

If “Cocchis” substation is excluded, the maximum error is 2.1%. The computed fault current given by Enel (238 A) differs by about 15% from that measured.

A polar representation of the currents phasors is reported in Fig. 9: the names of the phasors are made up by the names of the MV/LV substation in which the current is measured followed by the name of the upstream or downstream MV/LV substation or ES towards which the current is directed, in order

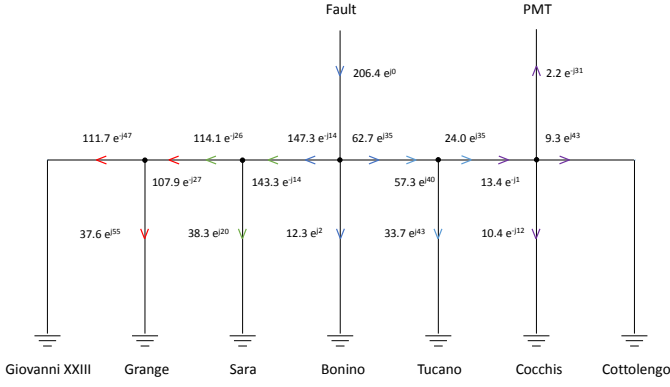

Fig. 8. Phasors of the measured currents. The RMS values are expressed in A; the angles in $^{\circ}$.

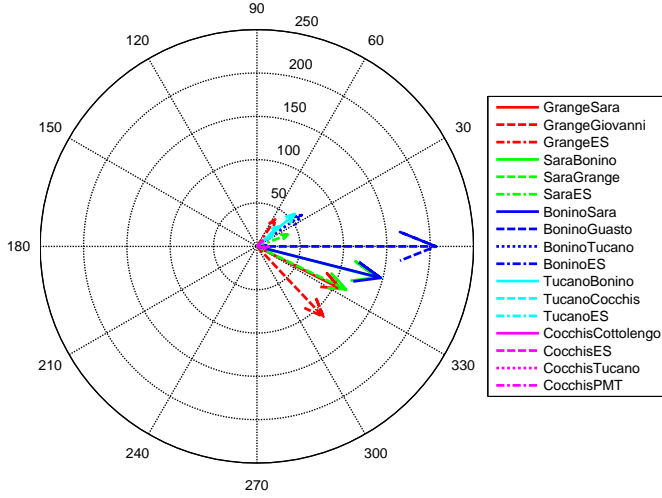

Fig. 9. Polar representation of the currents phasors. The RMS values are expressed in A; the angles in $^{\circ}$.

to univocally identify the measured current. The fault current phase is set at 0° .

It's worth to highlight that the currents at the beginning and at the end of a MV cable sheath connecting two substations ground-grids are not the same: in fact, a portion of the current returns through the capacitances between sheaths and phase conductors.

With regard to people's safety from electric shock, the RMS values of the currents that flow into the ESs of the MV/LV substations (I_{RS}) need to be considered together with the values of ground resistance: these two elements concur in fact to produce the EPRs. The interconnections among ESs of MV/LV substations reduce the currents that flow into the ESs and, consequently, the EPRs. In case "Bonino" substation was disconnected from the neighbouring ones, the total SLGF current (206.4 A) would flow into the ES, producing an EPR of 1569 V. The actual situation is instead presented in Fig. 10, where the distribution of the fault current to the neighbouring substations and the consequent reduction in the EPR are highlighted.

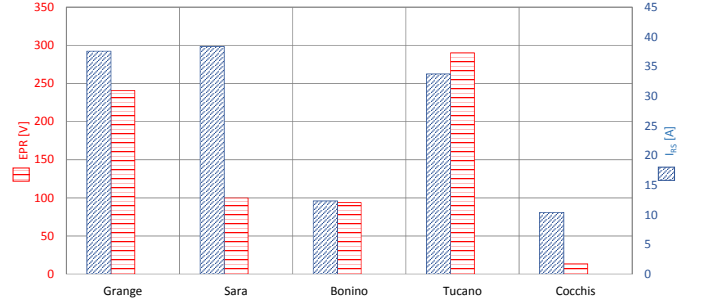

Fig. 10. EPR and earth currents in the considered substations.

In the faulted substation, "Bonino", thanks to the interconnection, the reduction of the EPR is about 94%. It is also interesting to observe that not necessarily the faulted substation injects into the ground the highest current (in the considered feeder the biggest currents are drained by the ground-grids of the neighbouring substations (Sara, Tucano and Grange). In addition to this, the substations which receive the biggest currents do not always present the highest EPRs (e.g. substation Sara).

The results presented here show that, considering only the RMS of currents, the ground-grid of the faulted substation receives only 6% of the fault current, while the upstream cable sheaths drain 71% and the downstream cable sheaths 30% of the fault current. These percentages can be compared, and a good agreement is found, with those measured by Fickert et al. [16], even if the test performed by them was not a real SLGF due to the earthing of one of the healthy phases through a resistance in the HV/MV substation. In [16] the ratio I_{RS}/I_F was found to be in the range 3% ÷ 4%, but in the tests also the LV neutrals contribution was considered.

Standard EN 50522 [6] provides in Annex I the reduction factors r to be used for the design of ESs. The reduction factor r is defined as the ratio of the return current in the earth to the sum of the zero sequence current of the 3-phase circuit, as in eq. (3).

$$r = \frac{I_E}{3I_0} = \frac{3I_0 - I_{EW}}{3I_0} \quad (3)$$

where I_{EW} is the current in the earth wire, I_E is the earth return current and $3I_0$ is the sum of zero sequence currents, equal to the fault current in systems with isolated neutral. The reduction factors are in fact thought and presented for overhead lines. The same definition is relevant to the reduction factor r of an underground cable with metal sheath: instead of the current in the earth wire I_{EW} the current in the metal sheath has to be used [6]. In this case there are not multiple groundings along the line, as with tower footings for overhead lines. For this reason we may assume that the current I_E and the current I_{RS} are identical, and the ratio I_{RS}/I_F obtained from the measurements can be compared with factors r provided by the Standard.

The typical values provided for MV cables are reported in Table III. According to the Standard the portion of fault current flowing to the ES of the faulted substation should

TABLE III
TYPICAL VALUES OF REDUCTION FACTORS OF CABLES (50 Hz)
PROVIDED BY EN 50522

MV Cable type	r
Paper-insulated Cu 95 mm ² /1,2 mm lead sheath	0.20 ÷ 0.60
Paper-insulated Al 95 mm ² /1,2 mm aluminium sheath	0.20 ÷ 0.30
Single-core XLPE Cu 95 mm ² /16 mm ² copper screen	0.5 ÷ 0.6

be in the range 20% ÷ 60%: this assumption seems to be quite conservative if compared with the measurements results presented here and by other authors.

V. CONCLUSION

In this paper the problem of SLGF in a HV/MV system is presented. A real fault was made on a real distribution network and the fault currents were measured with current clamps connected to digital high-speed waveform recording devices in the faulted MV/LV substation and in the four neighbouring ones.

The measurements results show that in distribution systems with interconnected grounding systems only a small portion of the fault current is injected into the ground by the ground-grid of the faulted substation (in S. Gillio less than 10%). In case also the contribution of the LV neutrals is considered, the percentage becomes even lower. The results presented here are in good agreement with those measured in other distribution networks by other authors.

The typical values of reduction factors of cables proposed by Standard EN 50522 appear to be quite conservative if compared with the measurements results presented here, also considering that in the tests the contribution of LV neutrals was not taken into account.

In the specific case presented here, the faulted substation injects into the ground a current that is lower than those injected by the neighbouring ones. This is obviously a particular situation, due to the network structure. Nevertheless, in general, the most dangerous situation can happen in the neighbouring substations: people's safety depends on the structure of the distribution system as a whole. Also for this reason, the concept of Global Earthing System is of utmost importance.

In case the distribution system is operated with resonant earthing, the fault current is reduced to a few dozen A. The strong reduction of the current injected into the ground, demonstrated by the field measurements, can be in this case sufficient to guarantee safety from electric shock without other requirements.

ACKNOWLEDGMENT

This work has been developed under the Project *METER-GLOB Contributo delle masse estranee estese alla "rete di terra globale"* Funded by CCSE Cassa Conguaglio per il settore Elettrico.

REFERENCES

- [1] G. Parise, F. Gatta, and S. Lauria, "Common grounding system," in *Industrial and Commercial Power Systems Technical Conference, 2005 IEEE*. IEEE, 2005, pp. 184–190.
- [2] A. Campoccia, E. Sanseverino, and G. Zizzo, "Analysis of interconnected earthing systems of MV/LV substations in urban areas," in *43rd International Universities Power Engineering Conference, 2008. UPEC 2008.*, 2008.
- [3] J. R. Dunki-Jacobs and C. St Pierre, "The function and composition of the global industrial grounding system," *Industry Applications, IEEE Transactions on*, vol. 42, no. 1, pp. 172–185, 2006.
- [4] R. Tommasini, E. Pons, and S. Toja, "MV ground fault analysis and global grounding systems," 2004.
- [5] *Power installations exceeding 1 kV a.c.* CENELEC Harmonization Document HD 637 S1, 1999.
- [6] *Earthing of power installations exceeding 1 kV a.c.* CENELEC Standard EN 50522:2010-11, 2010.
- [7] *Power installations exceeding 1 kV a.c. - Part 1: Common rules.* IEC Standard 61936-1:2010-08, 2010.
- [8] M. Desmedt, J. Hoeffelman, and D. Halkin, "Use of a global earthing system to implement the safety requirements for protecting against indirect contacts in HV systems," in *Electricity Distribution, 2001. Part 1: Contributions. CIRED. 16th International Conference and Exhibition on (IEE Conf. Publ No. 482)*, vol. 2. IET, 2001, pp. 10–pp.
- [9] G. Cafaro, P. Montegiglio, F. Torelli, A. Barresi, P. Colella, A. De Simone, M. Di Silvestre, L. Martirano, E. Morozova, R. Napoli, G. Parise, L. Parise, E. Pons, E. Riva Sanseverino, R. Tommasini, F. Tummolillo, G. Valtorta, and G. Zizzo, "Influence of LV neutral grounding on global earthing systems," in *Proceedings of the 15th IEEE International Conference on Environment and Electrical Engineering*. IEEE, 2015, submitted for publication.
- [10] L. Martirano, G. Parise, L. Parise, A. Barresi, G. Cafaro, P. Colella, M. Di Silvestre, P. Montegiglio, E. Morozova, R. Napoli, E. Pons, E. Riva Sanseverino, S. Sassoli, R. Tommasini, F. Torelli, F. Tummolillo, G. Vagnati, G. Valtorta, and G. Zizzo, "A practical method to test HV/MV substation grounding systems," in *Proceedings of the 15th IEEE International Conference on Environment and Electrical Engineering*. IEEE, 2015, submitted for publication.
- [11] M. Di Silvestre, E. Riva Sanseverino, G. Zizzo, A. Barresi, G. Cafaro, P. Colella, A. De Simone, L. Martirano, P. Montegiglio, E. Morozova, R. Napoli, G. Parise, L. Parise, E. Pons, R. Tommasini, F. Torelli, F. Tummolillo, and G. Valtorta, "The global grounding system: Definitions and guidelines," in *Proceedings of the 15th IEEE International Conference on Environment and Electrical Engineering*. IEEE, 2015, submitted for publication.
- [12] J. van Waes, F. Provoost, J. van der Merwe, J. Cobben, A. van Deursen, M. van Riet, and P. van der Laan, "Current distribution in LV networks during 1-phase MV short-circuit," in *Power Engineering Society Winter Meeting, 2000. IEEE*, vol. 4. IEEE, 2000, pp. 2385–2390.
- [13] E. Pons, P. Colella, R. Napoli, and R. Tommasini, "Impact of MV ground fault current distribution on global earthing systems," *Industry Applications, IEEE Transactions on*, 2015.
- [14] A. Campoccia, M. L. Di Silvestre, and G. Zizzo, "An analysis methodology to evaluate the contribution to electrical security given by bare buried conductors in a system of intertied earthing grids," in *Power Tech Conference Proceedings, 2003 IEEE Bologna*, vol. 3. IEEE, 2003, pp. 8–pp.
- [15] A. Campoccia and G. Zizzo, "A study on the use of bare buried conductors in an extended interconnection of earthing systems inside a MV network," in *Electricity Distribution, 2005. CIRED 2005. 18th International Conference and Exhibition on*. IET, 2005, pp. 1–5.
- [16] L. Fickert, E. Schmutzger, C. Raunig, and M. J. Lindinger, "Verification of global earthing systems," in *Electricity Distribution (CIRED 2013), 22nd International Conference and Exhibition on*. IET, 2013, pp. 1–4.