



Session

The development of electric mobility in Italy: plan and government incentives, the most advanced experiences and new trends in supply

Range of competitiveness of road FEV :
mobility of passengers and freight transport analysis,
performances and possible solutions

Ambito di competitività dei veicoli elettrici su strada: analisi di mobilità di persone e del trasporto merci, prestazioni e possibili soluzioni.

Torino - I, Thursday - 26th of September 2013, p.m.

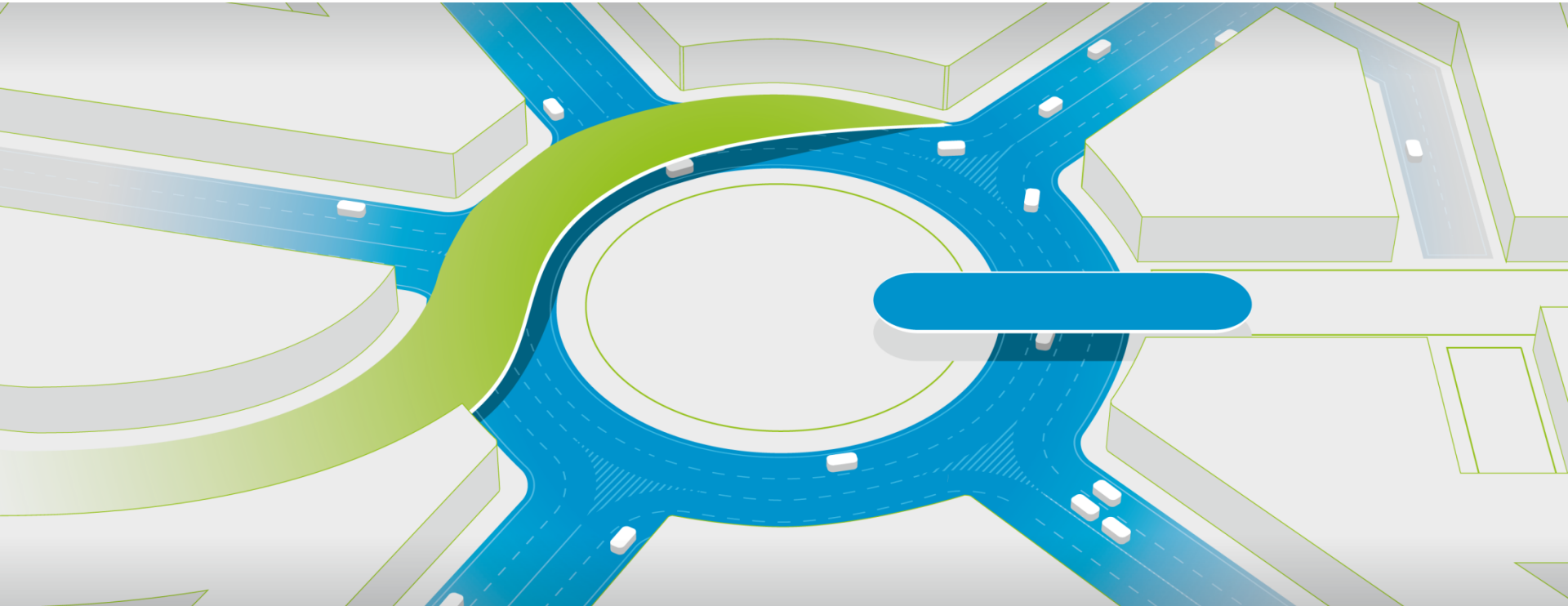

eCo-FEV

Sept. 2012- May 2015

EcO-FEV EU project working group, Politecnico di Torino

Torino - I , Lingotto, 26th of Sept. 2013

*Presented by:
prof. Bruno DALLA CHIARA, Transport Engineering
(Politecnico di Torino)*

This project is co-funded
by the European Union



Aims

1. Analysis of **typical travels of vehicles** (passengers/freight), on the basis of the international mobility beside specific national or local
2. Area of **competitiveness of FEV** on the base of the analysis of demand
3. Performances and limitations on the supply side: **autonomy, batteries, power, performances, consumptions**
4. **Recharging possibilities** most suitable on the bases of the previous items
5. Consequent choices, with examples of di UC (use case) of the EcOFEV
6. Possible technical solutions.

Premise: why?

Some figures, at European level (EU White Book on transports of 2001 [COM/2001/0370 def.]) estimated dependence on black oil at the 98%; in the USA it was estimated at 96% in the same period, reduced to **93.2% in 2010** [US Transportation Energy Data Book 2011, Ed30]). The White book on Transport Systems of 2011 reports a figure of **96% in EU**.

Demand of motorised mobility is nearly constant the last 2-3 years, but expressed in different ways in the last decades (urban contexts)

*The electrification of road transport is considered a key element in EU and worldwide for reducing the **near-monopoly of black oil** in this field and, consequently, local greenhouse gas (GHG) emissions generated by internal combustion engines, largely used at present for the whole travels.*

WHITE PAPER

Roadmap to a Single European Transport Area – Towards a competitive and resource efficient transport system

Brussels, 28.3.2011 - COM(2011) 144 final

“17. The challenge is to break the transport system’s dependence on oil without sacrificing its efficiency and compromising mobility.”

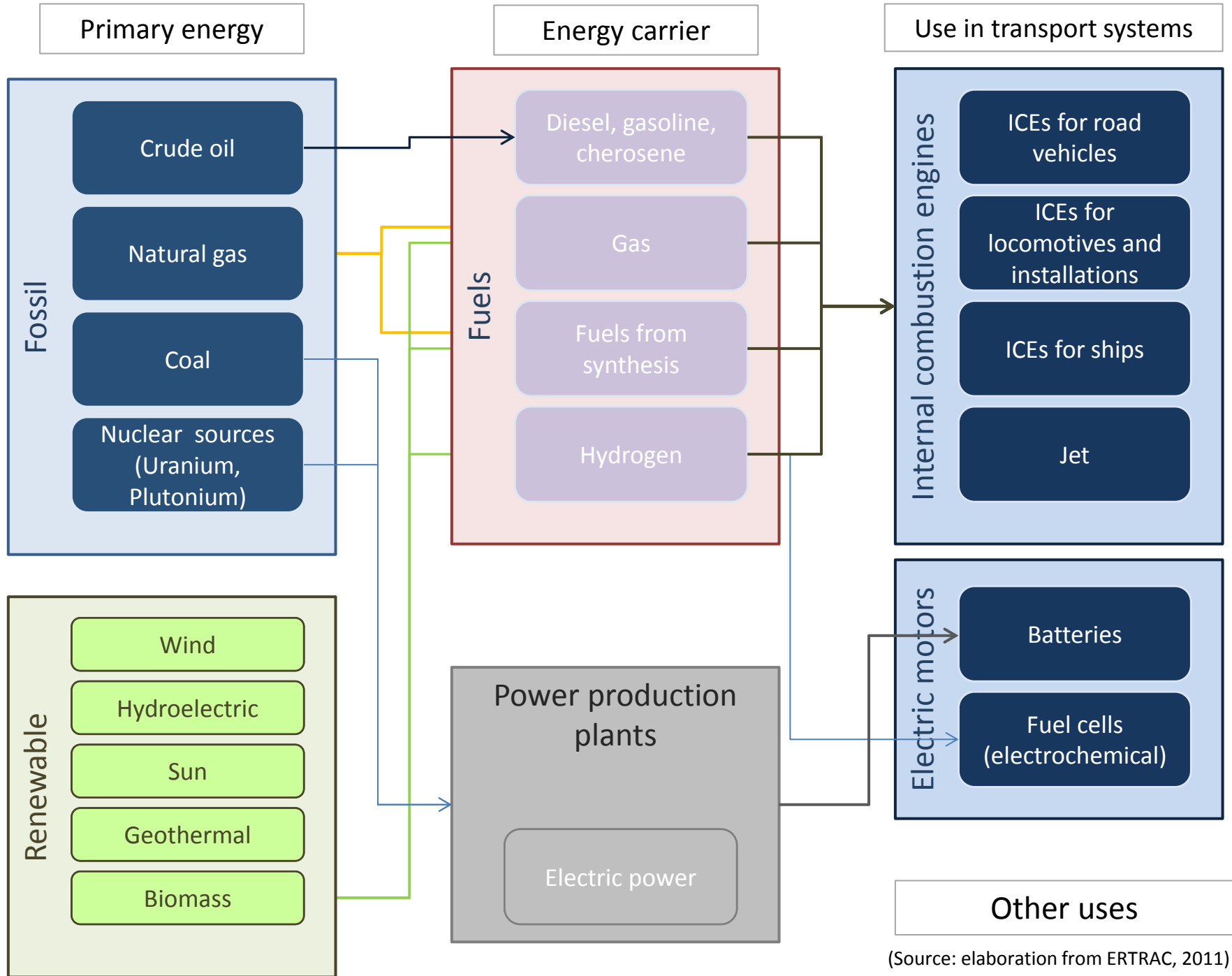

(Source: elaboration from ERTRAC, 2011)

Analysis of typical travels of vehicles
(passengers/freight), on the basis of the international
mobility beside specific national or local

Average distances covered in Italy

Starting from different samples, the following studies individuate comparable results:

AVERAGE DAILY VEHICLE DISTANCE [km]	
ISFORT	35,1
Polito⁽¹⁾	34,8
«5T» (Turin ITS centre)	32,1
CNIT/MIT 2004⁽²⁾	33,8
Polimi⁽³⁾	38,7

AVERAGE VEHICLE TRIP LENGTH [km]		
	URBAN	EXTRA URBAN
ISFORT	4,7	25
Polito⁽¹⁾	6,2	14,4
5T	4,6	11,9

Sources:

- (1) POLITECNICO DI TORINO, Dept. DIATI-Transport. Eng., *Indagine su mezzi di trasporto e mobilità motorizzata per il personale del Politecnico di Torino*, Risultati salienti, 2013
- (2) MINISTERO DELLE INFRASTRUTTURE E DEI TRASPORTI, *Conto nazionale delle infrastrutture e dei trasporti*, 2004
- (3) S. CASERINI, C. PASTORELLO, P. GAIFAMI, L. NTZIACHRISTOS, *Impact of the dropping activity with vehicle age on air pollutant emissions*, 2013

Distribution of daily travels (working days)

Average vehicle trip length distribution

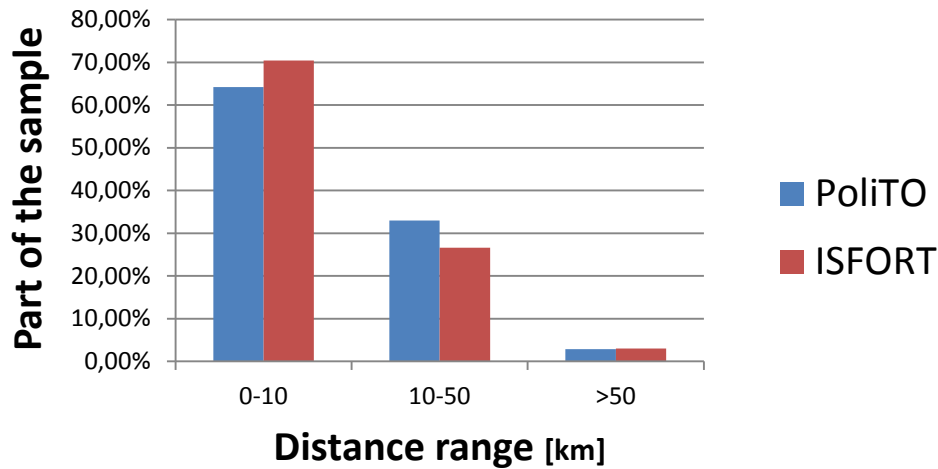

Average vehicle trip length distribution

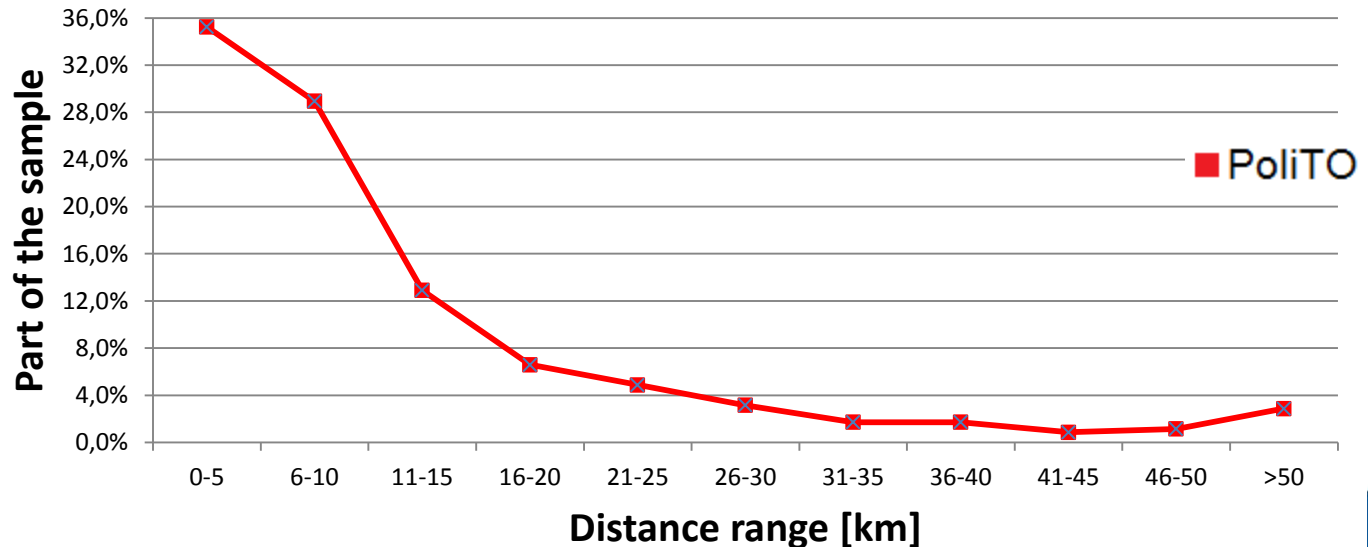

Comparison between Italy and USA trends

After a period of continuous growth of the road transports, a period of stabilisation or inflection of the demand is showed also in the USA

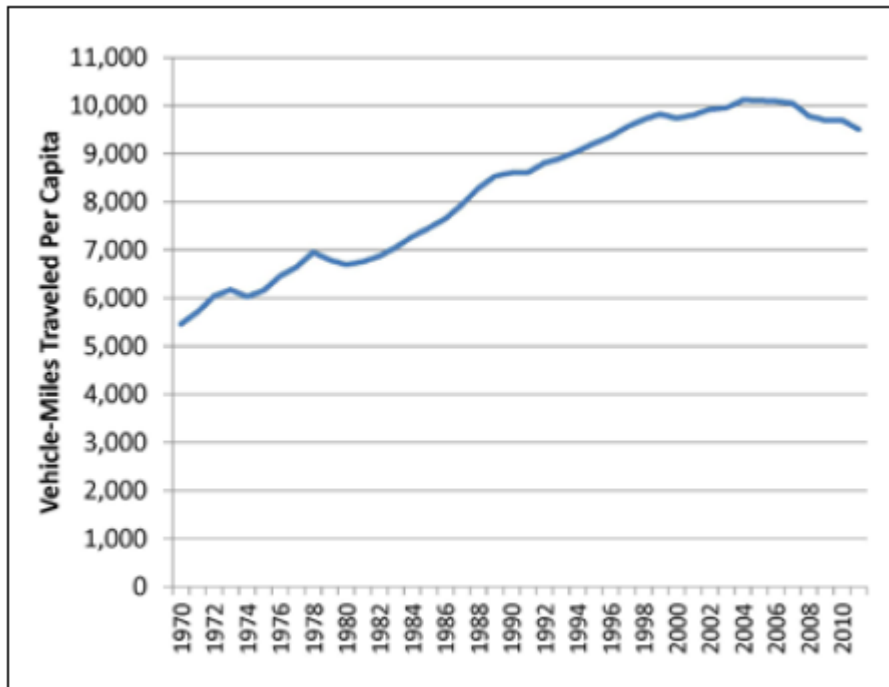

Source: FRONTIER GROUP and U.S. PIRG EDUCATION FUND, Transportation and the new generation – Why young people are driving less and what it means for transportation policy, 2012

Average daily vehicle distances are higher than Italian and generally European ones, on values next to 30 miles (about 48 km)

	Number of daily vehicle trips (per driver)	Average vehicle trip length (miles)	Daily vehicle miles of travel (per driver)
1990	3.3	8.9	28.5
1995	3.6	9.1	32.1
2001	3.4	9.9	32.7
2009	3.0	9.7	29.0

Source: S.C. DAVIS, S.W. DIEGEL, R.G. BOUNDY, *Transportation Energy Data Book: edition 31, 2012*

Freight transport in Italy

AVERAGE DAILY DISTANCES [km]			
	OWN ACCOUNT	FOR HIRE	GLOBAL
CONFETRA⁽¹⁾	48,8	165,1	118,6
Ministero dell'Ambiente⁽²⁾	36,6	133,2	102,5
Autostrade per l'Italia⁽³⁾	-	-	100,6

Data from “Autostrade per l'Italia” indicate that almost half of the heavy vehicles (48%) covers a distance less than 50 km

Sources:

- (1) CONFETRA, *Trasporti interni ed internazionali per titolo di trasporto e classe di percorrenza*, 2003
- (2) MINISTERO DELL'AMBIENTE E DELLA TUTELA DEL TERRITORIO E DEL MARE, *Il trasferimento modale sui grandi assi di scorrimento*, 2013
- (3) Autostrade per l'Italia, *Il traffico sulla rete del gruppo autostrade, valori a consuntivo*, 2012

Mobility demand trend in Italy (2000-2012)

	2012	2011	2010	2009	2008	2007	2000
Spostamenti totali in un giorno medio feriale	97,5	106,6	123,8	125,4	128,1	123,5	126,2
Passeggeri*km totali in un giorno medio feriale	1.261,2	1.302,2	1.381,4	1.432,8	1.561,0	1452,0	1216,2

Fonte: Isfort, Osservatorio "Audimob" sulla mobilità degli italiani

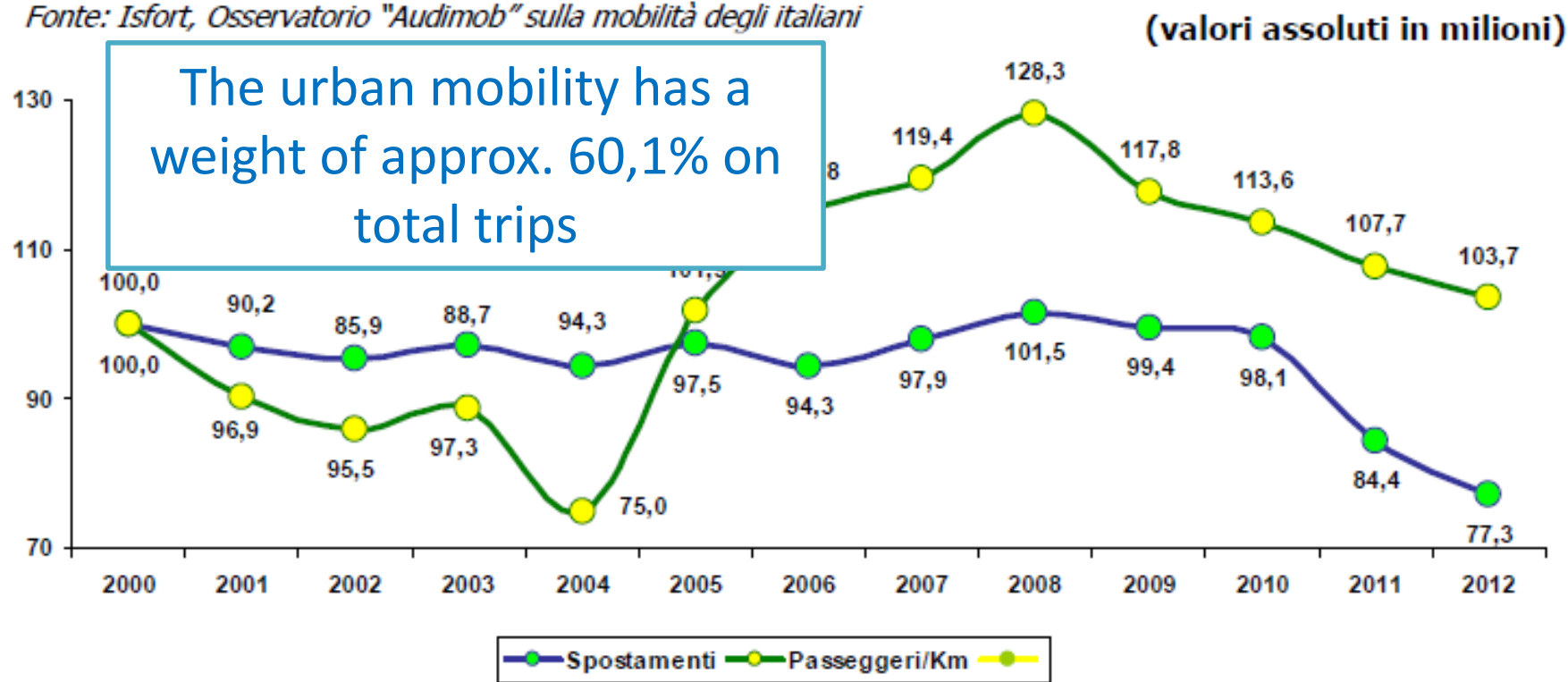

Fonte: Isfort, Osservatorio "Audimob" sulla mobilità degli italiani

Motorized mobility in Italy

Trips distribution for motorized vehicles in URBAN mobility (% values)

	2012	2011	2010	2007
Public transport	15,1	13,5	12,9	11,5
Car	79,7	79,4	80	81
Motorcycle / moped	5,2	7,1	7	7,6

Trips distribution for motorized vehicles in EXTRA-URBAN mobility (% values)

	2012	2011	2010	2007
Public transport	13,0	14,8	13,9	12,6
Car	84,7	83,0	83,0	83,9
Motorcycle / moped	2,2	2,2	3,1	3,4

Source: ISFORT, ANAV, ASSTRA, *Una leva per la ripresa – 10° rapporto sulla mobilità in Italia*, 2013

- Area of competitiveness of FEV on the base of the analysis of demand
- Performances and limitations on the supply side: autonomy, batteries, power, performances, consumptions
- Recharging possibilities most suitable on the bases of the previous items

Private transport

Freight transport

Public transport and multimodal mobility

- Area of competitiveness of FEV on the base of the analysis of demand
- Performances and limitations on the supply side: autonomy, batteries, power, performances, consumptions
- Recharging possibilities most suitable on the bases of the previous items

Private transport

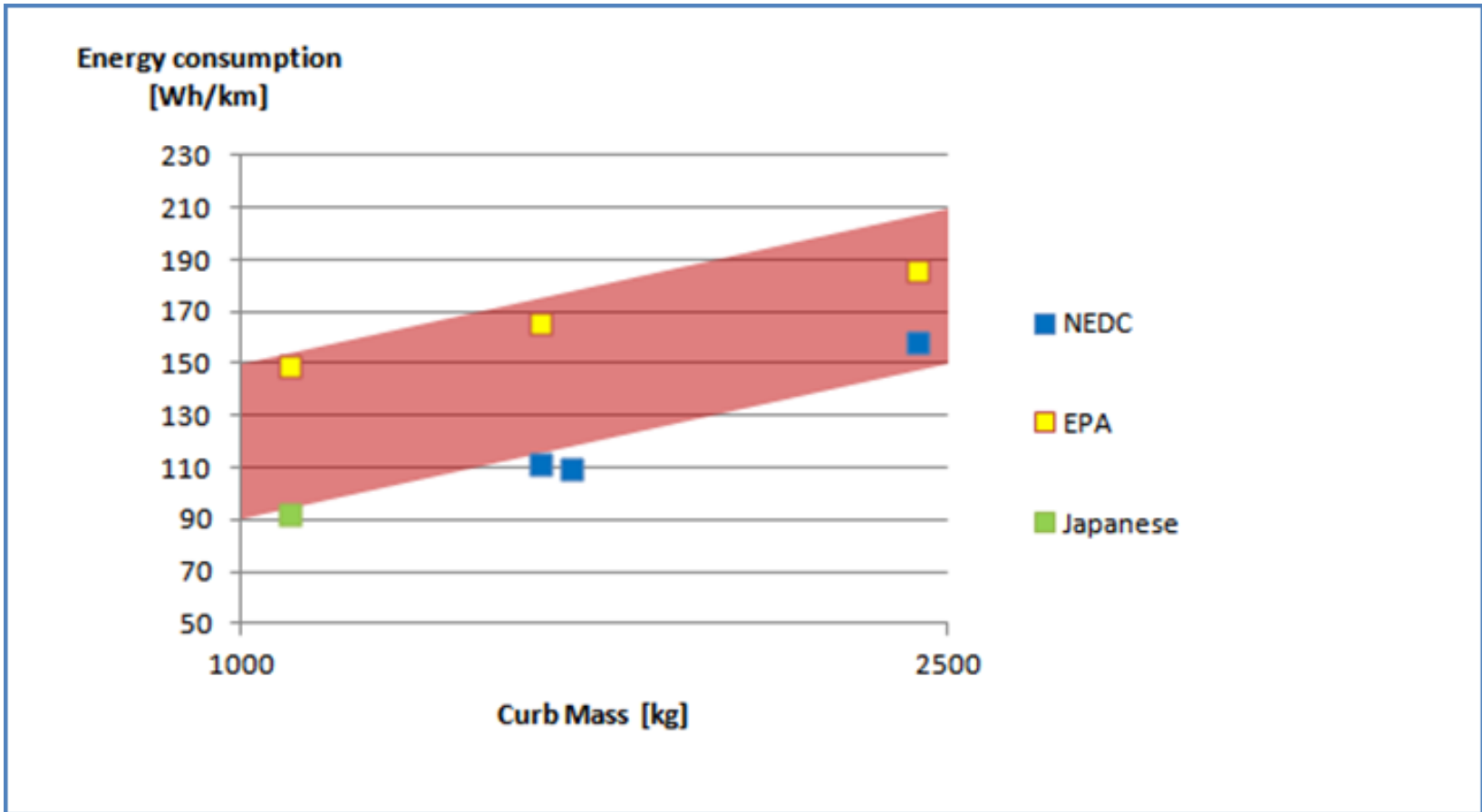

Full electric cars energy consumption range according to three driving cycles
 [elabor. by Politecnico di Torino, Filidoro, 2013]

		Maximum driving range [km] given the charging speed specified in the line below	
Curb mass [kg]	Energy consumption [Wh/km]	Slow charging: 220 V, 16 A, maximum power≈3.5 kW	Mode 2 charging: 220 V, 30 A, maximum power≈7kW
1000	150	187	373
1500	170	165	329
2000	190	147	295
2500	210	133	267

Maximum obtainable driving range, **eight-hour charging**
 [elabor. by Politecnico di Torino, Filidoro, 2013]

The calculation does not take into account the limits caused by the **batteries admissible size** though. The two types of charging methods would need respectively a 30 kWh and a 60 kWh battery pack. Recalling the Li-ion batteries characteristics, that would correspond to 200÷300 kg and 400÷600 kg respectively. Definitely it would not be possible to afford 500kg-heavy batteries in a vehicle with a total mass of 1000 kg. Small to medium electric cars are typically featured by a **20÷30 kWh battery pack**. As a consequence is possible to notice that the **limit on the maximum driving range between charges is not imposed by the charging methods, even if fast charging is not considered, but from the size of the batteries.**

Road tests performed by specialized magazines always show **real consumptions** to be higher than the one obtained through **standard driving cycles**, particularly NEDC.

There is no direct way of measuring the **State Of Charge** of a Li-Ion battery indeed. There are indirect ways of estimating it, but each suffers from limitations.

The electric cars designed in recent years show that is affordable to have approx. **up to 20% of the curb weight given by batteries**.

		Driving range [km] given the charging speed specified in the line below			
Curb mass [kg]	Energy consumption [Wh/km]	3.5 kW	7 kW	AC three-phase charging: 400 V, 30 A, max. power≈20 kW	DC fast charging: 400 V, 125 A, maximum power≈50kW
1000	150			67	167
1500	170			59	147
2000	190			53	132
2500	210			48	119

Obtainable driving range, **half-hour charging**
 [elabor. by Politecnico di Torino, Filidoro, 2013]

		Charging time [min] given the charging speed specified in the line below			
Curb mass [kg]	Energy consumption [Wh/km]	3.5 kW	7 kW	20 kW	50 kW
1000	150	90	45	16	6
1500	170	102	51	18	7
2000	190	114	57	20	8
2500	210	126	63	22	9

Charging time needed to obtain a **35 km driving range**

[elabor. by Politecnico di Torino, Filidoro, 2013]

BATTERY RE-CHARGING

A. **Conductive** charging

B. **Inductive** contactless charging (contactless implicit)

both of them can be

1. either **motionless** or **in motion** (e.g. inductive charging in motion);
2. either **driverless** or **while driving** (e.g. inductive charging while driving).

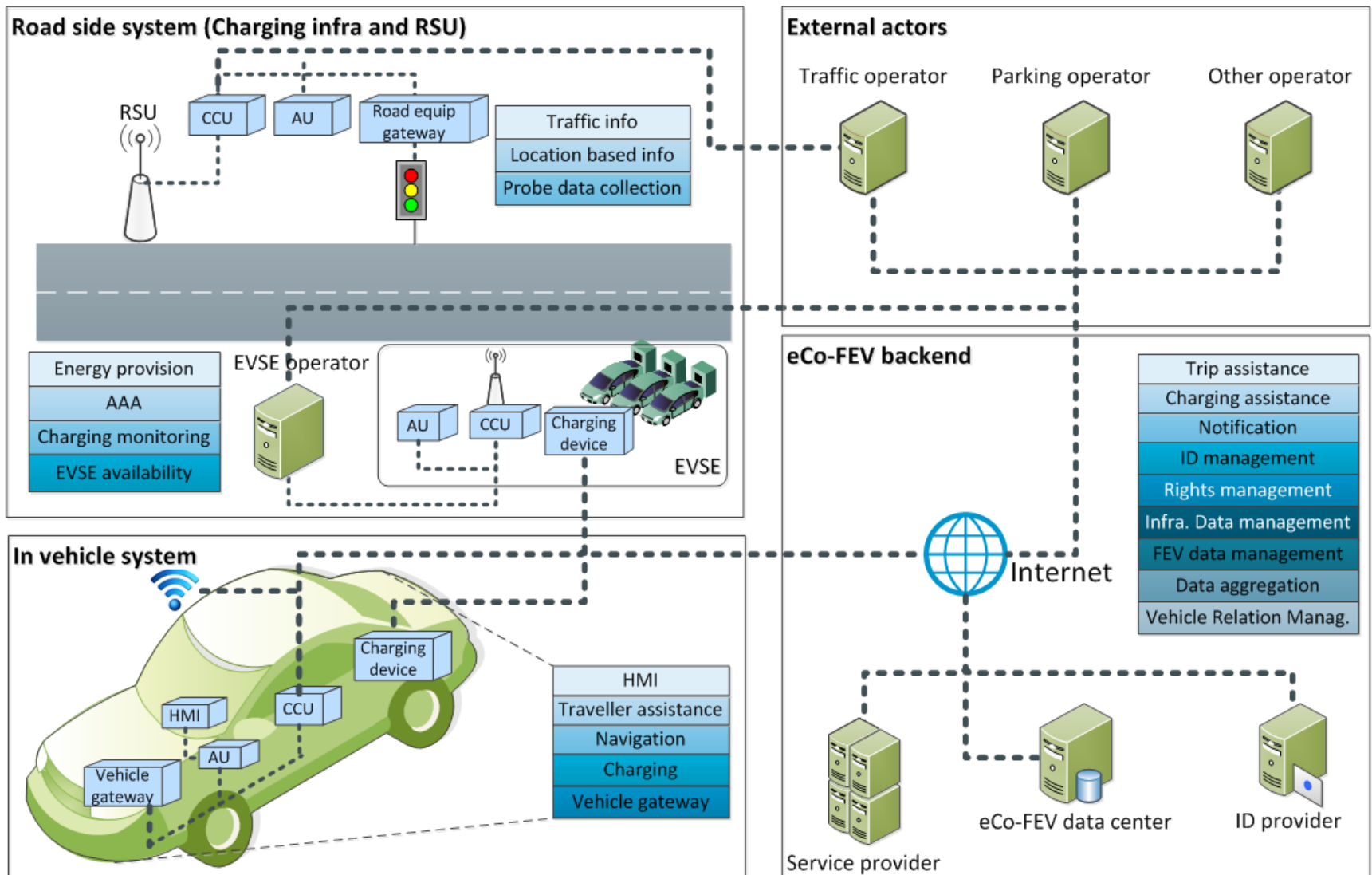

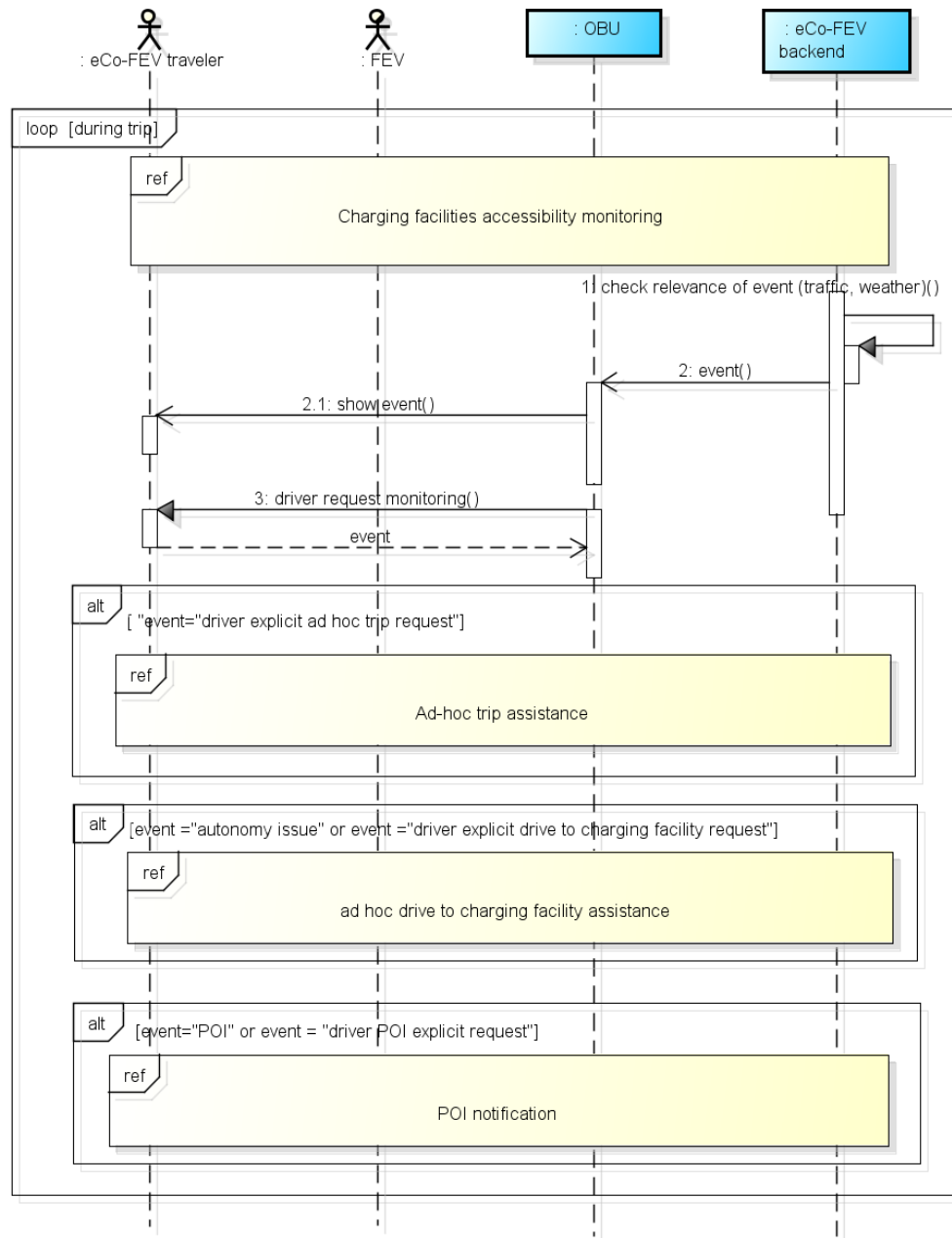

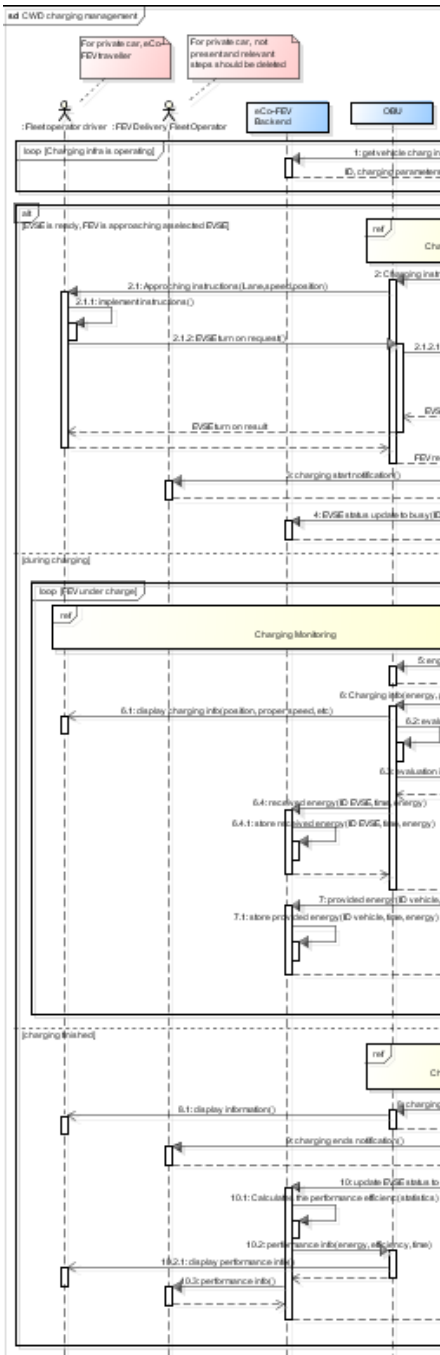

sdCWD charging management

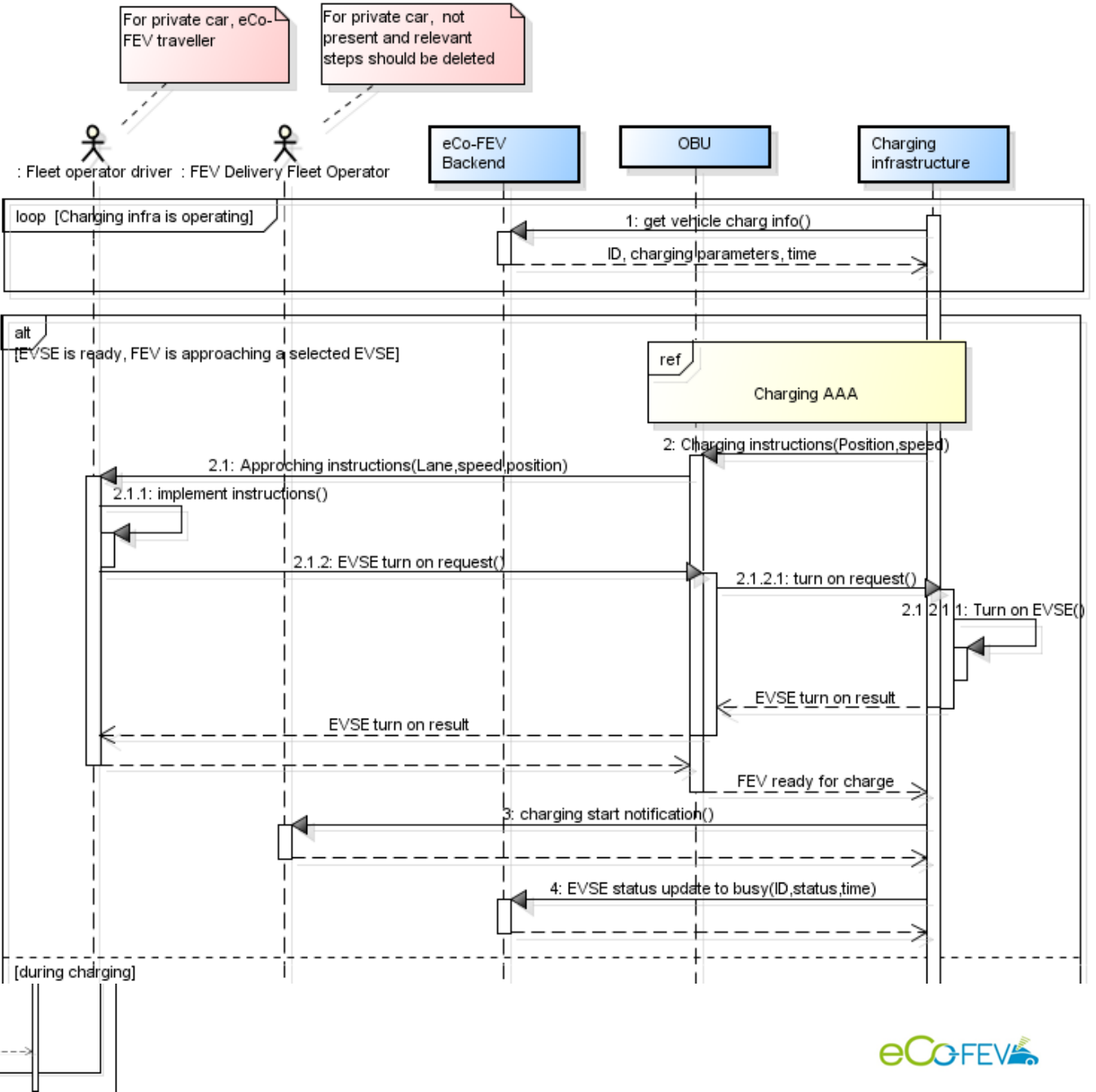

- Area of competitiveness of FEV on the base of the analysis of demand
- Performances and limitations on the supply side: autonomy, batteries, power, performances, consumptions
- Recharging possibilities most suitable on the bases of the previous items

Freight transport

Energy usage – **Freight transport**
From WELL TO WHEEL (electric drive)

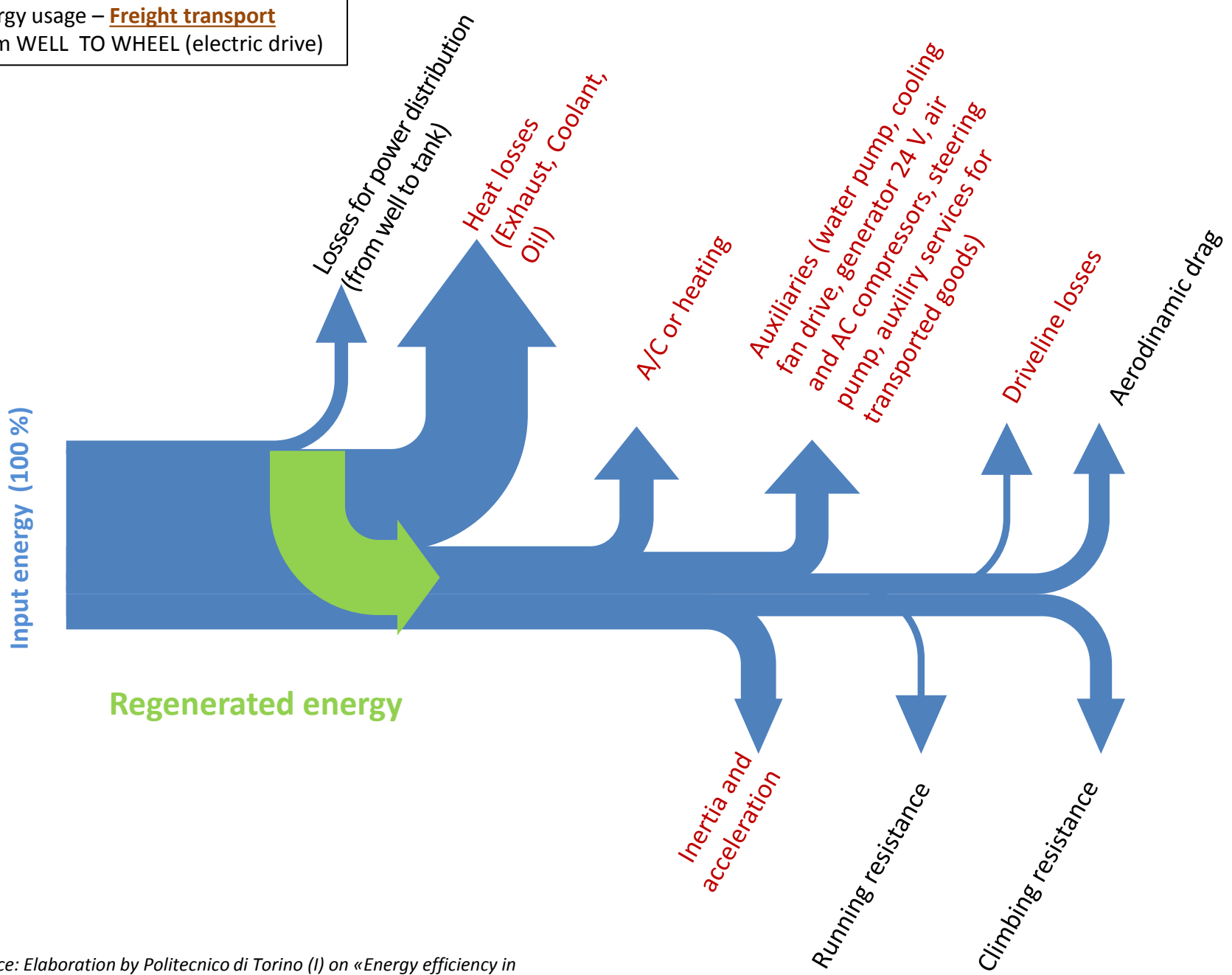

Source: Elaboration by Politecnico di Torino (I) on «Energy efficiency in public transport systems: what is the next stop on the line»? (F. Burkhart), *Public Transport International* n° 5, Sep-Oct 2012

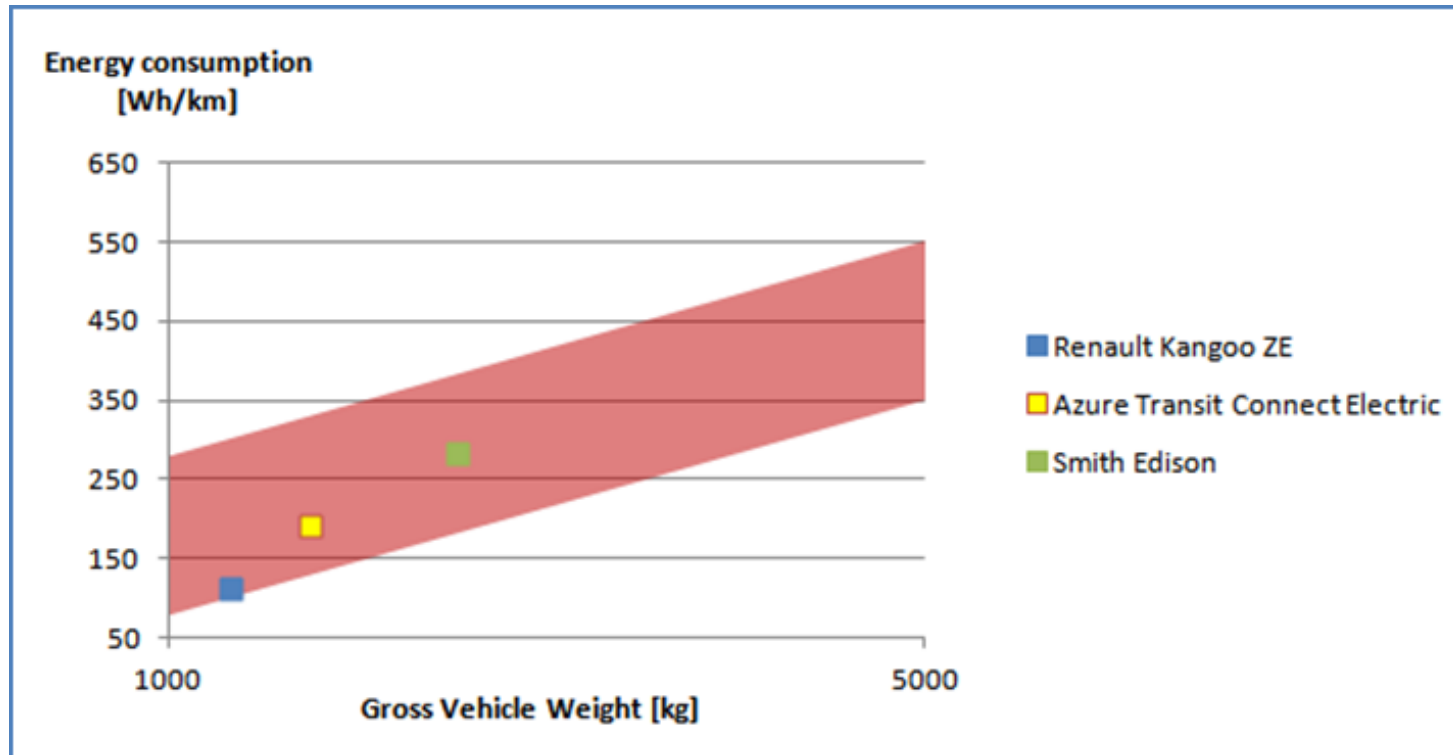

Full electric light commercial vehicles energy consumption estimation, with some examples

Payload conditions!

Maximum driving range [km] obtainable through the charging speed in the line below

Gross Vehicle Weight [kg]	Energy consumption [Wh/km]	3.5 kW charging	7 kW charging	20 kW charging
1300	300	93	187	533
2000	350	80	160	457
3500	450	62	124	356
5000	550	51	102	291

Maximum obtainable driving range, **eight-hour charging**

The calculation does not take into account again the limits caused by the batteries admissible size

Charging time [min] given the charging speed specified in the line below

Gross Vehicle Weight [kg]	Energy consumption [Wh/km]	3.5 kW	7 kW	20 kW	50 kW
1300	300	180	90	32	13
2000	350	210	105	37	15
3500	450	270	135	47	19
5000	550	330	165	58	23

Charging time needed to obtain a 35 km driving range

The calculation does not take into account again the limits caused by the batteries admissible size

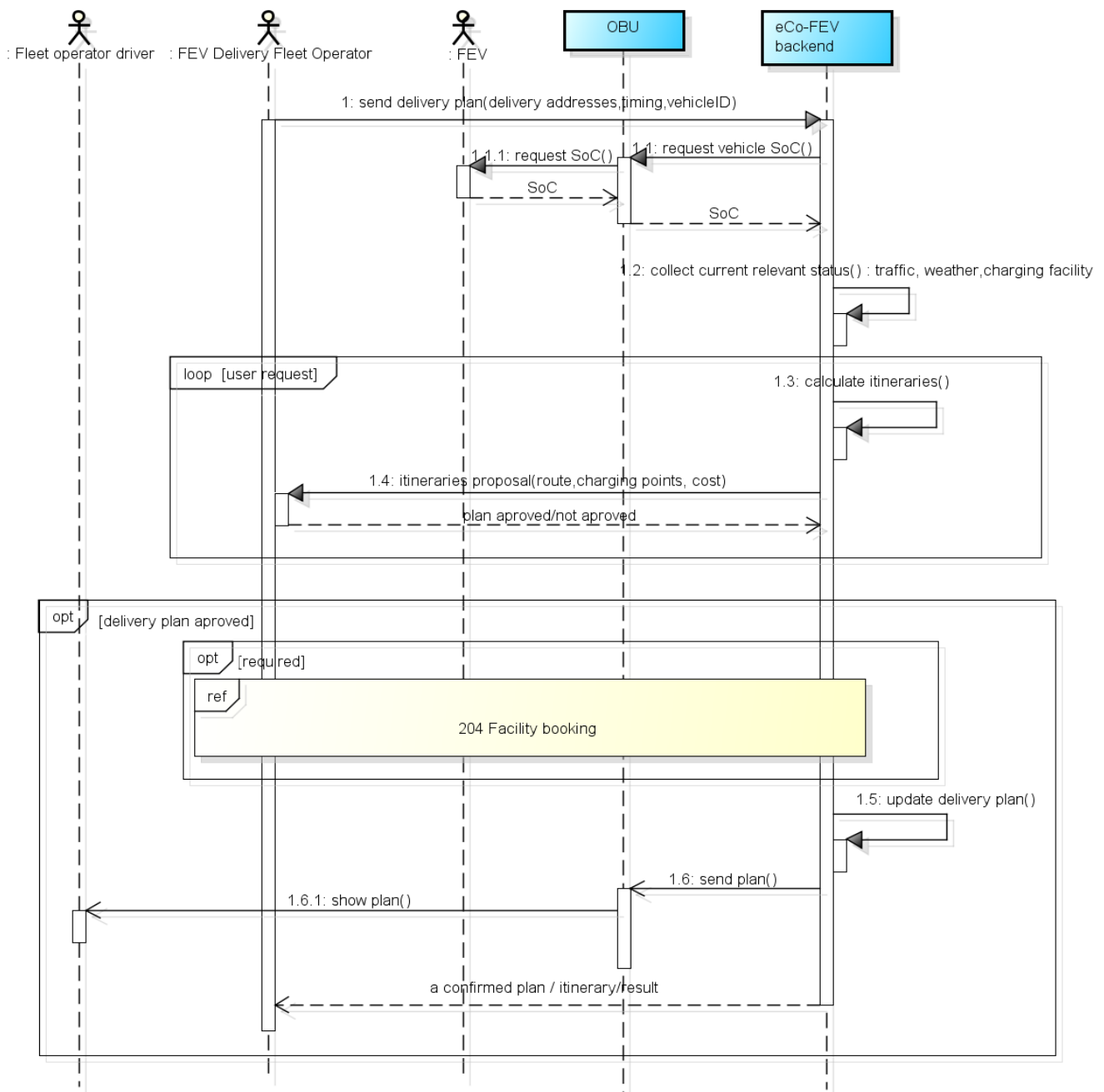

- Area of competitiveness of FEV on the base of the analysis of demand
- Performances and limitations on the supply side: autonomy, batteries, power, performances, consumptions
- Recharging possibilities most suitable on the bases of the previous items

Public transport and multimodal mobility

Main features:

- Fixed path
- Known distances
- Known and usually necessary stops
- Scheduling of activities (driver's rest) at terminals/depots

Though:

- Variability of the mass
- Possible aging effects on batteries
- Transport for a public service (no risks, no nearly-empty SOC allowed)

Factors driving change towards electrification of public transport

Global

Local

Technical

Environmental
issues and oil
depletion

Pressure to
improve
quality of city
life

Sustainable
technology
with low
running costs

Factors limiting change towards electrification of public transport

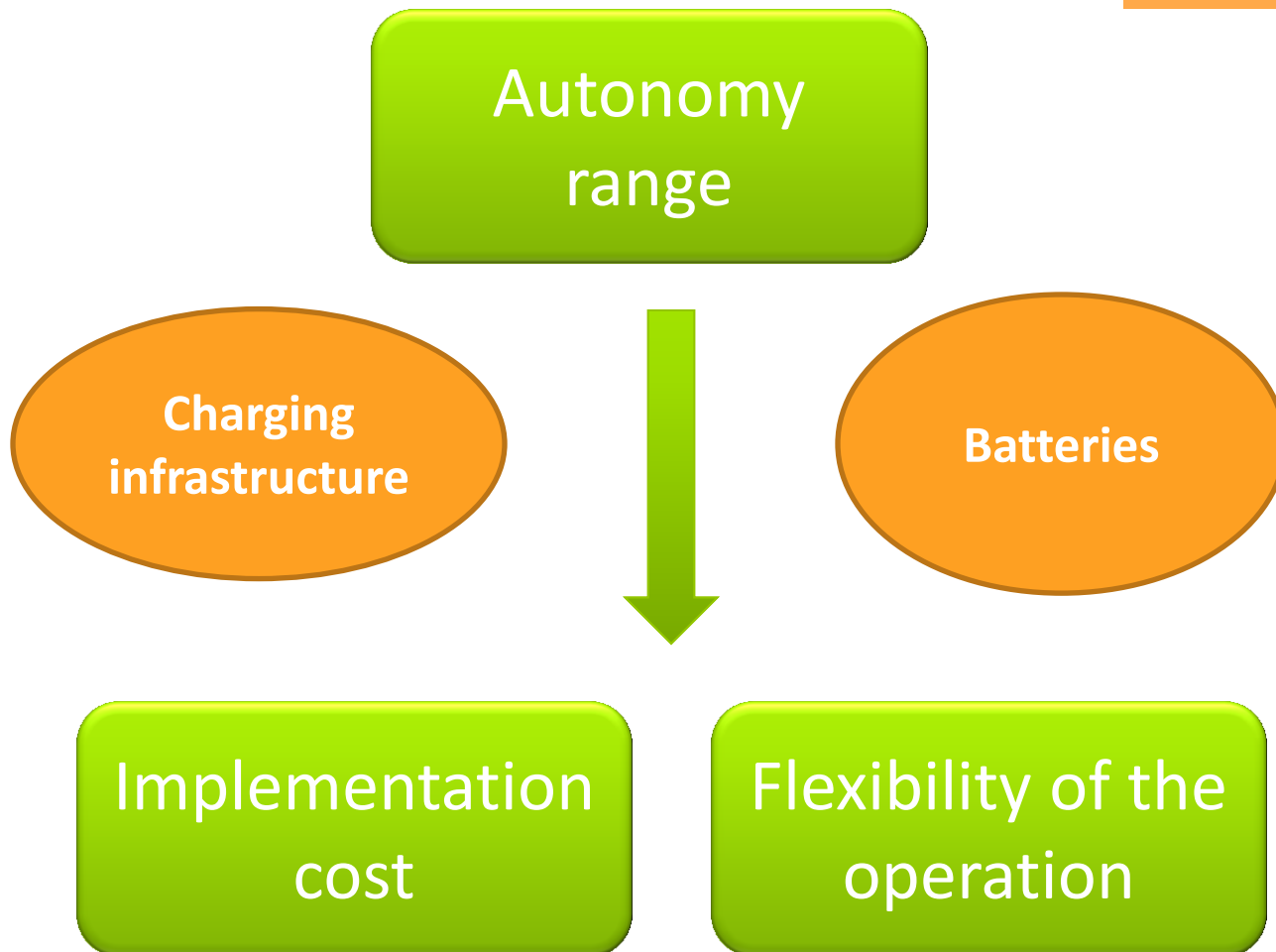

Electric energy storage element

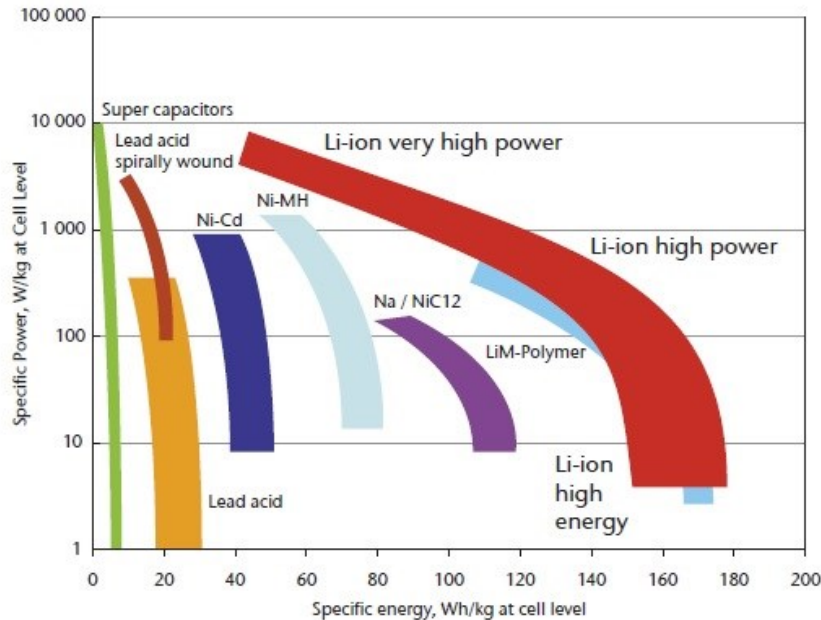

- Specific energy
- Cycle life
- Purchasing costs
- Opportunity charging



Most used

- Li-iron phosphate
- Li-titanate
- Super capacitors

- Sizing of the storage element

Electric bus typologies and energy consumption

Trolley bus
(Non autonomous)

Battery bus
(Autonomous, partially autonomous)

Capabus
(Partially autonomous)

- Dimensions
 - Number of passengers
 - Avg. energy consumption
- Energy storage element
 - Autonomy range
 - Charging time
 - Purchasing cost
- Charging devices on board
 - Adaptation to infrastructure

Electric bus typologies and energy consumption

For given traffic and route, energy consumption is mainly influenced by :

- Vehicle mass
- Auxiliary devices

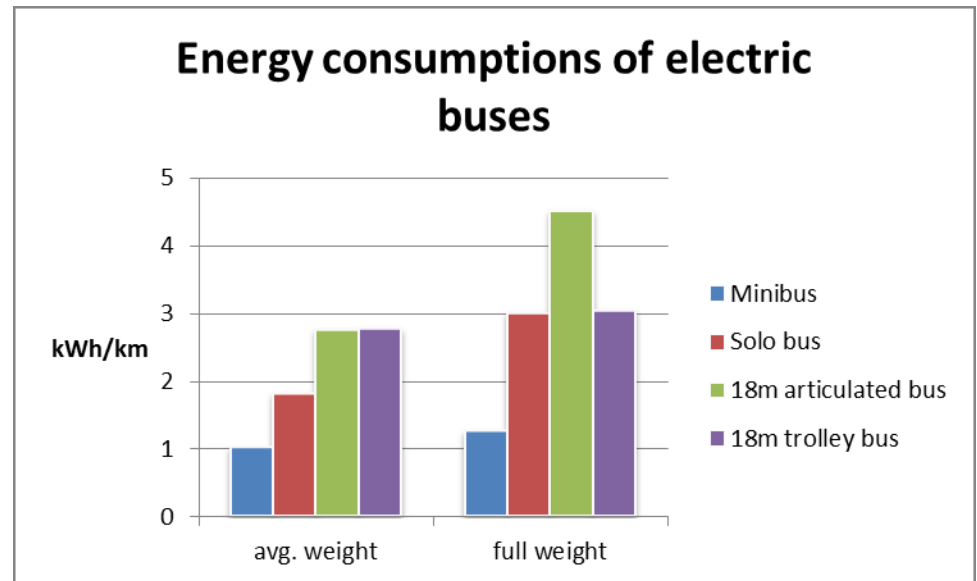

Exemplary consumption value: 1kWh/km

Investigated charging technologies and infrastructure systems

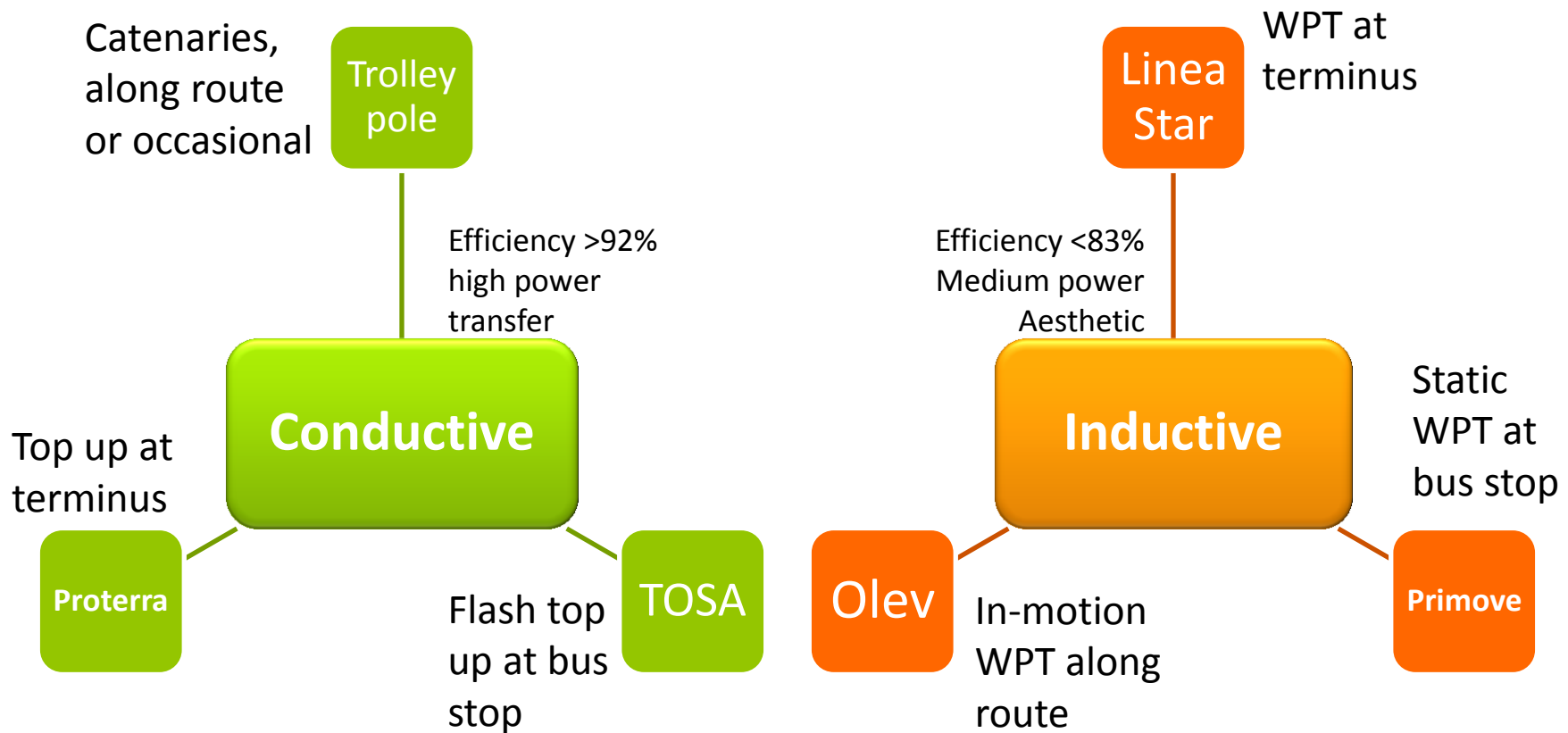

Linea Star study case: example

[source: some data were provided by GTT, Spring-Summer 2013]

Current bus characteristics:

- 7.48m, 34 passengers
- 8750-11500 kg
- Pb-gel batteries, 60.4 kWh, 1790 kg
- Three phase asynchronous motor (max 120kW, 65kW)

Route:

- Turin city center, 6km
- Total of 120km/day

Inductive charging at terminus:

- Efficiency 70%
- Power transfer $\leq 40\text{kW}$
- 10-15 minutes



Linea Star study case - current status

Pb-gel batteries	Data given by GTT
Full load energy consumption	1.25 kWh/km
Weight effect on energy consumption	0.094 kWh/km*ton

Cycle for verification 300 m

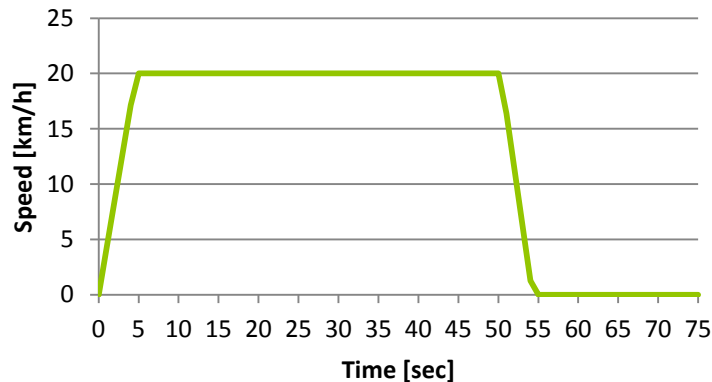

Verification of energy consumption, Pb-gel

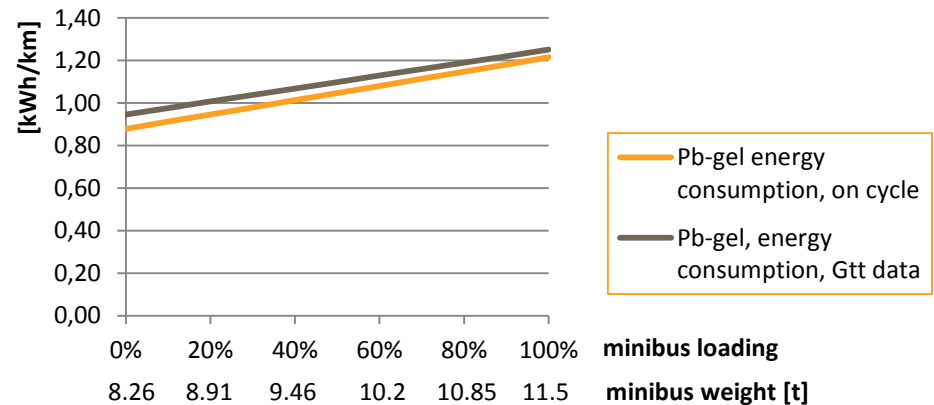

Linea Star study case - current state

Energy consumption and range autonomy, Pb-gel

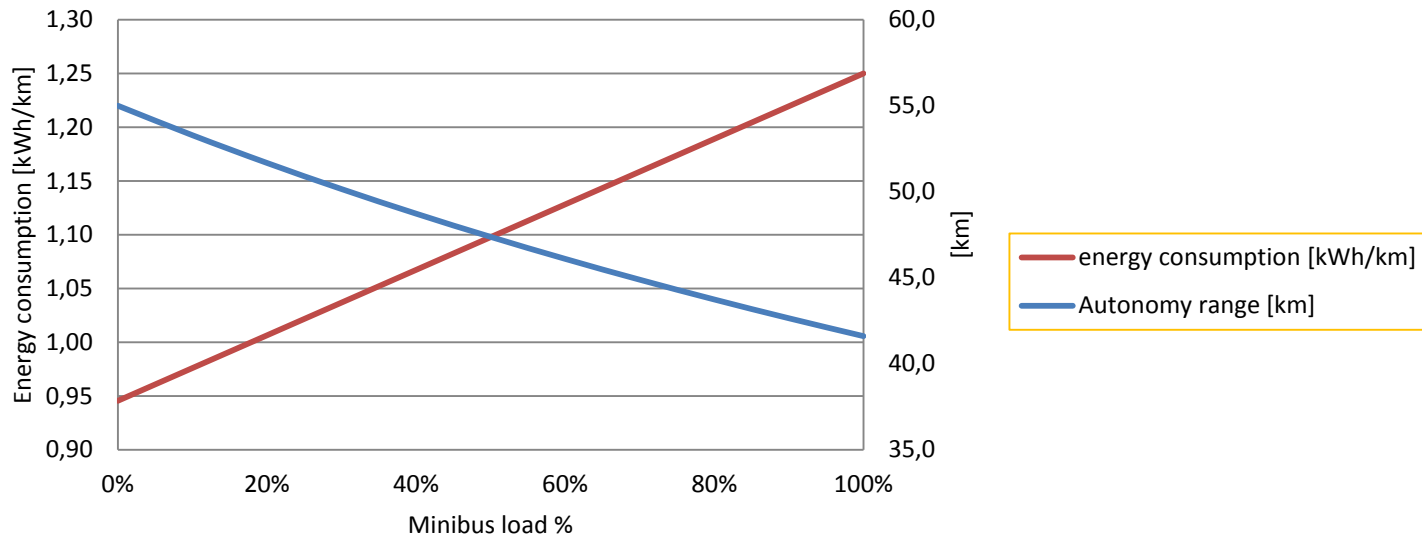

40% loading	14 passengers	9.56 ton	1.07 kWh/km	49 km
60%	20 passengers	10.2 ton	1.13 kWh/km	46 km

Linea Star study case - current state

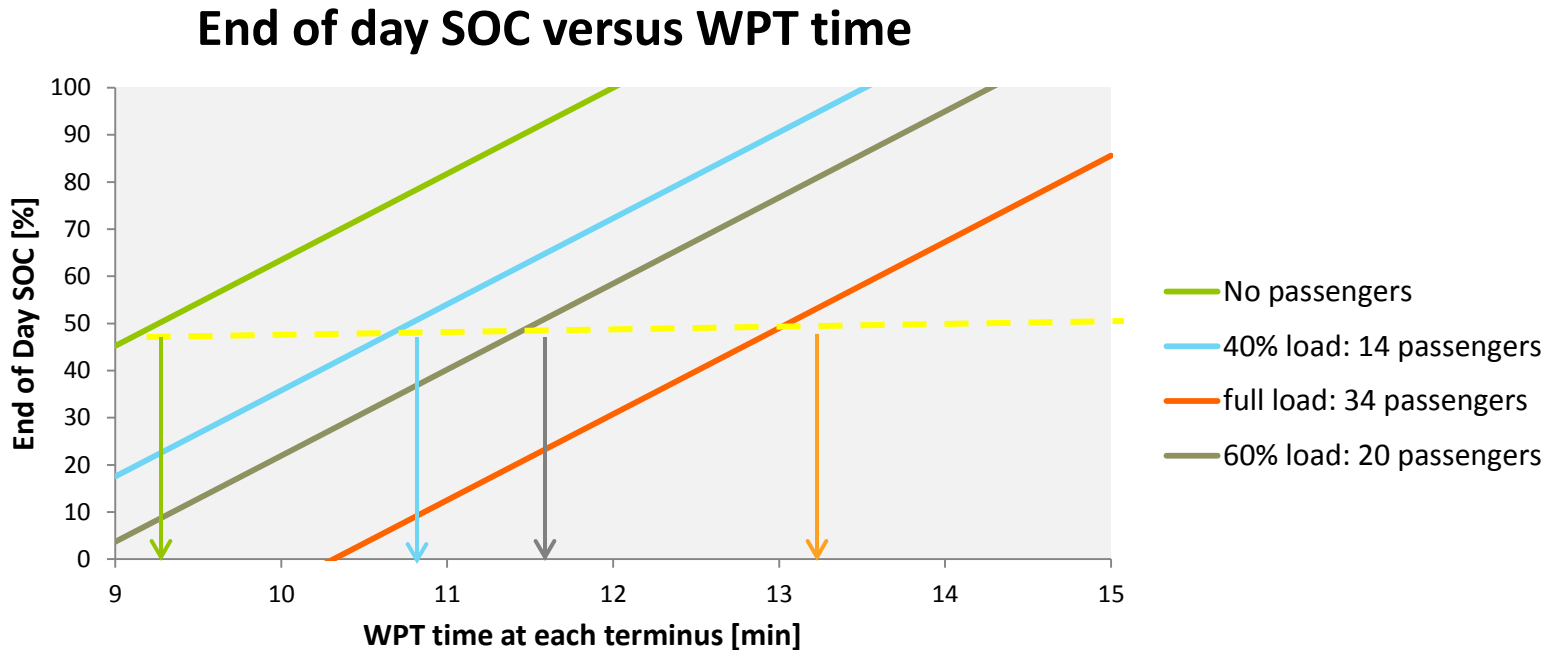

- Pb-gel useful SOC: 40-90 %

- 6km route
- 20 journeys
- 19 stops

Linea Star study case - Li-iron phosphate versus Pb-gel batteries

- Weight reduction (778 kg)
- Improvements in regenerative braking  -30% energy consumption

Energy consumption, range autonomy and data verification,
Pb-gel versus Li-iron phosphate

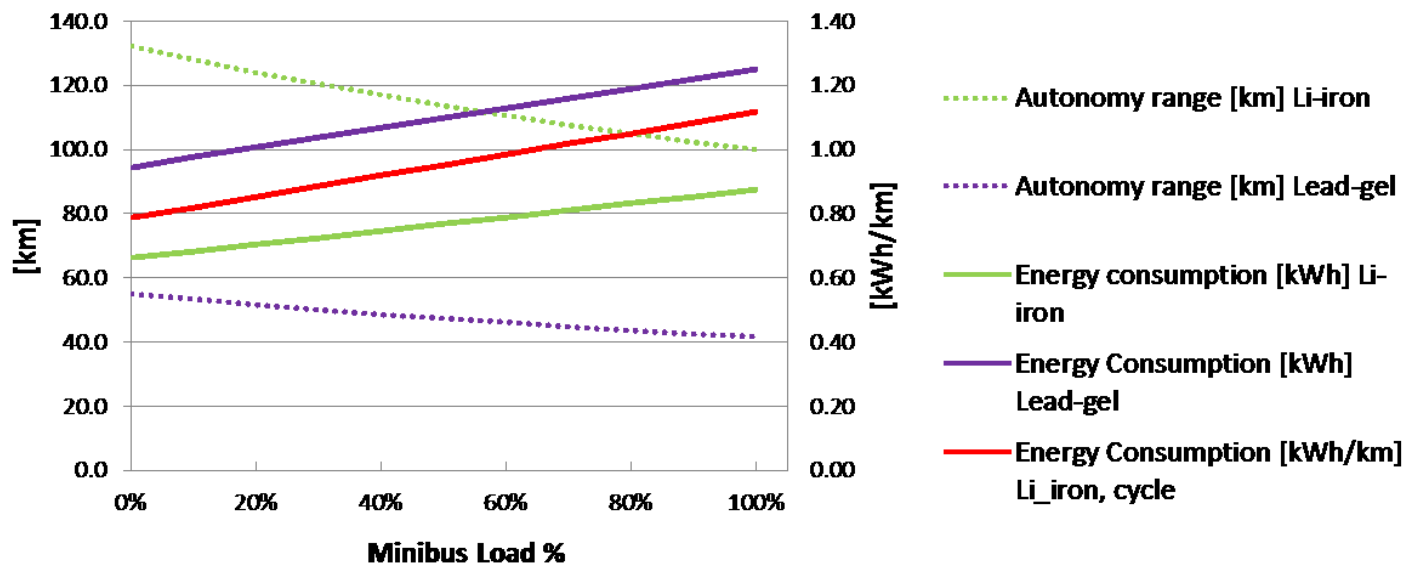

Linea Star study case - Li-iron phosphate versus Pb-gel batteries

Lead-gel vs Li-iron minibus operation for 120 km

Avg. 13.5 km/h
40% load

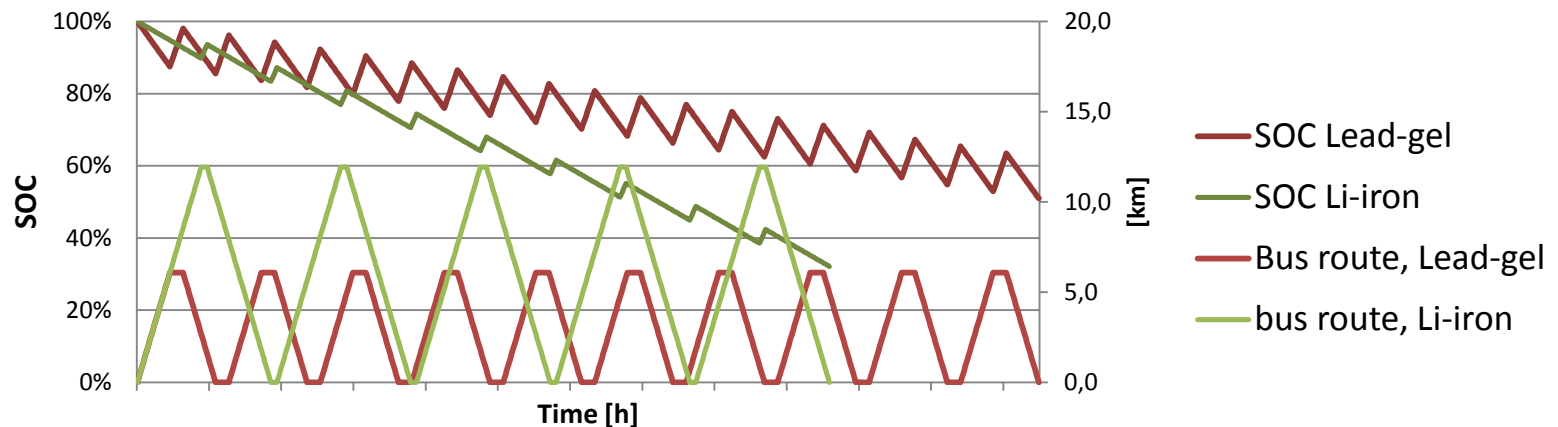

- Lead-gel (9.56 ton, 1.07 kWh/km): 20 journeys of 6km each with 19 stops of 11' for inductive charging
- Li-iron (8.78 ton, 0.75 kWh/km): 10 journeys of 12km each with 9 stops of 5' for inductive charging

sd Public transport monitoring

: eCo-
bac

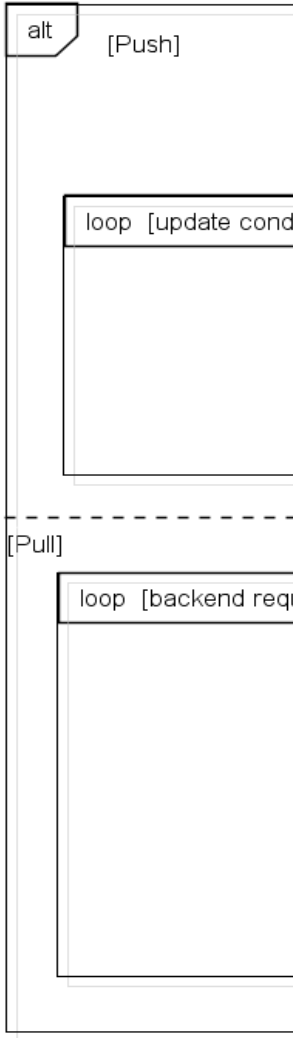

sd trip adjustment

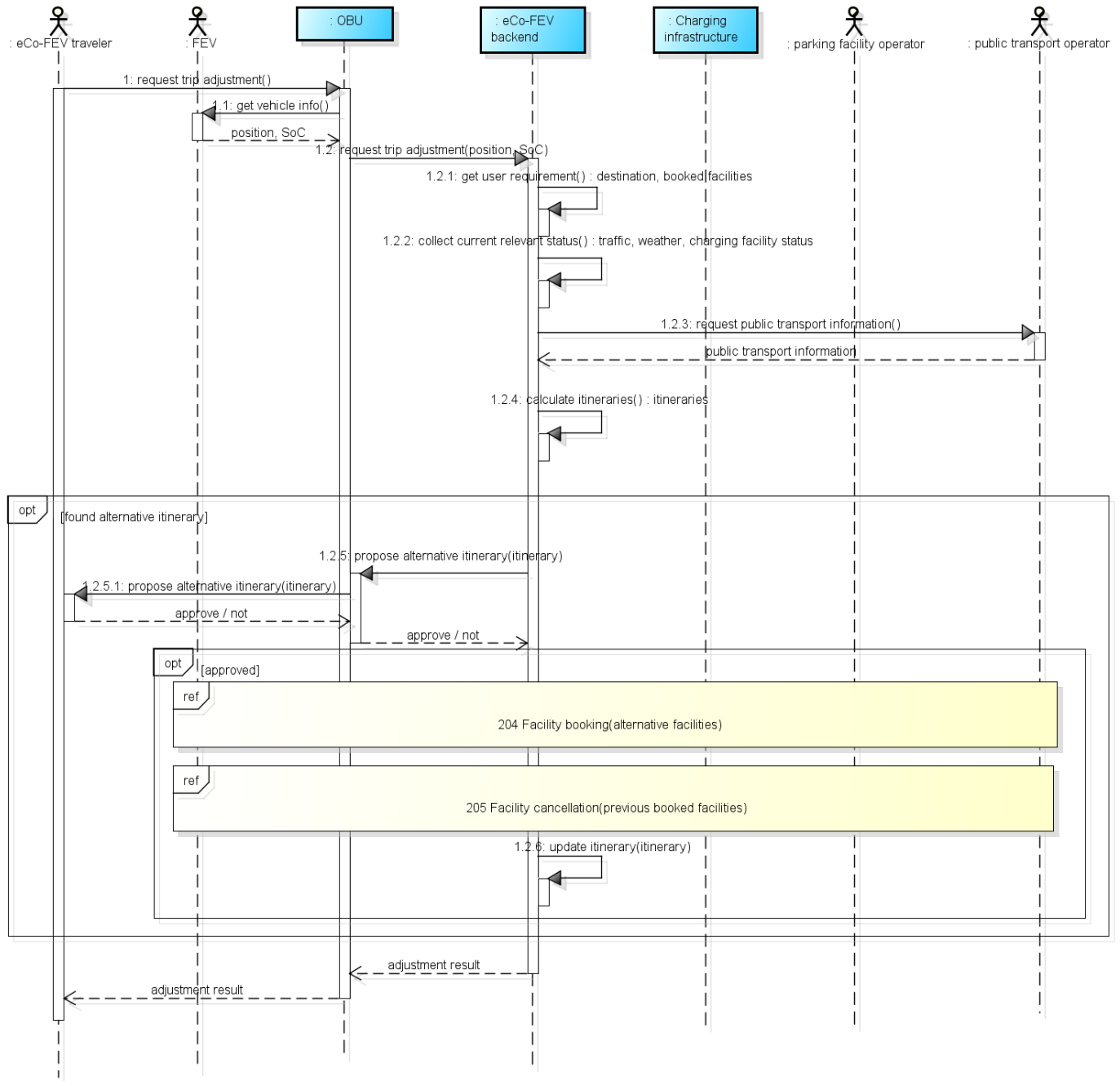

Conclusions: FEV

- A market compliant with **urban motorised personal mobility** and other specific cases (freight distribution, < 5 t – GVW; Public Transport)
- Conditioned by **use**, with preferences for known paths: actual autonomy and foreseeable SOC, recharging organisation and scheduling (e.g. PT)
- Inductive charging can be a good solution, especially in some conditions
- EV conditioned by flexible use → **PHEV**
- Heavy masses and long distances → traditional and alternative fuels

Contributions by:

Francesco DEFLORIO, Luca CASTELLO , Ivano PINNA

Paola TOMLIN, Ivan FILIDORO

Bruno DALLA CHIARA (resp.), associate professor, ph.d. eng.

POLITECNICO DI TORINO

Department DIATI - Transport Engineering

corso Duca degli Abruzzi, 24

10129 Torino - Italy - Europe

bruno.dallachiara@polito.it

© Any part of the document has to be *quoted* as :

Dalla Chiara B., *Range of competitiveness of road FEV: mobility of passengers and freight transport analysis, performances and possible solutions*, Session “The development of electric mobility in Italy: plan and government incentives, the most advanced experiences and new trends in supply”, Green Cars Forum, Lingotto - Torino (I), Politecnico di Torino - *Transport Engineering working group*, 26.09.2013