

POLITECNICO DI TORINO

Ph.D. IN CHEMICAL ENGINEERING

CYCLE XXVI

**APPLICATIONS OF ULTRAVIOLET RADIATIONS IN DYEING
PROCESSES OF YARNS AND FABRICS**

GIANLUCA MIGLIAVACCA



Tutor: Prof. FRANCO FERRERO
External Reviewer: Prof. GIUSEPPE ROSACE

Defended on 21/01/2014

Go to the ant, sluggard; consider her ways, and be wise!

(Proverbs 6, 6)

Acknowledgements

With great pleasure I would like to thank all people who made possible the writing of this thesis.

I had the luck to collaborate with good people, undoubtedly from a professional point of view but also from a personal perspective. With some of them I could couple the fruitful work relationship with a deep friendship and, in my opinion, it is the most important condition to reach good results.

I owe my deepest gratitude to my tutor, prof. Franco Ferrero, undoubtedly the person who taught me more during my degree thesis and during this PhD period. With his wide wisdom, he has been a valuable support in the difficulties. It has been a new great opportunity for me to work again under his knowledgeable guide.

A special thank to prof. Giuseppe Rosace for the valuable work of external reviewer with many suggestions and useful reports.

A big thank to ing. Monica Periolatto for her patience and willingness in many stages of my research; she was the ideal colleague that I would always find in future job opportunities!

I would like to show my gratitude to prof. Giorgio Rovero for my involvement in FILIDEA Research Projects, supplying my research fellows.

For this research work the collaboration with Filidea group of Magnonevolo was crucial. I thank ing. Luca Cinguino. and Mr. Davide Rossetti for the opportunity they gave me to spend profitable periods in their company, with all the people working at Magnonevolo plant , and above all I thank ing. Sara Gavignano From her deep competency and contagious enthusiasm I could learn the right way to approach a research work, keeping the mind always open to novelties and experimentation.

I would like to thank my colleagues of Politecnico di Torino, in particular ing. Mirco Giansetti and ing. Giuseppe Actis Grande for their valuable contribution to the research on dyeing techniques.

Also thank to ing. S. Andreoli, who choose my research field for their degree thesis.

And now, I owe my loving thanks to my family (thanks Milvia and Giovanni for your constant emotional and material support!)

But there is a but...

a special thank to all those people (and they are many, and they are too many) who have hoped and tried to stop this goal. I could say many things, but I will not. One thing you will allow me: I would like them to know that their hostility towards me gave me even more strength to the achievement of this goal; their hatred towards me has made me stronger and more stubborn! Thank you all!

Finally I thank everybody will read my thesis, maybe finding something of interest.

Gianluca Migliavacca

Summary

Introduction.....	12
Abstract.....	14
1 ST PART: LITERATURE REVIEW.....	15
Chapter 1: Update of bibliography on the subject.....	17
1.1 Introduction.....	19
1.2 Established textile UV treatments.....	20
1.2.1 <i>Enhanced wool shrinkage resistance.....</i>	<i>21</i>
1.2.2 <i>Enhanced pilling resistance on wool and cotton fabric.....</i>	<i>22</i>
1.2.3 <i>Improvement of wool dyeability.....</i>	<i>23</i>
1.2.4 <i>Preparation for wool printing.....</i>	<i>26</i>
1.2.5 <i>Alternative proposed cotton mercerization.....</i>	<i>27</i>
1.3 References.....	28
Chapter 2: Use of UV radiation on pretreatment/finishing of textiles. Study of different wavelengths and their interaction with different kind of fibres...29	
2.1 Introduction.....	31
2.2 Mechanisms of interactions.....	33
2.2.1 <i>Influence of wavelength.....</i>	<i>33</i>
2.2.2 <i>Influence of moisture.....</i>	<i>36</i>
2.2.3 <i>Influence of temperature.....</i>	<i>38</i>
2.3 References.....	39

Chapter 3: Study of interaction of UV radiation on different fibres: naturally present chromophores and related photomodifications.....	42
3.1 Introduction.....	44
3.2 Properties of chromophores.....	45
3.2.1 <i>About wool.....</i>	45
3.2.2 <i>About cotton.....</i>	45
3.3 Interaction between wool chromophores and radiation.....	46
3.4 Interaction between cotton chromophores and radiation.....	56
3.5 References.....	59
2 nd PART: EXPERIMENTAL WORK.....	60
Chapter 4: Instrumental methods and equipments.....	62
4.1 Instrumental methods.....	64
4.1.1 Reflectance colorimetry.....	64
4.1.2 <i>UV-VIS spectrophotometry.....</i>	68
4.1.3 <i>FTIR-ATR spectroscopy.....</i>	69
4.1.4 <i>SEM analysis.....</i>	70
4.2 Technical methods: fastnesses tests.....	72
4.3 Equipments.....	74
4.3.1 <i>UV static apparatus.....</i>	74
4.3.2 <i>UV dynamic apparatus.....</i>	75
4.3.3 <i>UV radiometer.....</i>	76
4.3.4 <i>Minox.....</i>	77
4.3.5 <i>OBEM API/O/1.....</i>	78
4.3.6 <i>Teintolab.....</i>	79

4.3.7	<i>Crockmeter</i>	80
4.4	References	81
Chapter 5:	Adjustment and optimization of the available tests of degree of treatment, for a fast evaluation of the intensity and uniformity of the treatment.....	82
5.1	Introduction	84
5.2	Available tests	86
5.3	Proposed test	88
5.4	Comparison between old and new tests	90
5.5	References	92
Chapter 6:	Characterization of wool fibres after UV treatment.....	94
6.1	Introduction	95
6.2	Scanning electron microscopy	97
6.3	FTIR-ATR	98
6.4	References	99
Chapter 7:	Wool and Cotton dyeing.....	100
7.1	Introduction	102
7.2	Common dyeing operations	102
7.3	Wool dyeing	103
7.3.1	<i>Acid dyes</i>	103
7.3.2	<i>1:1 Metal complex dyes</i>	104
7.3.3	<i>1:2 Metal complex dyes</i>	106

7.3.4	<i>Reactive dyes</i>	107
7.4	Cotton dyeing	109
7.4.1	<i>Direct dyes</i>	109
7.4.2	<i>Reactive dyes</i>	110
7.5	Proposed procedures	111
7.6	References	112
Chapter 8:	UV treatment of wool for differential dyeing with commercial dyestuffs.....	113
8.1	Wool pretreatment by UV radiations	115
8.1.1	<i>Static assessment</i>	115
8.1.2	<i>Continuous assessment</i>	116
8.2	Differential dyeing on wool	118
8.2.1	<i>1:2 Metal complex dyes</i>	118
8.2.2	<i>Reactive dyes</i>	121
8.2.3	<i>Acid dyes</i>	123
8.2.4	<i>1:1 Metal complex dyes</i>	125
8.2.5	<i>Kinetic behavior</i>	129
8.3	Differential dyeing on cotton	135
8.3.1	<i>Direct dyes</i>	135
8.3.2	<i>Reactive dyes</i>	137
8.4	Fading of dyed cotton yarns	143
8.5	References	146

Chapter 9: Industrial scale up of the treatments.....	147
9.1 Introduction.....	149
9.2 Discontinuous/continuous treatments.....	149
9.2.1 <i>Industrial applications</i>	150
9.2.2 <i>Proposals</i>	153
9.3 References.....	154
Chapter 10: Study of a technique that permits to achieve a sun-bleached look on fabrics.....	158
10.1 Introduction.....	158
10.2 Wool dyeing with special effects.....	158
10.2.1 <i>Fastnesses</i>	161
10.3 References.....	162
Chapter 11: Economical evaluation of the process.....	164
11.1 Feasibility.....	166
11.2 Reliability.....	167
11.3 Effective costs.....	168
11.4 References.....	182
Conclusions.....	183

Introduction

Considering the aim of the present PhD thesis research work, the application of UV technology to textiles seemed the right choice: it is in fact an environmental friendly process, economical and easily implementable at industrial level.

After thousands of years of dyer technology, apparently started by pioneering work of the Egyptians, Chaldeans and Babylonians, a major boost was recorded in the nineteenth century, when by the work of young Perkin appeared the first synthetic dye, thus giving rise to a science-technology, that especially in the last century, has made great strides. There has been a radical change both at the level of chemical knowledge, and at industrial level. The textile finishing recipes have moved from an initial alchemical connotation to a well defined periodic and rational approach; disappeared mysterious "ingredients" have disappeared for well-defined compounds having a clear structure, easily reproducible even after a long time and in very different places. Even the "landscape" related to the fibers has been clarified with the ability to perform analyzes, that revealed the real units constituent of natural macromolecules; then after having properly investigated the polymer chains of natural fibres, man has "copied" the nature producing "technofibres". Appeared first man-made fibers, having repeating units equal to those already present in nature, but with slightly different characteristics. Relatively little later appeared synthetic fibers, which starting from simple monomers, are able to generate polymers with different characteristics and therefore "programmable" for the needs of the market. In this scenario, today the textile finishing has achieved a remarkable complexity, just think of the many varieties of yarns and fabrics for countless destinations and uses. Alongside this way, different chromatic effects of are, both of special finishes, always careful to meet various commercial needs. Despite this wide variety of solutions proposed today, the market (stylists, designers, etc.) are always looking for something new, that can find the preference of the final user; ecology also has a role today finally equal, as the new finishing processes must meet the requirements of environmental compatibility, especially with end users (combination of increasingly stringent textile-human health point of view).

In recent times have been developed techniques for obtaining so-called differential dyeings, ie dyeings can provide special color effects; normally contrasting tone (light / dark) are produced playing on different dye affinities of the fibers, which are obtained by application of specific chemicals after normal dyeing operations.

In the past differential dyeings on wool were made pre-treating part of wool fibers with a suitable accelerating agent (compared to the traditional dyeing), or by applying a retardant agent to another part of the textile material; the final effect consisted of a same tone coloring in, but with different intensity on variously treated parts. These applications, not easily controllable in function of their intensity, however, had to be produced with accelerators agents or retarder agents against dyes, then further addition of chemicals were proceeded (effluent problem).

Faced with this situation, collaboration between research institutions, universities and industry is and will be increasingly crucial to ensure the possibility of innovative, high-performance and green technologies, with attention both to environment of to end users. In our case, the input was to propose special effects, going to modify partially consolidated dyeing technologies of wool and cotton, through the use of ultraviolet radiation, rarely used in the textile industry; the final results are then new technological possibilities of textile finishing, both at the level of yarn that of fabric

for natural fibers (wool and cotton), thanks to the pre-treatment (in the case of wool) or to the post-treatment (in the case of cotton) in order to achieve color effects not otherwise obtainable without use of additional chemicals to those normally used.

The purposed goal was the possibility, as consequence of the treatment, to dye wool with good fastness, at temperature lower than 98°C, actually used at industrial level, with the practical advantages of a real energy saving and no fibers damage due to high temperature.

Another application was to apply UV for fading effect (on a dyed cotton substrate with commercial dyestuffs) and this technique was carried out in the actual use conditions of the textile treatment.

The study begun with a deep investigation about the state of the art of the application of the chosen techniques, not only in textile field. Process parameters were then optimized, considering both the process feasibility and the properties conferred to treated yarn and fabric. It was followed by a wide characterization of the treated fabrics in order to evaluate not only the quality of the finish but also to understand the chemical and physical modifications occurred on the substrates surfaces.

Abstract

Not dyed wool yarns and fabrics were treated by ultraviolet radiations, using a medium pressure Hg lamp, in order to obtain a modification onto fibre surface. As consequence, UV treated wool showed increase in metal ions absorption and hydrophilicity, together with improved kinetics of dye absorption under the same dyeing conditions as untreated wool. The surface modification of wool due to UV radiations was confirmed by FTIR-ATR analysis, nevertheless the fibre morphology by SEM analysis was unaffected.

Experimental results showed that different kind of dyes are able to give differential dyeing after irradiation, but not all members of the same dyeing class have similar behaviour. Then, a selection of 1:1 metal-complex dyes was chosen to evidence the maximum of difference between irradiated and not irradiated areas.

The main interests on wool fabrics were focused on two effects:

- a) one shade, double face with different depth, higher on treated side;
- b) two shades, double face with different colour and depth.

Moreover it was found that UV pretreatment can be useful to obtain the same dyeing with lower temperature conditions (85°C).

Fastness evaluations towards dry rubbing and machine washing at 50°C were also carried out to confirm the feasibility of this alternative dyeing technique; in all experiments carried out with selected 1:1 metal-complex dyes the same score of conventional premetallized 1:1 dyeings was obtained.

Dyed cotton yarns and fabrics were treated by ultraviolet radiations, using a medium pressure Hg lamp, in order to obtain a fading of coloured fibre surface. As consequence, UV-treated dyed cotton showed different resistances to discoloration as a function of the selections of reactive dyes used; a selection of cold-reactive dyes (applicable at 60 ° C on cellulosic fibers), having good contrast between UV treated part and untreated, was presented.

Industrial applications for discontinuous and continuous treatments (yarns or fabrics) and new proposal are also presented, with an economical evaluation of the processes (feasibility, reliability and effective costs).

1ST PART

LITERATURE REVIEW

Chapter 1

Update of bibliography on the subject

1.1 Introduction

Dyeing processes are known from ancient times; they have been more and more refined over the centuries, from knowledge of alchemical type to physical-chemical concepts, enabling the achievement of high quality standards. The introduction of synthetic dyes, since the mid –twentieth century, and the progress of chemical industry in general (auxiliaries and inorganic products) greatly enhanced this development. The challenge of textile dyers and finishers of the twenty-first century to confer new functionalities to textile products, both yarns and fabrics; we are so looking for new dyeing and/or finishing effects to propose to an even more demanding market, new environment sustainable and energetically advantageous solutions bringing together, where possible, the greatest number of benefits to the final textile object.

The goal of the present research work, in particular, was aimed at dyeing improvement on different textiles through the application of ultraviolet radiations.

A preliminary investigation on the state of the art in this field evidenced that UV radiations can act in different ways on the functionalization of textiles, through pre- or post-treatments, in order to modify their behaviour in dyeing and finishing processes.

Specific photomodification can occur in a particular textile substrate due to UV irradiation, so the effect of UV exposure was investigated, focusing principally on wool and cotton as textile substrates.

These are typical steps of Textile Engineering; moreover the evaluation of the new properties obtained and the discussion of the applied technologies for these special effects were faced based on an usual approach of Chemical Engineering.

1.2 Established textile UV treatments

The UV treatments applied in textile field, in addition to required specific effects, should also have the following requirements:

- easy application, as not needing of technical or sophisticated equipments;
- durability and fastness of the degree of treatment on the basis of future uses;
- limited treatment costs, so as not to preclude any market segment;
- environmentally friendly requirements, for a sustainable textile.

In the following paragraphs existing UV procedures and/or recent proposals, with its consequent conferred functionalities, will be described.

1.2.1 Enhanced wool shrinkage resistance

Wool shrinkage resistance is a sought feature, especially in recent decades, when the customs usually wash and dry wool cloths by washing machines. The hosiery field, both internally and externally, has amended to the possible extent some characteristic of handmade wool.

In the mid-60 s numerous chemical processes have been proposed about the degradation of cuticular structure of wool, in order to limit felting, allowing to finished garments to bear ordinary washing/drying cycles.

Shrinkage resistance is often obtained using chemical reagents, especially oxidizing, with a significant impact on wastewater treatment; for this reason, further researches were aimed to introduce alternative treatments not based on chlorine and its compounds, but based on other oxidant agents, even in combination with suitable polymers.

Dodd, Carr and Byrne^[1] proposed a method based on curing of a photoreactive silicon monomer onto wool fabrics by exposure to UV radiations followed by a post-cure steam treatment.; the result was a machine washable fabric obtained with low monomer add ons.

El-Sayed and El-Khatib^[2] focused on a modification of wool fabric using ecologically acceptable treatments: previously UV-irradiated wool fabrics were then treated with an oxidizing agent (hydrogen peroxide or sodium monoperoxyphthalate) or a protease enzyme in order to lower its shrinkage

Shao, Liu and Carr^[3] investigated the synergistic effect of UV/ozone exposure and peroxide pad-batch bleaching on wool fabrics, confirming the beneficial effect of UV/ozone treatment on wool shrink-resist properties.

1.2.2 Enhanced pilling resistance on wool and cotton fabrics

Pilling is mainly due to rubbing, principally for knitted fabrics rather than woven ones, and can be related to the slack fabric structure. From an esthetic point of view it is necessary to reduce this effect; since it is not possible to modify the structure of the fabrics, it is necessary to choose the best process conditions to control the pilling, in particular for wet treatments such as dyeing and finishing procedures.

Mansouri, Khoddami and Rezaei Do^[4] claim that cotton fabric padded in a solution of hydrogen peroxide and then irradiated with UV lamp show a significant pilling reduction, comparable to that obtained with industrial system of biopolishing, (finishing process that improve fabric quality by mainly reducing fuzziness and pilling property of cellulosic fibres).

Millington^[5] says that its Siroflash[®] treatment, based on UV irradiation coupled with mild wet oxidation by H₂O₂, is highly effective against pilling formation; in fact, wool and cotton fiber surfaces result much weaker after the treatment and no anchor fibres are available to secure pills to the fabric surface, limiting the unpleasant effect.

1.2.3 Improvement of wool dyeability

The wool dyeability is governed by many factors; firstly, the cuticle, that is the external structure of wool fibre, is hydrophobic, due to lipids naturally contained in it, so it is opposed to hydration and therefore also to penetration of dissolved dyes in aqueous bath. To this purpose auxiliaries are commonly introduced in the dyebath: these are surfactants of different ionicity necessary to modify the surface wettability and to form, with particular dyes, micelles. The dye molecules, suitably incorporated in the micelles, will then be gradually released as a function of temperature, allowing a regular absorption and equalized dyeings.

Typically, the wool fibre is little affected by the dyebath at temperature below 70°C while above this temperature the dye transfer becomes important; for this reason conventional dyeings are carried out near the boil. Dyeing temperature is maintained for 30' – 45' or 60' in accordance with the desired colouration intensity, to allow a good penetration of the dye inside the whole structure of wool fibre (ortho- and para-cortex) – (Fig. 1)

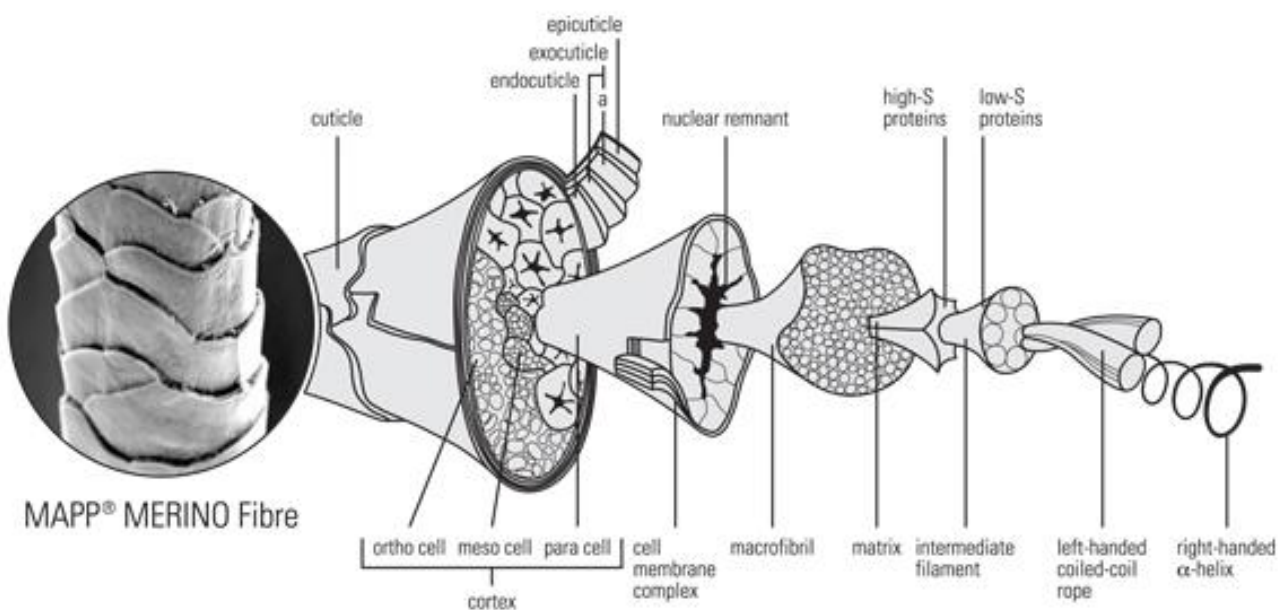

Fig. 1.3.3 Exploded view of the various structural units of the wool fibre

(taken from: <http://www.geoffanderson.com/kat16-Fabrics/side318-Merino-wool.html> - last access on 10/11/2013)

If the cuticle is damaged by external agents, dyes can penetrate the fibre more readily, particularly at low temperatures; this characteristic can also be used to assess the degree of damage of wool fibre.

In this case it is advisable to pay attention during dyeing, especially in the first step, because the fiber was modified at the cuticular region and its affinity is increased;

A modification of the wool fiber at cuticular level, maybe due to an ultraviolet radiation exposure, undoubtedly increases its affinity toward dyes, even if the fiber can be damaged in some extent. It's therefore appropriate to provide a thermal profile, during the dyeing process, taking into account this greater ability of the fibre to accept dye molecules from the aqueous media. On the other hand, it will be possible to dye at temperature below boiling, having regard to this energy will be used only to permit the dye migration inside the cortical cells.

As suggested by Stoot^[6], in general UV irradiation enables wool fibres to absorb dyes at a greater rate than normal and apparently to obtain higher concentration of dye at the equilibrium. Similar effects are achieved after wool chlorination under acidic conditions.

El-Zaher and Micheal^[7] proved that UV-C radiations produce wool fibre modification; both when molecular oxygen is subjected to radiation at 184.9 nm and when ozone is irradiated at 253.7 nm atomic oxygen is generated. Hydrocarbons and ozone absorb the 253.7 nm radiation and react with atomic oxygen to form simpler volatile molecules that away distance from the surfaces. So, oxygen is generated, ozone is formed continuously and the latter is destroyed. The modification is carried out under mild conditions - low temperature.

Beneficial improvements to wool dyeability may be achieved, because after a long exposure time the amorphous region dominates over the crystalline one, permitting a more easy penetration of dyes molecules. Moreover, the photo-oxidation of cystine linkage into a free-radical species promotes covalent bond formation between the fibre and the dye. Also, the sulfurous smell, which occurs after exposure, disappears after some days.

Gupta and Basak^[8] improved the wool dyeability using a 172 nm UV excimer lamp; in this case, SEM images show ablation and etching of the surface. In case of samples exposed to O₂ atmosphere in particular, micropores can be seen on the surface. Treated wool shows increased saturation dye uptake as well as improved rate of dyeing. These changes are restricted to surface and do not affect the bulk properties. XPS analysis shows the presence of polar groups, such as cysteic acid and sulphonic acid, created by cleavage of cystine linkages. An anionic dye was chosen for dyeing and the dye uptake was significantly increased in wool fabrics UV treated in air; at 60°C as dyeing temperature, an irradiated sample showed a dye uptake more than 95%, a good result if compared with a value of 70% for an untreated sample.

Improved dye uptake by all treated samples can be attributed to the destruction of the lipid barrier layer and decrease in the number of disulphide groups in the keratin, that act as a barrier to the diffusion of aqueous solutions.

Xin, Zhu, Hua and Shen^[9] instead worked with different dyeing temperatures (45, 50, 55 and 60 °C) using Acid Blue 7 on UV treated wool fabrics (Hg vapour lamp Philips TUV 36 W, operating at 253.7 nm and fixed a distance of 16 cm). The UV-treated wool samples showed greater levels of dye uptake compared with those of the untreated ones. Increases in dye uptake rate and colour yield, in terms of K/S, were observed on UV treated fabrics, especially at relatively low dyeing temperature; the adsorption behavior and diffusion coefficients were also studied.

Shao, Hawkyard and Carr^[10] confirmed the extensive fibre surface modification due to UV rays and obtained increased rates of exhaustion for acid-milling, metal-complex and reactive dyestuffs; comparison of the behavior of chlorinated wool and UV treated wool showed little differences related to total fixation efficiency for reactive dyes.

An accurate work was conducted by Millington^[5] about synergistic interaction between UV exposure and wet oxidation; in the first step, carried out with low-pressure mercury arc, he demonstrated high degree of contrast between dyed samples UV irradiated and not irradiated; he found great dependence of the dye class and suggested that the notable colour differences are obtainable using 1:1 metal-complex dyes. Differences in colour yields (K/S) are possible with many class of dyestuffs: acid milling dyes, 1:2 metal-complex dyes, 1:1 metal-complex dyes and reactive dyes, but the use of 1:1 metal-complex dyes is particularly effective.

1.2.4 Preparation for wool printing

Preparation for wool printing is an essential operation because without this step it is very difficult to get full color yields, levelness and brightness; usually this procedure is carried out with oxidative processes: chlorination with or without polymer addition, such as chlorination-Hercosett[®], rarely using a “sulphitolysis” process or application of tetraethylenepentamine before printing.

It's necessary to modify the external structure of fibres, increasing polarity and accessibility, in order to obtain a quick wettability with printing paste and easy swellability in water, preferably maintaining the original colour of the fibres.

Shao, Hawkyard and Carr^[10] found that UV irradiated wool fabrics have similar behavior of chlorinated ones during printing steps but UV treated fabrics showed more yellowing in comparison with chlorinated).

Always Millington^[5] faced also the problem of printing, and highlighted that UV-C irradiation before printing gave much better colour yields on wool fabrics regard to untreated ones; he remarked an initial green colouration of wool fibres, which turns at yellow under ambient conditions, probably due to the cystinyl radical cation. To overcome the yellowing problem, he advised a mild wet oxidation with hydrogen peroxide or permonosulfate, that are able, in aqueous media, to easily remove the chromophores produced by UV-C; this procedure is patented under the name of Siroflash[®].

It was shown that the UVC region in the medium-pressure mercury arc spectrum are the most important component for increasing colour yields in printing, mainly with reactive dyes, providing the brightest hues and the best fastness properties.

The rubbing fastness of dyed UV treated fabrics showed slightly lower values to untreated ones for a given dye concentration; generally, the UV irradiated samples dyed with 1:1 metal-complex dyes displayed more colour strength (for example, a 3% o.w.f. dyeing on UV-treated fabric can produce a better depth of shade than a 5% dyeing on untreated fabric).

Then, Siroflash[®] treatment is uniform across the fabric surface, can be limited to one fabric face, and has less impact on handle than chlorination. Moreover, the fastness properties of printed fabrics easily meet Woolmark standards. Also, for quick UV irradiations, the treatment cannot penetrate into the fabric, thus the loss of strength of fibres is minimal.

1.2.5 Alternative proposed cotton mercerization

The finishing operations performed on weaving fabrics include all the operations carried out to provide a fabric with those properties that the customer desires after the fabrics leave the textile factories. With the modern textile finishing operations, it is possible to provide cotton fiber with a structure similar to the superior properties of synthetic fibers.

Mercerization is a treatment for cellulosic materials, like cotton, that gives fabric or yarns a lustrous appearance and strengthens them.

Mercerization is carried out by cold, strong caustic soda liquor under tension; it is an important operation for cotton finishing, to achieve a resistant silk shine and good handle, even if without all the fundamental processes being understood.

Zuber, Zia, Bhatti, Ali, Arshad and Saif^[11] demonstrated that UV rays have a similar effect, on cellulosic fibres, of alkaline treatment (mercerization); irradiated cellulosic fibres showed higher swelling in comparison with any concentration of NaOH treatment, but tear and tensile strength were worse if compared to the untreated or alkali treated ones. They emphasized that UV rays don't produce loss in weight after exposition on cotton fabrics while dye affinity is slightly enhanced if dyeing was carried out with direct dyes.

These new properties can be useful for cellulose products in special applications (dialysis membranes, wound dressings, etc.) and for not conventional uses of cellulosic fibres such as adsorption of heavy metals.

1.3 References

- [1] K.J. Dodd, C.M. Carr et K. Byrne, *Textile Res. J.* **68** (1) 10-16 (1998).
- [2] El-Sayed et El-Khatib, *J Chem Technol Biotechnol* **80** 1111–1117 (2005).
- [3] J. Shao, J. Liu et C. M. Carr, *Color. Technol.*, **117** (2001).
- [4] A. H. Mansouri, A. Khoddami et A. Rezaei Do, *FIBRES & TEXTILES in Eastern Europe* 2011, Vol. 19, No. 3 (86).
- [5] K. R. Millington, *J.S.D.C.* **114** (1998) 286.
- [6] G. L. Stoot, *J.S.D.C.* **77** (1961) 206.
- [7] N. A. El-Zaher et M. N. Micheal, *J Appl Polym Sci* Vol. 85: 1469–1476, (2002).
- [8] D. Gupta et S. Basak, *J Appl Polym Sci*, Vol. 117, 3448–3453 (2010).
- [9] J. H. Xin, R. Zhu, J. Hua et J. Shen, *Color. Technol.*, **118** (2002) 169.
- [10] J. Shao, C. J. Hawkyard et C. M. Carr, *J.S.D.C.* **113** (1997) 126.
- [11] M. Zuber, K. M. Zia, I. A. Bhatti, Z. Ali, M. U. Arshad et M. J. Saif, *International Journal of Biological Macromolecules* **51** (2012) 743– 748.

Chapter 2

Use of UV radiation on pretreatment/finishing of textiles.

Study of different wavelengths and their interaction with different kinds of fibres.

2.1 Introduction

Ultraviolet (UV) light is an electromagnetic radiation with a wavelength shorter than visible light, but longer than X-rays, that is in the range 10 nm to 400 nm, corresponding to photon energies from 3 eV to 124 eV. It is so named because the spectrum consists of electromagnetic waves with frequencies higher than those that humans identify as the color violet. These frequencies are invisible to humans, but visible to a number of insects and birds (Fig. 2.1).

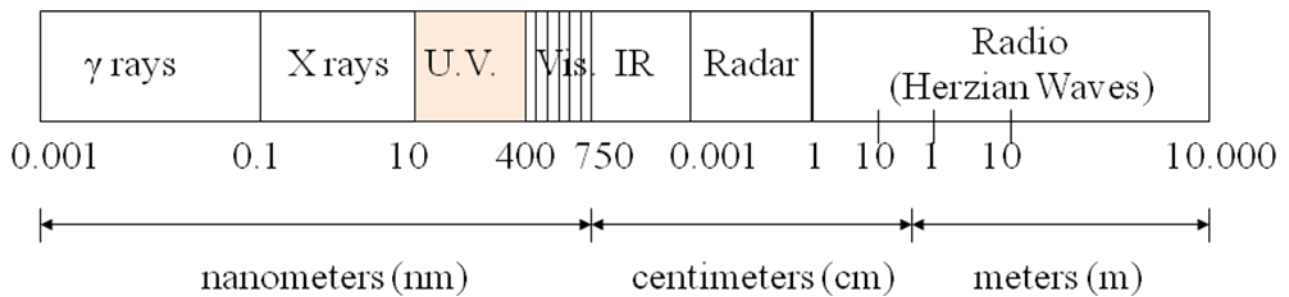

Fig. 2.1 - The electromagnetic spectrum

The totality of electromagnetic radiations, different in their wavelength and energy, travels in the vacuum at ca. $2.997 \cdot 10^8$ [m * s⁻¹];

The energy of the *photon (quantum of light)* referred to a given radiation is in inverse relation to the wavelength of the luminous beam. (Eq. 2.1.1 and Eq. 2.1.2)

$$\epsilon = h \nu = h c / \lambda \quad \text{photon energy [J]} \quad (\text{Eq. 2.1.1})$$

$$E = N_A h \nu = N_A h c / \lambda \quad \text{mol of photon energy [Einstein]} \quad (\text{Eq. 2.1.2})$$

where:

E = energy

N_A = Avogadro constant = $6.023 \cdot 10^{23}$ [mol⁻¹]

h = Planck constant = $6.63 \cdot 10^{-34}$ [J * s]

ν = frequency [s⁻¹]

c = speed of light = $2.997 \cdot 10^8$ [m * s⁻¹]

λ = wavelength [m]

UV radiations are ideally divided in four ranges, that are:

E-UV from 10 nm to 121 nm from $1.20 * 10^7$ to $1.00 * 10^6$ [Einstein]

UV-C from 100 nm to 280 nm from $1.20 * 10^6$ to $4.27 * 10^5$ [Einstein]

UV-B from 280 nm to 315 nm from $4.27 * 10^5$ to $3.80 * 10^5$ [Einstein]

UV-A from 315 nm to 400 nm from $3.80 * 10^5$ to $3.00 * 10^5$ [Einstein]

2.2 Mechanisms of interactions

2.2.1 Influence of wavelength

There are two basic principles of photochemistry:

- electromagnetic radiation must be absorbed, in order to initiate a photochemical process;
- absorption takes place in discrete quanta (photons) whose energy is determined by the frequency of the radiation.

These groundwork led research laboratories to devote extensive attention to wavelengths that are responsible for the deterioration of specific materials.

As potentially fruitful as this approach is in principle, the quest has not always yielded results as significant as initially expected.

Berger ^{[1], [2]} clearly states: “Absorption curves need not always be identical with the pertaining curves of damage, for not every type of absorption causes changes in the material.”

One reason for misdirection is that determination of the activation spectrum may show an apparent wavelength of peak activity, not because of the maximum absorption of a particular component, but simply because the available energy of the light source falls off rapidly at the lower wavelengths.

When the range of wavelengths considered is extensive (from 254 nm or lower to 450 nm or greater) it is expected that differences in photodegradative behavior will be observed.

The gases emitted by wool specifically, studied over a wide range of wavelengths by Launer and Black ^[3], provide an example: distinctly different combinations of gases were generated by 254, 365, or 436 nm radiation. (Table 2.2.1)

wavelength	Mass Spectrum, Percent Gaseous Products						
[nm]	CO ₂	CO	H ₂	H ₂ O	COS	H ₂ S	CH ₄
254	34	28	23	11	4	trace	-
365	75	-	-	-	-	-	-
436	100	-	-	-	-	-	-
546	-	-	-	-	-	-	-
(160 °C dark)	22	2	-	63	1	2	8

Table 2.2.1. Gases produced from wool in vacuo by the light of various wavelengths and by heat (data of Launer and Black 1971).

Bousquet and Foussier^[4] referred to differences induced by wavelengths as far apart as 254 nm and 313 nm as a “macroscopic” wavelength effect.

Another work carried out by Johnson et al.^[5] reported the loss of tensile strength versus wavelength, finding major activity between about 330 to 390 nm.

As noted earlier, as the wavelengths of radiation decrease through blue, violet and into the ultraviolet, the energy of the photons increases. Thus, a basic point of view regarding the damaging effect of exposure to visible and ultraviolet radiation would be to state simply that the shorter the wavelength, the more energetic the photons, and therefore the more potentially damaging the radiation.

An important generality is implied in the principle of reciprocity. This concept states that the net exposure, that influences the total amount of photochemical damage, is represented by the product of the intensity of the irradiance (or the illumination, the luminous flux) and the radiation time, other factors being negligible. In other words, 100 lux of intensity for 1 hour is considered to produce as much damage as 1 lux of the same radiation for 100 hours; the product in each case is the same: 100 lux hours and the total number of photons striking the sample would be the same.

In a series of tables, Harrison^[6] gave detailed examples showing how the factors of damage for a given wavelength could be used in conjunction with numbers related to the spectral distribution of emission from various light sources and the spectral transmission of various filters, in order to estimate the relative damage that might occur under various combinations of sources and filters.

Harrison proposed a logarithmic relationship between the damage factors (D_λ) versus wavelength on semilog paper, achieving a straight-line relationship.

In 1964, attention was drawn to the fact that the:

- (a) degradation of rubber (Bateman^[7]),
- (b) erosion of paint (Miller^[8]),
- (c) tendency of certain methacrylate polymers to cross-link (Feller^[9])

all responded in a similar way to decreasing wavelengths.

Later, it was found that the development of carbonyl groups in poly(vinylchloride) (Martin and Tilley^[10]) exhibited much the same behavior (Feller et al.^[11]).

In an extensive consideration of the problem of minimum tolerable exposure, Aydinli, Hilbert, and Krochmann^[12] took particular note of a logarithmic relationship.

This was based on their equation (Eq. 2.2.1 and Eq. 2.2.2):

$$S(\lambda)_{\text{dm rel.}} = ae^{-b\lambda} \quad (\text{Eq. 2.2.1})$$

$$\ln S(\lambda)_{\text{dm rel.}} = \ln a - b\lambda \quad (\text{Eq. 2.2.2})$$

where λ is the wavelength in nanometers and $S(\lambda)_{\text{dm rel.}}$ is the relative spectral damage or responsivity of the material (comparable to the NBS/Harrison, D_λ).

In the case of specific materials and photochemical changes, the intercept and slope become important specifications. Using these principles, Krochmann and his co-workers determined the slope b , for a series of watercolors, oil paints, paper, newsprint papers, and textiles.

They used this approach to estimate the minimum exposure under various lamps causing a “just perceptible” color change, considered to be a ΔE of 1 according the CIE $L^*a^*b^*$ color-difference formula.

Yano and Murayama ^[13] found that the dynamic modulus of nylon was only affected by wavelengths below 300 nm. The tendency of poly(methylmethacrylate) to undergo chain scission also becomes particularly important at wavelengths below 300 nm (Torikai et al. ^[14]).

When evaluating the photochemical activity of TiO_2 , Blakey ^[15] reported that a radiation source rich in the short wavelengths of ultraviolet (ca. 290 nm) exaggerated the photochemical deterioration of the binder and minimized the effect of the pigment photoactivity. It became particularly important when the behavior of different TiO_2 pigments was first tested in an air-drying alkyd and later compared to the behavior of the same pigments in a more durable binder based on a thermosetting acrylic.

In summary, there is ample evidence that UVB wavelengths can occasionally induce differences in degradation chemistry as opposed to the same source filtered by borosilicate or soda-lime glass.

Concerning the long-held interest in a threshold below which photochemical damage will not occur, there are indeed many examples of the fact that various reactions will not be induced above a certain wavelength. In contrast, there is theoretically no limit of *intensity* (more properly, *exposure*, intensity times) of an activating irradiance, below which a photochemical process will cease.

Evidence has been provided about the fact that UVB radiation, not significantly transmitted by ordinary window glass, is capable of inducing deterioration reactions.

Close attention must be paid to the wavelengths involved, particularly if 254 nm radiation is involved, or if low- and medium-pressure mercury-vapor lamps are used without an effort to filter out the lower wavelengths, responsible for photolytic deterioration.

Solarization affects the shortest, usually most damaging wavelengths, seriously altering their intensity during the normal lifetime of lamps. The change in intensity of wavelengths between 290 and 340 nm may require more careful monitoring than is often done.

Sources of intense illumination commonly cause the rising temperature of test samples, nearly always introducing unwanted heat effects. Besides the obvious effects of heat, there is usually also a decrease in moisture content of the specimens. A simple method to demonstrate the gross effects of heat as opposed to light during exposure outdoors, as well as under an intense artificial light source, is simply to place a covered control sample either alongside (preferable) or behind an exposed sample. This is particularly useful in estimating the degree of protection of textiles provided by ultraviolet filters.

Results related to silk and linen showed a certain loss of strength during the exposure, simply due to thermal effects.

As one prepares to evaluating the effect of ultraviolet radiations with short wavelengths, the possible ozone generation must be considered. This chemically active gas in fact can seriously attack many organic materials, masking the purely photochemical effects (Cass et al. ^[16]).

Wavelengths below about 242 to 248 nm should not be present if one is to avoid the generation of ozone.

2.2.2 Influence of moisture

It is generally agreed that oxidative degradation will be speeded up by the presence of moisture. Nonetheless, Lemaire et al. ^[17] take the position that “the chemical role of water in weathering is far from being understood.”

Kamal and Saxon ^[18] point out that water can have at least three kinds of important effects in the degradation of polymers:

- chemical: hydrolysis of the ester or amide bonds.
- physical: loss of the bond between the vehicle and a substrate or pigment.
- photochemical: generation of hydroxyl radicals or other chemical species.

Another influence of moisture could be the help in ionization and mobility of ionic entities, an important aspect of corrosion chemistry.

Polymer formation by condensation reactions with loss of water can be reversed. Ester groups in cellulose acetate-butyrate polymers hydrolyze, yielding destructive acidity (Allen et al. ^[19]).

The effect of moisture should always be checked. Moreover, the elevated temperatures achieved in samples exposed to high-intensity light sources tend to reduce the moisture content of samples.

Graminski et al. ^[20] note that, when the atmosphere was desiccated, little if any change in physical properties of paper occurred at temperatures between 60 °C and 90 °C. There are nonetheless notable examples in which increased levels of moisture have a negligible effect on the rate of deterioration.

Some workers, therefore, consider their results to be more fundamentally significant if expressed in terms of the moisture content of the material under test, inappropriately named “object humidity”, rather than of relative humidity.

The response of cellulose to decreasing moisture content does not decrease monotonically, but goes through a minimum at about 0.8% moisture content (DuPlooy ^[21]). At this point the absorbed moisture is zero and the only water remaining is the so-called *bound water*. Further reduction of water content begins to eliminate the bound water generally leading to an increased rate of deterioration. Graminski et al ^[20] also state that the minimum occurs because a portion of the water in cellulose, namely the bound water fraction, is chemically inactive.

Hon^[22] has pointed out that below a water content of 5–7%, the opportunity to form free radicals is reduced. Instead, as stated by Holt and Waters ^[23], “In the photodegradation of wool, humidity is a relatively unimportant parameter”.

On the question of 100% RH, Calvini ^[24] emphasized the fact that there can be differences in behavior between situations that principally involve absorbed water vapor, and situations that involve water in the condensed liquid phase. If the latter occurs, contact with water may cause leaching and cracking effects that lead to distinctly different results than that would occur when only the absorption of water vapor were affecting behavior (Abeyasinghe et al. ^[25]).

Instances are also known in which the hydrolysis of bonds, thought to be the principal process of degradation in a polymer, did not take place in the absence of oxygen. The diversity of these possible modes of action led authorities to assert that the role of water in weathering remains far from being understood. The action of moisture in deterioration, difficult to predict, must be verified in each specific situation.

Because reactions initiated by ultraviolet and short wavelength visible radiation are likely to be more rapid than thermally initiated reactions, it is usually the case that samples need to be much thinner for photochemical aging tests than for thermal (Cunliffe and Davis ^[26]). This general circumstance is further supported by the fact that the diffusion of oxygen is likely to be greater at the higher temperatures customarily employed in the thermal degradation studies; hence, thicker samples can be tolerated at higher temperatures.

2.2.3 Influence of temperature

The direct breaking of chemical bonds upon exposure to ultraviolet and visible light in absence of oxygen is termed *photolysis*. There are also *pyrolytic* chemical changes that can be induced by high temperatures in the absence of oxygen.

Vachon et al. ^[27] claimed that the degradation of nylon was not a purely hydrolytic process as might be expected. They found instead that the scission of the amide linkages did not occur in the absence of oxygen. Measurement of the rate of deterioration of nylon and Kevlar versus relative humidity allowed Auerbach ^[28] to conclude that at 150–170 °C there was a purely thermal reaction that took place in the absence of moisture.

There are some limitation:

- if the mechanism of the reaction at higher or lower temperatures should differ, this, too, would alter the slope of the curve.
- it is necessary that the energy of activation is independent by temperature, that is constant over the range of temperatures of interest.
- the Arrhenius equation applies to homogeneous reaction conditions while it has little significance in solid-state reactions.

Agrawal ^[29] cites two reasons for nonlinearity between $\log k$ and $1/T$: a change in reaction mechanism, as just mentioned, but also the existence of a temperature gradient within the sample, due to heat and mass transfer effects.

Day et al. ^[30] describe an example where the rate of oxidation became diffusion-controlled at lower temperatures.

Kelly et al. ^[31] report nonlinear Arrhenius plots for the fading of certain dyes on acrylic and poly(vinylalcohol) substrates.

It is necessary to consider also if the reactions take place above or below the Second-Order Transition Temperature, T_g ; in general, if irradiation tests are carried out solely at temperatures above the second-order transition temperature, the rate of certain key reactions may be sufficiently altered that Arrhenius-based extrapolations of possible behavior down to room temperature (specifically to temperatures below T_g) can be in error.

The effect of stress may become important in the case of materials on exhibition, perhaps a textile hung or draped over a frame; the greatest rate of deterioration should occur where the textile, or leather work, experiences the greatest stress of bending or tension.

The reason the applied stress leads to a more rapid rate of reaction is that mechanical tension contributes to chemical bond scission. The thermal energy of activation(E) is lowered by the potential energy of the stress, $\delta \sigma$.

Thus, the familiar Arrhenius equation (Eq. 2.2.3) becomes:

$$K = K_0 \exp [-(E - \delta\sigma) / RT] \quad (\text{Eq. 2.2.3})$$

2.3 References

- [1] W. Berger, Comparative studies on light resistance test instruments. *Farbe und Lack* 77:16–26.
- [2] W. Berger, Comparison of light stability testers. *Paint Manufacture*. May 1971:30–35.
- [3] H. F. Launer, D. Black, 1971 Gases produced from wool by light and heat. *Applied Polymer Symposium* No. 18: 347–52. New York: J. Wiley & Sons.
- [4] J. A. Bousquet, J. P. Foussier, 1984 Hydroperoxides as intermediates responsible for wavelength effects in photooxidation reactions. *Journal Polymer Science, Polymer Chemistry Edition* 22:3865–76.
- [5] L. D. Johnson, W. C. Tincher, and H. C. Bach, 1969 Photodegradative wavelength dependence of thermally resistant organic polymers. *Journal Applied Polymer Science* 13:1825–32.
- [6] L. S. Harrison, 1954a *Report on the deteriorating effects of modern light sources*. New York: The Metropolitan Museum of Art.
1954b An Investigation of the damage hazard in spectral energy. *Illuminating Engineering* 48:253–57.
- [7] L. Bateman, 1947 Photolysis of rubber. *Journal Polymer Science* 2:1–9.
- [8] C. D. Miller, 1958 Kinetics and mechanism of alkyd photooxidation. *Industrial Engineering Chemistry* 50:125–28.
- [9] R. L. Feller, 1963 New solvent-type varnishes. In *Recent Advances in Conservation*. G. Thomson, ed. London 171–75.
- [10] K. C. Martin, and K. I. Tilley, 1971 Influence of radiation wavelengths on photooxidation of unstabilized PVC. *British Polymer Journal* 3:36–40.
- [11] R. L. Feller, M. Curran, and C. Bailie, 1981 Photochemical studies of methacrylate coatings for the conservation of museum objects. In *Photo-degradation and Photostabilization of Coatings*. S. P. Pappas and F. H. Winslow, eds. American Chemical Society Symposium Series 151:182–96.
- [12] S. Aydinli, G. S. Hilbert, and J. Krochmann 1983 Über die gefährdung von ausstellungsgegenständen durch optische strahlung (On the damage hazard of art objects by optical radiation). *Licht-Forshung* 5:35–47. In German.
- [13] S. Yano, and M. Murayama, 1980 Effect of photodegradation on dynamic mechanical properties of nylon 6. *Journal Applied Polymer Science* 25:433–47.
- [14] A. Torikai, M. Ohno, and K. Fueki, 1990 Photodegradation of poly(methyl methacrylate) by monochromatic light: quantum yield, effect of wavelengths, and light intensity. *Journal Applied Polymer Science* 41:1023–32.

- [15] R. R. Blakey, 1985 Evaluation of paint durability—natural and accelerated. *Progress in Organic Coatings* 13:279–96.
- [16] G. R. Cass, J. R. Druzik, D. Grosjean, W. W. Nazaroff, P. M. Whitmore, and G. L. Wittman 1990 *Protection of Works of Art from Atmospheric Ozone*. Research in Conservation 5. Marina del Rey: The Getty Conservation Institute.
- [17] J. R. Lemaire, R. Arnand, and J.-L. Gardette, 1991 Low temperature thermo-oxidation of thermoplastics in the solid state. *Polymer Degradation and Stability* 33:277–94.
- [18] M. R. Kamal, and R. Saxon 1967 Recent developments in the analysis and prediction of the weatherability of plastics. *Applied Polymer Symposia* 4:1–28.
- [19] N. S. Allen, M. Edge, J. H. Appleyard, T. S. Jewitt, C. V. Horie, and D. Francis 1987 Degradation of historic cellulose triacetate cinematographic film: the vinegar syndrome. *Polymer Degradation and Stability* 19:379–87.
1988 Degradation of cellulose triacetate cinematographic film: prediction of archival life. *Polymer Degradation and Stability* 23:43–50.
- [20] E. L. Graminski, E. J. Parks, and E. E. Toth, 1979 The effects of temperature and moisture on the accelerated aging of paper in durability of macromolecular materials. American Chemical Society Symposium Series 95, 341–55. R. K. Eby, ed. See also NBSIR78-1443 (1978), National Bureau of Standards, Washington, D.C.
- [21] A. B. J. DuPlooy, 1981 The influence of moisture content and temperature on the aging rate of paper. *Australian Pulp & Paper Industry Technical Association* 34:287–92.
- [22] D. N.-S. Hon, 1975 Formation of free radicals in photoirradiated cellulose II. Effect of moisture. *Journal of Polymer Science* 13:955–59.
- [23] L. A. Holt, and P. J. Waters, 1985 Factors affecting the degradation of wool by light, wavelength, temperature, moisture content. Proceedings of the 7th International Wool Textile Research Conference, Tokyo 4:1–10.
- [24] P. Calvini, 1987 A two-dimensional equation of state of water absorbed on the surface of cellulose: A tool to better understand the artificial ageing of cellulosic materials. ICOM Committee for Conservation, 8th Triennial Meeting, Sydney, Australia 353–56
- [25] H. P. Abeysinghe, W. Edwards, G. Prichard, and G. L. Swanysillai, 1982 Degradation of crosslinked resins in water and electrolyte solutions. *Polymer* 23: 1785–90.
- [26] A. V. Cunliffe, and A. Davis, 1982 Photo-oxidation of thick polymer samples—Part II: The influence of oxygen diffusion on the natural and artificial weathering of polyolefins. *Polymer Degradation and Stability* 4:17–37.
- [27] R. N. Vachon, L. Rebenfeld, and H. S. Taylor, 1968 Oxidative degradation of nylon 66 filaments. *Textile Research Journal* 38:716–28.

- [28] I. Auerbach, 1989 Kinetics for the tensile strength degradation of nylon and Kevlar yarns. *Journal Applied Polymer Science* 37:2213–27.
- [29] R. K. Agrawal, 1985 On the use of the Arrhenius equation to describe cellulose and wood pyrolysis. *Thermochemica Acta* 91:343–49.
- [30] M. Day, J. D. Cooney, and D. M. Wiles, 1989 The thermal stability of poly(aryl-ether-ether-ketone) as assessed by thermogravimetry. *Journal Applied Polymer Science* 38:323–37.
- [31] S. E. Kelly, C. H. Nicholls, and M. T. Pailthorpe, 1982 Temperature dependence of the fading of basic dyes on acrylic and nylon substrates. *Polymer Photochemistry* 2:321–29.

Chapter 3

Study of interaction of UV radiation on different fibres: naturally present chromophores and related photomodifications.

3.1 Introduction

When a dyed or pigmented material fades, it may not be the absorption of light by the colored substance, the most obvious absorber, that represents the wavelengths principally responsible for its deterioration (ISO R105 blue-wool fading cloth No. 7 provides a case in point [McLaren 1956]^[1]). Instead, it may be that absorption by chromophoric groups, in a trace of impurity, activates the vehicle leading to the degradation of the colorant.

Occasionally, the discoloration of specimens apparently will be reversed by removal from exposure. It can pose a problem if the fading on samples is not measured either immediately or after precisely the same period of time following their exposure to heat or light. (Morris et al. 1985)^[2]

In the darkening or intentional bleaching of oils and paper, both changes can go on at the same time: the result after a period of accelerated aging will be the net effect of the equilibrium state between the two processes. It is particularly true if certain components react in one fashion and other components in another or if the light source emitted both visible and ultraviolet radiation inducing opposite reactions.

3.2 Properties of chromophores

3.2.1 About wool

In wool fibers there are several UV-absorbing chromophores, present in the form of the aromatic amino acid residues (Trp, Tyr, Phe and also Cys), absorbing in the UV region between 250 and 320 nm. There are also visible chromophores, that absorb from the near UV into the visible region of the spectrum (350–500 nm), resulting in the cream colour of natural undyed wool.

Surprisingly, little is known about the identity of the natural yellow chromophores in wool; it is likely that they are a complex mixture of compounds, including wool protein oxidation products.

Because wool has a very high absorption coefficient for high-energy UV, a wool fabric exposed only to UV-B (or UV-C) wavelengths is oxidised and discoloured specifically at the surface, to a depth of 1–2 μm .

Exposure of dry wool to high-energy UV-C wavelengths results in a green colour because of formation of two species: one absorbing blue light and one absorbing in the red region at 600 nm.

The presence of oxygen is not necessary for the green coloration to occur, thanks to free radicals derived from cystine residues, quite stable in the absence of oxygen and water. UV radiation in the presence of atmospheric oxygen results in rapid wool photoyellowing, accelerated in the presence of water, whereas exposure of natural cream wool to blue light causes photobleaching.

3.2.2 About cotton

In cotton, the precise origin of the UV absorption, which is not due to any of the structural groups which make up the normal cellulosic chains, is uncertain and can only be attributed tentatively to “impurities” or “faults” bearing carbonyl and/or carboxyl groups.

Naturally-pigmented green cotton derives its color from caffeic-acid, a derivative of cinnamic acid, found in the suberin (wax) layer surrounding, with cellulose, the fiber. The isolated compound is fluorescent (287 nm and 310 nm) and it is supposed that its purpose is to absorb UV radiation in order to protect the seed. On the other hand, brown and tan cottons derive their color from tannin vacuoles in the lumen of the fiber cells. TLC analysis revealed the pigment to be a tannin precursor, catechin, and tannin derivatives (absorption near 278 nm).

The brown color does not form until the fibers are exposed to oxygen and sunlight, which happens when the seed pod opens.

Naturally-pigmented cottons offer better UV protection than conventional bleached or unbleached cotton, then it has better UPF.

3.3 Interaction between wool chromophores and radiation

About wool, various mechanisms for the explanation of photobleaching and photoyellowing are proposed; here are listed the most relevant:

Free-radical oxidation of the peptide chain at α -carbon to form α -ketoacids

(1967) [Meybeck et Meybeck]^[3]

1. energy absorption by aromatic amino acid residue (Tyr)
2. energy transfer to the α -carbon position via the formation of a six-membered ring
3. formation of α -carbon radicals (Scheme 1)

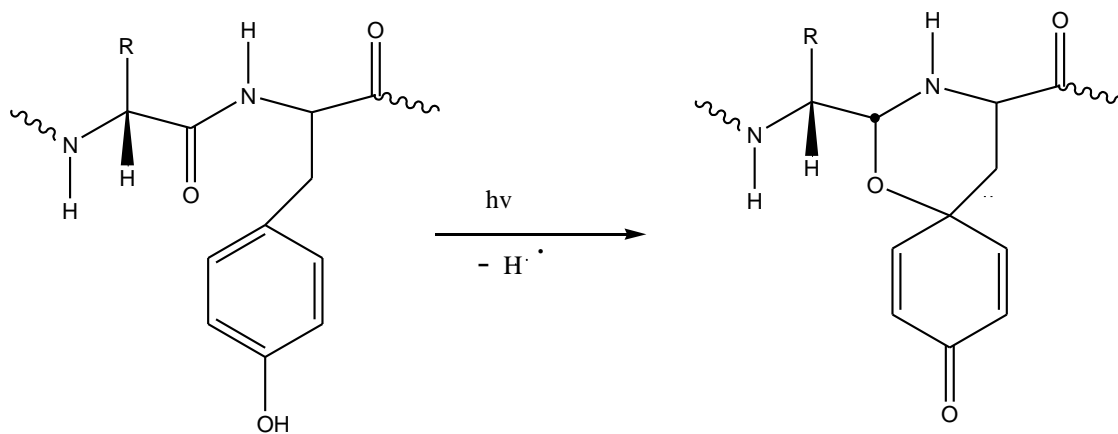

Scheme 1

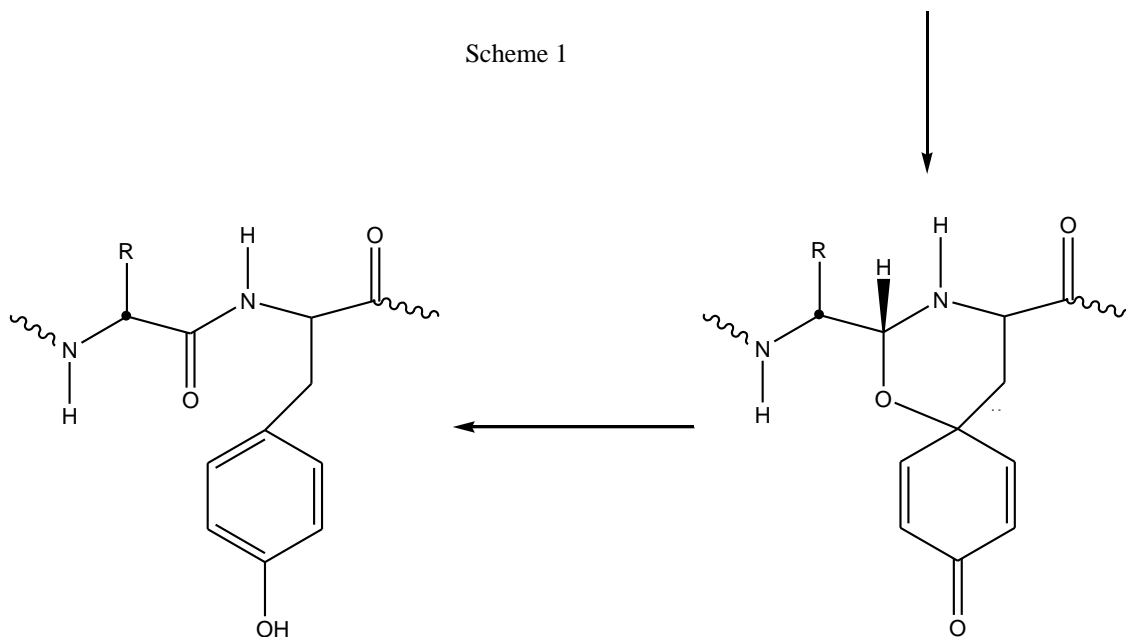

- α -carbon radicals can either react with oxygen to form α -hydroperoxides or lose hydrogen to form dehydropeptide
- both routes would yield α -ketoacids (RCOCOOH) following hydrolysis (Scheme 2)
- yellowing of wool is due to the formation of pyruvyl peptides (λ_{\max} at 310–317 nm) close to the peak of absorption (320–330 nm) of yellowed wool

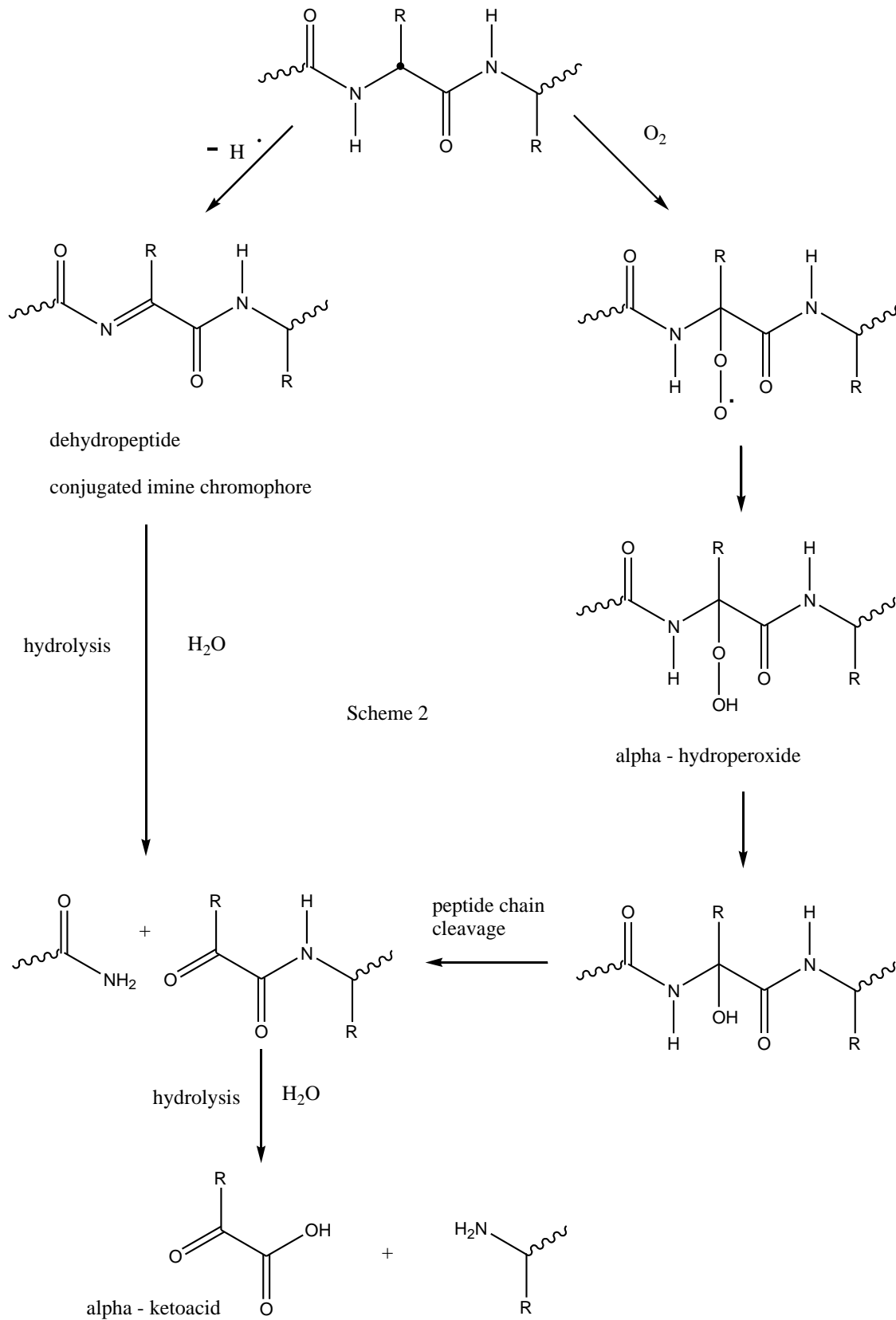

7. decomposition of Trp residues, due to their reaction with α -ketoacids
8. Trp reacts with α -ketoacids, via the Pictet–Spengler reaction, to form yellow b-carboline carboxylic acids

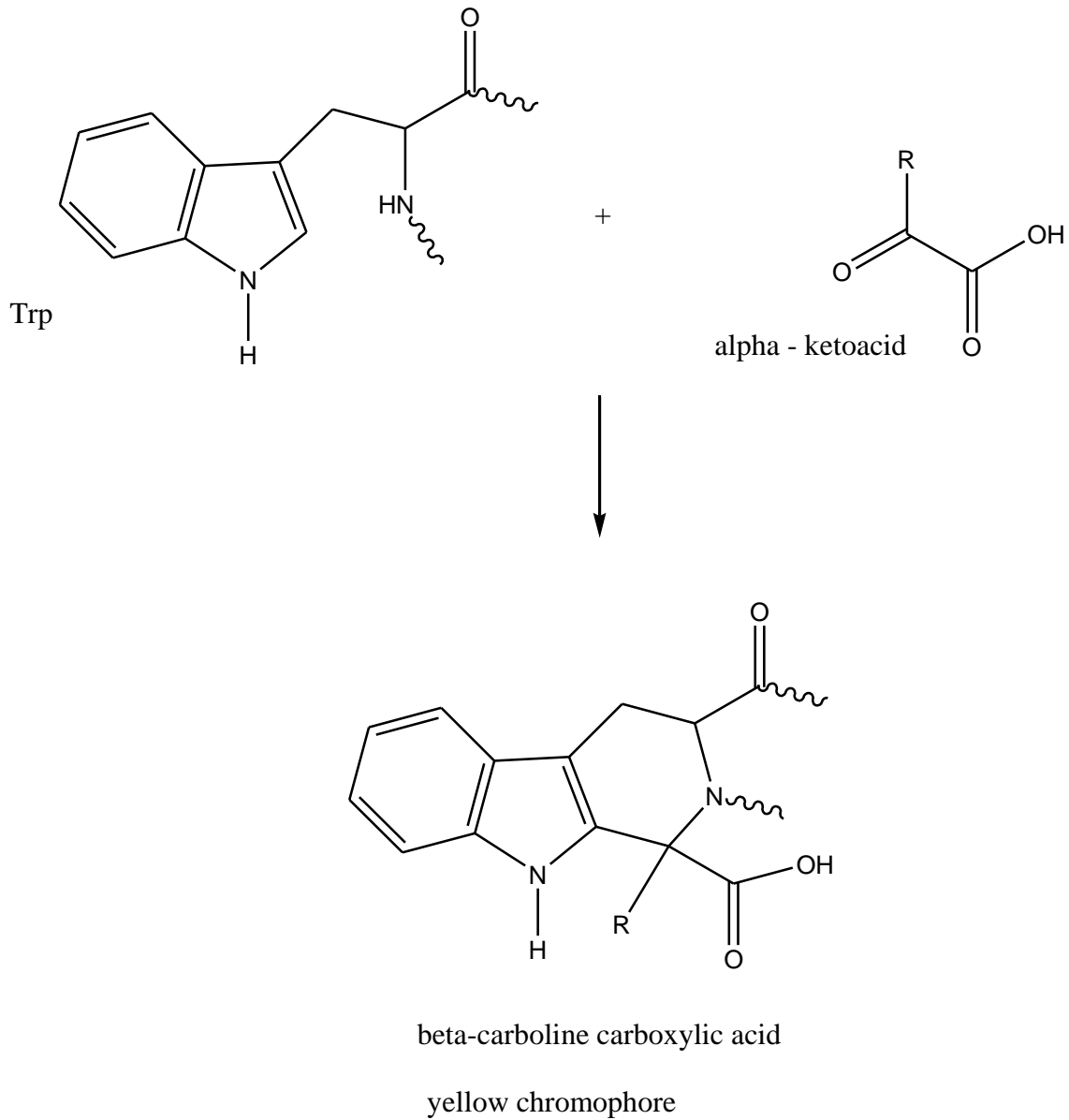

Criticism

α -ketoacids could not be detected after irradiation of wet wool, which yellows at a much faster rate. Maybe there are a number of different photoyellowing pathways available, so α -ketoacid formation via this mechanism is more favourable under dry conditions. Under wet conditions, a different and more rapid yellowing pathway may dominate.

Chromophore formation via increased conjugation: semiconductor theory.
(1974) [Hoare]^[4]

During irradiation, wool keratin produces mobile-free electrons that are promoted into a conduction band, similar to the known behaviour of semiconductor biomaterials, such as melanin. The theory is that the removal of electrons from single bonds increases the level of unsaturation and conjugation in the keratin structure (for example, dehydropeptides and conjugated imines as shown in Scheme 2) leading to the formation of new chromophores.

Criticism

The conjugation theory is that if the yellow chromophores in wool are due to the conjugation of unsaturated double bonds, then on mild hydrolysis, when the conjugated protein is cleaved, the colour should be removed. It is difficult to determine whether any loss of colour occurs under such conditions, but yellow solutions are formed showing the presence of chromophores formed via other mechanisms.

Oxidation by singlet oxygen $^1\Delta_g$
(1976) [Nicholls and Pailthorpe]^[5]

The singlet oxygen mechanism involves absorption of the UV components of sunlight by the aromatic amino acid residues in wool protein, followed by energy transfer through the protein chain to tryptophan residues. Tryptophan residues in the singlet excited state then undergo intersystem crossing to an excited, long-lived triplet state which can react with ground state oxygen to produce singlet oxygen.

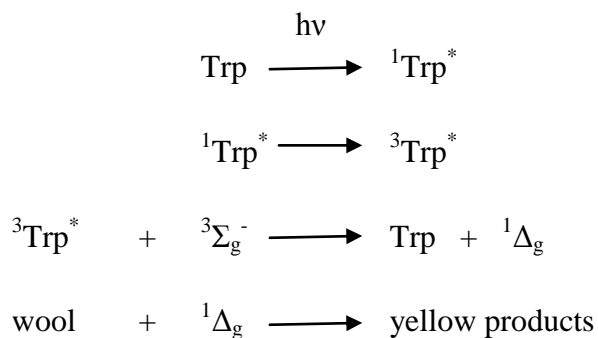

Criticism

One major criticism of a singlet oxygen mechanism is that it fails to explain the observed increase in the photoyellowing rate of wet wool. The lifetime of singlet oxygen in water is 4.2 μs , compared with 14 ms in the gas phase and any singlet oxygen is therefore rapidly deactivated. A study also showed that hydroxyl radicals are produced when wet wool is irradiated with both UV-A (366 nm) and blue (425 nm) light using a fluorescent probe. Another problem for this theory arises from studies on Trp-depleted wool. Removal of 80% of the Trp from wool had surprisingly little effect on the rate of yellowing of natural or bleached wool under wet and dry conditions over short irradiation periods (2 h wet, 24 h dry).

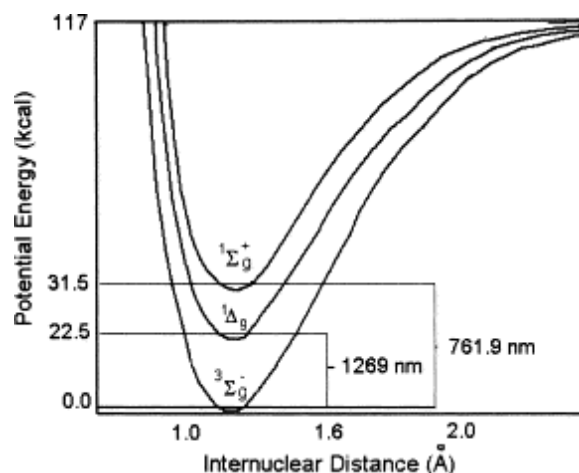

Graph 3.3 - Potential energy curves for the three low-lying electronic states of molecular oxygen.

Smith^[6] has detected singlet oxygen in dry-irradiated wool directly by measuring its luminescence emission at 1269 nm (Graph.3.3).

He found that, when wool is irradiated at 265 and 350 nm, $^1\Delta_g$ was detected at the higher wavelength only, and therefore suggested it causes photobleaching of wool, rather than photoyellowing. He also postulated that photoyellowing of wool by sunlight is much faster in the wet state because any $^1\Delta_g$ generated by visible wavelengths, which would lead to concurrent photobleaching in the dry state, is rapidly quenched by water.

Oxidation

(1996) [Millington et Church.]^[7]

The formation of both oxidized and reduced sulphur species in wool keratin after exposure to UV light is rationalized by two alternative mechanisms which are dependent on the irradiation wavelength.

Both mechanisms involve the formation of the radical anion $RSSR^-$ as a key transient species, with the formation of the radical cation $RSSR^+$ involved only in UVC exposure.

Based on the above information, the initial stages involved in the mechanism of the UVC photolysis of cystine and wool are as follows:

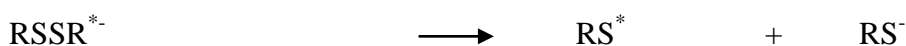
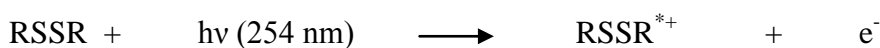

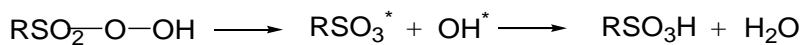
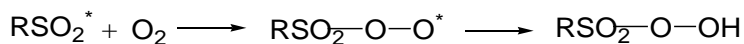
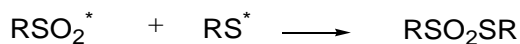
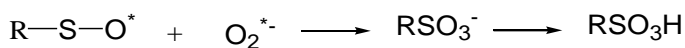
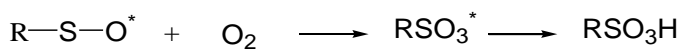
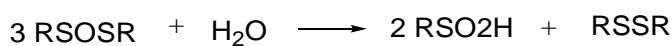
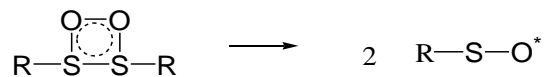
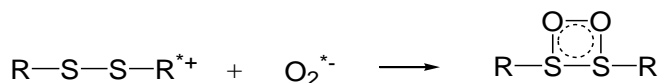
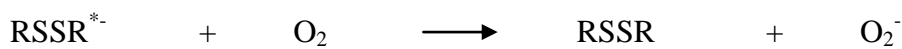

The mechanism of the UVB and UVA photolysis of cystine and wool are as follows:

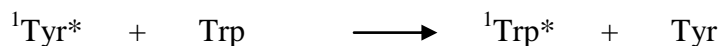
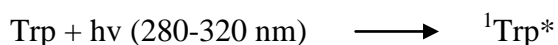
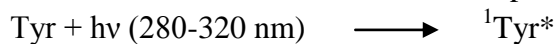

It is well known that cystine is a quenching agent for tyrosine and tryptophan in peptides and proteins.

Previous work has shown that the quenching mechanism occurs via an electron transfer process with the formation of the radical anion RSSR^-

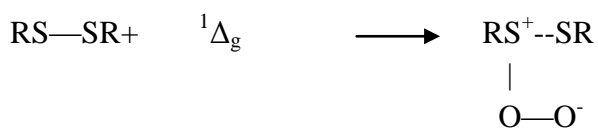
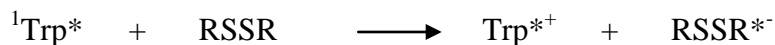
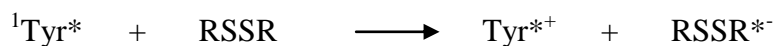

that rearrange to produce RS-SO_3^-

Oxidation

(2006) [Dyer, Bringans et Bryson]^[8]

The photo-oxidation product is consistent with mechanistic theories implicating a dominant role for the hydroxyl radical in wool; the proposed mechanism of formation is via initial production of superoxide and hydrogen peroxide, which can then generate hydroxyl radicals:



Hydroxyl radicals characteristically have an affinity for aromatic ring structures and this photomodification is consistent with hydroxyl radical attack of the tryptophan residue.

The major pathway of tryptophan photo-oxidation results in a progression in chromophore intensity, from colorless tryptophan through to the bright-yellow chromophore hydroxykynurenine.

It cannot be precluded that, in dry conditions, singlet oxygen may play a more significant role. The characterization of carboline and nitrotryptophan residues also implicates alpha-keto acids and the peroxynitrite ROS as co-contributors to the photoyellowing effect.

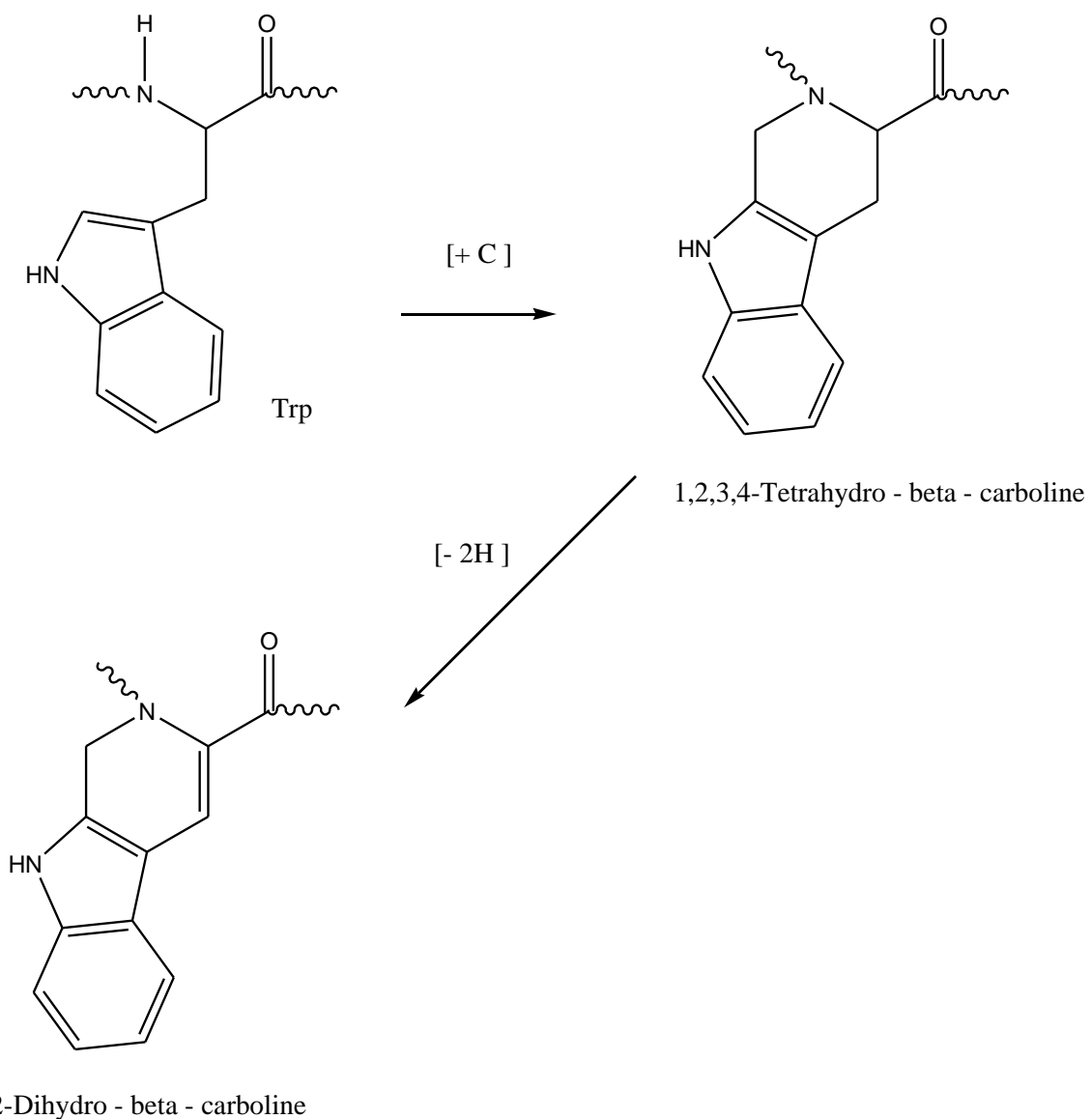

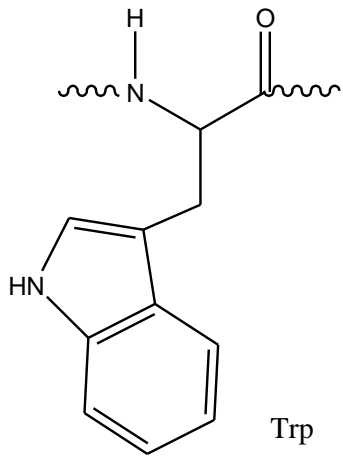

Trp

[+ O]

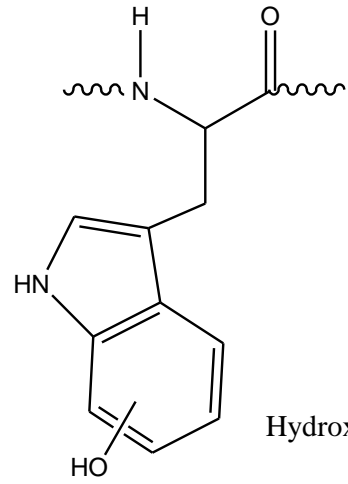

HydroxyTrp

[+ 2 O]

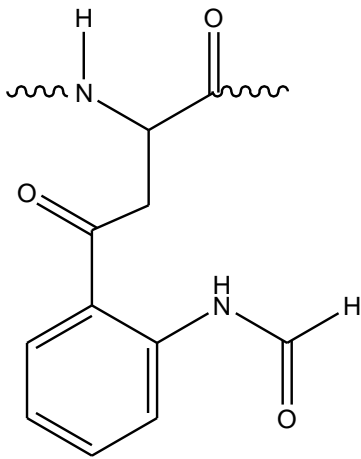

N-Formylkynurenine

[+ O]

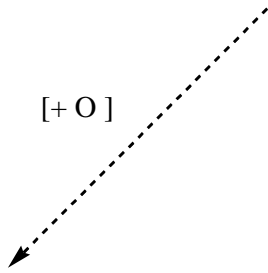

[+ O]

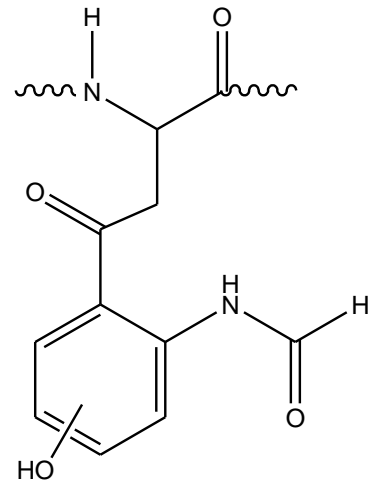

Hydroxy N-Formylkynurenine

[- CO]

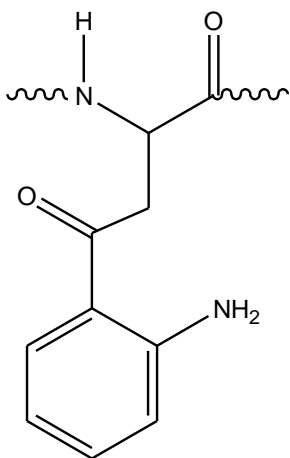

Kynurenine

[+ O]

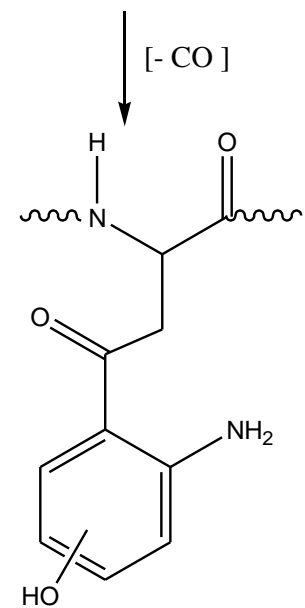

Hydroxykynurenine

[- CO]



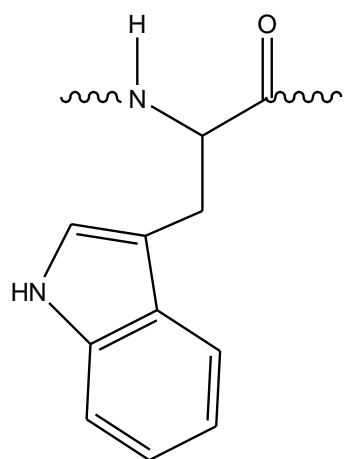

Trp

[+ O]

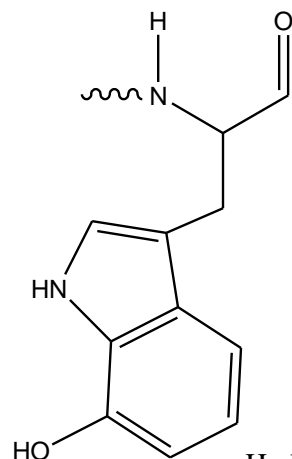

HydroxyTrp

[+ O]

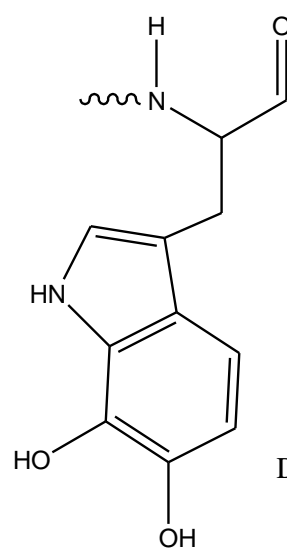

DihydroxyTrp

[- 2 H]

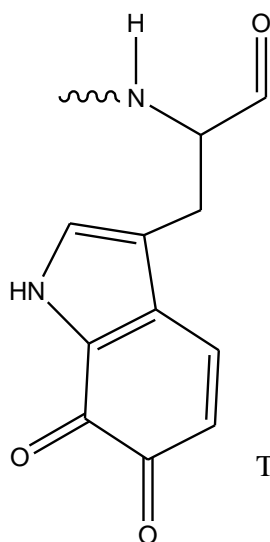

Trp-dione

[- 2 H]

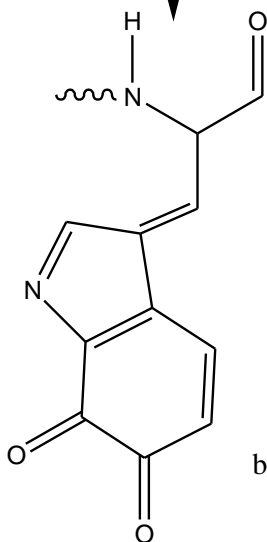

beta insaturated - 2,4 - bisTrp-dione

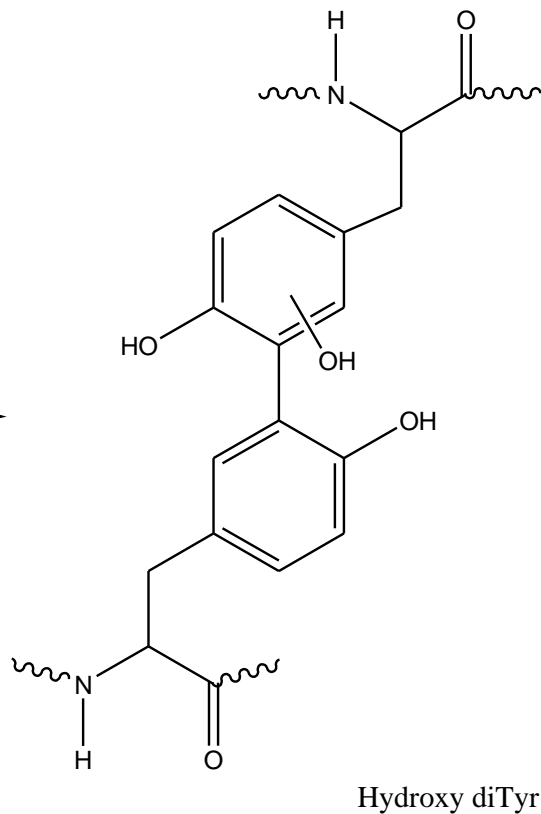
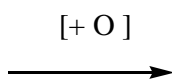
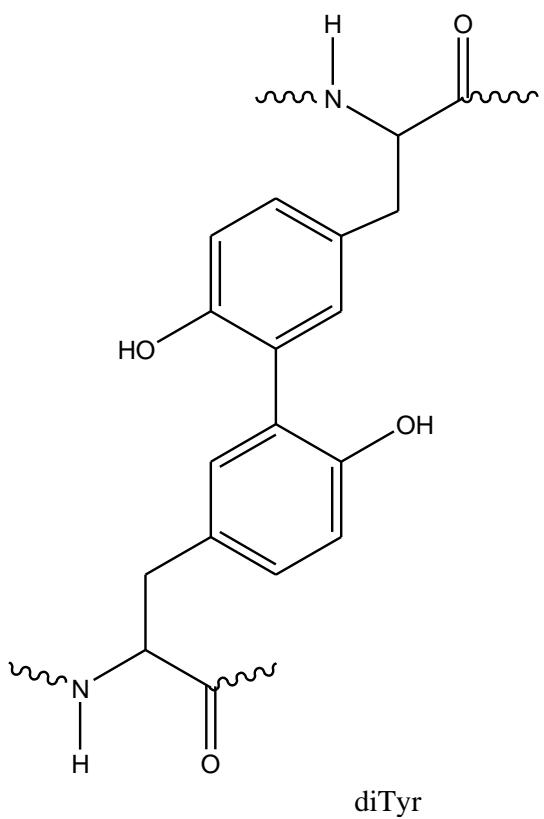
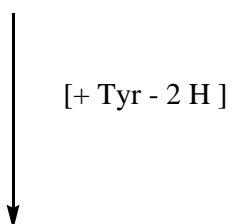
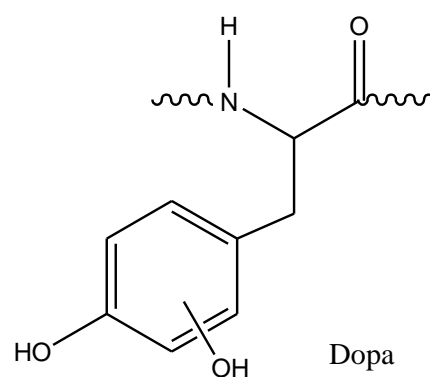
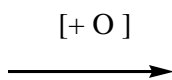
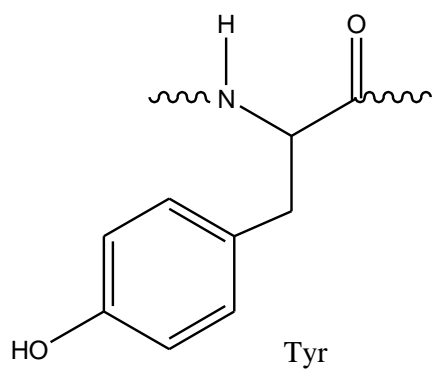

3.4 Interaction between cotton chromophores and radiation

About cotton, the situation is doubtful because the chromophores are not yet well identified; a proposed mechanism involving lignin is presented (Scheme 3).

On “pure” cellulose there are 2 behaviors:

$\lambda_{exc} < 300$ nm produce yellowing of the substrate and weight loss due to the formation of volatile photoproducts;

$\lambda_{exc} > 300$ nm leads to bleaching without any weight loss following a photochromic phenomenon.

It is suggested the presence in cellulose of a “family” of absorbing centres, with chromophores characterized by absorption bands which partially overlap.

The irradiation of the material with $\lambda_{exc} > 300$ nm induces the selective disappearance of the chromophores whose absorption maxima are centered at the irradiation wavelength, but also the partial bleaching of those possessing a weaker absorption cross section at this wavelength.

The reversibility of the colouration-decolouration cycles, over the whole range of studied wavelengths, demonstrates that the photochromism of cellulose is a general phenomenon.

This photochromism is not fully reversible, because several processes are involved during the non-radiative deactivation of excited states, only some of them being reversible during a thermal dark reaction.

The origin of this behaviour is tentatively attributed to the specific destruction and restoration of homologous chromophores.

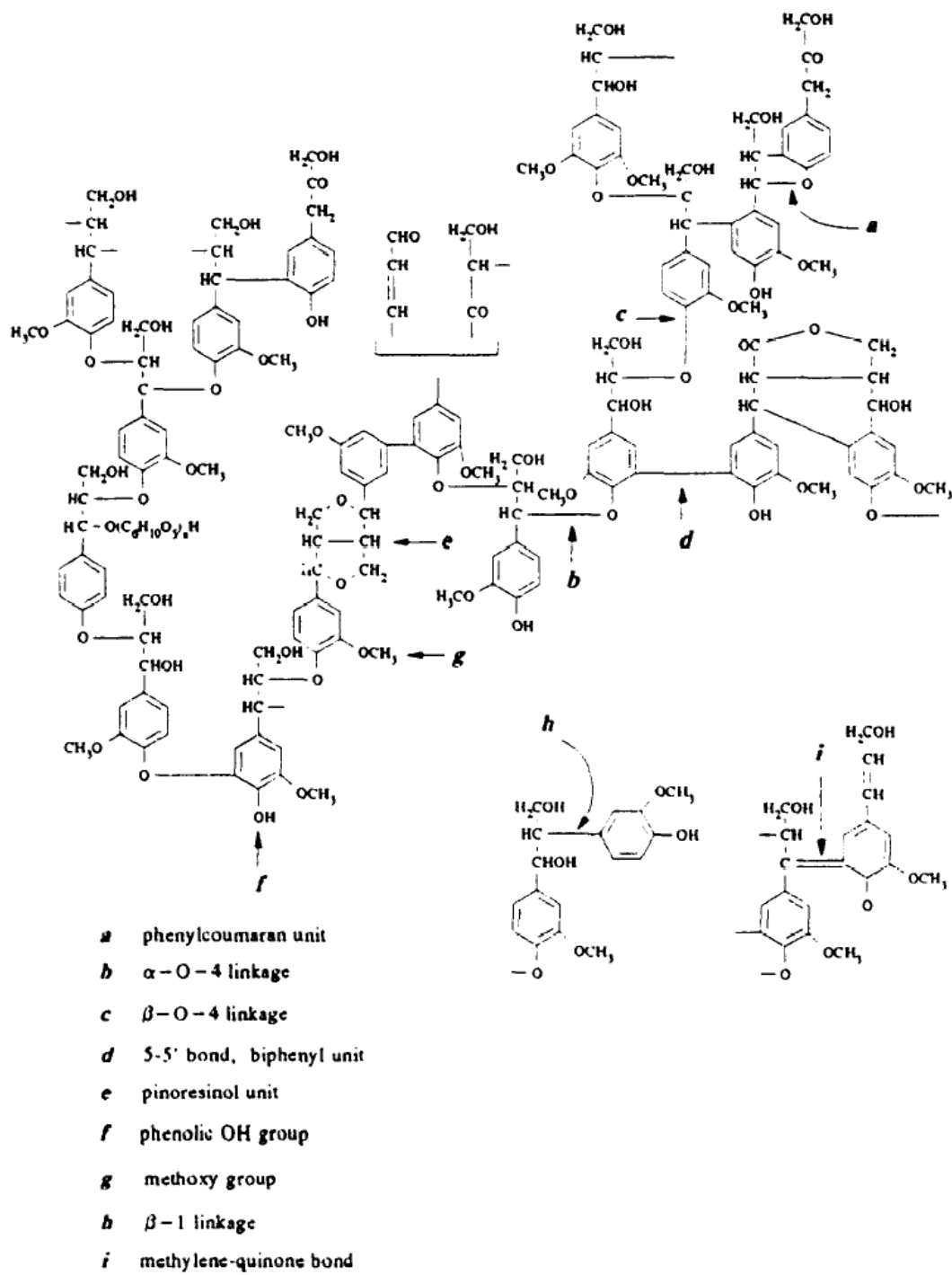

Scheme 3: A suggested structure for lignin impurity (Davidson)^[9]

The colour reversion process appears to involve both photodegradation and photochromic reactions. Chemical species probably involved in this phenomenon are quinol and phenylcoumaran residues (belonging to lignin impurity); some proposed mechanism are the following:

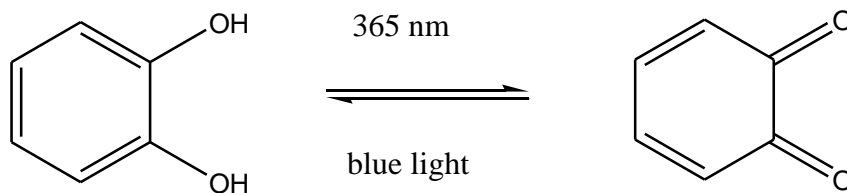
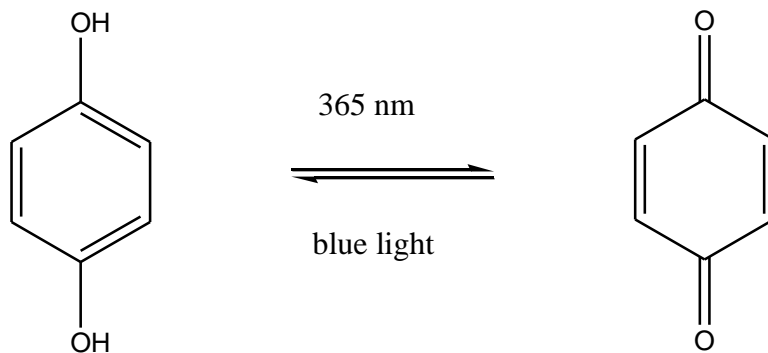

Quinol

Quinone

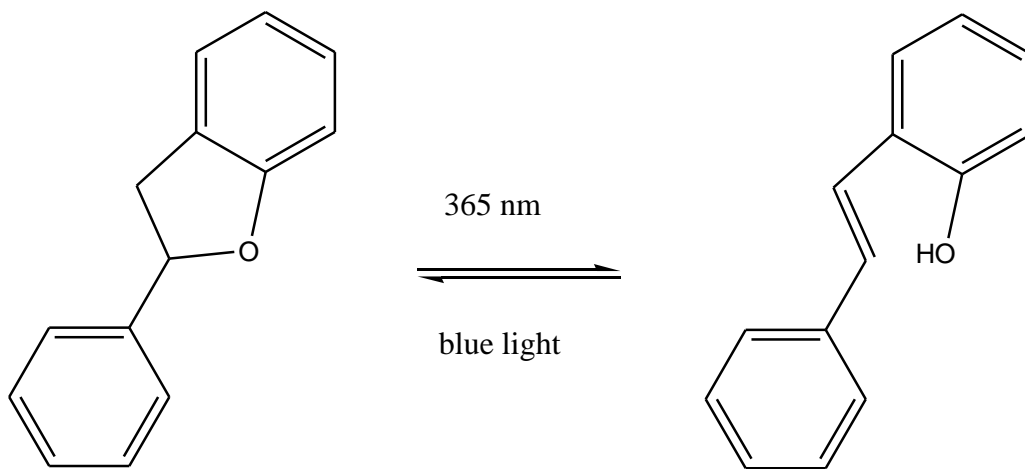

Phenyl coumaran

Hydroxy stilbene

3.5 References

- [1] K. McLaren, 1956 The spectral regions of daylight which cause fading. *Journal Society of Dyers and Colourists* 72:86–99.
- [2] R. A. Morris, T. G. Prejean, and J. G. Green, 1985
Dark time yellowing of white rigid vinyl outdoor weatherable compounds.
Society of Plastics Engineers ANTEC '85:1046–55.
- [3] A Meybeck and J Meybeck, *Photochem. Photobiol.*, 6 (1967) 355.
- [4] J. L. Hoare, *J. Text. Inst.*, 65 (1974) 503.
- [5] C. H. Nicholls and M T Pailthorpe, *J. Text. Inst.*, 67 (1976) 397.
- [6] G. J. Smith, Singlet oxygen produced by UV irradiation of wool keratin.
J. Photochem. Photobiol., B 12(2): 173-8 (1992).
- [7] K.R. Millington, J.S. Church, *Journal of Photochemistry and Photobiology B: Biology* 39 (1997) 204-212.
- [8] Dyer, Bringans et Bryson, *Photochemistry and Photobiology*, 2006, 82: 551-557.
- [9] R.S. Davidson, *Journal of Photochemistry and Photobiology B: Biology* 33 (1996) 3-25.
- [10] Choudhury, Collins et Davidson, *J. Photochem. Photobiol. A: Chem.* 69 (1992) 109-119.

2nd PART

EXPERIMENTAL WORK

Chapter 4

Instrumental methods and equipments

4.1 Instrumental methods

4.1.1 Reflectance colorimetry

To characterize dyeings and their chromatic effects objective methods universally recognized are needed; for this purpose instrumental methods were used.

Those methods belong mainly to the colorimetry, based on the measuring of reflectance and absorbance / transmittance; any dyed textile substrate presents a colour (tone) belonging to the substrate itself under certain conditions of observation. There are three factors that contribute to the final perception of colour [1], [2], [3]:

- the nature of the surface, that is the spectral curve of the object (Fig.4.1.1);
- the type of lighting, depending on the spectral distribution of the light source (Fig.4.1.2);
- the ability of colour perception of the observer (Fig. 4.1.3);

These three factors, appropriately weighted, provide the ultimate feeling, so the colour result as a stimulus. (Fig. 4.1.4)

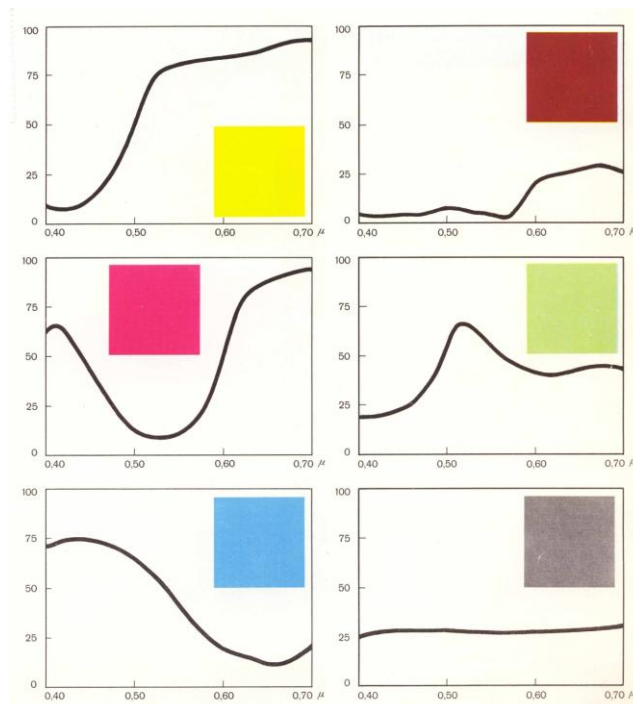

Fig. 4.1.1 Spectral curves of the objects

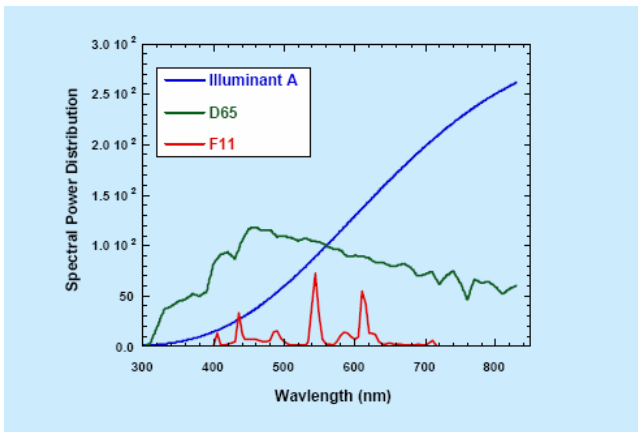

Fig. 4.1.2

Spectral distribution of the light sources

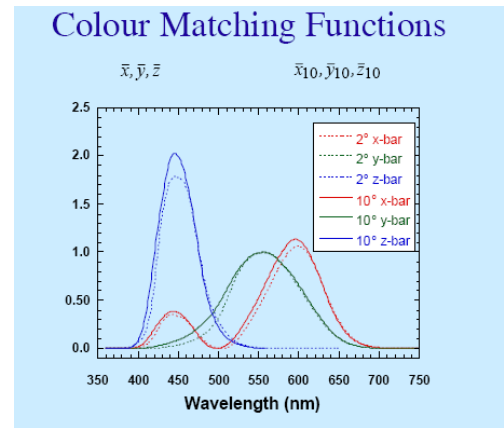

Fig. 4.1.3

Colour perception of the observer

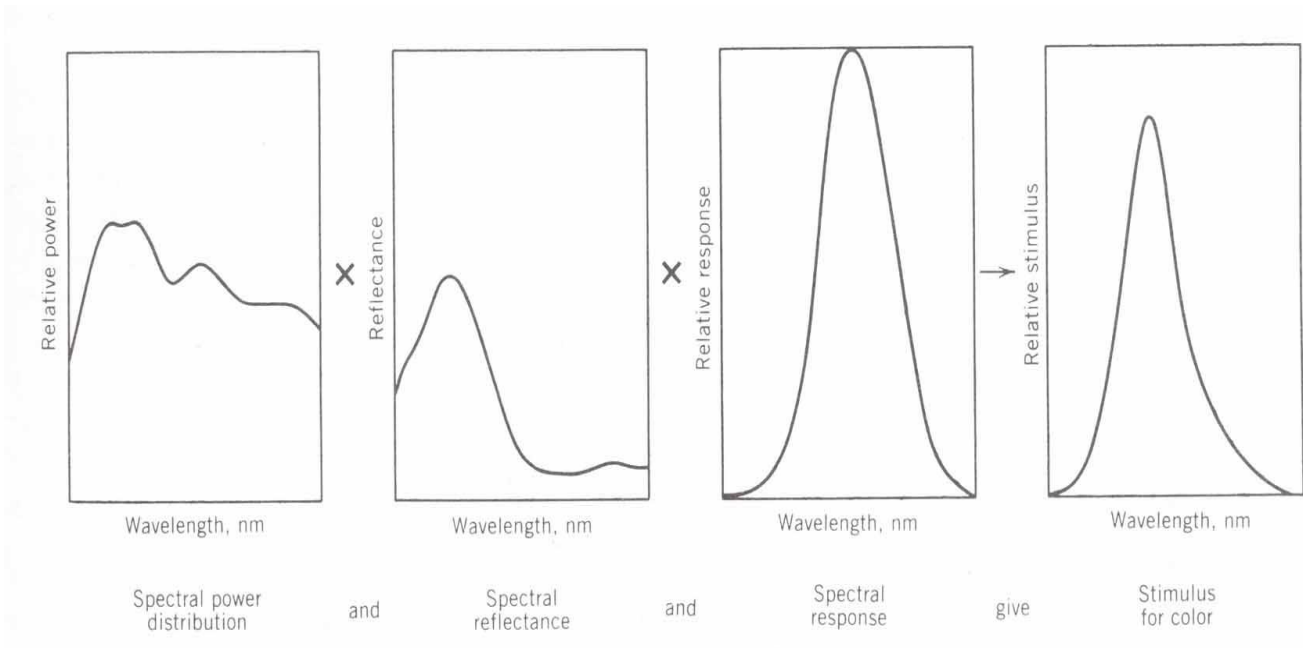

Fig. 4.1.4 Colour stimulus

For an objective “final judgment” it is necessary that the three factors are standardized. The reflectance colorimetry refers to a flat object, to a selected lighting and to a standard observer; after defining these 3 parameters, the color can be expressed in mathematical terms and be communicated at a distance with numerical sets; among the most common, citing CIELab color coordinates, or CIELCH, which allow to transfer the “chromatic idea” with few numbers.

These color systems refer to the virtual colour spaces, where with three coordinates, the colour of an object under a particular lighting and perceived by a standard observer, can be ideally placed inside the space.

The reflectance spectrophotometer is the instrument that can "capture" the colour in a physical mode and "give back" by means of the color chromaticity coordinates easily interpretable from the user.

The CIELab color space (Fig. 4.1.5) is in fact represented by the following coordinates:

L (value) ranging from 0 (black) to 100 (white);
a (green – red) ranging from negative score (green) to positive score (red);
b (blue – yellow) ranging from negative score (blue) to positive score (yellow).

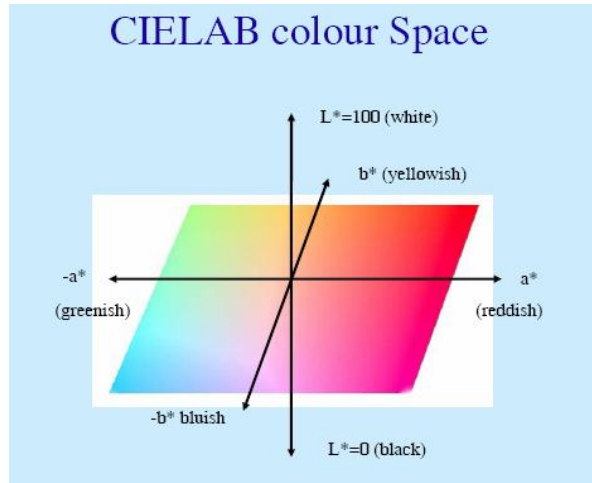

Fig. 4.1.5 CIELab colour space

In our case the reflectance colorimetry is useful for determining color differences (delta E) in accordance with the relationship:

$$\Delta E = (\Delta L^2 + \Delta a^2 + \Delta b^2)^{1/2}$$

where:

ΔL = value difference

Δa = difference of the a parameter

Δb = difference of the b parameter

and express, in an objective way, color differences between two objects, or two parts of the same object.

The portable instrument Datacolor Check II Plus is capable of providing many expressions for colour differences, however, the one we used was CIELab, above described, expressing a chromatic opinion easily interpretable.

For example, a $\Delta E \geq 5$ shows a big difference between two colours, but does not clarify how they differ while an exhibition explaining that $\Delta E = 5$, consisting of:

$$\Delta L = -3 \quad \Delta a = 0 \quad \Delta b = +4$$

means that the 2nd color is:

$\Delta L = - 3$ less bright compared to the 1st colour
 $\Delta a = 0$ equally red (or equally green) on the 1st colour
 $\Delta b = + 4$ more yellow than the 1st colour

The reflectance colorimetry was used also to express the strength of a dyeing, according to the Kubelka-Munch's law (discussed in Chapter 5).

The colour measurements were conducted using portable spectrophotometer Datacolor Check II Plus (Fig.4.1.6); this instrument consists of a Ullbricht's sphere and allows to illuminate the sample with diffuse radiation using different diaphragms and different types of normed lighting. In our case D65 illuminant was used). The radiations reflected from the sample were analyzed with different geometries, and the data collected were processed by the built-in hand-held computer.



Fig. 4.1.6 Datacolor Check II Plus

(taken from: www.industrial.datacolor.com - last access on 30/09/2013)

4.1.2 UV-VIS spectrophotometry

The absorbance colorimetry (or transmittance colorimetry depending on the numeric measures) is applied to colored solutions and allows to compare their colors by relating the solution components and their quantities, through the Beer-Lambert's law (Fig. 4.1.7 (a)):

$$A = \epsilon l c$$

where:

ϵ = absorption coefficient

l = path length

c = concentration

A = absorbance = $\text{Log} (1/T) = \text{Log} (I_0/I)$

T = transmittance = I/I_0

I = intensity of radiation coming out

I_0 = intensity of incident radiation

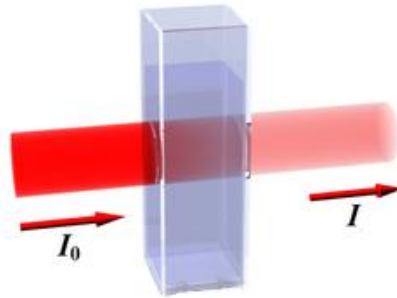

Fig. 4.1.7(a) Beer-Lambert's law

(taken from: http://stevegallik.org/sites/all/images/Beer_lambert_2.jpg - last access on 30/09/2013)

UV-Vis analyses of exhausted dyebath liquors were performed on a Evolution 300 UV-Vis spectrophotometer (Thermo Scientific) equipped with dual beam optical system, ranging from 190 nm to 1100 nm (Fig. 4.1.7 (b)).



Fig. 4.1.7 (b) Evolution 300 UV-Vis spectrophotometer

(taken from:

http://www.thermoscientific.com/ecom/servlet/productsdetail_11152_L11445_87231_11956207

-1 - last access on 10/11/2013)

4.1.3 FTIR-ATR spectroscopy

FTIR-ATR (attenuated total reflection) analyses were performed on a Nicolet FTIR 5700 spectrophotometer equipped with a Smart Orbit ATR single bounce accessory mounting a diamond crystal (Fig. 4.1.8). Each spectrum was collected directly on single yarn by cumulating 128 scans, at 4 cm^{-1} resolution and gain 8, in the wavelength range $4000\text{-}600\text{ cm}^{-1}$.

Even in this case, all treated and untreated samples were subjected to the analysis. The method doesn't allow quantitative but just qualitative evaluations, sorting out the peaks characteristic of the functional groups present on sample surface.

Working with the ATR technique the spectroscopic information obtained comes from wool fiber surfaces, examined about 100 nm in thickness, and it is possible to study modifications at level of fibre cuticle. The tested sample is "pinched" by a clamp against a diamond crystal; the IR radiation beam is focused on the crystal so that within the same undergoes continuous reflections, in which the sample is only superficially interested.



Fig. 4.1.8 Nicolet FTIR 5700 spectrophotometer

4.1.4 SEM analysis

The surface morphology of the fibres was examined by SEM (scanning electron microscopy) with a Leica (Cambridge, UK) Electron Optics 435 VP scanning electron microscope with an acceleration voltage of 15 kV, a current probe of 400 pA, and a working distance of 20 mm (Fig. 4.1.9). The samples were mounted on aluminum specimen stubs with double-sided adhesive tape and sputter-coated with Au in rarefied Ar using an Emitech K550 Sputter Coater (Fig. 4.1.10) with a current of 20 mA for 180 s.



Fig. 4.1.9



Fig. 4.1.10

Leica Electron Optics 435 VP SEM

Emitech K550 Sputter Coater

SEM enables the analysis of the microstructural characteristics of solid surface, providing three-dimensional images at high magnifications and high resolution; electrically heating a W filament (cathode) to about 2700 - 2900 K under a vacuum of at least 10^{-3} Pa, are first generated electrons for thermionic effect, remembering that a greater heating current corresponds an increasing emitted current density. The produced electrons are thus accelerated by an anode and collimated by "lenses", namely by magnetic fields with circular symmetry, powered by an excitation current. The electron beam is focused by interaction with the magnetic field and the distance from this point (focus) at the center of the "lens" is the focal distance; the focal distance is a function of voltage applied between anode and cathode, and also of the current which induces magnetic field. It is possible, varying appropriately on these 2 parameters, vary both the size of the beam that the focal distance, determining the resolution characteristics and depth of field of the image. The primary electron beam so focused is subjected to the action of two scan coils that deflect it from its optical axis; these coils generate a beam double deflection on a perpendicular plane. In this manner the beam "explore", in subsequent times, contiguous areas of the sample making the scansion.

The interaction between accelerated electrons and the substance generates emission of reflected electrons, backscattered electrons, secondary electrons and electromagnetic radiation of different wavelength; in this case the interest is directed to the secondary and backscattered electrons, that after having been collected by a collector and accelerated, come to a photomultiplier, which sends signals to a cathode ray tube. The resulting image is the correspondence between each point of the

excited sample and a corresponding point of the cathode ray tube; the magnification depends on the ratio between the size of the display system (generally constant) and the size of the scanned surface (variable by the operator). Changing electronically the geometry it is easily possible switch from one magnification to another keeping the depth of field (Fig. 4.1.11).

Exposure of surface to electron beam involves accumulation of electrostatic charges (especially for less conductive material, such as animal fibers);whereby there is a risk of overheating the investigated area, with possible sample destruction. For observations at low magnifications, ie with low voltage, this phenomenon is not so important, but working at high magnifications it is necessary to protect the sample; such protection is to cover it with a thin layer of conductive material. The simplest technique of coating is the metallization by "sputtering", which consists in submitting under examination fibers at a plasma current in inert atmosphere (Ar) under a vacuum of 10-20 Pa, using Au as coating material.

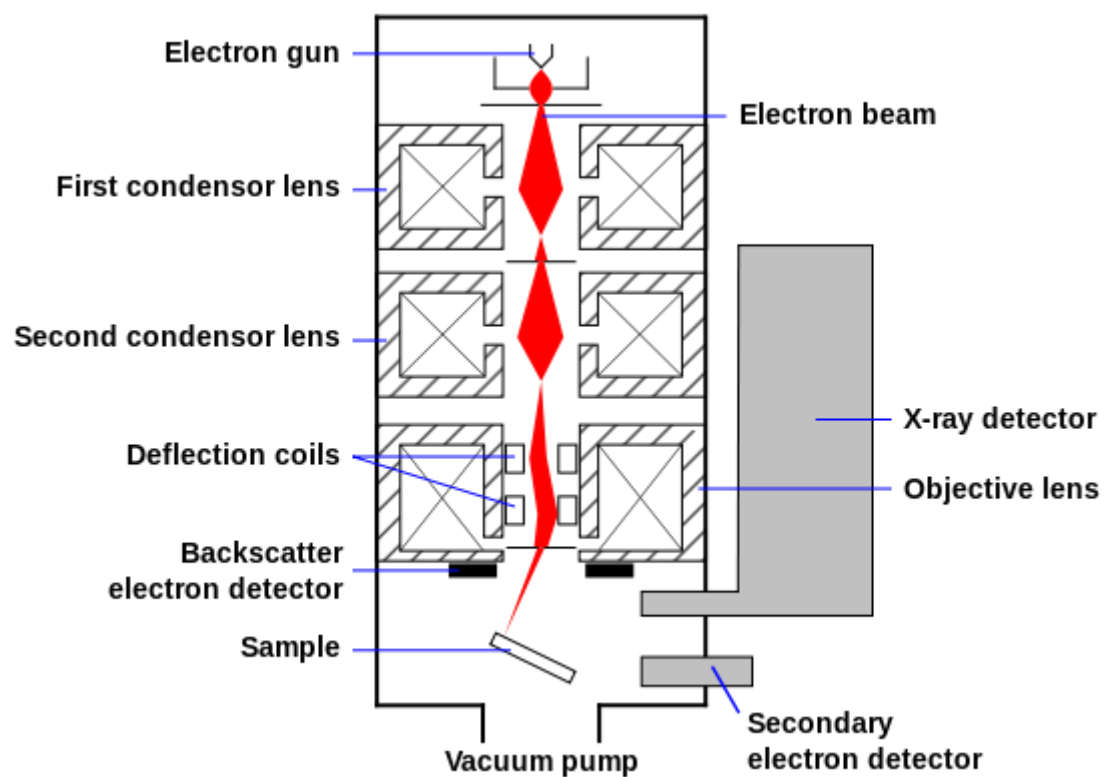

Fig. 4.1.11 Scheme of SEM

(taken from: http://photos.foter.com/19/schema-meb-en_1.png - last access on 30/09/2013)

4.2 Technical methods: fastnesses test

To characterize dyeings and its properties, in particular fastnesses, objective and universally recognized methods are needed; for this purpose technical methods were used.

For testing the fastness standard methods recommended by Woolmark were used and performed according to their specifications.

For domestic washing fastness test method TM 193a was used. It is a small-scale accelerated laboratory test, able to predict the colour fastness of wool textiles to repeated washing in the wool wash cycle in a domestic washing machine, using a low foam detergent solution (based on ISO 105 C06.B2S).

A specimen of dyed wool textile in contact with a multifibre undyed fabric is shaken in a washing solution, rinsed and dried; the colour change in the specimen and in the multifibre fabric are then evaluated with standard grey scales. The tests were carried out in the Minox apparatus (Fig. 4.3.1) using a washing solution composed of ECE-2 (standard reference detergent without NaBO_3) with the following parameters:

washing solution: 150 mL of ECE-2 (4 g/L solution)
temperature: 50°C
time: 30'

The specimen is then removed from the washing bath, rinsed twice for 10' with cold water and dried at maximum temperature of 60°C; the colour assessments, both degradation and staining, are made with standard grey scales; their values, ranging from 1 to 5, are listed in Tables 4.2.1 and 4.2.2

degradation grey scale	colour difference (ΔE)
5	0
4	1.5
3	3
2	6
1	12

Table 4.2.1 Degradation grey scale values

staining grey scale	colour difference (ΔE)
5	0
4	4
3	8
2	16
1	32

Table 4.2.2 Staining grey scale values

Clearly, going by the value 5 to the value 1, the fastness progressively worsen.

For rubbing fastness (dry and wet) test method TM 165 was used, It is a test able to predict the colour fastness of wool textiles to rubbing on bleached and undyed cotton fabric, (based on ISO 105 X12).

The tests were carried out by Crockmeter apparatus (Fig. 4.3.2). A specimen of dyed wool textile in rubbed on (dry or wet) bleached and undyed cotton fabric (the specimen is fixed on the testing device and there are made 10 runs in 10'') are then evaluated with staining standard grey scale:

4.3 Equipments

4.3.1 UV static apparatus

The static UV apparatus (Figg. 4.3.1 (a) and (b) (Helios Italquartz – Milano) is a box containing a medium pressure mercury UV lamp cooled by cold air circulation; the textile material is endorsed on a metallic support and receives the irradiation at variable distances from the UV source.

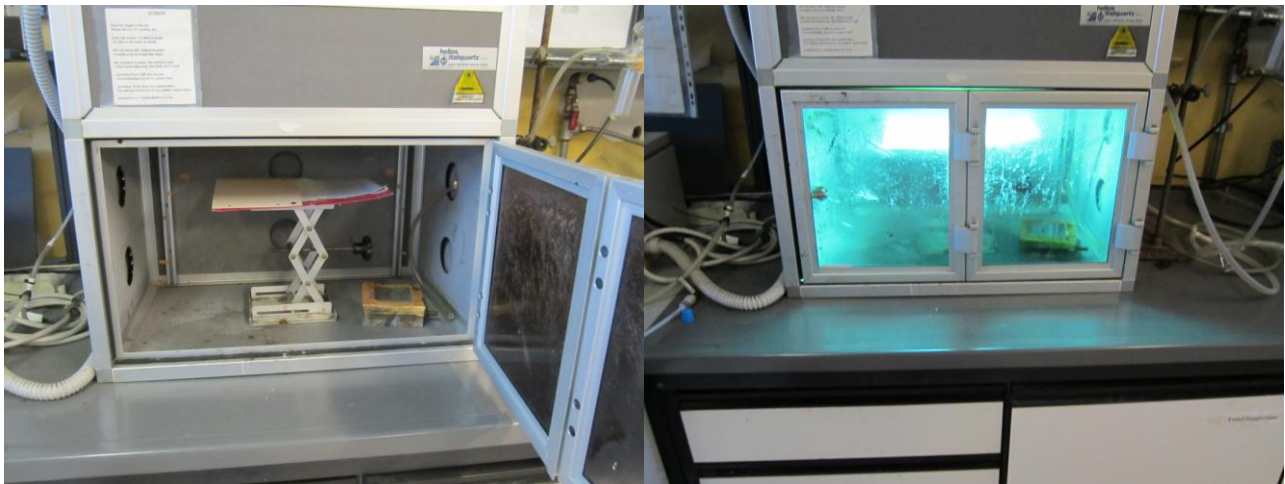

(a)

(b)

Fig. 4.3.1 (a) and (b)

Static UV apparatus

4.3.2 UV dynamic apparatus

Sunwash[®] (Stamperia Emiliana, Parma) is the dynamic UV apparatus used. It is composed by a chassis in which the power supply system, the cooling ventilator and the of ozone suction system, that is an appropriate carbon filter able to reduce ozone to oxygen, are mounted). The UV lamp, arranged in the upper part of the machine, in fact produces ozone that need to be removed because it is dangerous for human health. This apparatus, depending on its accommodation, can radiate with UV light the textile material in form of unwound yarn from creel, as parallel wires that advance under the action of the lamp (Fig. 4.3.2 (a)), both in the form of hanks which advance on a conveyor belt (Fig. 4.3.2 (b)), or in the form of pieces always moved by belt.



(a)

Fig. 4.3.2 (a) and (b) *Dynamic UV apparatus*



(b)

4.3.3 UV radiometer

The UV radiometer apparatus (Innovative UV Measurements – Sterling, VA) (Fig. 4.3.3) is an apparatus able to measure the irradiance of electromagnetic radiations incoming (mW/cm^2); this device was useful for the comparison of different UV sources (three kind of UV machines, both static or dynamic).

The operating principle is based on thermocouple effect: an optical fiber conveys the radiations on the sensor surface that has a hot junction on the irradiated surface and a cold junction on the surface dark. The irradiation generates thermoelectric effect which is amplified and linearized as irradiance.



Fig. 4.3.3 UV radiometer apparatus

4.3.4 Minox

The first dyeing apparatus used (Fig.4.3.4) was the Minox (Minox – Portula). it consists of a tank containing a rotary system for the dyeing of max 8 laboratory samples weighting 10 g – 100 g; the heating is provided by a system of resistors immersed in a carrier fluid (such as glycerin) that allows to keep the temperature uniform inside, while the cooling is ensured by a serpentine immersed in the carrier fluid in which cold water circulates. Thermal cycles can be managed by a programmer and the range of temperature vary from 40 °C to 130 °C.

The Minox allows to perform both lab dips and fastness tests, working on small quantities of textile material in form of staple, top, hank and fabric.



Fig. 4.3.4 Minox dyeing apparatus

4.3.5 OBEM API/O/1

The second dyeing apparatus used was the API/O/1 (OBEM – Biella) (Fig.4.3.5), it consists in a cylindric autoclave where the textile material is lodged; the dye-bath, heated by electric resistances, circulates by centrifugal pumps; through a 4-way valve it is possible to reverse flow (internal-external, external-internal), allowing optimal diffusion of auxiliary products and dyes in the packaged textile. Thermal cycles are managed by a PLC and the range of temperature vary from 40 °C to 140 °C.

The API/O allows to dye related big quantities of textile material in form of bobbin or fabric, ranging from 2 kg to 24 kg.



Fig. 4.3.5 OBEM API/O/1

4.3.6 Teintolab

In order to diagnose the dyeing phenomena, Teintolab (Comeureg – Haubordin) equipment was used (Fig. 4.3.6); Teintolab can be defined as a basic lab-scale apparatus, connected to an on-line light filter colorimeter and to a PC for recording dyestuffs coloration and pH profiles versus operation time; this equipment can reproduce a dyeing process in all its steps.



Fig. 4.3.6.a Teintolab apparatus

Teintolab consists in a dyeing vessel (detail in Fig. 4.3.6.a) capable of dyeing textile material in different shapes (staple, top, hank, bobbin and fabric) up to a maximum of 100 g; as shown in the layout (Fig. 4.3.6.b), devices for the automated introduction of solid products (such as salts) and liquids (auxiliary products) during the dyeing operations are provided; the circulation of the dyeing liquor is ensured by centrifugal pumps providing internal towards external circulation in the textile material, while the vessel pressure is supported by a compressor. There is a detection system of the pH and of liquor exhaustion in continuous: optical fiber connect a colorimetric cell with colorimetric reading system - PC online.

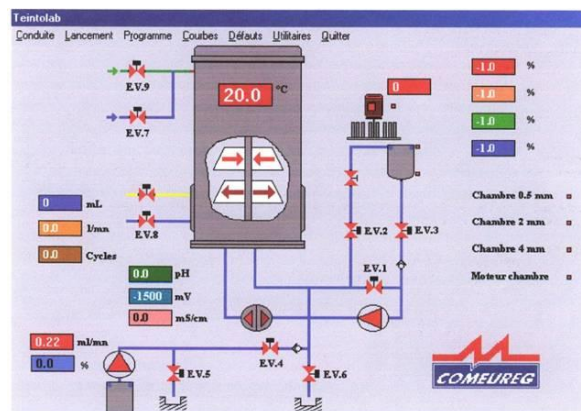

Fig. 4.3.6.b Teintolab layout

4.3.7 Crockmeter

To determine dry and wet colour fastness to rubbing^[4] the Crockmeter apparatus (SDL Atlas – Ontario) was used (Fig. 4.3.7). It consists in a fixed base anchored to the textile in examination and a mobile "arm" actuated with a reciprocating motion; this "arm", having determined weight, is fitted with a tip on which is mounted a specimen of cotton (dry or wet). The test consists in rubbing the tip on the textile in examination by 10 alternating movements in 10 seconds.



Fig. 4.3.7 Crockmeter

4.4 References

[1] H. Zollinger, *Color Chemistry: Syntheses, Properties and Applications of Organic Dyes and Pigments*, Zürich, 2003.

[2] E. Barni, Lecture notes “Chimica dei Coloranti”, academic year 1992/'93.

[3] F. Ferrero, Lecture notes “Processi Industriali della Chimica Fine”, academic year 1993/'94.

[4] J. Cegarra, P. Puente et J. Valdeperas, *The dyeing of textile materials, the scientific bases and the techniques of application*, 1992, Texilia, Biella.

Chapter 5

Adjustment and optimization of the available tests of degree of treatment, for a fast evaluation of the intensity and uniformity of the treatment.

5.1 Introduction

In order to obtain good colour yields, levelness and brightness in wool fabric printing, it is essential first to modify the fibre surface by using a suitable pretreatment; also in differential dyeing it is very important to have an appropriate preparation of substrate develop a reproducible effect.

For this reason, many technicians proposed different kind of pre-treatment onto wool fibres, mainly for fabrics; Heiz^[1] points out that before the pre-treatment other steps should be considered:

setting: useful for the relax and for the stabilization of cloth, it is usually carried out by crabbing (continuous or discontinuous steaming);

scouring: necessary for processing oils, dirt and size removal, , it is commonly achieved with commercial detergents, sometimes by addition of suitable enzymes;

milling: occasionally applied to impart the desired finish effect to the cloth.

Then, the preparation of wool can be performed; one of the earliest process is an oxidation, with the purpose to increase the colour yield and to produce well-defined edges. The most commonly used procedures are based on chlorination while other oxidative processes, such as treatments with permonosulphuric acid or its salts, are not yet developed.

The first kind of chlorination was performed starting from sodium hypochlorite and hydrochloric or sulphuric acid, adjusting the pH to range 1.5 – 2.0. An alternative way, introduced by Kroy Unshrinkable Wool Ltd of Canada and Woolmark, is the use of chlorine gas mixed to water.

Both the technologies consist in the production of a mixture of chlorine, hypochlorous acid or hypochlorite; these species are markedly depending from the pH of the solution according the Graph. 5.1

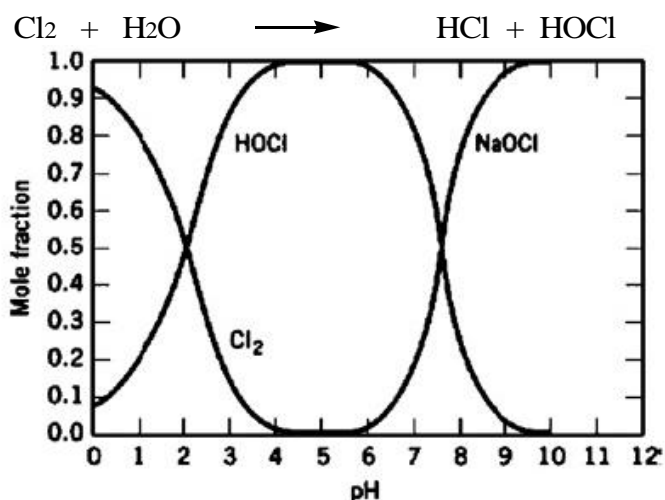

Graph. 5.1 Equilibrium between Cl_2 and HOCl in aqueous media

Another alternative is based on an organic chlorine compound (DCCA sodium salt) That, dissolved in water, is responsible for the production of hypochlorous acid.

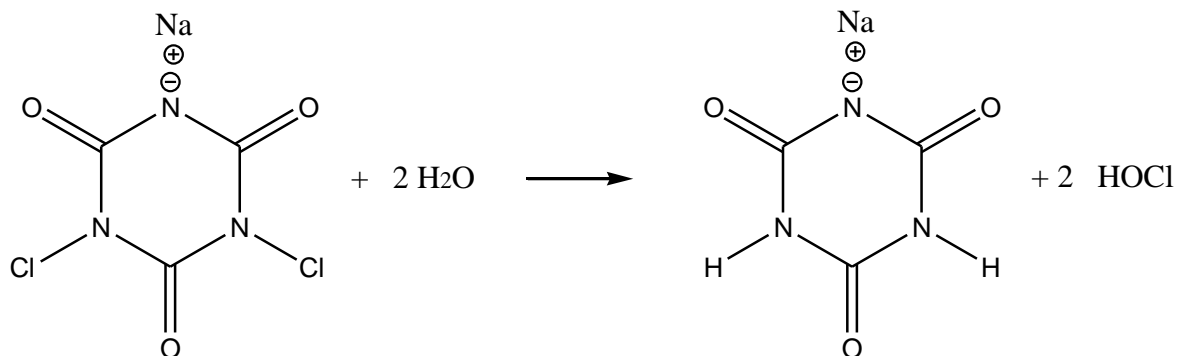

All these processes are carried out onto wool fibres employing a suitable wetting agent, durable in the acid/oxidizing media, in order to have a good distribution of oxidant agent on the fibres surface. Under strongly acid conditions a quickly reaction between Cl_2 and wool takes place, followed by little fibre yellowing, but with poor levelness of oxidation. Under alkaline conditions (ClO^-) the reaction is slower and the oxidation effect is more homogeneous, but the yellowing becomes significant. With DCCA sodium salt instead, it is possible to achieve a good levelness of treatment coupled to a middle yellowing effect even without a pH control .

In differential dyeing techniques these treatments are commonly used in order to have increased affinity toward dyestuffs, allowing to get colour differences between treated and untreated parts of the same textile material.

The reactions happening during chlorination (the most important, as suggested by Bell ^[2]) are:

cystine oxidation: cystine residues are quickly oxidized to cysteic acid residues;

peptide bond cleavage: chlorine tends to cleave peptides and proteins at tyrosine residues.

5.2 Available tests

Some researchers proposed different test to evaluate the grade of the given pre-treatment; Millington ^[3] has proposed the use of Reactive Blue 72 dyestuff (Fig. 5.2.1).

This test is based on the increased affinity of the Cu²⁺ phthalocyanine towards oxidized wool fibres; the new groups, generated by oxidant agent or by UV radiations, are able to form new bonds with Cu²⁺ ion inside the phthalocyanine, then the dyestuff results more attracted by the oxidized cuticle. It's possible that Cu²⁺ normally with planar coordination (4 ligands) inside the phthalocyanine complex, undergoes coordination 5 for admittance of a fifth ligand, changing the symmetry towards square pyramid.

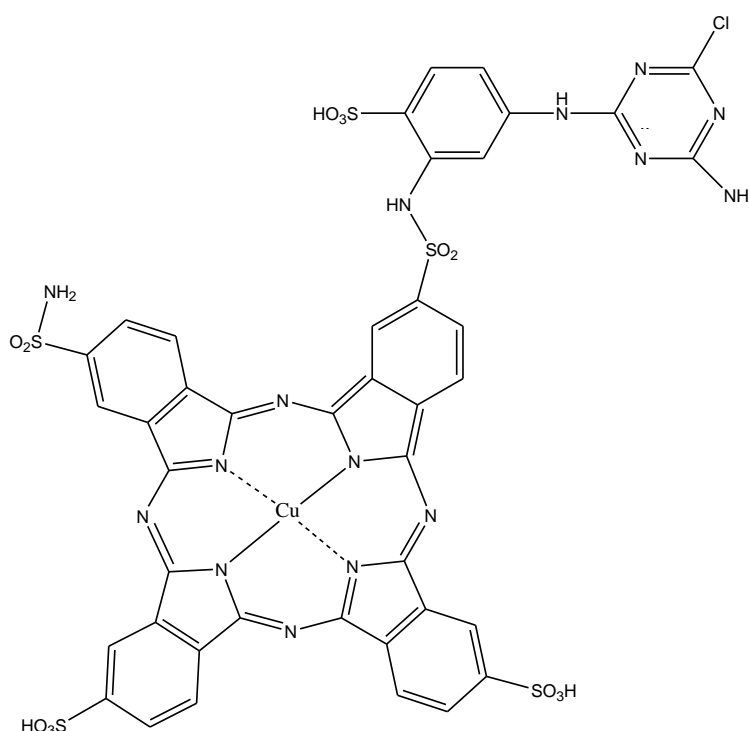

Fig. 5.2.1 Reactive Blue 72 (Cibacron Turquoise P-GR) supplied by Huntsman

The dyeing carried out with Turquoise Cibacron P-GR offers a good scenario about the uniformity of the previous oxidant treatment; also the intensity of scheduled recipes is useful for the evaluation of the intensity of oxidant action. A method for this comparison is the measurement of the K/S parameter, from Kubelka Munch equation:

$$K / S = (1 - R_{\lambda})^2 / (2 R_{\lambda})$$

where:

K is a parameter related to the dyestuff

S is a parameter related to the substrate

R_λ is the reflectance value, measured at the λ_{max} for that dyestuff-substrate system

Other proposals are Lanazol Black R and Palatin Fast Black WAN; the first one is a not well defined mix of alfa bromo acrylamido dyestuffs, while the second one (Fig. 5.2.2) is a classical 1:1 metal-complex dye, formed by an o,o'-azo dyestuff complexed with a Cr^{3+} ion that may be linked by oxidized groups previously mentioned.

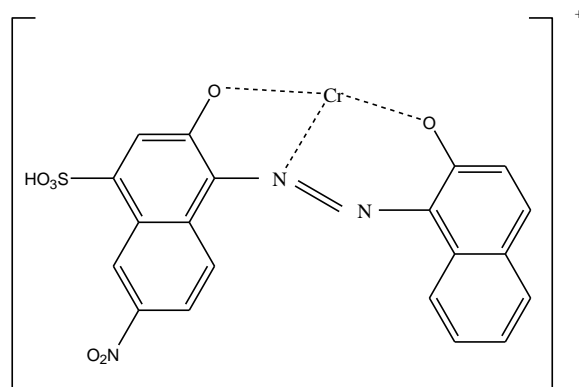

Fig. 5.2.2 Acid Black 52 (Palatin fast Black WAN) supplied by Basf

5.3 Proposed test

The available tests allow an assessment of the intensity of the UV treatments, however, are not very critical about the treatment uniformity; for this reason we tried a new test that brings together both ability (intensity and uniformity).

A new proposed test for the evaluation of degree and uniformity of UV treatments is based on Reactive Blue 38 (Brilliant Green Remazol 6B 175%) by Dystar (Fig. 5.31). Even in this case it is a phthalocyanine (metal complex dye) but with a Ni^{2+} ion complexed in its cavity.

It has the foregoing structure, where the Ni^{2+} (with coordination number of 4) is linked with 2 covalent bonds and 2 dative covalent bonds. Likewise, it's possible that Ni^{2+} having planar coordination (4 ligands) inside the phthalocyanine complex, undergoes coordination 5 or more easily 6 for admittance of one or two new ligands ^{[4], [5], [6]} changing the symmetry towards square pyramid, or most probably towards octahedral symmetry where 2 axial ligands differ from the others.

In facts this particular dyestuff has the possibility to displace two water molecules with more strong electron-donors groups, such as cystine oxides or cysteic acid; therefore it can be formed the octahedral complex (Fig. 5.3.2) with oxidized groups of UV treated wool. For this reason, we suggest to use this dyestuff as marker for the degree of UV treatment on wool.

An advantage, compared to the dye previously recommended, may be that Brilliant Green Remazol 6B 175% (Ni^{2+} - Phthalocyanine) can be coordinated by 2 ligands instead of only one (as in the case of Cu^{2+} - Phthalocyanine), then the test selectivity could be increased.

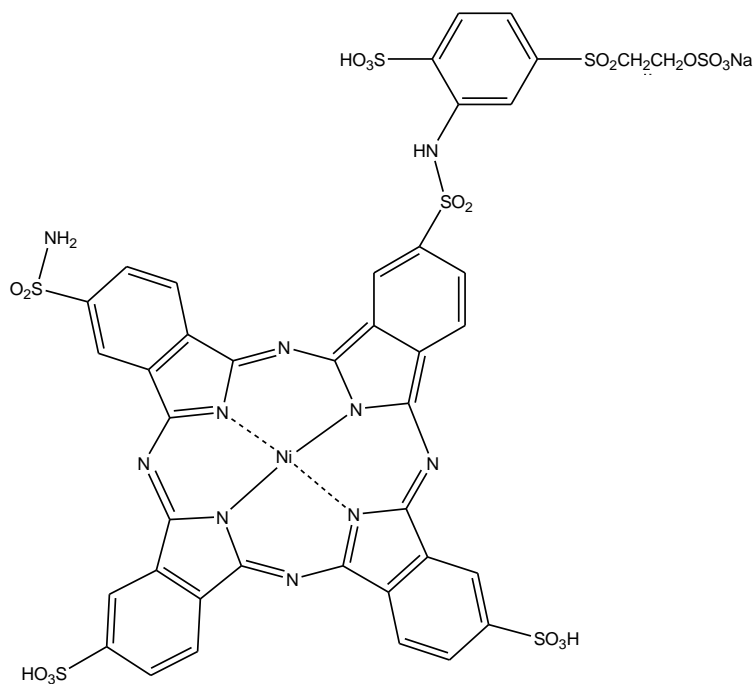

Fig. 5.31 Reactive Blue 38 (Brilliant Green Remazol 6B 175%)

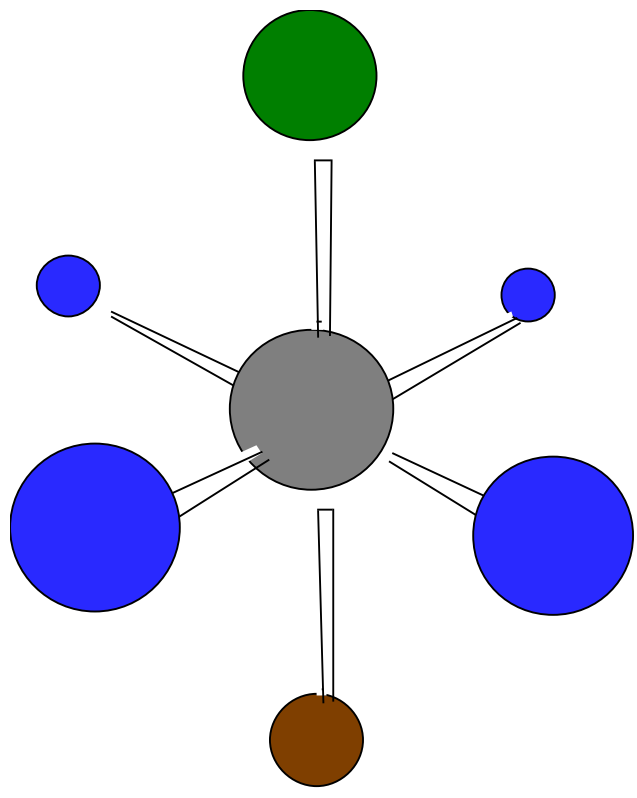
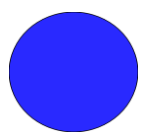

Fig. 5.3.2 Octahedral complex

where:



N



Ni



R (oxidized group)



R' (oxidized group)

5.4 Comparison between old and new tests

The proposed test, based on dyeing carried out with 2% o.w.f. of Reactive Blue 38 at 85°C for 90' and checked by reflectance spectrophotometer (Datacolor Check II), shows a good result in terms of intensity evaluation of UV treated wool.

The Kubelka Munch values are comparable with those obtained from dyeing carried out with 2% o.w.f. at 85°C for 90' of Reactive Blue 72 and the results on wool fabric UV-treated in discontinuous by Helios Italquartz apparatus, are reported in Table 5.4:

dyeing	wavelength	K/S
RG6B NT	670 nm	3.98
RG6B UV5	670 nm	9.13
Ratio UV5 / NT \approx 2.3		
NTSTGRr NT	670 nm	5.96
NTSTGRr UV5	670 nm	13.47
Ratio UV5 / NT \approx 2.3		

Table 5.4 Comparison between K/S of two dyeings (2% dye)

Another proposal for a test concerning both the intensity and the uniformity of the UV treatment is based on xanthoproteic reaction ^[7]. This reaction involves the nitric acid that is able to develop a considerable yellow coloration on contact with proteins. In particular, there are two responsible amino acids (namely Tyr and Trp) for this reaction in the keratin of wool. Tyr and Trp undergo, in the presence of HNO₃ on appropriate concentration, a reaction of nitration of their aromatic rings, forming nitro-derivatives intensely yellow colored in acidic media and orange colored in alkaline media.

Xanthoproteic reaction yields chromogens in function of accessibility of Trp and Tyr to the action of nitric acid on damaged fibers and this property can be used for assessing the degree of treatment severity: more intense yellow at higher damage of the wool cuticle.

The xanthoproteic test is carried out similarly to a dyeing, where the liquor consists of a solution of HNO₃ \approx 6.0 M at room temperature and with a liquor ratio equal to 50:1; the wool fabric (both untreated and UV treated) is dipped into this solution and occasionally stirred during a period of 1 h. The acid is then dropped out and the fabric is neutralized with a 1% NaHCO₃ solution; finally the fabric is dried in oven at maximum 60°C and checked by reflectance spectrophotometer (Datacolor Check II).

The Kubelka Munch values are listed below (Table 5.5):

dyeing	wavelength	K/S
XANTH NT	410 nm	25.21
XANTH UV5	410 nm	26.75
Ratio UV5 / NT \approx 1.1		
XANTH NT	490 nm	7.17
XANTH UV5	490 nm	15.99
Ratio UV5 / NT \approx 2.2		

Table 5.5 Comparison between K/S at 2 different wavelengths

Results related to untreated, statically and continuously treated samples, statistically evaluated by Minitab program, are reported in Tables 5.6 and 5.7:

measure	K/S	measure	K/S
RG6B TMT NT1	7.0537	RG6B TMT UV1	9.6404
RG6B TMT NT2	6.6623	RG6B TMT UV2	9.0864
RG6B TMT NT3	7.1130	RG6B TMT UV3	10.3919
RG6B TMT NT4	6.9266	RG6B TMT UV4	10.2594
RG6B TMT NT5	6.5955	RG6B TMT UV5	10.4157
RG6B TMT NT6	6.4857	RG6B TMT UV6	8.7694
RG6B TMT NT7	6.8326	RG6B TMT UV7	9.5653
RG6B TMT NT8	6.8661	RG6B TMT UV8	8.7984
RG6B TMT NT9	6.3955	RG6B TMT UV9	8.5156
RG6B TMT NT10	6.6836	RG6B TMT UV10	9.9959
RG6B TMT NT11	6.4655	RG6B TMT UV11	9.0189
RG6B TMT NT12	6.9992	RG6B TMT UV12	9.8868
RG6B TMT NT13	6.5162	RG6B TMT UV13	10.5439
RG6B TMT NT14	6.4789	RG6B TMT UV14	8.7926
RG6B TMT NT15	6.7847	RG6B TMT UV15	9.0189
RG6B TMT NT16	6.5747	RG6B TMT UV16	9.2432
RG6B TMT NT17	6.5747	RG6B TMT UV17	8.7405
RG6B TMT NT18	6.1903	RG6B TMT UV18	8.6719
RG6B TMT NT19	6.5920	RG6B TMT UV19	9.3919
RG6B TMT NT20	6.1934	RG6B TMT UV20	9.5789
RG6B TMT NT21	6.6481	RG6B TMT UV21	9.5789
RG6B TMT NT22	6.5026	RG6B TMT UV22	11.1049
RG6B TMT NT23	6.4868	RG6B TMT UV23	10.0699
RG6B TMT NT24	6.6481	RG6B TMT UV24	10.0328
RG6B TMT NT25	6.6060	RG6B TMT UV25	9.2368
RG6B TMT NT26	6.9684	RG6B TMT UV26	8.3220
RG6B TMT NT27	6.4621	RG6B TMT UV27	7.3760

Table 5.6 K/S at 670 nm of 27 sampling points on wool fabric (two sides - not treated and UV-treated) dyed with 2% Remazol Green 6B 175%

RG6B TMT NT	Mean	6.641
	SE Mean	0.0458
	St Dev	0.238
RG6B TMT UV	Mean	9.409
	SE Mean	0.156
	St Dev	0.812

which produce:

dyeing	wavelength	K/S
2% RG6B TMT NT	670 nm	6.64
2% RG6B TMT UV	670 nm	9.41
Ratio UV / NT \approx 1.4		

*Table 5.7 medium K/S on wool fabric
(two sides - not treated and UV-treated) dyed with 2% Remazol Green 6B 175%*

Obtained results showed good homogeneity of treatment as confirmed by St Dev less than one. The ratio UV / NT \approx 1.4 obtained in continuous assessment is lower than that obtained by irradiating wool fabric in static conditions (2.3); it is probably due to the fact that continuous treatment, carried out with a belt speed of 2.5 m / 'is slightly mild and does not allow to get the maximum UV treatment, for which the contrast in tone between one side and the other is not the maximum obtainable.

5.5 References

- [1] H. Heiz, *Textilveredlung*, **13** (1978) 205.
- [2] V.A. Bell, *Wool Dyeing*, SDC, Ed. D. M. Lewis, 10, Wool printing, 332.
- [3] K. R. Millington, *J.S.D.C.* **114** (1998) 286.
- [4] C. Furlani, *Coordin. Chem. Rev.*, **3**, 141 (1968).
- [5] J. E. Huheey, *Chimica Inorganica*, Piccin, Padova 1977, pp. 449-450.
- [6] C. L. Spiro, S. L. Lambert, T.J. Smith, E. N. Duesler, R.R. Gagné et D. N. Hendrickson, *Inorg. Chem.* **1981**, *20*, 1229-1237.
- [7] G. Migliavacca, F. Ferrero, C. Tonin, Xanthoproteic reaction for the evaluation of wool antifelting treatments, submitted to *Coloration Technology* on 2013.

Chapter 6

Characterization of wool fibres after UV
treatment

6.1 Introduction

To characterize in an exhaustive manner wool fibers subjected to the action of UV radiation, SEM and FTIR-ATR analysis were carried out.

From previous work [1] we know that as consequence of the surface modification, values of water contact angle decreased from 130° to 110° on treated fabrics with respect to untreated ones, denouncing an increased hydrophilicity regardless the radiation parameters.

Bursting test revealed a reinforcement of mechanical properties on treated fabrics, probably due to some crosslinking between the chains of wool fibers, not affecting the soft hand of the fabrics. Wool fibers were not weakened by UV radiations, confirming that the fibers modification is confined to the surface, not involving the bulk.

Also a pilling test was carried out finding, on treated sample, a grade 4 of pilling after 7000 abrasion cycles, a good result if compared with the grade 2/3 on the untreated sample. UV exposure makes wool surface fibers weaker, so no anchor fibers are available to secure pills to the fabric surface. Hence it was found that the UV treatment can also prevent pilling in knitwear, without severe loss in weight and strength of the fabric.

6.2 Scanning electron microscopy

Samples of untreated wool and UV-treated wool (Fig. 6.2) were submitted to SEM analysis;

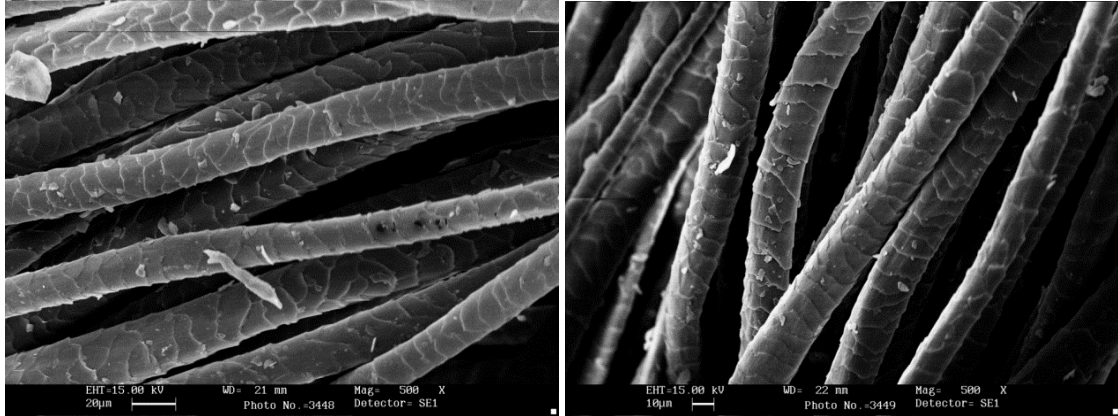

(a) untreated

(b) UV-treated 5' (30 mW/cm²)

Fig. 6.2 SEM micrographs (1000X)

SEM analysis showed no significant changes in the morphological structure of the wool after UV-treatment, confirming that the radiation does not degrade the fibers, but only the cuticular layer is interested, with hydrophilicity increased. This effect is due to oxidation caused by the presence of ozone generated by the UV radiations.

6.3 FTIR-ATR

From the obtained spectrum with FTIR-ATR analysis (Fig. 6.3.a)

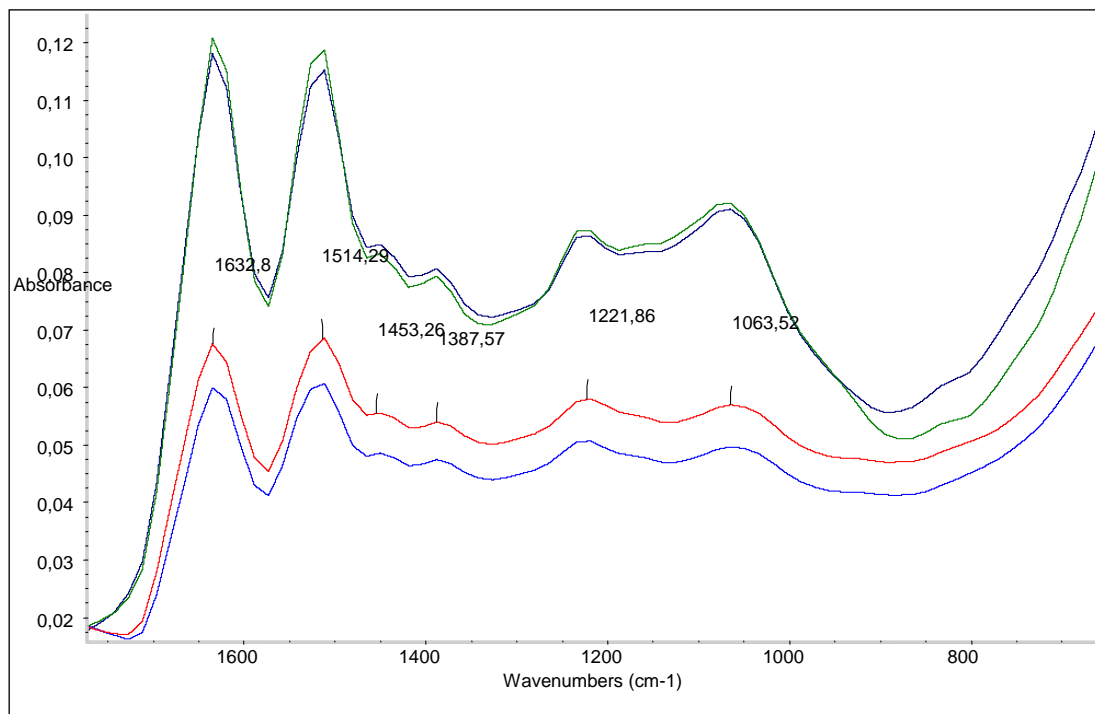

Fig. 6.3 a FTIR-ATR spectrum

(--- untreated --- 1' UV-treated --- 5' UV-treated --- 5' UV-Nearchimica)

<i>active vibration group</i>	<i>wavenumbers (cm⁻¹)</i>
primary amide	1627
secondary amide	1511
SO monoxide	1078
SO ₂ dioxide	1120
SO ₃ cysteic acid	1175, 1198, 1040

Table 6.3 b IR vibrations and related absorbing groups

it is possible see that samples more intensely UV irradiated shows a peak increase, with particular contribution due to oxidized sulfur compounds (Table 6.3 b), indicating oxidation of cystine.

6.4 References

- [1] M. Periolatto, G. Migliavacca, F. Ferrero,
XXIII IFATCC International Congress, 8-10 May 2013, Budapest "Wool fabric dyeing with
acid dye after UV irradiation",

Chapter 7

Wool and cotton dyeings

7.1 Introduction

Before considering guidelines for application of UV radiation on both wool and cotton, in pre-or post-treatment, it is good to spend a few words about dyeing in general and to review the main classes of suitable dyes. The proposed applications and their optimization follow.

7.2 Common dyeing operations

Dyeing is defined as the process of adding colour to textile products like staples, tops, hanks, yarns and fabrics. Dyeing is normally carried out in aqueous medium containing chemicals, auxiliary products and dyes. As consequence of this complex operation, dye molecules are differently bound to the fibres. Temperature, special products and time are key factors in dyeing processes.

Since the mid-18th century, synthetic dyes were produced to achieve a broader range of colours and to keep the dyeings more stable and fast toward washing and general use. Different classes of dyes are used for different types of fiber and at different stages of the textile production process, from loose fibers (staple) through yarn and cloth to completed garments.

The common operations of dyeing are in general:

1. preparation of the substrate, to obtain a material as homogenous as possible, particularly with regard to an increased hydrophilicity, such as to allow a regular distribution of both dyeing auxiliaries and dyes, achieving a leveled and uniform coloring;
2. real dyeing, performed with respect to the chemical-physical characteristics of the textile material, according the recommendations of the manufacturers of auxiliaries and dyes;
3. finishing of the dyed textile with the purpose to confer those features required by the end user (eg. softness, mothproofing, perfume, etc.).

Clearly, any textile fiber can be dyed in different presentations (staple, top, bobbin, hank, piece), and for each of these modes it is necessary to take into account chemical nature and needs of the textile packaging; the dyer then operate selections of auxiliaries and dyes in order to meet the demands of the customer, trying as much as possible, to proceed according to the path less "risky" and more cost effective.

7.3 Wool dyeing

Usually wool is dyed with acid dyes or metal-complex dyes; these two big classes of dyestuffs can be divided in other sub-classes, according to chemical differences and/or working conditions.

7.3.1 Acid dyes

The generic term acid dyes includes many chemical classes of dyestuffs, all applied in acidic or neutral media ($\text{pH} \leq 7.0$); under the generic acid range we can find several chemical structures, with a variety of chromophores ^[1]. They contain solubilising groups in the dye molecule, such as sulphonic or carboxylic, and are manufactured as the sodium salts of these acids in order to achieve acceptable solubility in water. Clearly, the number and the nature of these substituent groups impart the dyeing properties also and the HLB (hydrophilic lipophilic balance) is influenced by these groups.

The most popular chromophore in acid dyes is the azo group: normally we can meet one or two, rarely more than two in acid dyes. Structures of monoazo and disazo are reported in Fig. 7.3.1.a and Fig. 7.3.1.b

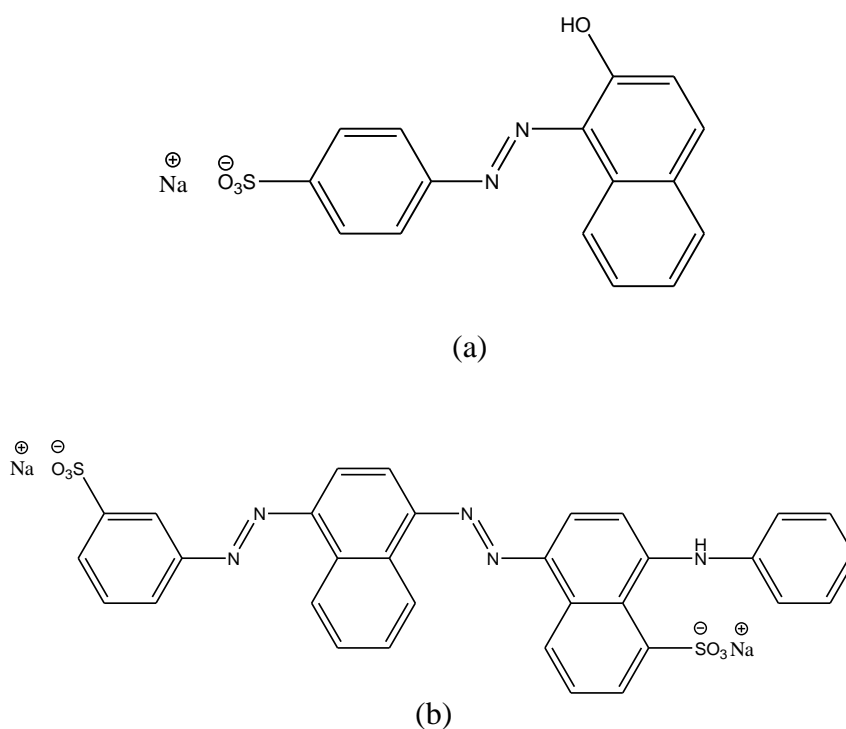

Fig. 7.3.1: (a) Acid Orange 7; (b) Acid Blue 113

Other chromophores are triphenylmethane, xanthenes, pyrazolone and anthraquinone structures. In use, acid dyes are classified by their dyeing behavior and wet fastness properties, rather than chemical composition; dyeing behavior is given by molecular weight and degree of sulphonation. Generally, acid dyes are classified into 3 groups:

1. level-dyeing acid dyes;
2. fast acid dyes;
3. milling dyes.

These groups are listed in order of increasing wet fastness and decreasing migration power: the dye-migration worse when the molecular weight grow, while wet fastnesses improve.

The degree of molecule sulphonation has the opposite effect, because many SO_3^- groups confer better dye solubility, but make the final dyeing less fastness towards wet treatments.

The level-dyeing acid dyes have molecular weight ranging between 300 – 600 dalton, migrate well and provide good coverage of dyeability differences within the fibre, but their wet fastnesses are poor.

Usually they are applied in acid media (pH ranging from 2.5 -3.5) with sodium sulphate (Na_2SO_4); this can be represented with amino groups of wool, that in acid media become:

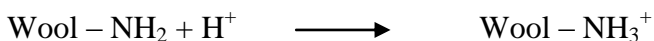

the dissolved dyes molecule in water are present as Dye^- and are attracted by cationic groups formed in wool fibre:

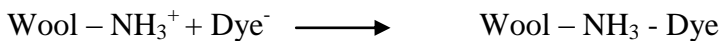

Sulphate ions (SO_4^{2-}) compete for cationic sites on the wool fibre and their presence assure migration and levelness.

Normally the dyeing is carried out at boiling point for a time variable between 30' and 60' depending on the desired colour intensity; this period is essential to allow the dye molecules to migrate into the wool fibre. Because of their excellent level-dyeing properties, these dyes are suitable for fabrics and carpets; their limited wet fastness suggests to use them for light and medium colour intensity.

The fast acid dyes have molecular weight ranging around 500 – 600 dalton, has medium power of migration and give superior wet fastness properties to level-dyeing acid dyes. They are usually applied always in acidic media (pH ranging from 3.5 – 5.5) with sodium sulphate (Na_2SO_4) and a leveling agent. The dyeing operation are carried out at boiling point for a time variable between 30' and 60' (always depending on the colour intensity). They show wet fastness intermediate between level-dyeing acid dyes and milling dyes and are mainly used for hand-knitting yarns.

The milling acid dyes have molecular weight ranging between 600 – 900 dalton, has minimum power of migration and give excellent wet fastness properties; their name remember that were used for the milling processes, requiring high level of wet fastness. Usually they are applied to wool with higher pH (ranging from 5.0 – 7.0), in presence of a suitable leveling agent and their great affinity towards wool fiber require that temperature and pH are appropriately controlled.

Milling dyes are used for those applications where good wet fastness properties are necessary: staple, top or yarn.

7.3.2 1:1 Metal complex dyes

1:1 metal-complex dyes are constituted by a monoazo dye with particular ligand groups in suitable positions and a metallic ion (such as Cr^{3+} , Co^{3+} , Cu^{2+}); the final complex (Fig. 7.3.2.a) is formed with a stoichiometric ratio of 1 azo molecule with 1 metallic ion^[2]. The water solubility is conferred by the presence of one or more sulphonic or amino-sulphone groups; the metal ion coordination is completed by water molecules or by F^- anions (only for modified 1:1 metal-complex dyes).

They are applied to wool fibre in strong acidic media, with pH approximately 2.0, supplied by H_2SO_4 .

Under these strong acidic conditions, the 1:1 metal-complex dyes show excellent migration power and good leveling character; they are normally applied to wool rising the boiling starting from 60°C and the boiling time is variable between 45' to 90' depending on the desired colour intensity.

Their very good migration is coupled by good wet fastness properties, but the colour space is limited (only dull shades).

Although studied by several workers, the precise nature of dye-fibre interaction remains a matter of debate; maximum exhaustion is obtained in the pH range 3.0 to 5.0 and the probable interactions are:

- electrostatic forces operating between the anionic dye and protonated amino groups in the fibre ($-\text{NH}_3^+$);
- coordination of the metallic ion (such as Cr^{3+}) with carboxyl or imino groups of wool;
- ion - dipole, dipole – dipole and related forces.

Dye exhaustion decreases with decreasing pH below 3.0 due to the protonation of the imino groups ($-\text{NH}-$) become protonated ($-\text{NH}_2^+$) and that cannot therefore coordinate the metallic ion; then at pH below 3.0, the final exhaustion is worse than at more higher pH, but the leveling property is enhanced.

However, working at pH values close to 2.0, far from the isoelectric point of wool (4.9), for long periods at boiling temperature, the wool fiber is damaged with loss of mechanical properties and softness; so, 1:1 metal-complex dyes were suitably modified by fluoride anions (F^-) in place of water molecules to complete the ion coordination (Fig. 7.3.2.b), allowing to work in a pH range from 3.5 to 4.0 with good leveling properties.

Then the metallic ion is more shielded and carboxyl or imino groups can coordinate it more slowly, giving leveled dyeing even at higher pH (3.5 – 4.0).

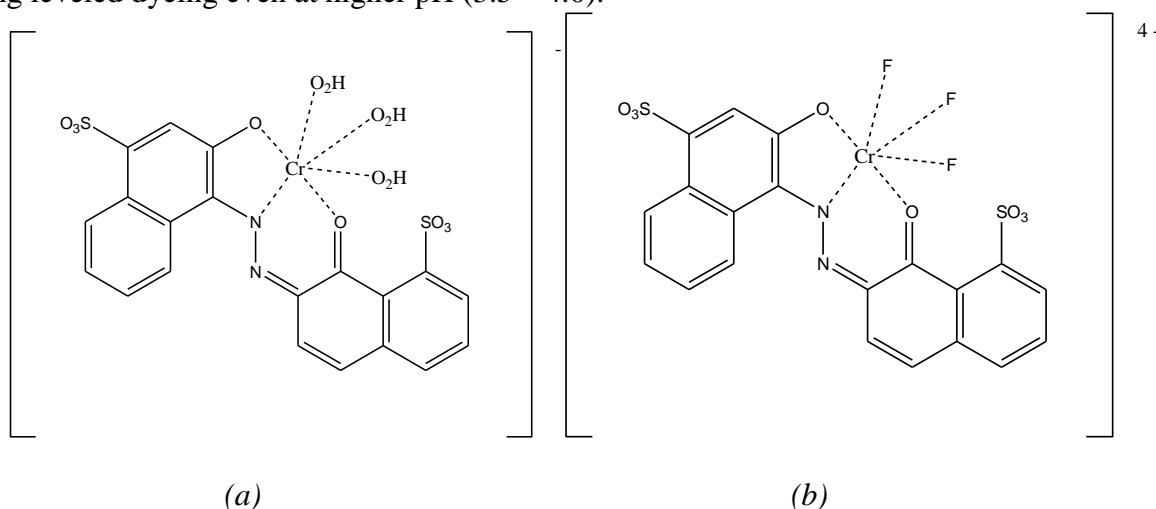

Fig. 7.3.2 (a) Acid Blue 158;

(b) (modified Acid Blue 158)

7.3.3 1:2 Metal complex dyes

1:2 metal-complex dyes are constituted by two monoazo dyes, not necessarily equals, with particular ligand groups in suitable positions and a metallic ion such as Cr^{3+} , Co^{3+} , Cu^{2+} . The final complex (Fig. 7.3.3) is formed with a stoichiometric ratio of 2 azo molecules with 1 metallic ion ^[2]. The water solubility is conferred by the presence of one or more sulphonic, methyl-sulphone or sulphonamide groups; the metal ion coordination is then completed with 2 azo molecules.

These dyes are applied to wool fibre in weakly acidic or neutral conditions, depending on colour intensity and show good migration power and good leveling character; they are normally applied to wool starting at 20°C and the boiling time is variable between 45' to 90' (depending on the colour intensity).

Their good migration is accompanied by excellent wet fastness properties, and the colour space is large enough even if the shades are not brilliant as acid dyes).

In contrast to 1:1 metal-complex, 1:2 metal-complex have the metallic ion fully coordinated and wool ligands, such as amino or carboxylic groups, cannot form bonds; they have an overall negative charge due to anionic solubilising groups and their behavior is similar to that of acid dyes with the formation of ionic bonds between dye and wool fibre.

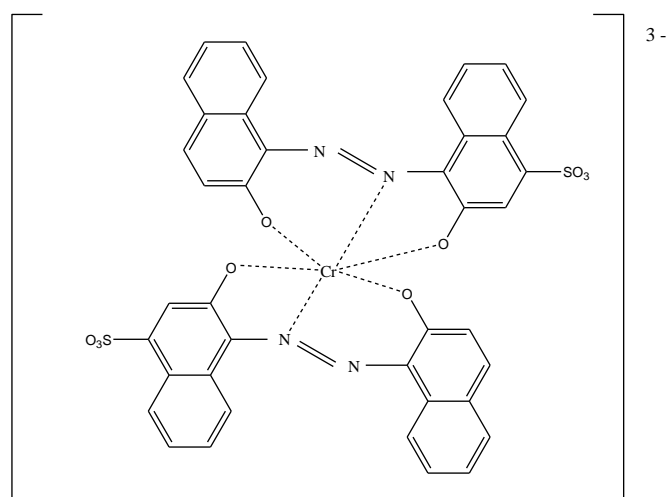

Fig. 7.3.3 (Acid Blue 193)

7.3.4 Reactive dyes

Reactive dyes are unique among other dyes in that they are covalently bonded to the substrate that is dye and fibre forming a bond of shared electrons. They are composed by a colored segment (chromophore) and a reactive segment (alpha-bromoacrylamido, beta-sulphato ethylsulphone, etc.)^[3].

In general, amino, thiol and hydroxyl groups of wool can react with the reactive segment by nucleophilic substitution or by Michael addition reaction (Fig. 7.3.4.a).

Cyclic structure (aziridine ring) is capable of further reaction with nucleophilic amino groups (Fig. 7.3.4.b).

It is possible to say that alpha-bromoacrylamido dyes (Fig. 7.3.4.c) are essentially bifunctional reactive dyes and this reaction does not suffer of sterical hindrance.

In 1st step reactive dyes, with a suitable leveling agent and under slightly acidic conditions (pH=5.5 – 6.0 for pale shades and pH=5.0 – 5.5 for dull shades), act as acid dyes forming ionic bonds with wool; then during boiling period the reaction takes place and covalent bonds are formed. Usually dyeing are carried out at boil for 30' – 90' depending of the final colour intensity; the 2nd step is the unfixed/hydrolyzed dye removal, typically carried out with NH₄OH at 80°C for 15' to improve the wet fastnesses.

Light fastnesses quite good and depending by the chemical nature of chromophore can be obtained.

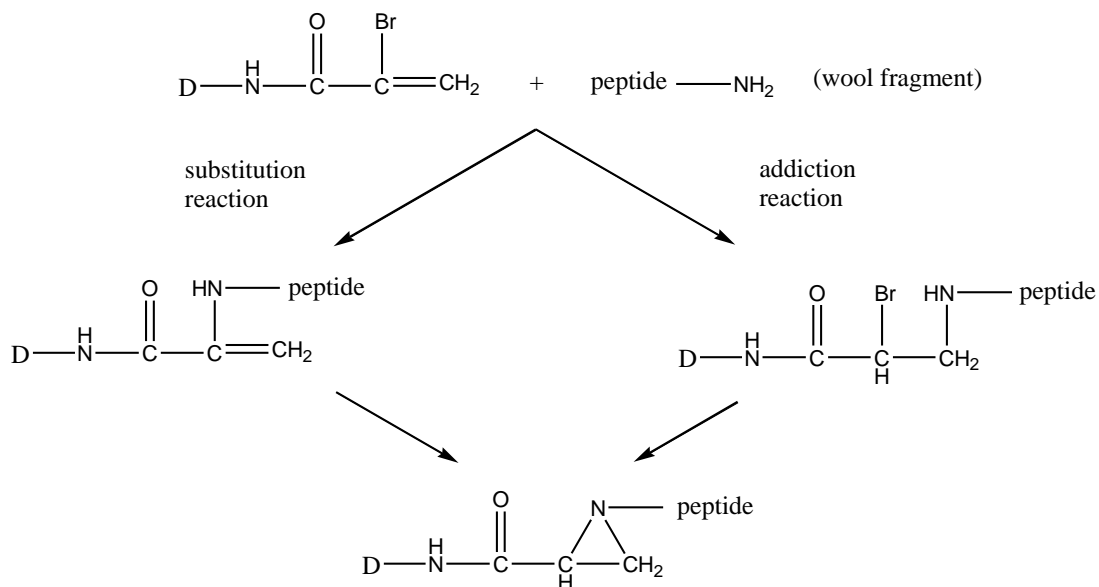

Fig. 7.3.4.a

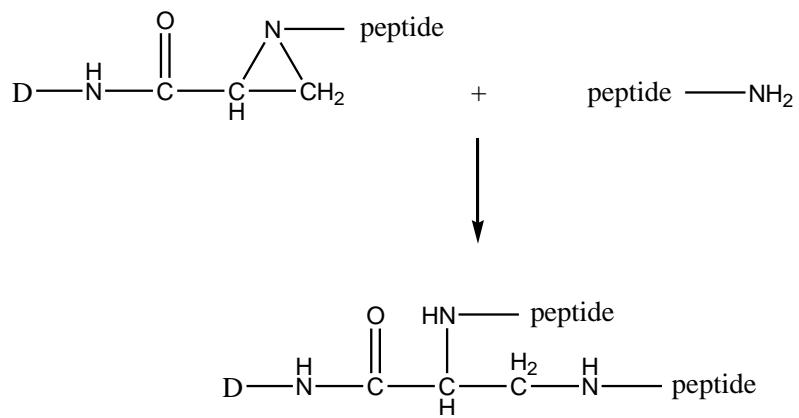

Fig. 7.3.4.b

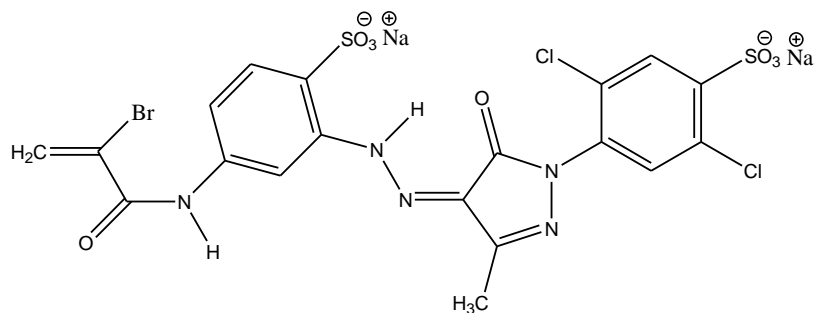

Fig. 7.3.4.c (Reactive Yellow 39)

7.4 Cotton dyeing

Usually cotton is dyed with direct dyes and reactive dyes; these two big classes of dyestuffs can be divided in other sub-classes, according to chemical differences and/or working conditions ^[4].

7.4.1 Direct dyes

Direct dyes are azo dyes, normally disazo (Fig. 7.4.1) or trisazo, rarely tetrazo structures, with an high molecular weight soluble thanks to the presence of sulphonic groups.

With this kind of dyestuffs cotton can form hydrogen bond, Van der Waals forces and other dipole – dipole forces, but there is not a real bond. For this reason, their wet fastnesses are poor, especially for dark shades. Direct dyes can show good, medium or poor levelness properties:

1. dyes with good levelness properties;
2. dyes with medium levelness properties;
3. dyes with poor levelness properties.

In the first case, particular attention during the dyeing operations are not required (temperature control and salt addition) and the maximum exhaustion is reached at temperature between 60°C and 80°C.

The second type requires a dyeing control with salt addition and the temperature of maximum exhaustion is between 80°C and 100°C; the third type needs dyeing control through temperature and salt addition in small increments and the temperature of maximum exhaustion is higher than 100°C.

Direct dyes show light fastness ranging from medium to very good, according to their chemical structure.

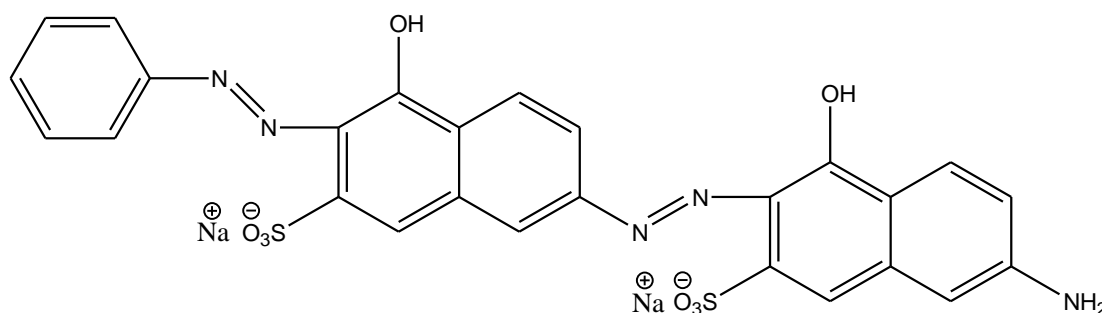

Fig. 7.4.1 (Direct Red 16)

7.4.2 Reactive dyes

Reactive dyes are made from various chromophores (azo, anthraquinone, pyrazolone, etc.) with different reactive groups, such as chlorotriazine, vinylsulphone (Fig. 7.4.2), chloropyrimidine and fluoropyrimidine, etc.; there are three main subdivisions depending on temperature of application:

- reactive dyes applied at cold (60°C, with vinylsulphone as reactive group);
- reactive dyes applied at hot (80°C, with chlorotriazine as reactive group);
- reactive dyes applied at hot (90°C, with 3-carboxy pyridinio-s-triazine as reactive group).

In the 1st step, the water dissolved dye that can migrate towards the cellulose like a direct dye due to the presence of solubilising groups that form hydrogen bonds with the cellulose; the salt addition promotes this migration and the dye can diffuse uniformly inside the fibre. During the 2nd step, the addition of alkali (NaHCO₃, or Na₂CO₃) produces the ionization of some -OH of cellulose at -O⁻; these anionic groups attack the reactive group in the dye molecule giving covalent bonds. The 3rd and last step is the removal of unfixed and /or hydrolyzed dye, by proper auxiliary agent (normally a polyacrylate) followed by rinsing.

These reactive groups are able to create a covalent bond between the dye and the cellulose of cotton; the result is a dyeing with excellent wet fastness, while the light fastness depends by chemical structure of dye.

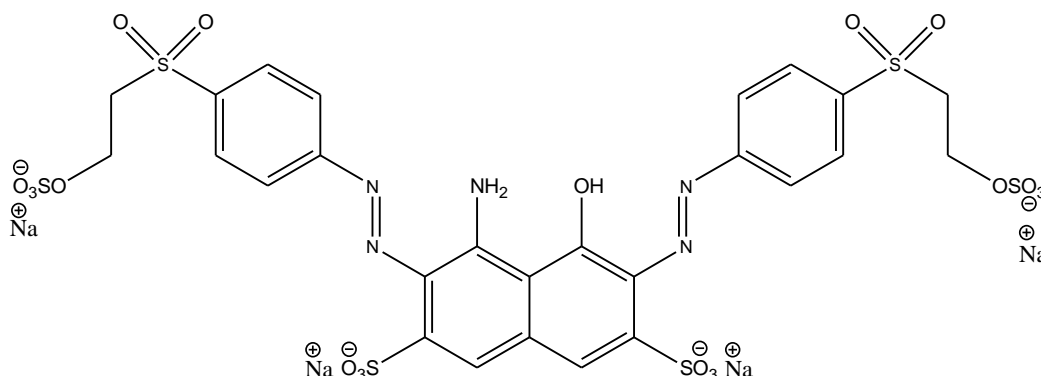

Fig. 7.4.2 (Reactive Black 5)

7.5 Proposed procedures

In the case of wool fiber, several experimental tests carried out on UV treated fabrics, with different dyes showed the best results with 1:1 metal-complex dyes. In fact, 1:1 metal-complex dyes provided differences of more than 5 score points, in terms of delta E color differences between UV-treated and untreated fibers, with a contrast clearly visible. Worst effect were obtained both with reactive dyes and 1:2 metal-complex dyes.

Therefore we proceeded to a selection of the above dyes, rejecting those elements not ensuring adequate colour difference. We also carried out a comparison between classical 1:1 metal-complex dyes and modified 1:1 metal-complex dyes, showing that the latter exert a lower action than the previous.

In the case of cotton fiber, the most advantageous technique appears to dye the cellulosic substrate with direct or reactive dyes with limited light fastness, subsequently exposed to UV radiation. Indeed, the UV-treated cellulose does not produce exploitable effects to obtain acceptable differential dyeings; then dyeing before and fading after, due to the action of chromogens degradation by UV radiation, acceptable effects of colour differences were achieved. These differences increase in value through yellow shades, to orange shades, to red shades, and have their delta E maximum in blue shades, navy shades and black shades.

7.6 References

[1] P. A. Duffield, Wool Dyeing, SDC, Ed. D. M. Lewis, 6, Dyeing wool with acid and chrome dyes, 176.

[2] S. M. Burkinshaw, Wool Dyeing, SDC, Ed. D. M. Lewis, 7, Dyeing wool with metal-complex dyes, 196.

[3] D.M. Lewis, Wool Dyeing, SDC, Ed. D. M. Lewis, 8, Dyeing wool with reactive dyes, 222.

[4] J. Cegarra, P. Puente et J. Valdeperas, The dyeing of textile materials, the scientific bases and the techniques of application, 1992, Texilia, Biella.

Chapter 8

UV treatment of wool for differential dyeing with commercial dyestuffs

8.1 Wool pretreatment by UV radiations

The main topic of my doctoral research work was the study about a treatment of wool yarns or fabrics (previously washed) by UV radiation to confer peculiar dyeing effects.

Pure wool knitted fabrics with a density of about 160 g/ m^2 or pure wool yarns with $N_m = 2/28$ were used as textile substrates. Both were previously washed at $60 \text{ }^\circ\text{C}$ for 30' with ECE detergent 1 g/L solution, rinsed and dried in oven at 100°C .

The UV radiation has a well-defined irradiance E_e :

$$E_e = d\Phi_e / dA$$

where: Φ_e is the radiant flux that impact on the surface [W]
A is the surface [m^2]

This radiometric parameter is defined as the radiant flux per unit area and can be measured in W/m^2 or mW/cm^2 .

More precisely, in the present study it was considered another parameter, the radiant exposure H_e , related to the accumulated amount of incident "light" energy per area, expressed in [J/m^2], or [J/cm^2] (in our case):

$$H_e = E_e * t$$

where: E_e is the irradiance [W/m^2]
t is the time of exposure [s]

8.1.1 Static assessment

For static irradiation test, samples were UV irradiated by a medium pressure Hg vapor lamp c/o Politecnico di Torino (Helios Italquartz). The radiant exposure relative to the UVA component resulted of $\approx 37 \text{ mW/cm}^2$ provided positioning the samples at a distance of $\approx 15 \text{ cm}$ from the lamp. Wool samples were half-exposed to UV light, covering the unexposed part with a paper sheet, on both sides for different times; namely, samples I, II, III, IV, V were exposed for 1, 2, 3, 4 or 5 minutes respectively. In this way, the effect of UV radiation can be easily evaluated after the dyeing, simply comparing the 2 halves of the sample.

On the other hand, the immediate effect of radiation on wool fabrics was evaluated from spectrophotometer readings, by Datacolor, of the various samples referred to the untreated ones.

From obtained results, reported in Table 8.1.1, a difference of color with respect to the untreated sample was revealed; it was mainly due to a Δb increase, related to a certain yellowing of the sample.

sample	ΔL	Δa	Δb	ΔE
I	-1.56	-0.31	0.47	2.29
II	-1.70	-0.73	1.35	2.29
III	-1.85	-0.67	2.29	3.02
IV	-2.00	-1.01	3.39	4.06
V	-2.44	-0.98	4.36	5.09

Table 8.1.1 CIE L a b parameters for static assessment on wool fabric

8.1.2 Continuous assessment

Static treatments are effective and useful for a preliminary study, also involving kinetic behaviour, but they are not fully comparable to the treatments in continuous, in which some parameters, such as the temperature of the irradiated material, or the lamp power and, as consequence, the irradiance, differ significantly from the static system (after static treatments the humidity of wool fabric fall as consequence of increased temperature). Tests, carried out with dynamics equipment c/o Nearchimica (Legnano), included an irradiance of the order of 900 mW/cm² for UVA component, while c/o the establishment of Filidea (Biella) the lamps provided an irradiance of about 430 mW/cm².

In order to compare the effects on wool fibre, the radiant exposure (J/cm²) was considered (Table 8.1.2). Static expositions for 5 minutes correspond to ≈ 11 J/cm²; the preliminary dynamic exposure (Nearchimica) performed with 6 steps for a total exposure time of 43 ", provided ≈ 39 J/cm² and this was the upper limit of UV irradiation before having unacceptable yellowing ($\Delta b = 7.64$) compared to the same untreated wool.

exposition time	radiant exposure
20''	$\approx 8.6 \text{ J/cm}^2$
40''	$\approx 17.2 \text{ J/cm}^2$
60''	$\approx 34.4 \text{ J/cm}^2$
80''	$\approx 68.8 \text{ J/cm}^2$

Table 8.1.2 Radiant exposure at different times with UVA irradiance of 430 mW/cm²

Only for 60'' and 80'' are then obtained good dyeing results, together with a not excessive yellowing ($\Delta E \leq 2$), for which both for wool yarn and wool fabric against standard references have been associated with treatments 60'' (mild) and 80'' (energetic).

8.2 Differential dyeing of wool

8.2.1 1:2 Metal-complex dyes

Samples of wool fabric, treated in a static way, were first dyed with 1:2 metal-complex dyes by Minox equipment, inspired also by previous works carried out by Nearchimica to obtain dyed fabrics with a vintage “Sunwash” effect.

Both a selection of 1:2 metal complex dyes and Nearsun B dyes, recommended by same NearChimica, were used, and relative colour indexes are reported in Table 8.2.1.a, while details of the dyeing recipe are scheduled in Table 8.2.1.b.

To avoid the levelling due to the high dyeing temperature, limiting the contrast between UV treated and untreated samples, dyeings were carried out at temperatures below the boil, and precisely at 80, 85 and 90°C.

At 90°C good final shade uniformity was obtained, but the contrast effect was decreased due to the easy migration of dyes; at 80 °C, the contrast is good, but the shade uniformity of dyeing was not reached; the acceptable compromise was a dyeing temperature of 85 °C, so both the shade uniformity and the degree of contrast are good.

dye in examination	Colour Index	reference dye
Nearsun Yellow B-4R	A.Y. 194	Acidol Yellow M-3RL
Nearsun Bordeaux B-P	A.V. 90	Acidol Bordeaux M-B
Nearsun Blue B-PR a.c.	A.Bl. 193	Acidol dark Blue M-TR
Nearsun Green B-G	A.Gr. 73 + ?	Lanacron Olive G + ?
Nearsun Grey B-B	A.Bk. 60	Irgalan Grey BRL
Nearsun Brown B-R	A.Br. 282 + A.Bk. 107 + A.Bk. 194	Lanacron dark Brown S-GR + Dyelan Black S-2B + Acidol Black M-SRL
Nearsun Black B-R	A.Y. 116 + A.Bk. 107	Irgalan Yellow GRL + Dyelan Black S-2B

Table 8.2.1.a

Colour Index and references of dyes in examination

customer	Filidea			data	
colour	Nearsun Yellow B-4R	goods		WO fabric (N.T. + UV5)	
apparatus	Minox				
	textile weight		10 g		
	liquor ratio	1	20		
	bath volume		200 mL		
	<i>Auxiliaries</i>	<i>Conc.</i>	<i>Unit</i>	<i>Quantity</i>	<i>Unit</i>
	Na ₂ SO ₄	10	%	1	g
	CH ₃ COOH 60%	1	g/L	0.2	g
	CH ₃ COONa*3H ₂ O	12	g/L	2.4	g
	Avolan IW	1	%	0.1	g
	Avolan S	0.35	%	0.035	g
	<i>Dyes</i>	<i>Conc.</i>	<i>Unit</i>	<i>Quantity</i>	<i>Unit</i>
	Nearsun Yellow B-4R	1	%	0.1	g
	<u>go to 60°C with 0.6 °C/‘</u>				
	<u>maintain at 60°C for 10’</u>				
	<u>go to 85°C with 0.7 °C/‘</u>				
	<u>maintain at 85°C for 60’</u>				
	final pH = 5.9				

Table 8.2.1.b Dyeing recipe for 1:2 Metal-complex dyes

sample	ΔL	Δa	Δb	ΔE
Nearsun Yellow B-4R	-3.09	0.44	-1.24	3.36
Nearsun Bordeaux B-P	-2.10	1.22	1.56	2.89
Nearsun Blue B-PR a.c.	-2.52	0.19	0.05	2.53
Nearsun Green B-G	-1.03	-0.06	-0.31	1.07
Nearsun Brown B-R	-0.49	-0.18	-0.12	0.54
Nearsun Black B-R	-0.61	-0.14	0.16	0.64

Table 8.2.1.c CIE L a b parameters for 1% dyeings with Nearsun B selection

sample	ΔL	Δa	Δb	ΔE
Dyelan Yellow S-GN	0.30	-0.49	-1.12	1.26
Lanacron Yellow S-2G	-1.19	0.65	0.27	1.38
Dyelan Orange D-RL 200%	0.20	-0.67	-0.77	1.04
Lanacron Red S-G	-0.84	-0.40	0.13	0.94
Dyelan Brown S-PRL 150%	-1.69	-0.27	-0.54	1.80
Lanacron Grey S-B	-0.97	0.04	0.16	0.98
Dyelan Navy S-B 150%	-2.46	0.12	1.64	2.96

Table 7.2.1.d CIE L a b parameters for 1% dyeings with 1:2 Metal-complex dyes

Unfortunately the results are not encouraging because color differences have no significant weight. (Tables 8.2.1.c and Table 8.2.1.d). Color differences in terms of delta E between untreated and UV-treated, are in fact always moderate. This behavior is due to the fact that these 1:2 Metal-complex dyes have the metal ion completely coordinated, so they can not form new bonds with UV-treated wool; differences in delta E are therefore attributable only to an easier penetration through the cuticle modified by UV radiation.

8.2.2 Reactive dyes

Nearchimica also recommend the use of dyes of Nearsun B series, belonging to the class of reactive dyes. (Table 8.2.2.a)

dye in examination	Colour Index	reference dye
Nearsun Yellow B-5G	R.Y. 39	Lanasol Yellow 4G
Nearsun Red B-2B	R.R. 65	Lanasol Red B
Nearsun Blue B-2R	R.Bl. 50	Lanasol Blue 3R

Table 8.2.2.a Colour Index and references of dyes in examination

Thus there are tested a selection of reactive dyes (alpha-bromoacrylamido), in according to the recipe below (Table 8.2.2.b):

customer	Filidea			data	
colour	Lanasol Yellow 4G	goods		WO fabric (N.T. + UV5)	
apparatus	Minox				
	textile weight		10 g		
	liquor ratio	1	20		
	bath volume		200 mL		
	<i>Auxiliaries</i>	<i>Conc.</i>	<i>Unit</i>	<i>Quantity</i>	<i>Unit</i>
	Na ₂ SO ₄	10	%	1	g
	CH ₃ COOH 60%	2	g/L	0.4	g
	CH ₃ COONa*3H ₂ O	14	g/L	2.8	g
	<i>Dyes</i>	<i>Conc.</i>	<i>Unit</i>	<i>Quantity</i>	<i>Unit</i>
	Lanasol Yellow 4G	1	%	0.1	g
	<u>go to 85°C with 0.7 °C/‘</u>				
	<u>maintain at 85°C for 90’</u>				
	final pH = 5.7				

Table 8.2.2.b Dyeing recipe for Reactive dyes

sample	ΔL	Δa	Δb	ΔE
Lanasol Yellow 4G	-1.64	2.47	13.43	13.8
Lanasol Red 6G	-4.67	4.49	6.40	9.1
Lanasol Blue 3G	-12.48	2.53	-2.22	12.9

Table 8.2.2.c CIE L a b parameters for 1% dyeings with Lanasol selection

From obtained results Table 8.2.2.c color differences, in terms of delta E between untreated and UV-treated, are all satisfactory but it's very difficult to obtain an acceptable levelness with these reactive dyes. It is due to a formation of strong bonds between wool fibre and reactive dye (covalent bonds), that severely limit the migration of dyes.

8.2.3 Acid dyes

As advised by Nearchimica, the use of acid dyes does not allow to distinguish sharply between UV-treated and untreated wool; indeed, these dyes are useful to "cover" differently UV-treated wools and thus these allow to obtain special colour effects in combination with other kind of dyes selective between UV-treated and untreated substrates.

Some test were carried out with a selection of acid dyes, both by Nearchimica (Table 8.2.3.b) and others suppliers, according the dyeing receipt reported in Table 8.2.3.a:

customer	Filidea			data	
colour	Nylosan Red E-BL 180%	goods	WO fabric (N.T. + UV5)		
apparatus	Minox				
	textile weight		10 g		
	liquor ratio	1	20		
	bath volume		200 mL		
	<i>Auxiliaries</i>	<i>Conc.</i>	<i>Unit</i>	<i>Quantity</i>	<i>Unit</i>
	H ₂ SO ₄ 96%	3.5	%	0.35	g
	<i>Dyes</i>	<i>Conc.</i>	<i>Unit</i>	<i>Quantity</i>	<i>Unit</i>
	Nylosan Red E-BL 180%	1	%	0.1	g
	<u>go to 60°C with 0.6 °C/‘</u>				
	<u>maintain at 60°C for 10’</u>				
	<u>go to 85°C with 0.7 °C/‘</u>				
	<u>maintain at 85°C for 60’</u>				
	final pH = 2.3				

Table 8.2.3.a Dyeing recipe for Acid dyes

sample	ΔL	Δa	Δb	ΔE
Nearsun Yellow L-3G	0.11	0.61	2.58	2.65
Nearsun Yellow L-G	-0.22	0.30	-0.38	0.53
Nearsun Red L-2G	-1.62	-0.77	3.41	3.86
Nearsun Red L-G	-1.22	0.46	1.65	2.11
Nearsun Blue L-R	-6.69	4.16	1.93	8.11
Nearsun Blue L-3R	-0.67	-1.39	1.53	2.17

Table 8.2.3.b CIE L a b parameters for 1% dyeings with Nearsun L selection

We have studied other dyes (always belonging to acid dye class) and we propose an alternative selection; the results are listed:

sample	ΔL	Δa	Δb	ΔE
A.Y. 17	-0.98	2.03	0.69	2.35
A.Y. 49	-0.76	1.42	1.22	2.02
A.O. 7	-2.35	0.16	-1.89	3.02
A.R. 57	-2.10	-0.74	1.87	2.91
A.R. 337	-1.81	-0.41	0.78	2.01
A.R. 361	-1.18	0.32	1.76	2.14
A.R. 52	-1.82	-1.83	0.21	2.59
A.Bl. 7	-3.07	0.36	0.32	3.11
A.Bl. 277	-2.42	0.02	1.78	3.01
A.Bl. 25	-0.68	-0.11	0.55	0.88
A.Gr. 16	-2.93	0.33	0.90	3.08

Table 8.2.3.c CIE L a b parameters for 1% dyeings with Acid dyes

Among investigated dyes, only Nearsun Blue L-R shows a total colour difference ΔE greater than 5 points. Other dyes (Table 8.2.3.c), always based on acid dyes (belonging to 1st group - level-dyeing acid dyes), enable to get total colour differences not exceeding 3 point of ΔE ; this outcome becomes important when a double face effect is wanted. The difference can be ascribable to their relatively small molecules, and therefore capable of producing dyeings always well leveled even in presence of modified cuticle (with UV radiation in our case).

8.2.4 1:1 Metal-complex dyes

We proceed as in subsequent tests by changing the composition of the dyes, and thus comes to the study of the effects obtained with both modified and classical 1:1 metal-complex dyes (Neolan P series, supplied by Huntsman, and Kemalene or Neolan, supplied by Kem. Color or Huntsman), according a typical recipe (Tables 8.2.4.a. and 8.2.4.d):

customer	Filidea			data	
colour	Neolan Yellow P	goods		WO fabric (N.T. + UV5)	
apparatus	Minox				
	textile weight		10 g		
	liquor ratio	1	20		
	bath volume		200 mL		
	<i>Auxiliaries</i>	<i>Conc.</i>	<i>Unit</i>	<i>Quantity</i>	<i>Unit</i>
	HCOOH 85%	2.5	%	0.25	g
	Albegal Plus	3	%	0.3	g
	<i>Dyes</i>	<i>Conc.</i>	<i>Unit</i>	<i>Quantity</i>	<i>Unit</i>
	Neolan Yellow P	1	%	0.1	g
	<u>go to 85°C with 0.7 °C/‘</u>				
	<u>maintain at 85°C for 90’</u>				
	final pH = 3.5				

Table 8.2.4.a Dyeing recipe for modified 1:1 Metal-complex dyes

sample	ΔL	Δa	Δb	ΔE
1% Yellow P	-1.99	1.83	4.25	5.04
1% Red P	-1.81	1.85	2.51	3.61
1% Bordeaux P	-2.10	2.21	1.42	3.37
1% Blue P	-3.54	-0.24	-0.95	3.67
1% Blue PA	-5.25	-0.42	-0.97	5.35
4% Navy P	-2.92	-0.29	2.12	3.62
4% Navy PA	-3.39	-0.13	4.99	6.04
5% Black P	-3.60	0.38	1.63	3.97

Table 8.2.4.b CIE L a b parameters for dyeings with modified 1:1 Metal-complex dyes

NOT EXPOSED SIDE

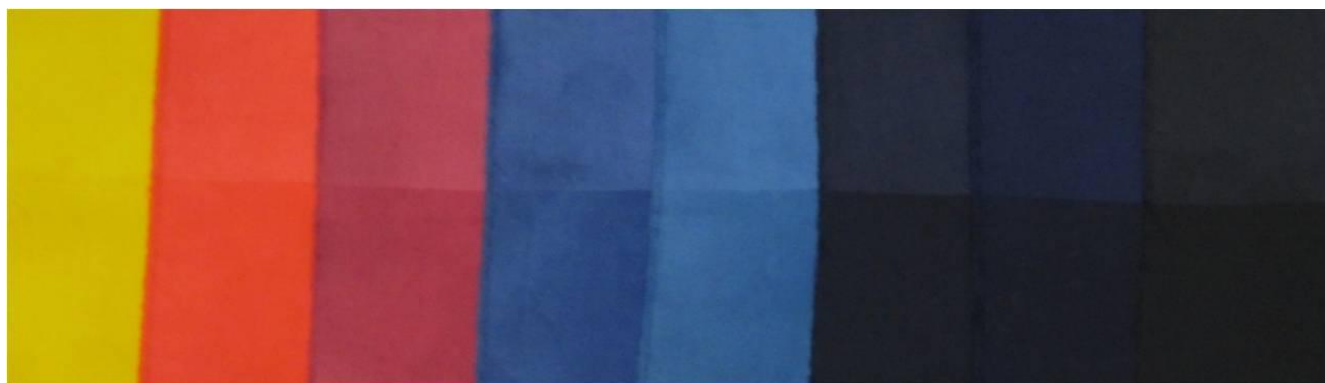

EXPOSED SIDE

Neolan Yellow P

Neolan Red P

Neolan Bordeaux P

Neolan Blue P

Neolan Blue PA

Neolan Navy P

Neolan Navy PA

Neolan Black P

Fig. 8.2.4.c Wool fabrics dyed with 1:1 modified Metal-complex dyes at 85 °C x 90'

So are used the classical 1:1 metal-complex dyes (provided by Huntsman and Kem. Color), according to the recipe type (Table 7.2.4.d):

customer	Filidea			data	
colour	Kemalene Yellow GR 150%	goods	WO fabric (N.T. + UV5)		
apparatus	Minox				
	textile weight		10 g		
	liquor ratio	1	20		
	bath volume		200 mL		
	<i>Auxiliaries</i>	<i>Conc.</i>	<i>Unit</i>	<i>Quantity</i>	<i>Unit</i>
	H ₂ SO ₄ 96%%	3.5	%	0.35	g
	<i>Dyes</i>	<i>Conc.</i>	<i>Unit</i>	<i>Quantity</i>	<i>Unit</i>
	Kemalene Yellow GR 150%	1	%	0.1	g
	<u>go to 85°C with 0.7 °C/‘</u>				
	<u>maintain at 85°C for 90’</u>				
	final pH = 2.6				

Table 8.2.4.d Dyeing recipe for classical 1:1 Metal-complex dyes

sample	ΔL	Δa	Δb	ΔE
A.Y. 104	-4.55	3.76	8.02	9.96
A.Y. 99	-4.07	2.75	5.38	7.29
A.O. 74	-2.18	1.86	4.22	5.10
A.R. 183	-4.29	2.86	5.38	7.45
A.R. 186	-5.12	4.74	2.67	7.47
A.R. 195	-5.09	3.50	2.84	6.80
A.R. 194	-6.15	1.08	3.14	6.99
A.V. 115	-5.99	2.50	0.89	6.56
A.Bl. 158	-7.14	0.24	-0.69	7.18
Navy 2RLB	-7.56	1.06	-1.57	7.79
A.Bk. 52	-9.72	-2.70	-0.21	9.72

Table 8.2.4.e CIE L a b parameters for 1% dyeings with classical 1:1 Metal-complex dyes

NOT EXPOSED SIDE

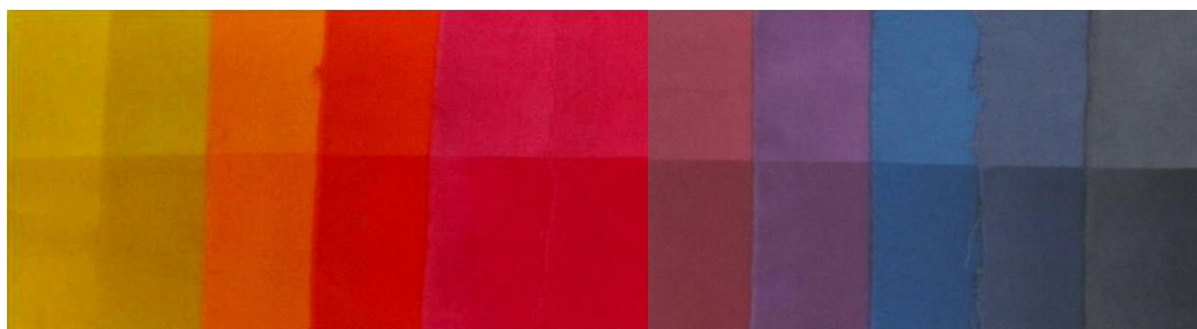

EXPOSED SIDE

(A.Y. 104) Yellow Neolan RE 250%
(A.Y. 99) Yellow Kemalene GR 150%
(A.O. 74) Orange Kemalene G
(A.R. 183) Red Kemalene GRE 150%
(A.R. 186) Pink Kemalene BE 200%
(A.R. 195) Pink Neolan BE 200%

(A.R. 194) Bordeaux Neolan RM 200%
(A.V. 115) Violet Kemalene 5RL 150%
(A.Bl. 158) Blue Kemalene 2G 250%
(mix) Navy Neolan 2RLB 150%
(A.Bk. 52) Black Kemalene BW 364%

Fig. 8.2.4.f Wool fabrics dyed with 1:1 classical Metal-complex dyes at 85 °C x 90'

Obtained results show that even with modified 1:1 Metal-complex dyes (Neolan P) the differences are not so noticeable (Fig. 8.2.4.c) as confirmed by Datacolor evaluations (Table 8.2.4 b), while with the classical dyes selection (Neolan or Kemalene) the results are more evident ($\Delta E \geq 5$) and color differences are well visible (Fig. 8.2.4.f) and (Table 8.2.4.e). The different behavior was due to the fact that both selections of dyes 1:1 Metal-complex dyes have the metal ion not fully coordinated; then they can form coordinative bonds between their ions with the oxidized groups generated by UV treatment. The modified 1:1 Metal-complex dyes (Neolan P) are relatively less suitable to form coordinative bonds than classical 1:1 Metal-complex dyes (Neolan/Kemalene) because in their formulation contain already ions F^- ; these fluoride ions are competing with oxidized groups on wool and therefore the color effect is less highlighted.

8.2.5 Kinetic behaviour

For Acid dyes (in particular for A.Bl. 185) were conducted kinetic studies on wool UV-treated 5' with reference to three absorption isotherms (70, 80 and 90 °C), (Table 8.2.5.a) according to the following recipe:

customer	Filidea			data	
colour	KIA	goods		WO fabric	
apparatus	Minox				
	textile weight		10 g		
	liquor ratio	1	30		
	bath volume		300 mL		
	<i>Auxiliaries</i>	<i>Conc.</i>	<i>Unit</i>	<i>Quantity</i>	<i>Unit</i>
	CH ₃ COOH 60%	5	g/L	1.5	g
	CH ₃ COONa*3H ₂ O	1.21	g/L	0.36	g
	<i>Dyes</i>	<i>Conc.</i>	<i>Unit</i>	<i>Quantity</i>	<i>Unit</i>
	Telon Turquoise M-5G 85%	1	%	0.1	g
	<u>maintain at 70 or 80 or 90 °C for 60 - 90'</u>				
	final pH = 4.0				

Table 8.2.5.a Dyeing recipe for kinetic study with Acid dyes

The final bath exhaustions, detected with transmittance spectrophotometry, gave the following results (Table 8.2.5.b):

time	temperature					
	70 °C		80 °C		90 °C	
	UV-treated	untreated	UV-treated	untreated	UV-treated	untreated
0'	0	0	0	0	0	0
10'	21	0	24	22	47	22
30'	23	0	71	38	85	61
40'	23	28	90	52	96	68
60'	27	29	99	70	100	83
90'	62	30	-	-	-	-

Tab. 8.2.5.b Final bath exhaustions (%) for wool fabric untreated and UV-treated 5'

The kinetic curves of dyeing were calculated in according with Cegarra Puente kinetic model and the results are showed (Graph. 8.2.5.c):

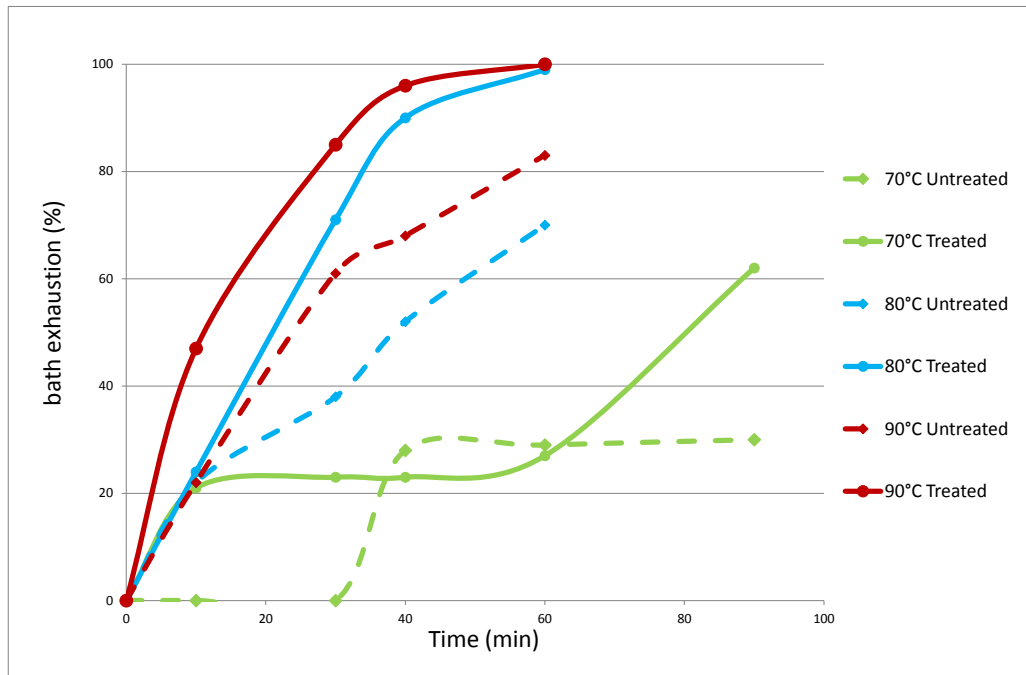

Graph. 8.2.5.c Kinetic curves at different temperatures

For what concerns the dyeability, at each investigated temperature the radiated samples showed better results in terms of kinetics and final bath exhaustion reached. Of relevance was the comparison between the dyeing of the radiated sample at 80°C with the untreated sample at 90°C: in the first case higher final bath exhaustion and faster kinetics were found. The effect was more relevant on high power or long time radiated samples and was confirmed by the adsorption coefficient, calculated at 80°C according Cegarra Puente kinetic model, increased from $8 \cdot 10^{-3}$ to $3 \cdot 10^{-2}$ by radiations effect. It means the real possibility to reduce dyeing temperature and times.

The classical 1:1 Metal complex dye Kemalene Pink BE 200% was chose for a deep investigation about the dyeing kinetics of UV treated and untreated samples, according the dyeing recipe reported (Table 8.2.5.d)

customer	Filidea			data	
colour	KIN	goods	WO fabric		
apparatus	Teintolab				
	textile weight		50 g		
	liquor ratio	1	20		
	bath volume		1000 mL		
	<i>Auxiliaries</i>	<i>Conc.</i>	<i>Unit</i>	<i>Quantity</i>	<i>Unit</i>
	H ₂ SO ₄ 96%	3.5	%	1.75	g
	<i>Dyes</i>	<i>Conc.</i>	<i>Unit</i>	<i>Quantity</i>	<i>Unit</i>
	Kemalene Pink BE 200%	1	%	0.5	g
	<u>go to 85°C with 0.7 °C/‘</u>				
	<u>maintain at 85°C for 90’</u>				
	final pH = 3.0				

Table 8.2.5.d Dyeing recipe for kinetic study with 1:1 Metal-complex dyes

The tests were carried out by Teintolab apparatus, having as the only variable the type of material to dye, that is untreated wool fabric and wool fabric statically radiated for 5 minutes. (Fig. 8.2.5.e and Fig. 8.2.5.f). The graphs express the dye exhaustion in function of time of dyeing, but also the dyeing conditions, such as pH (purple curve), and T (brown curve)

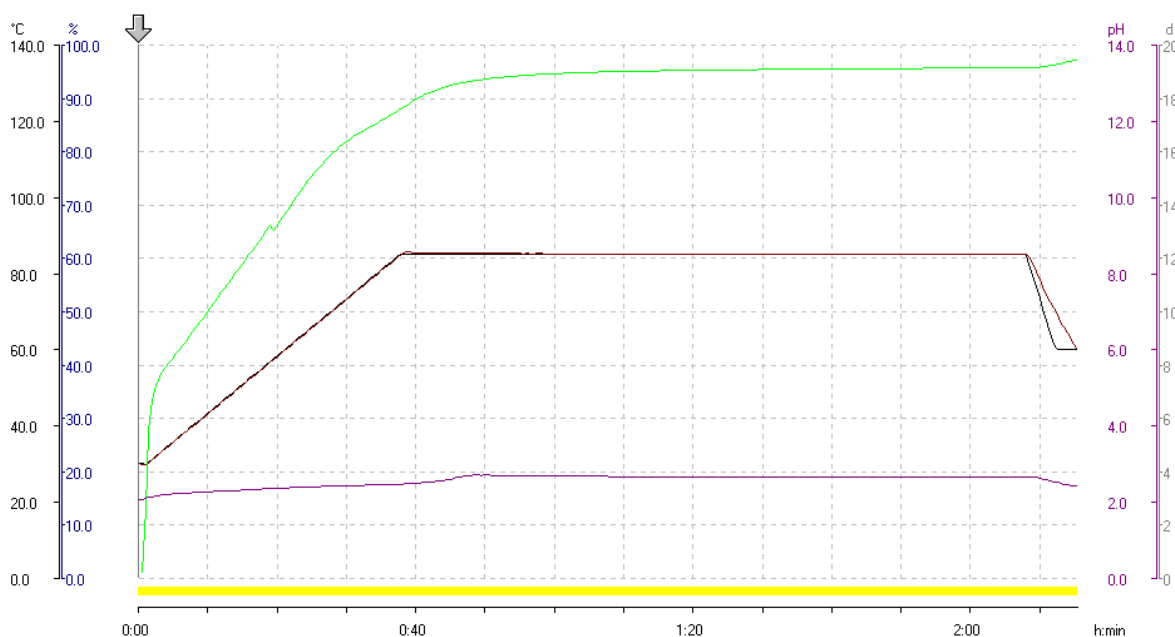

Fig. 8.2.5.e – KINNT - WO untreated

or the dyeing of untreated wool, (Fig. 8.2.5.e) it can be noted that the green curve, related to filter sensitive to red dye, presents a considerable initial "first strike", which follows an almost linear trend (from minute 3 to minute 40), then the exhaustion remains constant during the migration phase of the dye inside the fiber.

In this case, KINNT (KIneticNeolanNotTreated), (Fig. 8.2.5.e) 40 minutes are required to obtain a dye exhaustion of about 90%; it is a fairly quickly behaviour, however for the nature of this type of dye it is not a problem; in fact, the next migration phase (from minute 40 onwards) allows the dye to migrate itself evenly throughout the section of the fiber, also enhanced by the acid pH. around 2.5 allows high migration with this type of dye).

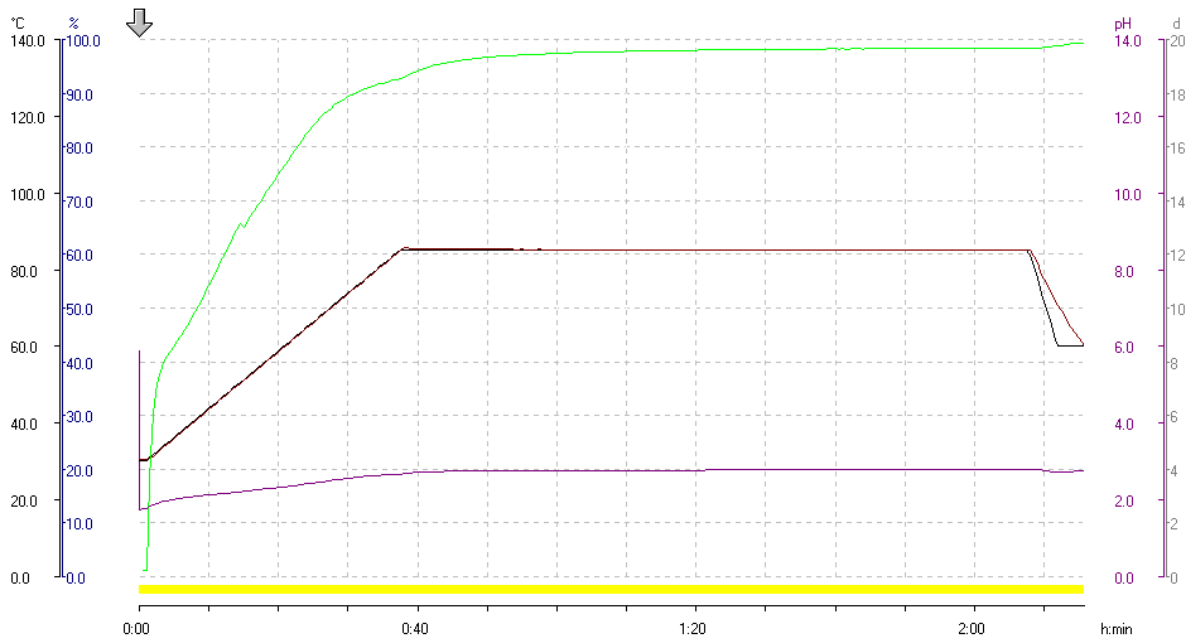

Fig. 8.2.5.f – KINUV5 - WO UV5 treated

The KINUV5 test (KIneticNeolanUVtreated5min) (Fig. 8.2.5.f) shows that the curve in green presents a similar trend: even in this case a considerable initial "first strike", which follow a almost linear trend (from minute 3 to minute 30), then the exhaustion remains constant.

In this second case, after approximately 30 minutes of dyeing 90% of the initially present dye is already on the fiber; compared to the previous case the "quickness" is more pronounced and this is attributable to the fact that the UV-treated wool is more accessible in general to the dyes and may form additional bonds with this type of dyes. In fact, the metal ion of the classical 1:1 metal-complex dye becomes coordinated by the groups formed in the oxidative action of UV radiations.

However the next migration step (from minute 30 forward) allows also to the dye to migrate uniformly throughout the fibrous section (always around pH 2.5) for which the final dyeing is well equalized.

Moreover, the kinetic curves of dyeing exhaustion of UV-treated and untreated wool with the reactive dye Lanazol Red B (reactive dye) (Fig. 8.2.5.g) were studied

customer	Filidea			data	
colour	KIL	goods	WO fabric		
apparatus	Teintolab				
	textile weight		40 g		
	liquor ratio	1	20		
	bath volume		800 mL		
	<i>Auxiliaries</i>	<i>Conc.</i>	<i>Unit</i>	<i>Quantity</i>	<i>Unit</i>
	Na ₂ SO ₄	10	%	4	g
	CH ₃ COOH 60%	2	g/L	1.6	g
	CH ₃ COONa*3H ₂ O	14	g/L	11.2	g
	<i>Dyes</i>	<i>Conc.</i>	<i>Unit</i>	<i>Quantity</i>	<i>Unit</i>
	Lanasol Red B	1	%	0.4	g
	<u>go to 85°C with 0.7 °C/‘</u>				
	<u>maintain at 85°C for 90’</u>				
	final pH = 5.8				

Table 8.2.5.g Dyeing recipe for kinetic study with Reactive dyes

The KILNT test (KILNT (KIneticLanasolNotTreated) (Fig. 8.2.5.h) shows that the green curve, related to filter sensitive to red dye, has no initial "first strike" but shows a linear trend, with constant exhaustion. In this first case, 70 minutes are required to obtain a dye exhaustion of about 70%; it is a little quick trend, recommendable for the nature of this type of dye (reactive dye), whose migration on fiber can be a problem, due to the reduced aptitude for the migration (formation of covalent bonds).

For the KILUV5 test ((KIneticLanasolUVtreated5min) (Fig. 8.2.5.i) the green curve shows a less linear trend, with increasing dye exhaustion in the middle.

In this second case, only 50 minutes are needed to obtain a dye exhaustion of about 70%; it is due to the fact that the UV-treated wool is, in general, more accessible to dye molecules.

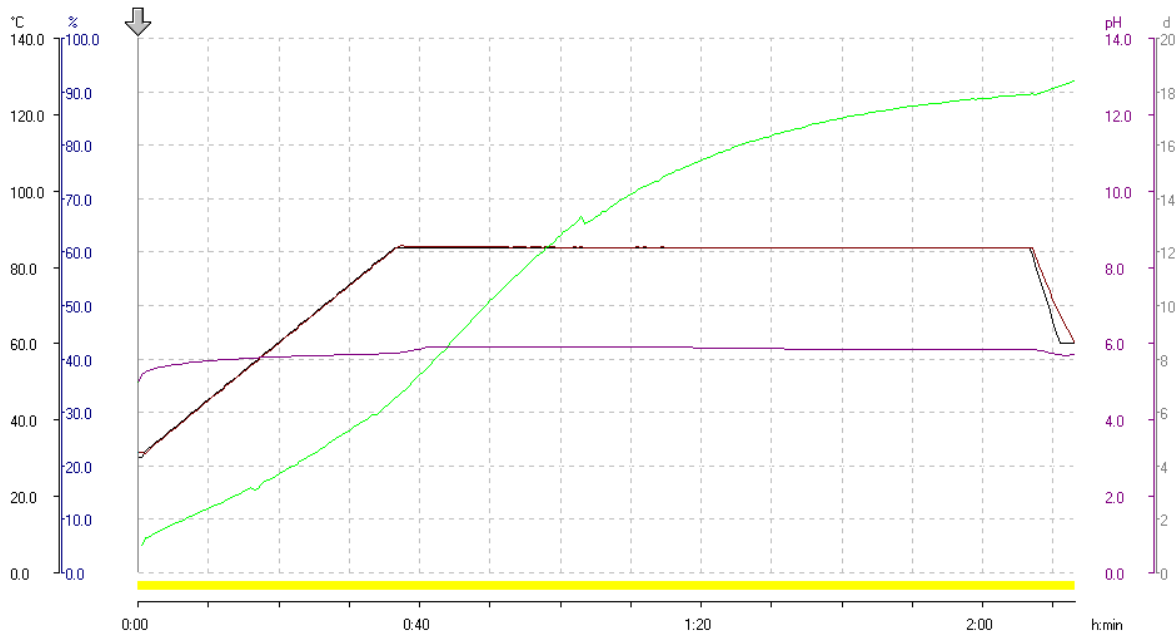

Fig. 8.2.5.h – KILNT - WO untreated

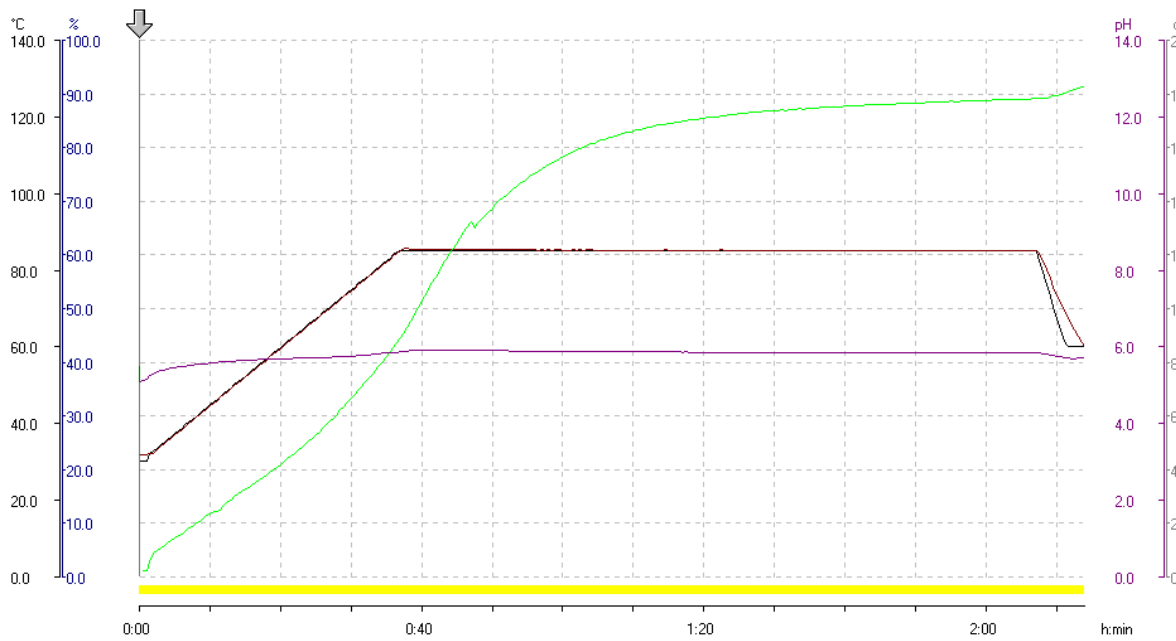

Fig. 8.2.5.i – KILUV5 - WO UV-treated

8.3 Differential dyeing on cotton

8.3.1 Direct dyes

Samples of cotton fabric, treated in a dynamic way, were preliminary dyed with direct dyes by Minox equipment, inspired by previous works for the determination of cotton ripening ^{[1],[2]} by tests carried out with two direct dyes.

The dyeings were conducted at boiling temperature, precisely at 100 °C for 30' and the total amount of NaCl added was 10 g/L. It was necessary due to the poor levelness properties of the dyes. (Table 8.3.1.a)

In all cases, we get good levelness and the dye exhaustion was about 70%, but unfortunately there were not acceptable differences between UV-treated and untreated cotton fibers.

customer	Filidea			data	
colour	Direct Blue 1	goods		CO fabric	
apparatus	Minox				
	textile weight		4.8 g		
	liquor ratio	1	40		
	bath volume		192 mL		
	<u>go to 40°C with 4°C/'</u>				
	<i>Auxiliaries</i>	<i>Conc.</i>	<i>Unit</i>	<i>Quantity</i>	<i>Unit</i>
	Albaflow UNI	2	g/L	0.38	g
	<i>Dyes</i>	<i>Conc.</i>	<i>Unit</i>	<i>Quantity</i>	<i>Unit</i>
	Direct Blue 1	0.1	%	0.0048	g
	<u>run 10'</u>				
	<i>Auxiliaries</i>	<i>Conc.</i>	<i>Unit</i>	<i>Quantity</i>	<i>Unit</i>
	NaCl	1	g/L	0.192	g
	<u>go to 100°C with 1.5°C/'</u>				
	NaCl	5	g/L	0.96	g
	<u>maintain at 100°C for 40'</u>				
	<u>cooling at 80°C (with 1.5°C/'</u>				
	<u>maintain at 80°C for 15'</u>				
	<u>cooling and dropping – then cold rinsing for 20'</u>				
	final pH = 6.5				

Table 8.3.1.a

Dyeing recipe for 0.1% dyeing with Direct dyes

sample	ΔL	Δa	Δb	ΔE
Cromasol Yellow RT	-0.20	0.16	-1.06	1.09
Solophenyl Orange TGL 182%	-0.14	-0.74	-1.74	1.89
Cromasol Red 8BL	2.16	-1.01	-0.21	2.39
Solophenyl Bordeaux 3BLE	1.64	-0.58	0.70	1.88
Direct Blue 1	2.18	-0.14	0.31	2.21
Cromasol Blue 4GLS	-0.16	-0.26	0.23	0.38
Cromasol Green BL	1.63	1.82	0.95	2.62
Solophenyl Blue FGLE 220%	2.53	0.68	2.86	3.88
Solophenyl Navy BLE 250%	5.14	-0.04	3.19	6.05

Table 8.3.1.b CIE L a b parameters for 0.1% dyeings with Direct dyes

Only one term of this dyes selection meet the requirements of total colour difference $\Delta E \geq 5$ points (Table 8.3.1.b); all the others present score less than 5 points, meaning that their colour difference with respect to untreated fabric is negligible.

It is probably possible an enhanced colour difference between cotton UV-treated and untreated increasing the dyeing intensity, but this would lead to further decrease the already not good wet fastness.

Similar behavior was observed also with many classes of reactive dyes for cellulosic fibers (results not reported); for this reason we tried to invert the two phases (dyeing before, then UV-treatment).

The following chromatic studies on cotton were conducted first making the dyeing (in a conventional manner) and subsequently faded by UV radiation.

8.3.2 Reactive dyes

The first class of reactive dyes studied was that of Kayacelon React, where 3-carboxy pyridinio-s-triazine is the reactive group; they are commonly applied at high temperature in presence of an alkali donor (Buslid 509, based on hexametylenetetramine) which raises the pH with increasing temperature.

These dyes have good migration power, provide good wet fastness and can be applied to cellulosic fibers without special attention (Table 8.3.2.a).

Moreover, low temperature reactive dyes, with vinylsulphone as reacting group, were also investigated, applied at just 60°C according the dyeing receipt in table....

While the Avitera SE selection is constituted by a chromogen with 3 reactive groups (chemical structure still under patent), other two selections are equipped with vinylsulphone (Remazol) and triazinyl with or without vinylsulphone ((Levafix CA) as reactive groups.

customer	Filidea			data	
colour	G. Yellow Kayacelon CN-GL	goods	CO fabric		
apparatus	Minox				
	textile weight		10 g		
	liquor ratio	1	20		
	bath volume		200 mL		
	<u>go to 40°C with 4°C/’</u>				
	<i>Auxiliaries</i>	<i>Conc.</i>	<i>Unit</i>	<i>Quantity</i>	<i>Unit</i>
	Na ₂ SO ₄	40	g/L	8	g
	Buslid 509	1	g/L	0.2	g
	<i>Dyes</i>	<i>Conc.</i>	<i>Unit</i>	<i>Quantity</i>	<i>Unit</i>
	G. Yellow Kayacelon CN-GL	1	%	0.1	g
	<u>go to 90°c with 1°C/’</u>				
	<u>maintain at 90°C for 60’</u>				
	final pH = 9.0				
	<u>cooling and dropping – then 2 rinsing at 80°C for 20’</u>				

Table 8.3.2.a Dyeing recipe for 1% dyeing with Kayacelon React dyes

sample	ΔL	Δa	Δb	ΔE
Kayacelon React Yellow CN-RL	-0.18	0.79	-0.48	0.94
Kayacelon React Yellow CN-ML	1.11	-0.49	-0.33	1.26
Kayacelon React Golden Yellow CN-GL	-0.02	0.45	-2.43	2.47
Kayacelon React Red CN-3B	2.28	-6.84	2.27	7.56
Kayacelon React Blue CN-MG	1.19	0.55	3.68	3.91
Kayacelon React Dark Blue CN-R	3.36	1.78	3.13	4.92

Table 8.3.2.b CIE L a b parameters for 1% dyeings with Kayacelon React dyes

Sadly this range of reactive dyes does not meet our requirements (total colour difference $\Delta E \geq 5$ points, Table 8.3.2.b).

We studied then other reactive dyes, belonging to the reactive series Remazol, Levafix and Avitera (Table 8.3.2.c):

customer	Filidea			data	
colour	Remazol Red RB 133%	goods		CO fabric	
apparatus	Minox				
	textile weight		10 g		
	liquor ratio	1	20		
	bath volume		200 mL		
	<i>Auxiliaries</i>	<i>Conc.</i>	<i>Unit</i>	<i>Quantity</i>	<i>Unit</i>
	NaCl	50	g/L	10	g
	<i>Dyes</i>	<i>Conc.</i>	<i>Unit</i>	<i>Quantity</i>	<i>Unit</i>
	Remazol Red RB 133%	0.5	%	0.05	g
	<u>maintain at 60°C for 30'</u>				
	<i>Auxiliaries</i>	<i>Conc.</i>	<i>Unit</i>	<i>Quantity</i>	<i>Unit</i>
	Na ₂ CO ₃	9	g/L	1.8	g
	<u>maintain at 60°C for 30'</u>				
	final pH = 9.8				
	<u>cooling and dropping – then 3 rinsing at 60°C for 20'</u>				

Table 8.3.2.c Dyeing recipe for 0.5% dyeing with Remazol, Levafix and Avitera dyes

The results of these series are listed in the Table 8.3.2.d for Avitera, Table 8.3.2.e for Remazol and Table 8.3.2.f for Levafix:

sample	ΔL	Δa	Δb	ΔE
Avitera Yellow SE	0.86	-0.77	-2.48	2.74
Avitera Red SE	4.92	-10.0	4.02	11.8
Avitera deep Blue SE	5.39	4.14	5.06	8.47

Table 8.3.2.d CIE L a b parameters for 0.5% dyeings with Avitera dyes

sample	ΔL	Δa	Δb	ΔE
Remazol Yellow 4GL	-1.05	0.99	-1.33	1.96
Remazol Yellow 3RS	0.69	-0.92	-5.55	5.67
Remazol Yellow RR	-0.17	-0.10	-0.53	0.56
Remazol Gold Yellow RNL	1.66	-1.48	-3.93	4.52
Remazol br. Orange 3R spec.	3.71	-5.23	-2.34	6.83
Remazol Orange RR	3.05	-5.94	-5.93	8.93
Remazol br. Red F-3B	5.52	-12.4	5.35	14.6
Remazol Red RB 133%	4.65	-11.50	3.69	12.9
Remazol Red RR	9.62	-13.17	4.10	16.8
Remazol br. Red 3BS 150%	3.39	-7.62	2.33	8.66
Remazol Blue RR	6.50	2.40	5.21	8.67
Remazol Navy GG 133%	2.77	3.90	2.83	5.56
Remazol Turquoise G 133%	-0.87	0.89	1.29	1.80
Remazol Black B 133%	4.58	2.76	4.76	7.16

Table 8.3.2.e CIE L a b parameters for 0.5% dyeings with Remazol dyes

sample	ΔL	Δa	Δb	ΔE
Levafix Yellow CA	-0.65	-0.36	-3.94	4.01
Levafix Amber CA	2.09	-3.27	-4.98	6.31
Levafix Scarlet CA	4.02	-3.80	-1.12	5.64
Levafix Red CA	4.37	-5.21	3.15	7.49
Levafix Rubin CA	3.05	-4.66	0.42	5.58
Levafix Blue CA	1.77	-0.42	4.69	5.03
Levafix Navy CA	4.47	2.61	4.35	6.76
Levafix Navy E-BNA	3.33	2.48	3.92	5.71
Levafix Olive CA	-0.67	2.56	-2.25	3.47

Table 8.3.2.f CIE L a b parameters for 0.5% dyeings with Levafix dyes

While the Avitera SE selection is constituted by a chromogen with 3 reactive groups (chemical structure still under patent), other two selections are equipped with vinylsulphone (Remazol) and triazinyl with or without vinylsulphone ((Levafix CA) as reactive groups; in Table 8.3.2.g there are some indications found by technical manuals.

<i>Colou Index</i>	<i>denomination</i>	<i>Light fastness (1/6 SD)</i>	<i>structure</i>	<i>reactive groups</i>
R.Y. 160	Remazol br. Yellow 4GL	5	azo	vinyls.
R.Y. 176	Remazol Yellow 3RS	5		
R.Y. 217	Avitera Yellow SE	5/6		3 groups
	Remazol Yellow RR	4/5	azo	vinyls.
R.O. 107	Remazol Gold YellowRNL 150%	4/5	azo	vinyls.
R.O.16	Remazol br. Orange 3R spec.	4/5	azo	vinyls.
	Remazol Orange RR	4		
	Levafix Scarlet CA	4	azo	triazinyl + vinyls.
	Remazol Red RR	4		
	Levafix Red CA	4	azo	triazinyl + vinyls.
R.R. 286	Avitera Red SE	4		3 groups
R.R. 180	Remazol br. Red F-3B	3/4	azo	vinyls.
	Remazol Blue RR	4		
R.Bl. 281	Avitera deep Blue SE	4		3 groups
	Farbofix Blue SP-BRF 150%	4/5		
	Neareafix br. Blue AC-BRF 150%	5		
	Levafix Navy CA	3/4	azo	triazinyl + vinyls.
	Farbofix Navy SP-BRK/N	3/4		
R.Bl. 225	Levafix NavyE-BNA	2/3		
R.Bl. 21	Remazol Turquoise G 133%	5	phthal.	vinyls.
R.Bk. 5	Remazol Black B 133%	3/4	disazo	2 vinyls.

Table 8.3.2.g

Some indications about light fastness, structure and reactive groups

Moreover, from a careful examination of other results, we note that light fastness is little influenced by type and number of reactive groups on the dye molecule; light fastness (and therefore also the fading ability under UV radiations) is instead related to the chemical structure of the chromogen. Specifically it was noted that the chromogens more difficult to fade, under UV radiations, are those that provide yellow shades (typically made up of pyrazolone); going from orange shades (azo) towards red (azo), blue (disazo) and navy (disazo), the fading ability increases, until the maximum value in the case of R.Bk. 5 (disazo). Turquoise and green shades (phthalocyanine) gives abnormal fading due to their high resistance to UV radiation.

8.4 Fading of dyed cotton yarns

Fading of dyed cotton yarns can be carried out in two ways; one is the UV treatment on yarn as samples wrapped on cardboard (Fig. 8.4.a), where one side is exposed for half area (right hand side) to UV rays. Another way is the free UV treatment on yarn unwinding from a creel (where more or less a semi-cylindrical part is affected by UV rays), then wound on a reel. The Fig. 8.4.c represents the knitwear made from yarn treated in this last way.

Some terms of series above listed have been selected in order to prepare a balanced set of dyes, with characteristics of mutual compatibility and reliability:



Fig. 8.4.a Yarns wrapped on cardboards

dyeing	ΔE	dyeing	ΔE
Levafix Amber CA	6.31	Remazol Blue RR	8.67
Remazol Orange RR	8.93	Remazol Navy GG 133%	5.56
Remazol Red RB 133%	12.9	Remazol Black B 133%	7.16

Table 8.4.b CIE ΔE for 0.5% selected dyeings wrapped on cardboards and UV treated

The samples shown in Figure 8.4.a have been treated under these conditions:

UVA irradiance:	430 mW/cm ²	yarn speed:	11 m/°
n° of steps	6	source working length:	0.6 m
radiant exposure:	8.6 J/cm ²		



Levafix Amber CA



Remazol Blue RR



Remazol Orange RR



Remazol Navy GG 133%



Remazol Red RB 133%



Remazol Black B 133%

Fig. 8.4.c Knitwears made from yarns submitted to free UV treatment

dyeing	ΔE	dyeing	ΔE
Levafix Amber CA	3.58	Remazol Blue RR	5.11
Remazol Orange RR	6.71	Remazol Navy GG 133%	5.18
Remazol Red RB 133%	9.41	Remazol Black B 133%	5.05

Table 8.4.d CIE ΔE for 0.5% selected dyeings free UV treated

Is shown above (Fig. 8.4.c) the fading effect obtained on cotton yarns free UV-treated (in continuous with UV radiation) according to the following parameters:

UVA irradiance: 430 mW/cm² yarn speed: 2 m/'
n° of steps 1 source working length: 0.6 m
radiant exposure: 7.7 J/cm²

As opposed to yarn wrapped on cardboard and then UV exposed (Fig. 8.4.a), yarn unroll by bobbin and free treated under UV lamp maintains its initial temperature, because the cooling system of lamp ventilation does not allow an increase of temperature of textile material. This effect make worse the resulting fading action (Fig. 8.4.c) because there is synergistic fading effect between UV and IR components of radiation.

Besides the chromatic effect of the free yarn cotton UV-treated (Table 8.4.d) is less pronounced than in the same yarn wound on cardboard (Table 8.4.b) (so integrated with it), because the free yarn undergoes rotations during its unrolling from bobbin as showed in Figure 8.4.e; such behavior does not allow the incident radiation of interest always the same semi-circumference of the yarn, so the final color effect is low contrasted (there is not a clear demarcation between UV-treated and untreated one).

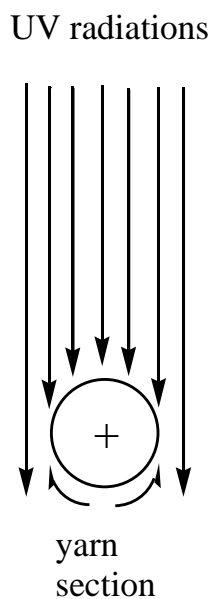

Fig. 8.4.e Section of free yarn interested by UV rays

8.5 References

- [1] Goldthwait, C.F.; Smith, H.O.; Barnett; M.P. 1947. New Dye Technique Shows Maturity of Cotton. *Textile World* 7:105-110.
- [2] N. Abidi et E. Hequet, World Cotton Research Conference-4, 2007
- [3] Y. Dong et J. Jang, *Color. Technol.*, **127**, 173–178, 2011.

Chapter 9

Industrial scale up of the treatments

9.1 Introduction

After a deep investigation at laboratory scale on UV treatments, pre-irradiation on wool and post-irradiation on cotton must be carefully studied and adapted to the needs of the textile industry in order to reach their real application.

The current machinery at the Filidea's plant, operating continuously on yarn and on fabric strips, must be considered as a prototype and therefore it need improvements and various expedients in order to get an effective industrial system. Similar considerations are true for discontinuous method present at Politecnico di Torino, where the apparatus used for static tests is intended for generic UV irradiations, usually to conduct photo polymerization of small amounts of materials. The mentioned devices are below discussed and changes on existing machines are suggested, in order to have industrial apparatus able to irradiate both fabrics and yarns, of wool or cotton, with benefit and to achieve effects of differential dyeing.

9.2 Discontinuous/continuous treatments

For the so-called static systems (ie operating in batch) it is necessary to provide a flat positioning of textiles, both fabric and yarn wrapped in hank, to be treated; UV lamps have usually cylindrical symmetry, so without any precaution, there would be a central area, corresponding to the lamp projection on the textile material, most affected by incoming radiations; in fact it is useful to remember that an UV source, having cylindrical symmetry, produces an irradiance [W/m^2] inversely proportional to the square of the distance between the irradiated surface and the lamp filament. Working then with a single lamp with cylindrical symmetry, it is necessary to provide a parabolic mirror behind the lamp, so that the whole irradiated surface is exposed to approximately same irradiance [W/m^2] or approximately same radiation exposure [J/m^2] – (Fig. 9.2.a, Fig 9.2.b and Fig. 9.2.c^[1]).

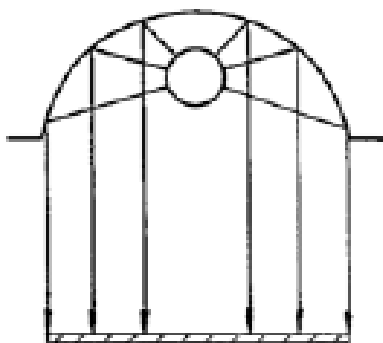

Fig. 9.2.a

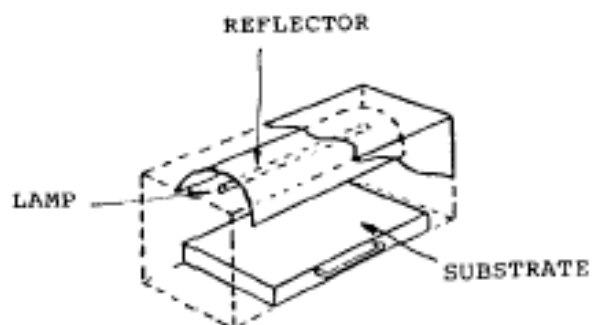

Fig. 9.2.b

Cylindrical symmetry with parabolic mirror

Parabolic reflector

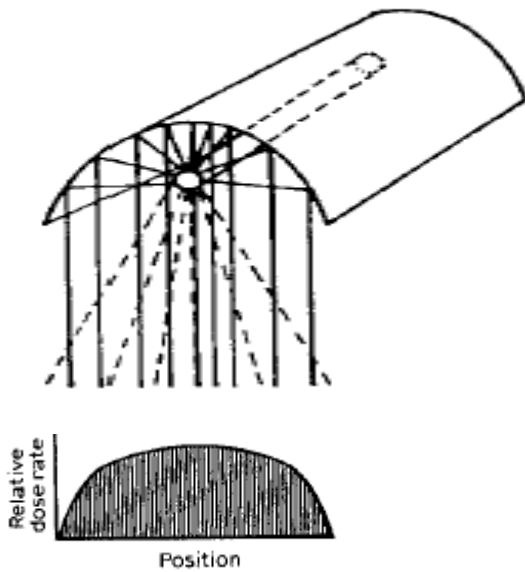

Fig. 9.2.c Irradiated surface exposed (approximately same irradiance)

9.2.1 Industrial applications

The machinery present in Filidea is schematically represented in Figg. 9.2.1.a, b and c. The UV lamp is longitudinally disposed respect to the feed direction of fabric strips or yarns; for the fabric strips the feed is guaranteed by a carpet driven by two motorized rollers, while for yarns the feed is operated by a reel placed after the lamp.

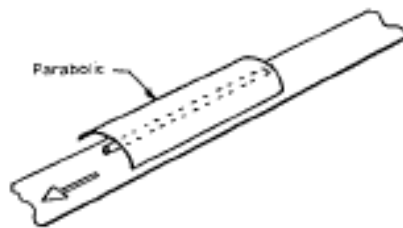

Fig. 9.2.1.a Longitudinal treatment

This prototype presents some limits:

- irradiance not completely constant in the working width;
- limited productivity, due to the fact that to obtain satisfactory results it is necessary to operate with modest feed-rate (eg. cotton yarn fed to 2 m / ');
- relevant thermal effects (positives in case of fading on dyed yarn cotton) due to the absence of dichroic filters;
- limitations in the hanks treatment (only arranged in longitudinal direction), exclusion of fabrics (only fabric strips), limited options for clothes treatment (wrinkled clothes for fancy effects).



Fig. 9.2.1.b

Longitudinal free yarns treatment

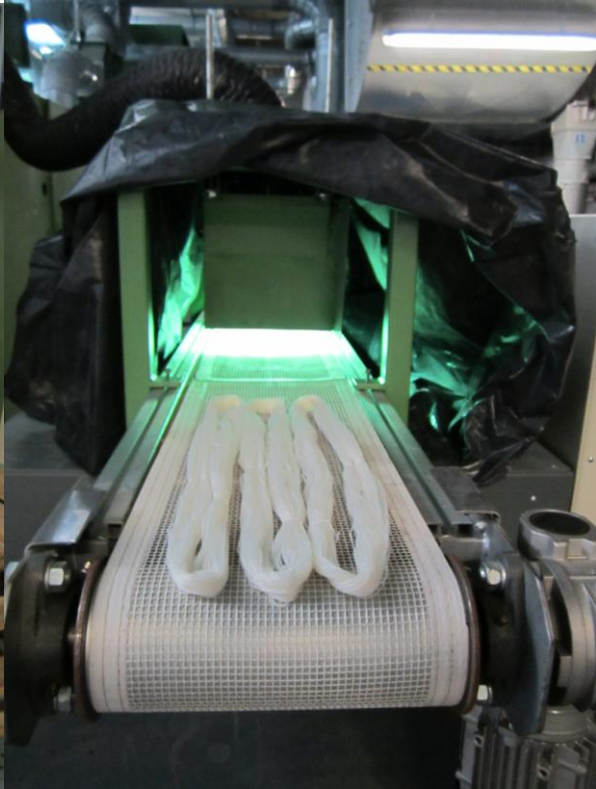

Fig. 9.2.1.c

Longitudinal hanks treatment

The machinery present in TMT Manenti instead consists of 3 equally spaced UV lamps in series that irradiate in a transversal way the fabric or the yarn in feed (Fig. 9.2.1.d, Fig. 9.2.1.e and Fig. 9.2.1.f)

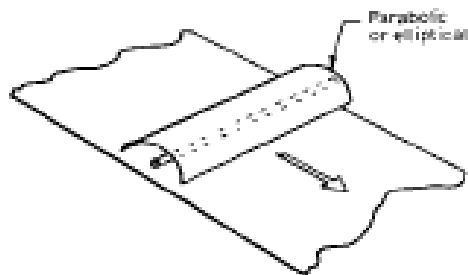

Fig. 9.2.1.d Transversal treatment

The machine shows the following characteristics:

- irradiance completely constant in the working width;
- treatment uniformity in the head - tail direction of the fabric or yarn feed;
- good productivity due to the fact that, even with modest speed of yarn feed, it is possible to work with a considerable number of bobbins (eg. 96 yarn bobbins of an average fineness of cotton yarn, always fed at 2 m / ');
- selectable thermal effects with the possibility to insert the dichroic filter;
- no limitation to hank treatments (arranged both longitudinally or transversally),
- no limitation to fabric and garment treatments (both wide or wrinkled).

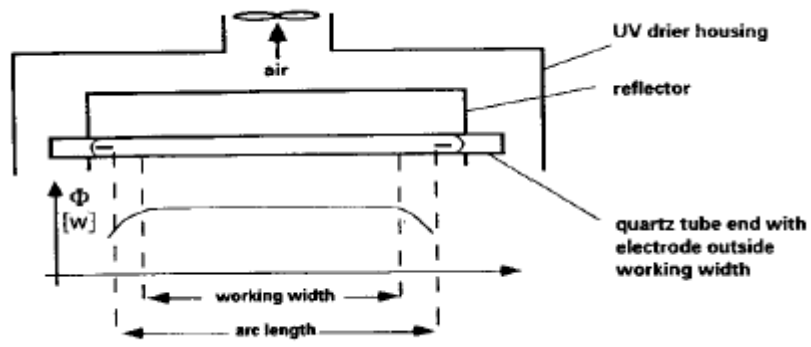

Fig. 9.2.1.e Scheme of transversal treatment

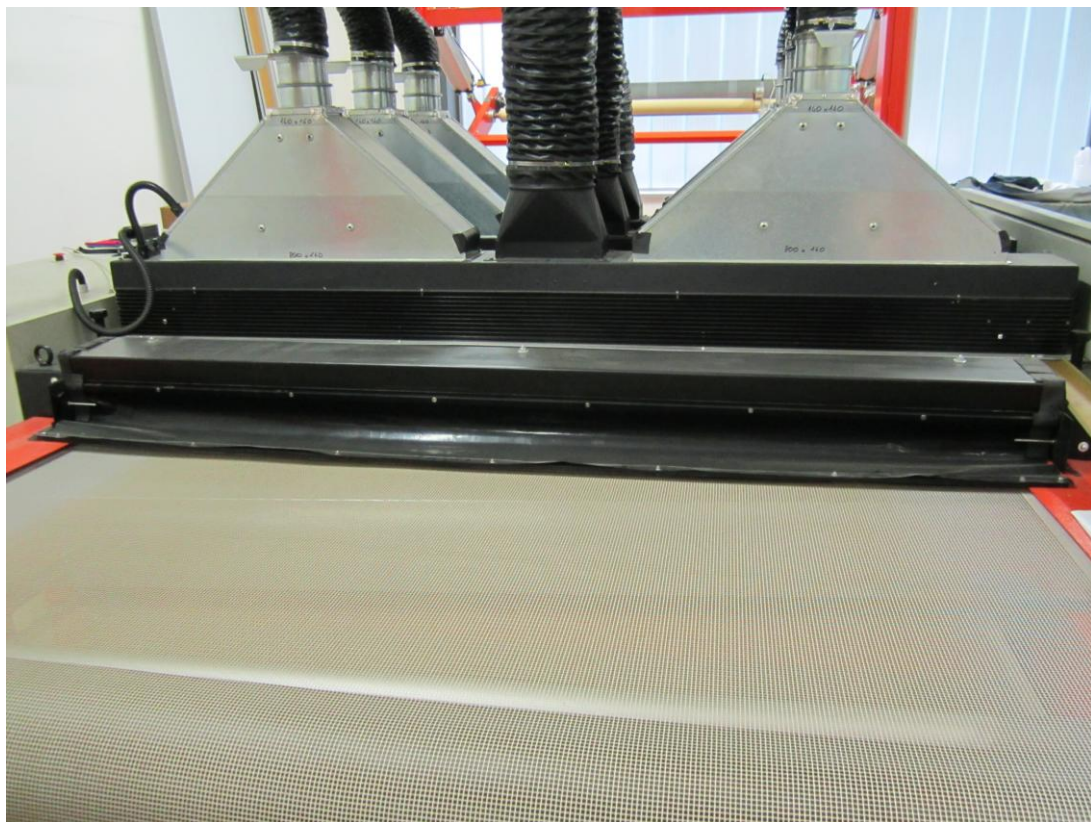

Fig. 9.2.1.f Transversal treatment of fabrics

9.2.2 Proposals

One of the most important requirements for an industrial application of the process, is the speed of treatment that should be as high as possible, in accordance with the speed of the other finishing processes carried out in continuous on the substrate. A first proposal is to modify a textile machinery destined for the singeing (Fig. 9.2.2.a), inactivating the two gas burners and inserting a serie of UV lamps, transversally arranged to the fabric feed and equipped with parabolic diffusers; in this way it is possible to treat the fabric in unwinding from one warp beam and get the UV treatment only on one side of the fabric.

Alternatively, it is possible to provide a single UV source, always transversally to the fabric feed working with a number of unwindings / windings, in a manner to send the request radiant exposure onto the concerned area. Normally in machinery for singeing only one of the two beams is motorized; in this case it is necessary to provide a second motor which can give also the opposite movement to the fabric and a system of slight braking on both beams, so that to keep the fabric in motion always well tensioned, thus avoiding creases.

In this type of textile machine the suction system to remove residues is normally already present ; however, it is necessary to channeling the flow in a special filtering system, such as carbon filters, to inactivate the ozone produced by UV radiation.

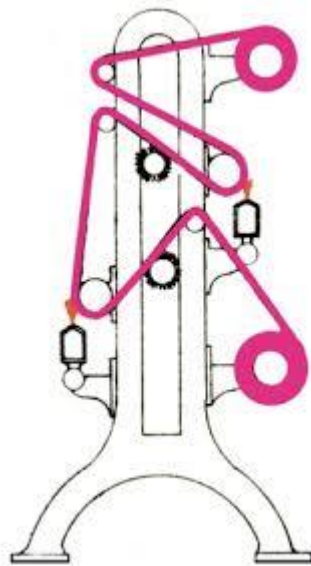

Fig. 9.2.2.a Modified singeing machine

(taken from: <http://www.sicurfad.it/strumenti/documenti/sicurfad127.pdf> - last access on 01/10/2013)

A second proposal is to equip the machine for plasma treatment on fabric (Fig. 9.2.2.b and Fig. 9.2.2.c) with one or more UV lamps; it is possible to change the "core" of the device, replacing the plasma generator with UV lamps.



Fig. 9.2.2.b

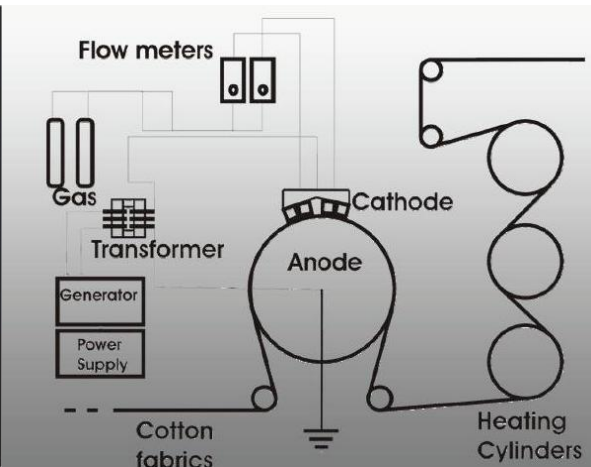

Fig. 9.2.2.c

Modified plasma device

Also in this case both unwinding / winding warp beams are used to perform several times the UV treatment always on the same face of the fabric, in order to impart the proper radiant exposure. This machine is already equipped with suction channeled in a special filtering system, because the plasma also produces considerable amounts of ozone, so the changes are at the level of the generator. In its place there will be one or more UV lamps with parabolic reflector (Fig. 9.2.2.d) equipped with dichroic mirror:

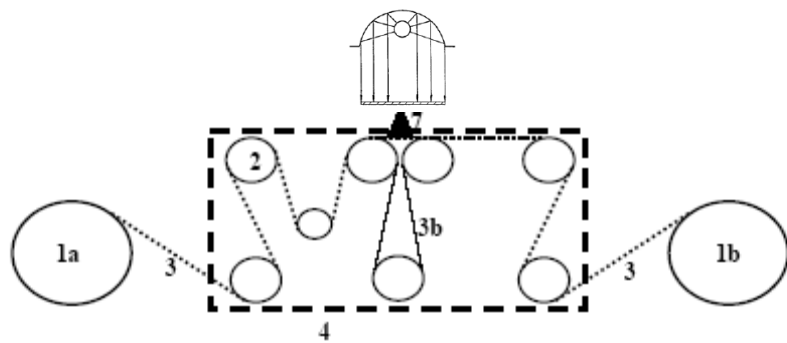

Fig. 9.2.2.d

Modified plasma scheme

9.3 References

[1] G. Gozzelino, Lecture notes “Polimeri e radiazioni”, academic year 2012/’13.

Chapter 10

Study of a technique that permits to achieve a sun-bleached look on fabrics

10.1 Introduction

Currently on the market there is a technical (Sun-Wash®) by Stamperia Emiliana s.r.l., which enables to obtain special effects known as "sun-bleached look" on fabrics. During this experimental work we have developed a similar technique, always starting from a UV irradiation of wool fabric, followed by a dyeing with particular selections of dyes, in order to obtain not only a different colour intensity between the UV irradiated side and untreated one, but also a "two-tone" effect, that is two shades with different colour and intensity.

10.2 Wool dyeing with special effects

A recipe to develop this "special effect" is reported in Table 10.2.a. Working with appropriate mixtures of dyes, for example a mix of classical 1:1 metal complex dyes with acid dyes 1st group, the effects shown in Fig 10.2.c were obtained, which correspond to relevant colour differences on opposing sides (Table 10.2.b)

customer	Filidea			data	
colour	A.O. 7 + A.Bk. 52	goods		WO fabric (N.T. + UV5)	
apparatus	Minox				
	textile weight		10 g		
	liquor ratio	1	20		
	bath volume		200 mL		
	<i>Auxiliaries</i>	<i>Conc.</i>	<i>Unit</i>	<i>Quantity</i>	<i>Unit</i>
	H ₂ SO ₄ 96%	3.5	%	0.35	g
	<i>Dyes</i>	<i>Conc.</i>	<i>Unit</i>	<i>Quantity</i>	<i>Unit</i>
	Orange Conc. II	0.5	%	0.05	g
	Kemalene Black BW 364%	0.5	%	0.05	g
	<u>go to 85°C with 0.7 °C/‘</u>				
	<u>maintain at 85°C for 90’</u>				
	final pH = 2.6				

Table 10.2.a Dyeing recipe for mix 1:1 Metal-complex and Acid dyes

sample	ΔL	Δa	Δb	ΔE
A	-4.99	-3.27	-5.43	8.06
B	-4.62	6.31	-2.05	8.09
C	-4.06	-3.39	-5.20	7.41
D	-3.57	-4.84	1.35	6.17
E	-5.05	4.86	3.21	7.71
F	-4.77	8.45	-1.90	9.89

Table 10.2.b CIE L a b parameters for dyeings with mix 1:1 Metal-complex and Acid dyes

All the dyed samples highlight delta E greater than 5 units.

These dye mixtures have some peculiarities; operating in fact in the well-established dyeing conditions (maintaining the temperature at 85 °C for 90 ') the 1:1 metal-complex dyes selects between the UV treated and not treated wool fabric in the manner already described for the effects light - dark in tone, while the acid dyes, which by their nature can not make this selection, are equally distributed between UV-treated and untreated wool fabric. Many combinations of the above dyes are so possible, with the ultimate goal to achieve simultaneous differences in intensity and in tone.

NOT EXPOSED SIDE



EXPOSED SIDE

A B C D E F

Fig. 10.2.c Wool fabrics dyed with 1:1 modified Metal-complex and Acid dyes at 85 °C x 90'

mix	% dye [kind of dye]	% dye [kind of dye]	% dye [kind of dye]
A	0.500% Acid Orange 7 [acid]	0.500% Acid Black 52 [1:1 metal-complex]	
B	0.750% Acid Yellow 17 [acid]	0.500% Acid Red 194 [1:1 metal-complex]	0.250% Acid Blue 25 [acid]
C	0.750% Acid Orange 7 [acid]	0.250% Acid Blue 158 [1:1 metal-complex]	
D	0.750% Acid Yellow 104 [1:1 metal-complex]	0.500% Acid Red 337 [acid]	0.500% Acid Blue 158 [1:1 metal-complex]
E	0.600% Acid Red 194 [1:1 metal-complex]	0.250% Acid Blue 25 [acid]	
F	0.750% Acid Yellow 17 [acid]	0.500% Acid Red 186 [1:1 metal-complex]	0.250% Acid Blue 25 [acid]

Table 10.2.d Composition of the combinations presented

In all colour combinations proposed (Table 10.2.d), the total colour difference is much higher than the threshold value (5 units) (Table 10.2.b); therefore it is a noticeable and chromatically relevant effect: the not exposed part to UV radiation is always lighter and presents a tone considerably different from the UV treated part, which instead appears darker and with another hue.

The obtained contrasts are listed in Table 10.2.e:

mix	untreated part	UV-treated part
A	dark orange	dark grey
B	light green-grey	dark red-grey
C	orange	dark beige
D	light red	dark bordeaux
E	light blue	dark purple
F	green-grey	red-grey

Table 10.2.e Chromatic perception of the combinations presented

10.2.1 Fastnesses

The machine washing and dry rubbing fastnesses, measured on treated samples, are the same obtainable with same dyestuffs in a conventional dyeing mode ^[1] (98°C for 60' or more, depending on the colour intensity), (Table 10.2.1.a and Table 10.2.1.b).

Just in the last case treated (special effect - light and dark tones with different colours) the wet fastnesses are lower than those normally required (Table 10.2.1.d), because acid dyes belonging to 1st group are not suitable for obtaining dyeings with knitwear fastnesses ^[2] (Table 10.2.1.c).

These results are not surprising since the acid dyes belonging to 1st group generate dyeings with modest wet fastness, normally accepted for garments intended to dry cleaning. Further studies will be focused to ensure chromatic results together with colour fastness for the desired uses.

dyeings		Woolmark TM 193a (4 g/L ECE a 50°C x 30')							Woolmark TM 165
		machine washing							dry rubbing
		D	CA	CO	PA 6.6	PL	PC	WO	CO
untreated	UV treated								
1% Yellow P NT	1% Yellow P UV5	5	5	5	5	5	5	5	5
1% Red P NT	1% Red P UV5	5	5	5	5	5	5	5	5
1% Bordeaux P NT	1% Bordeaux P UV5	5	5	5	5	5	5	5	5
1% Blue P NT	1% Blue P UV5	5	5	5	5	5	5	5	5
1% Blue PA NT	1% Blue PA UV5	4/5 R	5	5	5	5	5	5	5
4% Navy P NT	4% Navy P UV5	4/5	5	4	5	5	5	5	4
4% Navy PA NT	4% Navy PA UV5	4/5	5	4	5	5	5	5	4/5
5% Black P NT	5% Black P UV5	4/5	5	4	3/4	5	5	5	4

Table 10.2.1.a

Machine washing and dry rubbing fastnesses for dyeing with modified 1:1 Metal-complex dyes

C

dyeings		Woolmark TM 193a (4 g/L ECE a 50°C x 30')							Woolmark TM 165
		machine washing							dry rubbing
		D	CA	CO	PA 6.6	PL	PC	WO	CO
untreated	UV treated								
1% A.Y. 104 NT	1% A.Y. 104 UV5	4/5	5	5	5	5	5	5	4
1% A.Y. 99 NT	1% A.Y. 99 UV5	5	5	5	4	5	5	5	4/5
1% A.O. 74 NT	1% A. O. 74 UV5	5	5	5	4	5	5	5	4/5
1% A.R. 183 NT	1% A.R. 183 UV5	5	5	5	4	5	5	5	4/5
1% A.R. 186 NT	1% A.R. 186 UV5	5	5	5	4	5	5	5	4/5
1% A.R. 195 NT	1% A.R. 195 UV5	4/5	5	5	5	5	5	5	4
1% A.R. 194 NT	1% A.R. 194 UV5	4/5	5	4/5	5	5	5	5	4/5
1% A.V. 115 NT	1% A.V. 115 UV5	5	5	5	4	5	5	5	4/5
1% A.BI. 158 NT	1% A.BI. 158 UV5	4 R	5	5	4	5	5	5	4/5
1% Navy 2RLB NT	1% Navy 2RLB UV5	4/5	5	5	5	5	5	5	4/5
1% A.Bk. 52 NT	1% A.Bk. 52 UV5	5	5	5	4	5	5	5	4

Table 10.2.1.b

Machine washing and dry rubbing fastnesses for dyeing with classical 1:1 Metal-complex dyes

		Woolmark TM 193a (4 g/L ECE a 50°C x 30')							Woolmark TM 165
		machine washing							dry rubbing
dyeings		D	CA	CO	PA 6.6	PL	PC	WO	CO
untreated	UV treated								
A NT 85C	A UV5 85C	4	4	3	4	5	5	3	4
B NT 85C	B UV5 85C	3	4	4	3	5	5	3	4/5
C NT 85C	C UV5 85C	3	4	4	4	5	5	3	4/5
D NT 85C	D UV5 85C	3	4	4	3/4	5	5	3	4
E NT 85C	E UV5 85C	3	4	4	3	5	5	3	4/5
F NT 85C	F UV5 85C	3	4	4	3	5	5	3	4/5

Table 10.2.1.c

Machine washing and dry rubbing fastnesses for dyeing with mix 1:1 Metal-complex and Acid dyes

		Woolmark TM 193a (4 g/L ECE a 50°C x 30')							Woolmark TM 165
		machine washing							dry rubbing
dyeings		D	CA	CO	PA 6.6	PL	PC	WO	CO
		3/4	3/4	3/4	4	3/4	3/4	4	3/4

Table 10.2.1.d

Machine washing and dry rubbing fastnesses requested for knitwear(Woolmark®)

10.3 References

[1] Colour cards supplied by Huntsman - Textile Effects :

Neolan[®] P - Dyeing system with modified 1:1 metal complex dyes for highest wool quality (2007)

Neolan[®] - Dyes for wool pieces dyeing (2011)

[2] Fastness standards supplied by Woolmark[®]

Chapter 11

Economical evaluation of the process

11.1 Feasibility

The treatments with ultraviolet radiation on yarns or fabrics (wool and cotton) are applicable on basis of market demand, always looking for new fashion effects, in order to satisfy the needs and tastes of increasingly customers demanding. In this respect, if it may be too expensive the purchase of new UV equipment for treatments (Hg vapour lamps, cooling fans, etc.) it is possible to amend some existing machinery (eg. equipment for wide fabrics singeing, or machines for yarn printing) providing irradiation systems that interface existing machinery; so it will be possible get a "hybrid" machine, able to perform various operations, with appropriate rearrangements.

11.2 Reliability

The reliability of such machinery is related to the robustness of the constituent materials (chassis, fans, vacuum cleaners, etc..), but especially to good efficiency of the radiation system, that is directly dependent to the lamps efficiency in work; it must be remembered that commonly used lamps are Hg vapor lamps (normally at low or at medium pressure), that undergo a change of their spectral distribution in function of time. It is therefore recommended to make regular inspections of their spectral emission.

Monitoring this energy parameter, the results of the UV irradiation on textile materials are time dependent; it should be noted that in order to compare different machines for UV treatments, it is not sufficient to monitor the radiant exposure, because this parameter is not enough for a correct description of work conditions.^[1]

Indeed, the radiant exposure involves significant risk of repeatability; in fact also other parameters, not always easily controllable, have a very important role (combined maximum variability of 500%):

1. difference in spectral irradiance;
2. difference in exposure temperature;
3. difference in moisture exposure.

Hence, it is advisable to perform the textile materials irradiation trying as much as possible to standardize the work conditions; it is recommended for this purpose to carry out the irradiation on textile materials already conditioned ($T=20^{\circ}\text{C}$ and $\text{R.H.}=65\%$)^[2]; if this is not possible, it is advisable to leave the material acclimatize for at least 24 h near the machine for processing UV. The moisture management in fact affects the effects of radiation, because the residual moisture absorb the IR component of lamps and also influences the textile temperature under irradiation. It will therefore be good practice to make regular inspections of the spectral output of the lamps in use, in order to compensate the normal radiant decay with an increase of the electrical power supply (% increase the rheostat control).

11.3 Effective costs

The costs evaluation was based on the energy consumption required for heating and maintaining the dyeing system (machinery, textile material and dyebath), with the addition of energy consumption for Hg vapour lamps required for the UV irradiation.

In the calculation for the maintenance of the dyeing system, it is considered the heat loss by convection only, neglecting the phenomena of conduction and irradiation.

Here are presented the energy balances;

the **dyeing apparatus used** (API/O/1 - OBEM – Biella), has the following characteristics:

single dyeing tube

external diameter = 0.300 [m] internal diameter = 0.288 [m]
weight = 84 [kg] length = 1.93 [m]

expansion tank

height = 0.77 [m] external diameter = 0.66 [m]

total weight approximated of steel = 200 [kg]

Calculation for wool yarn (fineness $N_m = 2/28$)

8 bobbins of 1.25 [kg] each for a total fibre weight of 10 [kg]

liquor ratio = 1:10 for a total bath weight of 100 [kg]

C_p (wool) = 0.31 [kcal*kg⁻¹*K⁻¹]

DYEING AT 85 [°C] FOR 90'

Heating from 20 [°C] to 85 [°C]

$$Q = M_{H_2O} * C_{p_{H_2O}} * \Delta T + M_{steel} * C_{p_{steel}} * \Delta T + M_{wool} * C_{p_{wool}} * \Delta T$$

where:

$$M_{H_2O} = 100 \text{ [kg]} \quad C_{p_{H_2O}} = 1 \text{ [kcal*kg}^{-1}\text{*K}^{-1}\text{]} \quad \Delta T = 65 \text{ [K]}$$

$$M_{steel} = 200 \text{ [kg]} \quad C_{p_{steel}} = 0.12 \text{ [kcal*kg}^{-1}\text{*K}^{-1}\text{]} \quad \Delta T = 65 \text{ [K]}$$

$$M_{wool} = 10 \text{ [kg]} \quad C_{p_{wool}} = 0.31 \text{ [kcal*kg}^{-1}\text{*K}^{-1}\text{]} \quad \Delta T = 65 \text{ [K]}$$

Then $Q = 8261$ [kcal] for heating the system from 20 [°C] to 85 [°C]

Maintenance at 85 [°C] for 90' (dissipation by natural convection)

$$T_p = 85 \text{ [°C]} \quad T_\infty = 20 \text{ [°C]} \quad T = 52.5 \text{ [°C]}$$

parameter related to air at 52.5 [°C] and 1 [bar]:

$$\rho = 1.0702 \text{ [kg}\cdot\text{m}^{-3}] \quad \mu = 1.9785 \cdot 10^{-5} \text{ [kg}\cdot\text{m}^{-1}\cdot\text{s}^{-1}]$$

$$k = 2.8058 \cdot 10^{-2} \text{ [J}\cdot\text{s}^{-1}\cdot\text{m}^{-1}\cdot\text{K}^{-1}] \quad C_p = 1.0082 \cdot 10^3 \text{ [J}\cdot\text{kg}^{-1}\cdot\text{K}^{-1}]$$

Calculation of Prandtl and Grashof's numbers for the dyeing tube:

$$N_{Pr} = (C_p \cdot \mu) / k = 0.7109$$

$$N_{Gr} = (D^3 \cdot \rho^2 \cdot g \cdot \beta \cdot \Delta T) / \mu^2 = 1.5476 \cdot 10^8 \quad \text{where } \beta = 1 / ((T_{air} + T_{wall}) / 2) = 3.0722 \cdot 10^{-3} \text{ [K}^{-1}]$$

$$N_{Pr} \cdot N_{Gr} = 1.10 \cdot 10^8$$

$$\text{because: } 10^4 < N_{Pr} \cdot N_{Gr} < 10^9 \quad h_m = 1.3 \cdot (\Delta T / D)^{0.25} = 1.1913 \text{ [cal}\cdot\text{m}^{-2}\cdot\text{s}^{-1}\cdot\text{K}^{-1}]$$

$$\text{tube surface, } A = 2.384 \text{ [m}^2] \quad \Delta T = 65 \text{ [K]} \quad t = 5400 \text{ [s]}$$

$$Q = h_m \cdot A \cdot \Delta T \cdot t = 997 \text{ [kcal]} \text{ for maintain the tube at } 85 \text{ [}^\circ\text{C]}$$

Calculation of Prandtl and Grashof's numbers for the expansion tank:

$$N_{Pr} = (C_p \cdot \mu) / k = 0.7109$$

$$N_{Gr} = (L^3 \cdot \rho^2 \cdot g \cdot \beta \cdot \Delta T) / \mu^2 = 2.6167 \cdot 10^9 \quad \text{where } \beta = 1 / ((T_{air} + T_{wall}) / 2) = 3.0722 \cdot 10^{-3} \text{ [K}^{-1}]$$

$$N_{Pr} \cdot N_{Gr} = 1.88 \cdot 10^9$$

$$\text{because: } 10^9 < N_{Pr} \cdot N_{Gr} < 10^{12} \quad h_m = 1.8 \cdot (\Delta T)^{0.25} = 1.221 \text{ [cal}\cdot\text{m}^{-2}\cdot\text{s}^{-1}\cdot\text{K}^{-1}]$$

$$\text{expansion tank surface, } A = 2.073 \text{ [m}^2] \quad \Delta T = 65 \text{ [K]} \quad t = 5400 \text{ [s]}$$

$$Q = h_m \cdot A \cdot \Delta T \cdot t = 888 \text{ [kcal]} \text{ for maintain the expansion tank at } 85 \text{ [}^\circ\text{C]}$$

Hence, the total heat for carrying a dyeing at 85 [°C] for 90' is equal to:

$$8261 + 997 + 888 = 10146 \text{ [Kcal]} \text{ or } 42479 \text{ [kJ]}$$

DYEING AT 98 [°C] FOR 60'

Heating from 20 [°C] to 98 [°C]

$$Q = M_{H_2O} \cdot C_{p \text{ H}_2O} \cdot \Delta T + M_{steel} \cdot C_{p \text{ steel}} \cdot \Delta T + M_{wool} \cdot C_{p \text{ wool}} \cdot \Delta T$$

where:

$$M_{H_2O} = 100 \text{ [kg]} \quad C_{p \text{ H}_2O} = 1 \text{ [kcal}\cdot\text{kg}^{-1}\cdot\text{K}^{-1}] \quad \Delta T = 78 \text{ [K]}$$

$$M_{steel} = 200 \text{ [kg]} \quad C_{p \text{ steel}} = 0.12 \text{ [kcal}\cdot\text{kg}^{-1}\cdot\text{K}^{-1}] \quad \Delta T = 78 \text{ [K]}$$

$$M_{wool} = 10 \text{ [kg]} \quad C_{p \text{ wool}} = 0.31 \text{ [kcal}\cdot\text{kg}^{-1}\cdot\text{K}^{-1}] \quad \Delta T = 78 \text{ [K]}$$

then: $Q = 9914 \text{ [kcal]}$ for heating the system from 20 [°C] to 98 [°C]

Maintenance at 98 [°C] for 60' (dissipation by natural convection)

$$T_p = 98 \text{ [°C]} \quad T_\infty = 20 \text{ [°C]} \quad T = 59 \text{ [°C]}$$

parameter related to air at 59 [°C] and 1 [bar]:

$$\rho = 1.04992 \text{ [kg*m}^{-3}\text{]} \quad \mu = 2.0084*10^{-5} \text{ [kg*m}^{-1}\text{*s}^{-1}\text{]}$$

$$k = 2.85208*10^{-2} \text{ [J*s}^{-1}\text{*m}^{-1}\text{*K}^{-1}\text{]} \quad C_p = 1.00872*10^3 \text{ [J*kg}^{-1}\text{*K}^{-1}\text{]}$$

Calculation of Prandtl and Grashof's numbers for the dyeing tube:

$$N_{Pr} = (C_p*\mu)/k = 0.7103$$

$$N_{Gr} = (D^3*\rho^2*g*\beta*\Delta T)/\mu^2 = 1.5476*10^8 \quad \text{where } \beta = 1/((T_{air}+T_{wall})/2) = 3.0120*10^{-3} \text{ [K}^{-1}\text{]}$$

$$N_{Pr}*N_{Gr} = 1.700*10^8$$

$$\text{because: } 10^4 < N_{Pr}*N_{Gr} < 10^9 \quad h_m = 1.3*(\Delta T/D)^{0.25} = 1.2468 \text{ [cal*m}^{-2}\text{*s}^{-1}\text{*K}^{-1}\text{]}$$

$$\text{tube surface, } A = 2.384 \text{ [m}^2\text{]} \quad \Delta T = 78 \text{ [K]} \quad t = 3600 \text{ [s]}$$

$$Q = h_m*A*\Delta T*t = 835 \text{ [kcal]} \text{ for maintain the tube at } 98 \text{ [°C]}$$

Calculation of Prandtl and Grashof's numbers for the expansion tank:

$$N_{Pr} = (C_p*\mu)/k = 0.7109$$

$$N_{Gr} = (L^3*\rho^2*g*\beta*\Delta T)/\mu^2 = 2.6167*10^9 \quad \text{where } \beta = 1/((T_{air}+T_{wall})/2) = 3.0120*10^{-3} \text{ [K}^{-1}\text{]}$$

$$N_{Pr}*N_{Gr} = 2.8754*10^9$$

$$\text{because: } 10^9 < N_{Pr}*N_{Gr} < 10^{12} \quad h_m = 1.8*(\Delta T)^{0.25} = 1.221 \text{ [cal*m}^{-2}\text{*s}^{-1}\text{*K}^{-1}\text{]}$$

$$\text{expansion tank surface, } A = 2.073 \text{ [m}^2\text{]} \quad \Delta T = 78 \text{ [K]} \quad t = 3600 \text{ [s]}$$

$$Q = h_m*A*\Delta T*t = 744 \text{ [kcal]} \text{ for maintain the expansion tank at } 98 \text{ [°C]}$$

Hence, the total heat for carrying a dye at 85 [°C] is equal to:

$$9914 + 835 + 744 = 11493 \text{ [Kcal]} \text{ or } 48119 \text{ [kJ]}$$

Calculation for cotton yarn (fineness $N_m = 2/28$)

8 bobbins of 1.25 [kg] each for a total fibre weight of 10 [kg]

liquor ratio = 1:10 for a total bath weight of 100 [kg]

$$C_p (\text{cotton}) = 0.32 \text{ [kcal*kg}^{-1}\text{*K}^{-1}\text{]}$$

DYEING AT 60 [°C] FOR 60'

Heating from 20 [°C] to 60 [°C]

$$Q = M_{\text{H}_2\text{O}} * C_{p \text{H}_2\text{O}} * \Delta T + M_{\text{steel}} * C_{p \text{ steel}} * \Delta T + M_{\text{cotton}} * C_{p \text{ cotton}} * \Delta T$$

where:

$$M_{\text{H}_2\text{O}} = 100 \text{ [kg]} \quad C_{p \text{H}_2\text{O}} = 1 \text{ [kcal*kg}^{-1}\text{*K}^{-1}] \quad \Delta T = 40 \text{ [K]}$$

$$M_{\text{steel}} = 200 \text{ [kg]} \quad C_{p \text{ steel}} = 0.12 \text{ [kcal*kg}^{-1}\text{*K}^{-1}] \quad \Delta T = 40 \text{ [K]}$$

$$M_{\text{cotton}} = 10 \text{ [kg]} \quad C_{p \text{ cotton}} = 0.32 \text{ [kcal*kg}^{-1}\text{*K}^{-1}] \quad \Delta T = 40 \text{ [K]}$$

Then $Q = 5088 \text{ [kcal]}$ for heating the system from 20 [°C] to 60 [°C]

Maintenance at 60 [°C] for 60'

(dissipation by natural convection)

$$T_p = 60 \text{ [°C]} \quad T_\infty = 20 \text{ [°C]} \quad T = 40 \text{ [°C]}$$

parameter related to air at 40 [°C] and 1 [bar]:

$$\rho = 1.0468 \text{ [kg*m}^{-3}\text{]}$$

$$\mu = 2.013 * 10^{-5} \text{ [kg*m}^{-1}\text{*s}^{-1}\text{]}$$

$$k = 2.8592 * 10^{-2} \text{ [J*s}^{-1}\text{*m}^{-1}\text{*K}^{-1}\text{]}$$

$$C_p = 1.0088 * 10^3 \text{ [J*kg}^{-1}\text{*K}^{-1}\text{]}$$

Calculation of Prandtl and Grashof's numbers for the dyeing tube:

$$N_{Pr} = (C_p * \mu) / k = 0.7102$$

$$N_{Gr} = (D^3 * \rho^2 * g * \beta * \Delta T) / \mu^2 = 9.1535 * 10^7 \quad \text{where } \beta = 1 / ((T_{\text{air}} + T_{\text{wall}}) / 2) = 3.1949 * 10^{-3} \text{ [K}^{-1}\text{]}$$

$$N_{Pr} * N_{Gr} = 6.50 * 10^7$$

$$\text{because: } 10^4 < N_{Pr} * N_{Gr} < 10^9 \quad h_m \text{ will be } = 1.3 * (\Delta T / D)^{0.25}$$

$$h_m = 1.0551 \text{ [cal*m}^{-2}\text{*s}^{-1}\text{*K}^{-1}\text{]}$$

$$\text{tube surface, } A = 2.384 \text{ [m}^2\text{]}$$

$$\Delta T = 40 \text{ [K]}$$

$$t = 3600 \text{ [s]}$$

$$Q = h_m * A * \Delta T * t = 362 \text{ [kcal]} \text{ for maintain the tube at } 60 \text{ [}^\circ\text{C]}$$

Calculation of Prandtl and Grashof's numbers for the expansion tank:

$$N_{Pr} = (C_p * \mu) / k = 0.7102$$

$$N_{Gr} = (L^3 * \rho^2 * g * \beta * \Delta T) / \mu^2 = 1.5477 * 10^9 \quad \text{where } \beta = 1 / ((T_{air} + T_{wall}) / 2) = 3.1949 * 10^{-3} \text{ [K}^{-1}\text{]}$$

$$N_{Pr} * N_{Gr} = 1.099 * 10^9$$

$$\text{because: } 10^9 < N_{Pr} * N_{Gr} < 10^{12} \quad h_m \text{ will be } = 1.8 * (\Delta T)^{0.25}$$

$$h_m = 1.0812 \text{ [cal} * \text{m}^{-2} * \text{s}^{-1} * \text{K}^{-1}\text{]}$$

$$\text{expansion tank surface, } A = 2.073 \text{ [m}^2\text{]}$$

$$\Delta T = 40 \text{ [K]}$$

$$t = 3600 \text{ [s]}$$

$$Q = h_m * A * \Delta T * t = 323 \text{ [kcal]} \text{ for maintain the expansion tank at } 60 \text{ [}^\circ\text{C]}$$

Hence, the total heat for carrying a dyeing at 60 [°C] for 60' is equal to:

$$5088 + 362 + 323 = 5773 \text{ [Kcal]} \text{ or } 24170 \text{ [kJ]}$$

*Calculation for wool fabric (density = 160 [g*m²])*

wrapping of 6.67 [kg] of fabric

liquor ratio = 1:15 for a total bath weight of 100 [kg]

$$C_p (\text{wool}) = 0.31 \text{ [kcal} * \text{kg}^{-1} * \text{K}^{-1}\text{]}$$

DYEING AT 85 [°C] FOR 90'

Heating from 20 [°C] to 85 [°C]

$$Q = M_{\text{H}_2\text{O}} * C_{p \text{ H}_2\text{O}} * \Delta T + M_{\text{steel}} * C_{p \text{ steel}} * \Delta T + M_{\text{wool}} * C_{p \text{ wool}} * \Delta T$$

where:

$$M_{\text{H}_2\text{O}} = 100 \text{ [kg]} \quad C_{p \text{ H}_2\text{O}} = 1 \text{ [kcal*kg}^{-1}\text{*K}^{-1}] \quad \Delta T = 65 \text{ [K]}$$

$$M_{\text{steel}} = 200 \text{ [kg]} \quad C_{p \text{ steel}} = 0.12 \text{ [kcal*kg}^{-1}\text{*K}^{-1}] \quad \Delta T = 65 \text{ [K]}$$

$$M_{\text{wool}} = 6.67 \text{ [kg]} \quad C_{p \text{ wool}} = 0.31 \text{ [kcal*kg}^{-1}\text{*K}^{-1}] \quad \Delta T = 65 \text{ [K]}$$

Then $Q = 8194 \text{ [kcal]}$ for heating the system from 20 [°C] to 85 [°C]

Maintenance at 85 [°C] for 90'

(dissipation by natural convection)

$$T_p = 85 \text{ [°C]} \quad T_\infty = 20 \text{ [°C]} \quad T = 52.5 \text{ [°C]}$$

parameter related to air at 52.5 [°C] and 1 [bar]:

$$\rho = 1.0702 \text{ [kg*m}^{-3}\text{]}$$

$$\mu = 1.9785 * 10^{-5} \text{ [kg*m}^{-1}\text{*s}^{-1}\text{]}$$

$$k = 2.8058 * 10^{-2} \text{ [J*s}^{-1}\text{*m}^{-1}\text{*K}^{-1}\text{]}$$

$$C_p = 1.0082 * 10^3 \text{ [J*kg}^{-1}\text{*K}^{-1}\text{]}$$

Calculation of Prandtl and Grashof's numbers for the dyeing tube:

$$N_{Pr} = (C_p * \mu) / k = 0.7109$$

$$N_{Gr} = (D^3 * \rho^2 * g * \beta * \Delta T) / \mu^2 = 1.5476 * 10^8 \quad \text{where } \beta = 1 / ((T_{\text{air}} + T_{\text{wall}}) / 2) = 3.0722 * 10^{-3} \text{ [K}^{-1}\text{]}$$

$$N_{Pr} * N_{Gr} = 1.10 * 10^8$$

$$\text{because: } 10^4 < N_{Pr} * N_{Gr} < 10^9 \quad h_m \text{ will be } = 1.3 * (\Delta T / D)^{0.25}$$

$$h_m = 1.1913 \text{ [cal*m}^{-2}\text{*s}^{-1}\text{*K}^{-1}\text{]}$$

$$\text{tube surface, } A = 2.384 \text{ [m}^2\text{]}$$

$$\Delta T = 65 \text{ [K]}$$

$$t = 5400 \text{ [s]}$$

$$Q = h_m * A * \Delta T * t = 997 \text{ [kcal]} \text{ for maintain the tube at } 85 \text{ [°C]}$$

Calculation of Prandtl and Grashof's numbers for the expansion tank:

$$N_{Pr} = (C_p \cdot \mu) / k = 0.7109$$

$$N_{Gr} = (L^3 \cdot \rho^2 \cdot g \cdot \beta \cdot \Delta T) / \mu^2 = 2.6167 \cdot 10^9 \quad \text{where } \beta = 1 / ((T_{air} + T_{wall}) / 2) = 3.0722 \cdot 10^{-3} [K^{-1}]$$

$$N_{Pr} \cdot N_{Gr} = 1.88 \cdot 10^9$$

$$\text{because: } 10^9 < N_{Pr} \cdot N_{Gr} < 10^{12} \quad h_m \text{ will be } = 1.8 \cdot (\Delta T)^{0.25}$$

$$h_m = 1.221 [cal \cdot m^{-2} \cdot s^{-1} \cdot K^{-1}]$$

$$\text{expansion tank surface, } A = 2.073 [m^2]$$

$$\Delta T = 65 [K]$$

$$t = 5400 [s]$$

$$Q = h_m \cdot A \cdot \Delta T \cdot t = 888 [kcal] \text{ for maintain the expansion tank at } 85 [^{\circ}C]$$

Hence, the total heat for carrying a dyeing at 85 [°C] for 90' is equal to:

$$8194 + 997 + 888 = 10079 [Kcal] \text{ or } 42199 [kJ]$$

Calculation for wool fabric (density = 160 [g·m²])

wrapping of 6.67 [kg] of fabric

liquor ratio = 1:15 for a total bath weight of 100 [kg]

$$C_p (\text{wool}) = 0.31 [kcal \cdot kg^{-1} \cdot K^{-1}]$$

DYEING AT 98 [°C] FOR 60'

Heating from 20 [°C] to 98 [°C]

$$Q = M_{\text{H}_2\text{O}} * C_{p \text{ H}_2\text{O}} * \Delta T + M_{\text{steel}} * C_{p \text{ steel}} * \Delta T + M_{\text{wool}} * C_{p \text{ wool}} * \Delta T$$

where:

$$M_{\text{H}_2\text{O}} = 100 \text{ [kg]} \quad C_{p \text{ H}_2\text{O}} = 1 \text{ [kcal*kg}^{-1}\text{*K}^{-1}] \quad \Delta T = 78 \text{ [K]}$$

$$M_{\text{steel}} = 200 \text{ [kg]} \quad C_{p \text{ steel}} = 0.12 \text{ [kcal*kg}^{-1}\text{*K}^{-1}] \quad \Delta T = 78 \text{ [K]}$$

$$M_{\text{wool}} = 6.67 \text{ [kg]} \quad C_{p \text{ wool}} = 0.31 \text{ [kcal*kg}^{-1}\text{*K}^{-1}] \quad \Delta T = 78 \text{ [K]}$$

Then $Q = 9833$ [kcal] for heating the system from 20 [°C] to 98 [°C]

Maintenance at 98 [°C] for 60'

(dissipation by natural convection)

$$T_p = 98 \text{ [°C]} \quad T_\infty = 20 \text{ [°C]} \quad T = 59 \text{ [°C]}$$

parameter related to air at 59 [°C] and 1 [bar]:

$$\rho = 1.04992 \text{ [kg*m}^{-3}\text{]}$$

$$\mu = 2.0084 * 10^{-5} \text{ [kg*m}^{-1}\text{*s}^{-1}\text{]}$$

$$k = 2.85208 * 10^{-2} \text{ [J*s}^{-1}\text{*m}^{-1}\text{*K}^{-1}\text{]}$$

$$C_p = 1.00872 * 10^3 \text{ [J*kg}^{-1}\text{*K}^{-1}\text{]}$$

Calculation of Prandtl and Grashof's numbers for the dyeing tube:

$$N_{Pr} = (C_p * \mu) / k = 0.7103$$

$$N_{Gr} = (D^3 * \rho^2 * g * \beta * \Delta T) / \mu^2 = 1.5476 * 10^8 \quad \text{where } \beta = 1 / ((T_{\text{air}} + T_{\text{wall}}) / 2) = 3.0120 * 10^{-3} \text{ [K}^{-1}\text{]}$$

$$N_{Pr} * N_{Gr} = 1.700 * 10^8$$

$$\text{because: } 10^4 < N_{Pr} * N_{Gr} < 10^9 \quad h_m \text{ will be } = 1.3 * (\Delta T / D)^{0.25}$$

$$h_m = 1.2468 \text{ [cal*m}^{-2}\text{*s}^{-1}\text{*K}^{-1}\text{]}$$

$$\text{tube surface, } A = 2.384 \text{ [m}^2\text{]}$$

$$\Delta T = 78 \text{ [K]}$$

$$t = 3600 \text{ [s]}$$

$$Q = h_m * A * \Delta T * t = 835 \text{ [kcal]} \text{ for maintain the tube at } 98 \text{ [°C]}$$

Calculation of Prandtl and Grashof's numbers for the expansion tank:

$$N_{Pr} = (C_p \cdot \mu) / k = 0.7109$$

$$N_{Gr} = (L^3 \cdot \rho^2 \cdot g \cdot \beta \cdot \Delta T) / \mu^2 = 2.6167 \cdot 10^9 \quad \text{where } \beta = 1 / ((T_{air} + T_{wall}) / 2) = 3.0120 \cdot 10^{-3} [K^{-1}]$$

$$N_{Pr} \cdot N_{Gr} = 2.8754 \cdot 10^9$$

$$\text{because: } 10^9 < N_{Pr} \cdot N_{Gr} < 10^{12} \quad h_m \text{ will be } = 1.8 \cdot (\Delta T)^{0.25}$$

$$h_m = 1.221 [cal \cdot m^{-2} \cdot s^{-1} \cdot K^{-1}]$$

$$\text{expansion tank surface, } A = 2.073 [m^2]$$

$$\Delta T = 78 [K]$$

$$t = 3600 [s]$$

$$Q = h_m \cdot A \cdot \Delta T \cdot t = 744 [kcal] \text{ for maintain the expansion tank at } 98 [^{\circ}C]$$

Hence, the total heat for carrying a dye at 85 [°C] is equal to:

$$9833 + 835 + 744 = 11412 [Kcal] \text{ or } 47778 [kJ]$$

Calculation of Prandtl and Grashof's numbers for the dyeing tube:

$$N_{Pr} = (C_p \cdot \mu) / k = 0.7109$$

$$N_{Gr} = (D^3 \cdot \rho^2 \cdot g \cdot \beta \cdot \Delta T) / \mu^2 = 1.5476 \cdot 10^8 \quad \text{where } \beta = 1 / ((T_{air} + T_{wall}) / 2) = 3.0722 \cdot 10^{-3} [K^{-1}]$$

$$N_{Pr} \cdot N_{Gr} = 1.10 \cdot 10^8$$

$$\text{because: } 10^4 < N_{Pr} \cdot N_{Gr} < 10^9 \quad h_m \text{ will be } = 1.3 \cdot (\Delta T / D)^{0.25}$$

$$h_m = 1.1913 [cal \cdot m^{-2} \cdot s^{-1} \cdot K^{-1}]$$

$$\text{tube surface, } A = 2.384 [m^2]$$

$$\Delta T = 65 [K]$$

$$t = 5400 [s]$$

$$Q = h_m \cdot A \cdot \Delta T \cdot t = 997 [kcal] \text{ for maintain the tube at } 85 [^{\circ}C]$$

Calculation of Prandtl and Grashof's numbers for the expansion tank:

$$N_{Pr} = (C_p \cdot \mu) / k = 0.7109$$

$$N_{Gr} = (L^3 \cdot \rho^2 \cdot g \cdot \beta \cdot \Delta T) / \mu^2 = 2.6167 \cdot 10^9 \quad \text{where } \beta = 1 / ((T_{air} + T_{wall}) / 2) = 3.0722 \cdot 10^{-3} [K^{-1}]$$

$$N_{Pr} * N_{Gr} = 1.88 * 10^9$$

because: $10^9 < N_{Pr} * N_{Gr} < 10^{12}$ h_m will be = $1.8 * (\Delta T)^{0.25}$

$$h_m = 1.221 \text{ [cal} * \text{m}^{-2} * \text{s}^{-1} * \text{K}^{-1}\text{]}$$

expansion tank surface, $A = 2.073 \text{ [m}^2\text{]}$

$$\Delta T = 65 \text{ [K]}$$

$$t = 5400 \text{ [s]}$$

$$Q = h_m * A * \Delta T * t = 888 \text{ [kcal]} \text{ for maintain the expansion tank at } 85 \text{ [}^\circ\text{C]}$$

Hence, the total heat for carrying a dyeing at $85 \text{ [}^\circ\text{C]}$ for 90' is equal to:

$$8194 + 997 + 888 = 10079 \text{ [Kcal]} \text{ or } 42199 \text{ [kJ]}$$

*Calculation for cotton fabric (density = $160 \text{ [g} * \text{m}^2\text{])}$*

wrapping of 6.67 [kg] of fabric

liquor ratio = 1:15 for a total bath weight of 100 [kg]

$$C_p \text{ (cotton)} = 0.32 \text{ [kcal} * \text{kg}^{-1} * \text{K}^{-1}\text{]}$$

DYEING AT 60 [°C] FOR 60'

Heating from 20 [°C] to 60 [°C]

$$Q = M_{H_2O} * C_{p_{H_2O}} * \Delta T + M_{steel} * C_{p_{steel}} * \Delta T + M_{cotton} * C_{p_{cotton}} * \Delta T$$

where:

$$M_{H_2O} = 100 \text{ [kg]} \quad C_{p_{H_2O}} = 1 \text{ [kcal*kg}^{-1}\text{*K}^{-1}\text{]} \quad \Delta T = 40 \text{ [K]}$$

$$M_{steel} = 200 \text{ [kg]} \quad C_{p_{steel}} = 0.12 \text{ [kcal*kg}^{-1}\text{*K}^{-1}\text{]} \quad \Delta T = 40 \text{ [K]}$$

$$M_{cotton} = 6.67 \text{ [kg]} \quad C_{p_{cotton}} = 0.32 \text{ [kcal*kg}^{-1}\text{*K}^{-1}\text{]} \quad \Delta T = 40 \text{ [K]}$$

Then Q = 4960 [kcal] for heating the system from 20 [°C] to 60 [°C]

Maintenance at 60 [°C] for 60'

(dissipation by natural convection)

$$T_p = 60 \text{ [°C]} \quad T_\infty = 20 \text{ [°C]} \quad T = 40 \text{ [°C]}$$

parameter related to air at 40 [°C] and 1 [bar]:

$$\rho = 1.0468 \text{ [kg*m}^{-3}\text{]}$$

$$\mu = 2.013 * 10^{-5} \text{ [kg*m}^{-1}\text{*s}^{-1}\text{]}$$

$$k = 2.8592 * 10^{-2} \text{ [J*s}^{-1}\text{*m}^{-1}\text{*K}^{-1}\text{]}$$

$$C_p = 1.0088 * 10^3 \text{ [J*kg}^{-1}\text{*K}^{-1}\text{]}$$

Calculation of Prandtl and Grashof's numbers for the dyeing tube:

$$N_{Pr} = (C_p * \mu) / k = 0.7102$$

$$N_{Gr} = (D^3 * \rho^2 * g * \beta * \Delta T) / \mu^2 = 9.1535 * 10^7 \quad \text{where } \beta = 1 / ((T_{air} + T_{wall}) / 2) = 3.1949 * 10^{-3} \text{ [K}^{-1}\text{]}$$

$$N_{Pr} * N_{Gr} = 6.50 * 10^7$$

$$\text{because: } 10^4 < N_{Pr} * N_{Gr} < 10^9 \quad h_m \text{ will be } = 1.3 * (\Delta T / D)^{0.25}$$

$$h_m = 1.0551 \text{ [cal*m}^{-2}\text{*s}^{-1}\text{*K}^{-1}\text{]}$$

$$\text{tube surface, } A = 2.384 \text{ [m}^2\text{]}$$

$$\Delta T = 40 \text{ [K]}$$

$$t = 3600 \text{ [s]}$$

$$Q = h_m * A * \Delta T * t = 362 \text{ [kcal]} \text{ for maintain the tube at } 60 \text{ [°C]}$$

Calculation of Prandtl and Grashof's numbers for the expansion tank:

$$N_{Pr} = (C_p * \mu) / k = 0.7102$$

$$N_{Gr} = (L^3 * \rho^2 * g * \beta * \Delta T) / \mu^2 = 1.5477 * 10^9 \quad \text{where } \beta = 1 / ((T_{air} + T_{wall}) / 2) = 3.1949 * 10^{-3} [K^{-1}]$$

$$N_{Pr} * N_{Gr} = 1.099 * 10^9$$

$$\text{because: } 10^9 < N_{Pr} * N_{Gr} < 10^{12} \quad h_m \text{ will be } = 1.8 * (\Delta T)^{0.25}$$

$$h_m = 1.0812 [\text{cal} * \text{m}^{-2} * \text{s}^{-1} * \text{K}^{-1}]$$

$$\text{expansion tank surface, } A = 2.073 [\text{m}^2]$$

$$\Delta T = 40 [\text{K}]$$

$$t = 3600 [\text{s}]$$

$$Q = h_m * A * \Delta T * t = 323 [\text{kcal}] \text{ for maintain the expansion tank at } 60 [^{\circ}\text{C}]$$

Hence, the total heat for carrying a dyeing at 60 [°C] for 60' is equal to:

$$4960 + 362 + 323 = 5322 [\text{Kcal}] \text{ or } 22282 [\text{kJ}]$$

It can therefore be argued that while the conventional dyeing (10 [kg] of wool yarn $N_m = 2/28$) conducted at 98 °C for 60' requires 48119 [kJ]; a UV-pretreatment lowers the dyeing temperature to 85 °C, increasing at 90' the dyeing time and consuming 42479 [kJ]. This value must, however, add up the energy to UV irradiation, resulting from the following calculations:

$$1 [\text{kg}] : 14000 [\text{m}] = 10 [\text{kg}] : x [\text{m}] \quad x = 140000 [\text{m}] \text{ of yarn feeding}$$

the Filidea's machine can work with a maximum of 48 bobbins, then:

$$140000 / 48 = 2917 [\text{m}] \text{ for each of 48 bobbins}$$

$$\text{optimal speed treatment} = 2 [\text{m}] / ' \quad \text{with a power lamp of } 2200 [\text{w}]$$

$$2917 [\text{m}] / 2 [\text{m}] / ' = 1458.5' \text{ or } 87510 [\text{s}] \text{ time necessary for UV-treatment}$$

$$87510 [\text{s}] * 2200 [\text{J} * \text{s}^{-1}] = 192522 [\text{J}] \text{ energy for the treatment of } 10 [\text{kg}] \text{ of wool yarn}$$

The energy required for UV-treatment is about 4.5 times the dyeing energy; the energetic cost becomes too high and not affordable (total cost = 23500 [J] for each [kg] of wool yarn).

Likewise can be argued that conventional dyeing (10 [kg] of cotton yarn $N_m = 2/28$) conducted at 60 °C for 60' requires 24170 [kJ]; a UV-posttreatment does not lowers the dyeing temperature and does not modify the time. This value must, however, add up the energy to UV irradiation, resulting from the following calculations:

$$1 \text{ [kg]} : 14000 \text{ [m]} = 10 \text{ [kg]} : x \text{ [m]} \quad x = 140000 \text{ [m]} \text{ of yarn feeding}$$

the Filidea's machine can work with a maximum of 48 bobbins, then:

$$140000/48 = 2917 \text{ [m]} \text{ for each of 48 bobbins}$$

$$\text{optimal speed treatment} = 2 \text{ [m]}' \quad \text{with a power lamp of 2200 [w]}$$

$$2917 \text{ [m]} / 2 \text{ [m]}' = 1458.5' \text{ or } 87510 \text{ [s]} \text{ time necessary for UV-treatment}$$

$$87510 \text{ [s]} * 2200 \text{ [J*s}^{-1}] = 192522 \text{ [J]} \text{ energy for the treatment of 10 [kg] of cotton yarn}$$

The energy required for UV-treatment is about 8 times the dyeing energy; the energetic cost becomes too high and not affordable (total cost = 21669 [J] for each [kg] of cotton yarn).

For UV-treatment on wool fabric (density = 160 [g/m²]) the conclusions are as follows:

6670 [g] fabric weight

$$6670 \text{ [g]} / 160 \text{ [g/m}^2] = 41.7 \text{ [m}^2] \quad \text{fabric surface under treatment}$$

$$1.20 \text{ [m]} \quad \text{height of the fabric}$$

$$41.7 \text{ [m}^2] / 1.20 \text{ [m]} = 34.8 \text{ [m]} \quad \text{length of the fabric}$$

At TMT plant, the UV machine has a power lamp of 18000 [w],

$$\text{and with a optimal speed treatment} = 2 \text{ [m]}' \quad \text{with a power lamp of 18000 [w]}$$

$$34.8 \text{ [m]} / 2 \text{ [m]}' = 17.4' \text{ or } 1044 \text{ [s]} \text{ time necessary for UV-treatment}$$

$$18000 \text{ [J*s}^{-1}] * 1044 \text{ [s]} = 18792 \text{ [kJ]} \text{ energy for the treatment of 6.67 [kg] of wool fabric}$$

The energy required for UV-treatment is less than half the dyeing energy; the energetic cost it is not so high and becomes affordable (total cost = 9144 [J] for each [kg] of wool fabric).

Likewise, for UV-treatment on cotton fabric (density = 160 [g/m²]) the conclusions are as follows:

6670 [g] fabric weight

$$6670 \text{ [g]} / 160 \text{ [g/m}^2] = 41.7 \text{ [m}^2] \quad \text{fabric surface under treatment}$$

1.20 [m] height of the fabric

$41.7 \text{ [m}^2\text{]}/1.20 \text{ [m]} = 34.8 \text{ [m]}$ length of the fabric

At TMT plant, the UV machine has a power lamp of 18000 [w],

and with a optimal speed treatment = 2 [m/'] with a power lamp of 18000 [w]

$34.8 \text{ [m]}/2 \text{ [m/']} = 17.4'$ or 1044 [s] time necessary for UV-treatment

$18000 \text{ [J*s}^{-1}\text{]}\cdot 1044 \text{ [s]} = 18792 \text{ [kJ]}$ energy for the treatment of 6.67 [kg] of cotton fabric

The energy required for UV-treatment is less than the dyeing energy (84%); the energetic cost it is not so high and becomes affordable (total cost = 6158 [J] for each [kg] of cotton fabric).

11.4 References

- [1] D. M. Grossman, "Errors Caused by Using Joules to Time Laboratory and Outdoor Exposure Tests", Accelerated and Outdoor Durability Testing of Organic Materials, ASTM STP 1202, Warren D. Ketola, and Douglas Grossman, Eds., American Society for Testing and Materials, Philadelphia, 1993.
- [2] L. Rondolotto, "Perché il peso condizionato?", Massa Commerciale – Invoice Weight – Condizionatura Pubblica di Biella, 1988.

Conclusions

Wool and cotton fibres were successfully modified by UV treatments in order to achieve differential dyeings.

In particular, the study was focused on fibres-UV radiations interactions, aimed at new chromatic effects on different textile substrates (mainly wool and cotton), and improvement of dyeability conferred by UV-treatment on wool (low dyeing temperature).

UV-pretreatment on wool fibres change their affinity towards dyestuffs increasing the default value; good results were obtained with reactive dyes, 1:2 metal-complex dyes and acid milling dyes, but best results are get using 1:1 metal-complex dyes.

On cotton fibres instead UV-pretreatment does not substantially change the dyeing affinity, but UV-posttreatment is capable to fade the dyeing, allowing the obtaining of chromatic effects (like sun bleached effects).

These application techniques of UV radiation on yarns and fabrics gave encouraging results as regards the chromatic effects achievable; with suitable UV-pretreatment it is possible in fact to achieve effects of different colour intensity between UV-irradiated side and untreated one (light / dark in tone), or the effects of light and dark tones with different colours of wool (both in yarn and in the fabric). On cotton the results of differential dyeing are made by UV- posttreatment conduct on traditional dyeings performed with selected reactive dyes (both of yarn that on fabric).

For proteic fibres, after the UV-pretreatment, is executable a dyeing with maximum temperature of 85 °C (instead of 98 °C) with equal properties of tone uniformity and equal color fastnesses (machine washing and dry rubbing), together with a convenient reduced degradation of wool fibre, which then undergoes a little thermal deterioration, with better preservation of its intrinsic properties during the textile ennoblement.

The energy balances shows a substantial disparity in the case of UV-treatments on yarn of ordinary fineness (both wool and cotton yarns) conducted on the existing prototype machinery at Filidea factory; the innovative effects obtained by application of ultraviolet radiation on yarns needs technological alternative solutions respect to those currently available, in order to compete with conventional processes. Different speech must be done for UV-treatments on fabrics (always on both wool and cotton), in which the energy balances are slightly unfavorable to conventional ennoblement techniques, however, the possibility of realizing these chromatic effects of differential dyeing compensate and justify abundantly the energy increase for these application techniques.

Instead, it will be necessary to evaluate the possibility of making amendments to existing machines to the companies rather than the construction of new plants for radiations treatments, evaluating each time, what is the ratio cost/benefit, according to the company policies and to market trend, related at the temporary fashion.