

Transport and energy in India. Energy used by Indian transport systems and consequent emissions: the need for quantitative analyses (Well-to-Wheel, Lifecycle)

*Original*

Transport and energy in India. Energy used by Indian transport systems and consequent emissions: the need for quantitative analyses (Well-to-Wheel, Lifecycle) / Pant, K.; Pinna, Ivano; DALLA CHIARA, Bruno; Bensaid, Samir. - ELETTRONICO. - I:(2013), pp. 1-51.

*Availability:*

This version is available at: 11583/2507787 since:

*Publisher:*

EBTC - European Business and Technology Center

*Published*

DOI:

*Terms of use:*

This article is made available under terms and conditions as specified in the corresponding bibliographic description in the repository

*Publisher copyright*

(Article begins on next page)

# Report on **TRANSPORT AND ENERGY IN INDIA**

**ENERGY USED BY INDIAN TRANSPORT SYSTEMS AND CONSEQUENT EMISSIONS:  
THE NEED FOR QUANTITATIVE ANALYSES (WELL-TO-WHEEL, LIFECYCLE)**

POLITECNICO DI TORINO

synergic collaboration of Transport Engineering, Energy and Chemical Engineering domains

**MARCH 2013**

# ENERGY USED BY INDIAN TRANSPORT SYSTEMS AND CONSEQUENT EMISSIONS: THE NEED FOR QUANTITATIVE ANALYSES (WELL-TO-WHEEL, LIFECYCLE)

---

## Contents (2012)

Transport Engineering Area

- K. PANT, B.D. at the IIT-Bombay (India), Internship in 2012 at the Politecnico di Torino (Italy)
- I. PINNA, Fellow Researcher, Politecnico di Torino (Italy)
- B. DALLA CHIARA, Associate Professor, Politecnico di Torino (Italy)

Chemical Engineering Area

- S. BENSAID, Assistant Professor, Politecnico di Torino (Italy)

## Contributions (2012)

Transport Engineering Area

- S. L. DHINGRA, Institute Chair Professor, Emeritus Fellow of IITB, IIT-Bombay (India)

Project management

- I. MAROCCO, Fellow Researcher, Politecnico di Torino (Italy)

## Revision (2012-2013)

Transport Engineering Area

- B. DALLA CHIARA, Associate Professor, Politecnico di Torino (Italy)

Energy Engineering Area

- E. SPESSA, Associate Professor, Professor Politecnico di Torino (Italy)

Chemical Engineering Area

- G. SARACCO, Full Professor, Politecnico di Torino (Italy)

## Proof-reading (2013)

- C. MERCUGLIANO, Politecnico di Torino (Italy)

## Editing (2013)

- L. MONTOBBIO, Politecnico di Torino (Italy)

March 2013

prepared during the period April 2012 – February 2013

The present technical report has been realised in the frame of the European Business and Technology Centre in India (EBTC) project.

The European Business and Technology Centre helps industry, technology, science and research community in Europe and India, generating new business opportunities and encouraging cooperation. The Centre works closely with other existing networks, initiatives, partners and institutions, with a focused knowledge of Indian market sectors such as biotechnology, energy, environment, transport and trade.

For the purpose, Politecnico di Torino's technical staff availed itself of the Indian Institute of Technology of Mumbai collaboration, in particular Prof. Sunderlall Dhingra, Director of the Department dealing with Transport and Infrastructures, and one of its Indian collaborators, Miss Karishma Pant.

In partnership with the Indo-Italian Chamber of Commerce and Industry (IICCI), the International Conference on "Use of energy and emissions by the Indian Transport System: European experiences and future challenges for Indian mobility and logistics" was held on 12<sup>th</sup> of October, 2012 at the EBTC head office in New Delhi (India). Outputs from this event and some suggestions received from attendees are integrated into the report.

## **AIMS**

---

The purpose of this work is, at first, a general overview on the state-of-art of the transportation system in India outlining the related energy consumption, for the different transport modes, with consequent estimated emissions. These elements are essential for the preparation of a high-level strategic transport planning on the whole energy issue, to help India in the choices of most suitable transportation systems, according to the well-to-wheel analysis (WTW). Pursuing a WTW global index for India that takes into account both the energy and environmental aspects on a uniform basis is an important aim: it allows the best choices to be made as well as enabling the comparison between some of the most important powertrain and fuel options on the Indian market, the results are discussed from three different points of view: energy, environmental and economic impact.

# INDEX

---

## I PART

### STATE OF ART OF THE TRANSPORTATION SYSTEM IN INDIA

1	Introduction	6
2	Urban population in India	7
3	World production and circulation of vehicles	8
4	Registered motor vehicles in India	10
5	Compound annual growth rate	11
6	Effect of GDP	13
7	Transport by mode	14
8	Transport and energy	15
9	The effect of price	16
10	Gasoline and diesel transport consumption	16
11	Energy projection in transportation sector	18
12	Carbon dioxide emissions	19
13	Pollutant emissions from motor vehicles	24
14	Generation of electricity for transport systems	25
15	Energy consumption by indian railways	27
16	Compressed natural gas (CNG)	30
17	Biofuels	32

## II PART

### MEASURABLE ANALYSES: WELL-TO-WHEEL AND LIFECYCLE

18	Introduction to measurable analyses	38
19	Methodology for the WTW	39
20	Calculations	43
21	Suggestions	46
22	Final remarks	47
23	Conclusions	49
24	Bibliography	49

# I PART

## A SHORT STATE OF THE ART OF THE TRANSPORTATION SYSTEM IN INDIA

## 1. INTRODUCTION

The transport system is essential for the conveyance of goods and the motorised mobility of people across the country. Beside personal communications, it facilitates access of people to a wide range of economic and social services which are fundamental also for the well-being of the population. It is a key factor to social, regional and economic cohesion, including the development of rural areas.

Growth in personal relationships, in the economic activity and the population itself are the key factors that determine **energy demand in the transportation sector**. In developing economies, like India, increased economic activity leads to growing income per capita; as standards of living rise, demand for personal transportation increases: **from a non-motorised mobility to a motorised one**. This can be seen also from some images, as below (Figure 1, Figure 2).

From the **energy supply** viewpoint, uncertainty about the availability and security of oil supplies, the prospect of rising oil prices and environmental concerns about emissions are the major challenges. Market forces and government policies could drive the development of **highly efficient** vehicle technologies and of the transport systems itself, with the potential to alter future demand for transportation fuels, reduce emissions, improve energy security and provide significant energy savings. Widespread adoption of alternative **vehicle and transport technologies**, combined with expansion of **mass transit** infrastructure and **personal mobility**, could be an attractive option for long term development of the whole transportation sector.

The reason for the traffic congestion in the above picture is **saturation of land** and **limitedness of space**

*Figure 1: Traffic stands clogged near Connaught place, New Delhi*



Figure 2: Concentration of traffic in metropolitan cities of India



Delhi



Mumbai

Figure 3: Evolution of Traffic in Mumbai over the years



1960



Nowadays

The same thing – i.e., the evolution of motorised mobility and the consequent rise of traffic – happened in Europe, but over a longer period of time, almost over one century. Therefore, cities need to be re-conceived and the following element needs to be included: **high level transport plans, based on the sharing of space and energy resources**

## 2. URBAN POPULATION IN INDIA

India is the *second most populous country in the world*, with over 1.21 billion people – according to the census of 2011 – more than a sixth of the world's population. India is projected to become the world's most populous country by 2025, surpassing China, according to present trends and projections.

As it can be seen in the graph of Figure 4, the **level of urbanization** – i.e. inhabitants living in urban areas – has increased from 27.81% in 2001 to 31.16% in 2011. Migration to major cities caused rapid increase in urban population. According to some documents by United Nations and the International Energy Agency, India will probably witness the largest increase in urban population in the next four decades followed by China. The urban population represented nearly 51% of the world population in 2010. The urbanisation level is quite



high in Europe (nearly 75%) and in the American continent (82% in North-America, 79% in Latin America). This level of urbanisation will probably increase slightly in these regions until 2025.

On the contrary, the level of urbanisation will probably grow much more in the Sub-Saharan Africa and Asia-Pacific area where, at present, it is relatively low (37% Sub-Saharan-Africa, 43% Asia-Pacific).

The maximum growth of the population, in absolute terms, will probably take place in Asian-Pacific cities, which will represent – according to present hypotheses – nearly 50% of the world population in 2025.

Figure 4: Growth of Urban Population in India over the years (1951-2011)

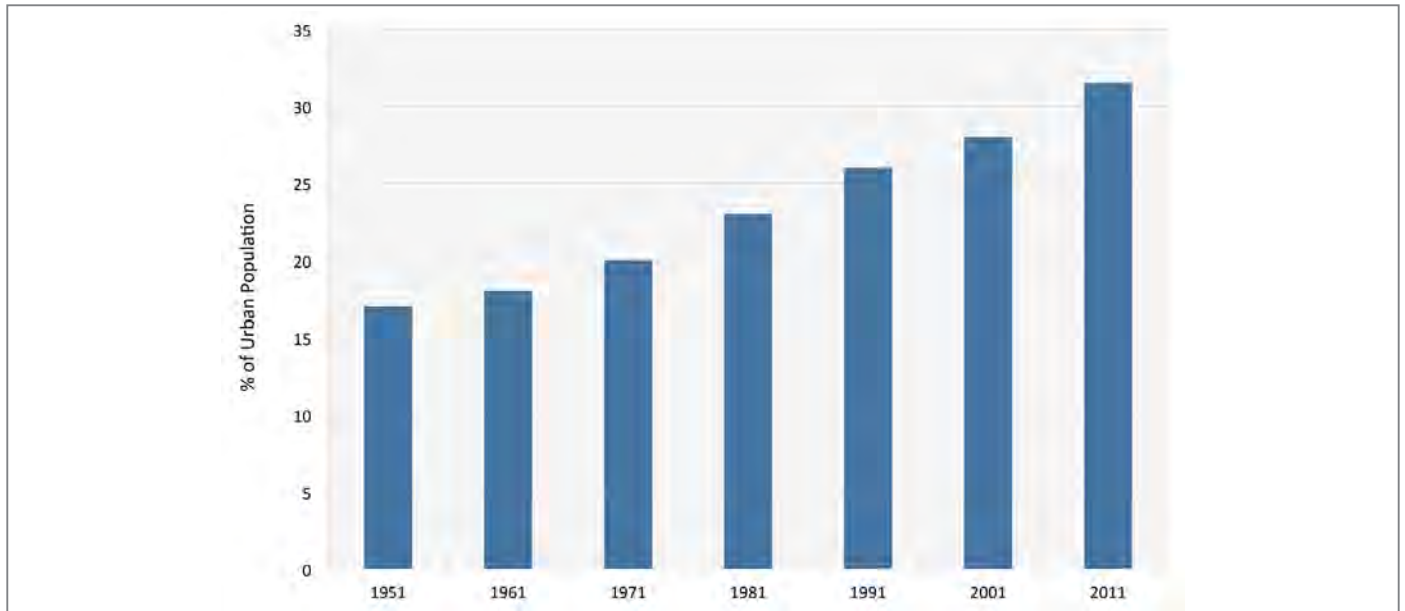

Source: Oct 2011, Central Statistics Office, Govt. of India, [www.mospi.gov.in](http://www.mospi.gov.in)

### 3. WORLD PRODUCTION AND CIRCULATION OF VEHICLES

If we consider the **circulating vehicles**, in the second half of the 20<sup>th</sup> century, the number of cars in the European countries has witnessed continuous growth: a moderately increasing trend from the second half of the nineteen forties to the first half of the nineteen sixties (approximately 1,980,000 in 1960, Italy, e.g.), and then a significantly faster one – as an average – in the nineteen seventies and eighties (approximately 17,700,000 in 1980, Italy), which would then progressively decrease, in terms of growth, in the nineteen nineties. In Italy, the circulating fleet has now reached a trend which converges towards – indicatively – forty-two million vehicles; at the end of the first four years of the 21<sup>st</sup> century, approximately 33,000,000 million cars were counted, a value which can be roughly derived from the owners of a driving licence as well as to the potential drivers, taking into consideration the share of the population which is not authorized to drive or is not able to drive because of age, physical, psychological, economic limits and the like. In Italy the number of light and heavy-duty vehicle **registrations** has remained approximately consistent with the one of the last 6 to 7 years, i.e. approximately 3 million units. In the last twelve years, the number of car registrations has shown an oscillating trend around 2 to 2.5 million. The status in the *other main European countries* is indicatively the same. The reduction of the growth since the second half of the nineteen nineties is in any case obvious. The saturation of the markets can also be seen in the other main European countries.

However, if the scenario of the circulating fleet in the European countries, which is obviously not exhaustive as related to the issue of energy consumption, shows a trend towards market **saturation**, the conditions are far different when we observe the **world panorama**; from an estimate of 216,608,470 vehicles in 1968 (169,994,128 cars, 46,614,342 heavy-duty vehicles), we have passed to approximately 484,000,000 in 1985 (375,000,000 cars, 109,000,000 heavy-duty vehicles) and to approximately 671,358,000 in 1996 (485,954,000 cars, 185,404,000 heavy-duty vehicles). Nowadays, however, approximately 176.5 million circulating vehicles

out of the 806 million ones in the whole world (2007/08), are circulating in the sole China (from the competent Ministry, 2008), a figure which represents approximately 21% of the circulating fleet the world over.

Table 1 reports the world production of cars and trucks, in 2000 and in 2010 (in thousands).

*Table 1: World Production of cars and trucks, 2000 - 2010 (in thousands) and relative change (%)*

<b>Cars</b>	<b>2000</b>	<b>2010</b>	<b>Percent change 2000-2010</b>
China	605	9,494	1470%
Japan	8,363	8,307	-1%
Germany	5,132	5,552	8%
Brazil	1,362	2,828	108%
U.S.	5,542	2,731	-51%
India	605	2,317	283%
Spain	2,366	1,951	-18%
France	2,880	1,914	-34%
Mexico	1,130	1,386	23%
UK	1,641	1,274	-22%
Russia	969	1,208	25%
Czech Republic	428	1,070	150%
All other countries	10,205	11,006	8%
Total world	41,229	51,040	24%

<b>Trucks</b>	<b>2000</b>	<b>2010</b>	<b>Percent change 2000-2010</b>
China	1,464	8,771	499%
U.S.	7,263	5,012	-31%
South Korea	513	1,480	188%
Japan	1,781	1,319	-26%
India	283	1,237	336%
Canada	1,411	1,101	-22%
Thailand	315	1,091	247%
All other countries	4,685	5,226	12%
Total world	17,717	25,236	42%

Source: Ward's Communications, Ward's World Motor Vehicle Data, 2011 Edition Southfield, MI, 2010, pp. 265-271 and annual

*Table 2: Vehicles per thousand people in main countries or areas, 2000 and 2010*

<b>Country / Region</b>	<b>Vehicles per 1,000 people</b>	
	<b>2000</b>	<b>2010</b>
Africa	23.1	29.9
Asia, Far East	39.8	66.7
Asia, Middle East	92.2	106.2
Brazil	109.5	159.6
Canada	565.0	623.6
Central & South America	107.0	150.4
China	10.6	58.7
Europe, East	200.7	321.8

Country / Region	Vehicles per 1,000 people	
	2000	2010
Europe, West	540.7	587.2
India	7.5	17.7
Indonesia	14.1	77.8
Pacific	456.0	565.3

Sources: Population (2010) U.S Census Bureau, Population Division, International DataBase (IDB) World, April 18,2012; Vehicles (2010) U.S Department of Transportation, Federal Highway Administration, Highway Statistics 2010, Washington DC 2012; All others: Ward's Communications, Ward's Motor Vehicle Data 2011

NOTE: Though some countries are listed separately in this table, those countries are also included in the regional total. For instance, China is listed separately, but is also included in the Asia, Far East region.

Therefore, the question arising is: **which level of penetration of private cars should we expect in India?**

## 4. REGISTERED MOTOR VEHICLES IN INDIA

In India, personalised motorised mobility – satisfied mainly by *two wheelers* and passenger cars – accounted for more than four-fifth of the motor vehicle population in the country compared to their share of little over three-fifth in 1951. Two-wheelers account for about 72%, followed by passenger cars at 13.3% and other vehicles at 8.4%. At lower levels of income, 2-wheelers is an affordable and cost effective means of personalised mobility. In contrast to personalised mode, the share of *buses* in total registered vehicles has declined from 11.1% in 1951 to a mere 1.3% in 2009. The erosion of share of buses in the vehicle population reflects slow growth in public passenger bus transport services.

Table 3: India: composition of the overall fleet of vehicles (% of total)

Year end	Two Wheelers	Cars, Jeeps & Taxis etc.	Buses	Goods Vehicle	Others Vehicles	Total
March	(as % age of total vehicle population)					(Million)
1951	8.8	52	11.1	26.8	1.3	0.31
1961	13.2	46.6	8.6	25.3	6.3	0.66
1971	30.9	36.6	5.0	18.4	9.1	1.86
1981	48.6	21.5	3.0	10.3	16.6	5.39
1991	66.4	13.8	1.5	6.3	11.9	21.37
2001	70.1	12.8	1.2	5.4	10.5	54.99
2002	70.6	12.9	1.1	5.0	10.4	58.92
2003	70.9	12.8	1.1	5.2	10.0	67.01
2004	71.4	13.0	1.1	5.2	9.4	72.72
2005	72.1	12.7	1.1	4.9	9.1	81.5
2006	72.2	12.9	1.1	4.9	8.8	89.61
2007	71.5	13.1	1.4	5.3	8.7	96.69
2008	71.5	13.2	1.4	5.3	8.6	105.33
2009 (p)	71.7	13.3	1.3	5.3	8.4	115.0

Note: Two wheelers with engines

Source: March 2011, Ministry of Road Transport and Highways

The published EBCT data referred to 2008-2009 are in line with these figures. With a rising income and greater indexed need for motorised mobility, the personalised mode of transport is likely to grow in importance in the coming years. The chart in Figure 5 indicates that the share of 2-Wheeler population shows a steep rise.

Figure 5: Growth of the number of registered vehicles over the years in India

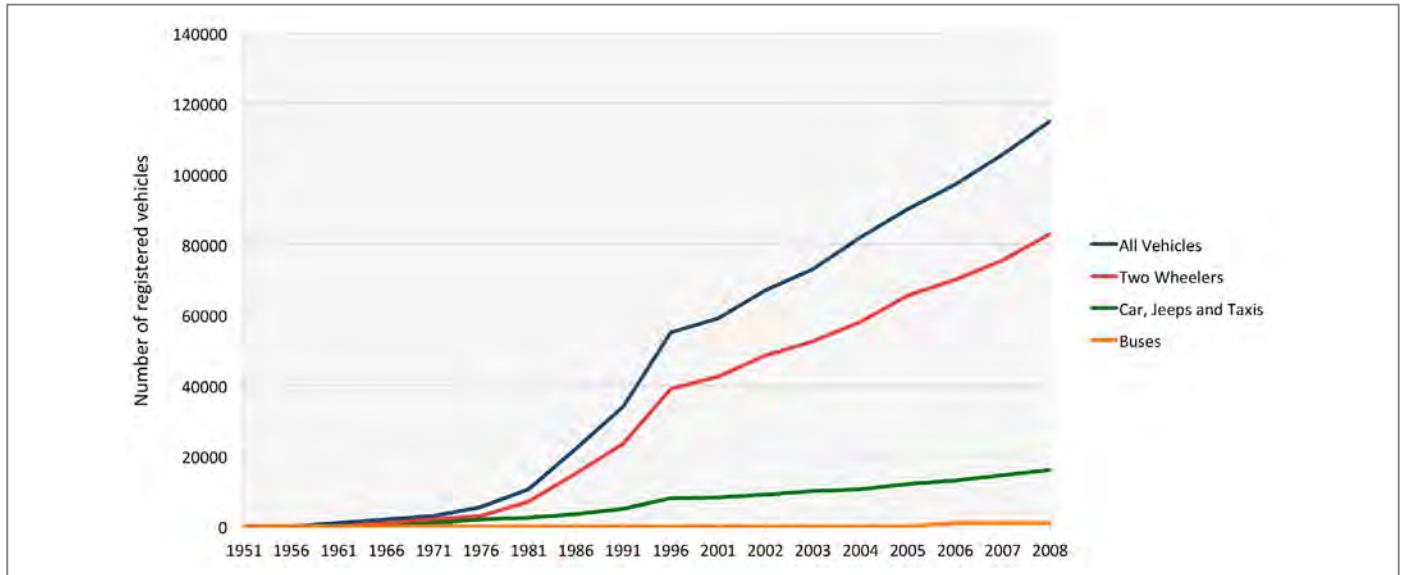

## 5. COMPOUND ANNUAL GROWTH RATE

The total registered vehicles in the country grew at a Compound Annual Growth Rate (CAGR) of 9.8% between 1991 and 2009. Two wheelers and cars grew at a CAGR 10.3% and 9.6% respectively, which was higher if compared to the growth in buses (8.7%).

The higher growth in personalised motor vehicles reflects rising disposable income and, most probably, the **easing of supply side restraints** (delicensing of automobile sector leading to the entry of vehicle manufacturers, lifting of Quantitative Restrictions, etc.) parallel to the **increase of road infrastructures**.

This recalls the *Braess's Paradox*:

**increase of supply  $\equiv$  increase of demand.**

Table 4: Compound Annual Growth Rates (in %) in vehicles and road extension or length

Period	Vehicles						Roads					
	Two-Wheelers	Cars, Jeeps & Taxis	Buses	Goods Vehicles	Others*	Total	NHs	SHs & PWD	Rural	Urban	Project	Total
2009/1951	14.8	8.2	6.7	7.7	14.4	10.8	2.2	3.2#	4.5#		4.2#	-
1961/1951	12.5	6.9	5.3	7.4	26.5	8.1	1.9	4	-	-	-	2.7
1971/1961	20.7	8.2	5.1	7.4	15	10.9	0	2.6	6.0	4.5	-	5.7
1981/1971	16.3	5.4	5.6	4.9	18.1	11.2	2.9	4.5	5.9	5.5	3.5	5
1991/1981	18.4	9.8	7.4	9.4	10.9	14.8	0.6	2.1	4	4.3	1.2	3

Period	Vehicles						Roads					
	Two-Wheelers	Cars, Jeeps & Taxis	Buses	Goods Vehicles	Others*	Total	NHs	SHs & PWD	Rural	Urban	Project	Total
2001/1991	10.5	9.1	6.7	8.1	8.6	9.9	5.5	3.1	1.4	3	0.6	2.1
2007/1991	10.4	9.5	9.2	8.7	7.8	9.9	4.4	2.8	4.1	3	1.6	3.5
2008/1991	10.3	9.6	9	8.7	7.8	9.8	4.1	2.8	4	2.9	1.5	3.4
2009/1991	10.3	9.6	8.7	8.7	7.7	9.8	NA	NA	NA	NA	NA	NA

Note: NHs: National Highways; SHs: State Highways; PWD: other Public Works Department roads

\* Other include tractors, trailers, three wheelers (passenger), vehicles / LMV and other miscellaneous vehicles which are not separately classified. NA: Not Available, #: CAGR for the period 2008/1951

Sources:

1. Calculated on the basis of data received from Offices of State Transport Commissioners / UT Admn
2. "Basic Road Statistics of India", 2004-05 to 2007-05

**Yet, the growth of vehicular traffic on roads has been far greater than the growth in the road network; as a result, the main arterial roads in the country are facing capacity saturation** (Figure 6).

The reason for this is:

- Focus on the growth of National Highway network though with lack of maintenance of arterial roads;
- Introduction of small and cheap cars, like Nano car from Tata Group priced at \$2,500, which are rising rapidly in the Indian market. Sales data from the Society of Indian Automobile Manufacturers (SIAM, 2007) show that total vehicle sales increased by an annual average rate of 15% over the last 5 years.

Figure 6: Graph of Compound Annual Growth Rate of vehicles and road extension (length) over the years

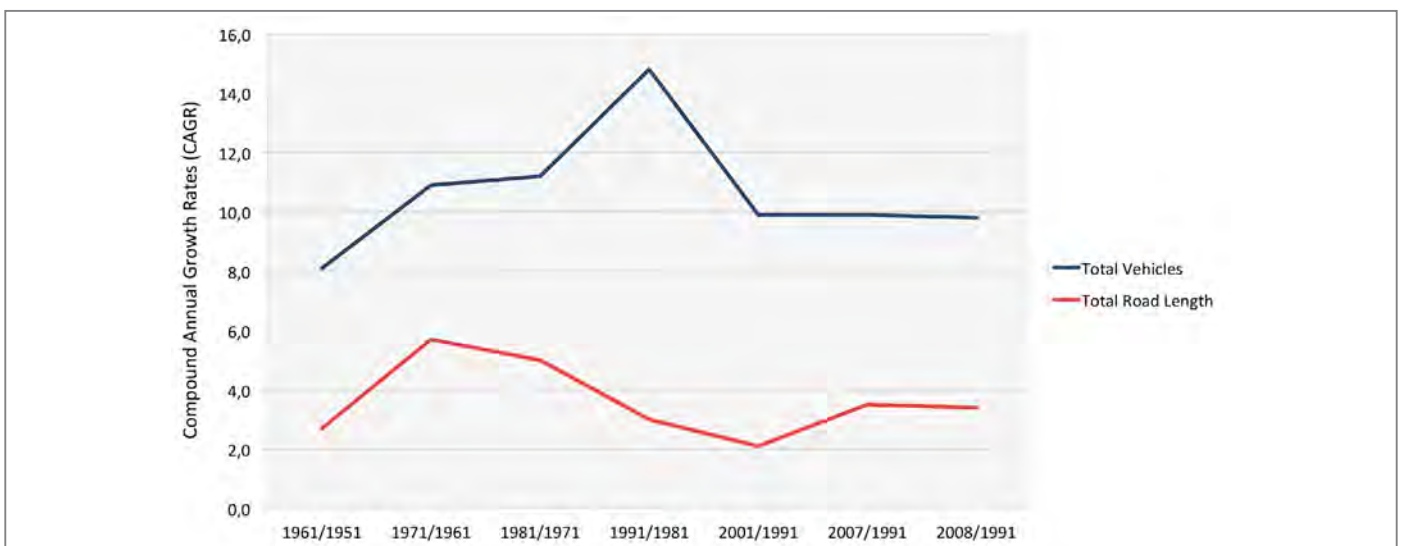

Sources:

1. Calculated on the basis of data received from Offices of State Transport Commissioners / UT Admn
2. "Basic Road Statistics of India", 2004-05 to 2007-08

Figure 7: Road vehicles sales in 2001 and 2006, India

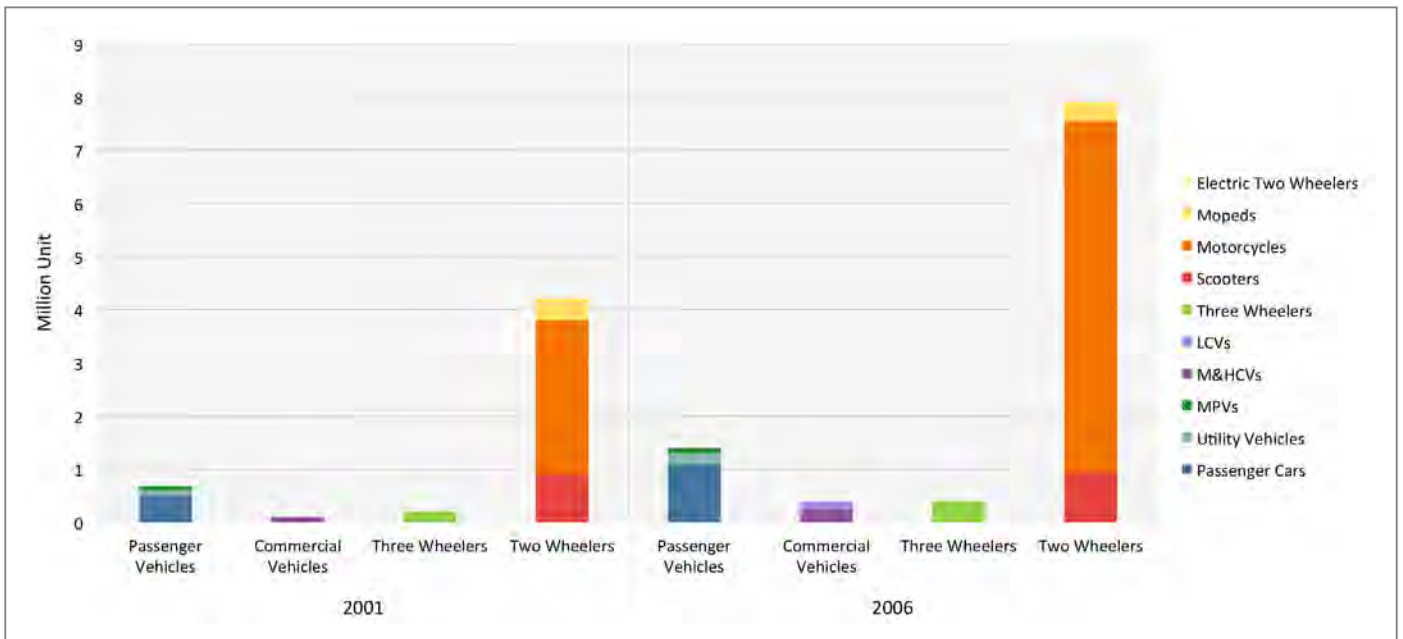

SIAM, 2007

M&HCVs: Medium and Heavy Commercial Vehicles; LCVs: Light Commercial Vehicles; MPV: Multipurpose Vehicle (van type of vehicle)

Source: Society of Indian Automobile Manufacturers, Transport Energy use in India: Past Trend and Future Outlook, Ernest Orlando Lawrence Berkeley National Laboratory, January 2009

The data reported in Figure 7 are in line with those published by EBTC in 2012.

## 6. EFFECT OF GDP

Transport sector accounted for a share of 6.6 per cent in India's Gross Domestic Product (GDP) in 2008-09, with road transport being the dominant mode of transport, with a share of 4.8 per cent in GDP. It can be seen how, over the years, share of road transport in GDP has increased, while that of railways has fallen. The composition of various sub-sectors of the transport sector in the GDP is given in Table 1.

Table 5: Share of different modes of transport in GDP

	1999-2000	2000-2001	2001-2002	2002-2003	2003-2004	2004-2005	2005-2006	2006-2007	2007-2008	2008-2009
<b>Sector</b>	<b>As percentage of GDP (at factor cost and constant prices)</b>									
Transport of which	6.0	6.0	6.0	6.2	6.3	6.7	6.7	6.7	6.7	6.6
Railways	1.3	1.3	1.2	1.2	1.2	1.0	1.0	1.0	1.0	1.0
Road Transport	3.8	3.9	3.9	4.1	4.3	4.8	4.8	4.8	4.7	4.8
Water Transport	0.2	0.2	0.2	0.2	0.2	0.2	0.2	0.2	0.2	0.2
Air Transport	0.2	0.2	0.2	0.2	0.2	0.2	0.2	0.2	0.2	0.2
Services*	0.5	0.5	0.5	0.5	0.5	0.5	0.5	0.5	0.5	0.4

Data from 1999-2000 up to 2003-04 are at 1999-2000 price / Data from 2004-05 onwards are at 2004-05 price

FISM = Financial Intermediation Services indirectly Measured / All modes include FISM; \*Services incidental to transport

Source: Centra Statistical Organisation

It may be noted how the **entire increase** in percentage share of transport in GDP since 1999-2000 has come from **road transport sector** only, with share of other modes remaining either constant or falling marginally. The total air passenger traffic in India has increased from 109 million in 2008-09 to 143 million in 2010-11, a 31% increase in 3yrs, international 20% and domestic 37%, but its contribution to India's economy is negligible. One of the reasons is the low fare war beginning in 2003. **The Indian carriers contribute to about a third of the worldwide airline losses even though they carry 2 per cent of global airline traffic.** **National Council for Applied Economic Research** stressed the need for productive investment in the sector. [Source: News from Deccan Herald, 3 Jan 2012 <http://www.ncaer.org>]

## 7. TRANSPORT BY MODE

Walking to work remains the prevailing mode of transport for Indian households today. Car ownership is still very low in India but sales of cars are starting to increase rapidly. Not surprisingly, bicycles are the most widely used vehicle type owned by households. Traveling by bus is by far the most used means of transport in India, accounting for 56% of total passenger-km. This results from a high passenger load factor in bus transport.

Figure 8: Passenger-km in transport modes, India

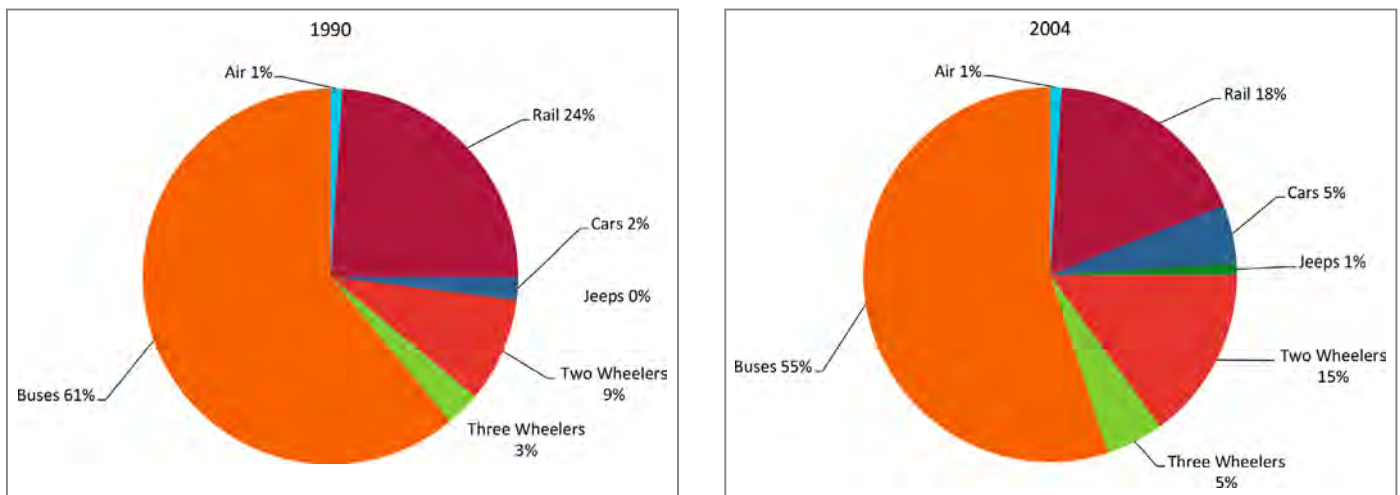

Passenger-km in India has increased from 1,327 billion passenger-kilometres (BPkm) to 2,933 BPkm between 1990 and 2004, at an average annual growth rate of 5.9%. Overall **road transport** is the **fastest** growing mode of transportation with an annual growth rate of 6.4%, followed by air at 6.2% and rail by 3.6%. Road dominated overall passenger transport with a share of 75% in 1990 and 81% in 2004.

**Although transport by rail has also increased, its share has decreased from 24% to 18% during the last 14 years, due to intense competition from road transport.** Operational inefficiencies and capacity constraints on key routes have also played a role in the slow growth of India's rail traffic (WB, 2002). Although a large proportion of passenger motorised mobility (in terms of passenger-km) is still catered to by buses, the share of bus use has decreased from 61% to 55%. The use of cars has increased from 2% to 6%, two wheelers from 9% to 15%, and auto-rickshaws from 3% to 5%. The share of transport by waterways is small compared to other modes.

Tonne-km was estimated to be equal to 610 billion in 2004, with an increase of 3.1% annually over the period 1990-2004. Rail transport represented 58% of tonne-km in 2004, down from 64% in 1990, medium and heavy trucks represent 37%, while light commercial vehicles represent a constant share of 4% (Figure 9).

Figure 9: Freight tonne-km per mode

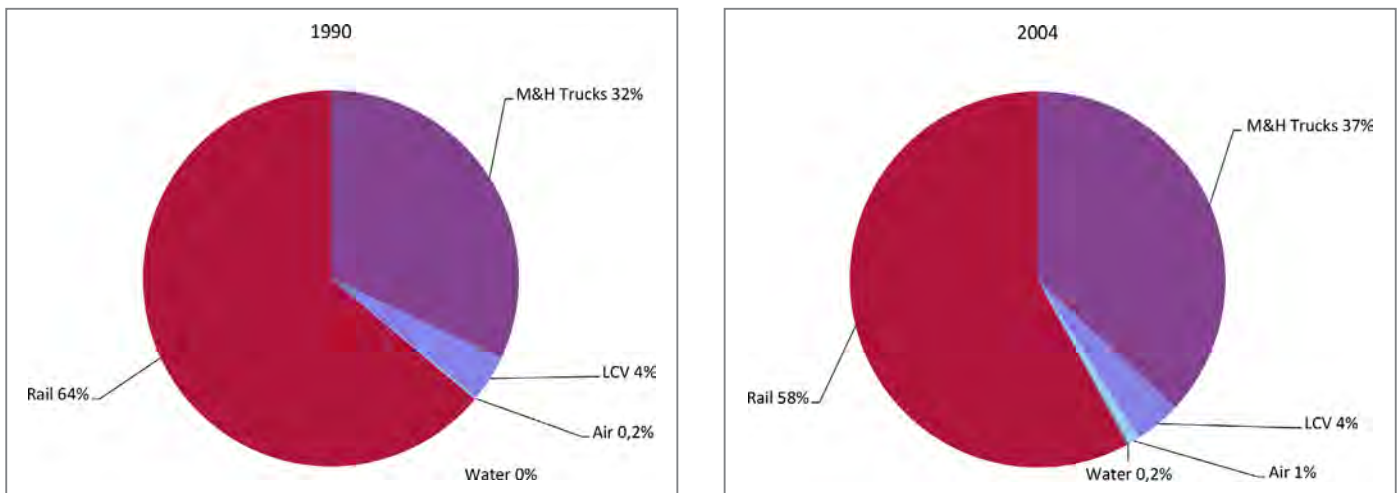

## 8. TRANSPORT AND ENERGY

Transport and energy are closely related. Energy is nowadays a crucial constraint on transport and transport is a major determinant of energy demand.

According to Eurostat, the impact in Europe (EU-25) of the transport systems in the overall use of the energy consumed in the EU countries in 2004 resulted to be equal to 30.7%; such value has grown around 31 to 32% in the following years. The impact of the transport systems in Europe is greater by nearly 10% versus the world average (estimate, 20.42% in 2003), on the grounds of the greater motorised average versus other continents. Europe actually shows some variability in the impact of transport consumption versus the overall final values reported for the different countries; in Italy, taken as example representative of an average, the transport systems approximately absorb one third of the overall consumption (33.82% in 2006/07).

The transport field is mainly characterized by the use of **vehicles with distributed energy use**, with the exception – in general terms – of the transport systems operating on fixed installations; in the large majority of cases, the combustion of the energy resource is developed directly on the vehicles, be they on road, sea, inland waterways or air. Almost all these transport systems are based upon **oil derived fuel**, and the alternatives are featured by significant limits. Transport systems operating on fixed installations do not strictly depend on it since – as well known – they use, with the exception of Diesel traction, electrical lines supplied by power stations, irrespectively on the energy source used to supply such stations.

The transport field, whose role has nowadays become essential, is the only sector – if compared to the manufacturing, housing and service industries – to be almost exclusively based upon a sole primary source, i.e. oil (indicatively, 96% in Europe and 93% in North America, 2011).

India's commercial energy resource base is meagre compared with the population; while India has a sixth of the world's population, it accounts for only about 0.8% of total geological reserves, with 5.7% of world's proven coal reserves, and 0.4% of the world's proven hydrocarbon reserves. According to present trends, **India's transportation energy use is projected to grow at the fastest rate in the world**, averaging 5.5%, compared with the world average of 1.4% per year. **India is increasingly dependent on imported petroleum.**

While India's dependence on imported petroleum is growing towards uncomfortable levels, its energy usage efficiency in the transport sector is estimated to be only half that in the industrialised countries. In the transport sector, based on existing estimates in 1996-97, 85% of oil use is in the road sector where energy-inefficient designs, poor vehicle maintenance and inadequate and low-grade roads are widely prevalent. Energy conservation, substitution of imported by domestic fuels and the pursuit of transportation policies have to become vital national concerns.

**To underline some comparisons, some figures at European level on the dependence from oil in the transportation area at the beginning of this century (EU White Book on transports of 2001, [COM/2001/0370 def.]) estimated this value at the 98%; in the USA it was estimated at the 96% in the same period, re-**



duced at the 93.2% in 2010 [US Transportation Energy Data Book 2011, Ed30]). The EU White book on Transport Systems of 2011 reports a figure of 96% in EU.

For example, from the data of the Italian Ministry of the Economic Development in 2010, it is estimated that this dependence for Italy was nearly 93.4% for its use in transport system (road, rail, ...), though in decline with respect to 2005, when black oil was used for nearly 97%.

## 9. THE EFFECT OF PRICE

Major increases of prices since the 90's have been affecting motor gasoline and diesel in India. Energy consumption in the transport sector is particularly sensitive to prices for two main reasons. First, **immediate substitution with other fuels is not possible** until the vehicle owned has reached its end life. Second, transport is necessary but not always vital and, when needed, people tend to restrain their need and/or switch to more economical or more efficient – usually from the personal viewpoint – modes of transport.

Figure 9: Evolution of motor gasoline and diesel price in India: wholesale price indexes of diesel and motor gasoline

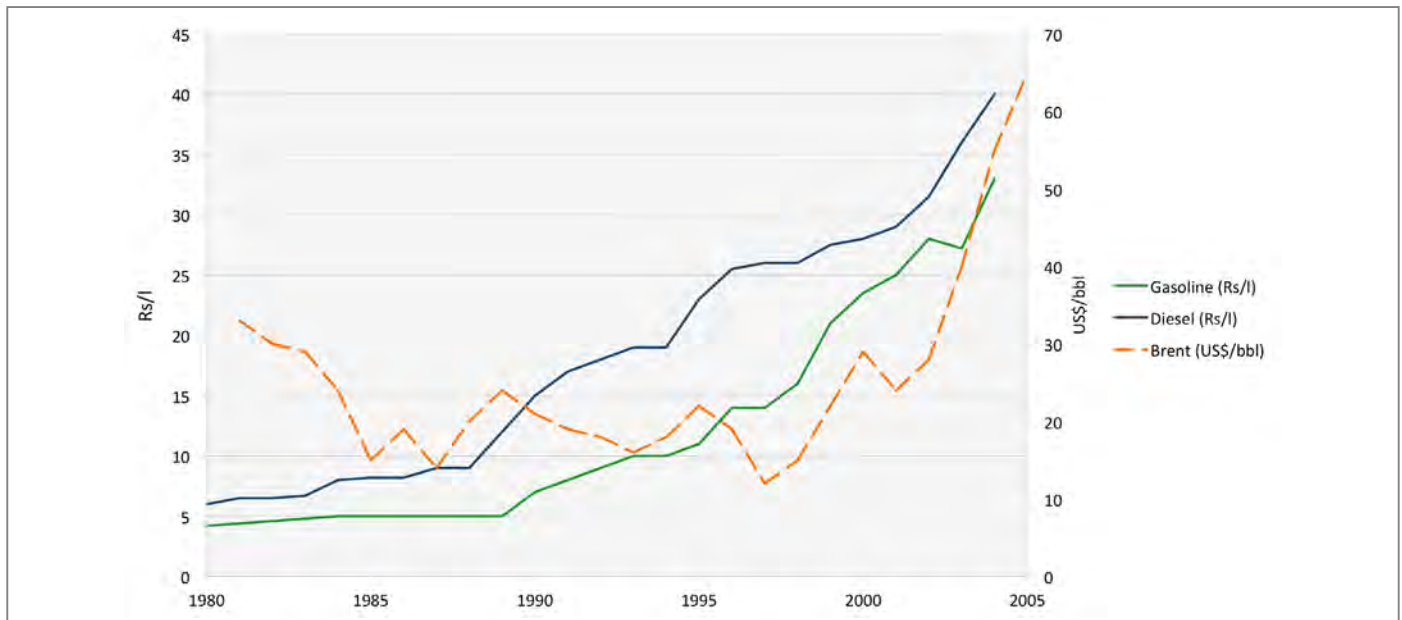

## 10. GASOLINE AND DIESEL TRANSPORT CONSUMPTION

In 2004, **diesel and motor gasoline represented 90% of final energy consumed in the transport sector**, while **jet kerosene represented 8% and electricity 2%**. Diesel is the most used form of energy, with a share of 66%, and motor gasoline representing 24%.

Statistics of energy consumption over time from the Ministry of Oil and Gas show a steady increase of motor gasoline, however statistics for diesel consumption show uneven trends (Figure 10). In 1996, a serious break in the series occurred, when diesel consumption in the transport sector plunged by 26%. In reality, no major activity disturbance or technology breakthrough can explain such a decline over a one year period. It is believed that a major restructuring in statistics accounting explains this trend, however, no official document or note was found to justify this argument.

Figure 10: Gasoline and Diesel usage over the years in India

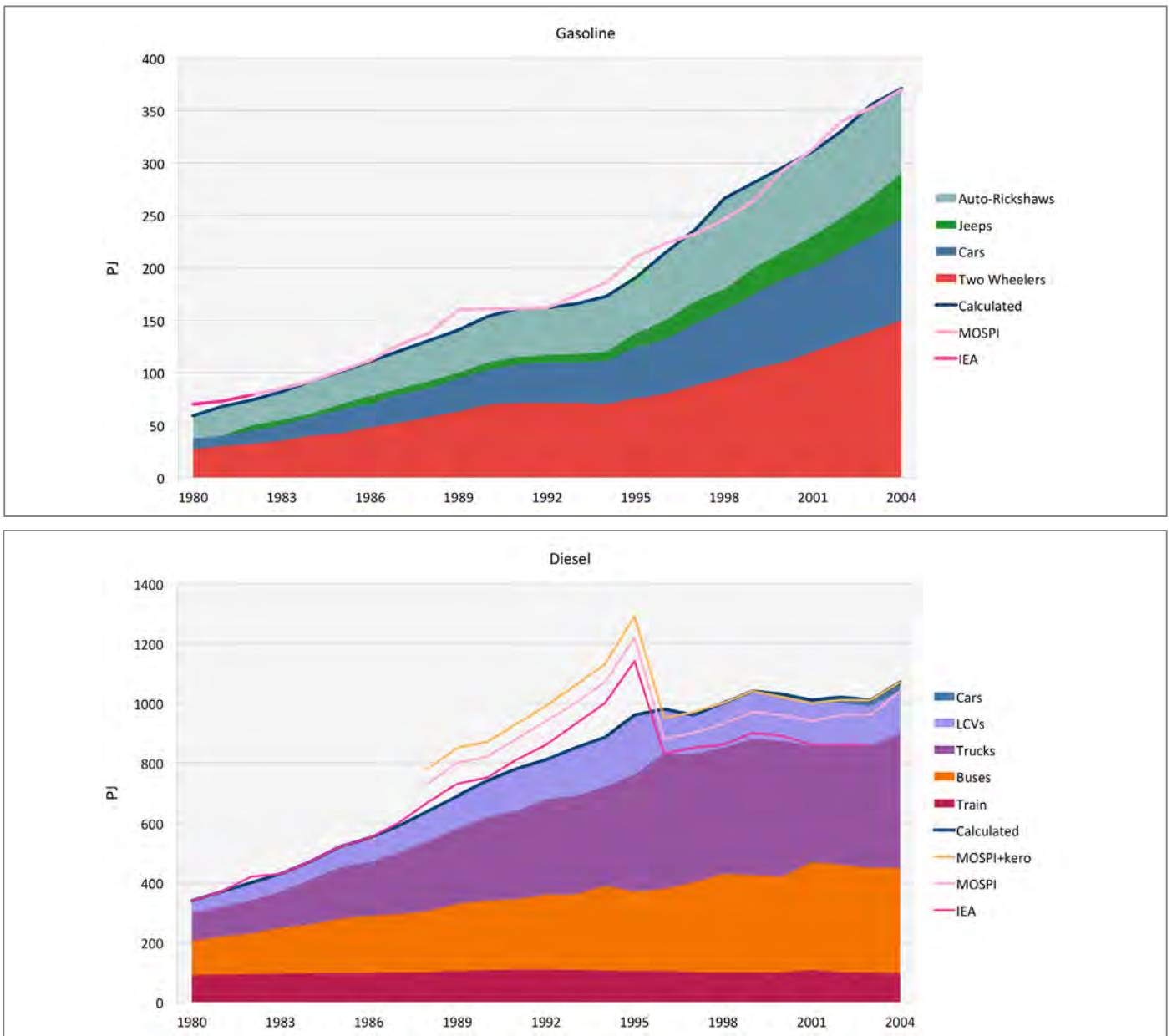

Source: *Transport Energy use in India: Past Trend and Future Outlook*, Ernest Orlando Lawrence Berkeley National Laboratory, January 2009

The Figure 10 also shows uneven trends for diesel consumption from data collected from the national statistics from MOSPI and the IEA. The reason for this is **adulteration of kerosene**.

Pricing of petroleum products varies greatly between the different types of petroleum products sold in India. Kerosene is highly subsidised while motor gasoline and diesel prices are subject to government taxes. **The price of a litre of kerosene was about a third of the price of a litre of diesel in 2005. The price difference is such that it has encouraged the use of kerosene for other purposes.**

## 11. ENERGY PROJECTION IN TRANSPORTATION SECTOR

Considering final energy consumption as the direct amount of energy consumed by end users while primary energy consumption including final consumption plus the energy that was necessary to produce and deliver electricity, in India, the factor primary on final energy is relatively high, i.e. 4.2, because of high transmission losses.

In 2020, the transportation sector is projected to account for 21% of total final energy use and 14% of primary energy use, versus 16% of total final energy use and 12% of primary energy use in 2005. This sector is expected to grow rapidly, with a projected annual growth rate of 6.8% for the period 2005 to 2020. Energy consumption from trucks is also expected to increase rapidly at 8.8% AAGR (average annual growth rate), followed by air transportation at 7.9%. In terms of share, energy used by buses will decrease from a share of 20% to 8% while energy used by trucks, still representing the largest consumption, will grow from 28% to 38%, and energy used by cars will increase from 10% to 18%.

Figure 11: Energy use projection by mode and vehicle types, PJ

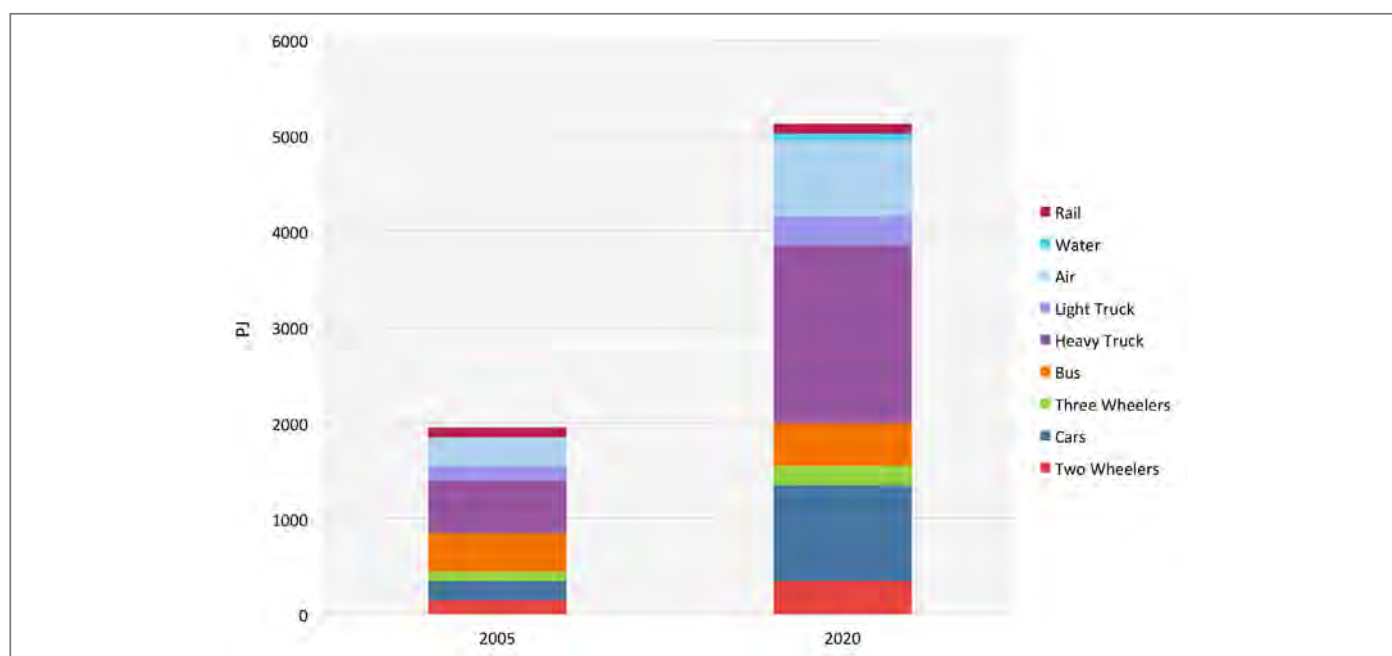

Two-wheelers make up about 63% of the projected vehicle stock, and yet they consume around 7% of transport fuels. Concerning the type of fuel used, motor gasoline is expected to represent a slightly larger share of 23% compared to 21% in 2005. Penetration of CNG is not visible here, because sufficient data were not available to estimate the energy use of this type of fuel.

However, in 1998, the Indian Supreme Court mandated CNG (Compressed Natural Gas) as the fuel for public transport in Delhi to control pollution. In 2002 a further ruling directed the Union government to give priority to the transport sector for CNG. Yet more recent regulations gave a limit to the development or increase of the CNG use.

Figure 12: Passenger-km projections, India

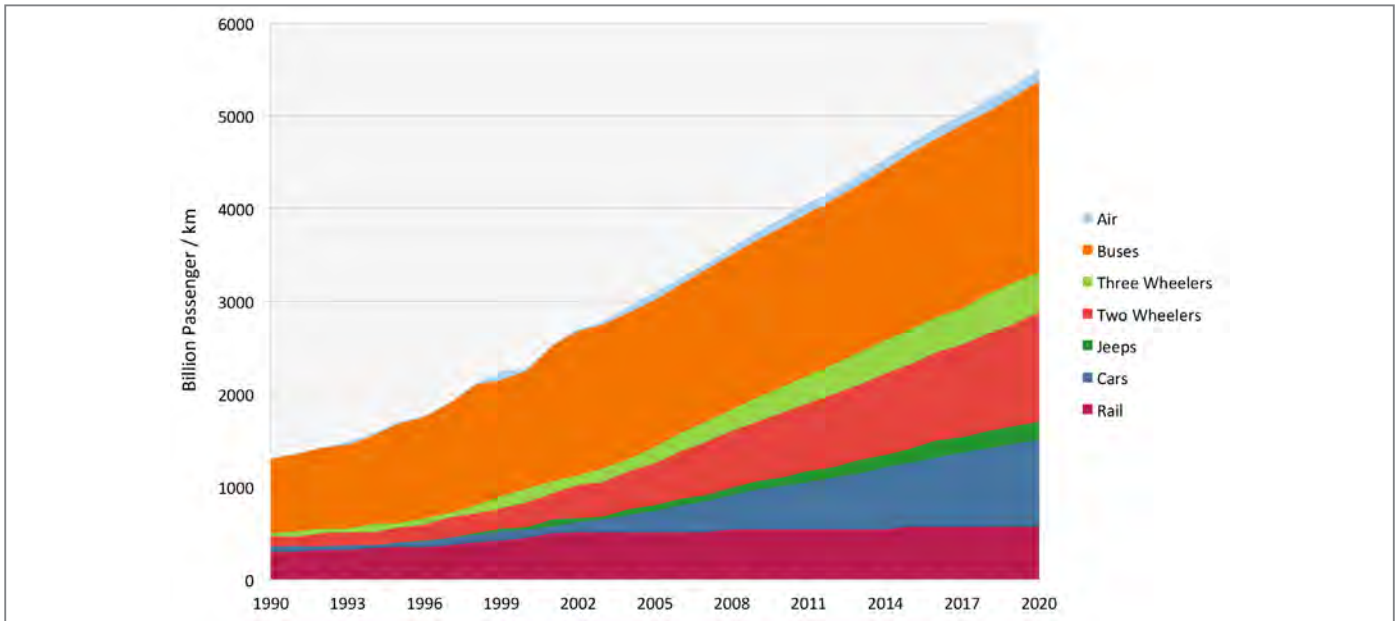

Note: No comprehensive data collection or analysis has been done. The greatest gaps in data availability arise from a lack of accurate statistics and it lacks consistent data reporting from national source.

Figure 13: Freight-tonne projections, India

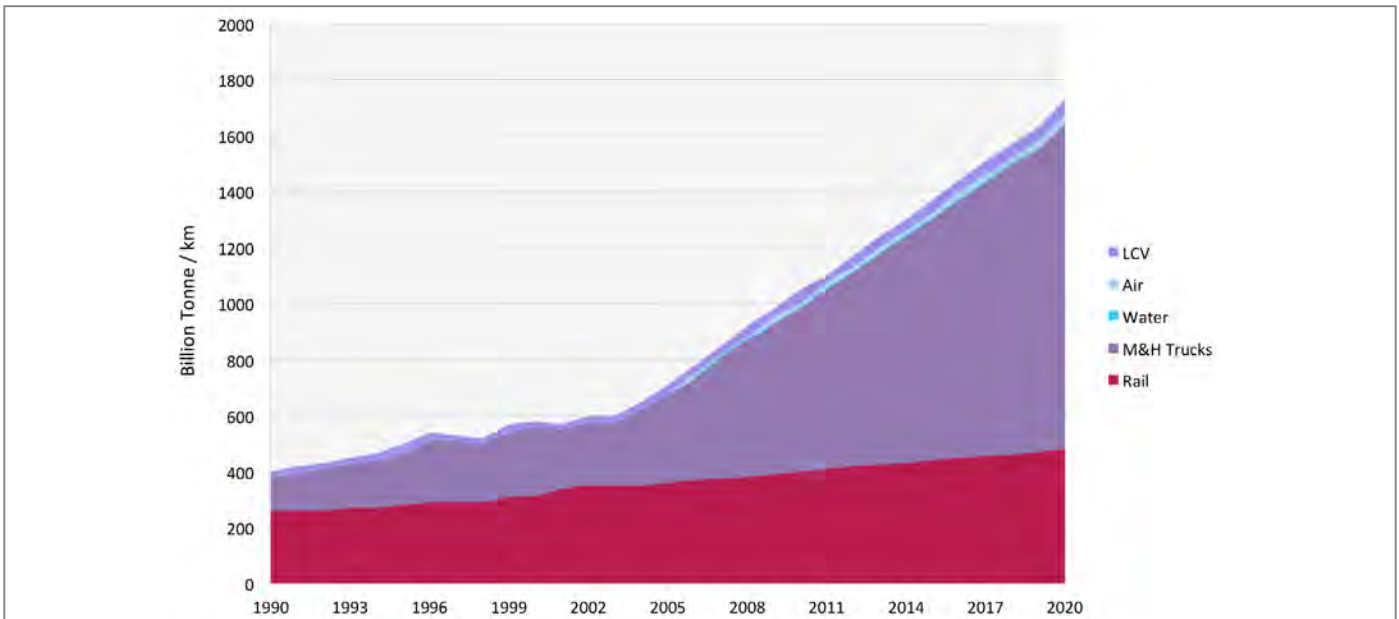

Source: Transport Energy use in India: Past Trend and Future Outlook, Ernest Orlando Lawrence Berkeley National Laboratory, January 2009

## 12. CARBON DIOXIDE EMISSIONS

Generation of electricity and heat is considered by far the largest producer of CO<sub>2</sub> emissions and was responsible, according to some sources, for nearly 41% of the world CO<sub>2</sub> emissions in 2008. Worldwide, this sectors rely heavily on coal, the most carbon-intensive of fossil fuels, amplifying their share in global emissions. Countries such as Australia, China, India, Poland and South Africa produce between 69% and 94% of their electricity and heat through the combustion of coal.

Between 2007 and 2008, total CO<sub>2</sub> emissions from the generation of electricity and heat were stable, although the fuel mix changed slightly. CO<sub>2</sub> emissions from gas grew by 3% and from coal remained constant while emissions from oil decreased by 4%. The future development of the emissions intensity of this sector depends strongly on the fuels used to generate the electricity and on the share of non-emitting sources, such as renewables and nuclear.

Table 6: World Carbon Dioxide Emissions, 1990 and 2008

	1990		2008	
	Million metric tons	Percent of emissions from oil use	Million metric tons	Percent of emissions from oil use
United States	4,989	44%	5,838	42%
Canada	471	48%	595	48%
Mexico	302	77%	493	66%
OECD" Europe	4,149	45%	4,345	48%
OECD Asia	243	59%	522	39%
Japan	1,054	65%	1,215	47%
Australia/New Zealand	298	38%	464	33%
Russia	2,393	33%	1,663	20%
Non-OECD Europe	1,853	32%	1,169	25%
China	2,293	15%	6,801	159c
India	573	28%	1,462	25%
Non-OECD Asia	811	57%	1,838	48%
Middle East	704	70%	1,581	57%
Africa	659	46%	1,078	41%
Central & South America	695	76%	1,128	71%
Total World	21,488	42%	30,190	37%

Source: US Department of Energy, Energy Information Administration, International Energy Outlook 2011

## 12.1 Top ten emitting countries in 2008

Two-thirds of world emissions for 2008 originated from just ten countries, with the shares of China and the United States far surpassing those of all others. Combined, these two countries alone produced 12.1 Gt CO<sub>2</sub>, about 41% of world CO<sub>2</sub> emissions. In the United States, the large share of global emissions is associated with a commensurate share of economic output (GDP), the largest in the world. Japan, with a GDP more than double that of the Russian Federation, emits 28% less than the Russian Federation.

In 2008, the United States alone generated 19% of world CO<sub>2</sub> emissions, despite a population of less than 5% of the global total. Conversely, China contributed a comparable share of world emissions (22%) while accounting for 20% of the world population. **India, with 17% of world population, contributed less than 5% of the CO<sub>2</sub> emissions.** Among the five largest emitters, the levels of per capita emissions were very diverse, ranging from **1 t of CO<sub>2</sub> per caput for India and 5 t for China to 18 t for the United States.**

**Industrialised countries emit far larger amounts of CO<sub>2</sub> per capita than the world average. However, some rapidly expanding economies are significantly increasing their emissions per capita.** For example, between 1990 and 2008, among the top 5 emitting countries, China more than doubled its per capita emissions and India increased them by almost 80%. Clearly, these two countries contributed much to the 10% increase of global per capita emissions over the period. Conversely, both the Russian Federation and the United States decreased their per capita emissions significantly over the same period.

Figure 14: Top ten emitting countries in 2008

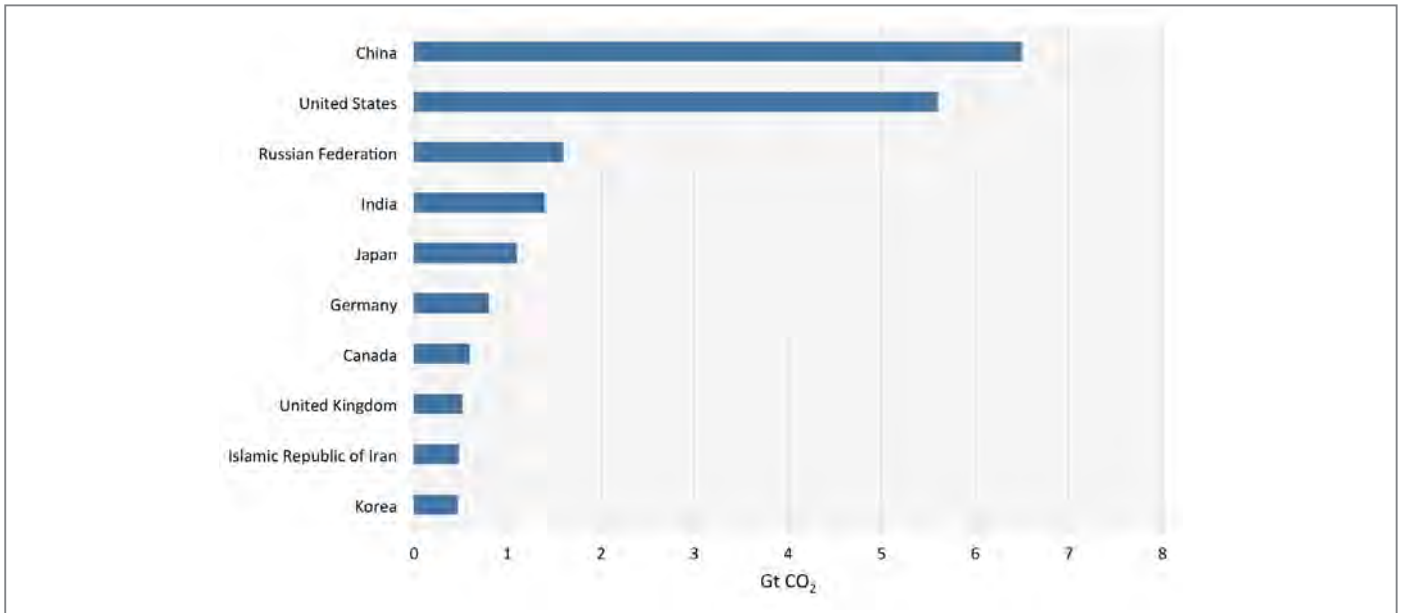

Keyword: The top ten emitting countries account for about two-thirds of the world CO<sub>2</sub> emissions  
 Source: IEA

Although climate and other variables also affect energy use, relatively high values of emissions per GDP indicate a potential for decoupling CO<sub>2</sub> emissions from economic growth. Possible improvements can derive from fuel switching away from carbon-intensive sources or from energy efficiency at all stages of the energy supply chain (from fuel extraction to energy end-use). Among the five largest emitters of CO<sub>2</sub> in 2008, China, the Russian Federation and the United States have significantly reduced their CO<sub>2</sub> emissions per unit of GDP between 1990 and 2008 (Figure 15). The other two countries, India and Japan, already had much lower emissions per GDP.

Figure 15: Trends in CO<sub>2</sub> emission intensities for the top 5 emitting countries

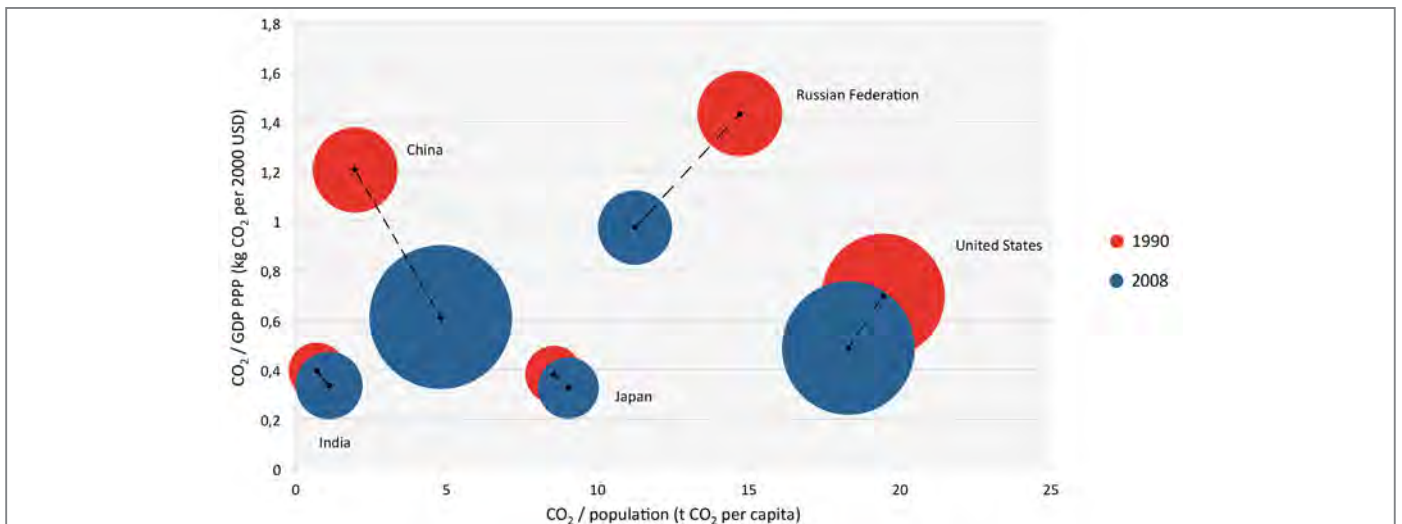

\*Size of circle represents total CO<sub>2</sub> emissions from the country in that year.  
 Source: International Energy Agency, 2010

Key point: China, the Russian Federation and the United States have all made significant improvements in the amount of CO<sub>2</sub> emissions per unit of GDP they emit.

## 12.2 CO<sub>2</sub> emissions for India

India emits nearly 5% of global CO<sub>2</sub> emissions: emissions continue to grow. The *WEO 2009 Reference Scenario* projects that CO<sub>2</sub> emissions in India will increase by more than 2.5 times by 2030 from 2008. A large share of these emissions is produced by the electricity and heat sector, which represented 56% of CO<sub>2</sub> in 2008. **The transport sector, which was only 9% of CO<sub>2</sub> emissions in 2008 (Figure 16, Figure 17), is growing relatively slowly compared to other sectors of the economy.**

Distribution of fuel use in the transport sector in 2007 (in PJ) in India is represented in Figure 19.

Figure 16: CO<sub>2</sub> emissions by fuel in India

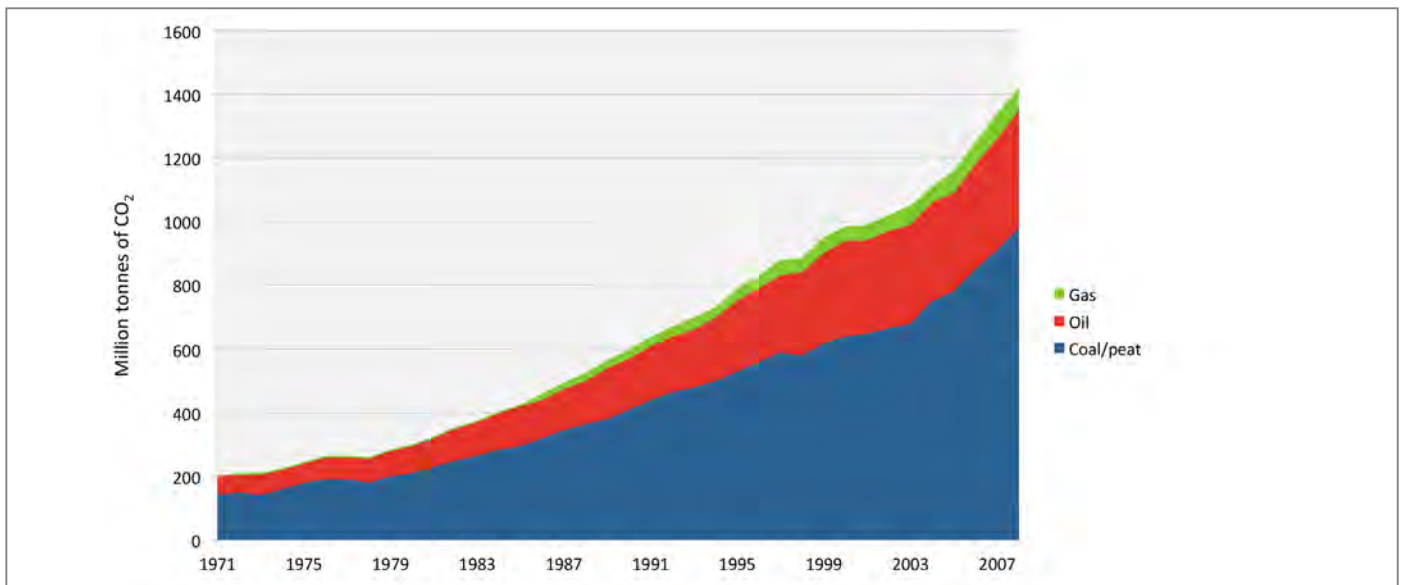
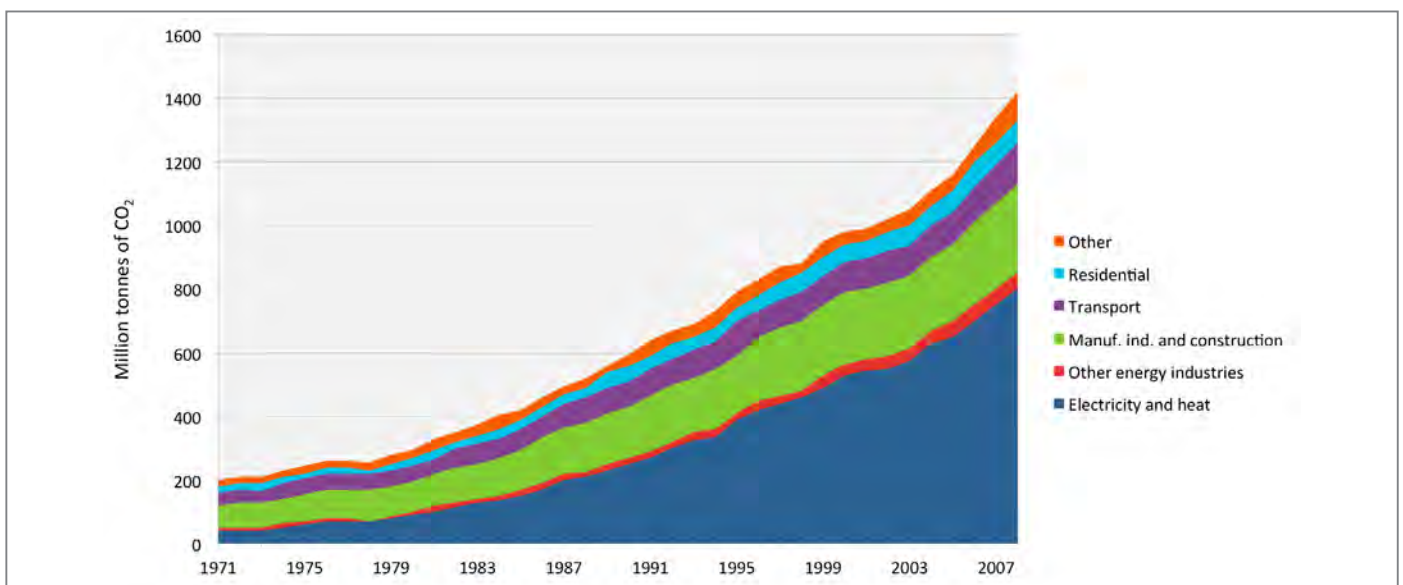

Figure 17: CO<sub>2</sub> emissions by sector in India



Source: International Energy Agency

**Keypoint:** The bulk of CO<sub>2</sub> emissions in India comes from the electricity and heat generation sector and its share is continuing to grow.

Figure 18: World CO<sub>2</sub> emissions by sector in 2008

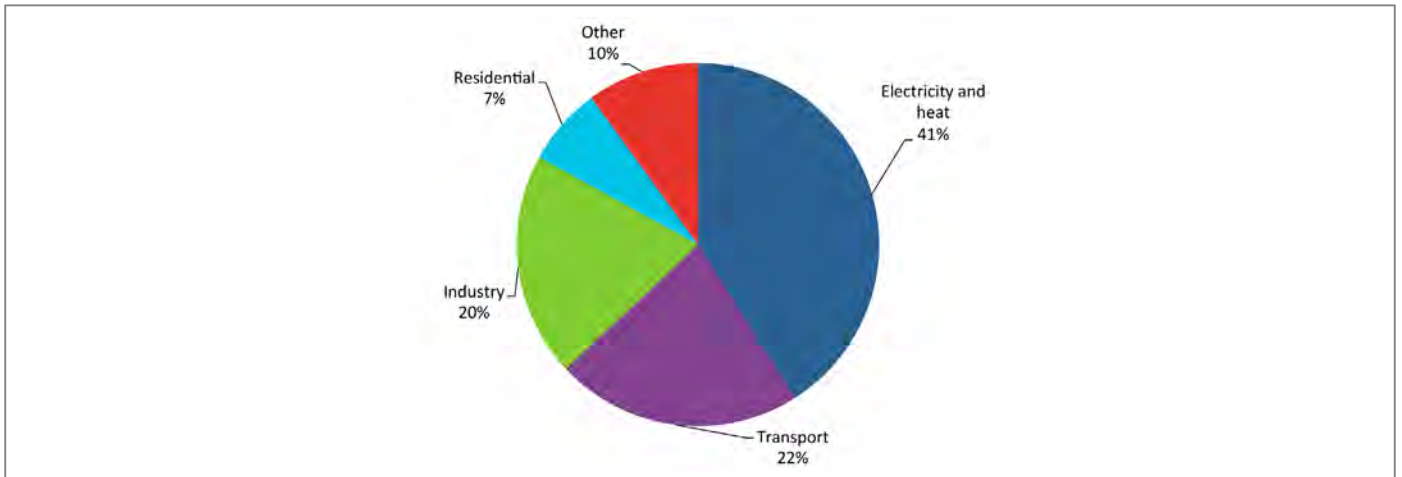

Source: IEA International Energy Agency

Other includes commercial/public services, agriculture/forestry, fishing, energy industries other than electricity and heat generation, and other emissions not specified elsewhere.

**Key point: the combined share of electricity and heat generation and transport represented two-thirds of global emissions in 2008.**

Figure 19: Distribution of fuel use in the transport sector in 2007 (in PJ) in India

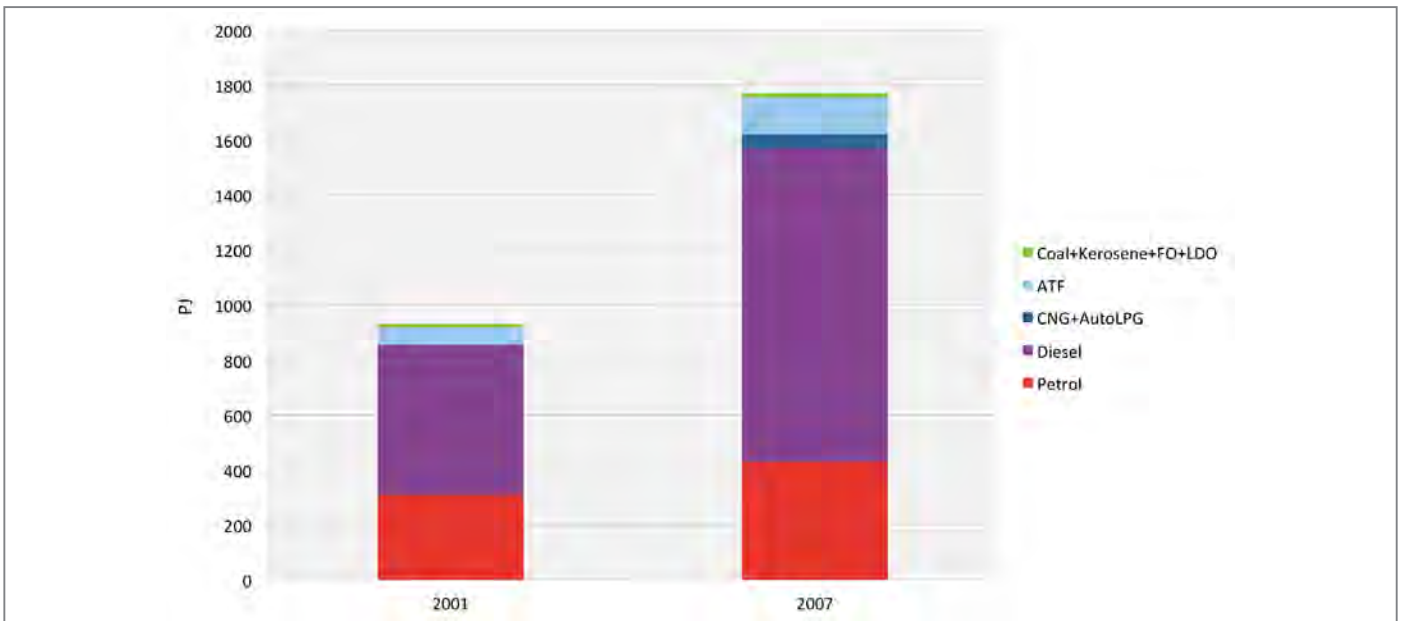
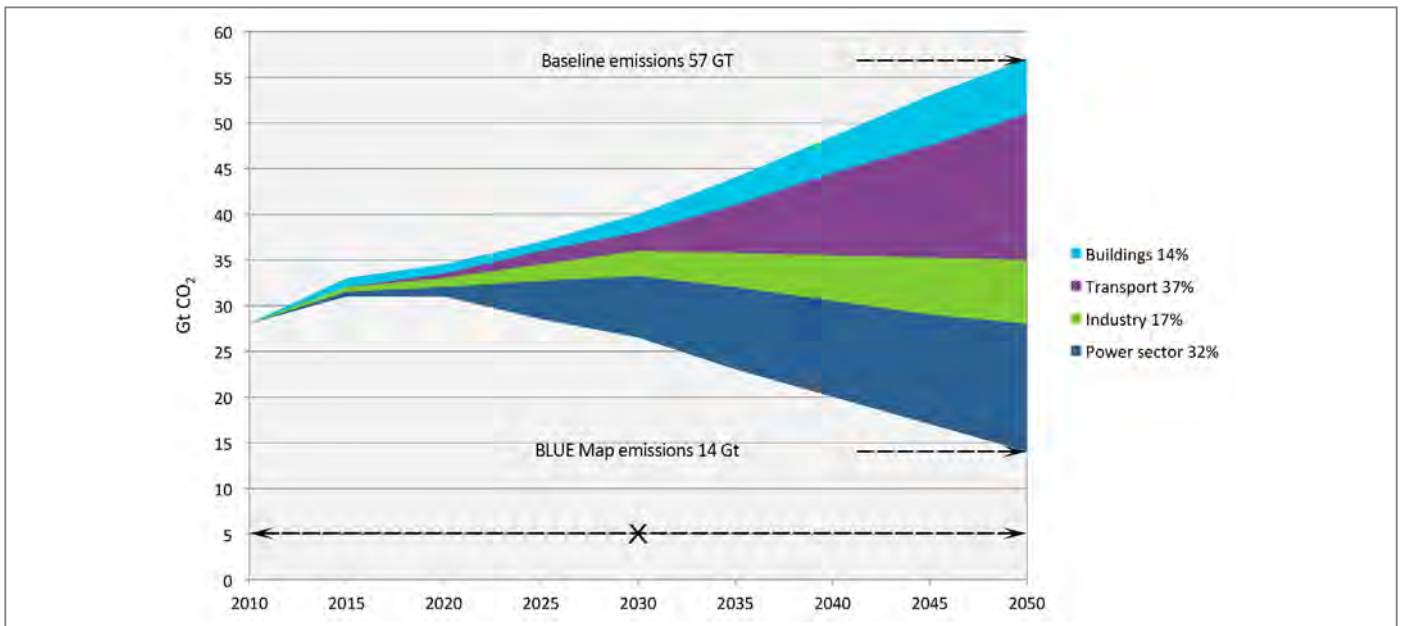



Figure 20: CO<sub>2</sub> emissions from Transport Sector in India, projections according to present perspectives by IEA



Source: Energy Transition in India, International Energy Agency, January 2011

### 13. POLLUTANT EMISSIONS FROM MOTOR VEHICLES

Table 7: Emissions from Motor Vehicles in India

Mode	Carbon Monoxide (CO)	Unburnt Hydrocarbon (HC)	Nitrogen oxides (NO <sub>2</sub> )	Sulphur dioxide (NO <sub>2</sub> )	Lead (Pb)	Total suspended particles (TSP)
2-wheelers	8.30	5.18	-	0.013	0.0040	-
Cars	24.03	3.57	1.57	0.053	0.0117	-
3-wheelers	12.25	7.77	-	0.029	0.0093	-
Urban buses	4.38	1.33	8.28	1.440	-	0.275
Trucks	3.43	1.33	6.48	1.130	-	0.450
LCVs	1.30	0.50	2.50	0.400	-	0.100

Sources: elaboration from Government of India and other sources

The figure 21 reports the and CO<sub>2</sub> equivalent emission distribution from various modes of transport within the transport sector.

Figure 21: GHG (greenhouse gases) emissions from the Transport Sector

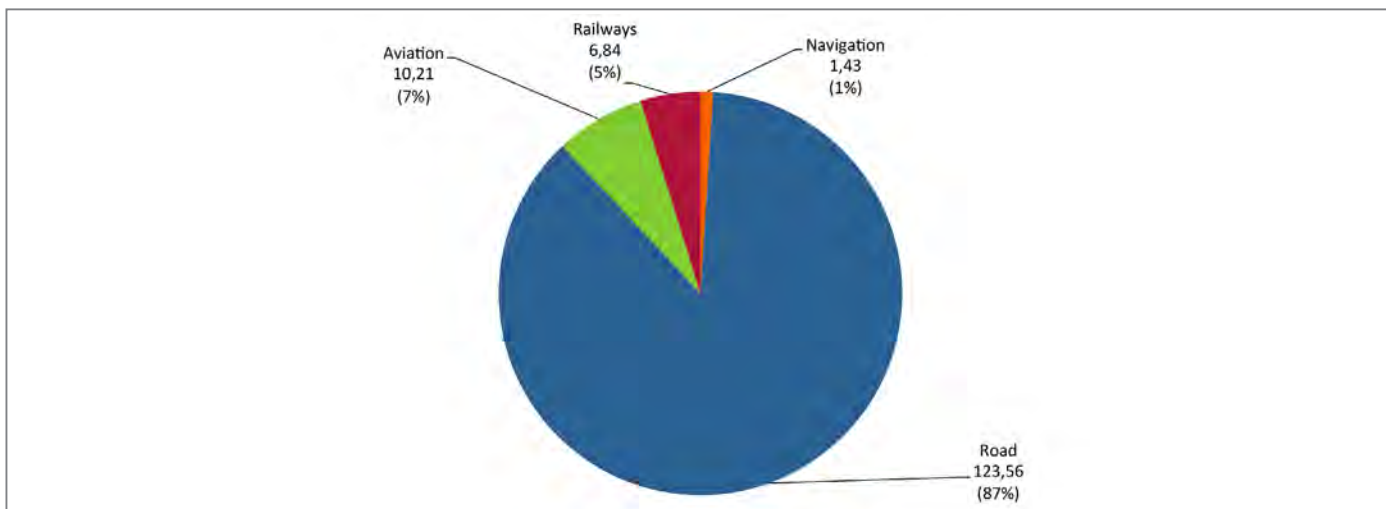

## 14. GENERATION OF ELECTRICITY FOR TRANSPORT SYSTEMS

Electricity is an energy vector which can be produced by a large variety of primary energy sources, both fossil fuels, renewables and nuclear.

In 2008, 69% of electricity in India came from coal, another 10% from natural gas and 4% from oil (Figure 22). The share of fossil fuels in the generation mix grew from 73% in 1990 to 85% in 2002. The share of fossil fuels has declined steadily since then, falling to 81% in 2007. Electricity produced from hydro has actually risen during this period. India is promoting the addition of other renewable power sources into its generation mix and had an installed capacity of 17 GW of renewable energy sources.

Figure 22: Electricity generation by fuel

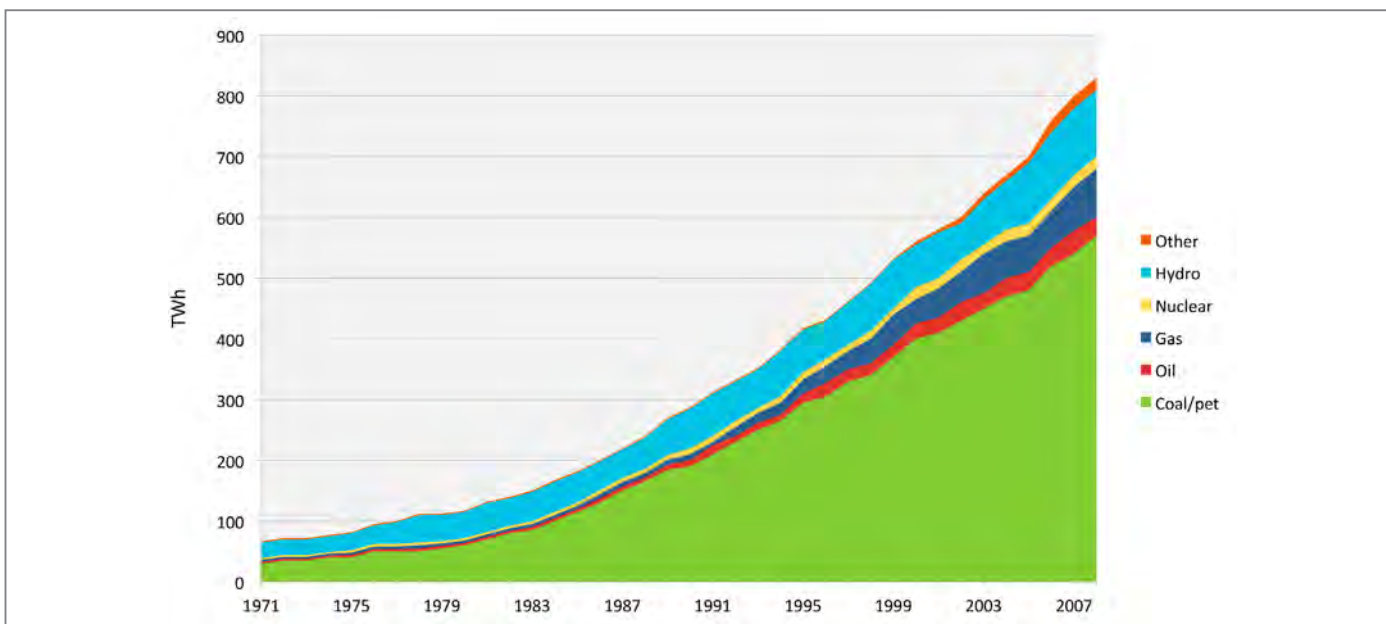

Source: international energy agency

Key point: nearly two-thirds of India’s electricity comes from coal.

As regards the use of electricity in vehicles, the use of electric motors proves to be highly efficient, nevertheless it remains to be **analysed how the energy stored in their batteries is produced** and/or distributed. Electricity can be supplied to the motor either by direct link to the electricity grid (e.g. for trolley buses or trains) or it can be stored on board through batteries. For road transport the most common system used is through on board batteries; the system can work either as a pure battery electric vehicle or as a plug-in electric hybrid vehicle in combination with an internal combustion engine.

The main advantages of electricity are that there are no tailpipe emissions and the power generation sector has the potential to become entirely decarbonised, thus leading to a decarbonised transport sector. The main disadvantages of electricity are currently related to the on-board storage possibilities (batteries), that until now do not allow ranges that are common in ICE vehicles, and to the costs, that are extremely high. Other issues are faced later in this document.

It is important now to introduce the concept of WTW. In order to provide an **appropriate analysis on energy consumption**, that is fully satisfactory from a methodological point of view and related to all transport systems, the well-to-wheel (WTW) index needs to be adopted. We are dealing with a tool which was firstly proposed and consolidated in the automotive industry, but which is rarely applied to the other modes.

WTW is an absolute energy index whose function enables the comparison between combinations of different propulsion technologies and different fuels or energy carriers (i.e. hydrogen and electricity, which – once they are produced – can be considered as fuels), obtained from the most various primary sources. The WTW index, which can be defined as the integration of all the processes required to produce and distribute a fuel (starting from the primary energy source) and use it in a vehicle (EC, 2004), consists of the combination of two more specific sub-indexes, namely: well-to-tank (WTT) and tank-to-wheel (TTW).

## 14.1 Cost of electric vehicle battery in India

At a very general and indicative level, the price of a complete lithium-ion battery pack could drop from the current price ranging between \$500 and \$600 per kilowatt hour to about \$200 in 2020 and to \$160 by 2025. It could plummet by more than 70 per cent by 2025 as rising oil prices and stringent fuel economy standards will push automakers to build more electric cars, according to a McKinsey & Co study. Manufacturing these batteries on a larger scale represents one-third of the potential price reduction. The expected influx of companies in the sector and new technology borrowed from consumer electronics makers like Apple Inc would help cut battery costs.

Nevertheless, the non-availability of charging points, battery capacity, limited driving range and lower speed has made customers shy away from the electric vehicle. Mahindra Reva Electric Vehicles (MREV) gears up to launch five new electric vehicles in the next four years; it seems a long way to go for the electric car market in India. Alternative fuel-driven vehicles especially electric cars or hybrids has failed to take off in India with automotive companies either shelving their plans or postponing their projects.

## 14.2 Fuel Cell Electric Vehicle (FCEV)

Energy efficiency standards may favour technologies that have high **tank-to-wheel (TTW) energy efficiency** such as FEVs (Full Electric Vehicles), BEVs (Battery Electric Vehicles) or plug-in hybrids (PHEV), but can hinder wide penetration of FCEVs in the long-term. BEVs and plug-in hybrids (especially those with high pure electric mileage ) are more efficient than FCEVs; on-board efficiency of FCEVs is lower than BEVs due to the additional on-board transformation process (i.e. the fuel cell). In the case of fuel cell success implementing energy efficiency standards, the share of FCEVs will be much greater than that of those implementing CO<sub>2</sub> standards, despite the breakthrough in fuel cell technology development, as the former will dominate the car market by 2050.

As in the battery success scenario if **energy efficiency standards** are introduced instead of CO<sub>2</sub> standards the share of FCEVs goes back considerably (although there could be a much stronger improvement in the tech-

no-economic performance of FCEVs). The main beneficiary technology would be **hybrid vehicles according to model projections**. Hybrid technologies cannot compete under CO<sub>2</sub> standards due to the remaining higher tailpipe emissions, but they will enter the market under energy efficiency standards.

The limited developments in fuel cells and battery based vehicles imply that freight and public transport remain dependent to the greatest extent on conventional ICEs and hybrids. The expected penetration of battery electric vehicles might be limited to the year 2050 when they reach a share less than 10%; the share of fuel cell vehicles would not reach a few units per cent. These vehicles will probably only penetrate in urban areas and for trips where range limitations do not represent a barrier.

[Source: elaboration from *Transportation Energy Databook, US Department of Energy, 31<sup>st</sup> edition, 2012*]

## 15. ENERGY CONSUMPTION BY INDIAN RAILWAYS

Ever since Rail Transportation was introduced in India by Great Britain, the most frequently used engines were run by steam traction, which was highly inefficient and caused heavy pollution. Now traction energy is provided by two means – Diesel and Electricity. Both these modes of traction are widely employed around the world and their performance is generally comparable up to the speeds of 200 kmph, beyond which electric traction becomes a technological necessity. Indian Railways have gone in for massive electrification, regardless of the fact that diesel traction can be equally efficient when the traffic density is low since it does not require capital expenditure on the overhead electrical equipment. Indian Railways has the second biggest electrified system in the world after Russia. The major freight railways of the world – the US, Canadian and the Australian railways – are on diesel only.

Figure 23: Passenger rail mobility by energy type

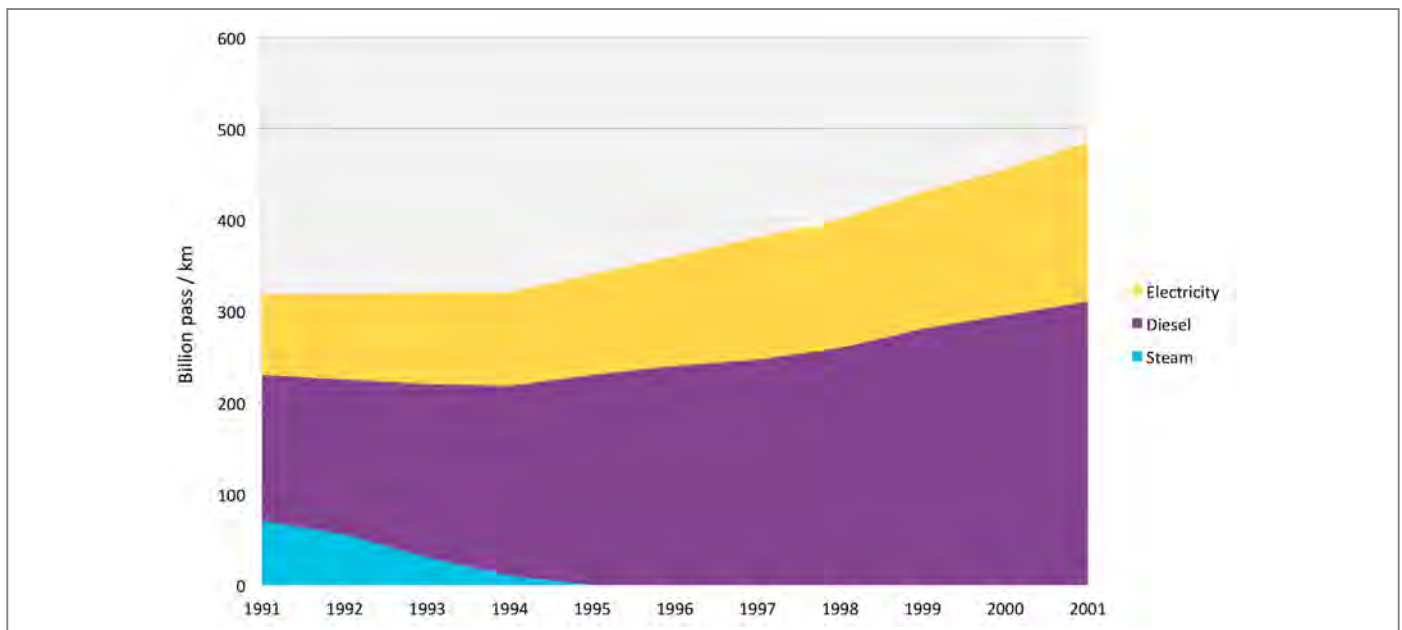

Table 8: Fuel Consumption by Indian trains over the years

Year	Non-traction Consumption			Traction Consumption		
	Electricity (million kWh)	HSD Oil (million litres)	Coal (million tonnes)	Electricity (million kWh)	HSD Oil (million litres)	Coal (million tonnes)
1997/98	1812.82	30.28	0.028	7137.07	1874.14	0.043
1998/99	2122.29	31.63	0.025	7299.34	1900.8	0.019
1999/2000	2216.13	31.46	0.028	7746.8	1983.43	0.01
2000/01	1975.86	32.33	0.026	7932.65	1999.26	0.004
2001/02	2079.63	31.79	0.017	8365.46	1970.72	0.003
2002/03	2361.32	33.72	0.016	9013.39	2007.99	0.003
2003/04	2160.96	33.11	0.012	9500.61	2060.4	0.003
2004/05	2182.39	34.17	0.006	10157.98	2080.63	0.003
2005/06	2269.41	35.87	0.006	10425.12	2082.03	0.003

Source: Indian Railways

Indian Railways – largest in Asia and the fourth largest in the world after United States, Russia and China – has got 20059 route kilometers of its tracks under the electric traction system as on October 30th, 2010: the 25 kV 50 Hz system was adopted as standard in 1957 and has been used for all subsequent electrification schemes. By March 1999, electrification extended to 14,579 route-km. This was **23.2 per cent of total route-km**, but electric traction was handling 45 per cent of passenger train-km and 60 per cent of gross tonne-km on broad-gauge.

Nowadays, the company carries over 30 million passengers and 2.8 million tons of freight daily. **The power consumption of the Indian Railways is around 2.5 percent of the country's total electricity consumption.** According to an estimation, the railway sector's demand for electricity will grow by seven percent annually and by 2020 it will have a projected energy demand of 37,500 kWh (million kilowatt hour).

## 15.1 Energy intensity

Table 9 reports Energy Consumption of Coal, Diesel and Electricity over the years in railways.

Table 9: Energy consumption of Coal, Diesel and Electricity over the years in Indian Railways

Energy consumption per thousand gross tonne-km							
Year	Gauge	Passenger Traffic (including passenger proportion of mixed traffic)			Freight Traffic (including goods proportion of mixed traffic)		
		Coal (kg)	Diesel (l)	Electricity (kWh)	Coal (kg)	Diesel (l)	Electricity (kWh)
1998-99	BG	-	5.2	20.6	-	3	8.1
	MG	92.5	6	19.7	793.6	4.8	8
	All	103.6	5.3	20.6	793.6	3	8.1
1999-2000	BG	-	4.8	20.6	-	3	8
	MG	153.4	5.8	22.9	977.1	5.4	7.5
	All	201.5	4.9	20.6	977.1	3	8.3
2000-01	BG	-	4.8	20	-	2.8	8.2
	MG	712.7	5.8	24.3	1058.8	5.1	8
	All	755.8	4.9	20	1058.8	2.9	8.2

Energy consumption per thousand gross tonne-km							
Year	Gauge	Passenger Traffic (including passenger proportion of mixed traffic)			Freight Traffic (including goods proportion of mixed traffic)		
		Coal (kg)	Diesel (l)	Electricity (kWh)	Coal (kg)	Diesel (l)	Electricity (kWh)
2001-02	BG	-	4.7	20	-	2.7	8.1
	MG	723.3	5.8	24.1	-	5.2	8
	All	720.7	4.8	20	-	2.8	8.1
2002-03	BG	-	4.7	19.5	-	2.7	8.1
	MG	523	5.7	20.5	-	5.1	-
	All	627.3	4.8	19.5	-	2.8	8.1
2003-04	BG	-	4.5	19.5	-	2.6	8.3
	MG	633.7	5.9	30.7	-	3.6	-
	All	772.5	4.6	18.6	-	2.6	8.3
2004-05	BG	-	4.6	19.2	-	2.6	8.6
	MG	620.3	5.8	34.6	-	3.6	-
	All	782.7	4.7	19.2	-	2.6	8.6
2005-06	BG	-	4.4	18.7	-	2.5	8.2
	MG	524.1	5.6	18.7	-	5.4	-
	All	652.5	4.5		-	2.6	8.2

For the past five decades, Indian Railways has faced increasing deficit in power supply, both for meeting its normal energy requirements as well as for its peak load demand. According to a report released by the Ministry of Statistics and Programme Implementation, energy consumption in Indian Railways has increased at a faster rate than energy production over the last four decades. The electricity consumption for operational purpose (Traction) and Railways sector has increased by tenfold in the last four decades.

## 15.2 Diesel Oil Consumption

Table 10 reports the Diesel Consumption per Locomotive over the years.

Table 10: Diesel Consumption per locomotive over the years

Year	Number of Diesel Locos	Diesel Consumption (kilolitres)	Diesel Consumption per locomotive (kilolitres)
1960/61	181	62771	346.8
1961/62	228	59444	260.7
1962/63	349	98481	282.2
1963/64	486	182328	375.2
1964/65	621	245633	395.5
1965/66	727	310813	427.5
1966/67	776	365582	471.1
1967/68	892	427126	478.8
1968/69	996	486084	488.0
1969/70	1091	536301	491.6
1970/71	1169	569025	846.8

Year	Number of Diesel Locos	Diesel Consumption (kilolitres)	Diesel Consumption per locomotive (kilolitres)
1971/72	1288	626983	486.8
1972/73	1431	667414	466.4
1973/74	1610	683140	424.3
1974/75	1702	720047	423.1
1975/76	1803	797610	442.4
1976/77	1903	867330	455.8
1977/78	2025	949077	468.7
1978/79	2126	960545	451.8
1979/80	2243	992060	442.3
1980/81	2403	1067470	442.2
1981/82	2520	1179682	468.1
1982/83	2638	1227236	465.2
1983/84	2800	1313200	459.0
1984/85	2905	1335664	459.8
1985/86	3046	1440269	472.8
1986/87	3182	1536499	482.9
1987/88	3298	1595897	483.9
1988/89	3454	1652555	478.4
1989/90	3610	1678814	465.0
1990/91	3759	1712816	455.7
1991/92	2905	1731473	443.4
1992/93	4069	1741751	428.1
1993/94	4192	1783162	425.4
1994/95	4259	1819464	427.2
1995/96	4313	1847748	428.4
1996/97	4363	1859443	426.5
1997/98	4496	1874139	416.8
1998/99	4586	1900804	414.5
1999/2000	4651	1983427	426.4
2000/01	4702	1999262	425.2
2001/02	4815	1970723	409.3
2002/03	4699	2007993	427.3
2003/04	4769	2060400	432.0
2004/05	4801	2080630	433.4
2005/06	4793	2082030	434.4

## 16. COMPRESSED NATURAL GAS (CNG)

In India a significant use of Compressed Natural Gas is made especially for tuk-tuks and for taxi services. Compressed Natural Gas (CNG) is a relatively clean automobile fuel with lower emission levels of SO<sub>x</sub>, NO<sub>x</sub> and SPM. It is, therefore, being promoted by the Government of India as a fuel for the transport sector by granting fiscal incentives. Average CNG consumption has grown at a CAGR of 76.86 per cent from 201.67

tonnes per day (TPD) as at April 1, 2001 to 1115.66 TPD as at April 1, 2004. India has 1,074 BCM (billion cubic meters) of natural gas reserves, according to present estimations. This includes 287 BCM of natural gas from on-shore and 787 BCM off-shore. In terms of gross production, the figures stand at 32,849 MCM. Of this, 8,763 MCM of natural gas is produced on-shore and 24,086 MCM off-shore. However, the net production of natural gas during 2008-09 was 31,770 MCM.

Table 11: CNG Data

State	City		No. of Vehicles						Price (Rs./Kg)	Average Consumption	
			Cars Taxis	Autos	LCV RTVs	Buses	Others Phatphat	Total		TPD	MMSCMD
Delhi	Delhi	IGL	281802	121854	5389	16655	5681	431381	29.00	1706.06	2.24
Maharashtra	#	MGL	66552	140533	2043	3720	1188	214036	31.84	940.37	1.31
	Pune	MNGL	1399	12991		115		14505	37.5	35.70	0.05
	Panvel	GAIL	38	163	0	2	0	203	41.00	0.44	0.00
Gujarat	Vadodara	GAIL	984	2327	0	72	0	3383	32.05	21.89	0.02
	Surat	GGCL	70502	50448	2994	584	0	124528	35.25	216.23	0.31
	Ankleshwar	GGCL	8465	10630	146	62	0	19303	35.25	34.92	0.05
Madhya Pradesh	Vijaypur	GAIL Gas	25	0	0	1	0	26	38.00	0.10	0.00
	Dewas	GAIL Gas	77	29	0	2	0	108	38.00	0.79	0.00
	Gwalior	AGL	50	350	0	9	0	409	46.00	0.75	0.00
	Ujjain	AGL	0	2000	0	40	0	2040	46.00	4.50	0.01
	Infore	AGL	2700	10500	0	109	0	13309	45.00	41.35	0.06
Haryana	Sonipat	GAIL Gas	1150	10	0	2	0	1162	34.20	7.68	0.01
Andhra Pradesh	Hyderabad	GAIL BGL	364	2558	0	0	18	2940	40.00	6.01	0.01
	Vihayawada	GAIL BGL	566	4272	0	293	13	5144	30.00	26.46	0.04
	Kakinada	GAIL BGL	46	20	0	0	0	66	35.00	0.02	0.00
	Rajamundry	GAIL BGL	12	34	0	0	0	46	35.00	0.09	0.00
Tripura	Agartala	GGL	362	3243	0	30	0	3635	28.00	9.85	0.10
Uttar Pradesh	Lucknow	GGL	488	6747	0	755	0	7990	39.00	56.85	0.082
	Agra	CUGL	50	6430	0	567	0	7047	39.00	30.46	0.042
	Kanpur	CUGL	3407	3618	105	847	10056	18033	39.00	57.33	0.08
	Bareilly		211	3542	0	35	1009	4797	39.00	13.95	0.02
<b>Total</b>			439250	382299	10677	23900	17965	874091			

#Mumbai and adjoining areas including Thane, Mira Bhyander and Navi Mumbai

TPD: Tonnes per day

Conversion factors:

1. IGL: Indraprastha Gas Ltd. 1 Kg = 1.313 SCM of gas

2. MGL: Mahanagar Gas Ltd. 1 Kg = 1.39 SCM of gas

3. GGCL: Gujarat Gas Company Ltd. 1 Kg = 1.45 SCM of gas

4. MNGL: Maharashtra Natural Gas Ltd. 1 Kg = 1.41 SCM of gas

5. AGL: Aavantika Gas Ltd. 1 Kg = 1.33 SCM of gas

Source: Gas Authority of India Limited



## 17. BIOFUELS

### 17.1 The biodiesel market

The biodiesel market represents a relatively young business. It started about 10-15 years ago and has been driven by two main factors:

1. new environmental regulations (e.g., EU target of greenhouse gas reduction of 20% by 2020) and
2. the dramatic increase of the oil price.

Thus, FAME (Fatty Acid Methyl Esters) became important alternative fuels for diesel engines due to the diminishing petroleum reserves. Nowadays, the EU biodiesel market corresponds to the world's largest one. Biodiesel is the most important biofuel in Europe, representing, on energy basis, about 75% of total biofuel used for transport (European biodiesel board, [www.ebb-eu.org](http://www.ebb-eu.org)).

As can be seen from production data of the last ten years (Figure 24 depicts data from the European biodiesel board, [www.ebb-eu.org](http://www.ebb-eu.org)), the production volume is strongly increasing. Particularly in the time period from 2003-2008, the production has grown by 40%. Looking at these data and considering the new environmental regulations (e.g., Directive 2009/28/EC), in the near future a positive trend and a further increase of biodiesel market volume can be expected.

Figure 24: EU biodiesel production trend (2002-2010).

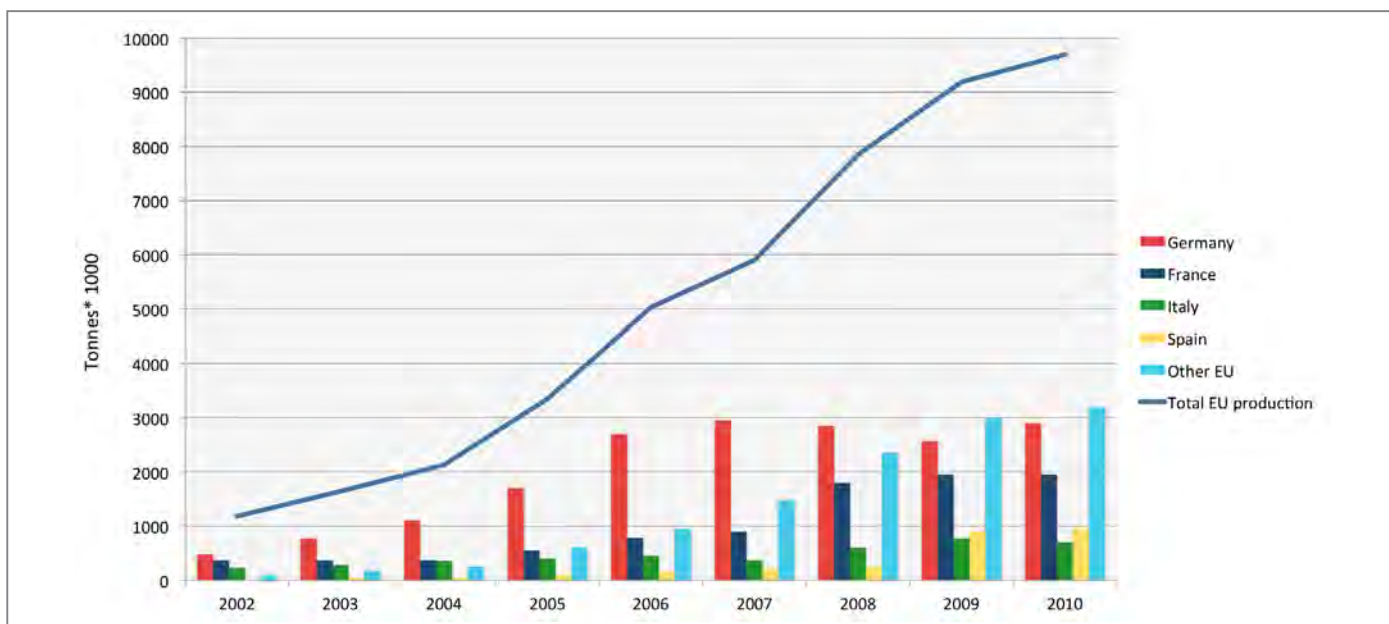

But, despite the constant increase of production, another aspect has to be considered. Based on the information given in the chart biodiesel production vs. installed plant capacities in Europe (Figure 25, European biodiesel board, [www.ebb-eu.org](http://www.ebb-eu.org)), up to 2006, almost all biodiesel plants produced at full capacity, while from 2007, the difference between effective biodiesel production and installed capacities has been rising. Thus, though a continuous increase of production volume took place, a lot of plants were closed or their work load was carried out partially. The main reason for this trend can be referred to raw material costs. The biodiesel production costs are strictly related to the feedstock price, especially vegetable oil which represents typically over 70% of the total production costs.

The constant growth of biodiesel production resulted in a strong increase of the demand for vegetable oil, that consequently led to a sharp increase of the corresponding raw material price (Figure 26, source International Monetary Fund). At the current vegetable oil price, the production cost of biodiesel is quite higher compared to common petroleum based diesel. Moreover, many European state governments are trying to make biodiesel competitive to common petroleum-based diesel through tax advantages. However, this approach can solve the problem only in the short term, but a better solution has to be found in the long-term.

Figure 25: EU biodiesel production vs. installed plant capacities.

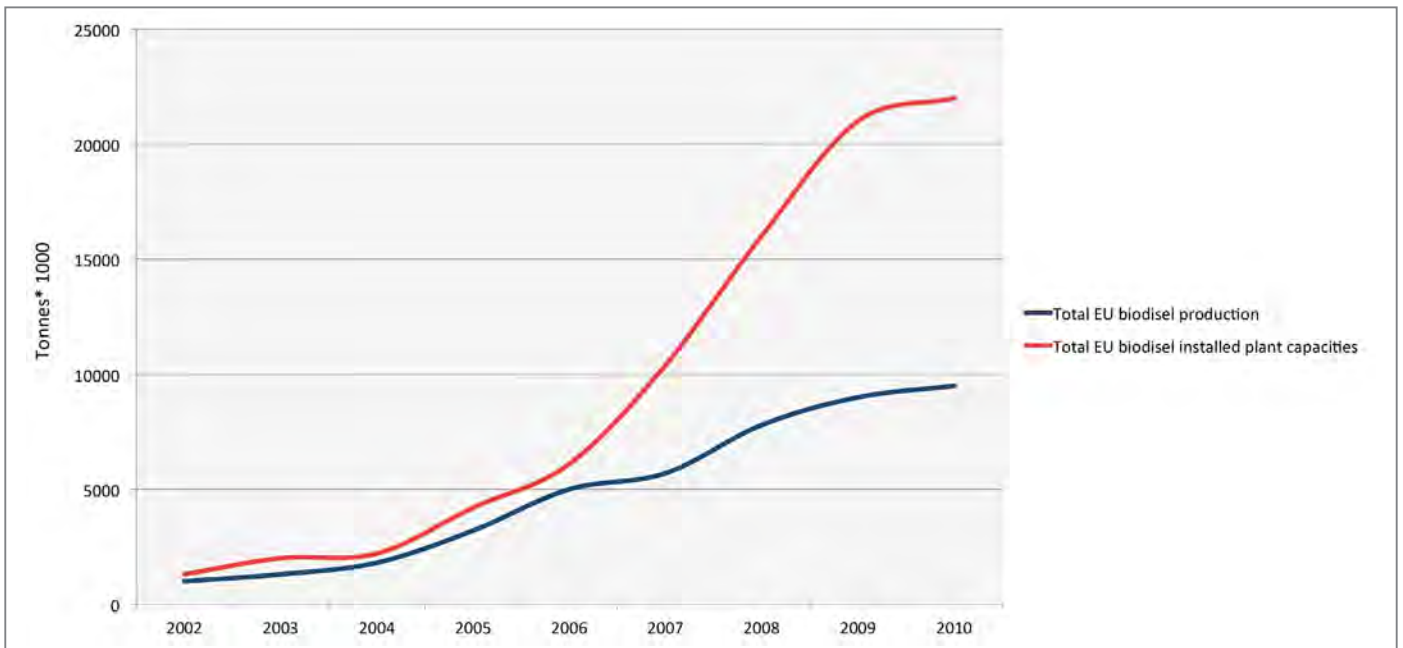
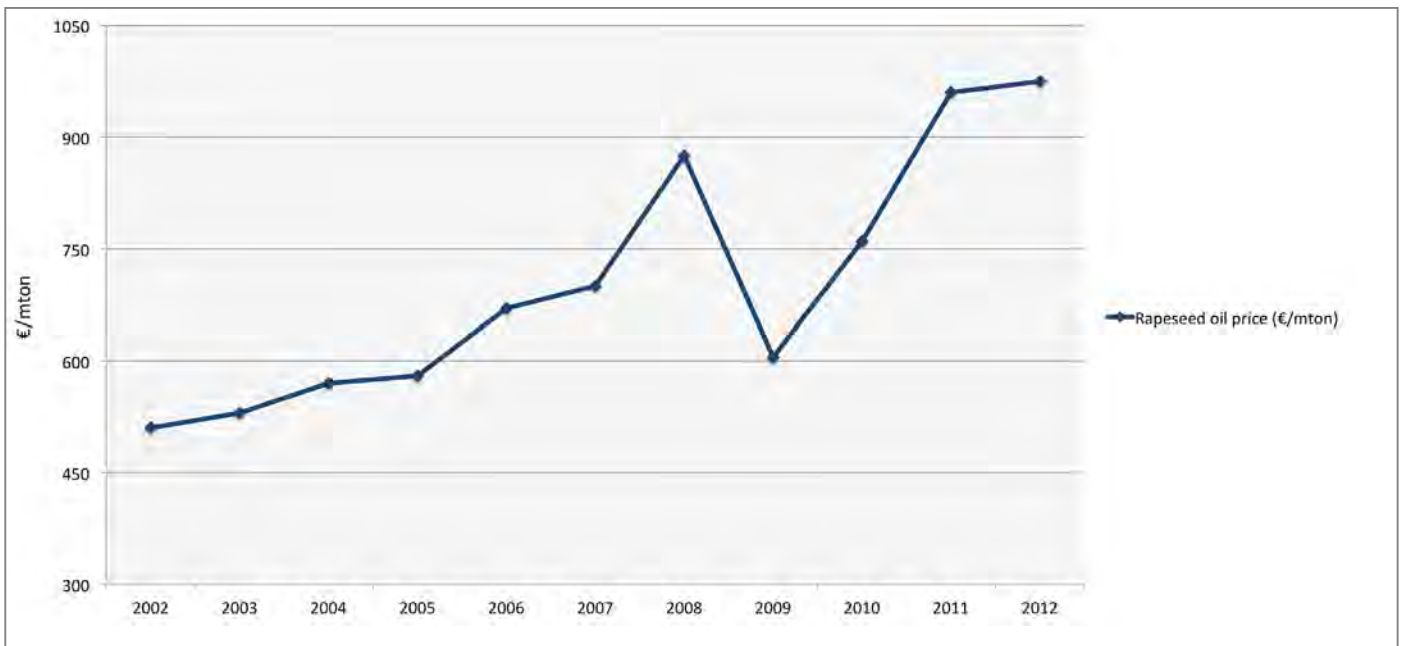

Figure 26: Rapeseed oil price (2002-2012).



Thus, the competitiveness of biodiesel is nowadays hindered by the price of vegetable oils. The reuse of waste vegetable oil can be a solution here, because its use gives a double benefit, as it provides a cheap feedstock, and also reprocess the waste.

The possibility of exploiting low price feedstock through innovative non-catalytic supercritical processes, in addition to the possibility of producing higher-added value by-products than glycerine, has been recently focussed on some of the authors. This development could pave the way for a wider exploitation of biodiesel, and was therefore addressed in the EBTC project for the fast growing market of diesel engine vehicles in India.

## 17.2 Biodiesel production in supercritical conditions

Many different technical options are currently being studied for an effective, cheap and on-spec production of biodiesel in supercritical conditions: many feedstock are being investigated, but the most interesting findings concern the possibility to use oils with high contents of free fatty acids such as recycled oils. The table in the next page (Table 12) summarizes all the experimental runs operated. It can be observed that different oils have been tried, such as vegetable or waste cooking oils. The larger part of experimental tests have been carried out using methanol as reagent, although also other reagents have been tested, such as ethanol or methyl acetate, especially in the last years, to avoid the problem of glycerol purification that is a consequence of the reaction with methanol. The most used molar ratio of oil/reagent is 1:42.

The operating temperature of tests is often in the range of 250-350°C, while the most used operative pressure is about 200 bar. Some tests have been carried out using a co-solvent, to lower the operating conditions with good results, while only one test has been done with the use of a catalyst.

The key point of this technology is the possibility of avoiding the use of homogenous base catalysts (KOH), thus allowing to be used as waste oils as feedstock (**which is currently the most profitable application for biodiesel**), having a high content of free fatty acids. Similarly, supercritical conditions avoid the use of liquid phase acid catalysts (H<sub>2</sub>SO<sub>4</sub>), reducing, in this way, its recovery in the separation section, and the associated energy cost. As for the heterogeneous processes for biodiesel production, it has to be pointed out that the unique commercialized solid catalyst process is the one developed by the Institut Français du Pétrole (Bloch et al., 2008), which was designed for the trans-esterification of refined oil, with very low free fatty acid content.

Table 12: Experimental test results from literature

n°	Oil	Reagent	T [°C]	P [bar]	t [min]	γ [%]	Molar ratio	Co-solvent	Catalyst	Reference
1	Rapeseed oil	Methanol	350-400	450	4	95	1:42	none	none	Kusdiana, Saka (2001)
2	Hazelnut kernel oil	Methanol	240	-	5	>95	1:41	none	none	Demirbas (2002)
3	Sunflower oil Cottonseed oil Soybean oil Corn oil	Methanol	367	-	-	96,8 97,6 97,9 97,2	1:41	none	none	Demirbas (2003)
4	Sunflower oil	Methanol	400	200	40	96	1:40	none	none	Madras, Kolluru, Kumar (2004)
5	Rapeseed oil	Methanol Ethanol 1-Propanol 1-Butanol 1-Octanol	300	20	15	100 95 95 85 62	1:42	none	none	Warabi, Kusdiana, Saka (2004)
6	Soybean oil	Methanol	280	128	10	98	1:24 (Prop/ MeOH=0,05)	Propane	none	Cao, Han, Zhang (2005)
7	Soybean oil	Methanol	280	143	10	98,5	1:24 (CO <sub>2</sub> / MeOH=0,1)	CO <sub>2</sub>	none	Cao, Han, Zhang (2005)
8	Soybean oil	Methanol	300	143	5	98	1:24 (CO <sub>2</sub> / MeOH=0,1)	CO <sub>2</sub>	none	Cao, Han, Zhang (2005)
9	Rapeseed oil	Methanol	380	200	15	80	1:42	none	none	Minami, Saka (2006)
10	Sunflower oil	Methanol	252	240	20	100	1:41	none	CaO (3%)	Demirbas (2007)

n°	Oil	Reagent	T [°C]	P [bar]	t [min]	γ [%]	Molar ratio	Co-solvent	Catalyst	Reference
11	Soybean oil	Methanol	350 300 300	200 - -	10 20 30	95 85,5 90,6	(CO <sub>2</sub> / MeOH 0,2)	Hexane CO <sub>2</sub>	None	Yin, Xiao, Song (2008)
12	Rapeseed oil	Crude bioMethanol	350	300	9	84,4	1:42	none	none	Isayama , Saka (2008)
13	Rapeseed oil	Methyl Acetate	350	200	47	95- 100	1:42	none	none	Saka, Isayama (2009)
14	Mustard oil	Methanol Ethanol	350	200	70 20	>80 100	1:40	none	none	Varma, Deshpande, Madras (2010)
15	Sesame oil	Methanol Ethanol	350	200	40 40	>90 100	1:40	none	none	Varma, Deshpande, Madras (2010)
16	Linseed oil	Methanol Ethanol	250	-	8	98 88	1:41	none	none	Demirbas (2009)
17	Palm oil	Ethanol	349	-	30	79,2	1:33	none	none	Gui, Lee, Bhatia (2009)
18	Rapeseed oil	Dimethyl carbonate	350	200	12	94	1:42	none	none	Ilham, Saka (2010)
19	Jatropha oil	Methanol	320	84	4	100	1:43	none	none	Hawash, Kamal, Zaher, Kenawi, El Diwani (2009)
20	Waste cooking oil	Methanol	287	-	30	100	1:41	none	none	Demirbas (2009)
21	Rice bran oil	Methanol	300	300	5	51,28	1:271	CO <sub>2</sub>	none	Kasim, Tsai, Gunawan, Ju (2009)
22	Dewaxed Degummed rice bran oil	Methanol	300	300	5	51,28	1:271	CO <sub>2</sub>	none	Kasim, Tsai, Gunawan, Ju (2009)
23	Palm oil	Methanol	360	-	20	72	1:30	none	none	Tan, Lee, Mohamed (2009)
24	Free Fatty Acids	Methanol	320	100	5	97	1:7	none	none	Alenezi, Leeke, Winterbottom, Santos, Khan (2010)
25	Waste cooking oil	Methanol	300	100	20	80	1:40	none	none	Patil, Deng, Rhodes, Lammers (2010)
26	Palm oil	Methanol	372	-	16	81,5	1:40	none	none	Tan, Gui, Lee, Mohamed (2010)
27	Palm oil	Ethanol	349	-	29	79,2	1:33	none	none	Tan, Gui, Lee, Mohamed (2010)

### 17.3 The experience of the COPIRIDE FP7 project

Within the COPIRIDE project (FP7 active), Politecnico di Torino has gained experience in the complex phenomenology occurring in the supercritical trans-esterification with methanol: the development of reactor line, based on a stirred tank autoclave, proved that quite high conversions can be achieved via this route at residence times lower than 10 minutes. A further lowering of the residence time was enabled by the use of a catalyst (MgO) with limited leaching. This catalyst was found active both under super- and sub-critical conditions, in line with other investigators (e.g. Wang and Yang, 2007). Even lower residence times, possibly less

than 1 min, could be reached through a static mixer boosting up the geometrical interface surface between subcritical reacting phases. Metal foams for process intensification of conventional biodiesel synthesis are particularly attractive, since they make possible to achieve nearly complete conversions in less than one minute (Yu et al. 2010).

In order to prove the supercritical technology for the production of biodiesel, Politecnico di Torino is building a pilot-scale plant in its laboratories in the framework of the COPIRIDE project (Figure 27). The operating parameters at which the plant will be driven, and consequently at which the solutions for process intensification and control will be implemented, are gathered in Table 14, which makes this plant among the few examples worldwide of this kind.

Figure 27: Pilot-plant for continuous production of biodiesel for sub- and super-critical operations

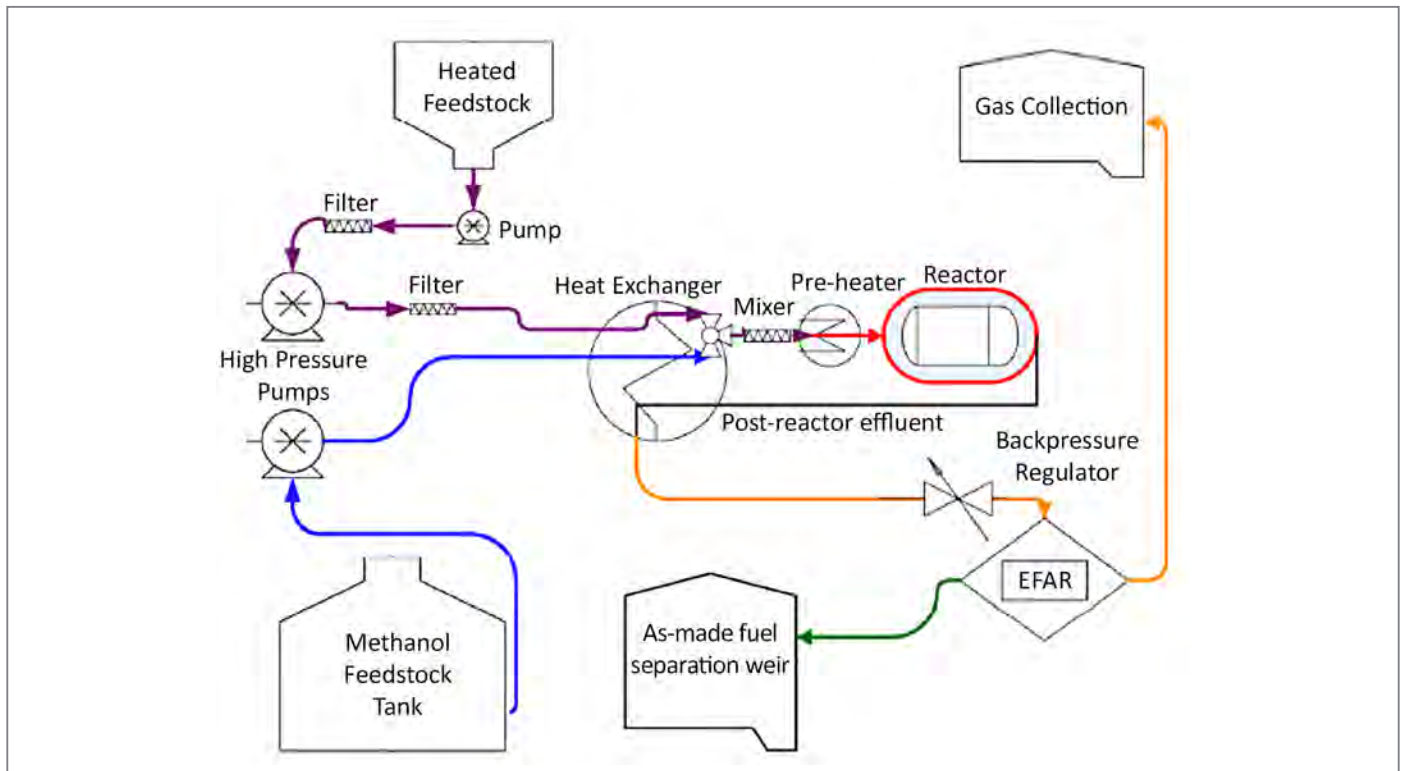

Table 14: Reaction conditions of the plant for continuous biodiesel production

Reaction conditions	
Temperature range	250-400°C
Pressure range	150-250 bar
Trans-esterification reagent	Methanol, Ethanol, Methyl Acetate
Type of oil	Waste cooking oil
Catalyst + Support	The reactor should operate without catalyst with a static mixer mean (ceramic or metallic foam). The foam might be hosting a stable and active catalyst (either electroplated or washcoated).
Catalyst/materials leaching	SiC foams, Ni foams, Ni-coated SiC foams as mixing tools.
Productivity	0,1 liter of FAME per minute

## II PART

# MEASURABLE ANALYSES: WELL-TO-WHEEL AND LIFECYCLE

## 18. INTRODUCTION TO MEASURABLE ANALYSES

In the last few decades, new powertrain technologies and alternative fuels have been proposed. There are several reasons behind the appropriateness of starting the transition from the conventional options towards the new ones: the **monopolistic situation in energy supply as regards transport systems in general**, the consequent climate change problems, the increasing restrictions on pollutant emissions, the increase in oil prices, the high dependence on oil for the road transport sector, etc.

Many points of view have to be considered: primary sources depletion, environmental impact, economic impact, geopolitical issues, etc. Concentrating the attention on the technological sector, attention is focused on the main topics of **global energy balance and environmental impact**. The energy balance addresses the management of the primary energy sources (depletion of finite sources, introduction of renewable ones) considering the criteria pertaining to the depletion of primary sources. The environmental impact addresses the effects of use of the transport systems on the environment (pollutant emissions, global warming, etc.).

Therefore, a **multi-criteria problem** has to be dealt with. This multi-criteria comparison of the different available options (both traditional and innovative) is a key point for decision makers, because a powertrain/fuel combination that addresses some criteria might not reach the target for another one.

As mentioned in the first part of this report, in order to provide an appropriate analysis on the whole energy consumption related to different alternative transport systems, some quantitative analyses have to be introduced, namely:

- 1) the well-to-wheel (WTW) analysis, a tool which was firstly proposed and consolidated in the automotive industry, but which is rarely applied to the other modes;
- 2) the life cycle analysis of any new transport infrastructure and of the transport systems themselves.

Therefore, some quantitative indexes have been proposed to take into account criteria in both the fuel cycle stage (named well-to-tank or WTT) and in the powertrain stage (named tank-to-wheels or TTW). The final objective is usually the integration of these two stages in one criteria, which has been named **well-to-wheel(s)** (or WTW).

The well-to-wheel(s) assessment is widely used in the automotive sector to analyse the efficiency and competitiveness of different powertrain/fuel options as the main differences in energy and GHG emission are due to the fuel pathways. The analysis proposes also a global index that takes into account both the energy and environmental aspects on a uniform basis, through the assignment of the costs associated to the energy and to the pollutant emissions. In short, even though the proposed global index is not an exhaustive index, it could be a useful tool for decision makers.

As regards the **life cycle analysis**, in Europe, the European Commission has recently introduced for the construction of **new transport infrastructures** the "Life-cycle costing" (LCC) as a contribution to sustainable transport development: "towards a common methodology"<sup>1</sup>. Some glimpses may be outlined at this proposal:

A. [...] "total cycle cost" should be the reference point.

"OECD countries have reduced their level of public investment over the last two decades and maintenance can [...] consume funds which were supposed to be allocated to replacement/upgrade."

B. "Level of Service (LOS) will be related not only to the civil engineering and related traffic features but also to the technological equipment of the infrastructures, in order to reach their higher safety, security, quality (queues, information) and efficiency, with a potential production of energy and availability of recharging areas for electric or hybrid vehicles, with consequent environmental outcomes. Sometimes some countries need **new transport infrastructures, to be considered with their "total cycle cost" in order to avoid the perspective, as it unfortunately happens, to be unable to maintain and upgrade the competitiveness of an existing infrastructure, losing thereafter its traffic.**

<sup>1</sup> [http://ec.europa.eu/enterprise/sectors/construction/studies/life-cycle-costing\\_en.htm](http://ec.europa.eu/enterprise/sectors/construction/studies/life-cycle-costing_en.htm)

## 19. METHODOLOGY FOR THE WTW

The Well to Tank (WTT) evaluation accounts for the **energy expended and the associated GHG emitted in the steps required to deliver the finished fuel into the on-board tank of a vehicle**. It also considers the potential availability of the fuels, through their individual pathways and the associated costs. The Tank to Wheels (TTW) evaluation accounts for the **energy expended and the associated GHG emitted by the vehicle/fuel combinations**. It also includes an assessment of the expected relative retail prices of the various vehicle configurations.

We refer to the Well to Wheels (WTW) integration, giving a global assessment of the energy required and the GHG emitted per km driven on the fuel/vehicle combinations considered.

A consensual and robust European Well-To-Wheels (WTW) analysis of all main alternative fuels and power-trains for passenger cars was jointly developed and presented first in 2003 by the European Commission's Joint Research Centre, EUCAR, and CONCAWE, the so-called JEC research collaboration. The assumptions made were clearly documented; a robust database and a transparent methodology were used, and the results were peer reviewed. Main parameters included in the study were energy consumption and efficiency, greenhouse gas emissions, cost (without externalities) and market potential.

The effective emissions of an electric car depend to a large extent on the emissions of the energy source creating the electricity. Electric cars that draw their power from an old coal power plant are only marginally cleaner from a greenhouse-gas perspective than the oil powered cars they replace, and may in fact be worse from a life-cycle perspective, especially when compared with the latest generation of diesel engines. However, they do still have all the benefits of massively reduced local air pollution.

Thus, from a holistic perspective, a case is made for low-emissions electricity generation. Looking at new generation technologies, electric vehicles are already far superior to alternatives even with combined-cycle gas power plants, and when powered by truly low-emissions energy such as nuclear or renewable, they are almost completely greenhouse-gas-emission free.

Figure 28: Some CO<sub>2</sub> emissions of ICE vs. EV PHEV

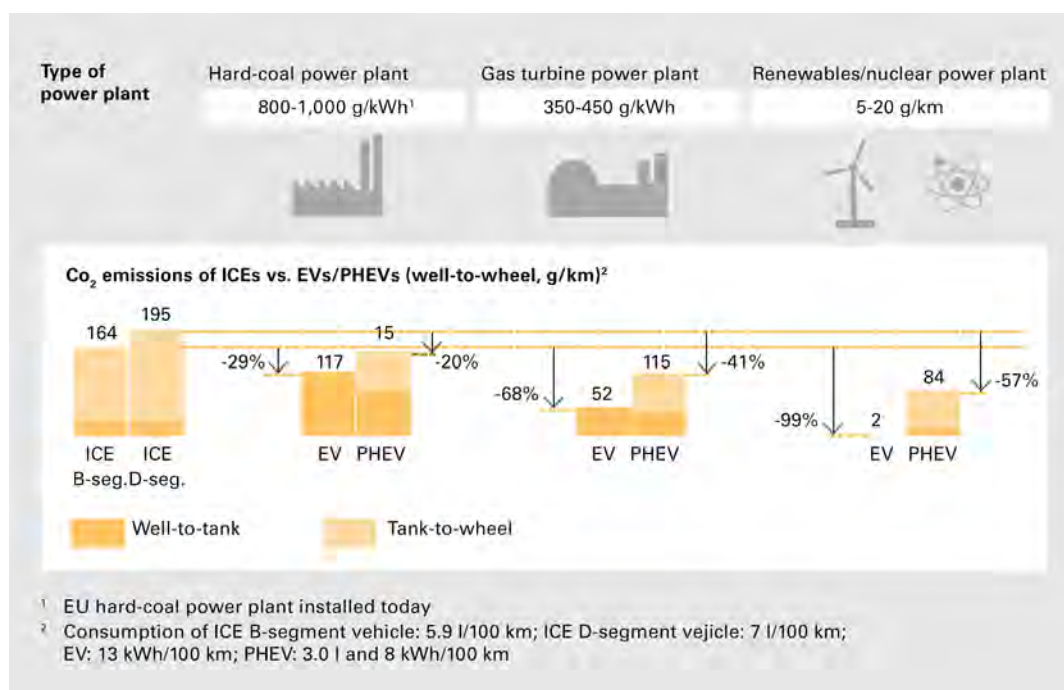

Source: BMWI, World Nuclear Association, EU Commission Roland Berger and ABB



As shown in Figure 28, introducing new low emission generation technologies can dramatically reduce CO<sub>2</sub> emissions on WTW basis.

India, like many other developing countries, is facing a rapidly growing road transport, as mentioned above. Road carries in India nearly the 87% of the total passenger traffic (Planning commission, 2007) with the strongest growth over the past 15 years in the number of two and three-wheel vehicles registered rather than cars. In 2005 the road transport was responsible for the 87% of the total CO<sub>2</sub> emissions.

When a new powertrain/fuel combination is analysed, two aspects are particularly significant: **energy efficiency** and **pollutant emissions**. A classical life cycle analysis estimates the energy and material flows associated to all the stages of a product's lifetime (cradle-to-grave). The attention is usually focused on energy consumption and on pollutant emissions.

*Moreover, in the automotive life cycle analysis, two cycles can be distinguished: the **vehicle life cycle** and the **fuel life cycle**. The vehicle life cycle includes material production, vehicle assembly, distribution, and disposal.*

*As mentioned, the fuel life cycle, which is also called well-to-wheels analysis, can be further divided into two important stages: the well-to-tank (energy consumption and emissions to extract raw materials, to transport them, to produce the desired fuel, to distribute the fuel to consumers, etc.) and the tank-to-wheels (energy consumption and emissions due to the use of the fuel in the vehicle). The energy consumption due to the fuel life cycle is in the range 80-93% compared to the total energy consumption. Therefore, in the present report, attention will be focused on the WTW analysis.*

The analysis of both energy efficiency and pollutant emissions can provide useful conclusions, which solution shows a clear advantage in terms of primary sources exploitation and which solution allows a reduction of the pollutant substances, in the overall fuel cycle. *However, a good solution concerning energy aspects from the final user's perspective might not be as good for environmental aspects, or vice versa.*

The use of energy costs and environmental costs is proposed in this report to connect energy and environmental aspects. The cost criteria has the advantage of evaluating these two aspects on a uniform basis. Cost estimation is of course a critical point. Energy cost estimation is not an easy task. One of the most critical aspects is that energy cost estimation is closely a function of market prices (both energy sources and crops), and these are not stable, therefore their forecasting is not easy.

Assigning a cost to a pollutant emission is also a complex task, due to the subjective and discretionary character of such an assignment. In the last few decades, one of the most interesting approaches has been the external costs analysis. The idea of external costs in the transport sector starts from the damage that a trip can produce on both the travellers and on the society *in general*. In the road transport sector, pollutant emissions are the most important environmental costs that mainly take into account the impact on human health, material damage, crop losses and the climate changes.

The fuels and energy vectors (ev) that have been considered are: gasoline, diesel, petrol, compressed natural gas (CNG), biofuel (bio-ethanol), hydrogen (ev) and electricity (ev).

The most common biofuel used in India is ethanol. Ethanol is obtained from bagasse in India. Bagasse is the fibrous residue left after extraction of sugar from the cane and can be a good feedstock for bioethanol (i.e. biomass-derived ethanol) production. According to the life cycle assessment report, the environmental benefits of diverting excess bagasse to ethanol production as opposed to disposing it through the current Indian practice of open-field burning include lower values for the following: carbon monoxide, hydrocarbons (except methane), SO<sub>x</sub>, NO<sub>x</sub>, particulates, carbon dioxide, methane, and fossil energy consumption. Reduced carbon dioxide and methane emissions for the ethanol scenario also lower its greenhouse potential.

In this report, the pollutants taken into account are: particulate matter (PM), nitrogen oxides (NO<sub>x</sub>), sulphur oxides (SO<sub>x</sub>) and greenhouse gases (CO<sub>2</sub>, NO<sub>2</sub> and CH<sub>4</sub>). In order to define the WTW indexes more clearly, some subscripts have been adopted: "e" for the energy indexes, "p" for the pollutant indexes, and "€" for the cost indexes.

## 19.1 Well-to-wheels energy indexes

As mentioned, the WTW index is the combination of two more specific subindexes: the WTT and the TTT indexes. The WTT takes into account the amount of energy necessary to make a fuel available for the vehi-

cle, starting from the primary energy source and going up to the refuelling of the vehicle tank (extraction, chemical processing, transport); it is useful to note that this index could be expressed in two different ways:

$$WTT_e = \frac{E_x}{F_f} \left[ \frac{MJ_x}{MJ_f} \right]$$

and

$$WTT_e^* = \frac{E_x}{D} \left[ \frac{MJ_x}{km} \right]$$

where  $E_f$  is the energy contained in the fuel mass stored in a vehicle tank,  $E_x$  is the primary energy expended to produce the finished fuel (it excludes the energy value of the fuel itself);  $D$  is a distance covered by the vehicle.

In order to show the link between  $WTT_e^*$  and  $WTT_e$ , it is necessary to define the energy TTW index. This is linked not only to the fuel, but above all to the propulsion technology. It is defined as:

$$TTW_e = \frac{E_f}{D} \left[ \frac{MJ_f}{km} \right]$$

Thus, the  $WTT_e^*$  index is

$$WTT_e^* \left[ \frac{MJ_x}{km} \right] = WTT_e \left[ \frac{MJ_x}{MJ_f} \right] \cdot TTW_e \left[ \frac{MJ_f}{km} \right]$$

$$TTW_e \left[ \frac{MJ_t}{km} \right] = WTT_e^* \left[ \frac{MJ_x}{km} \right] + TTW_e \left[ \frac{MJ_f}{km} \right]$$

Finally, the WTW index gives the total energy impact of the combination of a fuel production pathway and powertrain.

It should be noted that the subscripts "x", "f" and "t" have also been added to the energy measure unit to help to distinguish between these indexes.

## 19.2 Well-to-wheels environmental indexes

In order to take into account also environmental aspects, the WTW has been extended to evaluate the pollutant emissions linked to both the production procedure step and the final utilization of a fuel step. Two sub-indexes could also be analysed for the emissions: the WTT emission index which takes into account the pollutant mass ( $m_{p\_WTT}$ ) emitted in the extraction, chemical processing and transport. This index can also be defined in two different ways:

$$WTT_p = \frac{m_{p\_WTT}}{E_f} \left[ \frac{g}{MJ_f} \right]$$

$$WTT_p^* = \frac{m_{p\_WTT}}{D} \left[ \frac{g}{km} \right]$$

The TTW emission index takes into account the pollutant mass ( $m_{p\_TTW}$ ) emitted by a vehicle, e.g. a car, related to a reference distance: it is usually expressed in grams of pollutant emitted by a car per km.

$$TTW_p = \frac{m_{p\_TTW}}{D} \left[ \frac{g}{km} \right]$$

Thus, the link between  $WTT_p$  and  $WTT_p^*$  is

$$WTT_p^* \left[ \frac{g}{km} \right] = WTT_p \left[ \frac{g}{MJ_f} \right] \cdot TTW_e \left[ \frac{MJ_f}{km} \right]$$

Thus, the  $WTT_p^*$  index is a function of both the energy (conversion efficiency of the propulsion technology) and of the environmental aspects (emissions linked to the fuel cycle). Finally, the WTW emission index gives the total pollutant emitted from a fuel production pathway and powertrain combination

$$WTW_p \left[ \frac{g}{km} \right] = WTT_p^* \left[ \frac{g}{km} \right] + TTW_p \left[ \frac{g}{km} \right]$$

### 19.3 The connection between energy and environmental indexes

As far as energy costs are concerned, a specific cost (without taxes), referring to its energy content, can be assigned to each analysed fuel as  $c_e$  (€/MJ<sub>f</sub>), and the cost of the entire pathway is

$$WTW_{e-€} \left[ \frac{€}{km} \right] = c_e \left[ \frac{€}{MJ_f} \right] \cdot TTW_e \left[ \frac{MJ_f}{km} \right]$$

The energy costs have been conventionally assigned to the two stages, WTT and TTW, using an energy weight:

$$WTT_{e-€} = WTW_{e-€} \cdot \frac{E_x}{E_x + E_f} = WTW_{e-€} \cdot \frac{WTT_e^*}{WTW_e} \left[ \frac{€}{km} \right]$$

$$TTW_{e-€} = WTW_{e-€} \cdot \frac{E_f}{E_x + E_f} = WTW_{e-€} \cdot \frac{TTW_e^*}{WTW_e} \left[ \frac{€}{km} \right]$$

and

$$WTW_{e-€} = WTT_{e-€} + TTW_{e-€}$$

As far as environmental costs are concerned, two specific external costs can be assigned to each analysed pollutant: one refers to the WTT stage,  $c_{p\_WTT}$ , and the other refers to the TTW stage,  $c_{p\_TTW}$ . The external costs associated to the two stages, are

$$WTT_{p-€} = c_{p\_WTT} \cdot WTT_p^* \left[ \frac{€}{km} \right]$$

$$TTW_{p-€} = c_{p\_TTW} \cdot TTW_p \left[ \frac{€}{km} \right]$$

and the well-to-wheels external cost associated to the complete pathway is

$$WTW_{p-€} = WTT_{p-€} + TTW_{p-€} \left[ \frac{€}{km} \right]$$

These values can be calculated for each pollutant, therefore the total external costs, referring to all pollutants, can also be calculated as

$$WTT_{Ex\_€} = \sum_{p=1}^{NP} WTT_{p\_€} \left[ \frac{€}{km} \right]$$

$$TTW_{Ex\_€} = \sum_{p=1}^{NP} TTW_{p\_€} \left[ \frac{€}{km} \right]$$

$$WTW_{Ex\_€} = WTT_{Ex\_€} + TTW_{Ex\_€} = \sum_{p=1}^{NP} WTW_{p\_€} \left[ \frac{€}{km} \right]$$

## 20. CALCULATIONS

As an **applicative example**, we shall now find out the quantity of pollutants emitted by the different transportation modes (**road, rail, air**) carrying freight between **Delhi and Mumbai**, the two metropolitan cities of India. It is the most busiest national highway of India. This has been done using **EcoTransit website**, a practical tool used by freight services and decision makers to compare the environmental impacts of different options. The calculation of energy consumption and emission data of a worldwide transport chain can be done rather quickly with the help of EcoTransIT World.

### EcoTransIT - Ecological Transport Information Tool

The Ecological Transport Information Tool (EcoTransIT) calculates and compares the environmental impacts of goods transported by different modes. EcoTransIT compares the energy consumption, greenhouse gas and exhaust emissions of freight transported by rail, road, ship and aircraft.

The origin and destination have been inputted in terms of latitude and longitude through the use of google maps. The amount of freight has been taken to be 20 tons. Most of the heavy vehicles operating in India belong to Tata Motor Industries, which carry an average load of 20 tonnes. The data has been taken from Tata Motor Company.

#### Calculation Parameter

**Creation Date:** 04.07.2012

**Origin:** 28.536274512989912 / 77.431640625 (latitude/ longitude Delhi)

**Destination:** 19.145168196205297 / 72.94921875 (latitude/ longitude Mumbai)

**Cargo weight:** 20 ton

**Input mode:** Standard

#### Transport Chain Road – 1344.84 km 4

**Origin:** 28.536274512989912 / 77.431640625

**Road** (24-40 t, Load factor: 60.0%)

**Destination:** 19.145168196205297 / 72.94921875

#### Transport Chain Rail – 1423.55 km

**Origin:** 28.536274512989912 / 77.431640625

**Rail** (electrified, Load factor: 60.0%)

**Destination:** 19.145168196205297 / 72.94921875

#### Transport Chain Air – 1293.94 km

**Origin:** 28.536274512989912 / 77.431640625

**Air** (null, Load factor: 65.0%)

**Destination:** 19.145168196205297 / 72.94921875

The different transport modes and TTW/WTW have been differentiated by the following colors:

- Train well to tank
- Train tank to wheel
- Truck well to tank
- Truck tank to wheel
- Airplane well to tank
- Airplane tank to wheel

## Primary Energy Consumption

Energy Resource Consumption

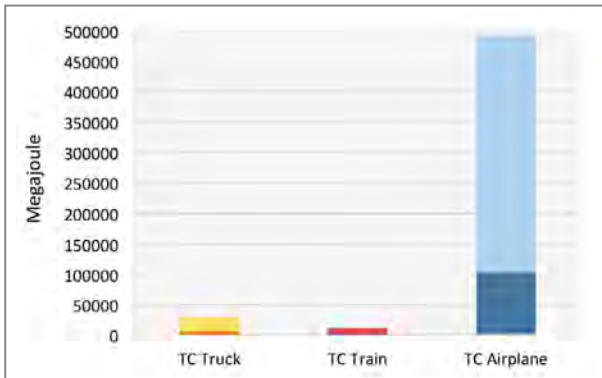

	[Megajoule]		
	TC Truck	TC Train	TC Airplane
Truck (WTT)	6284	0	271
Truck (TTW)	22526	0	970
Train (WTT)	0	2487	0
Train (TTW)	0	8914	0
Airplane (WTT)	0	0	102006
Airplane (TTW)	0	0	389894
<b>Sum</b>	<b>28809</b>	<b>11401</b>	<b>493140</b>

## Carbon Dioxide

Greenhouse Gas, Climate change

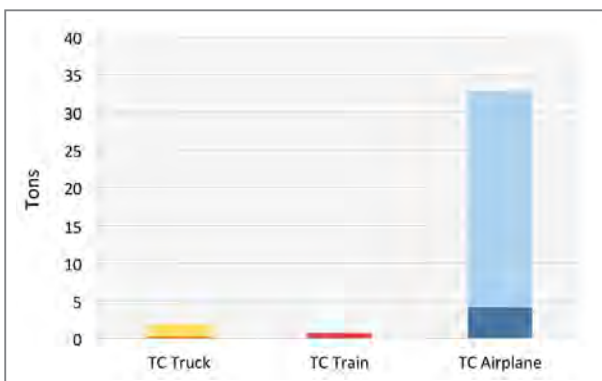

	[Tons]		
	TC Truck	TC Train	TC Airplane
Truck (WTT)	0,25	0	0,01
Truck (TTW)	1,65	0	0,07
Train (WTT)	0	0,10	0
Train (TTW)	0	0,65	0
Airplane (WTT)	0	0	4,12
Airplane (TTW)	0	0	28,59
<b>Sum</b>	<b>1,90</b>	<b>0,75</b>	<b>32,79</b>

## Nitrogen Oxides

Acidification, smog

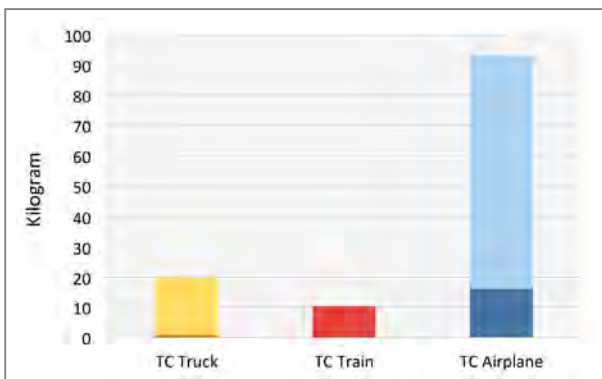

	[Kilogram]		
	TC Truck	TC Train	TC Airplane
Truck (WTT)	0,97	0	0,04
Truck (TTW)	18,76	0	0,18
Train (WTT)	0	0,38	0
Train (TTW)	0	10,04	0
Airplane (WTT)	0	0	16,00
Airplane (TTW)	0	0	76,88
<b>Sum</b>	<b>19,72</b>	<b>10,42</b>	<b>93,10</b>

## Nonmethane Hydrocarbon

Smog, damage to health

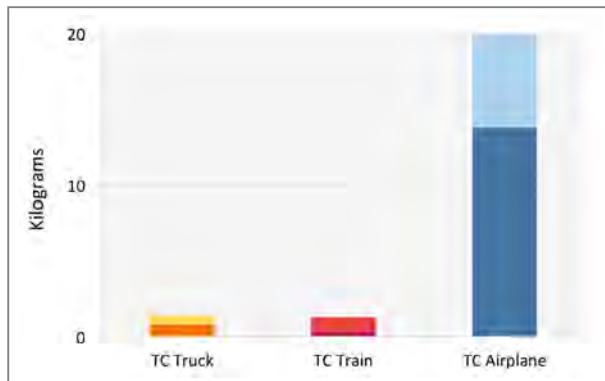

[Kilogram]

	TC Truck	TC Train	TC Airplane
Truck (WTT)	0,793	0,000	0,034
Truck (TTW)	0,636	0,000	0,002
Train (WTT)	0,000	0,314	0,000
Train (TTW)	0,000	0,945	0,000
Airplane (WTT)	0,000	0,000	13,698
Airplane (TTW)	0,000	0,000	6,157
<b>Sum</b>	<b>1,429</b>	<b>1,259</b>	<b>19,892</b>

## Sulphur Dioxide

Acidification, damage to health

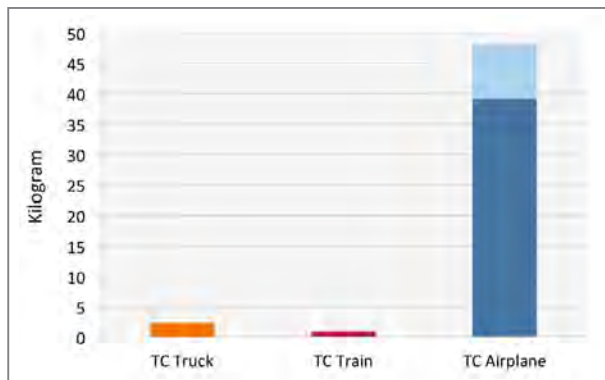

[Kilogram]

	TC Truck	TC Train	TC Airplane
Truck (WTT)	2,287	0	0,099
Truck (TTW)	0,052	0	0,002
Train (WTT)	0	0,905	0
Train (TTW)	0	0,021	0
Airplane (WTT)	0	0	39,028
Airplane (TTW)	0	0	9,076
<b>Sum</b>	<b>2,339</b>	<b>0,926</b>	<b>48,204</b>

## Particulate Matter

Combustion related

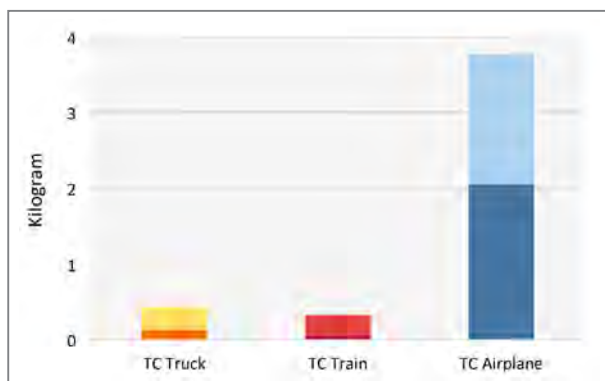

[Kilogram]

	TC Truck	TC Train	TC Airplane
Truck (WTT)	0,124	0	0,005
Truck (TTW)	0,307	0	0,002
Train (WTT)	0	0,049	0
Train (TTW)	0	0,276	0
Airplane (WTT)	0	0	2,043
Airplane (TTW)	0	0	1,716
<b>Sum</b>	<b>0,431</b>	<b>0,325</b>	<b>3,767</b>

### Main issues:

- The pollutants emitted by air transportation are very high if compared to road and rail transportation, yet air transport does not require **linear infrastructures**, as roads and railways, just punctual ones (as airports).
- The well-to-tank emissions are huge as compared to the tank-to-wheel emissions.
- The rail transport implies an infrastructure, but, if well used, it is the most convenient option.
- The Government seems to impose public laws and policies based on the tank-to-wheel emissions, without taking into account the well-to-tank emissions. **Therefore, Government policies should be based on the well-to-wheel emissions, i.e. the integration of WTT and TTW.**

If we observe, on the base of some European experiences, **the impact on the operational cost of energy consumption in railways, subways and tramways**, some indicative data – similar to one another – it emerges:

- ~4-5%, indicatively, for the Italian railways, on the overall running cost, according to some unofficial data of 2009;
- ~11% for the public transport in Milan (I), taken as an example, as energy cost on the 2009 budget, approximately 50% (5.3%) for rail systems and subway in the specific case (official data of 2009);
- ~6% as energy impact on the budget in case of the traction for the automated metro operating in Turin (I), plus an equivalent value for other electric power supply means (indicative data of 2009).

It is unmistakable that, in case of urban traction, the more frequent acceleration and braking phases lead to a greater impact of energy consumption versus the case of medium to long distance traction, as it is the case of the national railway service; such impact is even more obvious in case of high acceleration and braking in comparison with the conventional subways, as it is the case in the automated metro.

## 21. SUGGESTIONS

---

### 1. Demand management

- Improved **land-use planning**: lower growth in passenger·kilometres and tone·kilometres, by improved land-use planning and the matching of jobs, schools, shopping centres and transport corridors to the location of residential areas.
- Better **telecommunication facilities** may also reduce the demand for transport, beside satisfying the future needs of **Intelligent Transport Systems** (where is the bus, how much traffic is there, what is the expected time of travel?...).
- Government policies and actions such as those concerning **road pricing**, taxation and imports, land-use and urban planning, public transport support systems.
- Development of **alternative fuels and institution of administrative and regulatory measures**.

### 2. Technological improvements: should be primarily focused on **rail – including metros, tramways, ropeways and automated people movers in general – and road transport**, as these are the pre-dominant means of transport.

- Improving fuel efficiency.
- Poor public transportation: “Buses have cheaply fabricated bodies, each built on a 110-BHP truck chassis designed for a payload of 10 tonnes, although the actual loading, which tends to be less than 7 tonnes, needs only about 90-BHP. Body designs are 40 years old in Delhi and 70 years old in the case of double-deckers in Bombay. Even urban buses have narrow aisles, high floor levels and narrow doorways. In place of the needed maximum speeds of say 50 kmph for inter-city buses, and lower speeds and high pick-up for urban buses, the present buses allow speed up to 80 kmph and low pick-up, leading to higher fuel use and pollutant emissions. Substantial fuel saving is possible by mandating the use of properly designed urban and inter-city buses” [Reddy, 1991].

### 3. Improvement of the capacity and quality of road infrastructure

- Road capacity and quantity also play a critical role in the fuel performance of the vehicles as well as in road congestion, safety and pollution from vehicle emissions. A study by the Central Road Research Institute indicated that 90% of even the national highways are non-motorable by world standards. 60% of the length of state highways has poor riding quality and substandard geometry. One estimate predicts a saving of at least 10% automobile fuel consumption by better-maintained roads [Patankar, 1992].
- Till now major concern has been to achieve rural connectivity by constructing national highways.
- **Segregated lanes for public transport even operating on roads**.

#### 4. Traffic Management

- Intelligent Transportation System
- Non-availability of **footpaths and cycle-paths** and use of the limited road space for non-transport purposes (hawking, stacking of materials, parking, etc.) result in the congestion of roads and the slowing down of traffic
- **Road pricing** and eco driving

5. **Urban transport planning and management should encourage public transport** in preference to private transport owing to the huge population of India. They should also recognize the significant role of environment-friendly slow-moving modes (**pedestrians, cycles, rickshaws**) and adequately provide a separate broad path for them.

## 22. FINAL REMARKS

---

This study sought to verify the contributions of different fuel-technology combinations in achieving the reduction of emissions in the transport sector. To achieve this reduction objective, it is necessary to develop alternative vehicle technologies as well as the related infrastructure for alternative energy carriers.

The study found that there is **no single solution** which can be used for all transport modes, as the only available **energy carrier** for this purpose, **biofuels**, cannot be produced to the amounts necessary in a sustainable manner. Biofuels should therefore be used selectively for transport modes where electric vehicles and fuel cells are not expected to be technically viable. For passenger cars and LDVs the development of **Hybrid electric vehicles (HEV)** in short-medium term, of battery electric and, in some cases, fuel cell vehicles probably in long-term, should be pursued, keeping in mind the different upfront costs of the technologies.

The possibility of large scale market penetration of both battery electric vehicles and fuel cell vehicles in long term is highly dependent on the future developments of the basic technology they require, either the battery or the fuel cell. Literature sources claim that it is possible that these technologies will obtain sufficient development to start penetrating the market within the next 10 to 15 years. If only one of the two technologies would reach the technology development necessary for penetrating the market of light-duty vehicles (i.e. covering all possible distance and weight segments of LDVs) contemporarily or slightly prior to large scale penetration the refuelling/recharging infrastructure would be built (necessary condition), then this technology would dominate the market and be able to substitute oil based fuels. If in addition the energy carrier is produced with low or free carbon sources then the development would comfortably lead to a approx. 60% reduction in transportation emissions by 2050.

The development of both technologies, battery and fuel cell, is highly dependent on R&D and infrastructure development expenditures, which rely at least to a certain extent on public resources and on public initiative.

Energy supply for transport could take a large number of different pathways as shown in Figure 29. Alternative fuels will gradually become a much more significant part of the **energy mix**: no single substitution candidate, however, can be foreseen. Fuel demand and greenhouse gas challenges will most likely require **the use of a great variety of primary energies**. There is rather broad agreement that all sustainable fuels will be needed to resolve the expected supply-demand tensions.



Figure 29: Energy pathways in transport and other sectors

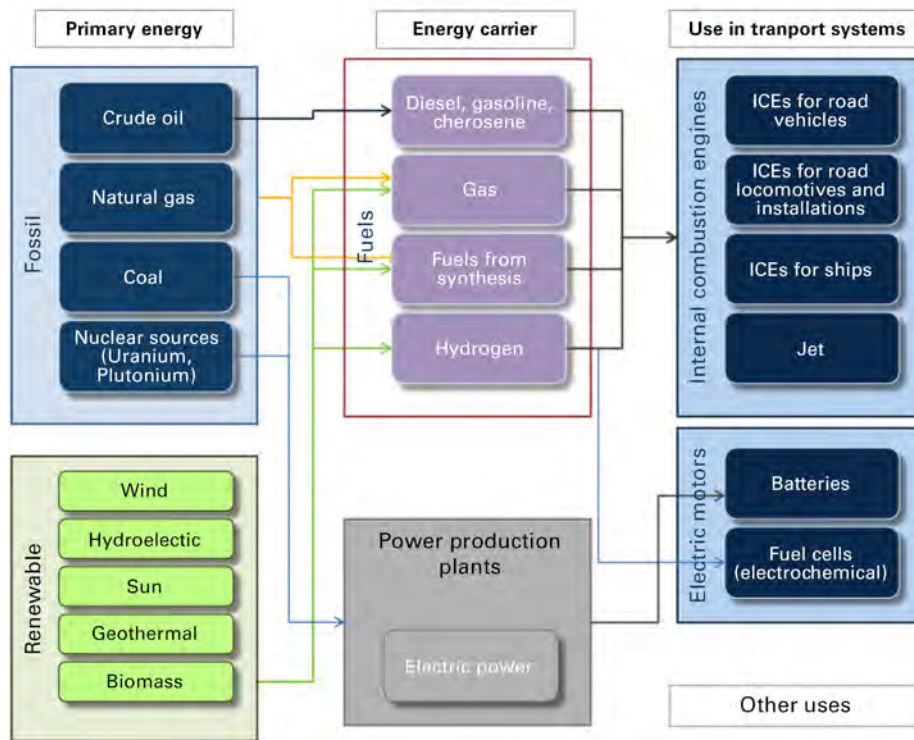

(Source: modifications from a basis by ERTRAC)

As regards the road vehicles, Figure 30 reports a possible scenario for the future traction and propulsion, on the base of the WTW analysis, interaction of the production with the territory and energy availability (Report of the European Expert Group on Future Transport Fuel, 2011).

Figure 30: A perspective on road vehicle traction and propulsion on the basis of WTW analysis, interaction of the production with the territory and energy availability

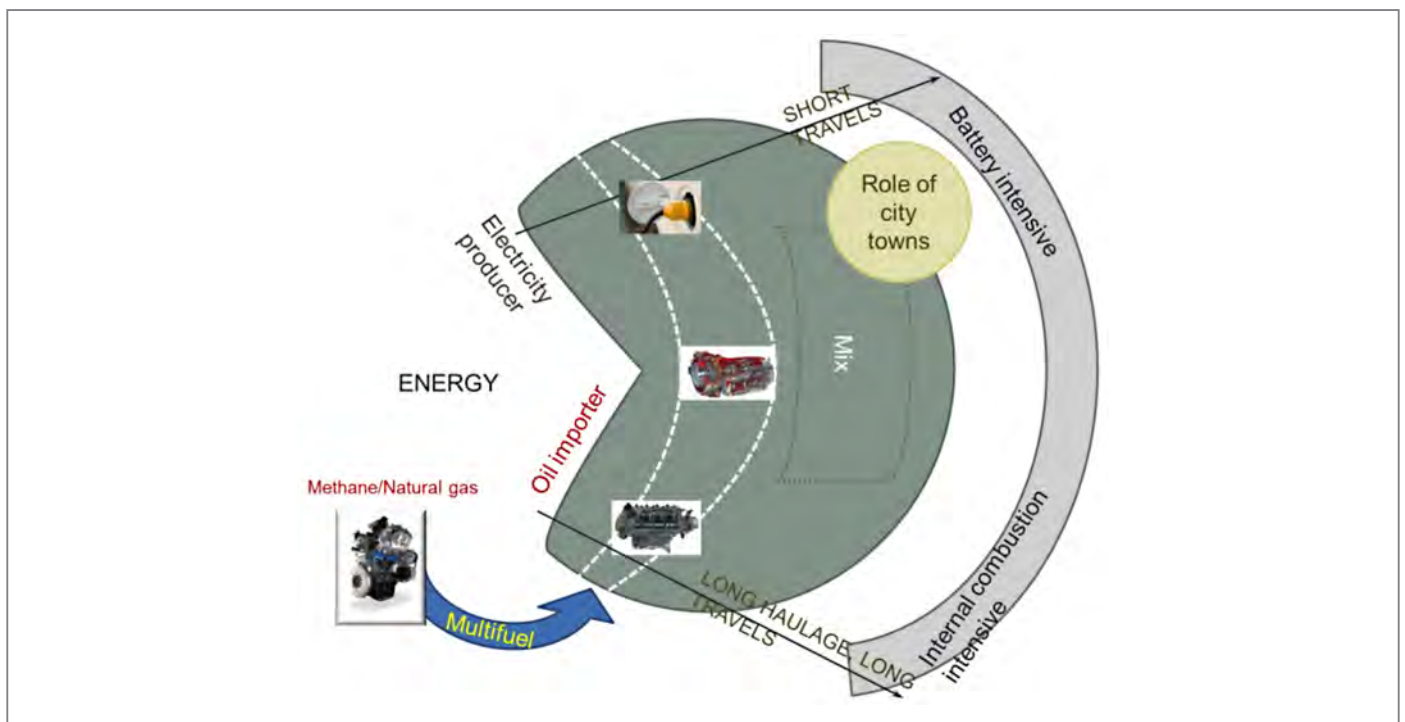

(Politecnico di Torino, 2011)

In case of extended use of *electric traction*, the problem might be to reverse partially to the electric grid a sector which weights in Europe – as India is increasing rapidly in the same direction – for nearly *one third of the overall energy consumption and which aims to exit from the monopoly of that energy source that it chose at the beginning of the last century*. As a matter of fact and as previously mentioned, various alternative solutions, from the engine (ICEs) efficiency to the hybrid-electric and full-electric vehicles (charged on the grid, with a quote likely variable from Nation to Nation and from Region to Region), to a higher load on public transport based on electric power, to alternative primary energies, including **Natural Gas**, may arise in the next future.

## 23. CONCLUSIONS

---

We may synthesize the main results in the sentence: *use of lower personal energy in motorised mobility in order to reduce the fuel consumption per person and consequent emissions*. This aim can be pursued either through *higher capacity transport modes*, yet guaranteeing as far as possible vehicles loaded more than the break-even of energy, or with a low level of energy used for personal vehicles in movement (scooters, rickshaws, ...). The WTW analysis synthesises, in effect, most of this idea.

The other two main issues which emerge are:

- Inverse relationship between space and energy: provide more public space to more energy-efficient vehicles; segregated lanes for public transport, runways for bicycles, ITS (intelligent transport systems);
- LCC, life cycle cost, for any new infrastructure.

There would be also another point, for which probably India is not ready, neither Europe at this moment: *road pricing*; circulation taxes based on actually use of the roads; and this is feasible through new technologies.

The assignment of space to road transport should, at first, take into account the energy used by transport modes, possibly with a WTW analysis at the base, and any analysis on new infrastructures should include not only the coverage of their investment but also the capability to maintain them and equip them with modern technologies (ITS) during their whole life cycle. Currently, resources lack concern space – mostly in Indian cities rather than outside them – and energy. Therefore, these should constitute the constraints on any decision-making process regarding high-level transport planning.

An important issue is that the Government has the duty to guarantee free movement to the citizens: the high traffic at certain times of the day in Indian cities is a contradiction to this. Therefore people should have the freedom to choose their most suitable transport means: on foot, by bicycle, by bus, metro, rickshaws, personal cars and so on. Yet this can only be feasible if high level transport plan – in accordance with the above-mentioned goals – is put in place by the Government, before traffic becomes a restriction to personal mobility.

## 24. BIBLIOGRAPHY

---

### 24.1 For all chapters

1. Government of India, Annual Report 2011-12, Ministry of Road Transport and Highways
2. Government of India, Eleventh and Twelfth Five Year Plan, Ministry of Road Transport and Highways. Selected Socio-Economic Statistics, October 2011, Ministry of Statistics and Programme Implementation
3. Government of India, Passenger and Freight Traffic Assessment and Adequacy of Fleet and Data Collection and Use of IT in Transport Sector in the Twelfth Five Year Plan, Ministry of Road Transport and Highways
4. Government of India, Road Accidents in India 2010, Transport Research Wing

5. Lawrence Berkeley National Laboratory, "What do India's transport energy data tell us? A bottom-up assessment of energy in India transportation sector"; Nan Zhou, Jayant Sathaye, Michael A. McNeil, Mark Levine, Stephane de la Rue du Can, Environmental Energy Technologies Division
6. CNG programme in India: The future challenges- Anumita Roychowdhury, Fact Sheet Series, Centre for Science and Environment, 2010
7. Berkeley National Laboratory, Residential and Transport Energy Use in India: Past Trend and Future Outlook, Ernest Orlando Lawrence, January 2009
8. Government of India, Basic Statistics on Indian Petroleum & Natural Gas 2010-11, Ministry of Petroleum & Natural Gas
9. Energy for a sustainable road/rail transport system in India, Amulya K.N. Reddy, Y.P. Anand, Antonette D'Sa, Energy for Sustainable Development, Volume IV No. 1, June 2000
10. International Energy Agency, International Energy Outlook 2011, U.S. Energy Information Administration Energy Transition for Industry: India and the Global Context
11. Torchio M.F., Santarelli M.G. , Energy, environmental and economic comparison of different powertrain/fuel options using well-to-wheels assessment, energy and external costs e European market analysis. Energy, 5, 2010
12. International Energy Agency, CO2 emissions from fuel combustion, International Energy Agency 2010 edition
13. Natural Gas in India, International Energy Agency 2010
14. EcoTransit Website, <http://www.ecotransit.org>, used on 2012
15. Transportation Energy DataBook, Oak Ridge National Laboratory, U.S Department of Energy, July 2012
16. Clean Transport Systems, European Commission, Final Report, November 2011
17. Government of India, INDIA'S GHG Emission profile - Results of Five climate modelling Studies, Climate Modelling Forum, India, Supported by Ministry of Environment and Forests, September 2009
18. Dalla Chiara B., Pinna I., On issues of sustainable transport, International congress - Motor vehicles and Motors 2012, "Sustainable development of automotive industry", 3-5 October Kragujevac - Serbia, ISBN 978-86-86663-90-0 (abstract), 978-86-86663-91-7

## 24.2 For chapter 17

19. Alenezi R., G.A. Leeke, J.M. Winterbottom, R.C.D. Santos, A.R. Khan, Esterification kinetics of free fatty acids with supercritical methanol for biodiesel production, Energy Conversion and Management 51, 1055–1059
20. Bloch M., I. Bournay, D. Casanave, J.A. Chodorge, V. Coupard, G. Hillion, D. Lorne, 2008 Fatty acid esters in Europe: market trends and technological perspectives. Oil Gas Sci. Technol. 63, 405–417
21. Cao W., H. Hen, J. Zang, 2005 Preparation of biodiesel from soybean oil using supercritical methanol and co-solvent. Fuel 84, 347-351
22. Demirbas A., 2002 Biodiesel from vegetable oils via transesterification in supercritical methanol, Energy Conversion and Management 43, 2349-2356
23. Demirbas A., 2003 Biodiesel fuels from vegetable oils via catalytic and non-catalytic supercritical alcohol transesterifications and other methods: a survey, Energy Conversion and Management 44, 2093–2109
24. Demirbas A., 2006 Biodiesel from sunflower oil in supercritical methanol with calcium oxide, Energy Conversion and Management 48, 937-941
25. Demirbas A., 2009 Preparation of biodiesel from waste cooking oil via base-catalytic and supercritical methanol transesterification, Energy Conversion and Management 50, 923-927
26. Gui M.M, K.T. Lee, S. Bhatia, 2009 Supercritical ethanol technology for the production of biodiesel: Process optimization studies, The Journal of Supercritical Fluids 49, 286–292 2009
27. Kasim N.S., T.H. Tsai T.H., S. Gunawan, Y.H. Ju, 2009 Biodiesel production from rice bran oil and supercritical methanol, Bioresource Technology 100(8), 2399–2403
28. Kusdiana, D. and S. Saka, 2001 Kinetics of transesterification in rapeseed oil to biodiesel fuel as treated in supercritical methanol, Fuel 80, 693–698
29. Hawash S., N. Kamal, F. Zaher, O. Kenawi, G.E. Diwani, G.E., 2009 Biodiesel fuel from Jatropha oil via non-catalytic supercritical methanol transesterification, Fuel 88(3) 579-582
30. Ilham Z. and S. Saka, 2009, Dimethyl carbonate as potential reactant in non-catalytic biodiesel production by supercritical method, Bioresource technology, 100, 1793–1796

31. Isayama Y. and S. Saka, 2008 Biodiesel production by supercritical process with crude bio-methanol prepared by wood gasification. *Bioresour Technol.* 99(11), 4775-4779
32. Madras G., C. Kolluru, R. Kumar, 2004 Synthesis of biodiesel in supercritical fluids, *Fuel* 83, 2029–2033
33. Minami E. and S. Saka 2006 Kinetics of hydrolysis and methyl esterification for biodiesel production in two step supercritical methanol process, *Fuel* 85, 2479-2483
34. Patil P., S. Deng, J.I. Rhodes, P.J. Lammers, 2010 Conversion of waste cooking oil to biodiesel using ferric sulfate and supercritical methanol processes, *Fuel* 89, 360–364
35. Saka S. and Y. Isayama, 2009, A new process for catalyst-free production of biodiesel using supercritical methyl acetate, *Fuel*, 88, 1307-1313
36. Tan K.T., K.T. Lee, A.R. Mohamed, 2009 Production of FAME by palm oil transesterification via supercritical methanol technology, *Biomass and bioenergy* 33(8), 1096–1099
37. Tan K.T., M.M. Gui, K.T. Lee, A.R. Mohamed, 2010 An optimized study of methanol and ethanol in supercritical alcohol technology for biodiesel production, *The Journal of Supercritical Fluids* 53, 82–87
38. Varma M.N., P.A. Deshpande, G. Madras, 2010 Synthesis of biodiesel in supercritical alcohols and supercritical carbon dioxide, *Fuel* 89(7), 1641–1646
39. Wang L and J. Yang , 2006 Transesterification of soybean oil with nano-MgO or not in supercritical and subcritical methanol, *Fuel* 86, 328-333
40. Warabi Y., D. Kusdiana, S. Saka 2004 Reactivity of triglycerides and fatty acids of rapeseed oil in supercritical alcohols. *Bioresource Technology* 91, 283-287
41. Yin J.Z., M. Xiao, J.B. Song, 2008 Biodiesel from soybean oil in supercritical methanol with co-solvent, *Energy Conversion and Management* 49, 908–912
42. Yu X., Z. Wen, Y. Lin, S.T. Tu, Z. Wang, J. Yan, 2010 Intensification of biodiesel synthesis using metal foam reactors, *Fuel* 89(11), 3450-3456