

# EXERGETIC AND THERMOECONOMIC APPROACH FOR OPTIMAL PLANNING OF DISTRICT ENERGY SYSTEMS

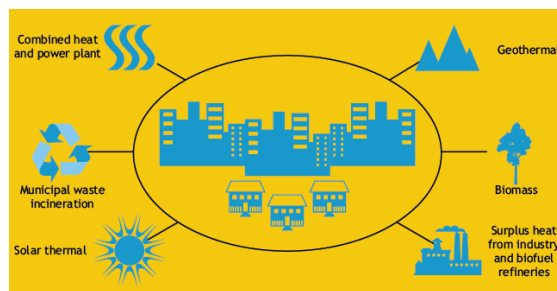

ALBANA KONA

Author's e-mail: [albana.kona@polito.it](mailto:albana.kona@polito.it)

Author's address: Via Carlo Noè 14, 15040, Bozzole (Al), Italy

---

# Acknowledgments

My time as a PhD student has been rewarding. The work atmosphere at Energy Department has been creative and stimulating and I thank everyone involved for contributing to this. I want to thank my supervisor Professor Vittorio Verda for visionary discussions, support and enthusiasm that have always left me encouraged.

The work has been carried out under various research programme, such as the collaboration with Azienda Multiservizi Casalese s.p.a. A very special thank to eng. Fabrizio Gallina for the support and the useful information given during all this period, which has been fundamental for the elaboration of this PhD thesis.

Thank you: Lushi, Vasil, nonna Zoy e nonna Mala for your support, emotional as well as practical, such as minding my kids. You are really part of this thesis!

Thanks to all my family and friends for lifting my spirit!

Thank you my dear Roberto for your unfailing belief in me and for your love. I do listen to your encouraging words even if I not always confess to it! You were so proud of me when I won the PhD position, and I am so grateful of having you my sweetheart as my partner in this journey.

Last but not least; to my beloved children: Lorenzo and Caterina Maria: thank you for coming into my life and making it so much richer. I hope god will give me enough time to bring you up and love you my dearest!

---

# Contents

<b>PREFACE</b> .....	<b>7</b>
<b>1 INTRODUCTION</b> .....	<b>9</b>
1.1 CLASSIFICATIONS OF DISTRICT HEATING SYSTEMS.....	12
1.1.1 <i>CHP based DH systems</i> .....	13
1.1.2 <i>Renewable energy</i> .....	15
1.1.3 <i>Waste to energy</i> .....	18
1.2 FUTURE OF DISTRICT HEATING SYSTEMS.....	20
1.2.1 <i>Heat storages systems in DHS</i> .....	21
<b>2 OPTIMIZATION MODELS FOR DISTRICT HEATING SYSTEMS</b> .....	<b>24</b>
2.1 STATE OF THE ART.....	25
2.2 DEFINITION OF THE OPTIMIZATION MODEL.....	26
2.3 OBJECTIVE FUNCTION: MINIMUM SPECIFIC PRIMARY ENERGY CONSUMPTION.....	28
2.4 OBJECTIVE FUNCTION: MINIMUM ECONOMIC COST .....	30
2.5 MULTI-OBJECTIVE OPTIMIZATION .....	31
<b>3 EXERGETIC AND THERMOECONOMIC APPROACH FOR DISTRICT HEATING SYSTEMS</b> .....	<b>34</b>
<b>4 GLOBAL OPTIMIZATION METHODOLOGY</b> .....	<b>40</b>
4.1 OPTIMAL CONFIGURATION .....	41
4.1.1 <i>Building DBS</i> .....	46
4.1.2 <i>Thermo fluid-dynamics model</i> .....	48
4.1.3 <i>Costing model</i> .....	50
4.1.4 <i>Energy production model</i> .....	54
4.2 TIME EVOLUTION OF THE NETWORK .....	62
<b>5 CASE APPLICATIONS</b> .....	<b>63</b>
5.1 CASE APPLICATION WITH ENERGY BASED OBJECTIVE FUNCTION .....	66
5.2 CASE APPLICATION WITH ECONOMIC OBJECTIVE FUNCTION .....	72
5.3 CASE APPLICATION WITH MULTI-OBJECTIVE FUNCTION .....	78
<b>6 CONCLUSIONS</b> .....	<b>84</b>
<b>BIBLIOGRAPHY</b> .....	<b>86</b>

---

## List of figures

FIGURE 1.1 THE PRINCIPLES OF DH (RIGHT) THE HYDRAULIC INTERFACE UNIT (SOURCE BRE) .....	10
FIGURE 1.2. MAP OF CITIES WITH DISTRICT HEATING SYSTEMS.....	11
FIGURE 1.3 LARDERELLO GEOTHERMAL PLANT .....	11
FIGURE 1.4 MAJOR COMBUSTION INSTALLATIONS ABOVE 50 MW FOR POWER AND HEAT GENERATION IN EUROPE .....	14
FIGURE 1.5 THE CHP POWER PLANT OF TORINO NORD.....	15
FIGURE 1.6 SOLAR DISTRICT HEATING IN DENMARK .....	16
FIGURE 1.7 LOCATIONS OF 414 WASTE INCINERATION PLANTS IN EUROPE. ....	18
FIGURE 1.8 SKETCH OF GOTEBOG DISTRICT HEATING POWER PLANT .....	19
FIGURE 1.9 PRINCIPLE OF BEDDING DH TANKS .....	22
FIGURE 2.1 FLOW CHART OF THE OPTIMIZATION PROCEDURE .....	27
FIGURE 2.2 PARETO FRONT OF TWO OBJECTIVES PROBLEM.....	32
FIGURE 3.1 SPECIFIC PRIMARY ENERGY CONSUMPTION FOR EACH USER CONNECTED TO THE DHN .....	37
FIGURE 3.2 ECONOMIC COST OF HEAT FOR EACH USER CONNECTED TO THE DHN .....	38
FIGURE 4.1 CONCEPTUAL DIAGRAM OF THE DEVELOPED METHODOLOGY .....	41
FIGURE 4.2 A SKETCH OF EXCAVATION FOR THE NETWORK INSTALLATION .....	53
FIGURE 4.3 DISTRICT HEATING SYSTEM BORDERS.....	54
FIGURE 4.4 CUMULATIVE HEAT PRODUCTION FOR THE THERMAL PLANT .....	55
FIGURE 4.5 DISTRICT HEATING SYSTEM BORDERS.....	55
FIGURE 4.6 THERMAL PLANT SYSTEM BORDERS .....	56
FIGURE 4.7 COMPUTATIONAL DOMAIN AND SLICE TEMPERATURE DISTRIBUTION FOR UNBALANCED HEAT LOAD .....	58
FIGURE 4.8 GROUNDWATER TEMPERATURE DEVIATIONS AND EFFECTS ON THE HEAT PUMP COP .....	59
FIGURE 5.1 THE SUBDIVISION OF THE CITY INTO THE MACROZONES .....	64
FIGURE 5.2 A SKETCH OF THE DHN OF CASALE MONFERRATO .....	65
FIGURE 5.3 THE AVERAGE PRIMARY ENERGY CONSUMPTION OF THE MACROZONES CONNECTED TO THE DHN .....	66
FIGURE 5.4 THE AVERAGE ENERGY COST OF HEAT BASED ON DETERMINISTIC.....	67
FIGURE 5.5 THE AVERAGE ENERGY COST OF HEAT BASED ON DETERMINISTIC.....	67
FIGURE 5.6 THE AVERAGE ENERGY COST OF THE ENERGY SYSTEM (COP 4 AND CHP 40%) .....	68
FIGURE 5.7 SIMULATIONS OF THE AVERAGE ENERGY COST OF HEAT: COP4, CHP 40% .....	69
FIGURE 5.8 AVERAGE ENERGY COST OF HEAT OF THE ENERGY SYSTEM WITH DHN AND COND. BOILERS.....	71
FIGURE 5.9 AVERAGE ECONOMIC COST OF HEAT SUPPLIED TO THE ZONES BY DHN WITH A CHP RATIO OF 50% .....	72
FIGURE 5.10 THE AVERAGE ECONOMIC COST OF HEAT OF THE ENERGY SYSTEM COP 4 AND 5, CHP 40% DETERMINISTIC APPROACH .....	73
FIGURE 5.11 THE AVERAGE ECONOMIC COST OF HEAT OF THE ENERGY SYSTEM COP 5 AND DIFFERENT CHP RATION – DETERMINISTIC APPROACH.....	73
FIGURE 5.12 THE AVERAGE ECONOMIC COST OF HEAT OF THE ENERGY SYSTEM COP 4 AND CHP 40%.....	74
FIGURE 5.13 THE AVERAGE ECONOMIC COST OF HEAT OF THE ENERGY SYSTEM COP 4 AND CHP 40%.....	74
FIGURE 5.14 AVERAGE ECONOMIC COST OF HEAT OF THE ENERGY SYSTEM WITH DHN AND COND. BOILERS – DETERMINISTIC APPROACH .....	76
FIGURE 5.15 THE PARETO FRONT OF THE MULTI-OBJECTIVE OPTIMIZATIONS - COP 4 .....	80
FIGURE 5.16 THE PARETO FRONT OF THE MULTI-OBJECTIVE OPTIMIZATIONS - COP 5 .....	83

---

## *List of tables*

TABLE 1.1. DHS IN ITALY ON 2011.....	12
TABLE 4.1 THE FREQUENCIES OF THE MINIMUM COST .....	44
TABLE 4.2 THE CONFIGURATION OF THE DHN WITH DIFFERENT VALUES OF THE PROBABILITY FUNCTION .....	44
TABLE 4.3 FEATURES OF THE THERMAL REQUEST OF THE USERS .....	47
TABLE 4.4 PRIMARY ENERGY CONSUMPTIONS [MJ/KG] ASSOCIATED WITH THE MATERIALS AND COMPONENTS.....	53
TABLE 4.5 PRIMARY ENERGY CONSUMPTIONS [MJ/M <sup>2</sup> ] ASSOCIATED WITH THE INSTALLATION LABOUR.....	53
TABLE 5.1 THE MAP OF THE MACROZONES INTO WHICH THE CITY OF CASALE MONFERRATO HAS BEEN DIVIDED.....	64
TABLE 5.2 SUMMARY OF ENERGY BASED OPTIMIZATIONS WITH COP 4 AND CHP RATIO 40% (1000 ITERATIONS).....	69
TABLE 5.3 SUMMARY OF ENERGY BASED OPTIMIZATIONS WITH COP 4 AND VARYING THE CHP RATIO (20000 ITERATIONS) .....	70
TABLE 5.4 SUMMARY OF ENERGY BASED OPTIMIZATIONS WITH COP 5 AND VARYING THE CHP RATIO ( 20000 ITERATIONS) ....	70
TABLE 5.5 THE MINIMUM OF THE AVERAGE ENERGY COST OF HEAT WITH 1000 ITERATIONS, UTILIZING CONDENSING BOILERS AS THE ALTERNATIVE TECHNOLOGY.....	71
TABLE 5.6 SUMMARY OF ECONOMIC BASED OPTIMIZATIONS WITH COP 4 AND CHP RATIO 40% (1000 ITERATIONS).....	74
TABLE 5.7 SUMMARY OF ECONOMIC BASED OPTIMIZATIONS WITH COP 4 AND DIFFERENT CHP RATIO (1000 ITERATIONS).....	75
TABLE 5.8 SUMMARY OF ECONOMIC BASED OPTIMIZATIONS WITH COP 5 AND DIFFERENT CHP RATIO (1000 ITERATIONS) .....	76
TABLE 5.9 SUMMARY OF ECONOMIC OPTIMIZATION WITH CHP RATIO 50% WITH 1000 ITERATIONS - PROBABILISTIC APPROACH .....	77
TABLE 5.10 THE OPTIMAL CONFIGURATION BY PERFORMING THE SINGLE OBJ. FUNCTIONS.....	78
TABLE 5.11 SUMMARY OF MULTIOBJECTIVE OPTIMIZATIONS WITH COP 4.....	79
TABLE 5.12 THE OPTIMAL CONFIGURATION BY PERFORMING THE SINGLE OBJ. FUNCTIONS COP 5 .....	80
TABLE 5.13 SUMMARY OF RESULTS OBTAINED WITH MULTI-OBJECTIVE OPTIMIZATION - COP 5 .....	82

---

# Preface

A sustainable urban energy planning for achieving the EU 2020 and 2050 energy goals requires adopting a systemic approach based on reducing end-user energy requirements, recycling energy that otherwise would be wasted and replacing fossil fuels by renewable. District Heating and District Cooling play a key role in such a concept.

From the sustainability viewpoint, district heating is an important option to supply heat to the users in urban areas. The energy convenience of such option depends on the annual energy request, the population density and the efficiency in heat production. Among the alternative technologies, geothermal heat pumps (both open loop and closed loop heat pumps) play a crucial role.

In order for the DHN to remain an effective solution with respect to alternative technologies, the optimal configuration, design and operation must be investigated.

This thesis aims to propose a methodology for the Multiobjective Optimizations of district heating networks, where the objective functions (the minimum specific primary energy consumption or the minimum economic cost) of a district heating network are investigated using a thermoeconomic based probabilistic procedure.

A procedure, derived from Simulating Annealing optimization technique, to select which users in a urban area should be connected with a district heating network and which ones should be heated through an alternative technology is proposed. The goal of this procedure is to reach a globally optimal system from the energy and economic viewpoints.

The procedure proposes district heating as the initial choice for all the users. The users are then progressively disconnected to the network, according with the primary energy required to supply them heat, and the alternative technology is considered for disconnected users. Here, ground water heat pump and condensing boilers are considered as the alternative technologies.

The optimization technique developed in this PhD thesis develops the three levels of the optimization of energy systems:

- Development of a Synthetic Method: The optimal synthesis is performed through a method which starts with a superstructure (where all the buildings (users) in the considered area for the expansion of DH network are supplied by district heating network) and then reduced to the optimal configuration (some of the users are disconnected from the DHN and supplied with an alternative technology such as geothermal heat pumps or condensing boilers).
- Development of Optimal Design Method for the components and the properties at the nominal load selected in order to reach optimal performances:

- 
- as the users are disconnected from the district heating network, the mass flow rate flowing in the pipes is reduced resulting in different pipe diameters in comparison to the initial configuration. The optimal value velocity in the pipes is obtained as a function of the pipe diameters;
  - The cogeneration ratio (the ratio between the thermal power of the CHP appliances and the total thermal power installed in the power station ) has been considered as a parameter in the optimal design of the system.
  - Development of Optimal Operating properties: the operating properties under specific conditions has been changed, like the operating supply temperatures, but also the evolution of the network during its construction is considered.

The application to an Italian town is considered as a test case. The main advantage of this procedure is that complex networks, like the DHN in Casale Monferrato characterized by 198 users, grouped in 21 macrozones, can be easily processed. The optimal configuration of the overall urban heating system is obtained. This configuration corresponds to the minimum primary energy request to supply heat to all the users (those connected to the network and those using an alternative heating system).

After a brief introduction where the district heating technology is presented, the Thesis is divided in two parts: the first part introduces the methodological approach proposed for the optimization of a District heating network, together with the description of the optimization model. The second part focuses on a specific application case, showing the preliminary operations required for the application of the model and the results obtained from the optimizations performed. The results have been interpreted trying to reach a more general conclusion which is not related only to the specific case study.

The following papers have been originated from the research work that has been performed: two articles published in International journal papers and two articles published in conference proceedings.

The paper [[Verda and Kona 2012](#) ] has been awarded as the best paper of the conference ECOS 2012. (Efficiency, Cost, Optimization and Simulation of energy conversion systems and processes).

A paper proposing the application of the multi-objective optimization is also under submission.



---

# 1

## Introduction

District Heating (DH) is a comprising technology that can make significant contributions to the reduction of emissions (carbon dioxide and air pollution) and to increasing energy security. The main idea of DH is simple but powerful: connect multiple thermal energy users through a piping network to environmentally optimum energy sources, such as combined heat and power (CHP), industrial waste heat and renewable energy sources [IEA 2008].

DH schemes comprise a network of pipes connecting the buildings in urban areas, so they can be served from centralized plants. This approach allows any available source of heat to be used, including combined heat and power plants (CHP), Waste-to-Energy, industrial heat surpluses, and renewable. In general, a number of factors contribute to a success of DH networks. These include [Wiltshire 2011]:

- climate;
- the population density of the considered area;
- a source or sources of cheap fuel nearby;
- high prices for competing oil and gas;
- the technical ability to cogenerate heat and power;
- the local environmental and energy policies.

The achievement of the EU objective of 20% of energy share from renewable energy sources requires a systemic approach by implying adoption of Smart grids thought:

- integration of local and centralized energy production and use;
- storage facilities: water basins, hydrogen, electric cars, new and more efficient batteries, etc.

In a such framework the inherent fuel flexibility of a district energy infrastructure lends itself to the integration of renewable sources that are crucial to the overall reduction of carbon emissions: geothermal heat; solar heat; biomass [Wiltshire 2011].

A general district energy system consists of three main subsystems, as represented in figure 1.1, the thermal plant containing the source of thermal energy, a hydraulic interface unit (end users) e.g. heat exchangers and a network of pipes to connect them, the thermal distribution.

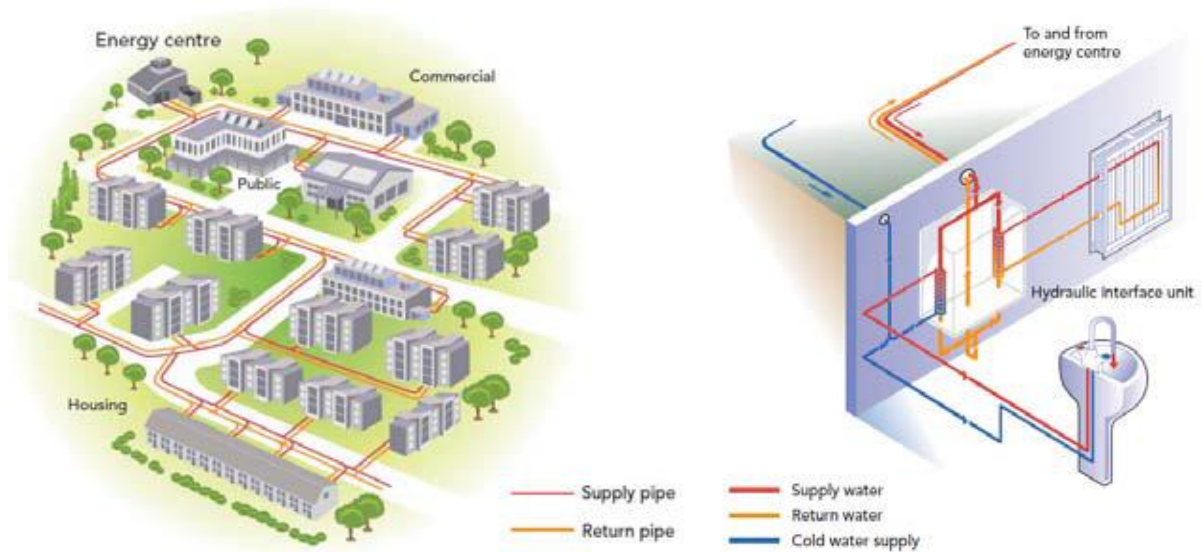

Figure 1.1 The principles of DH (right) The hydraulic interface unit (Source BRE)

DH systems can be found all over Europe today, but levels of expansion differ significantly between EU27 Member States. Currently these systems cover 12% of the European heat market for buildings in the residential and service sector, soaring to 40-60% in some Scandinavian and Baltic Member States. The corresponding market share for the industrial sector is about 9% [Verda et al.2005]. The European district heating systems have networks containing distribution pipes with a total trench length of almost 200,000 km [Heat Roadmap 2050]. The spread and dissemination of European district heating technology is shown in figure 1.2.

District heating systems (DHS) have been used in Europe since the 14<sup>th</sup> century, with one geothermal district heating system in continuous operation in France (Chaudes-Aigues thermal station) since that time [Lund JW 2007]. The commercial district heating system in New York - Birdsill Holly, Lockport, was built in 1877 (5-km loop) [Marinova et al. 2008].

The first use of geothermal energy for electric power production started in Italy with experimental work by Prince Gionori Conti between 1904 and 1905. The first commercial power plant (250 kWe) was commissioned in 1913 at Larderello, Italy, pictured in figure 1.3

Northern European countries are the main users in district heating energy systems. They has succeeded for many reasons; the simple fact that the cold climate makes DH profitable, despite low density population [Magnusson et al. 2012]; climate change policies in these countries has assigned to such systems a key role; the increase of energy prices from fossil fuels; the involvement in the policies of strong local energy actors, such as municipalities; In Sweden, for instance, DHS have traditionally been built, owned, and managed by municipalities; and lastly the incentives provided for the tax policy.

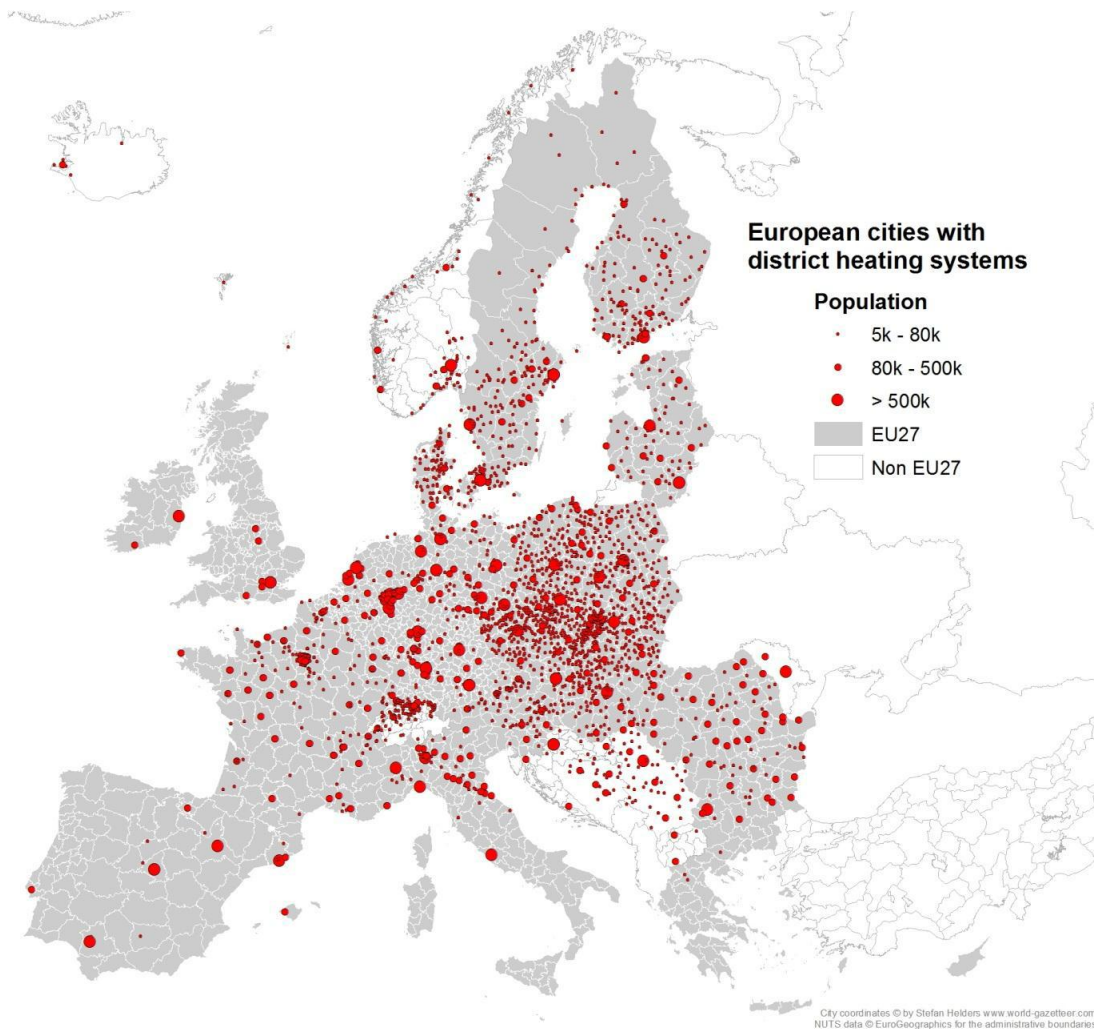

Figure 1.2. Map of cities with District heating systems



Figure 1.3 Larderello geothermal plant

DH systems versus individual supply of heat demand for residential buildings has been analysed in [Thyholt et al.2008], where, in Norway, was found to have a lower CO2 emission in comparison to the latter.

In Italy, the very first industrial urban heating network was built in Brescia in 1972. Since then, there has been a remarkable development, due, in the first place, to the increase of energy prices from fossil fuels, secondly to the important role which the National Energy Plan has assigned to such heating systems, and lastly to the incentives provided for the tax policy [Botio 1990]. The table 1.1 shows the expansion of DHS in Italy in 2011 [Airu 2012].

At the time being the city of Torino (Piedmont Region) has the highest share of DHS in Italy with 50 Million m<sup>3</sup> of heated volume; which corresponds of 500.000 inhabitants ; with about a 2000 GWh of thermal energy delivered and an expansion of 515 km of DH pipes [Tripodi 2012].

Year 2011		
Number of cities with DHS 104		
	Hot water	87
DHS	Overheated water	40
	Steam	6
Overall heated volume [Mmc]		260
Electric power installed in CHP [MW]		805
Thermal power installed in CHP [MW]		2.556
Thermal energy supplied to the users	[GWh]	7.322
	from renewable	23.2%
	CHP with fossil fuels	50.5%
	Pure combustion of fossil fuels	26.3%

Table 1.1. DHS in Italy on 2011

## 1.1 Classifications of District Heating Systems

District heating systems are categorized based on different aspects. One grouping is derived from the heat transport fluid: low pressure steam, hot water, overheated water. Another classification is based on the thermal energy transported: heating, cooling and heating and cooling [Rezaie et al.2011]. A further categorization of district heating systems can be based on the fuel source, which will be developed in the following, are:

- Cogeneration Heat Power (CHP) plants based district heating systems;
- Renewable based district heating systems;
- Waste heat based district heating systems.

---

### 1.1.1 CHP based DH systems

The combined heat and power (CHP) plant is a power plant where primary energy is used to produce power and usable heat simultaneously [Rosen et al.2005]. CHP is efficient because it avoids the large amounts of waste heat produced in typical power generation plants [Gustafsson et al.2010].

In assessing the efficiencies of the CHP based DH systems, the thermodynamic analyses techniques, based on exergy concept, provide a more meaningful tool than the energy based analysis [Rosen et al.2005]. These authors pinpoint the difficulty in assessing complex array of energy forms (such as electricity heat and cool), mainly due to the different nature and their quality. The method of exergy analysis is well suited for furthering the goal of a more efficient use of energy sources, for it enables the location, causes and magnitude of waste and losses to be determined. Such information can be used in the design of new energy efficient systems and for increasing the efficiency of existing systems [Bejan et al. 1996].

The European union has promoted the cogeneration based on a useful heat demand in the internal energy market through the deliberation of the 2004/08/EC. The directive establishes some clear general principles for CHP policy. It does not set overall targets, but urges the member states to analyze their potential for developing CHP further. The locations of major thermal power stations in EU using fuel combustion is represented in figure 1.4.

However, according to the principles announced in EU Directive 2009/29/EC (Emissions trading scheme), the economics of large combined heat and power (CHP) generation for district heating applications will be strongly affected by the cost and allocation mechanism of CO<sub>2</sub> emission allowances [Westnera et al. 2012]. This will contribute in a reduction of attractiveness of investments in large scale CHP plants that feed into DH systems.

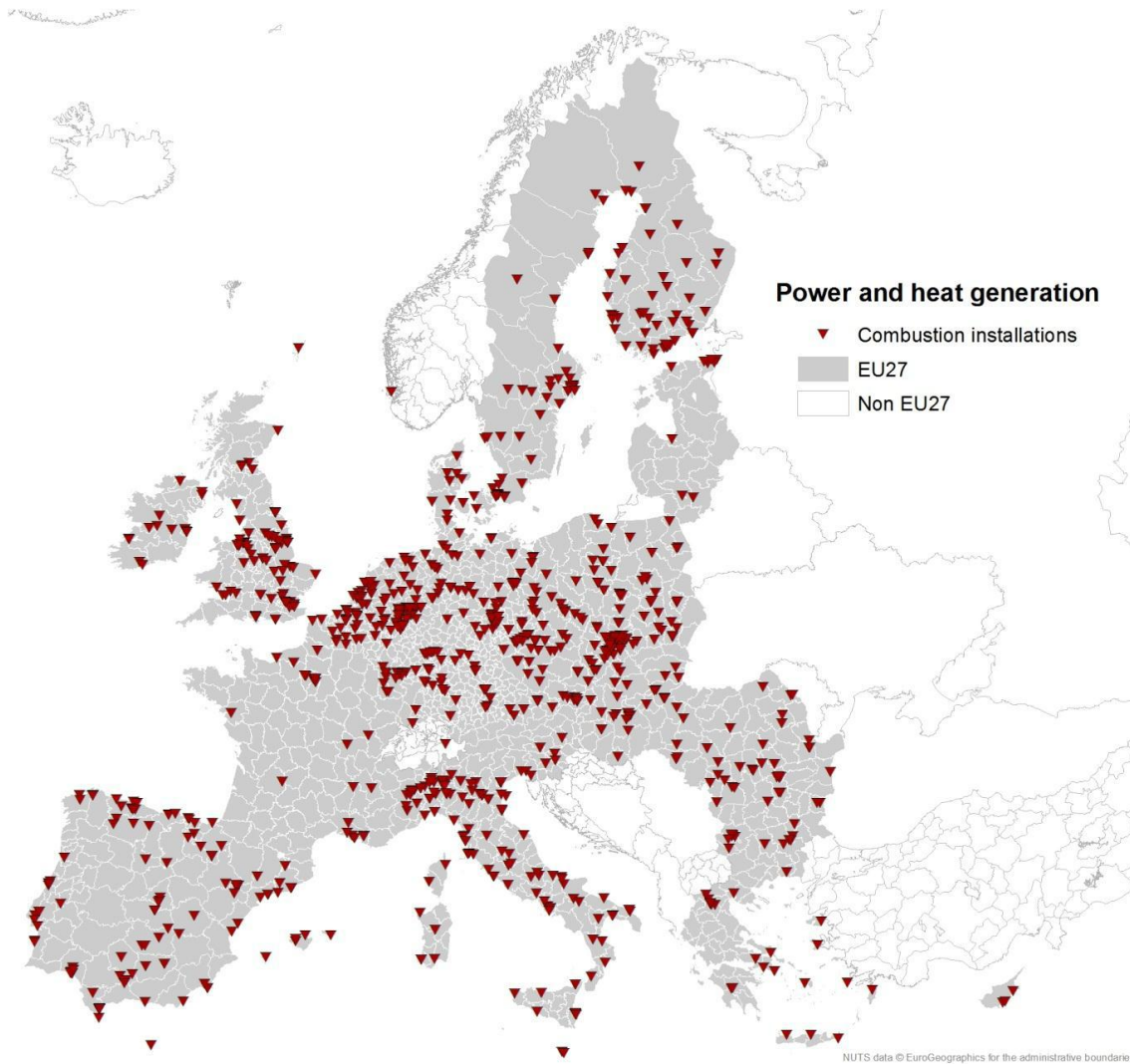

Figure 1.4 Major combustion installations above 50 MW for power and heat generation in Europe

CHP plants are particularly common in Denmark, where over 80% of the district heating energy is produced by CHP; in Sweden this figure is about 30%.

In Torino, the amount of the thermal energy produced by the CHP plants combined with district heating network is about 85.5% of the overall delivered thermal energy. In the [figure 1.5](#) is shown a sketch of the new CHP plant situated in the northern part of the Torino city [[Tripodi 2012](#)].

A cogeneration plant supplying heat to a small DH network is usually heavily dependent on the heat demand. Long-term heat storage can make it possible to produce more electricity in the cogeneration plant [[Annex VIII, IEA 2008](#)]. New technologies are making cogeneration cost effective at smaller scales.



Figure 1.5 The CHP power plant of Torino Nord

### 1.1.2 Renewable energy

One of the most interesting contributions of district heating networks to future energy systems is the opportunity to integrate heat productions from renewable energy sources such as: large scale Geothermal energy; large scale solar thermal energy and biomass. The role of DHS in future renewable energy systems has been evaluated in [Lund et al. 2010](#).

#### Geothermal Heat

European Geothermal Energy Council ([EGEC](#)) reported recently in 2011 that 212 district heating systems in Europe use partly input from geothermal heat.

The use of geothermal energy directly for district heating has increased notably by 10% over the past 30 years [[Lund JW 2006](#)]: The distribution of thermal energy used by category is approximately 47.2% for ground-source heat pumps, 25.8% for bathing and swimming (including balneology), 14.9% for space heating (of which 85% is for district heating) [[Lund JW 2010](#)].

The use of low enthalpy geothermal energy as heat source in district heating is increasing in recent years. For instance, the Danish city Frederikshavn is aiming at becoming a 100% renewable energy city [[Ostergaard et al. 2011](#)]. In this study it is shown, that the use of geothermal energy in combination with an absorption heat pump shows promise in a situation where natural gas supply to conventional cogeneration of heat and power (CHP) plants decreases radically.

A comprehensive analysis and discussion of geothermal district heating systems and applications based on thermodynamic aspects in terms of energy and exergy and

performance improvement opportunities of three geothermal district heating systems, installed in Turkey has been carried out in [Ozgener et al 2007](#).

### Solar Heat

Solar thermal energy has been used effectively in district heating. The regional conditions for solar district heating depends on the location in Europe, since the global solar irradiation is about twice in Southern Europe compared to Northern Europe. Some solar thermal installations in conjunction to district heating systems appear in Denmark, Germany, Austria, and Sweden. Denmark has a lead position with a solar heat supply of 0.03 TWh during 2009 according to the Eurostat heat balance. In the [figure 1.6](#) has been represented an overview of existing and planned solar collector fields connected to district heating systems in Denmark.

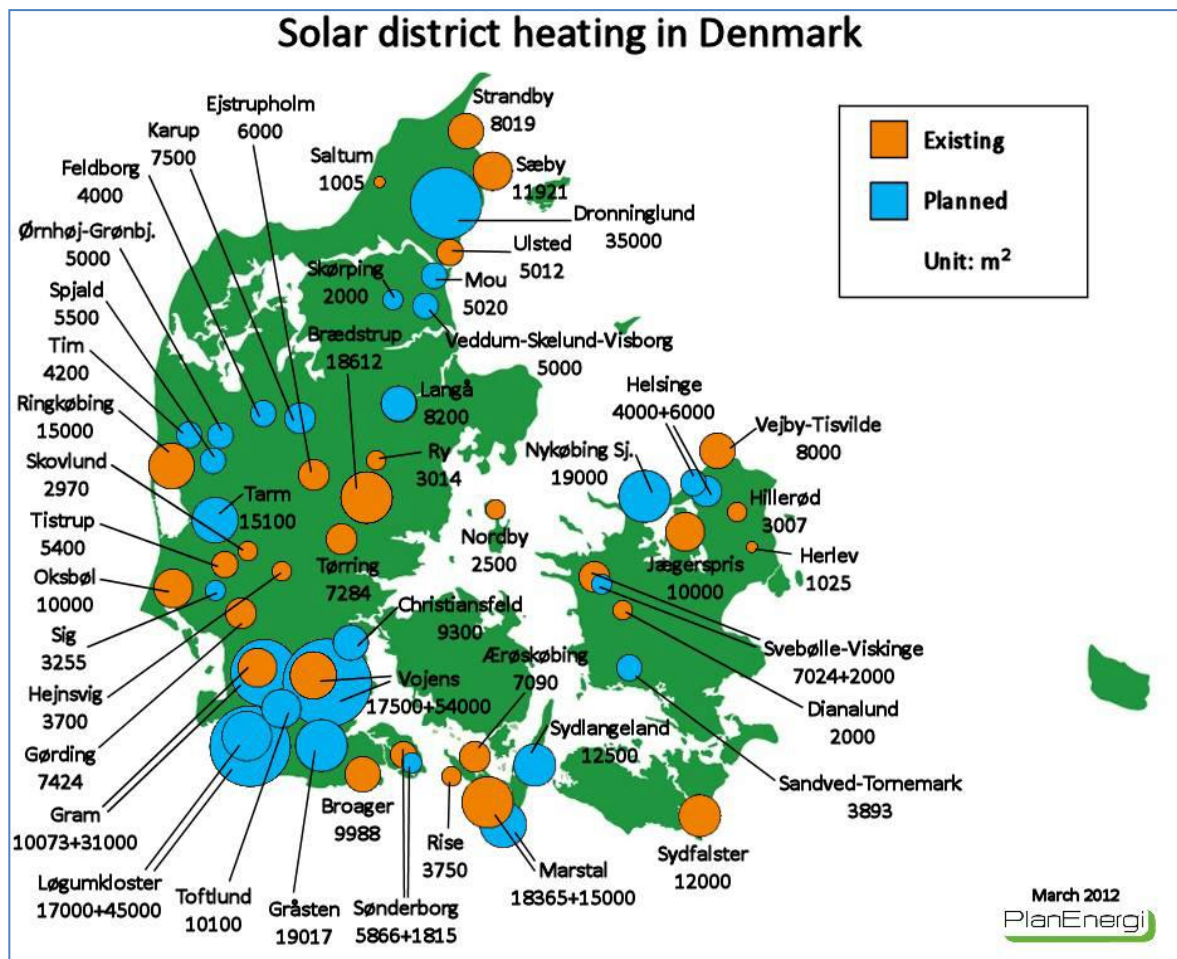

Figure 1.6 Solar District Heating in Denmark

An evaluation on the performance of 11 Central Solar Heating Plants with Seasonal Storage (CSHPSS) combined with district heating networks and seasonal thermal storages, has been conducted in [Bauer et al. 2010](#). Four seasonal thermal energy store concepts



---

has been successfully demonstrated and it was found that an average of 62% of thermal energy delivered into the DHS comes from solar.

Moreover, [Guadalfajara et al.2012](#) states that the unit cost of heat produced by CSHPSS, where the solar fraction is 50%, is competitive with the traditional heat generation system (i.e. gas boilers). The analysis has been conducted for a CSHPSS in Spain showing that this technology represent an interesting and promising alternative for covering the heating demand in residential buildings.

### *Biomass Heat*

Biomass is currently used as original energy source in many European district heating systems. Fuel sources are mainly forestry and agricultural waste. According to the Eurostat heat balance for 2009, 67TWh heat with biomass origin was supplied into district heating systems. Sweden had a lead position with an input of 24 TWh, while other significant applications appeared in Austria, Denmark, and Finland. In typical forestry areas, the availability of forestry wood waste can be sufficient for local district heating systems.

Referring to [Rakos et al. 2005](#), in Austria the energy from biomass provides about 13% (130 PJ) of all Austrian primary energy consumption in 2005.

An alternative technology of exploiting the biomass is the biomass gasification, which applications can be interesting for DH suppliers in the future, and may be a vital measure to reach the 2020 targets for greenhouse gases and renewable energy, given continued technology development and long-term policy instruments [[Difs et al. 2010](#)]. Biomass gasification in the DH systems will lead to economic benefits for DH supplier as well as reduce CO<sub>2</sub> emissions. The authors note that the most profitable investment is highly dependent on the level of policy instruments for biofuels and renewable electricity.

Furthermore, biomass application with combustion of biofuel in a CHP have been examined in district heating and electricity generation by [Eriksson et al. 2007](#), indicating the technology environmentally favourable and robust with respect to the avoided type of electricity and waste management.

However, DH systems are important in limiting the dependence on biomass and create cost effective solutions, thus leaving the biomass to other sectors [[Mathiesen et al. 2012](#)]. DH increases the efficiency with the use of combined heat and power production (CHP), while reducing the biomass demand by enabling the use of other renewable resources such as large-scale solar thermal, large heat pumps, geothermal heat, industrial surplus heat, and waste incineration. The authors state that where the energy density in the building stock is not high enough for DH to be economical, geothermal heat pumps can be recommended for individual heating systems, even though biomass consumption is higher than the DH solutions.

A methodology of designing Biomass district heating systems have been developed by [Vallios et al. 2009](#). covering technical aspects as well as environmental and economical ones.

### 1.1.3 Waste to energy

Waste incineration with energy recovery belongs to the fourth recovery step of the waste management hierarchy after prevention, re-use, and recycling in the Waste Framework Directive [Heat Roadmap 2050]. As presented in figure 1.7, the use of landfills is still very extensive for municipal solid waste in many EU Member States. Also industrial waste streams are available for waste incineration.

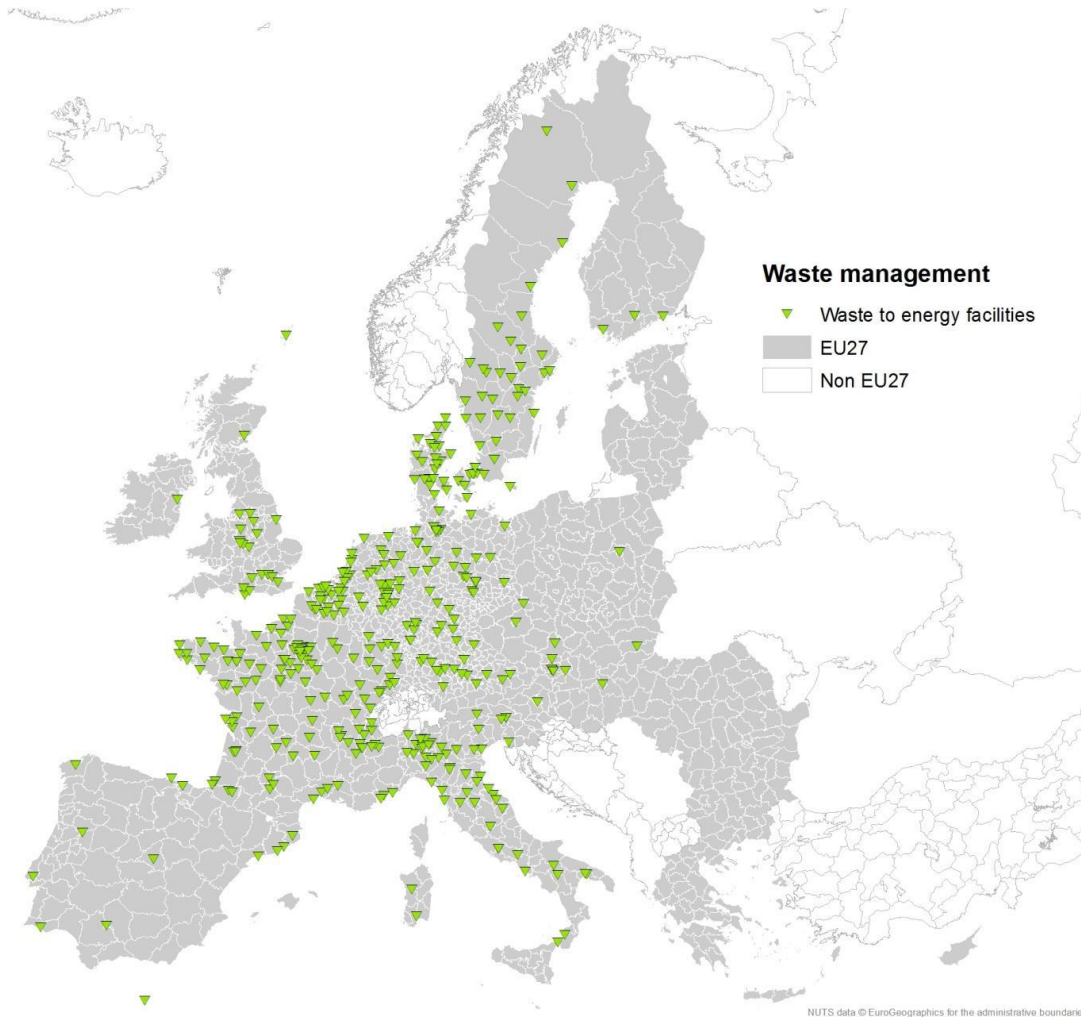

Figure 1.7 Locations of 414 waste incineration plants in Europe.

[Werner et al.2004](#) define the district heating system as a means for using local fuel or heat resources that would otherwise be wasted to satisfy local customer heat demands by using a heat distribution network of pipes as a local marketplace. [Persson et al. 2012](#). explain the conceptual idea of excess heat recovery in district heating systems as a structural and organisational energy efficiency measure. The main conclusion from this study is that a future fourfold increase of current EU27 excess heat utilisation by means of district heat distribution to residential and service sectors is conceived as plausible if applying best Member State practice.

Moreover, district heating systems using residual industrial waste heat and waste incineration with energy recovery are an efficient way to address government policies at reducing the dependence on fossil fuels for space heating and corresponding CO<sub>2</sub> emissions [Ajah et al. 2007].

However, there is a competition between energy carriers in DH systems. Holmgren 2006 analyses the municipal DH system of Goteborg in Sweden, which uses waste heat from industries and waste incineration as base suppliers of heat and a new natural-gas fired combined heat-and-power (CHP) plant has been investigated in the frame of an integrated European electricity-market. A sketch of Goteborg district heating power plant is represented in figure 1.8 The study shows that there is space in the DH system for all three energy carriers; heat from industries, waste incineration and CHP plants, where the new CHP plant replaces mainly other heat sources, i.e., hot water boilers and heat pumps. From the economical point of view, the heat from waste incineration is advantageous in comparison to the other energy carriers.

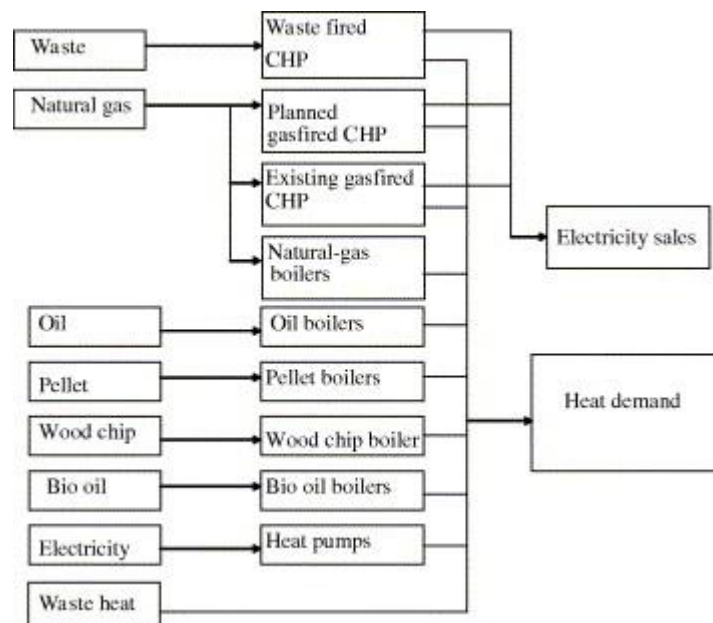

Figure 1.8 Sketch of Goteborg district heating power plant

Moreover, in comprising different energy carriers into the DHS, the economic feasibility of integrating low grade heat into DHS is of crucial importance. Kapil et al. 2012 have developed a design methodology in order to evaluate the economic benefit of integration of low grade heat with local DH networks. A case study has been carried out to demonstrate the design methodology, and the results from the case study illustrate techno-economic and engineering barriers in practice for the implementation of low grade heat recovery beyond the site. The integration of waste heat with an existing DH network decreases the heat production from the existing supplying units. The economic feasibility for the integration of waste heat with DH systems is case-specific, as the performance of such an integrated system is heavily dependent on the part load performance of the energy equipment and the cost of heat and electricity.

---

## 1.2 Future of District Heating Systems

The concept of district heating was quite standardized but has evolved in the last few years, mainly because of new opportunities that the development of renewable energy plants and energy saving techniques within the buildings have created [Verda Kona 2012]. New buildings are more efficient than existing, and this trend will continue in future due to the strengthening of the energy efficiency requirements that buildings will have to comply with. Hence, in future new buildings will require substantially reduced heat demand and low supply temperatures [Bruehlisauer et al. 2010].

To face these challenges and, at the same time, opportunities, thermal networks have to become “smart” [Schmidt et al. 2012]. Hence, in order for DHS to remain an effective solution for such developments transition to Low Temperature is imperative. Low and very low temperature networks allow different sources of heat to increase flexibility in matching demand with locally available heat sources. Low temperature district heating is typically characterized by supply temperatures between 75°C and 50°C (even if lower temperatures may be considered) and return temperatures between 40°C and 20°C [Dalla Rosa et al. 2011]. The benefits of Low Temperature DHS can be summarized as below [Frangopoulos 2002]:

- solar and geothermal heat used with higher efficiency
- use of waste heat based on renewable energy
- supply at same exergy level for Domestic Hot Water and Space Heating
- sustainable source on community level
- reliable and easy operation for customer
- reduced heat distribution losses

The aspects regarding the integration of Renewable into the DHS have been reviewed previously, while the others will be discussed in the following.

Reduction of heat distribution losses is an important aspect of improving DH network performance, and has therefore been investigated in IEA DHC programme and is undertaking research looking at the use of DH to supply heat to areas of low heat demand density [DHC Annex VIII IEA]. Heat distribution losses can be reduced by:

- using higher performance pipes
- using smaller pipe diameters, e.g. through the use of local hot water storage or booster pumps [Verda and Colella 2011]; [Verda and Colella 2012]
- reducing the heat network operating temperature: [Verda and Kona 2012] As renewable based district heating involves reductions in supply temperature, this generally causes reduction in temperature difference between supply and return pipe and therefore larger mass flow rates in the pipes. This means that energy consumption for pumping increases. Trade-off between primary energy required for heat production and pumping can be investigated through the concept of exergy (see for example [Moran and Shapiro 1998]).

---

[Grohnheit and Mortensen](#) studied the competition between energy carriers in DH systems. The authors state that none of the EU directives on liberalisation of the electricity and gas markets are considering the district heating systems, although the district heating networks offer the possibility of competition between natural gas and a range of other fuels on the market for space heating.

### 1.2.1 Heat storages systems in DHS

Fundamental elements of district heating networks are heat storage systems which are largely used to reduce the discrepancy between energy supply and demand. The storage system is charged during the night using CHP plants (or waste heat or other efficient production systems) and discharged during the day when the thermal request peaks occur. This operation has significant energetic advantages, including a reduction in the primary energy consumption with respect to the separate production of heat and power, and also economic advantages related to a shift of a portion of electrical energy production to the daily hours.].

- Possible to produce electricity when prices at power market are high, but heat demand is low.
- Possible to produce heat during night time when heat demand is low.
- Heat demand in the morning peak can be covered partial from reloading the heat storage tank.

[Verda and Colella 2012](#) presents a discussion on all the possible configurations of a district heating system based on traditional water-based and Latent Heat Thermal Energy Storage units.

In the traditional water based systems there are mainly three different technologies seen from the heat storage aspect and these are: storage in water, storage in the ground and rock and finally storage in form of chemical compound. At current technology level only water or ground/rock can be considered when it comes to storing of large quantity of heat. Chemical heat storages are still under development and they do not offer economically viable solution for large systems [IEA Annex VIII 2008].

The water storage, especially steel tanks are very common components in CHP systems. Most of these systems are based on thermal stratification, which is related with the density differences between hot and cold water. Thermal stratification enables water with an acceptable temperature to feed the supply network to be available when it is needed. A sketch of DH tanks is shown in figure [1.8](#).

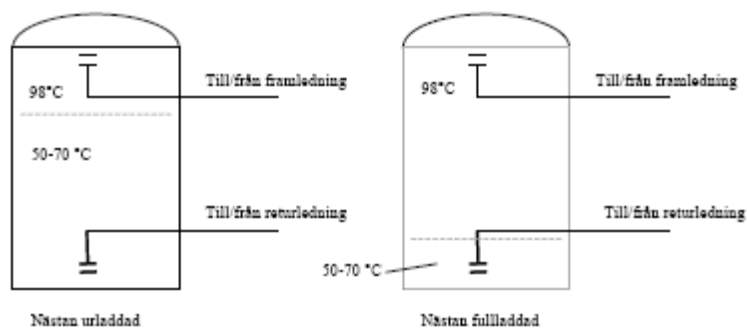

Figure 1.9 Principle of bedding DH tanks

The authors showed that a promising option in terms of energy storage density are characterized by latent storage units installed on the building heating network rather than on the primary district heating network. Also, the authors in [Verda Colella 2011] proposed a multi-scale model of storage tanks. The model is suitable to analyze the operation of storage systems during the heating season and to predict their effects on the primary energy consumption and cash flows. The analysis conducted, considering the Turin district heating system as case study, showed that primary energy consumption can be reduced up to 12%, while total costs can be reduced up to about 5%.

---

# I

---

## Methodological approach and model description

---

# 2

## Optimization Models for District Heating Systems

The optimization of energy systems is of crucial importance for rational use of natural and economic resources and for minimizing their possible negative effects on the environment [Frangopoulos et al.2002]. The best system (the optimum) is the one that satisfies a criterion of optimality, i.e. the one that minimizes (or maximizes) an objective function. The optimization technique can be divided in three levels:

- *Synthesis*: implying the set of components that constitute a system and their interconnections;
- *Design*: implying the technical specifications of the components and the properties of substances flowing throughout the system at the nominal load;
- *Operation*: implying the operating properties of components and sub-stances under specified conditions (i.e. the off-design operation).

In the case of district heating networks, synthesis consists in the selection of the users in a urban area that should be connected with the network and those who should be heated using alternative systems (e.g. boilers, heat pumps, etc.). Design consists in the selection of quantities such as the pipe diameters, the supply temperature, the size of the systems in the thermal plant (e.g. percentage of the thermal power produced through cogeneration versus the maximum heating load), etc. Operation involves the selection of the control strategies at partial load (e.g. variable supply temperature, as the function of the ambient temperature), but also the time evolution of the network during construction. Synthesis and design optimization cannot be performed separately in the case of district heating network because of the mutual dependence of these two problems. Operating conditions also affect the synthesis/design. Nevertheless, the effect of the ambient temperature along the heating season can be approximated in the synthesis/design problem (e.g. the annual energy for pumping and thermal losses can be estimated on the basis of the degree day), therefore a first approach to the optimization problem can consist of the first two levels only: synthesis+design. The main features of this approach are presented in this chapter. The optimization starts with a superstructure (all the thermal users of the considered area are connected to the DHN), which is then



---

reduced to the optimal configuration. This approach embeds the optimal design, especially in terms of choosing the optimal diameter of the pipes at each iteration. The complete approach, also including additional design variables and the analysis of the operating conditions, is presented in chapter 4. The latter aims at providing a better evaluation of the off-design operation of a network and also consider the operation during construction. This chapter reports a brief overview of the state of the art, an introduction to the optimization method, the Single and Multi-objective optimization methods developed in this PhD thesis.

## 2.1 State of the Art

The design evaluation and optimization of energy systems is typically based on the trade-off between efficiency and investment cost for the most important plant components [Bejan et al. 1996].

One of the first optimization model of energy systems implying district heating networks, was developed by Henning et al. 1997. The model, called MODEST, consists on a linear programming technique aiming at minimizing the capital and operation costs of energy supply system.

Recently, various studies have been conducted on the optimization of district heating systems, for a general overview of models, methods and applications, the author refers readers to extended reviews such as Weber et al. 2011, Möller et al. 2010, Thylot et al. 2008, Curti et al. 2000-1, Curti et al. 2000-2, Chinese et al. 2005, Verda and Ciano 2005.

The majority of models for the optimization of district energy systems relies on linear programming (LP) or mixed integer linear programming (MILP). For instance, Weber and Shah 2011 presented the DESDOP tool, based on mixed integer linear optimization techniques. Its purpose is to define the mix of technologies that will best meet the energy service requirement for a small city. The considered technologies include both renewable and non-renewable powered technologies, as well as centralized and distributed technologies. This method has been applied to a small city showing that CO<sub>2</sub> reductions up to 20% are easily achievable at no extra costs.

A different methodology has been developed by Möller et al. 2010, the so called Heat Atlas methodology. The model uses data from the national register of buildings and dwellings of Denmark, and for each building date have been georeferenced using unique address location. The heat demand is calculated using registered floor areas and calculated specific heat losses for types of buildings (25 types depending on usage and age). The model has been used to analyze the expansion of DH systems in the Danish energy system. The authors conclusion is that the optimal expansion of DH lies between 50-70% of the Danish heat share market, while the remaining buildings should be supplied with an alternative technology such as heat pumps.

Some approaches based on meta-heuristics (simulated annealing, genetic algorithms) have been proposed in Curti et al. 2000-1, Curti et al. 2000-2, Verda and Ciano 2005. The techniques based on Evolutionary Algorithms can handle sets of possible solutions at the same time and are recognized as a natural way of solving multi-objective

---

problems efficiently, even if they have been applied only recently [Fazlollahi et al. 2011], [Abdollahi et al.2011].

## 2.2 Definition of the Optimization Model

The objective of the thesis is to define an optimization technique in order to perform the optimal planning of the energy systems in urban areas.

In this thesis has been developed an optimization technique in order to find the configuration of the energy system which requires the minimum primary energy or the minimum economic cost of energy. Moreover, since these objective functions are competing between them, a multiobjective optimization has been defined in order tackle this issue.

First of all, the optimal synthesis of the energy system is approached by starting with a superstructure, where all the users are connected to the district heating network. Afterwards the superstructure is reduced to an energy system where some of the users are connected to the DH, while the others are supplied with an alternative heating technology as the geothermal groundwater heat pumps or condensing boilers. The main steps of the procedure are mapped in figure 2.1.

The definition of a superstructure is widely used for solving synthesis problems (see for example Frangopoulos et al. 2004; Rancruel et al.2004; Li et al. 2004).

The initial configuration of the energy systems comprise a network where all the users are connected to a centralized thermal power station. The simulation model of energy production is explained in 4.1.4, while the design of the network can be found in 4.1.2.

Once the superstructure is built, the problem can be solved as an optimization problem. Referring to the figure 2.1, the procedure follows this steps:

Block (1): as the procedure is iterative, it begins with performing the first iteration:

Block(2): all the user are connected to the DHN, so the initial superstructure is defined;

Block(3): The initial step of the procedure consists on designing the energy system, based on the thermal request of buildings. The thermal request of the users are derived from the database of the buildings (DBS), as explained in the section 4.1.1. The simulation model of energy production is explained in 4.1.4, while the design of the network can be found in 4.1.2.

Block(4): the procedure evolves with the evaluation of the objective function in the initial configuration. In this work the objective functions refers to the average unit cost (primary energy cost or economic cost) of heat supplied by the energy system.

In order to determine the average cost of heat to each user, the procedure computes the unit cost of heat supplied considering both the DHN or supplied with an alternative heating technology. The unit cost of heat for a user is a function of the spatial position (the distance from the network) and its thermal request (supply and return temperature, mass flow rates)

The approach to achieve the optimal solution implies the reduction of the superstructure, i.e. the network is reduced by removing the users that determine high

costs and the corresponding pipes connecting these users with the rest of the network.

Block(5-6): There has been developed two different criterions on the user's removal selection from the network:

- The deterministic criteria is based on selecting the user with the higher specific cost;
- The probabilistic criteria is based on a simulated annealing approach on selecting the user with the higher specific cost-Block(7)

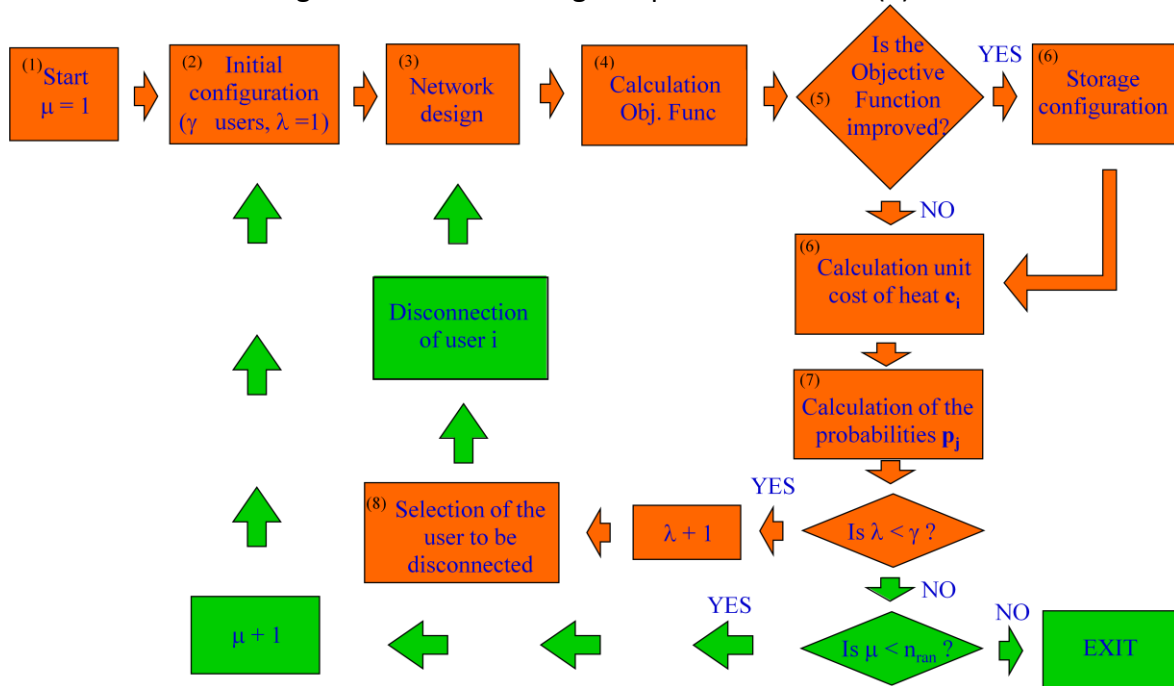

Figure 2.1 Flow chart of the optimization procedure

During this simulation process the quantity of thermal energy is reduced as users are removed from the network and consequently the primary energy for pumping is reduced as well. The removed users from the heating network will be supplied with an alternative technology. The alternative technologies considered in this thesis are the natural gas fuelled condensing boilers and geothermal heat pumps.

The synthesis procedure, in both selection criterions, is iterative and each iteration consists of following steps:

1. calculation of the unit cost of all the users connected to the actual network configuration;
2. selection on probabilistic/deterministic criteria and removal of the user from the DH network:
  - a. the deterministic criteria is based on the elimination of the user characterized by the highest cost and the corresponding piping joining the user with the rest of network;

- b. the probabilistic criteria is based on assignment of a probability cost-based function to all the users; extraction of a random number and then the identification of the user to be deactivated from the DH network.
3. calculation of the average cost of heat provided to the users in the new configuration, i.e. a configuration where the DH network is reduced by the previous removed user and supplied with an alternative technology.

The procedure is stopped when all the users are eliminated; it is not safe to stop the procedure when a minimum/maximum is reached because of the possible presence of local minimum/maximum [Verda and Ciano 2005].

### 2.3 Objective function: Minimum specific primary energy consumption

A first objective function considered in the district heating optimization is the average primary energy specific consumption  $\bar{k}$  of the overall energy system (eq. 2.1).

$$\bar{k} = \frac{Ep_{district\ heat} + Ep_{alternative\ heat}}{\sum_i E_{thermal\ request}(i)} \quad (2.1)$$

The first term  $Ep_{district\ heat}$  represents the total primary energy consumption by the users connected to the district heating network, while  $Ep_{alternative\ heat}$  is the quantity of primary energy required by the users supplied with an alternative technology. In this work the alternative technologies considered are the natural gas fuelled condensing boiler and groundwater geothermal heat pumps. The term at the denominator  $\sum_i E_{thermal\ request}(i)$  represents the total annual thermal request of the users (i.e. users connected to the DH and the users supplied by an alternative technology).

The primary energy consumption associated with the DH is calculated as (eq. 2.2)

$$Ep_{DH} = Ep_{thermal\ losses} + Ep_{network} + Ep_{pumping} + Ep_{heat\ production} \quad (2.2)$$

where  $Ep_{thermal\ losses}$  is the annual primary energy consumption due to thermal losses incurring in the pipes, calculated as a production of three terms (eq. 2.3):

$$Ep_{thermal\ losses} = \Phi_{losses} * h * k_{prod} \quad (2.3)$$

$\Phi_{losses}$  accounts for the total thermal flow which is lost by the network. This term is calculated considering each pipe that constitutes the network and depends on its diameter, which reveals the link between synthesis and design optimization. The heat losses are almost constant during the heating season if the supply temperature is kept constant (the return temperature has a smaller effect on this term). The term  $h$  represents the hours of heating season and  $k_{prod}$  is the unit cost of heat;  $k$  stands for primary energy factor, and represents the amount of primary energy required at the power station to produce one kWh of thermal energy exiting the station. An extended explanation of the  $k_{prod}$  unit cost of heat is done in the section 4.1.4. If the supplied

temperature is modified during the heating season, this terms on the right hand side of equation eq. 2.3 must be calculated considering the various operating conditions, which means that a link with the operation optimization problem must be considered.

$E_{p_{network}}$  is the annual primary energy consumption due to the construction of the network (eq. 2.4). These energetic costs includes:

- the production and transportation of the insulated pipes;
- excavation of the pavement and the pavement restoring.

$$E_{p_{network}} = E_{p_{material}} + E_{p_{transport}} + E_{p_{construction}} \quad (2.4)$$

$E_{p_{pumping}}$  is the annual primary energy required for pumping during the heating season, calculated as a production between the electricity consumed and the exergetic cost of electricity (eq. 2.5):

$$E_{p_{pumping}} = \left( \frac{1}{\eta_p} \int G \cdot v \cdot \Delta p \cdot dt \right) \cdot \frac{1}{\eta} \quad (2.5)$$

where  $\eta_p$  is the pump efficiency,  $G$  the water mass flow rate,  $v$  the water specific volume (constant) and  $\Delta p$  the total pressure losses due to pipe friction and local resistances, while  $1/\eta$  is the primary energy factor for the Italian electricity system, calculated as the inverse of its efficiency. If the supply temperature of the network is constant along the season, the mass flow rate flowing in each pipe only depends on the external temperature and so the total pressure losses. This means that an estimation of the primary energy for pumping can be obtained on the basis of the degree day of the site.

$E_{p_{heat production}}$  is the annual primary energy required in the thermal plant, calculated as a production of thermal energy requirement of the user and the energetic cost of heat ( for further explanation see section 4.1.4) (eq. 2.6).

$$E_{p_{heat production}} = E_{thermal request} \cdot k_{prod} \quad (2.6)$$

The primary energy consumption of the users which are not connected to the DH but supplied with an alternative heating technology is calculated as the summation of the primary energy consumption required by each single user (eq. 2.7)

$$E_{p_{alternative tech}} = \sum E_{p_{user alt}} \quad (2.7)$$

$E_{p_{user alt}}$  is the annual primary energy required to supply the user with an alternative heating technology, calculated as the product of thermal energy requirement of the user and the energetic cost of heat  $k_{alt}$  ( for further explanation see section 4.1.4)

$$E_{p_{user alt}} = E_{thermal request} \cdot k_{alt} \quad (2.8)$$

The results obtained by the application of the primary energy consumption objective function in the case application are reported in the chapter 5.1.

## 2.4 Objective function: Minimum economic cost

As a second objective function (to be minimized) is the average economic unit cost of heat ( $\overline{c_{ecp}}$ ) supplied to the users (eq. 2.9).

$$\overline{c_{ecp}} = \frac{C_{district\ heat} + C_{alternative\ heat}}{\sum_i E_{thermal\ request}(i)} \quad (2.9)$$

The first term on the numerator,  $C_{district\ heat}$ , represents the total annual cost of heat supplied to the users connected to the district heating network, while  $C_{alternative\ heat}$  is the annual cost of heat supplied to the users with an alternative technology. The term at the denominator,  $\sum_i E_{thermal\ request}(i)$ , is the total annual thermal request of the users (i.e. both connected to the DH and users supplied by an alternative technology)

The total annual economic cost of heat for the users connected to the DHN network, is calculated as (eq.2.10)

$$C_{district\ heat} = C_{thermal\ losses} + C_{network} + C_{pumping} + C_{heat\ production} \quad (2.10)$$

where  $C_{thermal\ losses}$  is the annual cost of primary energy due to thermal losses incurring in the pipes, calculated as a product of the total primary energy due to thermal losses  $E_{thermal\ losses}$  calculated in (eq. 2.3) and the unit cost of heat ( $c_{prod}$ ) (eq. 2.11):

$$C_{thermal\ losses} = E_{thermal\ losses} \cdot c_{prod} \quad (2.11)$$

The unit cost of heat ( $c_{prod}$ ) refers to the specific cost of heat produced in the thermal plant. Further explanation on calculation procedure of this cost can be find in section 4.1.4.

$C_{network}$  is the annual cost of the investment of DH, it includes: purchase of insulated pipes, pumps, valves, together with other direct costs, which means excavation, installation and paving restoration, and the cost of heat exchange substations installed in the user buildings.

$C_{pumping}$  is the annual cost of primary energy utilised for the pumping during the heating season, calculated (eq. 2.12) as a product of the total primary energy required for pumping  $E_{pumping}$  and the unit cost of electricity  $c_{elc}$ .

$$C_{pumping} = E_{pumping} \cdot c_{elc} \quad (2.12)$$

$C_{heat\ production}$  is the annual cost of primary energy produced in the thermal plant, calculated as a product of the required primary energy  $E_{heat\ production}$  in order to satisfy the required thermal energy for the users, and the unit cost of heat  $c_{prod}$  (eq. 2.13).

$$C_{heat\ production} = E_{heat\ production} \cdot c_{prod} \quad (2.13)$$

The total heating costs of the users which are not connected to the DH but supplied with an alternative heating technology is calculated as a summation of the total annual costs for each of these users (eq. 2.14)

$$C_{\text{alternative heat}} = \sum C_{\text{alt}}(i) \quad (2.14)$$

$C_{\text{alt}}(i)$  is the annual cost of heat supplied to the user with an alternative heating technology, calculated as (eq. 2.15) a product of the thermal energy requirement of the user  $E_{\text{thermal request}}(i)$  and the unit cost of heat supplied by the alternative heating technology  $c_{\text{alt}}$ , plus the annuity associated with investment and maintenance ( $A_{\text{alt tech}}$ )

$$C_{\text{alt}}(i) = E_{\text{thermal request}}(i) \cdot c_{\text{alt}} + A_{\text{alt tech}} \quad (2.15)$$

The results obtained by the application of the Economic objective function in the case application are reported in the chapter 5.2.

## 2.5 Multi-objective Optimization

The optimization of district energy systems should consider different targets. Usually, the first target is the economic performance of the system, where the objective function is minimizing the total annual costs or the total operating costs or maximizing the revenues. A second objective function that should be considered is related with primary energy utilization, i.e. the system should allow the minimization of primary energy consumption with respect to the base option (i.e. all buildings supplied with local boilers). These two objective functions are competing since larger energy efficiency involves increasing investment costs thus a multi-objective optimization can be implemented.

Multi-objective minimisation of two objectives attempts to find the trade-off curve between each objective such that at any point on the curve the value of one objective cannot be decreased without increasing the other (Pareto frontier). This is illustrated in figure 2.2 for a problem where cost and efficiency are optimized. In the real world many engineering problems are multi-objective, for example investment cost and running cost, or overall cost and pollution emitted.

A Multi-objective problem has no single solution, but a set of solutions. To determine if one is better than another, the concept of “dominance” needs to be defined. A solution “a” dominates a solution “b” if the following conditions are verified at the same time.

- “a” is no worse than “b” with respect to all objectives;
- “a” is better than “b” at least with respect to one objective.

Therefore, “b” is “dominated” by “a”, and “a” is “non-dominated” if there is no other solutions which satisfy the two conditions with respect to “a”. All “non-dominated” solutions form the Pareto Frontier as represented in figure 2.2, which is the solution of the Multiobjective problem. The Utopia point has the minimum of each objectives as coordinates and it corresponds to the optimal solution only if the objectives are not in

competition. The final solution will be identified between the solutions forming the Pareto front it depends on secondary evaluations.

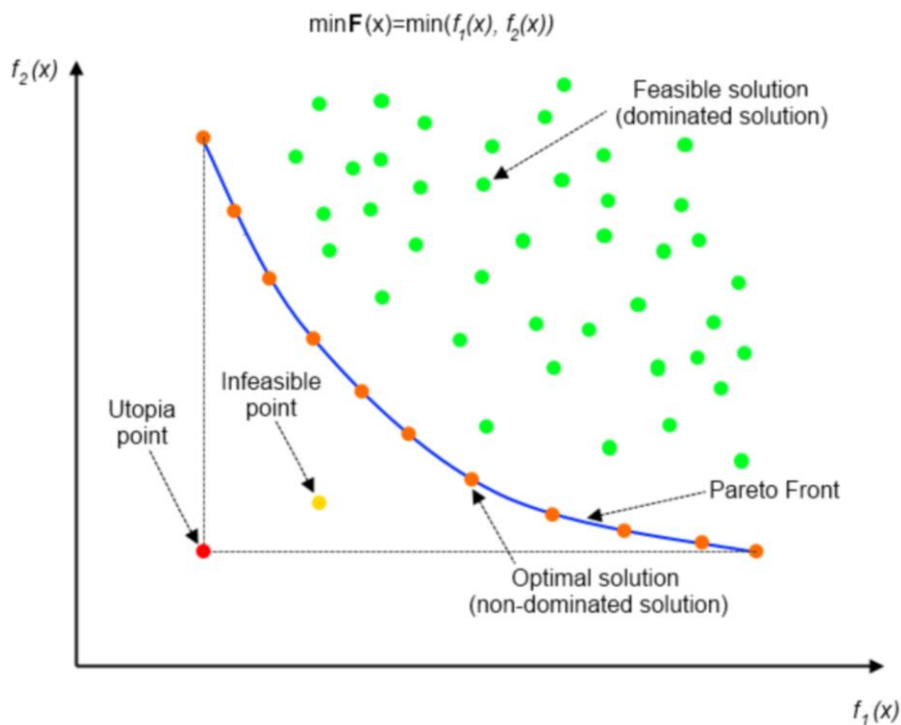

Figure 2.2 Pareto front of two objectives problem

There are a lot of methods for solving multi-objective optimization problems, such as compromise programming, global criterion method, and goal programming [Alarcon-Rodriguez et al. 2010]. Methods which allow to solve Multiobjective optimization problems can be divided in two main groups:

- Single objective techniques;
- Techniques based on Evolutionary Algorithms.

The single objective techniques are known as the classical approach to the Multiobjective optimization, as they treat a problem with several objectives, like a problem with a single objective. Two of the most common methods are the weighted sum method and the  $\epsilon$  constrained method. The weighted sum method is a weighted sum of each objective and it requires that all objectives are comparable as they are summed to each other. Moreover it cannot deal with problem which comport a non-convex Pareto Front, as it cannot find any solution in the non-convex region [Jing YY et al. 2012]. The  $\epsilon$  constrained method overcome to this problem as it optimizes with respect to only one objective, while constraining the other objectives.

Another method of single objective techniques is the compromise programming, which minimizes the distance between the Pareto solution and the Utopia point, but is



not often used in energy system optimizations [Ren et al. 2010]. All these techniques can guarantee the optimality of the solutions.

The techniques based on Evolutionary Algorithms can handle sets of possible solutions at the same time and, as a result, permit identification of several solutions of the Pareto front at once. Hence, Evolutionary Algorithms are recognized as a natural way of solving multi-objective problems efficiently, even if they have been applied only recently [Fazlollahi et al. 2011], [Abdollahi et al. 2011].

The problem handled in this PhD thesis concerns the optimization of an energy system, and the SA optimization technique has been applied to solve the problem, using the  $\varepsilon$  constrained method. The design task has been posed as a bi-criteria programming problem, which could be mathematically expressed as  $Min f(x) = \{f_1, f_2\}$ . The solution to this problem has been given by analyzing Pareto optimal points representing alternative process designs, each achieving a unique combination of the objectives. This method, as previously described, minimizes one objective and constrains the other. The objective function of the problem is therefore formulated as follows (eq. 2.16- 2.17):

$$Min f_1 \quad (2.16)$$

$$\text{subject to: } f_2(x) \leq \varepsilon \quad \text{with } Lim_{inf} \leq \varepsilon \leq Lim_{sup} \quad (2.17)$$

The problem has been optimized for different values of  $\varepsilon$  to obtain the Pareto front within two limits  $[Lim_{inf}, Lim_{sup}]$  evaluated solving the problem with respect to  $f_2(x)$  and  $f_1(x)$ , respectively. After the optimizations have been done and the Pareto front is available, one solution is identified evaluating all "non-dominated" solutions based on secondary criteria. This method is relatively simple, but computationally intensive, so that decomposition techniques could help to reduce the complexity of the optimization, or alternatively, to allow optimization of more complex systems.

In this work the objective function to be minimized is the average primary energy consumption  $\bar{k}$  provided to the users, calculated in eq. 2.1, and the constrained function is the average economic cost of heat  $\bar{c}_{ecp}$  supplied to the users; calculated in eq. 2.9. The Multiobjective function has been formulated as above (eq. 2.18- 2.19):

$$Min \bar{k} \quad (2.18)$$

$$\text{subject to } \bar{c}_{ecp} \leq \varepsilon \quad \text{with } Lim_{inf} \leq \varepsilon \leq Lim_{sup} \quad (2.19)$$

Where  $[Lim_{inf}, Lim_{sup}]$  are evaluated by finding the solution solving the problem with respect to  $f_2(x)$  (i.e. the average economic cost by solving the economic objective function) and  $f_1(x)$  (i.e. the average economic cost by solving the specific primary energy consumption objective function), respectively. The value of  $\varepsilon$  is chosen randomly within the interval  $[Lim_{inf}, Lim_{sup}]$ .

Results on the application of Multiobjective optimization are reported in section 5.3.

---

# 3

## Exergetic and Thermoeconomic Approach for District Heating Systems

In this chapter the cost formation process, considering the physical roots provided by Second Law of thermodynamics is analyzed. The physical magnitude connecting physics and economics is entropy generation or more specifically, irreversibility. This represents the “useful” energy or exergy lost or destroyed in a physical process [Torres and Valero].

An opportunity for doing useful work exists whenever two systems at different states are placed in communication. In principle work can be developed as the two systems reach the equilibrium. When one of the two systems is a suitably idealized system called an “environment” and the other is a system of interest, exergy is the maximum theoretical useful work obtainable as the systems interact to equilibrium. [Bejan et al. 1996].

The exergy balance of a system can be expressed using a linear combination of first and second law of thermodynamic:

$$\frac{dU}{dt} = \sum \dot{Q}_i - \dot{L}_i + \sum_{in} \dot{m} h^t - \sum_{out} \dot{m} h^t \quad (3.1)$$

$$\dot{S}_{gen} = \frac{dS}{dt} - \sum_{i=0}^n \frac{\dot{Q}_i}{T_i} + \sum_{out} \dot{m} s - \sum_{in} \dot{m} s \geq 0 \quad (3.2)$$

Equation 3.1 and 3.2 are the first and the second law of thermodynamic written for an open system, i.e. a system which can exchange mass and energy with other systems. The terms in the equations are:

$\frac{dU}{dt}$  is the time rate of change of internal energy

$\dot{Q}_i$  thermal flow exchanged with a system at a temperature  $T_i$  (or with the environment in the case of  $\dot{Q}_0$ );

$i$  is the number of thermal sources, i.e. systems which the system exchanges thermal flows with;

$\dot{L}_i$  mechanical shaft power;

$\dot{m}$  mass flow of the flow;

$n$  number of mass flows entering or exiting the system

$h^t$  specific total enthalpy of the flow;

$\dot{S}_{gen}$  entropy generation;

$S$  entropy of the system

$s$  specific entropy of the flow;

The exergy balance can be expressed in various forms that may be appropriate for particular applications. A convenient form of the exergy balance for open systems is the rate equation 3.3:

$$\frac{dE}{dt} = \sum_{i=0}^n \left(1 - \frac{T_0}{T_i}\right) \dot{Q}_i - \left(W - p_0 \frac{dV}{dt}\right) + \sum_{in} \dot{m} (h^t - T_0 s) - \sum_{out} \dot{m} (h^t - T_0 s) - T_0 \dot{S}_{gen} \quad (3.3)$$

Where:

$\frac{dE}{dt}$  is the time rate of change of exergy;

The term  $\left(1 - \frac{T_0}{T_i}\right) \dot{Q}_i$  represents the time rate of exergy transfer associated with heat transfer at the rate  $\dot{Q}_i$  occurring at the location on the boundary where the instantaneous temperature is  $T_i$ ;

The term  $W$  is the time rate of energy transfer by work, and the associated exergy transfer is given by  $\left(W - p_0 \frac{dV}{dt}\right)$  where  $\left(\frac{dV}{dt}\right)$  is the time rate of change of system volume;

Here,  $T_0 \dot{S}_{gen}$  accounts for the time rate of exergy destruction due to the irreversibilities within the system and is related to the rate of entropy generation within the system.

The exergy destruction  $T_0 \dot{S}_{gen}$  is due to the irreversibilities of real transformations. The main causes of exergy destructions in industrial processes are [Moran and Shapiro 1998]: free (non controlled) chemical reactions, free expansions of fluids, free mix of fluids, free heat transfer, inelastic deformation, electricity flow in a resistance, friction and magnetic hysteresis.

Thermoeconomics is a branch of engineering combining exergy and economic principles (Gaggioli and Wepfer 1980) The thermoeconomic analysis of an energy system allows one to calculate on a thermodynamic and economic base the cost rate of all the fluxes flowing in, out and through the system, and in particular its products. The cost calculation gives as much information as the representation of the system is detailed. This is more important as the number of products is high, because in those cases the number

---

of components and fluxes, both with physical and productive meaning, are high. Thermoconomics can be used for costing purpose, design improvement, optimization and the analysis of operating conditions, as illustrated in [El Sayed 2003](#).

A thermo-economic analysis is implemented for the designed network, where all the possible users are connected. In particular, a useful approach that can be adopted for this purpose is the one proposed by Valero and co-workers in the eighties. One of its main characteristics is the matrix based approach, in particular the use of an incidence matrix for expressing the equation of cost conservation. The concept of the incidence matrix was formulated in the ambit of the graph theory ([Harary 1995](#)), which is widely adopted for the topology definition as well as the fluid dynamic and thermal calculation of distribution networks.

The incidence matrix,  $\mathbf{A}$ , is characterized by as many rows as the branches ( $m$ ) and as many columns as the nodes ( $n$ ). The general element  $A_{ij}$  is equal to 1 or  $-1$ , respectively if the branch  $j$  is entering or exiting the node  $i$  and 0 in the other cases. The use of the incidence matrix allows for expressing the balance equation of the flow of the general extensive quantity  $G_x$  as (eq 3.4):

$$\mathbf{A} \cdot \mathbf{G}_x + \mathbf{G}_{xd} = \mathbf{0} \quad (3.4)$$

where  $\mathbf{G}_x$  is the vector containing the values assumed by the quantity  $G_x$  in the nodes and  $\mathbf{G}_{xd}$  is the vector that allows accounting for the amount destroyed in the branches, if it is not null. In thermoconomics, Eq. 3.4 allows for the writing of the cost balance as (eq. 3.5):

$$\mathbf{A} \cdot \mathbf{\Pi} + \mathbf{Z} = \mathbf{0} \quad (3.5)$$

Where  $\mathbf{\Pi}$  is the vector containing the cost of all the flows, while  $\mathbf{Z}$  contains the cost rate of the components. The calculation of all the costs requires the formulation of  $n-m$  auxiliary equations, which are obtained through a definition of resources and products of each component, expressed in terms of exergy flows ([Tsatsaronis and Winhold 1985](#)).

The auxiliary equations were formulated as four propositions:

(P1) is the conservation of cost, expressed by eq. 3.5

(P2) in the absence of a different evaluation, the economic unit cost of an exergy flow entering the system from the environment can be assumed to be equal to its price;

(P3) in the absence of a different evaluation, the unit cost of a lost exergy flow is the same;

(P4a) if the fuel of a component is defined as the difference between two exergy flows, the unit cost of these flows is equal;

(P4b) if the product of a component is defined as the summation of two or more flows, the unit cost of these flows is the same.

Unit costs can be also introduced. The economic unit cost of the  $j_{th}$  flow entering/exiting the  $i_{th}$  component  $c_{ji}$  is defined as a ratio between the exergetic cost of a flow  $\Psi_{ji}$  and its exergy

Using these concepts the balance equation for a component can be written as (eq.3.6):

$$\sum_j \Psi_{ji} \cdot c_{ji} + \dot{Z}_i = 0 \quad (3.6)$$

Cost can also be expressed in thermodynamic units, in particular in terms of exergy  $k^*_{ji}$ . The exergetic cost of heat expresses the amount of exergy associated to the natural resources to produce a product, it is defined as the ratio between the exergetic cost  $\Psi_{ji}^*$  of a flow and its exergy  $\Psi_{ji}$ .

In this way, the exergetic and economic unit cost for each user can be calculated. This cost is not the same for all the users because of the different exergy destruction (mainly due to friction) and the pipe cost associated with the different paths joining the thermal plant with the users.

### Primary energy consumption of the users

In the figure 3.1 are represented the specific primary energy consumption of each user (i.e. the energetic cost), calculated for the DHN of Casale Monferrato, where the cogeneration ratio in the thermal plant was assumed 50%. A more detailed explanation of the model calculation of the costs can be find in the chapters 2 and 4.

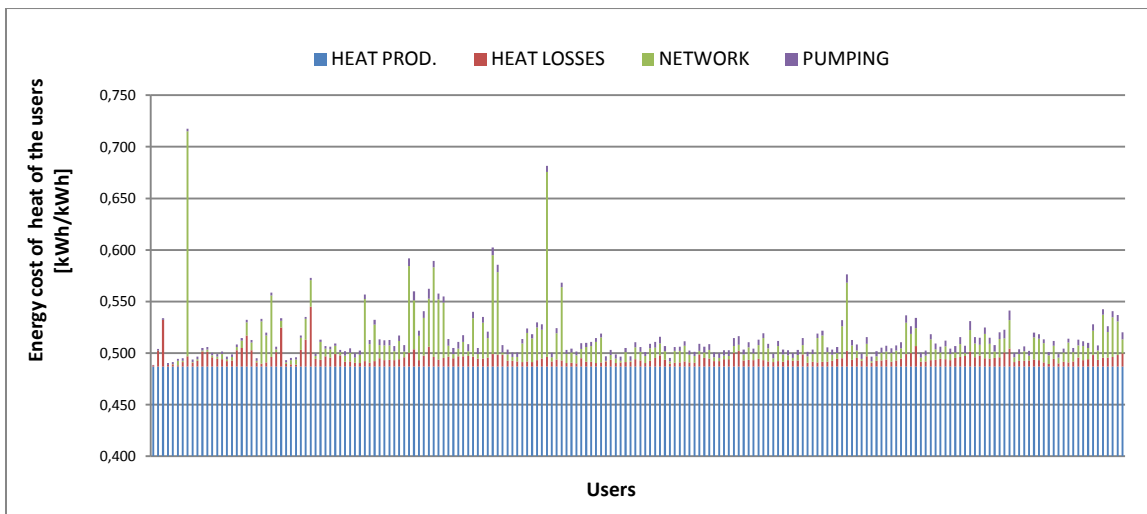

Figure 3.1 Specific primary energy consumption for each user connected to the DHN

As it can be seen on the graph, the user number 8 has the network cost component (0.218 kWh/kWh) the highest of all. This is principally due to the fact that the user is characterized with a very low thermal request and it is far away from the main pipe of DHN. For the same reason, the user number 81 has a very high network cost 0.179 kWh/kWh, in comparison to the average value (0.016 kWh/kWh)

### Economic costs of heat of the users

In the figure 3.2 are represented the economic cost of heat of each user, connected to the DHN of Casale Monferrato, where the cogeneration ratio in the thermal plant was assumed 50%.

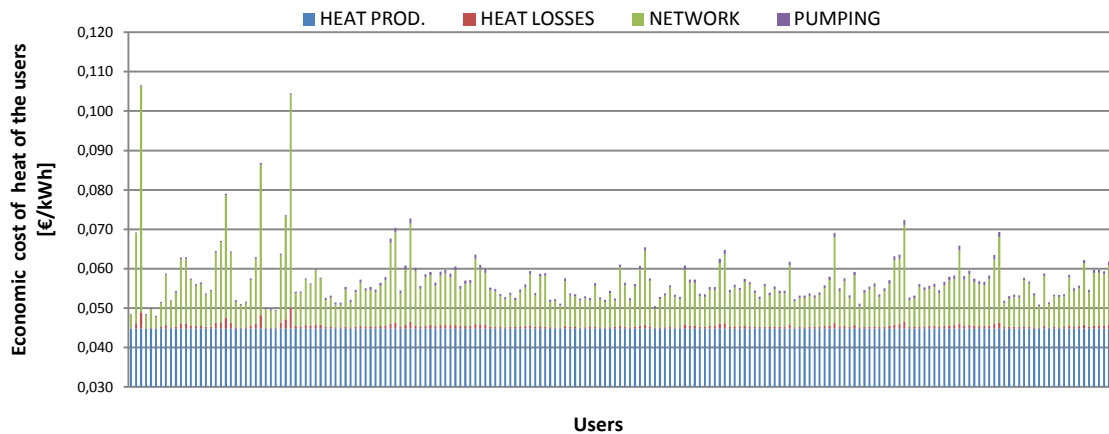

Figure 3.2 Economic cost of heat for each user connected to the DHN

As it can be seen on the graph, the user number 3 has the network cost component (0.06 €/kWh) the highest of all. This is principally due to the fact that the user is characterized with a very low thermal request and the pipe connecting the user with the main network is oversized (This user is an existing user of the network). For the same reason, the user number 33 has a very high network cost 0.054 €/kWh, in comparison to the average value (0.011 €/kWh).

In [Verda and Kona 2012], the authors have highlighted the importance of using the thermoeconomic approach for the design and the analyses of energy savings initiatives in buildings connected to DHN. In this paper it is shown that there are potential advantages in introducing energy savings initiatives in buildings connected to district heating networks, mainly related to the possible reduction in operating temperatures and the possibility of connecting new users to the DHN, which may be a cost effective solution for the community.

The temperature of water flow feeding the network has been assumed as an operating parameter. It has been shown how this parameter influences the whole system operation conditions, as the products, electricity and heat supplied to the users depend on it. Heat losses need to be reduced and this can be achieved by means of lower temperature supply, which also extends the scope for using different sources of locally available waste and renewable heat. The use of exergy is particularly suitable for handling these problems and an economic scheme based on this quantity results to be effective.

Other problems are still open in district heating. In particular, the link between quality of heat and its price should be considered in order to properly consider the characteristics of the producers and users. In the near future it is expected that multiple producers are allowed to supply heat to district heating networks, similar to what happens with electricity producers in the case of the electric grid. Not only the amount of heat they may produce is important, but also its quality. Exergy is an effective way to

---

measure quality. Moreover, users characterized by local heating systems working at lower temperatures should be considered in a different way than users requiring the same amount of heat, but at higher temperature. As an example, users with radiant panels may be theoretically connected to the return network and use low grade heating. This is generally a big benefit for the energy system, since the returning temperature decreases and a more effective heat recovery is obtained in the thermal plant.

In [Verda and Kona, 2012], the energy and economic optimization of a district heating network is conducted using a thermo-economic based probabilistic procedure. The procedure is applied to a small low temperature district heating network. Groundwater heat pumps are considered as the possible alternative systems to supply heat to the users not connected to the district heating network.

A multi-objective optimization is performed for various combinations of the supply and return temperatures. The analysis shows that supply and return temperatures play a crucial role in the optimal configuration. In particular a reduction of both temperatures allows one to achieve smaller cost of heat in terms of required primary energy, but causes an increase in the economic costs. An increase in the return temperature causes an increase in both costs, which conducts to non competing objective functions.

The most important terms that affect to optimal configuration are the efficiency of solar collectors and the possible thermal interferences between heat pump, and, from the economic viewpoint only, the investment cost due to the seasonal thermal storage and the pipe network.

---

# 4

## Global Optimization Methodology

In this chapter the methodology developed for the search of the optimal configuration, design and operation of a district energy system is presented. The methodology proposed here is based on the application of the theory of the exergetic costs (see chapter 3) to obtain the cost of heat supplied to each single user. This quantity is used to decide which users should be disconnected from the network.

The developed methodology has been applied to the energy systems in the city of Casale Monferrato, a small town in the north-west of Italy (see chapter 5). Initially the buildings with thermal request located into the analyzed area of the city, are grouped in macrozones in order to simplify the superstructure. A second reason for grouping the users is related with the typical way of implementing district heating: when the pipeline reaches an area the users leaving there decide whether or not connect to the network. Once the superstructure is defined, the algorithm can be divided in two steps:

- the first step deals with the search of the “optimum” of the energy system (Optimal synthesis, design and operation properties);
- the second step involves the simulation of the evolution of district heating network with time.

A logical scheme of the developed methodology is represented in the figure [4.1](#).

The algorithm finds the optimal configuration of the energy system, which consists in:

- spotting the macrozones connected to the district heating network, the optimal DHN design and operation properties as well.
- spotting the macrozones supplied with alternative heating technology (such as groundwater heat pumps or gas natural fuelled condensing boilers).

This requires that the following aspects are considered: information about the buildings, costing model for the district heating and the alternative energy systems, the model for energy production by the thermal plant and the thermo-fluid dynamic model for the network.



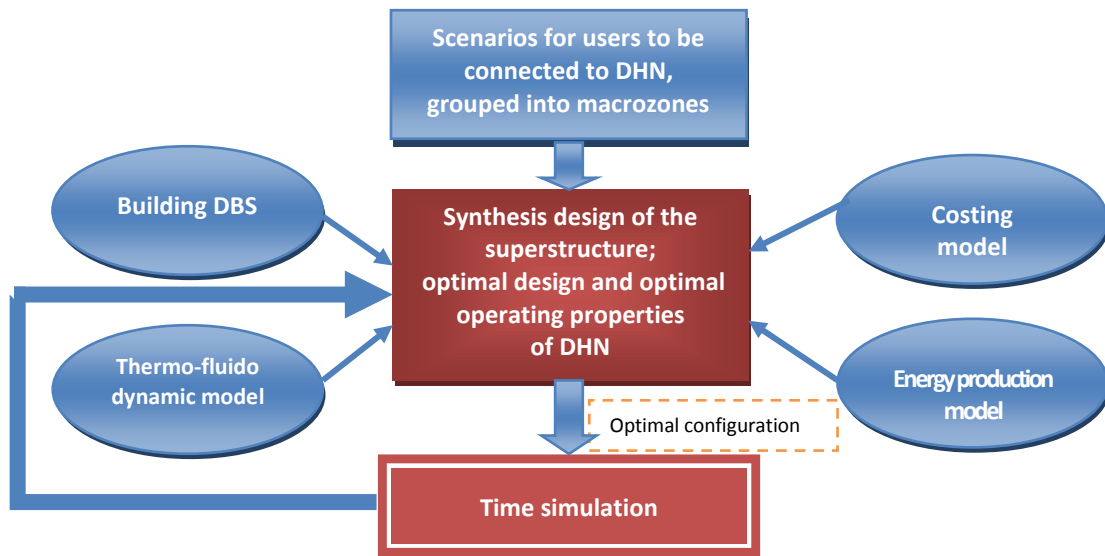

Figure 4.1 Conceptual diagram of the developed Methodology

Once the optimal configuration of the system has been spotted, a time simulation of the DHN expansion is performed. The time evolution may determines changes in the actual value of the objective function with respect to that calculated in the synthesis/design/operation. Therefore there is need for a feedback to the previous step.

In the following paragraphs the developed algorithm will be explained in details.

## 4.1 Optimal Configuration

Once the superstructure is defined, the algorithm deals with the search of the “optimum” of the energy system (i.e. Optimal synthesis, design and operation properties). The procedure begins with the evaluation of the objective function in the initial configuration. The objective function is the minimum average energetic/economic cost of heat of the energy system, composed by the DH network and alternative heating technologies for users not connected to the DH.

In order to define the average cost of heat (energetic or economic), a series of models have been developed and integrated as follows:

- Building DataBase System, where the information on the buildings are stored: the characteristics of the thermal request like: supply/return temperature; the annual quantity of heat; the spatial coordinates of the buildings. The detailed model is explained in section 4.1.1.
- Thermo-fluidodynamic model of the DHN, to obtain the mass flow rate in each branch, the pressure losses and the thermal losses.. The detailed model is widely explained in section 4.1.2.
- Costing Model, where all the direct and indirect costs related to the district heating network are calculated, both in terms of primary energy (exergetic cost) and money. This is necessary to obtain the value of the objective function at each

iteration as well as the unit cost of heat supplied to each single users, through thermoeconomic analysis. The detailed model has been explained in the section 4.1.3.

- Energy model production: where the design criteria of the thermal plant in terms of cogeneration appliances and industrial boilers; the model of the heating alternatives such as Geothermal Goundwater heat pumps (GWHP) and the natural gas fuelled condensing boilers. The detailed model is widely explained in section 4.1.4

At this stage, where the overall model of the energy system and the initial structure are defined, (i.e. all the users are connected to the district heating network), the procedure begins to evaluate the objective function, i.e. the unit cost (primary energy cost or economic cost) of heat supplied to each user connected to the DHN and then the average cost of heat of the overall energy systems.

The approach to achieve the optimal solution implies the reduction of the initial superstructure, i.e. the network is reduced by removing the users that determine high costs and the corresponding pipes connecting these users with the rest of the network.

Two criteria to select the users to be removed from the district heating network have been developed: the deterministic approach (based on selecting the user with the higher specific cost) and the heuristic approach (based on assigning a probability to the users to be disconnected from the DHN, as the function of their cost). The selection criteria have been widely explained in section 2.2.

The probabilistic criterion which is proposed for deactivating the users is similar to the simulated annealing algorithm [Schwefel et al. 1994]. This name is derived from a physical process used to harden steel, which will briefly be described below [Frangopoulos et al. 2002].

Annealing is the process of a mass of molten metal heated up to the transition to the liquid phase and then cooled more or less slowly. If the cooling is slow enough, the metal reaches a state of minimum energy, corresponding to the crystalline (and phase) structure in equilibrium at that temperature. If the cooling rate is "too high", the configuration might correspond to a state of local minimum and not global. Boltzmann was the first scientist who formulated a probabilistic law linking the temperature to the frequencies of the many possible energy states: this law is used to simulate the annealing process.

In the simulation, energy states are generated randomly. They are compared with the former one  $E_{old}$ : if the new state,  $E_{new}$ , is lower than the old one, then,  $E_{new}$  survives. Otherwise, if,  $E_{old}$  is lower than  $E_{new}$  there is still a probability for the system to leave the old state and enter the new one. This probability is computed as (eq. 4.1):

$$p = \exp\left(-\frac{E_{new}-E_{old}}{K \cdot T}\right) \quad (4.1)$$

where  $K$  is the Boltzmann constant and  $T$  is the current temperature of the system. The higher the difference between the two energy configuration, the lower the

probability for the system to enter in new state, but still that probability is not null. Therefore, Simulating Annealing (SA) procedure has the ability to escape from local optima and to reach the global one [Schwefel et al. 1994]. The SA can be used to describe phenomena other than the annealing, a n K and T parameters has be to chosen carefully.

In the following, the procedure derived from the SA technique is described. As the deterministic approach, this probabilistic approach is iterative. Being a probabilistic approach the probability to find the optimal configuration, can be increased by running the whole procedure several times (in this work, different procedures have been run from 1000 to 5000 times depending on the case )

In this procedure once the unit cost of heat has been determined for every zone (for the calculation procedure see section 2.3-2.4), a probability function  $p_j$  is assigned to each user (zone). This probability represents their probability of being deactivated and is determined by the equation 4.2

$$p_j = p_0 \cdot \exp\left(\frac{DC_j}{KT}\right) \quad (4.2)$$

where the term  $DC_j$  stands for the difference between the unit cost of user  $j$  and the average cost of heat (i.e. the objective function).  $KT$  is calculated through equation 4.3

$$KT = \log\left(\frac{\exp(\max cost1 - \text{mean cost})}{\exp(\max cost2 - \text{mean cost})}\right) * \frac{1}{\log(\text{ratio})} + \text{coeff}. \quad (4.3)$$

where  $\max cost1$  is the unit cost of heat for the user with the maximum cost,  $\max cost2$  is the unit cost of heat for the user with second maximum cost and  $\text{ratio}$  stands for the ratio between the probability of the highest cost and the probability of the second, while the coefficient  $p_0$  is calculated through the equation 4.4

$$p_0 = \frac{200}{\exp\left(\frac{(\max cost1 - \text{mean cost})}{KT}\right)} \quad (4.4)$$

Once the user is removed from the network and supplied with the alternative heating technology, the procedure proceeds with the calculation of the average cost of heat provided to the users in the new configuration.

The procedure is stopped when all the users are eliminated. Since the procedure is based on probabilistic criteria to disconnect the users, the entire procedure must be repeated various times, starting from the initial superstructure and disconnecting all users. The main advantage of this procedure is that complex networks can be easily processed.

Within the procedure, for every complete iteration (disconnection of all users starting from the superstructure) the best configuration is extracted and stored. The optimum is the best configuration (i.e. the minimum average energetic/economic cost of heat ) of all the iterations. Once the optimal configuration has been spotted, then a time simulation of the expansion and construction of the district heating network is done. The evolution in time procedure related to the expansion of the District Heating is explained in section 4.2.

A sensitivity analysis on the assignment of the probability function has been also performed. In table 4.1 the results obtained by launching 5000 iterations, with different value of the coefficients in the probability function are reported.

Coeff.	Minimum Energetic cost [kWh/kWh]	Configuration	Frequency
0.01	0.577	68 897 MWh supplied by DHN and 6 375 MWh supplied by the alt technology	94%
0.001	0.577	68 897 MWh supplied by DHN and 6 375 MWh supplied by the alt technology	95%
0.0001	0.577	68 897 MWh supplied by DHN and 6 375 MWh supplied by the alt technology	97%

Table 4.1 The frequencies of the minimum cost

In table 4.2 the optimal configurations of the DHN obtained for the simulations are shown.

	Configuration with coef.=0.01	Configuration with coef.=0.001	Configuration with coef.=0.0001	Configuration with coef.=0.00001
Zone 1	Connected to DHN	Connected to DHN	Connected to DHN	Connected to DHN
Zone 2	Connected to DHN	Connected to DHN	Connected to DHN	Connected to DHN
Zone 3	Connected to DHN	Connected to DHN	Connected to DHN	Connected to DHN
Zone 4	Connected to DHN	Connected to DHN	Connected to DHN	Connected to DHN
Zone 5	Connected to DHN	Connected to DHN	Connected to DHN	Connected to DHN
Zone 6	Connected to DHN	Connected to DHN	Connected to DHN	Connected to DHN
Zone 7	Connected to DHN	Connected to DHN	Connected to DHN	Connected to DHN
Zone 8	Connected to DHN	Connected to DHN	Connected to DHN	Connected to DHN
Zone 9	Connected to DHN	Connected to DHN	Connected to DHN	Connected to DHN
Zone 10	Connected to DHN	Connected to DHN	Connected to DHN	Connected to DHN
Zone 11	Connected to DHN	Connected to DHN	Connected to DHN	Connected to DHN
Zone 12	Not Connected to DHN	Not Connected to DHN	Not Connected to DHN	Not Connected to DHN
Zone 13	Connected to DHN	Connected to DHN	Connected to DHN	Connected to DHN
Zone 14	Connected to DHN	Connected to DHN	Connected to DHN	Connected to DHN
Zone 15	Connected to DHN	Connected to DHN	Connected to DHN	Connected to DHN
Zone 16	Connected to DHN	Connected to DHN	Connected to DHN	Connected to DHN
Zone 17	Connected to DHN	Connected to DHN	Connected to DHN	Connected to DHN
Zone 18	Connected to DHN	Connected to DHN	Connected to DHN	Connected to DHN
Zone 19	Connected to DHN	Connected to DHN	Connected to DHN	Connected to DHN
Zone 20	Connected to DHN	Connected to DHN	Connected to DHN	Connected to DHN
Zone 21	Not Connected to DHN	Not Connected to DHN	Not Connected to DHN	Not Connected to DHN

Table 4.2 The configuration of the DHN with different values of the probability function

As it can be seen from the table 4.1 and 4.2, the optimal configuration of the energy system is the same, it does not changed as the value of the coefficient of the probability function is tuned. But the frequency of the optimum value increases as this value decreases from 0.01 to 0.0001.

---

The optimal configuration comprise all zones connected to the DHN and zones 12 and 21 supplied with GGHP. The zones 12 and 21 presents the highest value of the primary energy consumption, principally due to the fact that they are far away from the main thermal plant, and characterized with a low thermal request.

### 4.1.1 Building DBS

This module is used for mapping the thermal requirements of the users. In the case studied, there are 196 end-users, comprising residential buildings, a hospital and public buildings. All these end users are mapped in a database and in order to simplify the representation and the analyses of a such complex area, the area has been divided into 21 macro-zones each representing a group of buildings. The annual heat load of each zone is calculated by considering, for the whole heating season, the daily difference between the internal temperature (20°C) and the external temperature, the average global heat transfer coefficient of buildings and the number of daily heating hours (hh). The global heat transfer coefficient of buildings can be multiplied for a shape factor defined as a ratio of the external surface (heat transfer area of the building) and the building volume. This quantity, indicated as  $r$ , expresses the volumetric heat losses per unit temperature difference. In this work an average value of 0.9 W/m<sup>3</sup>K, based on experimental data, has been used. The annual heat [kWh/year] for a zone is then expressed as (eq. 4.5):

$$E_{\text{thermal request}} = \frac{r \cdot DTD \cdot hh \cdot Vb}{1000} \quad (4.5)$$

Where  $Vb$  is the total volume of buildings in the zone and  $DTD$  is the sum of the daily difference between the internal and external temperature, calculated for the whole heating season. This data has been provided by the company (AMC spa). The data have been organized in order to extract the mean hourly temperature for the all the hours during the heating reason, and the frequencies of this values. There are 11 intervals with frequencies mapped in table 4.3. Given the annual thermal request of the users, within the model we defined the pattern of thermal power during the heating season (eq. 4.6).

$$\Psi_j = r * Vb * (20 - T_j) \quad (4.6)$$

In the table 4.3 are reported the values of the thermal power required by the users in the initial superstructure. When the users are disconnected, the corresponding heat request is supplied by the alternative system, instead of the district heating network. These 11 operating conditions are simulated for each network configuration in order to account for the variations in the operation during the heating season.

Intervals	Mean hourly temperature [°C]	Frequencies	Thermal power Buildings [MW]
1	-11.45		
2	-8.45		
3	-5.45		
4	-2.45		
5	0.54		
6	3.54		
7	6.54		
8	9.54		

---

9	12.54
10	15.54
11	18.54

Table 4.3 Features of the thermal request of the users

Other important information stored in the DBS are the spatially coordinates of the end-user. This information is useful in order to determine the length of the pipes connecting the end-users to the DH network as well as for the model simulation of the groundwater thermal degradation due to a massive installation of geothermal groundwater heat pumps (see section 4.1.4).

### 4.1.2 Thermo fluid-dynamics model

This module is used to calculate the pressure losses and the heat losses in the network for each examined configuration and each operating condition.

For a general duct in one-dimensional geometry, assuming steady-state conditions and incompressible fluid, momentum equation is (eq. 4.7):

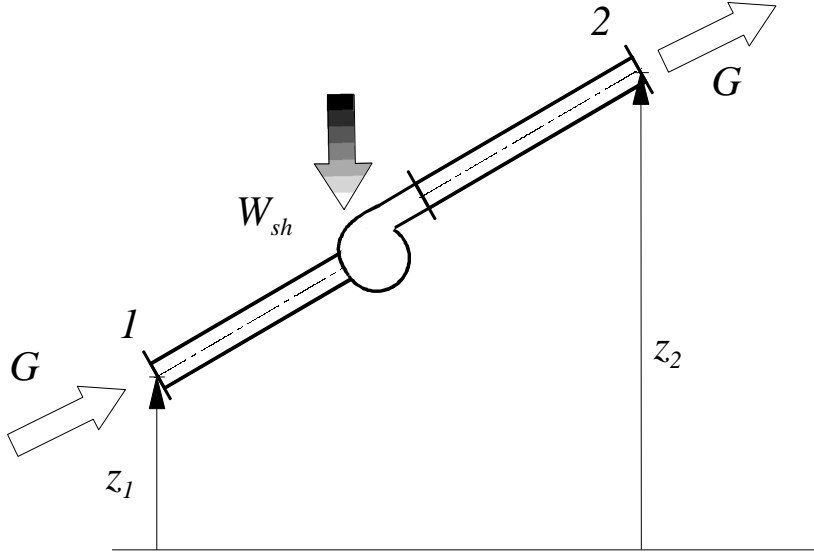

$$W_t + G l_a + G \left[ v(p_2 - p_1) + \left( \frac{V_2^2}{2} - \frac{V_1^2}{2} \right) + g(z_2 - z_1) \right] = 0 \quad (4.7)$$

where  $W_t$  is the shaft mechanical power,  $G$  the mass flow rate whose direction is chosen arbitrarily from 1 to 2,  $l_a$  the unit mass friction loss,  $v$  the specific volume,  $p$  the static pressure,  $V$  the mean velocity in a section, and  $g$  the gravity. More concisely, in the hypothesis that the kinetic energy differences are negligible, the equation can be written in the form (eq. 4.8):

$$W_t + G \cdot l_a + G \cdot v \cdot (P_2 - P_1) = 0 \quad \text{with} \quad P = p + \rho \cdot g \cdot z \quad (4.8)$$

Friction losses can be written as the summation of two terms: distributed friction and localized friction (eq. 4.9).

$$l_a = l_{ad} + l_{ac} \quad (4.9)$$

which can be expressed as:

$$l_{ad} = \xi \cdot \frac{L}{D} \cdot V^2 \quad (4.10)$$

$$l_{ac} = \beta \cdot \frac{V^2}{2} \quad (4.11)$$



where L is the pipe length, D the diameter,  $\xi$  is the friction coefficient, which is a function of Reynolds number and duct roughness “e” through the Coolebrook formula (eq. 4.12):

$$\frac{1}{\sqrt{\xi}} = -2 \cdot \log \left[ \frac{e}{3.7 \cdot D} + \frac{2.51}{\text{Re} \cdot \sqrt{\xi}} \right] \quad (4.12)$$

The local friction coefficient  $\beta$  depends on the type of geometric variations in the various components.

The mass flow rate in a section can be expressed as (eq. 4.13 ):

$$G_j = \rho \frac{\pi \cdot D^2}{4} \cdot v \quad (4.13)$$

In the case of a pipe, equation (4.8) can be rewritten considering the previous assumptions and considering the absence of shaft power, as:

$$(P_1 - P_2) = s \cdot R_p \cdot G^2 \quad (4.14)$$

where s is +1 o -1 depending on the actual verse of mass flow rate (+1 is coherent with the conventional verse). This equation can be used to obtain an expression of the mass flow rate as the function of the pressure difference:

$$G = Y_{12} \cdot (P_1 - P_2) \quad (4.15)$$

Where:

$$Y_{12} = \frac{1}{R_p^{0.5} \cdot |\Delta P|^{0.5}} \quad (4.16)$$

To handle complex networks, with large number of pipes, a topological matrix can be used. This is the incidence matrix **A**, which is characterized by as many rows as the branches (m) and as many columns as the nodes (n). The general element **A<sub>ij</sub>**, is equal to 1 or -1, respectively if the branch j is entering or exiting the node I, and 0 in other cases.. In order to implement the incidence matrix the nodes are named, and the branches are mapped assigning a conventional exiting node from which the flow exits and the entering node in which the flow enters.

The continuity equation at nodes is written as:

$$\mathbf{A} \mathbf{G} + \mathbf{G}_{\text{ex}} = \mathbf{0} \quad (4.17)$$

where G is a vector containing all mass flow rates in the branches and **G<sub>ex</sub>** the vector of mass flow rate exchanged at nodes.

The pressure differences in all branches can be expressed as

$$\Delta \mathbf{P} = \mathbf{A}^T \mathbf{P} \quad (4.18)$$

and the mass flow rates can be obtained as the function of the pressure differences:

$$\mathbf{G} = \text{diag}(\mathbf{Y}) \Delta \mathbf{P} = \text{diag}(\mathbf{Y}) \mathbf{A}^T \mathbf{P} \quad (4.19)$$

Therefore:

$$\left[ \mathbf{A} \text{diag}(\mathbf{Y}) \mathbf{A}^T \right] \mathbf{P} + \mathbf{G}_{\text{ex}} = \mathbf{0} \quad (4.20)$$

The boundary conditions for this equation set are the mass flow rates at the nodes corresponding with the users:

$$G_j = \frac{\Phi_j}{(h_f - h_r)} \quad (4.21)$$

Where  $\Phi_j$  is the thermal flow provided to the users (the maximum load has been considered for the design),  $G_j$  is the water mass flow rate,  $h_f$  and  $h_r$  are the enthalpies of fluid feeding the user and returning from the user.

An additional boundary condition is the supply pressure at the thermal plant (which is imposed in order guarantee that the return pressure is larger than the minimum acceptable value).

The diameter of pipes is determined by imposing the optimal velocity in the pipes under the constrain of the maximum allowed velocity. The optimal value is mainly defined on the basis of economic criteria, since friction losses and thus pumping cost depend on the square of velocity.

Once the mass flow rates are computed, the heat losses can be calculated as (eq. 4.22):

$$\Phi_{\text{losses } j} = \frac{U_j}{2} * \pi * L_j * D_j * (T_s - T_t) + \frac{U_j}{2} * \pi * L_j * D_j * (T_r - T_t) \quad (4.22)$$

where  $U_j$  is the global heat transfer coefficient,  $L$  is the pipe length and  $D$  its diameter,  $T_s$  is the supply temperature,  $T_t$  the ground temperature and  $T_r$  the return temperature.

### 4.1.3 Costing model

As shown in the previous sections, the cost model is necessary to calculate the objective functions and the unit cost of heat supplied to each single user, through thermoeconomics. In this section, the cost functions that are used for obtaining the investment cost rates in monetary units and primary energy units are presented.

#### Monetary cost of the DHN

The total annual economic cost of heat for the users connected to the DHN network, is calculated in the eq. 2.10, where the three first components constitutes the cost of the network (eq. 4.23), while the forth component is related to the thermal plant .

$$C_{district\ network} = C_{thermal\ losses} + C_{network} + C_{pumping} \quad (4.23)$$

Where:

$C_{thermal\ losses}$  is the annual cost of primary energy due to thermal losses incurring in the pipes, calculated (eq. 2.11) as a product of the total primary energy due to thermal losses  $E_{P_{thermal\ losses}}$  calculated in the eq. 2.3 and the economic cost of heat ( $C_{prod}$ ).

$C_{pumping}$  is the annual cost of primary energy utilised for the pumping during the heating season, calculated (eq. 2.12) as a product of the total primary energy required for pumping  $E_{P_{pumping}}$  and the unit cost of electricity  $c_{elc}$ .

$C_{network}$  is the annual cost of the investment of DH, it includes: purchase of insulated pipes, pumps, valves, together with other direct costs, which means excavation, installation and paving restoration, and the cost of heat exchange substations installed in the user buildings.

The total investment cost of the district heating network,  $C_{network}$ , includes: purchase of insulated pipes, pumps, valves, together with other direct costs, which means excavation, installation and paving restoration ( $C_{district\ network}$ ), and the cost of heat exchange substations installed in the user buildings ( $C_{sst}$ ) (eq. 4.29). The total cost of district heating can be written as (eq. 4.24):

$$C_{network} = PC_{pipes} + C_{install} \quad (4.24)$$

where  $PC_{pipes}$  represents the purchasing cost of pipes. A function (eq. 4.25) obtained by interpolation of available data has been used to compute this cost (i.e. data on the purchasing costs of the pipes has been provided by the utility company):

$$PC_{pipes} = (a_0 + a_1 \cdot D_{int} + a_2 \cdot D_{int}^2) \cdot L \cdot 2 \quad (4.25)$$

Where  $D_{int}$  is the internal diameter of the pipe,  $L$  stands for the length of the pipe, while the coefficients of polynomial are:  $a_0 = 42$  €/m,  $a_1 = 0.268$  €/(mm·m), and  $a_2 = 8.18 \cdot 10^{-4}$  €/(mm<sup>2</sup>·m).

$C_{install}$  represents the cost of installation of the DH network, and it is a function of excavation volume and the quantity of sand (eq. 4.26):

$$C_{install} = f(Vol_{excav}; Q_{sand}) \quad (4.26)$$

where the excavation volume and the quantity of sand are functions of pipe diameters and depth and they are computed as above (eq. 4.27 and 4.28):

$$Volume_{excav} = Area(Diameter, Length) * Depth(D) \quad (4.27)$$

$$Q_{sand} = (0.4 + D) * Area(D, L) - D^2 * \pi * L/2 \quad (4.28)$$

The purchase cost of the Heat Exchange sub-station ( $C_{sst}$ ) has been computed as a function of the thermal power (eq. 4.29) , according with a general function (Bejan et al. 1996):

$$TC_i = TC_0 * \left(\frac{X_i}{X_0}\right)^\alpha \quad (4.29)$$

where  $TC_0$  is the known cost of the component at a specific size,  $X$  is a variable selected for expressing the component size,  $X_i$  is its value for the component whose cost is calculated and  $X_0$  its reference value. The coefficients has been calculated from interpolation of the provided data from the utility company:  $TC_0 = 8782$  e  $X_0 = 150$ , while  $\alpha=0.7306$ .

#### Primary energy consumption of the DHN

The primary energy consumption associated with the DH is calculated through the eq. 2.2, where the three components constitutes the energetic cost of network (eq. 4.30), while the fourth is the heat production cost.

$$Ep_{District\ network} = Ep_{thermal\ losses} + Ep_{network} + Ep_{pumping} \quad (4.30)$$

Where:

$Ep_{thermal\ losses}$  is the annual primary energy consumption due to thermal losses incurring in the pipes, calculated in the eq. 2.3;

$Ep_{pumping}$  is the annual primary energy required for pumping during the heating season, calculated as a production between the electricity consumed and the exergetic cost of electricity (eq. 2.5):

$Ep_{network}$  is the annual primary energy consumption due to the construction of the network. These energetic costs includes:

- the production and transportation of the insulated pipes;
- excavation of the pavement and the pavement restoring.

$$Ep_{network} = Ep_{material} + Ep_{transport} + Ep_{construction} \quad (4.31)$$

The energetic costs for installation have been calculated by determining the dimensions of the excavation. It has to be 500 mm wider than the pipes' external diameter and 650 mm deeper; a sustaining and covering layers of sand 100 mm high is also required. An example of excavation is shown in figure 4.2.

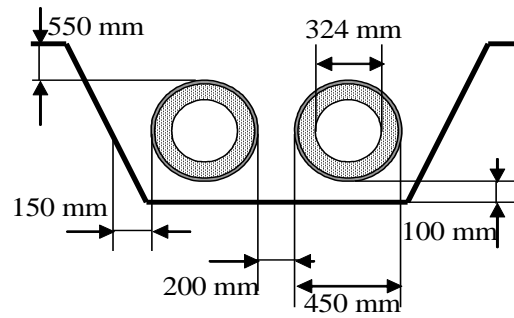

Figure 4.2 A sketch of excavation for the network installation

The primary energy consumptions required to build network components and for the materials are shown in table 2.1, while the primary energy consumptions corresponding with the main installation labor are shown in table 2.2 [Verda et al. 2009].

Sand	0.1
Asphalt	2.67
Polyurethane	72.1
Steel	34.44
PEHD	84.4

Table 4.4 Primary energy consumptions [MJ/kg] associated with the materials and components

Clipper	3.56	Track	21.35
Hammer	4.73	Pneumatic rammer	2.39
Electricity generator	4.73	Pavement storing	23.74
Mini excavator	8.29	Roller	19.00
Excavator	17.79	Cement mixer	17.79
Terna	14.23		

Table 4.5 Primary energy consumptions [MJ/m<sup>2</sup>] associated with the installation labour

#### 4.1.4 Energy production model

The energy production model is divided in two parts: one describing the energy production model in the thermal plant and the other the alternative heating technology at building level.

##### The thermal plant energy production model

The production unit at the CHP Station is composed by the cogeneration appliance and a series of industrial boilers. In figure 4.3 a schematic of the District Heating system borders is reported.

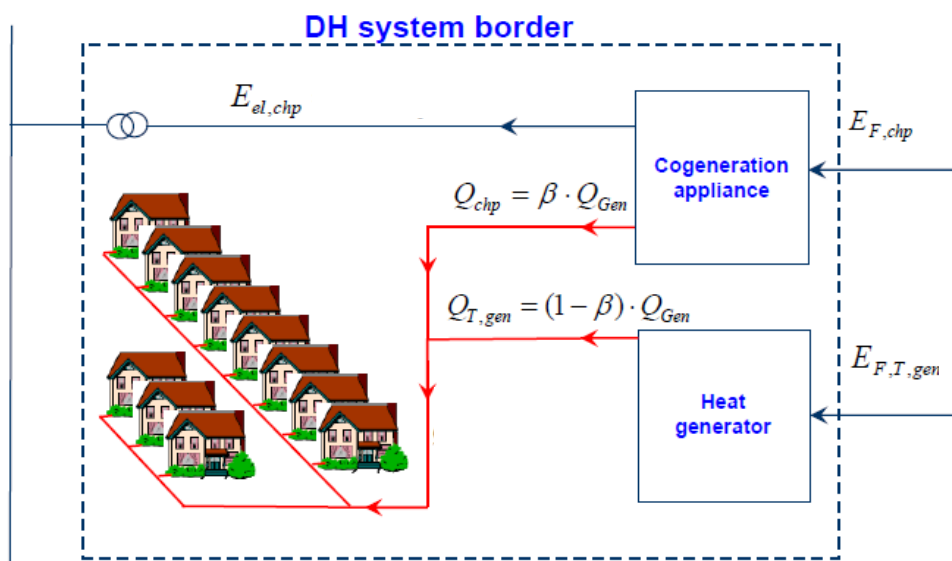

Figure 4.3 District heating system borders

The cogeneration appliances, for the case application are internal combustion engines and industrial natural gas fuelled boilers.

The CHP ratio  $\beta$  represents the ratio between the amount of thermal energy produced by the cogeneration appliance and the total amount of thermal energy produced at the power station. This parameter has been considered as one of the design variables and has been chosen randomly. This cases will be reports in the chapter 5.

The choice of the supplied (90°C) and the return temperature (65°C) of the DHN was a consequence of the case application. This optimization technique has been used for the optimal planning of the expansion of the DHN of the city of Casale Monferrato, which has an existing DH scheme with 90-65°C of supply and return temperatures.

First of all, data were collected from the existing CHP plant. The existing plant comprises an internal combustion engine and two industrial boilers (10 MW of thermal power installed and 1MW of electric power) and a length of 6km of district heating

network. This network supplies heat to 40 buildings, grouped in the macrozone one. The amount of the annual thermal request of the buildings were obtained from the utility company (AMC).

Given the yearly pattern of the thermal request of the users, a simulation model of the overall thermal energy produced by the CHP station has been performed. The model takes into account not only the thermal request of the buildings (see section 4.1.1), but also the thermal losses incurring in the pipes during the heating season. In figure 4.4 the cumulative heat production curve during the heating season is represented.

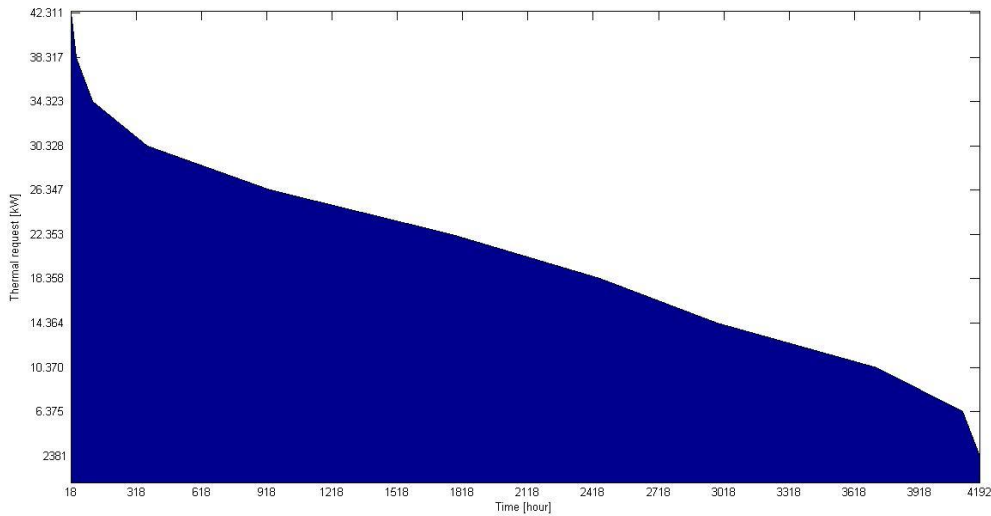

Figure 4.4 Cumulative heat production for the thermal plant

Writing the balance equation to the exergetic costs for the CHP internal combustion engine (fig. 4.5) we have (eq. 4.32):

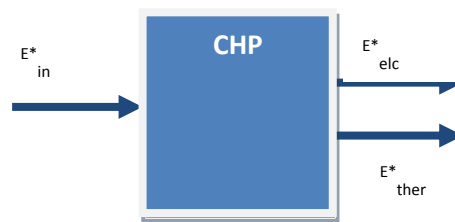

Figure 4.5 District heating system borders

$$\sum E_{in}^* - \sum E_{out}^* = 0 \quad (4.32)$$

where the  $E^*$  are the exergetic costs of the flows. First of all, we assume that the exergetic cost of the fuel is equal to its exergy (as indicated by the first auxiliary equation in the theory of exergetic cost) , in other words it means that in absence to other evaluations, the specific exergetic cost  $k^*$  of a flow entering an energy system from the environment is equal to 1. This primary thermal flow can be written as the output thermal

flow divided by the thermal efficiency of the engine (eq. 4.33), which allows one to refer the analysis to the thermal request of the network:

$$E_{in}^* = E_{in} = \frac{\Phi_{T\ chp}}{\eta_{chp\ th}} \quad (4.33)$$

The exergy outputs of the internal combustion engine are:

1. the thermal exergy, i.e. the exergy related to a thermal flow can be written as follows (eq. 4.34):

$$E_{ther} = \Delta B = \dot{m} \cdot (\Delta h - T_0 \cdot \Delta s) \quad (4.34)$$

2. the exergy related to the electrical power: the exergy is equal to the generated electric power (eq. 4.35), and it can be written as a function of the primary thermal flow times the electric efficiency of the engine:

$$E_{elc} = W_{chp} = \eta_{elc} \cdot \frac{\Phi_{T\ chp}}{\eta_{chp\ th}} \quad (4.35)$$

Based on the fourth assumption of the auxiliary equations of thermoeconomics: if the product of a component is defined as the summation of two or more flows, then the exergetic unit costs  $k^*_{chp}$  of these flows are the same. All these information and assumptions can be incorporated in the cost balance equation, thus obtaining eq. 4.36:

$$E_{in} = \frac{\Phi_{T\ chp}}{\eta_{chp\ th}} = \dot{m} \cdot (\Delta h - T_0 \cdot \Delta s) \cdot k^*_{chp} + \eta_{elc} \cdot \frac{\Phi_{T\ chp}}{\eta_{chp\ th}} \cdot k^*_{chp} \quad (4.36)$$

By substituting the thermal flow as a function of the enthalpy difference, can be written as (eq. 4.37-4.38):

$$\frac{\dot{m} \cdot \Delta h}{\eta_{chp\ th}} = \dot{m} \cdot (\Delta h - T_0 \cdot \Delta s) \cdot k^*_{chp} + \eta_{elc} \cdot \frac{\dot{m} \cdot \Delta h}{\eta_{chp\ th}} \cdot k^*_{chp} \quad (4.37)$$

$$k^*_{chp} = \frac{1}{\eta_{th}} \cdot \frac{1}{\left(1 - T_0 \frac{\Delta s}{\Delta h} + \frac{\eta_{elc}}{\eta_{th}}\right)} \quad (4.38)$$

Once the exergetic cost of heat produced by the CHP station has been defined, we proceed on the calculation of the exergetic cost of heat produced by the thermal plant. In order to do so, let us reconsider the border of the thermal power plant as represented in figure 4.6.

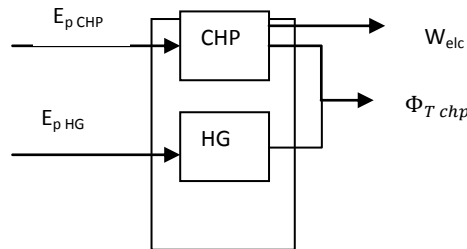

Figure 4.6 Thermal Plant system borders



The primary energy unit cost of heat ( $k_{prod}$ ) produced in the thermal plant can be written as the summation of two terms: the first term is the cost of heat produced by the CHP generator and the second term refers to the cost of heat produced by the boilers (eq. 4.39):

$$k_{prod} \cdot (m \cdot \Delta h) = \beta \cdot k_{chp}^* \cdot (m \cdot \Delta B) + (1 - \beta) \cdot k_{HG} \cdot (m \cdot \Delta h) \quad (4.39)$$

Where  $\beta = \frac{Q_{chp}}{Q_{tot}}$  is the cogeneration ratio, and  $(1 - \beta)$  is the ratio of heat produced by the industrial boiler at the power station. The  $k_{chp}^*$  is the exergetic cost of heat produced by the CHP appliance and  $k_{HG} = \frac{1}{\eta_{HG}}$  is the energy cost of heat produced by the boilers. The unit cost of is thus calculated as (eq. 4.41):

$$k_{prod} \cdot (m \cdot \Delta h) = \beta \cdot k_{chp}^* \cdot (m \cdot (\Delta h - T_0 \cdot \Delta s)) + (1 - \beta) \cdot k_{HG} \cdot (m \cdot \Delta h) \quad (4.40)$$

$$k_{prod} = \beta \cdot k_{chp}^* \cdot \left(1 - T_0 \cdot \frac{\Delta s}{\Delta h}\right) + (1 - \beta) \cdot \frac{1}{\eta_{HG}} \quad (4.41)$$

#### The alternative heating technology energy production model

The energetic cost of heat supplied by the alternative technology is calculated as follows:

- For condensing boilers (eq. 4.42):

$$k_{alt} = \frac{1}{\eta_{cond \ boiler}} \quad (4.42)$$

- For Geothermal Groundwater Heat Pumps (GGHP), this cost is a function of the coefficient of performance of the pump and of the electric efficiency of the national energy system (eq. 4.43):

$$k_{alt} = \frac{1}{COP} \cdot \frac{1}{\eta_{elc \ mix}} \quad (4.43)$$

A parametrical analysis is conducted by changing the efficiency of the heat pumps in order to evaluate the effects on the optimal system configuration.

Moreover, in the case of massive installation in a urban center, it is possible that the water discharged by a heat pump (which is colder than the inlet temperature in winter operation) affects the temperature of water entering a downstream installation. The latter will be operating with smaller COP than in the case of unperturbed groundwater. The extension of perturbed area mainly depends on water velocity in the ground. A CFD model (fig 4.7) of the aquifer able to describe the impact of the heat pump on the groundwater temperature has been developed in previous work [Verda et al. 2012]. Information from temperature distributions can be used in order to evaluate the impact produced by the thermal plume on the COP, depending on the position of the

downstream installation.

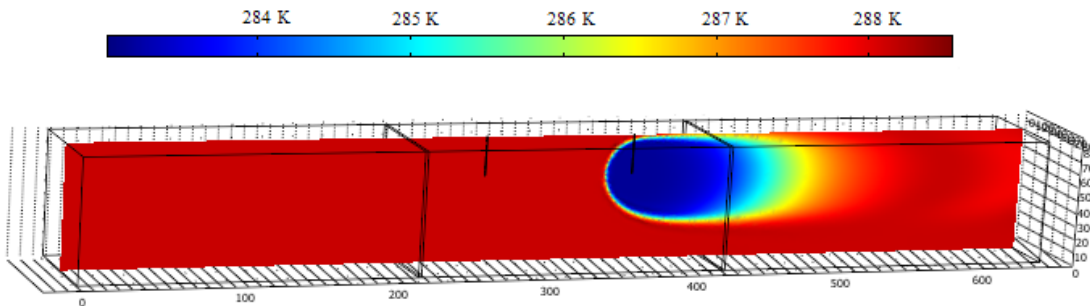

Figure 4.7 Computational domain and slice temperature distribution for unbalanced heat load

In particular, it is possible to calculate the average deviation of the groundwater temperature with respect to the undisturbed groundwater temperature during the heating season. This term has been calculated by weighting each contribution for the heat request at that time.

This deviation is represented in Figure 4.8 for an aquifer characterized by a groundwater velocity as in Casale Monferrato..

The average thermal deviation is about 4 °C close to the injection well and becomes about 1.5 °C at about 250 m. The effect on the COP is a significant reduction (**black curve**): more than 5% up to 150 m from the injection well. There is then an area with almost unperturbed performance. This occurs because the thermal plume affects this area mainly outside the heating season. There is then a second effect, smaller than the first one, starting about 750 m from the injection well. This is due to the thermal plume originated the year before.

Based on this information a model on how the thermal degradation of the waterlayer affects the heat pump efficiency has been implemented.

An interpolation function of the back curve on the graph has been computed within the model. The coefficient of performance is multiplied by a matrix of the thermal impacts, which is a square matrix containing the relative distance between the users with respect to the groundwater flow direction (the impact is only produced downstream). If the extraction well of a GGHP is located in the thermal plume of a nearby heat pump, its COP is reduced.

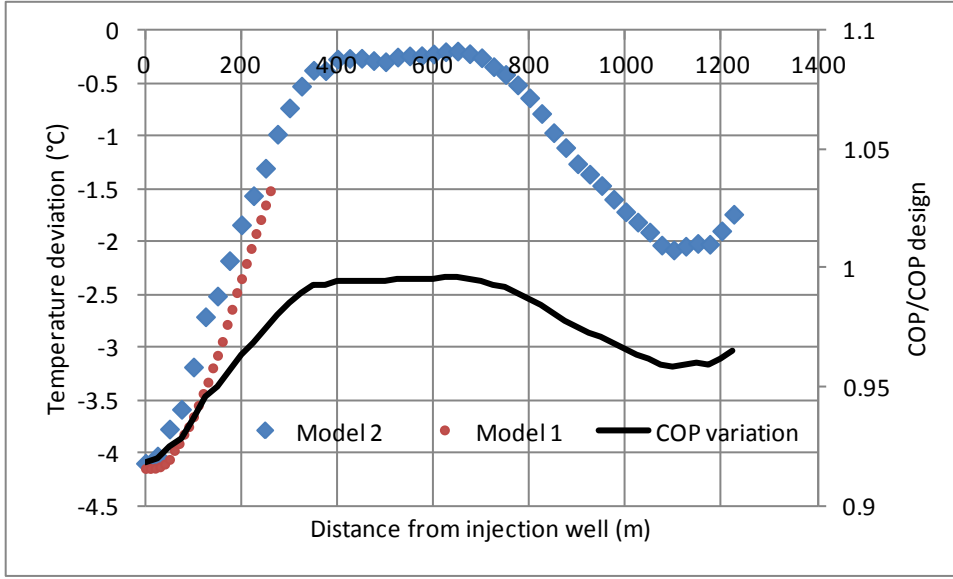

Figure 4.8 Groundwater temperature deviations and effects on the heat pump COP

The economic unit cost of heat produced at the power station

The thermoeconomic theory allows the definition of the cost of the productive flows (fuels and products of all the components), which can be expressed in thermodynamic and monetary units. By applying the monetary cost balance to the thermal power plant, we can write the following equation 4.44:

$$c_f * E_F + \dot{Z}_{plant} = c_w * E_{elc} + c_{prod} * E_{ther} \quad (4.44)$$

Where  $E_F$  is the annual primary energy (natural gas spent in the internal combustion engine  $E_{F\ chp}$  and natural gas spent in the heat generators  $E_{F\ HG}$ ) spent in the thermal power station, in order to produce the annual thermal energy  $E_{ther}$  required in the DHN and the annual electricity  $E_{elc}$ . While  $\dot{Z}_{plant}$  is cost rate of the thermal plant, computed in eq.

$c_w = p_w$  is the average price of selling the electricity to the grid;  
 $c_{prod}$  is the economic cost of heat and  $c_f$  is the unit cost of the natural gas, which depends on the type of use. In our case, the previous equation can be written as (eq. 4.45):

$$\begin{aligned} (1 - \beta) * c_{f\ HG} * (E_{F\ HG}) + \beta * c_{f\ chp} * (E_{F\ chp}) + Z_{plant} = \\ = p_w * E_{elc} + c_{prod} * E_{ther} \end{aligned} \quad (4.45)$$

By simplifying the previous equation we can express the economic unit cost of heat produced at the power station as (eq. 4.46):

$$c_{prod} * E_{ther} = c_{f\ HG} * (1 - \beta) * \left( \frac{E_{ther}}{\eta_{HG\ ther}} \right) +$$

$$+ c_{f\ chp} * \beta * \left( \frac{E_{ther}}{\eta_{chp\ ther}} \right) + Z_{plant} - p_w * (E_{elc}) \quad (4.46)$$

The electricity produced at the power station can be written as a function of the thermal energy (eq. 4.47)

$$E_{elc} = \left( \frac{\beta * E_{ther}}{\eta_{chp\ ther}} \right) * \eta_{chp\ elc} \quad (4.47)$$

By substituting the electricity with the expression in eq. 4.46, we can write the economic unit cost of heat as (eq. 4.48):

$$c_{prod} = c_{f\ HG} * \left( \frac{(1 - \beta)}{\eta_{HG\ ther}} \right) + c_{f\ chp} * \left( \frac{\beta}{\eta_{chp\ ther}} \right) + \left[ \frac{Z_{plant}}{E_{ther}} - p_w * \left( \frac{\beta * E_{ther}}{\eta_{chp\ ther}} \right) \eta_{chp\ elc} \right] \quad (4.48)$$

#### The cost rate of the thermal plant

The cost of building the thermal plant  $PC_{structure}$  is assumed equal to 1,45 M€ (data provided from the utility company); while the total investment cost for the power generation appliances is a function of the electric power  $W_{chp}$  and the thermal power  $\Phi_{T\ Heat\ generators}$  (eq.4.49):

$$TCI = 600 \cdot (W_{chp}) + 10 \cdot \Phi_{T\ Heat\ generators} + PC_{structure} \quad (4.49)$$

These cost has been levelized with a discount rate of 5%. The equivalent annual cost has been computed as (eq. 4.50):

$$TC_c = TCI \frac{(1+d)^l}{(1+d)^l - 1} \cdot d \quad (4.50)$$

Where d is discount rate, and l is the lifetime of the network, expressed in years. The cost rate component  $\dot{Z}_{plant}$  expressed in €/s is computed as (eq. 4.51):

$$\dot{Z}_{plant} = \frac{TC_c}{operating\ hours} * \frac{1}{3600} \quad (4.51)$$

#### The economic unit cost of heat produced with an alternative technology

$c_{alt}$  is the economic unit cost of heat and it is computed as:

For condensing boilers this unit cost is the cost of the natural gas expressed in kWh, while for the GGHP there is no cost at all.

The purchase cost of the GGHP or the condensing boilers has been computed as a function of the thermal power, according with a general function (Bejan et al. 1996). The

---

coefficients has been calculated from interpolation of the provided data from the utility company:

$$TC_{alternative\ tech} = TC_0 * \left(\frac{X_i}{X_0}\right)^\alpha \quad (4.52)$$

For condensing boilers:  $TC_0 = 13662$  and  $X_0 = 70$  kW, while  $\alpha=0.358$ , while for GGHP :  $TC_0 = 625$  and  $X_0 = 1$ , while  $\alpha=1$ .

The cost rate of these components, can be written, by applying (eq. 4.52), where  $d$  is discount rate, and  $l$  is the lifetime of the network, expressed in years. The cost rate component  $\dot{Z}_{alt}$  expressed in €/year is computed as (eq. 4.53):

$$\dot{Z}_{alt} = TC_{alternative\ tech} * \frac{(1+d)^l}{(1+d)^l - 1} \cdot d \quad (4.53)$$

---

## 4.2 Time evolution of the network

The time simulation procedure takes into account the expansion in time of the DHN, hence the connection of the macrozones as well as the production of energy flows in the thermal plant.

In the algorithm, the position of the zones and the thermal plant is mapped. In the case application (DHS of Casale Monferrato) there is an existing macrozone, denominated as zone 1. A standard length of network that can be installed each year is imposed based on data provided by the utility company.

The distances between the zones and the existing network is determined and consequently the users that can be connected each year are obtained assigning the priority to the closer users. Once the yearly value is reached, a simulation of energy production and the calculation of unit cost of heat per each user is performed. The new network configuration is also assigned as the status for the following year, i.e. the new users to be connected are selected on the basis of their distance with respect to this status of the network. This procedure continues till all the predesigned zones (from the optimization algorithm) are connected to the existing DHN.

The unit cost of heat supplied to the users during the construction period is generally different than that achieved at full development, therefore it is possible to repeat the entire synthesis/design/operation procedure considering a correction factor to the cost. This correction factor is explained by need of installing since the beginning the pipe diameters that are required at full development. In particular, the pipe exiting the thermal plant is selected with appropriate diameter to supply heat to all the users which will be connected with the network. This requires an initial investment cost that is remunerated by the heat supplied to the connected users, which may be significantly smaller than the value at regime. This causes larger payback and thus larger average cost of heat.

---

# 5

## Case applications

In this chapter, results from the application of the methodology to the district heating system of the city of Casale Monferrato are reported. The optimal configuration of the system has been examined with the various objective functions that have been previously introduced: minimum energy cost of heat, minimum economic cost and finally a multi-objective function. The energy performance of the alternative technologies, i.e. the efficiency of local boilers and the coefficient of performance of heat pumps, and the cogeneration ratio at the thermal power station have been modified in order to explore their sensitivity on the economic and energy costs of the whole energy system. The cogeneration ratio has been also considered as a possible design variable in the global optimization.

In figure 5.1 a map of the macrozones of the urban area of the city has been reported. In table 5.1 the thermal power heat requirements are reported for each macrozone.

Nr of macrozones	Macrozones denomination	Thermal power request [kW]	Thermal energy request [kWh]
1	San Bernardino - Ospedale		
2	Via Bligny		
3	Largo Minatori		
4	Via Pagliano		
5	Via Buozzi		
6	Via Hughues		
7	Via del Carmine		
8	Via Celoria		
9	Via Fr. Palli		
10	Via Savio		
11	C.so Manacorda		
12	Via Vigliani		
13	Via Pagliano		
14	Via Cavalli D'Olivola		
15	Via Mellana		

16	C.so Indipendenza- V. Crispi
17	Via Leardi
18	Via Cavour -Comune
19	Via Solferino
20	Via della biblioteca
21	Via Bertana- Via C. D'Olivola

Table 5.1 The map of the macrozones into which the city of Casale Monferrato has been divided

In Anex I the tables with the users and their thermal requests, the nodes and branches of the district heating network are reported.



Figure 5.1 The subdivision of the city into the macrozones

In the Figure 5.2 a sketch of the DHN of Casale Monferrato is represented. The users are grouped into the macrozones. As described in chapter 2, the selection procedure adopted in the objective functions is based on the average (economic or energy) costs of zones computed as below:

- 1) the cost of heat production is assumed as constant while the network is progressively simplified;



2) the pumping cost within each zone is computed considering the user with the most unfavourable path, i.e. the pipe network of the zone with the highest pressure losses;

3) the heat losses and the construction cost are computed considering the contribution of all the pipes connecting the users of the zone.

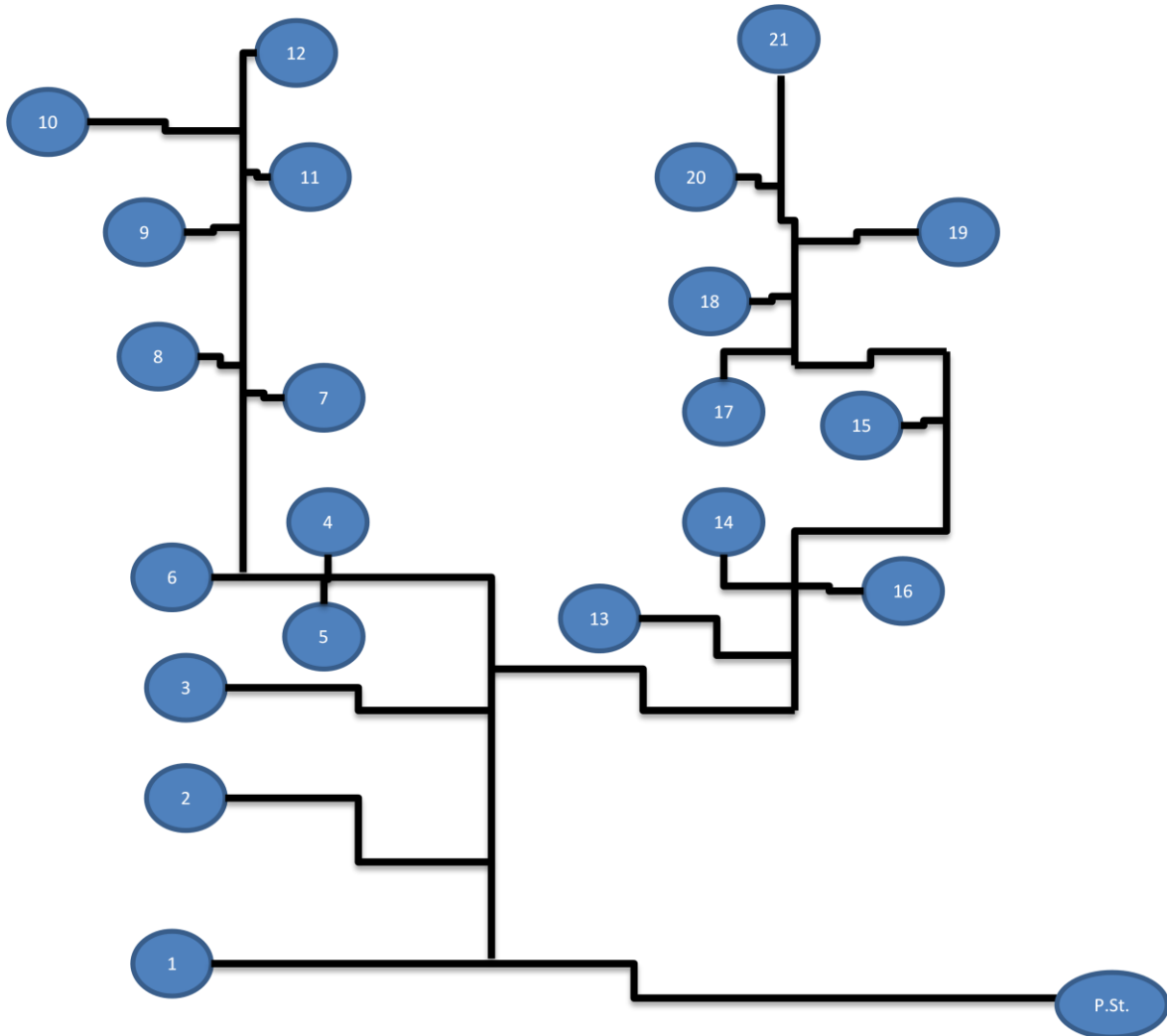

Figure 5.2 A sketch of the DHN of Casale Monferrato

The results obtained applying the following objective functions are reported:

- 1) Minimum primary energy cost of heat supplied to the users;
- 2) Minimum monetary cost of heat supplied to the users;
- 3) Multi-objective optimization.

## 5.1 Case application with energy based objective function

In this paragraph the results obtained from the application of the minimum energy cost of heat for the whole energy system as the objective function are reported.

Figure 5.3 shows the average energy cost of heat of the macrozones connected to the district heating network in the initial configuration (superstructure), with a cogeneration ratio of 50% (i.e. the ratio between the thermal power of the CHP appliance and the total thermal power installed at the power station).

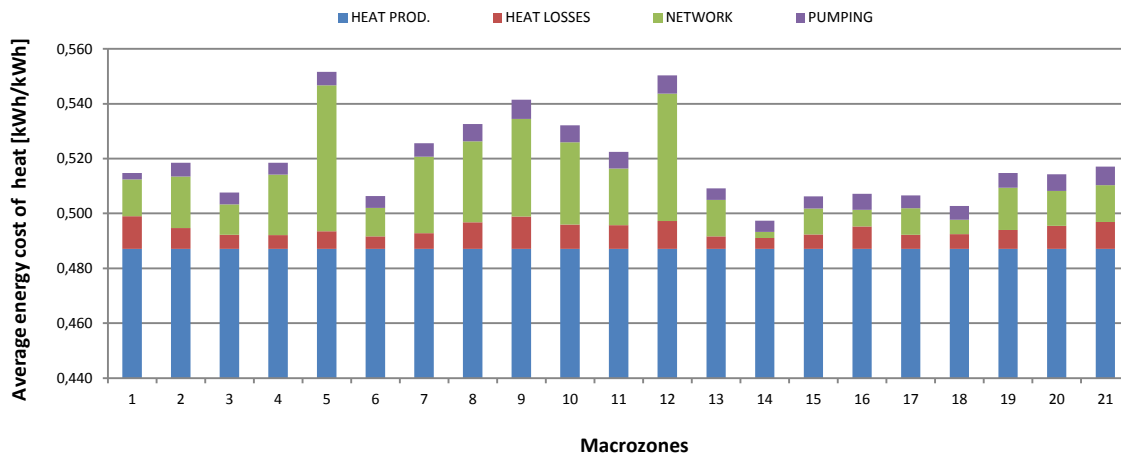

Figure 5.3 The average primary energy consumption of the macrozones connected to the DHN with CHP 50%

As it can be seen from the graph, the macrozones with the highest costs are the zones 5 and 12 principally due to the fact that they are far away from the main thermal plant, and characterized by a relatively thermal request.

In fact, the average cost due to the network construction is 0.019 kWh/kWh, while this value for the zone 5 is 0.053 kWh/kWh and for the zone 12 is 0.046 kWh/kWh. Furthermore, the average cost due to heat losses for the zone 12 is 0.01kWh/kWh, which are higher than the average value of the network (0.007 kWh/kWh).

Various simulations of the energy based objective function have been performed. As mentioned in chapter 4, two approaches have been adopted in order to select the zones to be disconnected from the DHN and supply with an alternative heating technology: the deterministic approach and the probabilistic approach.

### Deterministic approach

In figure 5.4, the average energy cost of heat (primary energy cost) of the overall energy system, using a deterministic approach on selecting the zone to be disconnected from the DHN, has been mapped. This cost is referred to an energy system where the alternative heating technology is the GWHP with different values of the coefficient of performance and cogeneration ratio.

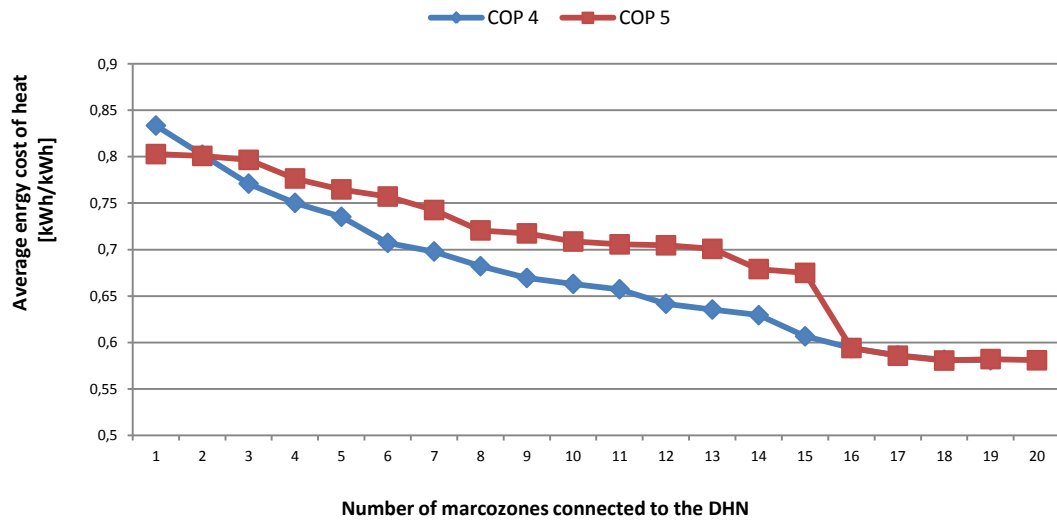

Figure 5.4 The average energy cost of heat based on deterministic approach with different COP and a CHP ratio of 40%

In figure 5.5, the average energy cost of heat determined with three different values of cogeneration ratio and a nominal coefficient of performance of 5 are reported. In general the average energy cost of heat increases as the zones are removed from the network, and supplied with the GWHP (i.e. the minimum value is reached with all the zones connected to the DHN). When the cogeneration ratio is large there is no advantage in disconnecting the users since the primary energy cost of the alternative is smaller than that obtained with district heating, despite the large COP of the heat pump. It should be also considered that the actual COP may be smaller than the nominal COP because of the possible interferences. The effect of interferences increase as the number of users supplied with the alternative technology increases.

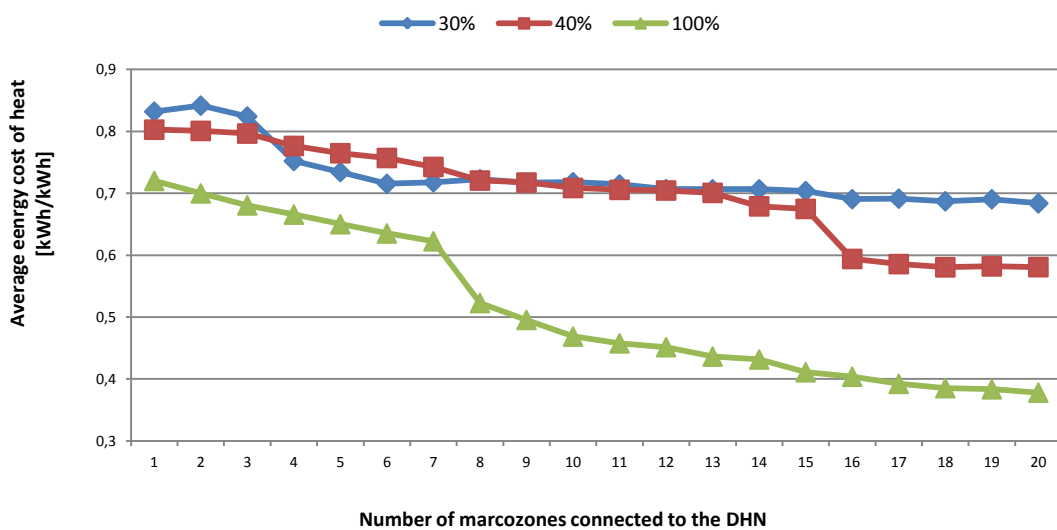

Figure 5.5 The average energy cost of heat based on deterministic approach with different CHP ratio and COP 5

In the case of smaller cogeneration ratio, there is some positive effect in disconnecting some of the users, but this is limited because of the increase in the cost of heat caused on the users connected with the network and, again, for the effects due to interferences.

### Probabilistic approach

As the procedure is iterative, several iterations have been launched in order to increase the certainty to find the true optimum. In figure 5.6 five of the various iterations (1000 complete iterations) of the average energy cost of heat of the overall energy system (with a CHP 40% and a COP 4) have been mapped. The values of the average energy cost of heat are different for the various iterations because of the different selections in the disconnection sequence. The results of the deterministic approach are also reported for comparison purpose.

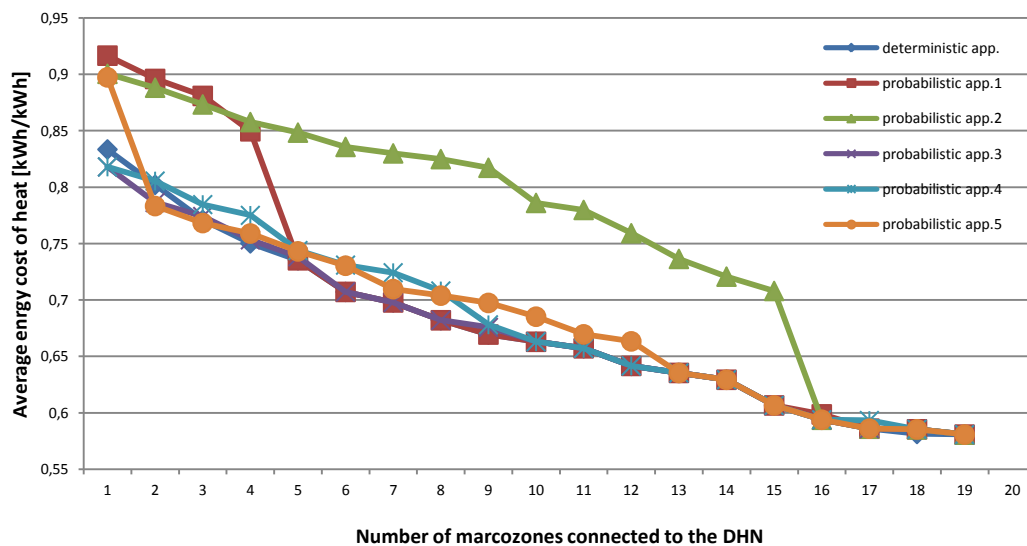

Figure 5.6 The average energy cost of the energy system (COP 4 and CHP 40%) with deterministic and probabilistic approach

In figure 5.7 the results obtained by launching 1000 iterations, with COP 4 and CHP 40% are reported. With heat pump efficiency of 4, the minimum average energy cost of heat (0.581 kWh/kWh) is reached with all the zones connected to the DHN (table 5.2).

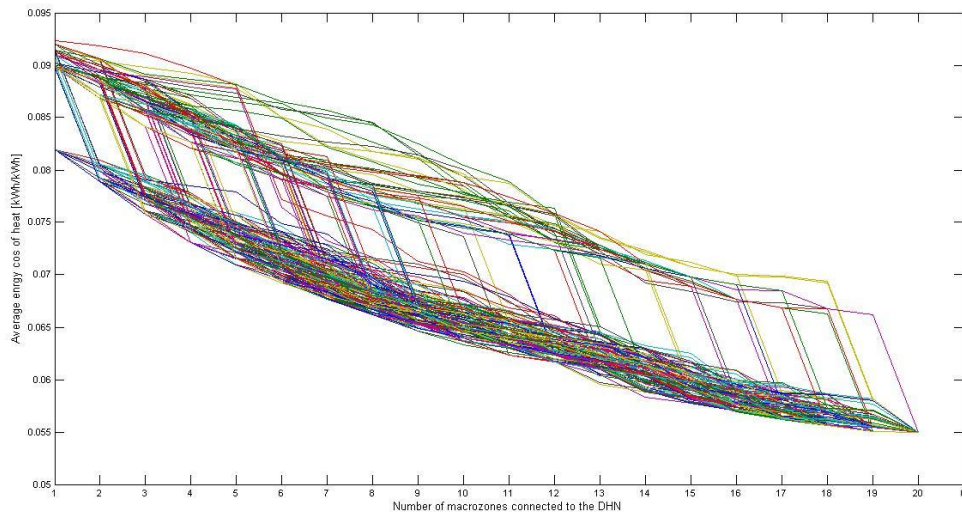

Figure 5.7 Simulations of the average energy cost of heat: COP4, CHP 40%

Cogeneration ratio	Average energy cost of heat [kWh/kWh]	Thermal request DHN [kWh]	Thermal request disconnected zones [kWh]	configuration
0,400	0,581	75.272.024	-	All zones connected to DHN

Table 5.2 Summary of Energy based optimizations with COP 4 and CHP ratio 40% (1000 iterations)

Moreover, other simulations based on probabilistic criteria have been performed with variable cogeneration ratio. The results from these simulations have been mapped in table 5.3 and table 5.4.

Clearly, the minimum average energy cost of heat decreases as the cogeneration ratio increases (e.g. CHP ratio 80% the min value of the energy cost is 0,394 kWh/kWh, while for a CHP of 40% this value is 0,581kWh/kWh). All optima have the same configuration of the energy system, i.e. all the zones are connected to the DHN. If a smaller cogeneration ratio lower than 40% is considered, the minimum average energy cost of heat is obtained with all the zones connected to the DHN, except the zones 12 and 21, which are the farthest from the thermal power plant.

Cogeneration ratio	Average energy cost of heat [kWh/kWh]	Thermal request DHN [kWh]	Thermal request disconnected zones [kWh]	configuration
0,100	0,922	39.477.028	35.794.996	Zones connected to DHN: 1,6,13-15,17-18
0,200	0,795	63.105.605	12.166.418	All zones connected to DHN, except 5,12,16 and 21,

0,300	0,682	68.897.204	6.374.820	All zones connected to DHN, except 12 and 21
0,400	0,581	75.272.024	-	All zones connected to DHN
0,500	0,507	75.272.024	-	All zones connected to DHN
0,700	0,415	75.272.024	-	All zones connected to DHN
0,800	0,394	75.272.024	-	All zones connected to DHN

Table 5.3 Summary of Energy based optimizations with COP 4 and varying the CHP ratio (20000 iterations)

Other simulations based on probabilistic criteria has been performed with a cogeneration ratio chosen randomly and a coefficient of performance of 5. The results from the these simulations has been reported in the table 5.4.

Cogeneration ratio	Average energy cost of heat [kWh/kWh]	Thermal request DHN [kWh]	Thermal request disconnected zones [kWh]	Configuration
0	0,904	33.404.515	41.867.509	Zones connected to DHN: 1, 6,13, 14, 18
0,10	0,827	33.404.515	41.867.509	Zones connected to DHN: 1, 6,13, 14, 18
0,40	0,577	67.337.612	7.934.412	All zones connected to DHN, except 5 ,12 and 21
0,70	0,415	75.272.024	-	All zones connected to DHN
0,80	0,394	75.272.024	-	All zones connected to DHN
0,90	0,381	75.272.024	-	All zones connected to DHN
1,00	0,378	75.272.024	-	All zones connected to DHN

Table 5.4 Summary of Energy based optimizations with COP 5 and varying the CHP ratio ( 20000 iterations)

#### Condensing boilers as alternative heating technology

In figure 5.8 the mean energetic cost of heat has been mapped considering the condensing boilers as the alternative technology for supplying heat to the non-connected users. The CHP ratio in the thermal power station is 50%. These costs are determined by using a deterministic approach for selecting the zones to be disconnected from the DHN.

The efficiency for the alternative technology of 83% refers to the mean value of the existing systems, while the value of 110% refers to the new condensing boiler. In both cases, the minimum energy cost is reached with all the users connected to the DHN ( 0.641 kWh/kWh)

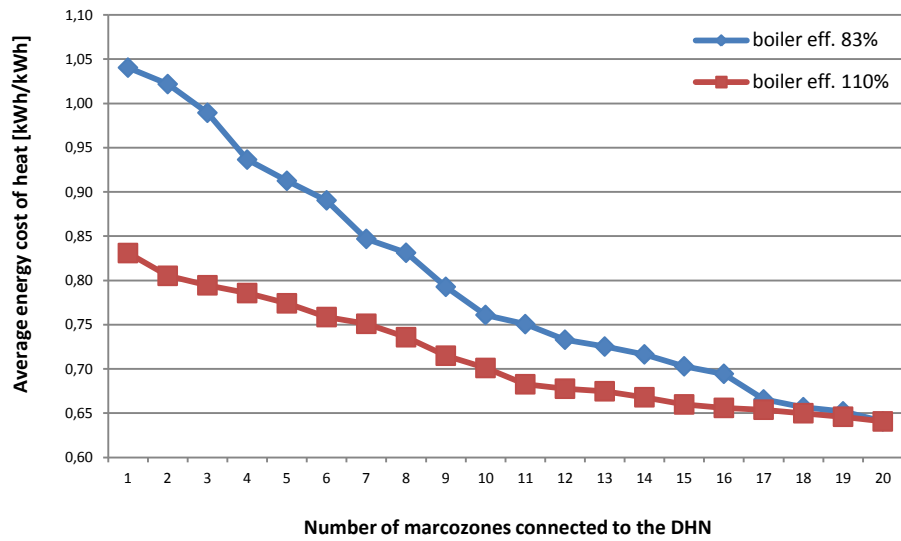

Figure 5.8 Average energy cost of heat of the energy system with DHN and cond. boilers

Moreover, same results are obtained by launching 1000 iterations, in which the selection procedure is based on the probabilistic approach. These results are reported in table 5.5.

CHP 50%	Average energy cost of heat [kWh/kWh]	Configuration
Existing boilers efficiency 83%	0.6406	All zones connected to the DHN
Condensing boilers efficiency 110 %	0.6406	All zones connected to the DHN

Table 5.5 The minimum of the average energy cost of heat with 1000 iterations, utilizing condensing boilers as the alternative technology

## 5.2 Case application with economic objective function

In this paragraph the results obtained from the optimization procedure considering the minimum economic cost for the whole energy system are reported. In figure 5.9 the average economic cost of heat supplied to the zones in the initial configuration (superstructure), with a cogeneration ratio of 50% installed at the thermal power station are presented.

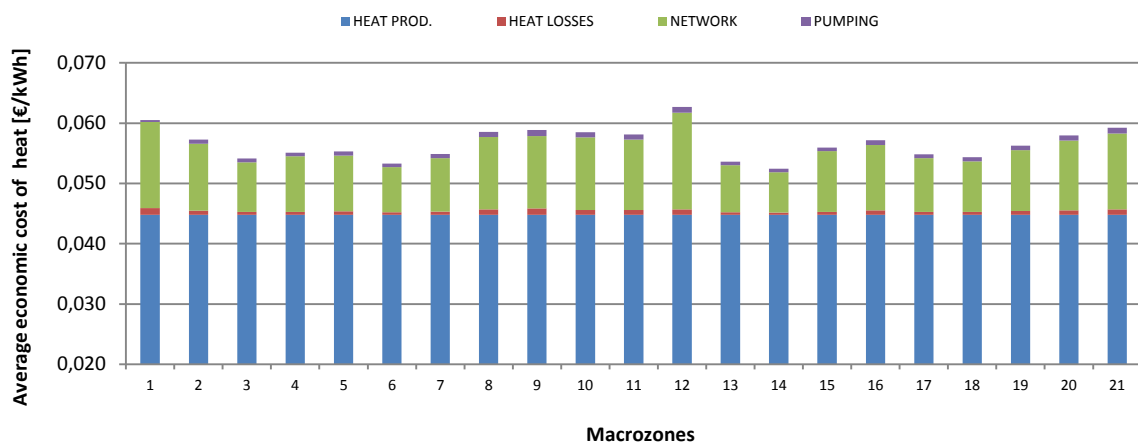

Figure 5.9 Average economic cost of heat supplied to the zones by DHN with a CHP ratio of 50%

As it can be seen from the graph, the zones with the highest costs are zones 12 and 21, mainly due to the fact that they are far away from the main thermal plant, and characterized with a small thermal request.

In fact the average cost due to the network construction of these zones are 0.016 €/kWh, while the average value for the network is about 0.010 €/kWh. Furthermore, the average pumping cost (0.0009 kWh/kWh) is higher than the average value of the network (0.0006 kWh/kWh).

Another zone with a high specific energy cost is the zone number 21. The average cost of the network construction (0.012 kWh/kWh) is higher than the average value of the network (0.010 €/kWh), and the average pumping cost (0.0009 €/kWh) is higher than the average value of the network (0.0006 €/kWh).

Several simulations of the energy based objective function have been performed. As mentioned in the previous case, two approaches has been adopted in order to select the zones to be disconnected from the DHN and supplied with an alternative heating technology: the deterministic approach and the probabilistic approach.

### Deterministic approach

In figure 5.10 the average economic costs of heat of the overall energy system, using a deterministic approach on selecting the zone to be disconnected from the DHN, have been mapped. These costs are referred to an energy system where the alternative



heating technology is GWHP. Different values of the coefficient of performance and cogeneration ratio have been considered.

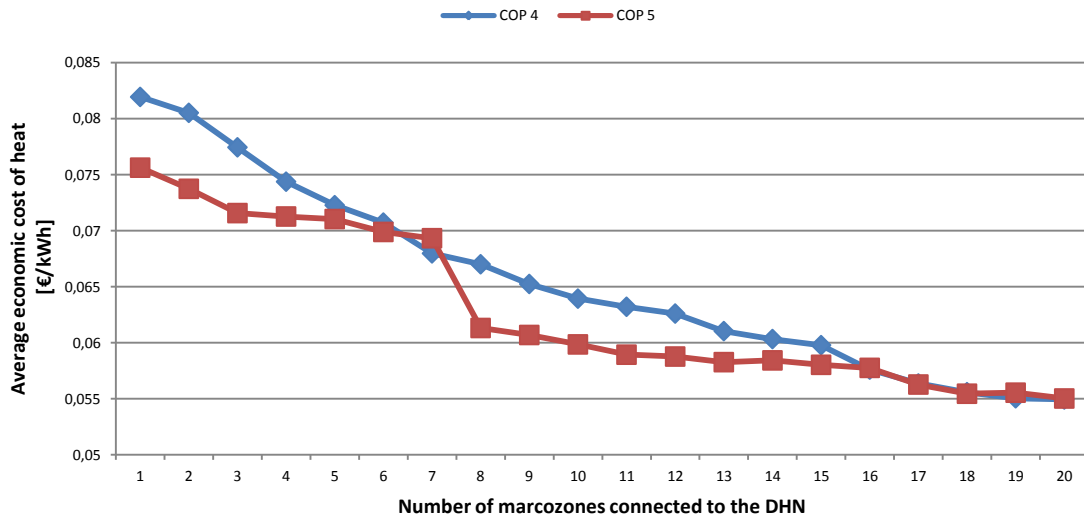

Figure 5.10 The average economic cost of heat of the energy system COP 4 and 5, CHP 40% Deterministic approach

In figure 5.11, the average economic cost of heat determined with different cogeneration ratios and a coefficient of performance of 5 are reported, where the selection procedure of disconnecting the zones from the DHN is based on deterministic approach. In general the average energy cost of heat increases as the zones are disconnected from the network, and supplied with the GWHP (i.e. the minimum value is reached with all the zones connected to the DHN).

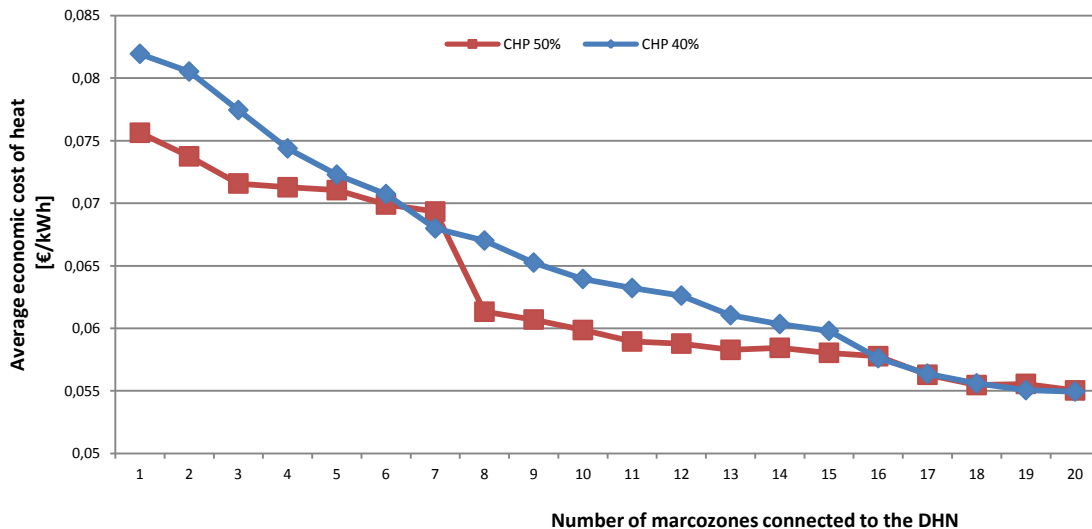

Figure 5.11 The average economic cost of heat of the energy system COP 5 and different CHP ratio – Deterministic approach

Probabilistic approach

As the procedure is iterative, several iterations have been launched in order to find the true optimum value. In figure 5.12 different iterations of the average energy cost

of heat of the overall energy system have been mapped (with a CHP 40% and a COP 4) obtained by using the deterministic and the probabilistic approach.

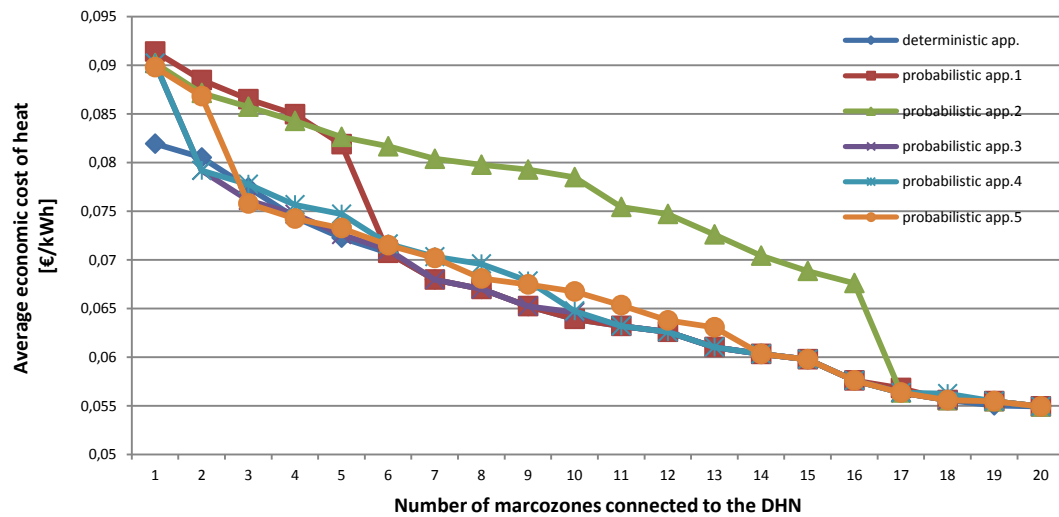

Figure 5.12 The average economic cost of heat of the energy system COP 4 and CHP 40%

In figure 5.13 the results obtained by launching 1000 iterations, with COP 4 and CHP 40% are reported. With heat pump efficiency of 4, the minimum average economic cost of heat (0.055 €/kWh) is reached with all the zones connected to the DHN (table 5.6)

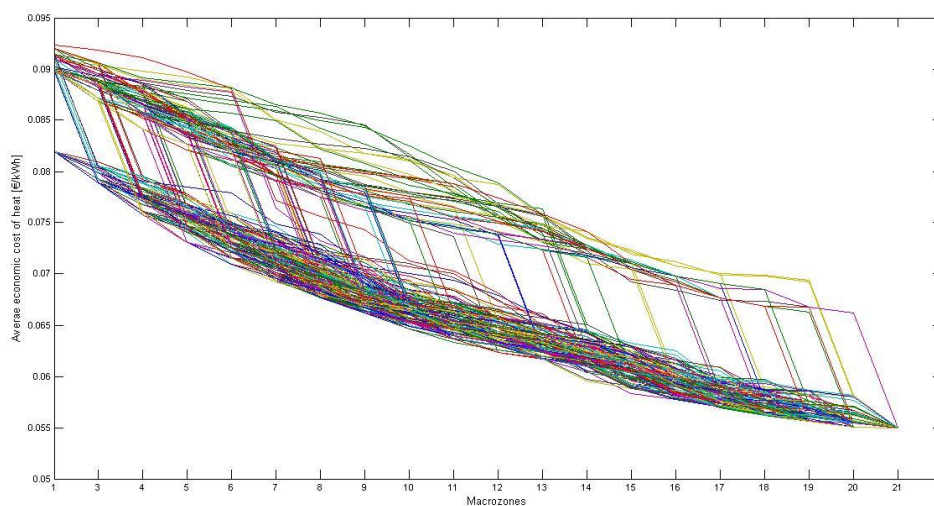

Figure 5.13 The average economic cost of heat of the energy system COP 4 and CHP 40%

Cogeneration ratio	Average energy cost of heat [kWh/kWh]	Thermal request DHN [kWh]	Thermal request disconnected zones [kWh]	configuration
0,400	0,055	75.272.024	-	All zones connected to DHN

Table 5.6 Summary of Economic based optimizations with COP 4 and CHP ratio 40% (1000 iterations)

Other simulations based on probabilistic criteria have been performed with a variable cogeneration ratio, where the COP is 4. The results from these simulations have been mapped in table 5.7.

The minimum average economic cost of heat increases as the cogeneration ratio increases. (e.g. CHP ratio 80% the minimum value of the economic cost is 0,059 €/kWh, while for a CHP of 40% this value is 0,055 €/kWh). In these cases all optima have the same configuration of the energy system (i.e. all the zones are connected to the DHN). This is due to a high total cost for the CHP appliances, mainly associated with the investment cost.

In the case of a cogeneration ratio lower than 40%, the minimum average economic cost of heat is reached with all the zones connected to the DHN, except the zones 12 and 21, which are the farthest from the thermal power plant.

Cogeneration ratio	Average energy cost of heat [kWh/kWh]	Thermal request DHN [kWh]	Thermal request disconnected zones [kWh]	configuration
0,1	0,072	39.477.028	35.794.996	Zones connected to DHN: 1,6, 13-15,17-18
0,2	0,060	63.105.605	12.166.418	All zones connected to DHN, except 5,12,16 and 21
0,3	0,057	68.897.204	6.374.820	All zones connected to DHN, except 12 and 21
0,4	0,055	75.272.024	-	All zones connected to DHN
0,5	0,055	75.272.024	-	All zones connected to DHN
0,7	0,057	75.272.024	-	All zones connected to DHN
0,8	0,059	75.272.024	-	All zones connected to DHN

Table 5.7 Summary of Economic based optimizations with COP 4 and different CHP ratio (1000 iterations)

Other simulations based on probabilistic criteria have been performed with a variable cogeneration ratio and the nominal COP of heat pumps equal to 5. The results from these simulations have been mapped in table 5.8.

The minimum average economic cost of heat increases as the cogeneration ratio increases (e.g. CHP ratio 80% the minimum value of the economic cost is 0,058 €/kWh, while for a CHP of 40% this value is 0,055 €/kWh). These cases are characterized by the same configuration of the energy system (i.e. all the zones are connected to the DHN, except for the zones 12 and 21, which are the farthest from the thermal power plant). This is due to the impact of the investment cost of the DHN necessary to reach these zones.

Cogeneration ratio	Average energy cost of heat [kWh/kWh]	Thermal request DHN [kWh]	Thermal request disconnected zones [kWh]	Configuration
0,2	0,0572	68.897.204,09	6.374.819,67	All zones connected to DHN, except 12 and 21
0,4	0,0547	68.897.204,09	6.374.819,67	All zones connected to DHN, except 12 and 21
0,5	0,0548	70.135.243,76	5.136.780,00	All zones connected to DHN, except 21
0,6	0,0555	68.897.204,09	6.374.819,67	All zones connected to DHN, except 12 and 21
0,8	0,0585	68.897.204,09	6.374.819,67	All zones connected to DHN, except 12 and 21
1,0	0,0628	68.897.204,09	6.374.819,67	All zones connected to DHN, except 12 and 21

Table 5.8 Summary of Economic based optimizations with COP 5 and different CHP ratio (1000 iterations)

#### Condensing boilers as alternative heating technology

In figure 5.14 the average economic cost of heat has been mapped, where the alternative technology for supplying heat to the users is condensing boiler and the CHP ratio in the thermal plant is 50%. These costs are determined by using a deterministic approach for selecting the zones to be disconnected from the DHN.

The efficiency of 83% of the alternative technology refers to the mean value of the boiler efficiency in the existing systems, while the 110% (with respect to LHV) refers to the condensing boiler efficiency. In both cases, the minimum energetic cost is reached with all the users connected to the DHN (0.0596 €/kWh)

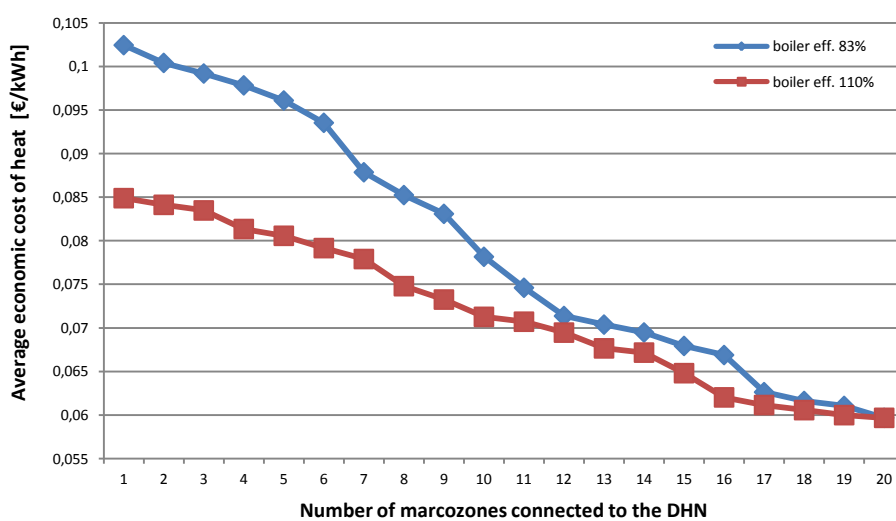

Figure 5.14 Average economic cost of heat of the energy system with DHN and cond. boilers – Deterministic approach

Moreover, same results are obtained by launching 1000 iterations, in which the selection procedure is based on the probabilistic approach. These results are reported in table 5.9.

CHP 50%	Minimum Economic cost [€/kWh]	Configuration
Existing boilers efficiency 83%	0.0596	All zones connected to the DHN
Condensing boilers efficiency 110 %	0.0596	All zones connected to the DHN

Table 5.9 Summary of economic optimization with CHP ratio 50% with 1000 iterations - Probabilistic approach

### 5.3 Case application with multi-objective function

In this paragraph the results obtained applying a multi-objective optimization are reported. This procedure has been implemented considering the minimum value of the average energy cost for of heat  $\bar{k}$  of the whole energy system as the objective function and constraining the average economic cost of heat  $\bar{c}_{ecp}$  supplied to the users. The value of the constrained variable  $\varepsilon$  (i.e. the average economic cost of heat) is chosen randomly within the interval  $[Lim_{inf}, Lim_{sup}]$ .

The multi-objective optimizations has been applied to energy system configurations comprising the DHN and Groundwater Heat Pumps as alternative heating technology. This is due to the fact that, for GWHP the two single objective functions are competing, i.e. the optimal configuration considering these two objective functions is, for various cases, different. In the case of condensing boilers as the alternative technology, the objective functions are not competing.

Furthermore, the cogeneration ratio produces , within a certain range, an opposite effect on the two objective functions, i.e. it make the primary energy cost decrease and the economic cost increase.

Two groups of simulations have been launched. The first group refers to an energy system comprising a district heating network and geothermal groundwater heat pumps with an efficiency of 4, while the second group with an efficiency of 5.

The lower limit  $Lim_{inf}$  refers to the value of the average economic cost of heat of the optimal configuration obtained by minimizing the economic objective function, while the superior limit  $Lim_{sup}$  is the value of the average economic cost of heat obtained in the optimal configuration of the energy based objective function.

#### Results of multi-objective function of the energy system with GWHP efficiency 4

The  $Min f_1(x)$  is represented by the value of the average energy cost of heat in the configuration corresponding with the minimum primary energy cost, where the cogeneration ratio is 100%. While the  $Min f_2(x)$  is represented by the value of the average economic cost of heat in the optimal configuration corresponding with minimum economic cost, where the cogeneration ratio is 40%. These results, mapped in table 5.10, are obtained by launching 1000 iterations.

Cogeneration ratio	Minimum	Average energy cost [kWh/kWh]	Average Economic cost [€/kWh]
100%	Minimum energy based obj. function	0,378	0,064
40%	Minimum economic based obj. function	0,581	0,055

Table 5.10 The optimal configuration by performing the single obj. functions

In table 5.11 the results obtained by performing multi-objective optimization of the energy system characterized by an efficiency of heat pumps of 4 and a variable cogeneration ratio are reported. In figure 5.15. the Pareto front obtained mapping the optimal points is presented.

Cogeneration ratio [%]	Min average energy cost [kWh/kWh]	Average Economic cost [€/kWh]	Thermal request DHN [kWh]	Thermal request disconnected zones	Max average economic cost	Configuration with min Economic cost
70%	0,415	0,057	75.272.024	-	0,063	all zones connected to DHN
70%	0,415	0,057	75.272.024	-	0,064	all zones connected to DHN
20%	0,799	0,058	68.897.204	6.374.820	0,058	all zones connected, except 12 and 21
30%	0,682	0,057	68.897.204	6.374.820	0,059	all zones connected, except 12 and 21
30%	0,682	0,057	68.897.204	6.374.820	0,057	all zones connected, except 12 and 21
60%	0,452	0,056	75.272.024	-	0,056	all zones connected to DHN
40%	0,581	0,055	75.272.024	-	0,061	all zones connected to DHN
91%	0,380	0,062	75.272.024	-	0,062	all zones connected to DHN
50%	0,507	0,055	75.272.024	-	0,060	all zones connected to DHN
45%	0,542	0,055	75.272.024	-	0,060	all zones connected to DHN
90%	0,381	0,061	75.272.024	-	0,063	all zones connected to DHN
63%	0,441	0,056	75.272.024	-	0,061	all zones connected to DHN
42%	0,564	0,055	75.272.024	-	0,057	all zones connected to DHN
33%	0,649	0,056	74.033.984	1.238.040	0,061	all zones connected, except 12
83%	0,389	0,060	75.272.024	-	0,062	all zones connected to DHN
56%	0,467	0,055	75.272.024	-	0,062	all zones connected to DHN
40%	0,581	0,055	75.272.024	-	0,058	all zones connected to DHN
65%	0,434	0,056	75.272.024	-	0,062	all zones connected to DHN
11%	0,917	0,063	62.492.694	12.779.330	0,063	all zones connected, except 5,12,16,19
100%	0,378	0,064	75.272.024	-	-	all zones connected to DHN

Table 5.11 Summary of Multiobjective optimizations with COP 4

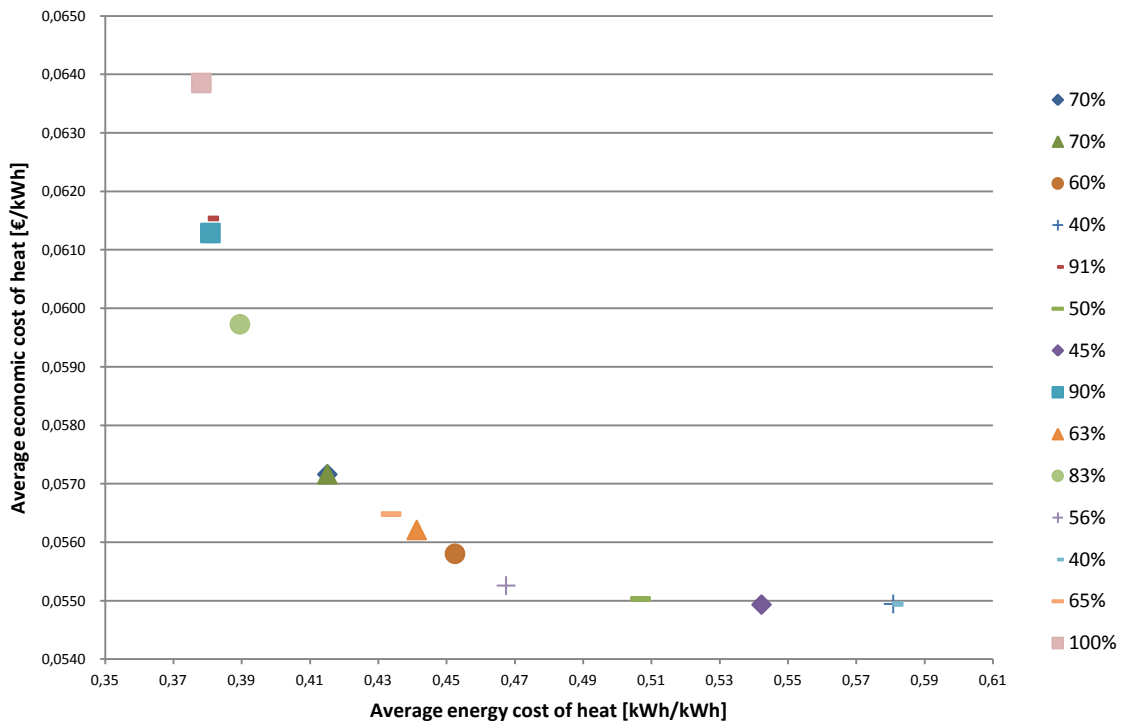

Figure 5.15 The Pareto front of the multi-objective optimizations - COP 4

### Results of multi-objective function of the energy system with GWHP efficiency 5

The  $Min f_1(x)$  is represented by the value of the average energy cost of heat in the optimal configuration corresponding with minimum energy cost, where the cogeneration ratio is 100%. While the  $Min f_2(x)$  is represented by the value of the average economic cost of heat in the optimal configuration corresponding with the minimum economic cost, where the cogeneration ratio is 40%. These results mapped in table 5.12, are obtained by launching 1000 iterations for each case.

Cogeneration ratio	Minimum	Average energy cost [kWh/kWh]	Average Economic cost [€/kWh]
100%	Minimum energy based obj. function	0,378	0,064
40%	Minimum economic based obj. function	0,577	0,055

Table 5.12 The optimal configuration by performing the single obj. Functions COP 5

In table 5.13 the results obtained by performing multi-objective optimization of the energy system considering an efficiency of heat pumps of 5 and variable cogeneration ratio are reported.



Cogeneration ratio [%]	Min average energy cost [kWh/kWh]	Average Economic cost [€/kWh]	Thermal request DHN [kWh]	Thermal request disconnected zones	Max average economic cost	Configuration with min Economic cost
10%	0,897	0,060	61.587.920	13.684.103	0,060	all zones connected, except 5, 12,19 and 21
10%	0,897	0,060	61.587.920	13.684.103	0,060	all zones connected, except 5, 12,19 and 21
20%	0,770	0,058	61.587.920	13.684.103	0,059	all zones connected, except 5, 12,19 and 21
20%	0,758	0,063	39.477.028	35.794.996	0,063	all zones connected, except 5, 12,19 and 21
20%	0,758	0,063	39.477.028	35.794.996	0,063	all zones connected, except 5, 12,19 and 21
20%	0,758	0,063	39.477.028	35.794.996	0,063	all zones connected, except 5, 12,19 and 21
20%	0,758	0,063	39.477.028	35.794.996	0,063	all zones connected, except 5, 12,19 and 21
30%	0,665	0,056	61.587.920	13.684.103	0,060	all zones connected, except 5, 12,19 and 21
30%	0,665	0,057	60.226.784	15.045.240	0,060	all zones connected, except 4,5, 12,19 and 21
30%	0,665	0,057	60.226.784	15.045.240	0,060	all zones connected, except 4,5, 12,19 and 21
30%	0,665	0,056	63.105.605	12.166.418	0,064	all zones connected, except 5, 12,16 and 21
40%	0,577	0,055	67.337.612	7.934.412	0,059	all zones connected, except 5, 12 and 21
40%	0,577	0,055	67.337.612	7.934.412	0,057	all zones connected, except 5, 12 and 21
40%	0,577	0,055	67.337.612	7.934.412	0,061	all zones connected, except 5, 12 and 21
40%	0,577	0,055	67.337.612	7.934.412	0,062	all zones connected, except 5, 12 and 21
40%	0,577	0,055	67.337.612	7.934.412	0,062	all zones connected, except 5, 12 and 21
50%	0,506	0,055	74.033.984	1.238.040	0,056	all zones connected, except 12
60%	0,452	0,056	75.272.024	-	0,058	all zones connected to DHN
60%	0,452	0,056	75.272.024	-	0,063	all zones connected to DHN
60%	0,452	0,056	75.272.024	-	0,060	all zones connected to DHN
60%	0,452	0,056	75.272.024	-	0,060	all zones connected to DHN
60%	0,452	0,056	75.272.024	-	0,058	all zones connected to DHN

60%	0,452	0,056	75.272.024	-	0,063	all zones connected to DHN
60%	0,452	0,056	75.272.024	-	0,056	all zones connected to DHN
70%	0,415	0,057	75.272.024	-	0,058	all zones connected to DHN
80%	0,394	0,059	75.272.024	-	0,062	all zones connected to DHN
90%	0,391	0,061	70.135.244	5.136.780	0,061	all zones connected, except 21
90%	0,381	0,061	75.272.024	-	0,062	all zones connected to DHN
90%	0,381	0,061	75.272.024	-	0,062	all zones connected to DHN
59%	0,456	0,056	75.272.024	-	0,057	all zones connected to DHN
57%	0,464	0,055	75.272.024	-	0,060	all zones connected to DHN
83%	0,389	0,060	75.272.024	-	0,064	all zones connected to DHN
36%	0,612	0,055	68.897.204	6.374.820	0,062	all zones connected, except 12 and 21
58%	0,460	0,056	75.272.024	-	0,062	all zones connected to DHN
27%	0,696	0,057	61.684.223	13.587.801	0,062	all zones connected, except 3-5,12,21
55%	0,471	0,055	75.272.024	-	0,059	all zones connected to DHN
31%	0,659	0,056	67.337.612	7.934.412	0,061	all zones connected, except 5,12,21
57%	0,464	0,055	75.272.024	-	0,061	all zones connected to DHN
3%	0,962	0,063	54.140.001	21.132.023	0,063	all zones connected, except 4, 5, 8,9,12,16,19,21
39%	0,585	0,055	68.897.204	6.374.820	0,055	all zones connected, except 12 and 21
100%	0,378	0,064	75.272.023	-	-	all zones connected to DHN

Table 5.13 Summary of results obtained with multi-objective optimization - COP 5

While in figure 5.16 are presented the Pareto optimal point, representing the alternative process designs, each achieving a unique combination of the objectives

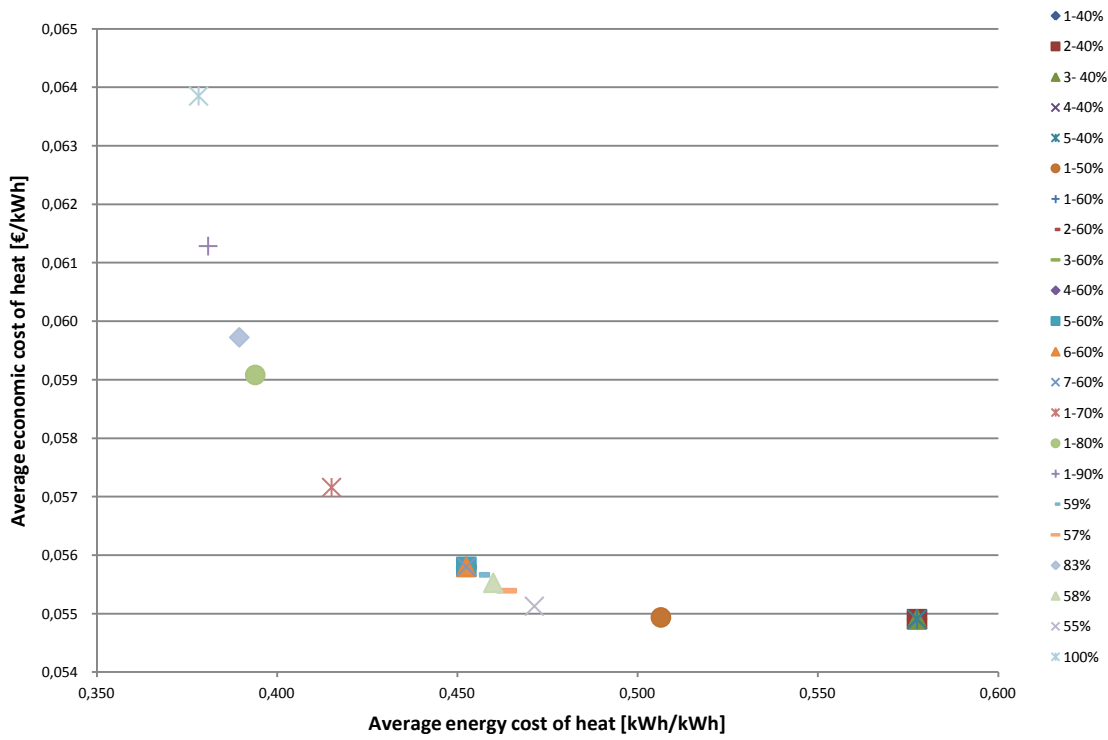

Figure 5.16 The Pareto front of the multi-objective optimizations - COP 5

---

# 6

## Conclusions

The aim of the research developed in this Ph.D. Thesis is to propose a reliable procedure for the synthesis, design and operation optimization of a DHN, focusing on energetic and economic results.

A unique rigorous tool for optimal planning of the district energy systems, using a simulating annealing technique has been proposed. The main features of the procedure are:

- cost calculation through exergoeconomics: the energy and economic optimization of a district energy system are conducted using a thermoeconomic procedure
- probabilistic approach for the simplification of the network structure, with the same framework of the physical model of the DHN;
- a multi-objective optimization of the network.

The procedure is applied to a district energy system, comprising a district heating network and Groundwater heat pumps or condensing boilers are considered as the possible alternative systems to supply heat to the users not connected to the DHN.

Multiobjective optimization technique allows the determination of the best solutions for single objective energy system analysis and gives the possibility to obtain also compromise solutions which try to minimize at the same time different objective functions.

In this case study, the economic and energetic objective functions were considered as single objective functions, and a single solution which minimized both of them could not be identified. The analysis of the Pareto Frontiers obtained using the  $\epsilon$  constrained method allowed the identification of the best compromise solutions, in the different cases analyzed.

The analyses shows that energy performances of the alternative heating technologies the possible thermal interferences between heat pumps ,and the cogeneration ratio of thermal power plant play a crucial role in the optimal configuration.

---

In conclusion, the strengths of the proposed method can be summarized as below:

- The application of Thermoeconomics theory, which takes into account the technical considerations integrated with the economic aspects, in order to define criteria for the network design, and determine the costs of the service provided to every user, depending on their thermal request (heating load and temperature) and on the geometric characteristic of the path;
- The optimization, using an approach derived from Simulating Annealing, has been performed by solving the fluid-dynamic, thermal and thermoeconomic problems for the whole network. Therefore the optimization algorithm is blind, as it would occur in the case of mathematical programming;
- The same structure (through incidence matrix), used for the thermo-fluid-dynamic simulation of the physical-economical properties of the network, has been used for the calculation of the probabilities of the users to be disconnected.
- This approach is preferred, being able to give a physical perception of the expansion of network.

The proposed methodology is very flexible, and besides allowing the optimization of the system, can be also used for sensitivity analysis varying investment and energy costs in order to evaluate different heating technologies for the optimal solution.

---

# Bibliography

IEA Implementing Agreement on District Heating and Cooling, including the integration of CHP , ANNEX VIII, 2008

Rezaie B., Rosen MA. District heating and cooling: Review of technology and potential enhancement.,.1016/j.apenergy.2011.04.020)

Lund JW. (June 2007), "Characteristics, Development and utilization of geothermal resources", Geo-Heat Centre Quarterly Bulletin (Klamath Falls, Oregon: Oregon Institute of Technology) 28 (2): 1–9, ISSN 0276-1084

Marinova M., Beaudry C., Taoussi A., Trepanier M., Paris J. Economic assessment of rural district heating by bio-steam supplied by a paper mill in Canada. Bull Sci, Technol Soc 2008; 28(2):159–73

Magnusson D, Swedish district heating—A system in stagnation: Current and future trends in the district heating sector. Energy Policy, Volume 48, September 2012, Pages 449–459, <http://dx.doi.org/10.1016/j.enpol.2012.05.047>

Bottio L.F., Urban Cogeneration Combined with District Heating: Is it Still a Valid Solution for Italy? Applied Energy 36 (1990) 85-88

Il riscaldamento urbano. Annuario 2010 ISSN 1972-6953

Lund H., B. Möller, B.V. Mathiesen, A. Dyrelund, The role of district heating in future renewable energy systems. Energy 35 (2010) 1381–1390

Thyholt M, Hestnes AG. Heat supply to low-energy buildings in district heating areas: analyses of CO2 emissions and electricity supply security. Energy and Buildings 2008;40(2):131–9.

Lund JW. Geothermal tapping focus: tapping the earth's natural heat. Refocus 2006; 7:48-51

Lund JW, Derek H. Freeston, Tonya L. Boyd, Direct utilization of geothermal energy 2010 worldwide review . Geothermics Volume 40, Issue 3, September 2011, Pages 159–180

Ostergaard PA., Lund H., A renewable energy system in Frederikshavn using low-temperature geothermal energy for district heating. Applied Energy 88 (2011) 479–487,

Connolly, Mathiesen, Möller, Nielsen, Østergaard, Lund, Persson, Nilsson, Werner, Trier. Heat Roadmap Europe 2050. Euroheat and Power. Available at <http://www.euroheat.org>.

EGEC, Deep Geothermal Market Report. December 2011. Available at <http://egec.info/egec-deep-geothermal-market-report-2011/>

Bauer D., R. Marx, J. Nußbicker-Lux, F. Ochs, W. Heidemann, H. Müller-Steinhagen, German central solar heating plants with seasonal heat storage. Solar Energy 84 (2010) 612–623

Guadalfajara M., Lozano M.A., Serra Luis M. Evaluation of the Potential of Large Solar Heating Plants in Spain, Energy Procedia Volume 30, 2012, Pages 839–848 .1st International Conference on Solar Heating and Cooling for Buildings and Industry (SHC 2012)

Rakos C., Chapter 4—'Dissemination of Biomass District Heating Systems in Austria: Lessons Learned, Bioenergy - Realizing the Potential 2005, Pages 47–57

---

Difs K., Wetterlund E., Trygg L., Söderström M., Biomass gasification opportunities in a district heating system

Vallios I., Tsoutsos T, Papadakis G., Design of biomass district heating systems, *Biomass and Bioenergy* 33 (2009) 659 -678

Eriksson O., Finnveden G., Ekvall T, Björklund A. Life cycle assessment of fuels for district heating: A comparison of waste incineration, biomass- and natural gas combustion. *Energy Policy* Volume 35, Issue 2, February 2007, Pages 1346–1362

Mathiesen B.V., Lund H., Connolly D. Limiting biomass consumption for heating in 100% renewable energy systems. *Energy*, Volume 48, Issue 1, December 2012, Pages 160–168

Rosen M.A, Minh N. Le, Ibrahim Dincer. Efficiency analysis of a cogeneration and district energy system. *Applied Thermal Engineering* . Volume 25, Issue 1, January 2005. Pages 147-159.

Gustafsson J., Jerker Delsing, Jan van Deventer. Improved district heating substation efficiency with a new control strategy. *Applied Energy*, Volume 87, Issue 6, June 2010, Pages 1996–2004

Chinese D., Meneghetti A., Optimisation models for decision support in the development for biomass-based industrial district-heating networks in Italy. *Applied Energy* 82(2005) 228-254

European Commission. *Energy Roadmap 2050*. European Commission, 2011. <http://eurlex.europa.eu/LexUriServ>

Werner S. District heating and Cooling. *Encyclopedia of Energy 2004*: 841-848.

Ajah N.A , Patil A.C, Herder P.M, Grievink J. Integrated conceptual design of a robust and reliable waste-heat district heating system. *Applied Thermal Engineering* 27 (2007) 1158–1164

Grohnheit P.E., B.O.G. Mortensen. Competition in the market for space heating. District heating as the infrastructure for competition among fuels and technologies. *Energy Policy*, 31 (2003), pp. 817–826

Holmgren K., Role of a district-heating network as a user of waste-heat supply from various sources – the case of Göteborg. *Applied Energy* 83 (2006) 1351–1367

Persson U., Werner S., District heating in sequential energy supply. *Applied Energy* 95 (2012) 123–131

Kapil A., I. Bulatov, R. Smith, J.K. Kim. Process integration of low grade heat in process industry with district heating networks. *Energy* 44 (2012) 11-19

Bruelisauer M., Wiltshire R., A New Future for District Energy Systems. *The Future for Sustainable Built Environments with High Performance Energy Systems*. 19-21 October 2010. Fraunhofer Institute for Building Physics (IBP) pg . 46-53.

Verda V. Kona A., Thermoeconomics as a Tools for the Design and Analysis of Energy Savings Initiatives in Buildings Connected to District Heating Networks. *International Journal of Thermodynamics (IJOT)*. ISSN 1301-9724 / e-ISSN 2146-1511. Vol 15(no.4), pp. 221-229, 2012 DOI 10.5541/ijot.422.

Schmidt R.R., Pol O., Basciotti D., Page J., Smart thermal networks for smart cities – Introduction of concepts and measures. *EPJ Web of Conferences* 33, 04002 (2012) DOI: 10.1051/epjconf/20123304002

---

Frangopoulos C.A., Von Spakovsky M.R, E. Sciubba., A Brief Review of Methods for the design and Synthesis Optimization of Energy Systems. *The International Journal of Applied Thermodynamics*. Vol.5, No. 4. Pp 151-160. (2002).

Frangopoulos C.A., Dimopoulos G.G., Effect of reliability Considerations on the Optimal Synthesis, Design and Operation of a Cogeneration System. *Energy*, 29, pp. 309-329. (2004).

Rancruel D., M.R. von Spakovsky., Investigation of the Control Strategy Development using an Integrated Model of a SOFC based APU under Transient Conditions. ASME Paper IMECE2004-62374. (2004).

Li M., F. Maréchal, M. Burer, D. Favrat., Multi-criteria Optimization of an Advanced Combined Cycle Power Plant Including CO<sub>2</sub> Separation Options. *Proceedings of ECOS 04, Guanajuato, Mexico*. (2004).

Verda V., Ciano C., Procedures for the search of the optimal configuration of district heating networks, *International Journal of Applied Thermodynamics*, 2005, vol8, pg 143-154. ISSN 1301-9724 .

Bejan A., G. Tsatsaronis, M. Moran (1996). *Thermal design and Optimization*. Wiley. New York.

Schwefel H.P. (1994). *Evolution and Optimum Seeking*. Wiley. New York.

Torres C.C, Valero A. C., *Thermoeconomics*, PhD course. Center of Research for Energy Resources and Consumption University of Zaragoza. Spain

Tribus M. (1956). *Thermodynamic and Economic Considerations in the preparation of fresh water from sea Water*. Department of Engineering report No. 56-16, University of California at Los Angeles.

Tribus M., Evans R.B. (1962). *A contribution to the Theory of Thermoconomics*, UCLA Report n. 62-36.

Gaggioli R.A. (1999). *Reflections on the History and Future of Exergy*. ECOS99. *Proceedings of international Symposium on Efficiency, costs, optimization and simulation of energy systems*. Tokyo, Japan, pp.5-13.

Weber C., Shah N. Optimisation based design of a district energy system for an eco-town in the United Kingdom. *Energy* 36 (2011), pp 1292-1308.

Möller B, Lund H. Conversion of individual natural gas to district heating: Geographical studies of supply costs and consequences for the Danish energy system. *Applied Energy* 87 (2010).pp 1846–1857

Fruergaard T., T.H. Christensen, T. Astrup. Energy recovery from waste incineration: assessing the importance of district heating networks. *Waste Manage*, 30 (2009), pp. 1264–1272

Verda V., Colella F. Primary energy savings through thermal storage in district heating networks. *Energy* 36 (2011), pp 4278-4286

Verda V., Colella Numerical analysis of a medium scale latent energy storage unit for district heating systems. *Energy* 45 (2012),pp 397–406

Verda V. Fausone S. Exergoeconomic analysis of district heating systems. *Proceedings of ASME 3rd International Conference on Energy Sustainability San Francisco, California, July 19-23, 2009*.

Zinko, H., Bohm, B., Kristjansson, H., Ottosson, U., Rama, Miika & Sipila, K. 2008. *District heating distribution in areas with low heat demand density*. IEA DHC Annex VIII. International Energy Agency.



---

Verda V., Kona A., Thermoconomics as a Tool for the Design and Analysis of Energy Savings Initiatives in Buildings Connected to District Heating Networks. *International Journal of Thermodynamics*. Vol. 15 (No. 4), pp. 221-229, 2012. Sept. 24, 2012. doi: 10.5541/ijot.422.

Verda V., Kona A., Thermo-economic approach for the analysis of low temperature district heating systems. *Proceedings of the 25th International Conference on Efficiency, Cost, Optimization, Simulation and Environmental Impact of Energy Systems*, by Firenze University Press. ISBN 978-88-6655-322-9. Perugia (Italy) 26-29 June 2012 .

Dalla Rosa A., J.E. Christensen (2011). Low-energy district heating in energy-efficient building areas. *Energy* 36: 6890-6899

Wiltshire R, Low temperature district energy systems. 16th,, Building Services, Mechanical and Building Industry Days". International conference, 14-15 october 2011, Debrecen, Hungary

2004/08/EC European Directive

Westner G, Madlener. R., The impact of modified EU ETS allocation principles on the economics of CHP based district heating systems., *Journal of Cleaner Production*, Volume 20, Issue 1, January 2012, Pages 47–60

Ozgener L., Hepbasli A., Dincer I., A key review on performance improvement aspects of geothermal district heating systems and applications. *Renewable and Sustainable Energy Reviews*, Vol 11, Issue 8, October 2007, Pages 1675-1697

Moran M.J., H.N. Shapiro, *Fundamentals of Engineering Thermodynamics*, 3rd edition, John Wiley & Sons, New York, USA, 1998.

Serra LM, MA Lozano, A Valero, and C Torres. On average and marginal costs in thermoconomics. In *ECOS 1995*, 1995.

Henning D. Modest-An energy system optimisation model applicable to local utilities and countries. *Energy* Vol. 22, No. 12, pp. 1135-1150, 1997

Curti V., Favrat D., von Spakovsky M.R. An environomic approach for the modelling and optimization of a district heating network based on centralized and decentralized heat pumps, cogeneration and/or gas furnace. Part I: Methodology. *International Journal of Thermal Science* (2000) 39, 721–730.

Curti V., Favrat D., von Spakovsky M.R. An environomic approach for the modelling and optimization of a district heating network based on centralized and decentralized heat pumps, cogeneration and/or gas furnace. Part II: Application. *International Journal of Thermal Science* (2000) 39, 731–741.

Alarcon-Rodriguez, Ault G, Galloway S. Multi-objective planning of distributed energy sources. A review of the state of the art. *Renewable and Sustainable Energy Reviews*. Volume 14, Issue 5, June 2010, Pages 1353–1366

YY Jing, H Bai, and JJ Wang. Multi-objective optimization design and operation strategy analysis of BHP system based on life cycle assessment. *Energy*, 37(1):405-416, January 2012.

H Ren, W Zhou, K Nakagami, W Gao, and Q Wu. Multi-objective optimization for the operation of distributed energy systems considering economic and environmental aspects. *Applied Energy*, 87(12):3642-3651, December 2010.

---

Fazlollahi S. and F Marechal. Multi-objective, multi-period optimization of biomass conversion technologies using evolutionary algorithms and mixed integer linear programming (MILP). *Applied Thermal Engineering*, pages 1-10, November 2011.

Abdollahi G. and M Meratizaman. Multi-objective approach in thermo environomic optimization of a small-scale distributed CCHP system with risk analysis. *Energy and Buildings*, 43(11):3144-3153, November 2011.

Tripodi C. Teleriscaldamento verso Smart Grid : L'evoluzione de sistema di teleriscaldamento torinese con il progetto Torino Nord Est. Torino-Lingotto Fiere , 25 Maggio 2012.

Verda V., Guelpa E., Kona A., Lo Russo S. Reduction of primary Energy needs in urban areas through optimal planning of district heating and heat pump installations. ...2012

Verda V., Baccino G., Sciacovelli A., Lo Russo S., Impact of district heating and groundwater heat pump systems on the primary energy needs in urban areas. , *Applied Thermal engineering* (2012), doi: 10.1016/j.applthermaleng.2012.01.047

R. A. Gaggioli, W. J. Wepfer, *Exergy Economics, Energy*, Vol. 5, pp. 823-837 (1980).

Y.M. El Sayed (2003). *The Thermoconomics of Energy Conversions*. Elsevier.

F. Harary, *Graph Theory*, Narosa Publishing House, New Delhi (1995).

G. Tsatsaronis, M. Winhold, *Exergoeconomic Analysis and Evaluation of energy-conversion. Plants – I. A new general Theory. Energy*, Vol.10. N.1, pp. 69-80 (1985).