

Performance of Modal Signaling vs. medium dielectric variability

Original

Performance of Modal Signaling vs. medium dielectric variability / Manfredi, Paolo; Stievano, IGOR SIMONE; Canavero, Flavio. - STAMPA. - (2012), pp. 81-84. (Intervento presentato al convegno 2012 IEEE 16th Workshop on Signal and Power Integrity (SPI) tenutosi a Sorrento (I) nel May 13-16, 2012) [10.1109/SaPIW.2012.6222916].

Availability:

This version is available at: 11583/2497881 since:

Publisher:

Piscataway, N.J. : IEEE

Published

DOI:10.1109/SaPIW.2012.6222916

Terms of use:

This article is made available under terms and conditions as specified in the corresponding bibliographic description in the repository

Publisher copyright

(Article begins on next page)

Performance of Modal Signaling vs. Medium Dielectric Variability

Paolo Manfredi, Igor S. Stievano, Flavio G. Canavero
 Dipartimento di Elettronica e Telecomunicazioni, Politecnico di Torino
 Corso Duca degli Abruzzi 24, 10129 Torino (Italy)
 E-mail: paolo.manfredi@polito.it, Phone: +39-011-0904187

Abstract

This paper addresses the feasibility of the so-called Modal Signaling (MS) transmission scheme from a stochastic viewpoint. MS has been proposed for crosstalk mitigation over interconnects and is based on the encoding of signals onto fundamental transmission-line modes. However, the design of drivers and receivers strongly depends on the physical characteristics of the channel. In this paper, the impact of random variations of these properties on MS effectiveness is efficiently analyzed by means of Polynomial Chaos (PC) technique.

Introduction

The increasing demand for data throughput in high-speed PCB links makes electromagnetic coupling between adjacent traces the dominant noise source. High-density microstrip configurations are often employed, and the induced crosstalk considerably limits the system performance. In order to mitigate the impact of such coupling, a signaling scheme called Modal Signaling (MS) has been proposed in literature [1, 2]. This scheme encodes input signals onto fundamental transmission-line modes thus diagonalizing the channel. In fact, since the modes are decoupled, the transmission is theoretically free of crosstalk. However, the design of transmitters and receivers strongly depends on the physical characteristics of the channel. As such, random fluctuations of these properties among different fabricated devices may be detrimental for this technique.

Concerning the simulation of interconnects affected by variability, the authors of this contribution have recently proposed a stochastic model for multiconductor transmission lines (MTLs) that inherently includes any possible randomness in the line cross-section [3]. This methodology is based on the so-called Polynomial Chaos (PC) technique [4] and has been successfully applied, for instance, to the analysis of the performance of emerging nano-technologies [5]. In this framework, PC allows to efficiently overcome the limitations of standard and well-known tools that are typically employed to handle variability, such as Monte Carlo (MC) method, which requires a large number of samples (i.e., system solutions) to achieve convergence.

In this paper, we intend to exploit PC to analyze the feasibility of MS from a stochastic point of view, i.e., by taking into account the effects of random variations that may occur in the material parameters, thus preventing MS from working in ideal conditions. Comparisons with MC results confirm the strength and flexibility of the proposed technique.

Modal Signaling Overview

The transmission scheme for MS is depicted in Fig. 1 [1]. The underlying idea consists in feeding the interconnect modes rather than its physical conductors. As we know from transmission-line theory, the propagation along a MTL with N

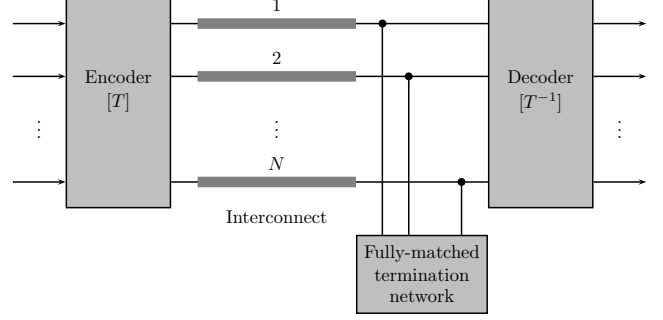

Figure 1: Unidirectional modal signaling block diagram of a N -line channel.

signal conductors can be described by mapping the physical electrical variables onto N equivalent uncoupled modal lines and carrying out propagation using the well-known results for single lines [6]:

$$\frac{d}{dz} \mathbf{V}_m(z, s) = -s \mathbf{T}_V^{-1} \mathbf{L} \mathbf{T}_I \mathbf{I}_m(z, s) \quad (1a)$$

$$\frac{d}{dz} \mathbf{I}_m(z, s) = -s \mathbf{T}_I^{-1} \mathbf{C} \mathbf{T}_V \mathbf{V}_m(z, s), \quad (1b)$$

where s is the Laplace variable and z is the longitudinal coordinate. \mathbf{V}_m and \mathbf{I}_m are the modal voltages and currents, which are related to the physical ones as follows:

$$\mathbf{V}(z, s) = \mathbf{T}_V \mathbf{V}_m(z, s) \quad (2a)$$

$$\mathbf{I}(z, s) = \mathbf{T}_I \mathbf{I}_m(z, s). \quad (2b)$$

Matrices \mathbf{T}_V and \mathbf{T}_I define two *similarity transformation* and diagonalize the per-unit-length (p.u.l.) matrices \mathbf{L} and \mathbf{C} . Therefore, (1) is diagonal and each line can be treated independently as a single-conductor one.

Normally, to transmit a signal over a multiconductor transmission line, one would excite one of the physical conductors. However, due to the inversion of (2), all modal quantities are in general non-zero. As a result, several modes propagate with different velocities, and their recombination at the receivers gives raise to crosstalk.

With MS, input sources are encoded so that only one mode is actually excited. This can be easily achieved by applying the same mapping (2) to the inputs. For instance, if we denote the uncoded and encoded voltage signals as \mathbf{V}_S and \mathbf{V}_E , respectively, at the beginning of the line (section $z = 0$) we have

$$\mathbf{V}_m(z = 0) = \mathbf{T}_V^{-1} \mathbf{V}_E = \mathbf{T}_V^{-1} \mathbf{T}_V \mathbf{V}_S = \mathbf{V}_S. \quad (3)$$

Hence, if \mathbf{V}_S has only one non-zero entry, this holds also for the modal voltages \mathbf{V}_m .

Therefore, we can state that the traditional transmission scheme, in which an electric signal is directly sent into the corresponding conductor, excites one physical conductor and N modes. On the contrary, MS excites N physical conductors but just one single mode [2].

Furthermore, reflections must also be eliminated and a proper termination network, ideally realizing complete matching for the line, is required. This means that the far-end termination impedance matrix \mathbf{Z}_L should be equal to the characteristic impedance of the MTL, i.e.,

$$\mathbf{Z}_L = \mathbf{Z}_C = \mathbf{T}_V \mathbf{Z}_{C_m} \mathbf{T}_I^{-1}, \quad (4)$$

where \mathbf{Z}_{C_m} is the diagonal characteristic matrix for the uncoupled lines [6].

Finally, inverse of mapping (2) must be applied at the receiver in order to retrieve the modal voltage, which now propagates alone and mimics the input voltage \mathbf{V}_S . Therefore, if we denote with \mathbf{V}_D and \mathbf{V}_L the voltage at the decoder and at the final output, respectively, we have

$$\mathbf{V}_L = \mathbf{T}_V^{-1} \mathbf{V}_D = \mathbf{T}_V^{-1} \mathbf{T}_V \mathbf{V}_m(z = \mathcal{L}) = \mathbf{V}_m(z = \mathcal{L}), \quad (5)$$

where section $z = \mathcal{L}$ indicates the far-end termination, being \mathcal{L} the interconnect length.

It should be noted that the inclusion of losses would imply a frequency dependence for transformation matrices and, consequently, for encoders and decoders. For the sake of simplicity, losses will be neglected in the feasibility analysis presented in this paper.

Polynomial Chaos Model for Stochastic Interconnects

From the MS overview, it is evident that such a technique can be successful only if there is good correspondence between the transformation map in the encoder/decoder, the termination network and the actual interconnect properties. Hence, the design of such encoders (and corresponding decoders) is unavoidably tied to a precise, deterministic description of the line geometry. Nevertheless, these parameters are unavoidably affected by some uncertainties, that may arise from slight variations of the substrate materials due to process technology and/or from numerical errors in the estimation of line per-unit-length parameters.

In [3], a stochastic model for MTLs was presented to statistically characterize crosstalk over multiconductor PCB interconnects, and this can be readily applied to analyze feasibility of MS in presence of variability. The proposed model is based on the analytical expansion of the interconnect p.u.l. parameters in terms of a series of orthogonal basis functions:

$$\mathbf{L}(\boldsymbol{\xi}) \approx \sum_{k=0}^P \mathbf{L}_k \cdot \phi_k(\boldsymbol{\xi}) \quad (6a)$$

$$\mathbf{C}(\boldsymbol{\xi}) \approx \sum_{k=0}^P \mathbf{C}_k \cdot \phi_k(\boldsymbol{\xi}), \quad (6b)$$

where \mathbf{L}_k and \mathbf{C}_k are matrix coefficients which can be computed with standard numerical integration techniques such as Gaussian quadratures. Of course, the number of terms $P + 1$

sets the accuracy of the approximation in (6). Vector $\boldsymbol{\xi} = [\dots, \xi_i, \dots]$ collects a set of normalized independent random variables which the line parameters depend on, while $\{\phi_k(\boldsymbol{\xi})\}$ are orthogonal polynomials defining a basis for the space spanned by the variables ξ_i . As such, the optimal choice for this basis depends on their distribution. For instance, Hermite and Legendre polynomials turn out to be the most suitable bases when ξ_i are Gaussian or uniform, respectively.

By using a similar expansion for the unknown voltage and current variables, and exploiting the orthogonality properties, the stochastic MTL equations can be rewritten in the following augmented form:

$$\frac{d}{dz} \tilde{\mathbf{V}}(z, s) = -s \tilde{\mathbf{L}} \tilde{\mathbf{I}}(z, s) \quad (7a)$$

$$\frac{d}{dz} \tilde{\mathbf{I}}(z, s) = -s \tilde{\mathbf{C}} \tilde{\mathbf{V}}(z, s), \quad (7b)$$

where the new p.u.l. matrices $\tilde{\mathbf{L}}$ and $\tilde{\mathbf{C}}$ are $P + 1$ times larger than those in the original line and contain the coefficients \mathbf{L}_k and \mathbf{C}_k of (6) in proper and pre-defined positions.

Solution of (7) can be obtained by means of the standard procedure for MTLs (see [6]) and provides the coefficients $\tilde{\mathbf{V}} = [\dots, \mathbf{V}_k, \dots]^T$ and $\tilde{\mathbf{I}} = [\dots, \mathbf{I}_k, \dots]^T$ for an expansion of the unknown voltage and current variables which is analogous to (6). Therefore, with a single solution of a larger system, one obtains an approximate analytical expression that can be used to fast evaluate any statistical parameter.

This solution was demonstrated to be much faster than collecting a large number of MC samples of the system solution, while maintaining comparable accuracy. Readers are referred to [3] and references therein for a formal and comprehensive discussion about the PC model and its derivation.

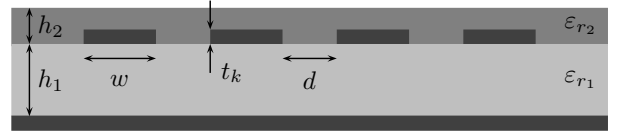

Figure 2: Cross-section of a two-layered microstrip interconnect with four signal traces. Bottom layer: substrate; top layer: solder mask.

Impact of Parameter Uncertainties on the Modal Signaling Transmission Scheme

In this Section, a PC model is created and used to study the effectiveness of MS in the case of a PCB link with uncertainties in the material parameters.

Let us assume a microstrip interconnect having the two-layered cross-section depicted in Fig. 2, and whose geometric and material parameters are [1]: trace width and thickness $w = 173 \mu\text{m}$ and $t_k = 50 \mu\text{m}$, respectively, trace separation $d = 132 \mu\text{m}$, substrate thickness and permittivity $h_1 = 118 \mu\text{m}$ and $\epsilon_{r1} = 4.1$, solder mask thickness and permittivity $h_2 = 60 \mu\text{m}$ and $\epsilon_{r2} = 3.5$. Moreover, a length of $\mathcal{L} = 4$ in is considered.

Of course, the design of encoders and decoders in Fig. 1 is unavoidably based on these nominal values. However, a fine

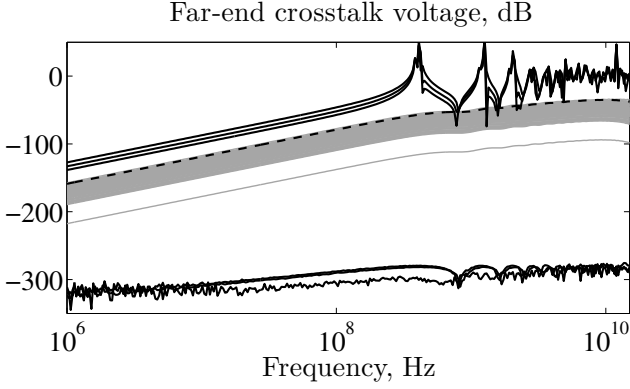

Figure 3: Crosstalk generated on the unexcited conductors. Upper solid black lines: crosstalk without MS scheme; lower solid black lines: crosstalk with MS scheme (deterministic interconnect); solid gray lines: set of MC samples showing the effects of permittivity variations; dashed black line: upper 3σ limit estimated using PC.

control of the substrate properties is often prohibitive, depending on the process technology. Fabrication tolerances as well as changes in the operating temperature might produce slight deviations that could have a significant impact on the transmission. To account for that, 3σ Gaussian variations of $\pm 10\%$ are independently ascribed to ϵ_{r1} and ϵ_{r2} , and a suitable PC model is created for the line of Fig. 2. One signal conductor is excited with a normalized 1-V voltage source. To compute the electrical characteristics of the interconnect, a 2D field solver is used.

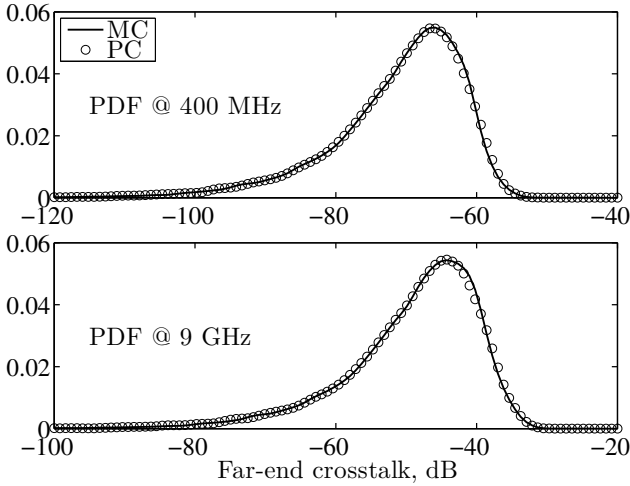

Figure 4: Probability density function of crosstalk at two different frequencies. Of the two distributions, the one marked MC refers to 20,000 MC simulations, while the one marked PC refers to the response obtained via PC expansion.

Figure 3 shows crosstalk produced on the three remaining conductors. The upper solid black lines refer to crosstalk without the application of MS scheme. At high frequencies, the

interference becomes very strong. The lower solid black lines show the improvement provided by the application of MS to the deterministic line: the simulation result is limited to numerical error, i.e., crosstalk is zero. The gray lines are a set of MC samples of the crosstalk on one adjacent conductor, obtained for random values of ϵ_{r1} and ϵ_{r2} . It is interesting to note that, due to the symmetry in the cross-section, which holds in case of permittivity variations, crosstalk is produced solely on one conductor. Finally, the dashed black line is the upper 3σ bound estimated from the PC approximation. As we can see, after the application of MS, resonances appear at higher frequencies, as if the electrical length were actually shorter. However, permittivity variations lead to a consistent worsening of the MS efficiency, although crosstalk is mostly below the uncoded case. Moreover, the 3σ limit given by PC provides an excellent estimation of the worst-case crosstalk that can be expected.

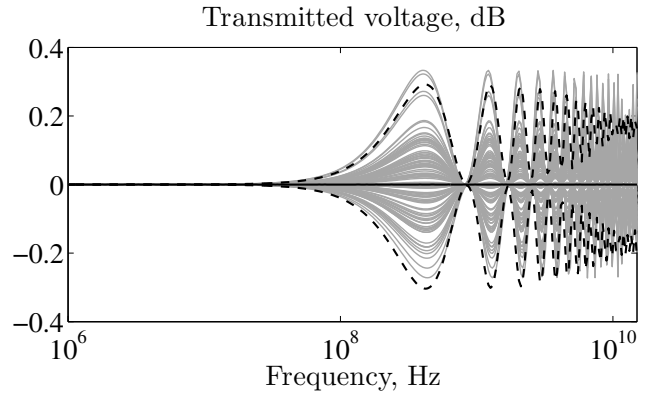

Figure 5: Voltage transmitted on the excited conductor. Solid black line: with MS scheme and deterministic interconnect; solid gray lines: set of MC samples showing the effects of permittivity variations; dashed black lines: $\pm 3\sigma$ limits estimated using PC.

In order to quantify the crosstalk spread and to estimate how often it will exceed a certain amount, more complex statistical information, such as the probability density function (PDF), is required. Figure 4 shows the PDF of crosstalk computed at two different frequencies. The PDFs estimated from the PC model are compared with those obtained from 20,000 MC samples. The accuracy in reproducing shapes rather differing from the original Gaussian distribution confirms the strength of the proposed technique. From the information enclosed in the PDF at 9 GHz, i.e., the frequency at which crosstalk flattens, it is possible to conclude that in 99% of devices crosstalk will be below -35 dB.

The same considerations apply to the signal that is effectively transmitted at the far-end side of the excited conductor, which is shown in Fig. 5. Again, gray lines are a set of MC samples while dashed black lines are the $\pm 3\sigma$ limits with respect to the average value. The PDFs reported in Fig. 6 show perfect agreement anew.

The curves in Fig. 3 clearly show that when permittivity variations are up to 10%, the improvement provided by MS is con-

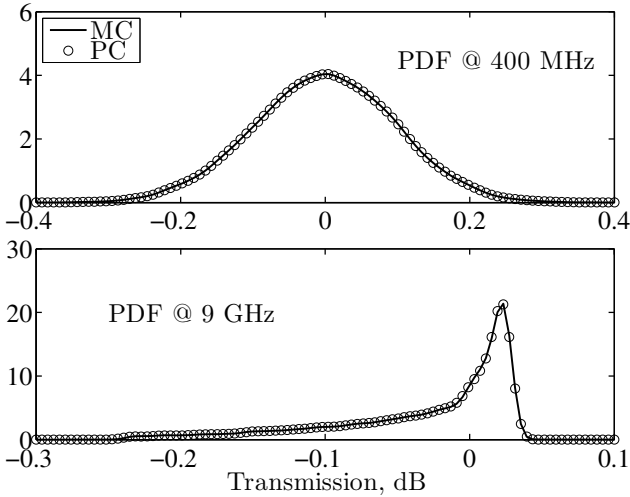

Figure 6: Probability density function of the transmitted voltage at two different frequencies. Of the two distributions, the one marked MC refers to 20,000 MC simulations, while the one marked PC refers to the response obtained via PC expansion.

siderably reduced. Nevertheless, such deviations may be somewhat extreme when dealing with high-quality PCBs. In order to assess the impact of tolerance deviations, Fig. 7 shows the upper crosstalk bounds computed for increasing values of permittivity deviations, from 0.0001% to 10% with magnification steps of $10\times$. Variations as small as 1 ppm in the permittivity values produce a remarkable crosstalk level with respect to the ideal case, although far below the uncoded case.

Method	Simulation time	Speed-up
MC	2 h 16 min	–
PC	57 s	$140\times$

Table 1: CPU times required by MC and PC simulations.

Finally, Tab. 1 collects the key figures about the efficiency, showing that PC is faster by over two orders of magnitude. The reported times are referred to an entire frequency sweep over 300 points. For fairness, the table includes also the overhead introduced by PC due to the building of the augmented matrices.

Conclusions

MS transmission scheme is being studied as a promising solution for the crosstalk mitigation in high-speed links. However, being its design strongly based on the interconnect properties, any random fluctuation in these parameters may represent a challenge in the application of this methodology.

This paper addresses the analysis of MS feasibility in presence of uncertainties in the material parameters by means of PC models. The proposed approach is based on the expansion of the governing equations onto a basis of orthogonal polynomials. The result is an analytical, yet representative and accurate approximation of the actual solution allowing the computation

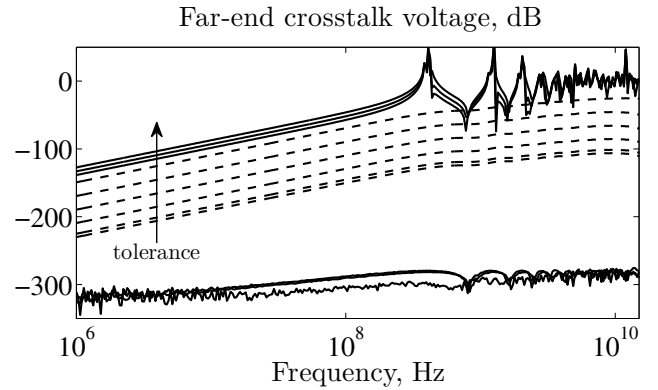

Figure 7: Upper 3σ bounds of crosstalk, computed by means of PC for different values of permittivity standard deviations (dashed lines). For comparison's sake, solid lines coincide with those in Fig. 3.

of any statistical information. Therefore, it provides designers an efficient tool for the stochastic analysis and the assessment of design margins.

By means of this application, the advocated method is further validated and confirms to be more efficient than the classical MC technique in determining the system response sensitivity to parameter variability, while providing accurate results. The computational advantages of PC arise from the reduced size of the system that must be solved, compared to the large number of simulations required by a traditional MC analysis. The speed-up observed in the proposed example is $140\times$.

References

- [1] Milosevic, P., Schutt-Ainé, J. E., and Beyene, W. T., “Crosstalk Mitigation of High-Speed Interconnects with Discontinuities Using Modal Signaling,” *Proc. of the 19th IEEE Conference on Electrical Performance of Electronic Packages and Systems*, Austin, TX, pp. 21–24, October 2010.
- [2] Broydé, F., and Clavelier, E., “A New Method for the Reduction of Crosstalk and Echo in Multiconductor Interconnections,” *IEEE Trans. Circ. Sys.*, Vol. 52, No. 2 (2005), pp. 405–416.
- [3] Stievano, I. S., Manfredi, P., and Canavero, F. G., “Parameters Variability Effects on Multiconductor Interconnects via Hermite Polynomial Chaos,” *IEEE Trans. Comp. Pack. Man. Tech.*, Vol. 1, No. 8 (2011), pp. 1234–1239.
- [4] Xiu, D., and Karniadakis, G. E., “The Wiener-Askey Polynomial Chaos for Stochastic Differential Equations,” *SIAM J. Sci. Comput.*, Vol. 24, No. 2 (2002), pp. 619–622.
- [5] Stievano, I. S., Manfredi, P., and Canavero, F. G., “Impact of Parameters Variability on the Electrical Performance of Carbon Nanotube Interconnects,” *Proc. of the 15th IEEE Workshop on Signal Propagation on Interconnects*, Napoli, Italy, pp. 83–86, May 2011.
- [6] Paul, C. R., *Analysis of Multiconductor Transmission Lines*, Wiley (New York, 1994).