

POLITECNICO DI TORINO
Repository ISTITUZIONALE

HARMONAC Case study report: IT Case Study 1: Office – Water system. ISBN: 978-1-899895-72-4

Original

HARMONAC Case study report: IT Case Study 1: Office – Water system. ISBN: 978-1-899895-72-4 / Masoero, Marco Carlo; Silvi, Chiara; Toniolo, Jacopo. - ELETTRONICO. - (2010).

Availability:

This version is available at: 11583/2497824 since:

Publisher:

Published

DOI:

Terms of use:

This article is made available under terms and conditions as specified in the corresponding bibliographic description in the repository

Publisher copyright

(Article begins on next page)

IT Case Study 1: Office – Water system

Marco Masoero, Chiara Silvi and Jacopo Toniolo
DENER, Politecnico di Torino
IT

August 2010

The sole responsibility for the content of this report lies with the authors. It does not represent the opinion of the European Communities. The European Commission is not responsible for any use that may be made of the information contained therein.

Supported by

Intelligent Energy  **Europe**

ISBN: 978-1-899895-72-4

CASE STUDY

ATC: Office building with Water system

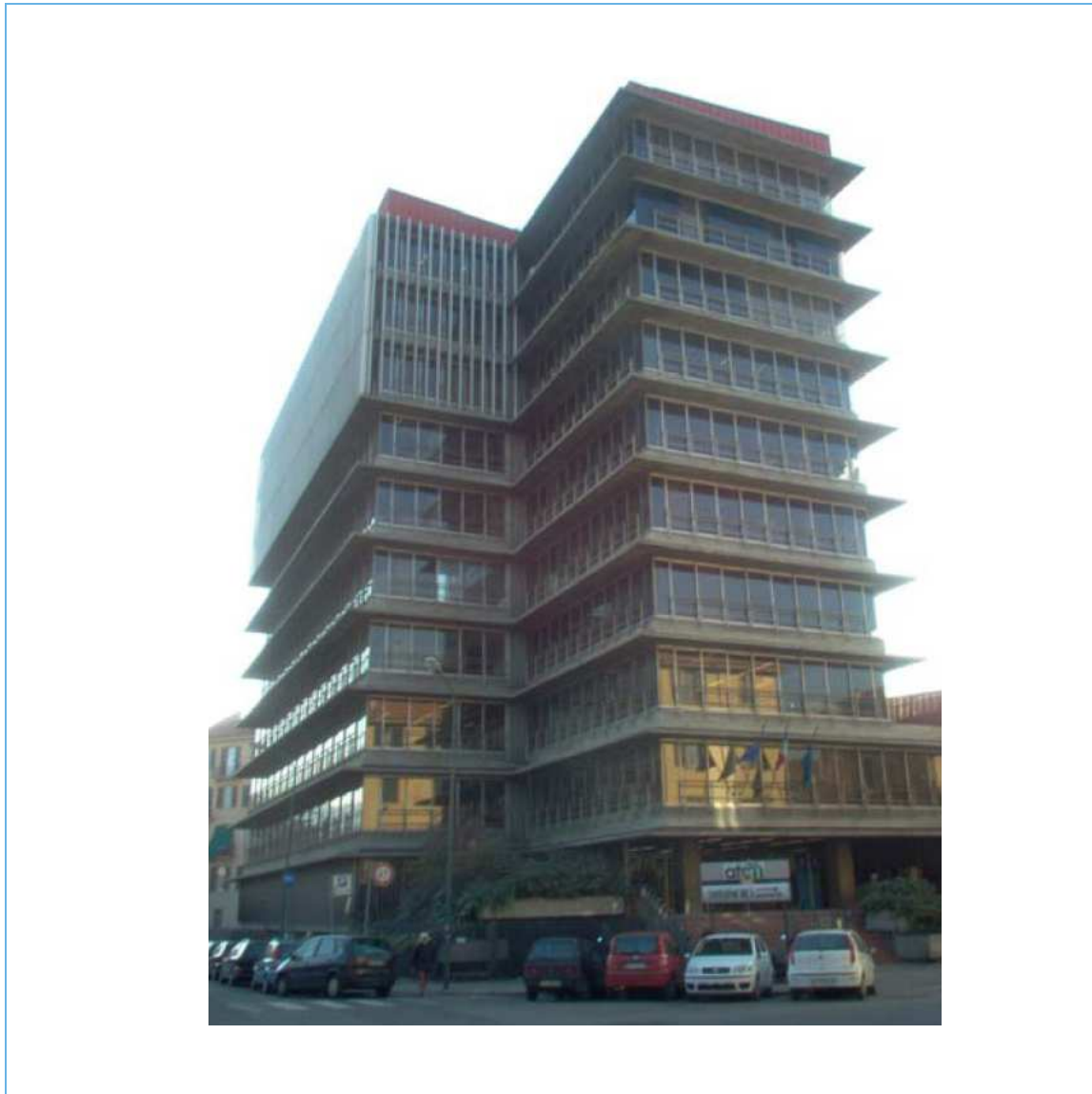

This case study examines a 10 floor office building built between 1969 and 1972. The A/C system of the office spaces is an all-water, two-pipe, fan coil type. No mechanical ventilation is provided. The main plant comprises a cogeneration unit. The cold generators for the system are one Trane RTWB 214 (screw) and an absorption unit, Broad BDH 20, installed in June 2008. Condenser heat rejection is achieved with underground water.

The building has an online electrical consumption metering system that was installed within the EU funded Policity project, in which Politecnico di Torino is also involved; aim of the project is the detailed analysis of electrical energy consumption of buildings.



Building Description

Country & City	Italy, Turin
Building Sector /Main Activity	Office
Net Area[m ²]	6840

Installed Plant

Parameter	Installed electrical load / kW	Floor area served / m ² GIA	Installed capacity W/m ² GIA	Annual consumption kWh	Average annual power W/m ²	Annual use kWh/m ²	Average annual power (% FLE)
Total Chillers nominal cooling capacity (cooling output)	630.0	4'840.0	130.2				
Total Chillers	100.0	4'840.0	20.7	66'400.0	1.6	13.7	7.6
Total CW pumps[a]	82.0	4'840.0	16.9		-	-	-
Total fans			-		-	-	-
Total humidifiers			-		-	-	-
Total boilers	4.9	6'440.0	0.8	-	-	-	-
Total HW pumps	57.9	6'440.0	9.0	113'200.0	2.0	17.6	22.3
Total HVAC electrical	246.8	6'440.0	38.3		-	-	-
Total Building Elec kWh		6'440.0		1'260'700.0	22.3	195.8	
Total Boilers/Heat kWh		6'440.0	-		-	-	-
Total Building Gas/Heat kWh		6'440.0			-	-	

Energy savings

ECO CODE	DESCRIPTION	ACTION	Saving
E2.4	Correct excessive envelope air leakage	partially windows substitution	-0.6-4% of HVAC consumption in summer -1.5-7.3% of heat consumption in winter
E2.6	Apply night time over ventilation	users or automatic devices	1.5-5% of summer HVAC consumption
E3.1	Upgrade insulation of flat roofs externally	roof insulation	-0.6 on summer HVAC consumption
E3.7	Locate and minimize the effect of thermal bridges	already applied, insulation of overhangs	11.5% on heating energy in winter
E3.9	Use double or triple glaze replacement	partially applied, spot measurements	24.17% on heating energy in winter
P2.12	Consider the possibility of using waste heat for absorption system	applied with CHP, measured by BMS	Value dramatically different between simulation and measurement



Overview of building and system

This case study examines a 10 floor office building built between 1969 and 1972, which hosts the headquarters of ATC, the public housing agency of the Province of Torino. The A/C system of the office spaces (Zone 1: roughly 12000 m³) is an all-water, two-pipe, fan coil type. While no mechanical ventilation is provided to the office spaces, two distinct AHU's serve the Canteen (Zone 2) and the Auditorium (Zone 3). The building is presently undergoing a thorough refurbishment including interventions on the building envelope, fan coil substitution, and the installation of a new absorption water chiller. The lighting system in the building is standard, without any type of PIR control.

HVAC system

The system is centralized. The main plant comprises a cogeneration unit, consisting of a gas fired IC engine providing 960 kW of electric output and 1168 kW of thermal output, and three gas fired hot water boilers, two of which rated at 2600 kW and one rated at 895 kW. The hot water produced by the central plant is used both for the ATC office building and for a district heating network serving the nearby "Arquata" quarter (505 apartments, 80000 m³ heated volume). The circuit is hydraulically disconnected, by two heat exchangers. One heat exchanger, rated at 1000 kW, serves the ATC building, while the other one, rated at 3000 kW, serves the Arquata district heating network. The hot water on the primary circuit is circulated by 2 x 15 kW pumps. The secondary circuits of the ATC building comprise a main collector. From the collector the hot water is circulated by 11 pumps, serving distinct zones (more detail in **HVACs' system components** section).

The pumps for the horizontal circulation for district heating are 3 x 15 kW; in each building served, a sub station exists with dedicated pumping devices.

The cold generators for the system are one Trane RTWB 214 (screw) rated at 400 kW cooling capacity, with a maximum electrical consumption of 91 kW. The absorption Broad BDH 20 unit was installed in June 2008, rated at 195 kW cooling, with a maximum electrical consumption of 1.8 kW; thermal input to the absorption chiller is given by heat recovered from the cogeneration plant. The chilled water produced by these generators is distributed by 4 x 1.5 W fixed speed pumps. Condenser heat rejection is achieved with underground water.

The building has an online electrical consumption metering system that was installed within the EU funded Policity project, in which Politecnico di Torino is also involved; aim of the project is the detailed analysis of electrical energy consumption of buildings.

This means that the metering currently available is:

- Main electrical incoomer
- Global electrical consumption of the central cooling plant
- CHP electrical production

- Electric chiller consumption
- Absorption chiller Thermal production

To obtain the overall performance of the A/C system, additional metering was installed to allow disaggregation of the cooling plant global consumption.

The system has a BMS operated via the BacNet protocol. This enables data to be stored on the outstations for items such as external temperature and RH, internal temperature and RH, etc. This data are available since March 2008.

S

ummary of building and systems

The following table summarises the main aspects of the building (based on EPA-NR and WP2):

Building Description

Building Sector /Main Activity	Office
Net Area[m ²]	6840
Max number Occupants	390
N° Zones	3

Zone Description

Zone ID	Activity Type	Net Area	N° Occupants
1	Office	6440 (net)	300
2	Canteen	80 (net)	10
3	Conference Hall	315 (net)	80

Heating/Cooling Production

		Normalised/ m ² GIA	Notes
Conditioned net Area (cooling)	4840 [m ²]		not all the area are conditioned
Chillers nominal cooling capacity	630 [kW]	130.2 W/m ²	195 abs. + 400 el.
Chillers nominal electrical demand	100 [kW]	20.7 W/m ²	
Chillers chilled water circulation pumps nominal electric demand	82 [kW]	16.9 W/m ²	
COP	4.35		
Operation Hours	760	-	estimate
Conditioned net Area (heating)	6440 [m ²]		Zone 1,2 (3 on demand)
Boilers nominal heating capacity	7195 [kW]	Not Applicable	2 gas boilers (2600 each) + 1 gas boiler (895) + 1 CHP unit (1100) The building serves also as a central heating station for District Heating
Nominal Efficiency	95 [%]	-	
Operation Hours	1680	-	depending on climatic conditions

M

Measured annual performance

		Normalised/ m ² GIA	Notes
Total Building Electrical Consumption	1260.7 [MWh]	195.8 kWh/m ²	
• HVAC Equipment	74.1 [MWh]	15.3 kWh/m ²	Data referred to electric chiller and chilled water pumps
Total Building Gas Consumption	15723 [MWh]		The kWh/m ² value has not meaning because the gas is used to heat the nearby quarter
HVACs' system components			
Main Chillers and Chilled Water circulation pumps	74.1 [MWh]	15.3 kWh/m ²	Data referred to electric chiller
Main Chillers Chilled Water circulation pumps	3.8 [MWh]	0.8 kWh/m ²	
CHP system Gas consumption	1370 [MWh]		The kWh/m ² value has not meaning because the gas is used to heat the nearby quarter

C

ase study details - Building Description

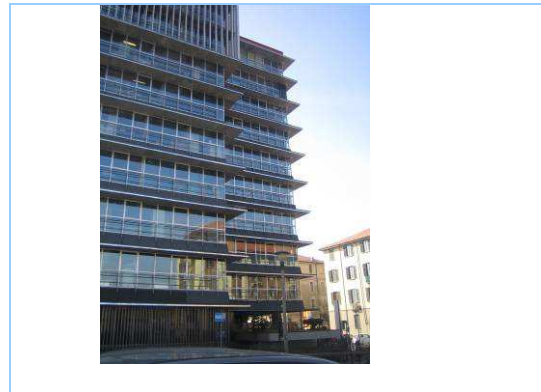
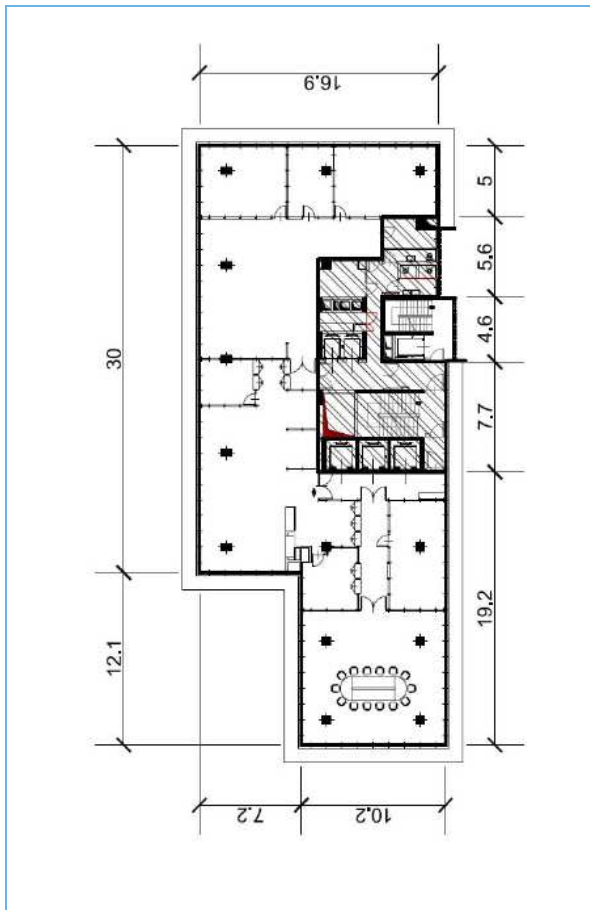

General building data

Country/City

Latitude/Longitude[°]

Elevation [m]

Cooling Degree Days

Building Sector/Main Activity

Total net floor area [m²]

Ceiling height [m]

Number of floors

Italy – Turin
45°4'41"16 N-07°40'33"96 E

240

2617

Office

6440

3,3

9

C

ase study details - Constructions details

Envelope	
- Heat Transfer Coefficient [W/m².K]	
External wall (predominant)	0.74
Floor (predominant)	1.2
Intermediated floor (predominant)	1.1
Roof (predominant)	1.0

Windows	
U- value (predominant) [W/m ² .K]	1.75 - 3.58
Window type	4 glass – 2 glass
Window gas	Argon – air
Solar Factor	
Solar Protection Devices	
Window Overhangs	External
Shading Device	Interior Shade

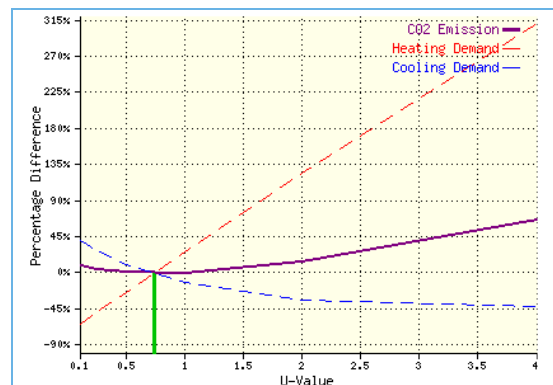
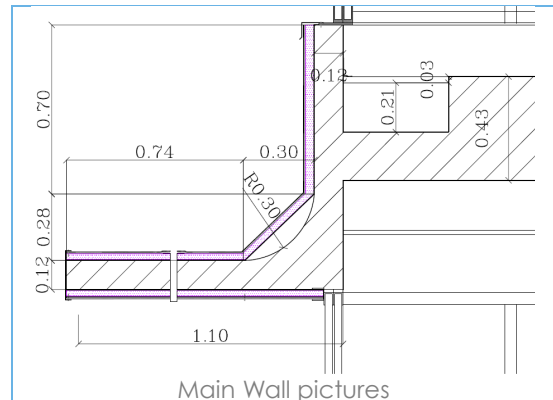
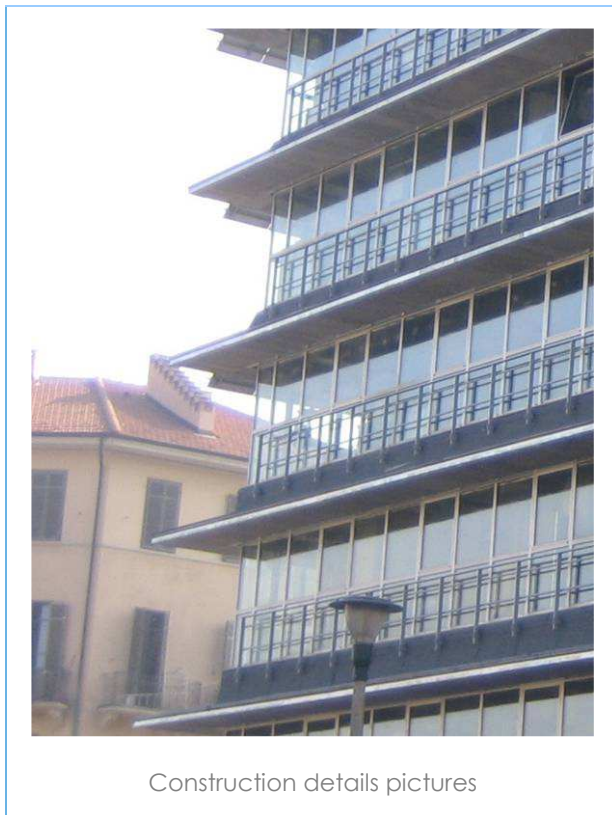

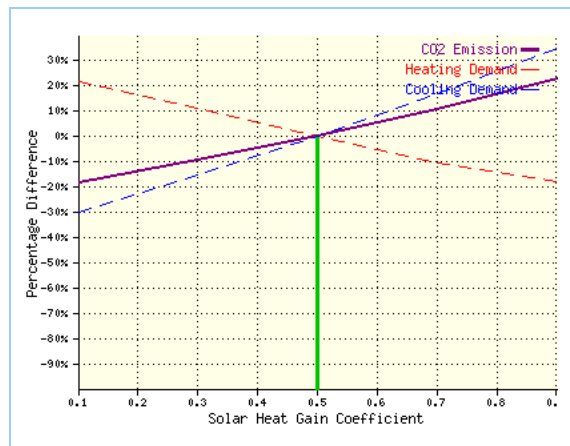
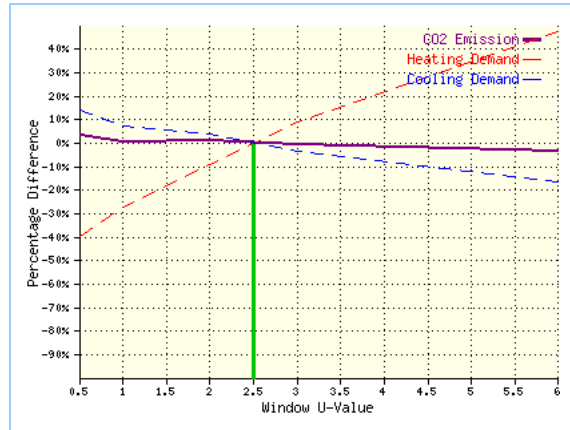

Internal gains and operation schedules per zone

Zone ID:	1	
Activity type	Office	
Equipment electric loads/Schedules	Design	Measure/observe - Winter/Summer (average)
Office equipment [W/m ²]	16	
Working schedule	Mon-Fri 9:00-18:00 Sat 9:00-13:00	
Permanent/variable occupancy	-	300 (mean)
Cleaning staff schedule	-	variable
Lighting [W/m ²]	23	22
Type of lighting	Fluorescent tubes	-
Lighting control	manual on/off	-

Lighting schedule	Winter 30% 8:00-15:00 100% 15:00-18:00 Summer 30% 8:00-18:00
-------------------	--

The building, due to its construction, has high levels of natural light. Automatic lighting control would permit high savings on electric consumption associated to electric light system. At present conditions, lights are shut off manually, with low effectiveness on control.

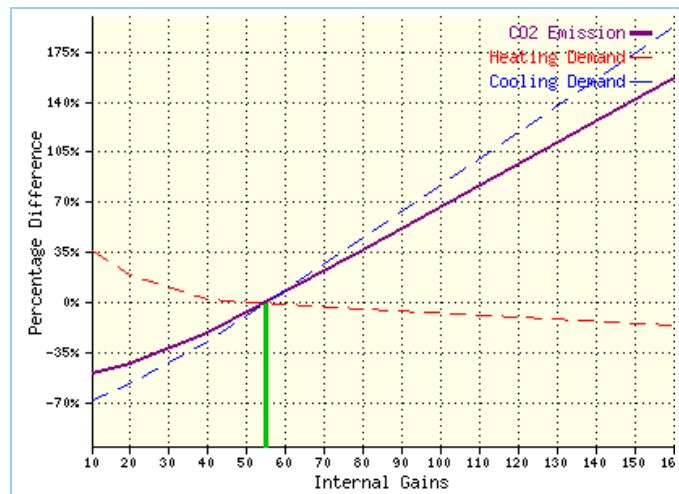

Monitoring observations for internal gains

Benchmark and Simaudit tools were used on the case study, to simulate energy consumption of the building. The first run on benchmark shows underestimate values (almost at 50%). Second run on Simaudit, changing the more sensitive variables on the model (air exchange, internal temperature), shows good results.

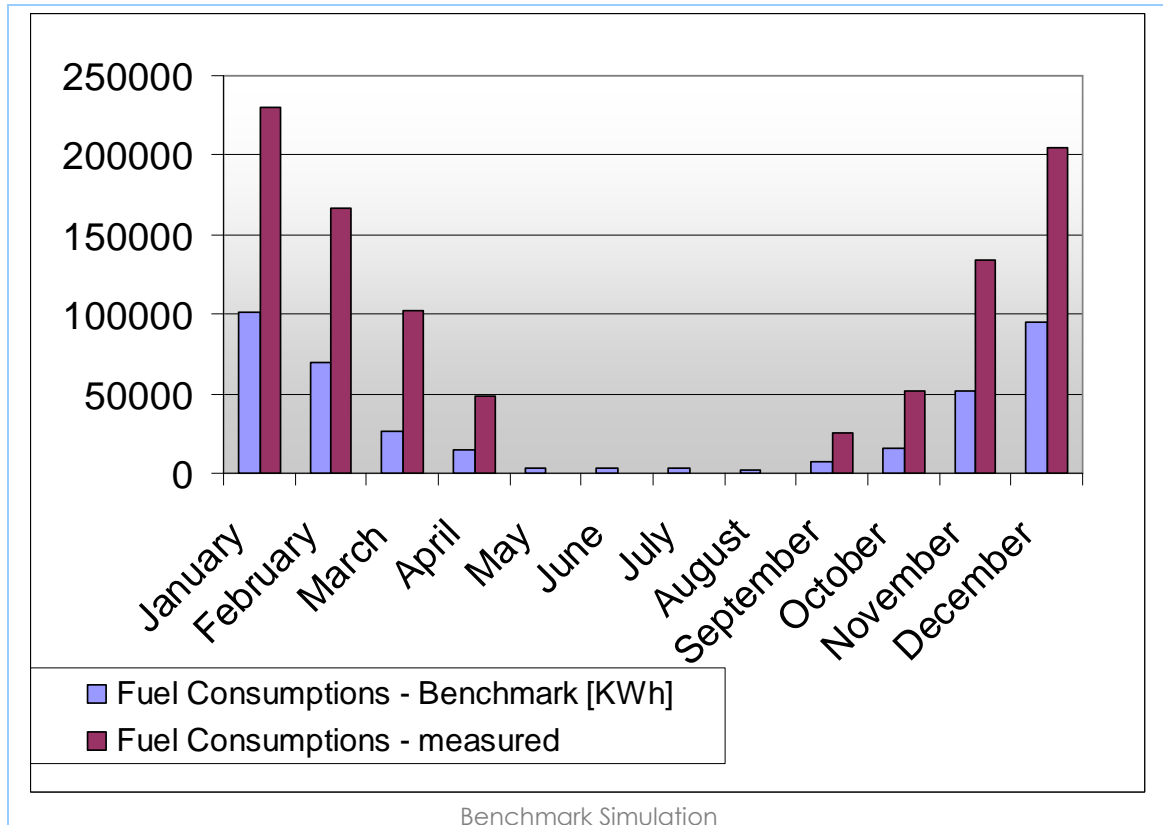

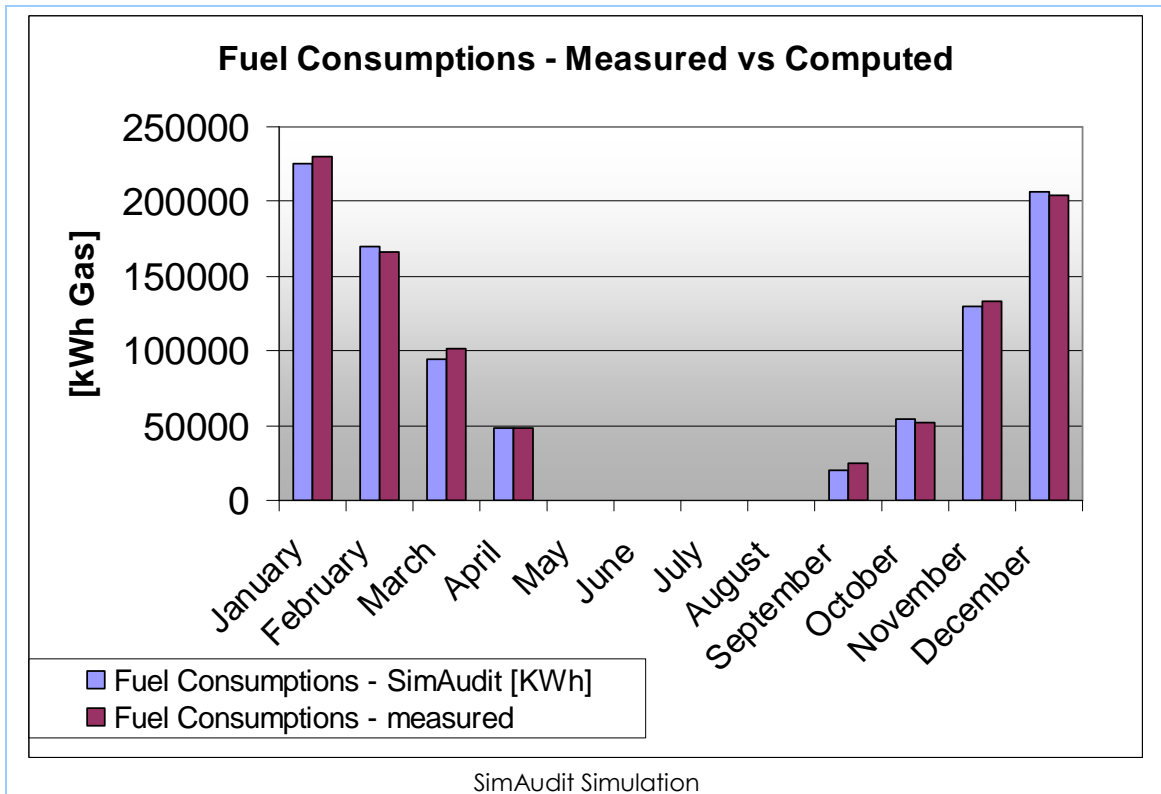

In the table below are presented some parameters, input of the simulation in benchmark

1.2.1. Global Heat Transfer Coefficient

$$h_{in} = 8 \text{ [W/m}^2\text{-K]}$$

$$h_{out} = 20 \text{ [W/m}^2\text{-K]}$$

1.2.2. Frontages Characteristics

$$U_{opaque,frontages} = 0,62 \text{ [W/m}^2\text{-K]}$$

Type_Opaque_frontages: MEDIUM : 250000 J/m²-K

$$U_{windows} = 2,5 \text{ [W/m}^2\text{-K]}$$

$$SF_{windows,0} = 0,5 \text{ [-]}$$

1.2.3. Structure Characteristics

$$U_{floor} = 1,6 \text{ [W/m}^2\text{-K]}$$

$$U_{ceiling} = 1,6 \text{ [W/m}^2\text{-K]}$$

$$U_{roof} = 0,8 \text{ [W/m}^2\text{-K]}$$

$$C_{int,walls\&int,walls} = 150000 \text{ [J/m}^2\text{-K]}$$

Diagram from Benchmark and SimAudit tool on electricity consumption.

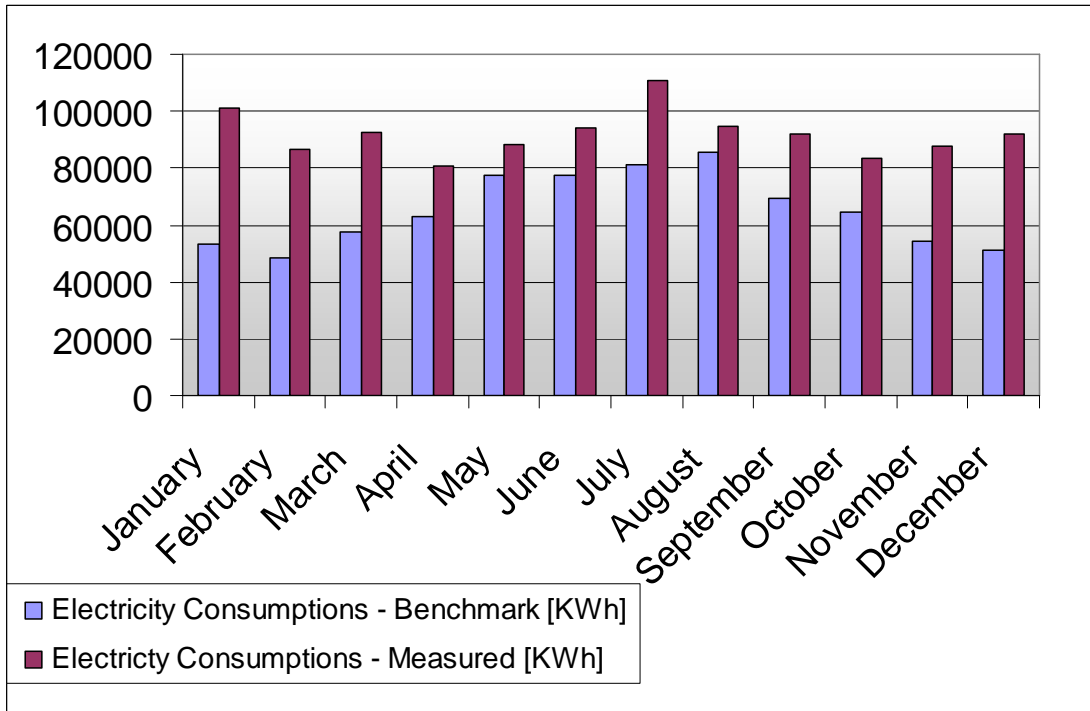

Benchmark Simulation

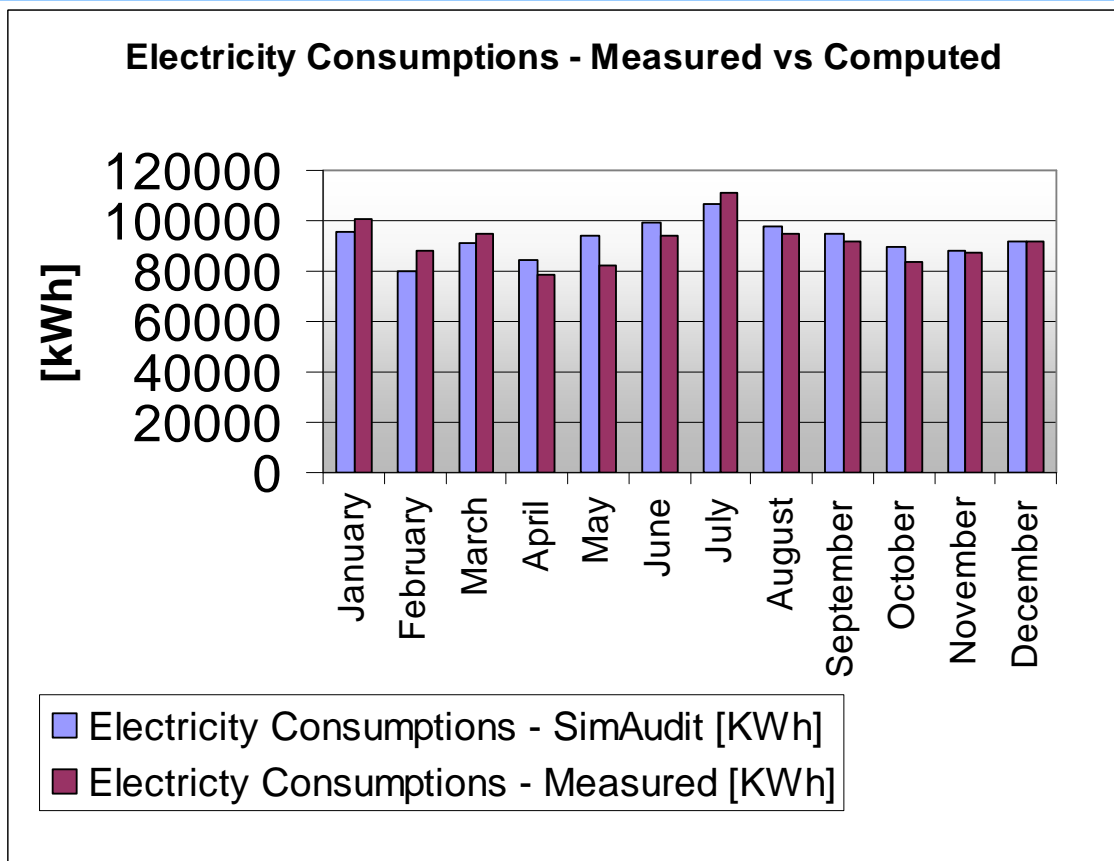

SimAudit Simulation

E

Environment parameters

Description of the environment design conditions, Heating/cooling loads, design temperatures (from UNI EN 10349).

Outdoor Environment Parameters	Design	Measure/observe - Winter/Summer (average)
Outdoor air temperature [°C] Winter/Summer	-8 / 30.7	min -3 / max 36.4 avg: 6.1/ 25.3
Outdoor Relative Humidity [%] Winter/Summer	85% / 46%	77/ 61.6
Max. Solar Radiation [W/m ²]		max 1119 (10.06.2008) avg : 63.6 / 203.1 (on 24h)

Zone ID:	1
Activity type	Office

Indoor Environment Parameters per zone	Design	Measure/observe - Winter/Summer (average)
Ventilation Rate [ach]	2	
Indoor air Temperature [°C] – Winter/Summer (air temperature)	20/N.A.	21/22-26

Monitoring observations for environmental parameters

The meteo data for Torino were provided by three different sources:

1. meteo station installed on the roof of the building
2. meteo data provided by NEMEST project (station installed on Politecnico di Torino)
3. meteo data provided by ARPA Piemonte, the regional environmental protection agency

For the consumption and statistical analysis ARPA data were used. These data, in fact, showed statistical robustness, provided by 3 meteo stations in a 3 km radius from the case study location.

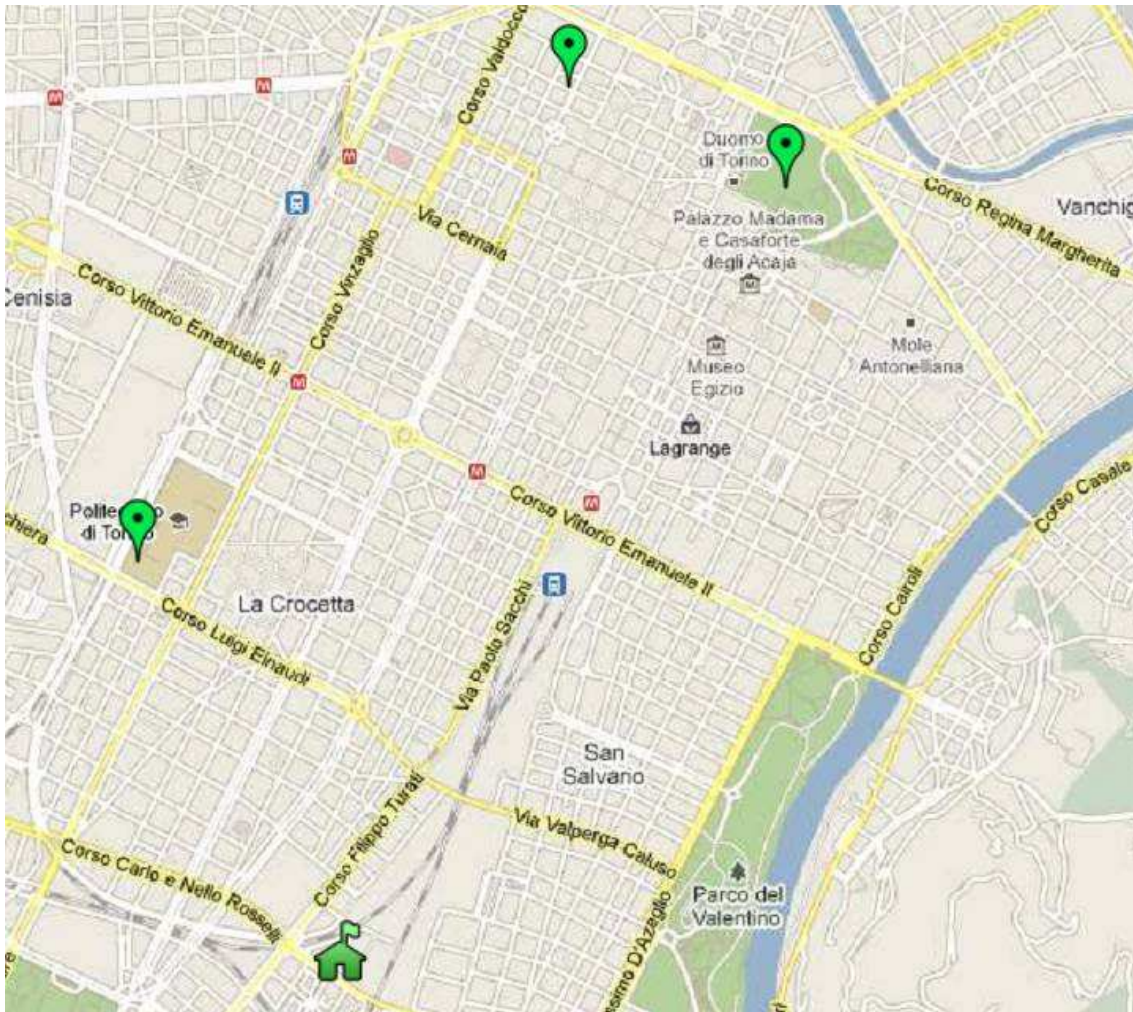

The green house represents ATC building, while the three green pointers represent the 3 meteo stations.

Daily temperature (2007-2009)

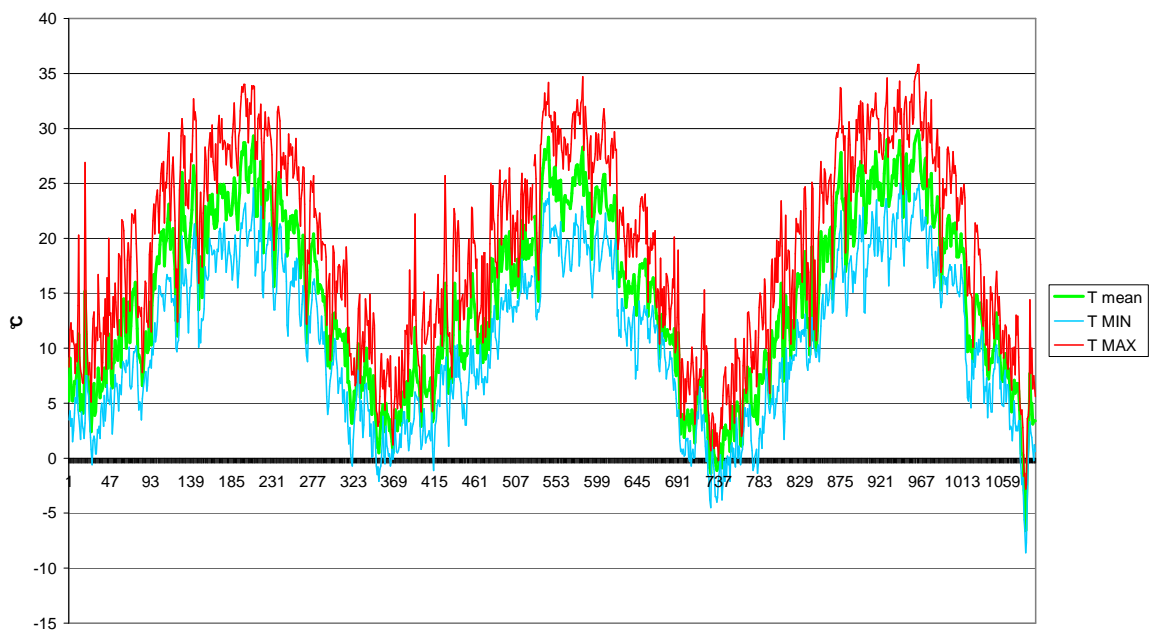

Carpet plots of external temperature are provided for different years (2008, 2009). Air enthalpy was calculated with the formula below (ASHRAE 2009, Fundamentals) from external temperature, relative humidity and air pressure:

$$h = 1.006t + W(2501 + 1.86t)$$

$$W = 0.621945 \frac{P_w}{p - P_w}$$

$$P_w = RH \cdot P_{ws}$$

$$\ln(P_{ws}) = \frac{C8}{T} + C9 + C10T + C11T^2 + C12T^3 + C13 \ln T$$

With:

h	=	air enthalpy
t	=	air temperature (°C)
P _w	=	vapour pressure
P _{ws}	=	saturated vapour pressure
RH	=	relative humidity
C9-C13	=	constants

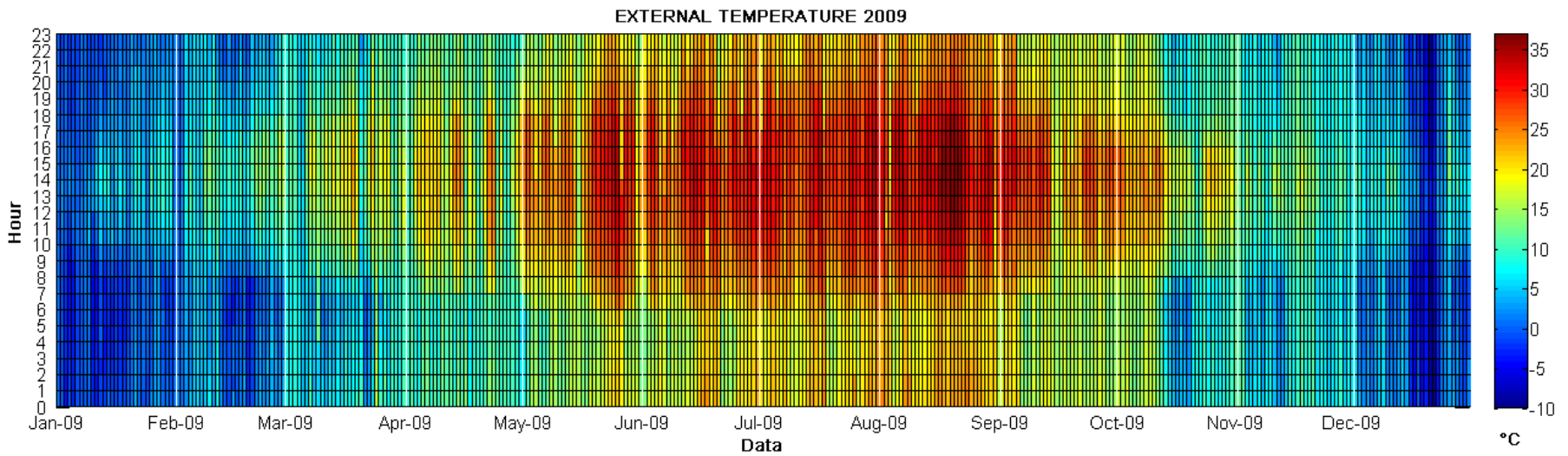
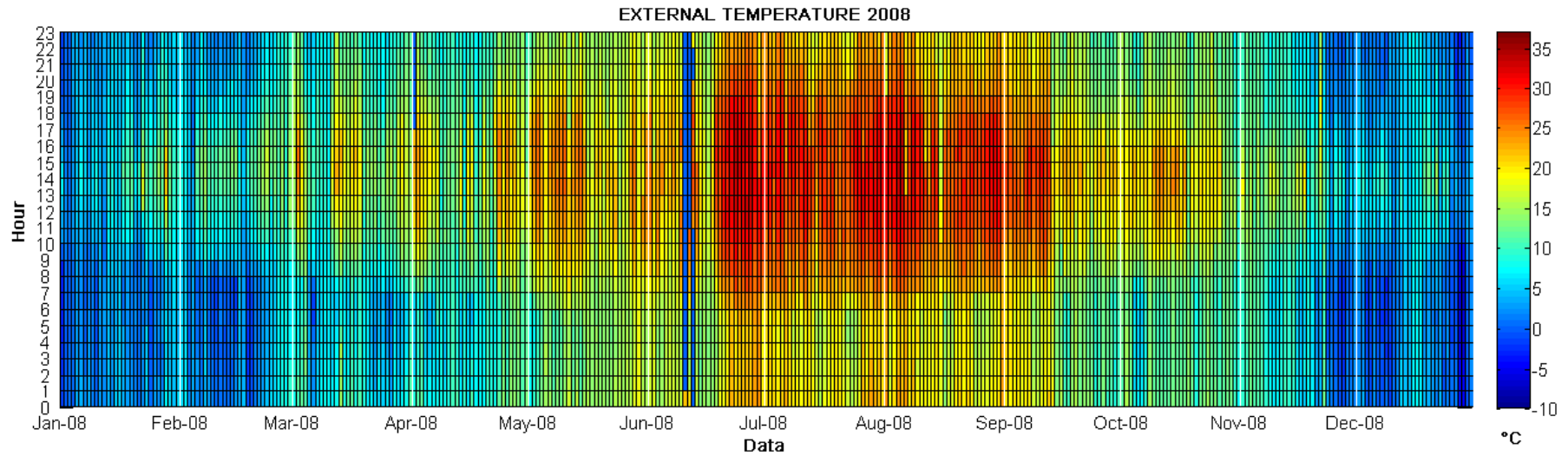

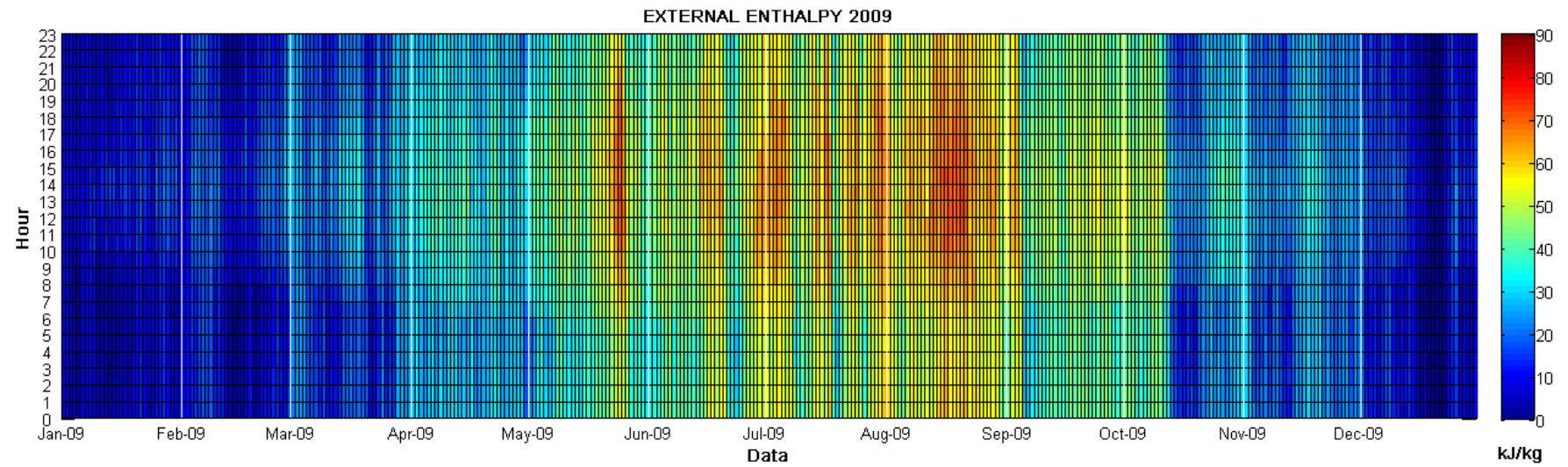
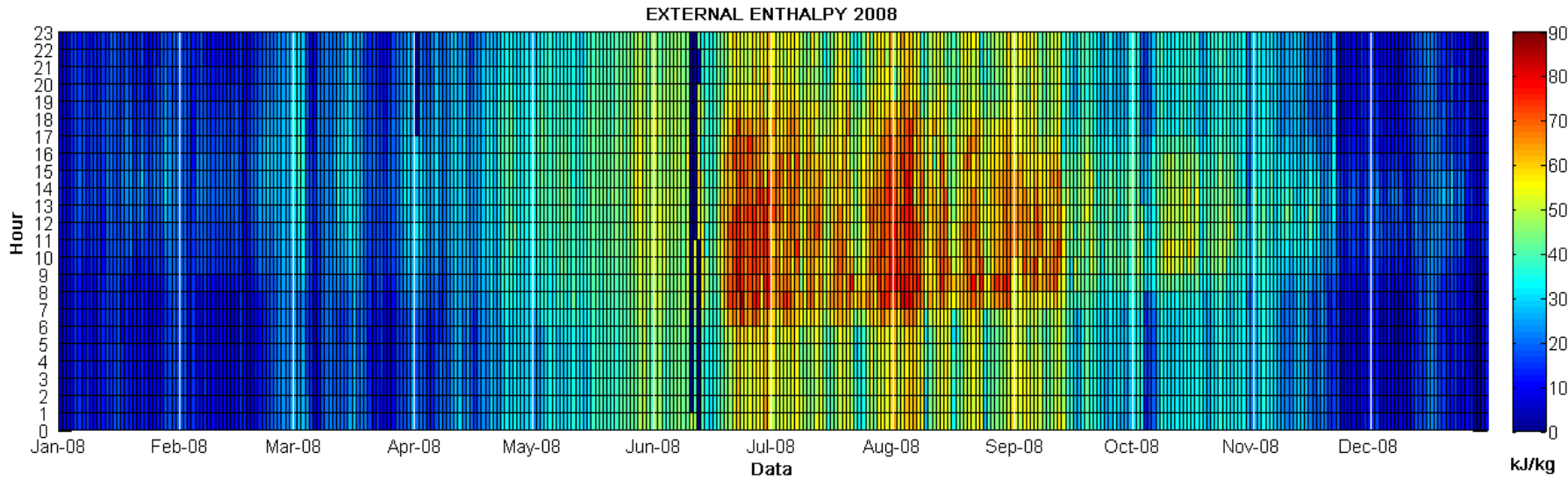

As seen in the graphs, 2009 season was characterized by external air temperature higher than 2008 season. This implies, on a first analysis, a higher load for the cooling system. Nevertheless it is interesting that air enthalpy on 2009 season is lower than in 2008 season; this implies that for those systems with mechanical ventilation, probably 2008 season was characterized by higher consumption.

The system analyzed does not provide mechanical ventilation: the 2009 season had a higher cooling load than 2008. This difference was due to external conditions, but also to a different system operation strategy (explained in the **Energy consumption data** section).

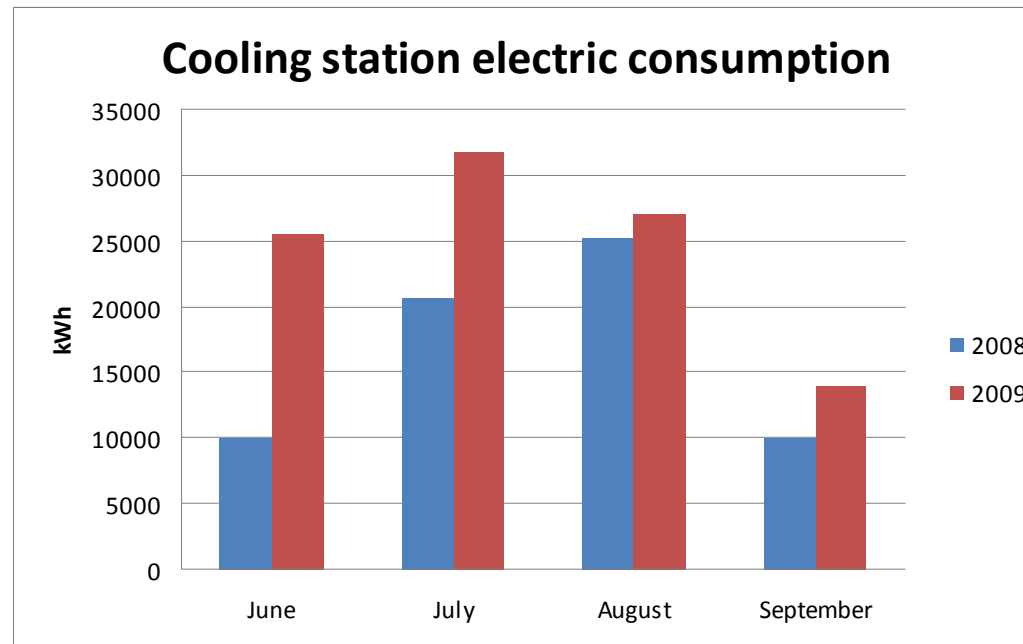

Internal temperature logging

Survey on occupants was made on a statistical basis. Four persons per storey were interviewed about complaints. Reason for complaints was in general temperature control in south part of the building. The control system allows different temperature control in different zones; temperature logging was installed on August 2008 to check occupants' complaints. Loggers was installed on first, fifth and ninth storey. In the image below, the scheme of logger installation (green flags) on **storey number 5** is shown. Analogous installation was provided on storey 1 and 9.

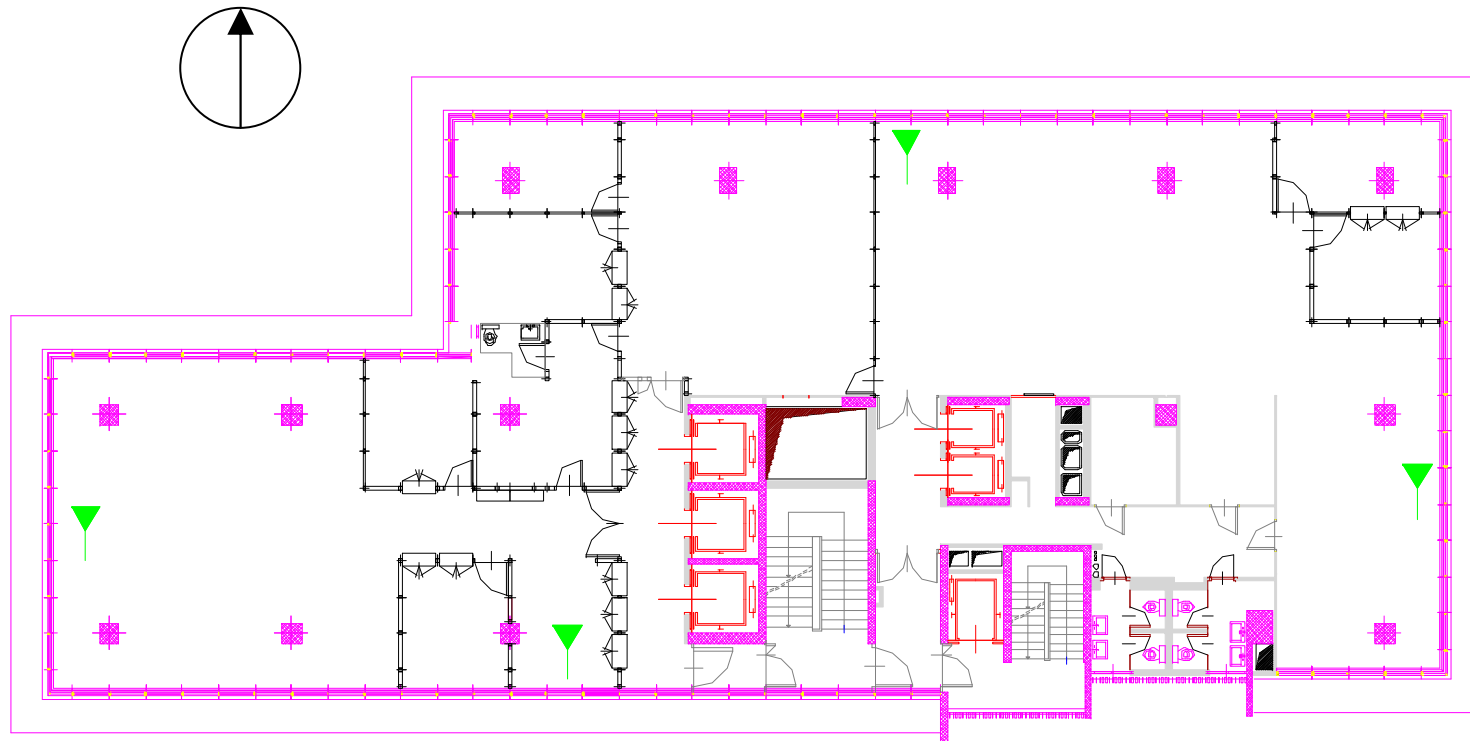

The installation cover the the four different orientation. Data are provided in the graphs below.

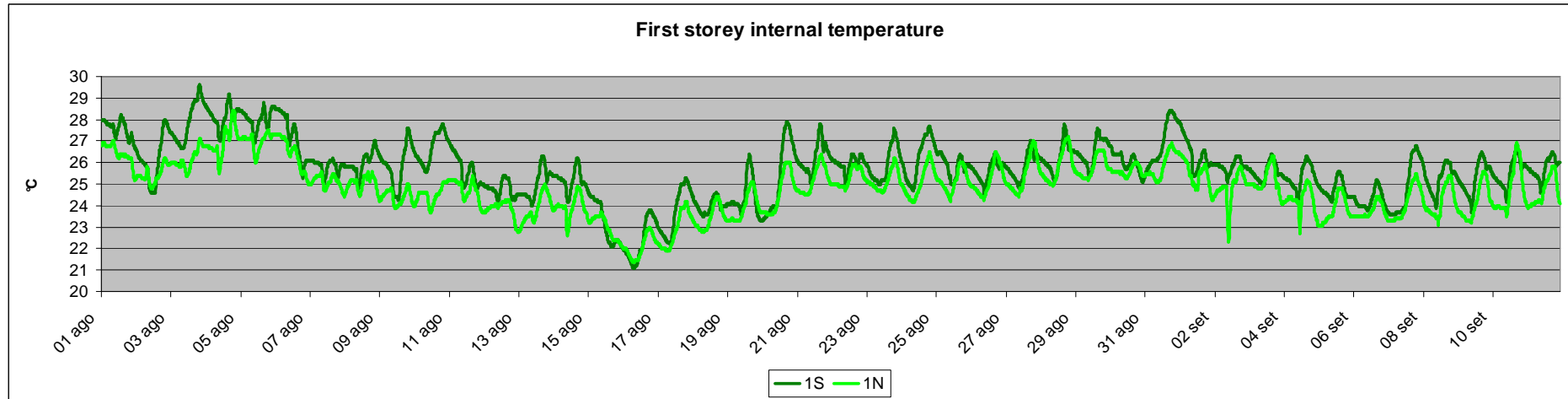

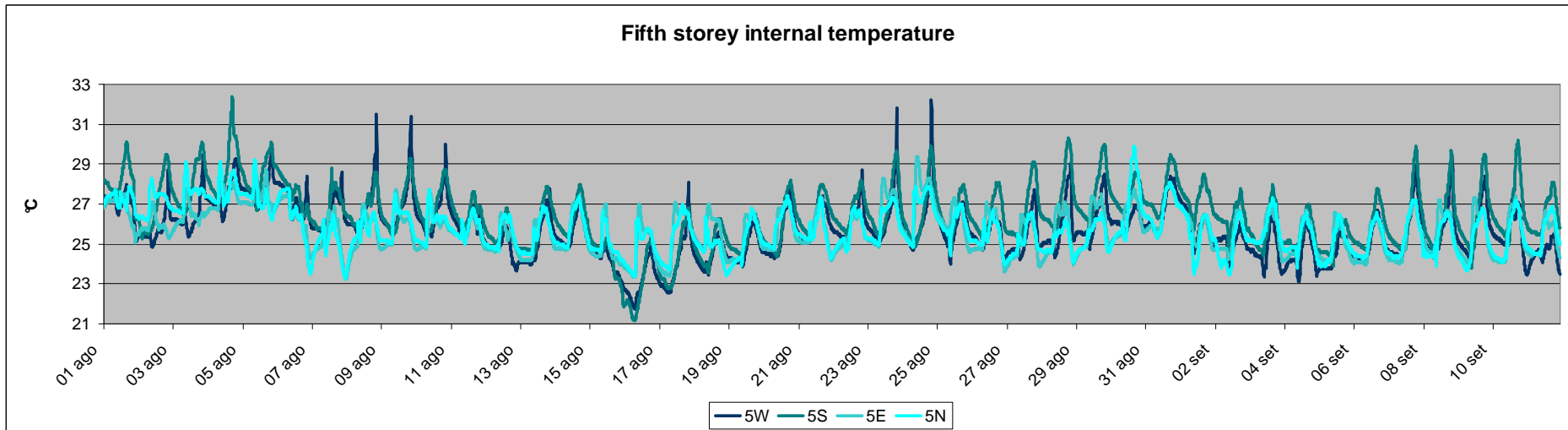

It can be noticed that temperature varies a lot between different parts of the building, depending on time of the day and solar irradiance. Some check in control system has to be made.

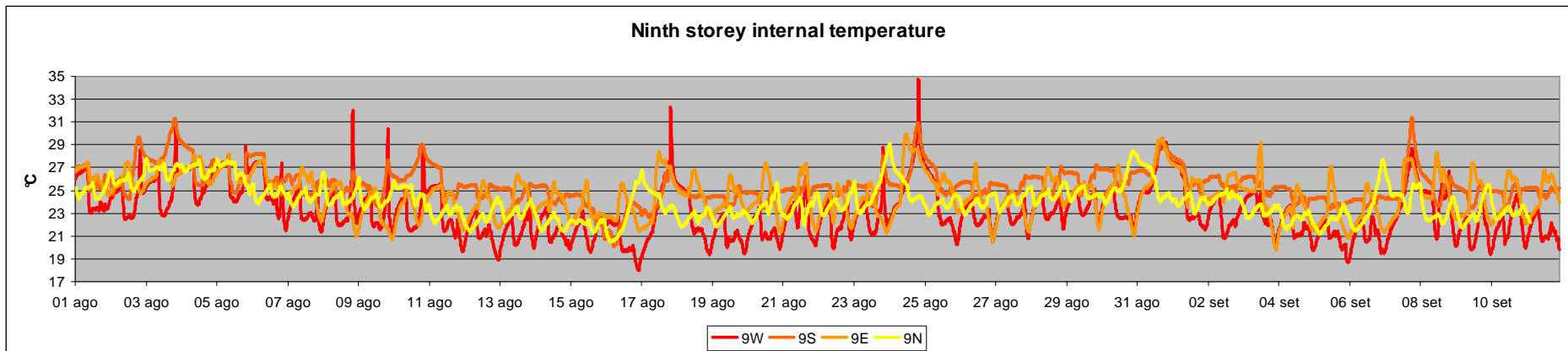

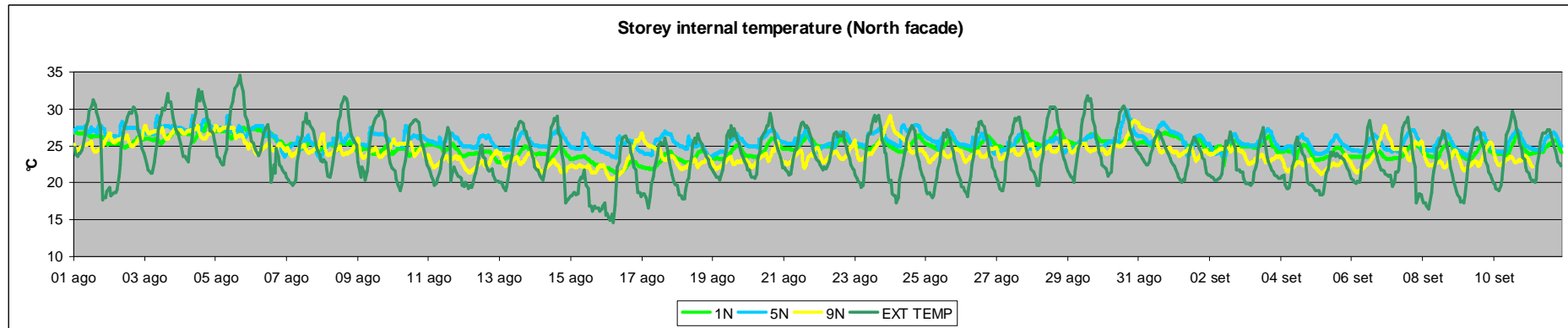

As seen in the graph the internal temperature varies from 20 to 29 °C. The ninth storey has in general temperatures lower than the other storeys; this is due to the relatively low set point of this storey, used as meeting room. With a better definition of system controls, zone set-point and users training, it will be possible to obtain better internal comfort and energy savings (it is clear that the ninth floor is over cooled, considering the external temperature).

User's behaviours

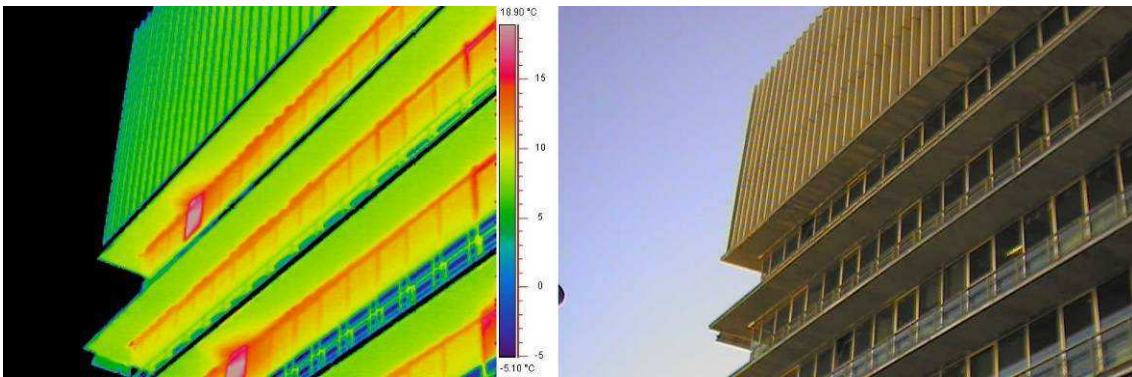
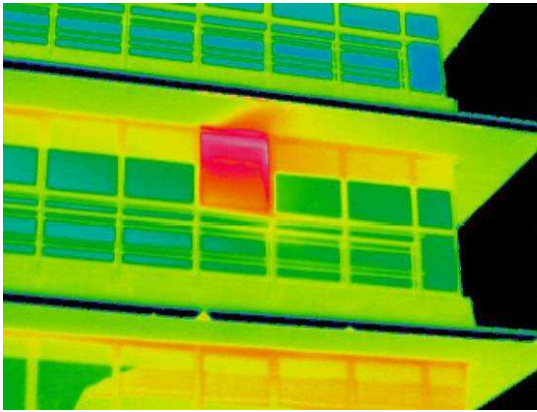

These thermographic pictures were shot in winter 2008 during work time; the sun light acts as a disturbance on the output of the instrument: the indicated temperatures are therefore affected by major errors, and should be used for qualitative analyses only. The thermographic pictures show some windows opened during winter season. The heat losses are clearly visible. Better control of zone temperature could avoid inconvenient windows openings.

HVACs' system components

The system is centralized. The main plant comprises a cogeneration unit, consisting of a gas fired IC engine providing 960 kW of electric output and 1168 kW of thermal output, and three gas fired hot water boilers, two of which rated at 2600 kW and one rated at 895 kW. The hot water produced by the central plant is used both for the ATC office building and for a district heating network serving the nearby "Arquata" quarter (505 apartments, 80'000 m³ heated volume). The circuit is hydraulically disconnected by two heat exchangers. One heat exchanger, rated at 1000 kW, serves the ATC building, while the other one, rated at 3000 kW, serves the Arquata district heating network. The hot water on the primary circuit is circulated by 2 x 15 kW pumps. The secondary circuit of the ATC building comprises a main collector. From the collector the hot water is circulated by 11 pumps, serving distinct zones:

- 2 X KSB Rio 50-100 D rated at 0,45 kW each (meeting room)
- 2 X KSB Etabloc 80-160 rated at 2,2 kW each (conference room)
- 4 X KSB Etabloc 50-250 rated at 4 kW each (fan coils)
- 3 X KSB Etabloc 50-200 rated at 2,2 kW each (radiators)

The pumps for the horizontal circulation for district heating are 3 x KSB Etaline HDX 150-200 rated at 15 kW; each condominium served has a sub station with dedicated pumping devices.

Two cold generators are present. The first is a Trane RTWB 214 (screw) rated at 400 kW cooling capacity, with a maximum electrical input of 91 kW. The second is an absorption Broad BDH 20 unit that was installed in June 2008, rated at 195 kW cooling, with a maximum electrical consumption of 1.8 kW; thermal input to the absorption chiller is given by heat recovered from the cogeneration plant. The condensing circuits of the two units are connected to underground well. Water from the well is pumped by submersed pumps:

- 2 X KSB UPA 150 S 65/7 rated at 15 kW each
- 2 X KSB UPA 150 S 65/9 rated at 18.5 kW each

Finally, one pump KSB Trieline 100-170 rated at 3 kW serves the condensing circuits, while four pumps KSB 80-210 (3 kW each) feed the evaporators.

The building has an electrical consumption metering system that was installed within the EU funded Policity project, in which POLITO is also involved; aim of the project is the detailed analysis of electrical energy consumption of buildings.

This means that the metering currently available is:

- Main electrical incomer
- Global electrical consumption of the central cooling plant
- CHP electrical production

- Electric chiller consumption
- Total cooling production (absorption + electric chiller)

The system has a BMS operated via the BacNet protocol. This enables data to be stored on the outstations for items such as external temperature and RH, internal temperature and RH, etc. This data are available since March 2008.

The Case Study considers each of the components of the system individually in the following order and which of the zones are served with each system:

- Heating systems
- Cooling systems
- Heat rejection and pumps
- CHP system

All water system

In the scheme below a particular of the water distribution system. Each sub system has a duplicated pump.

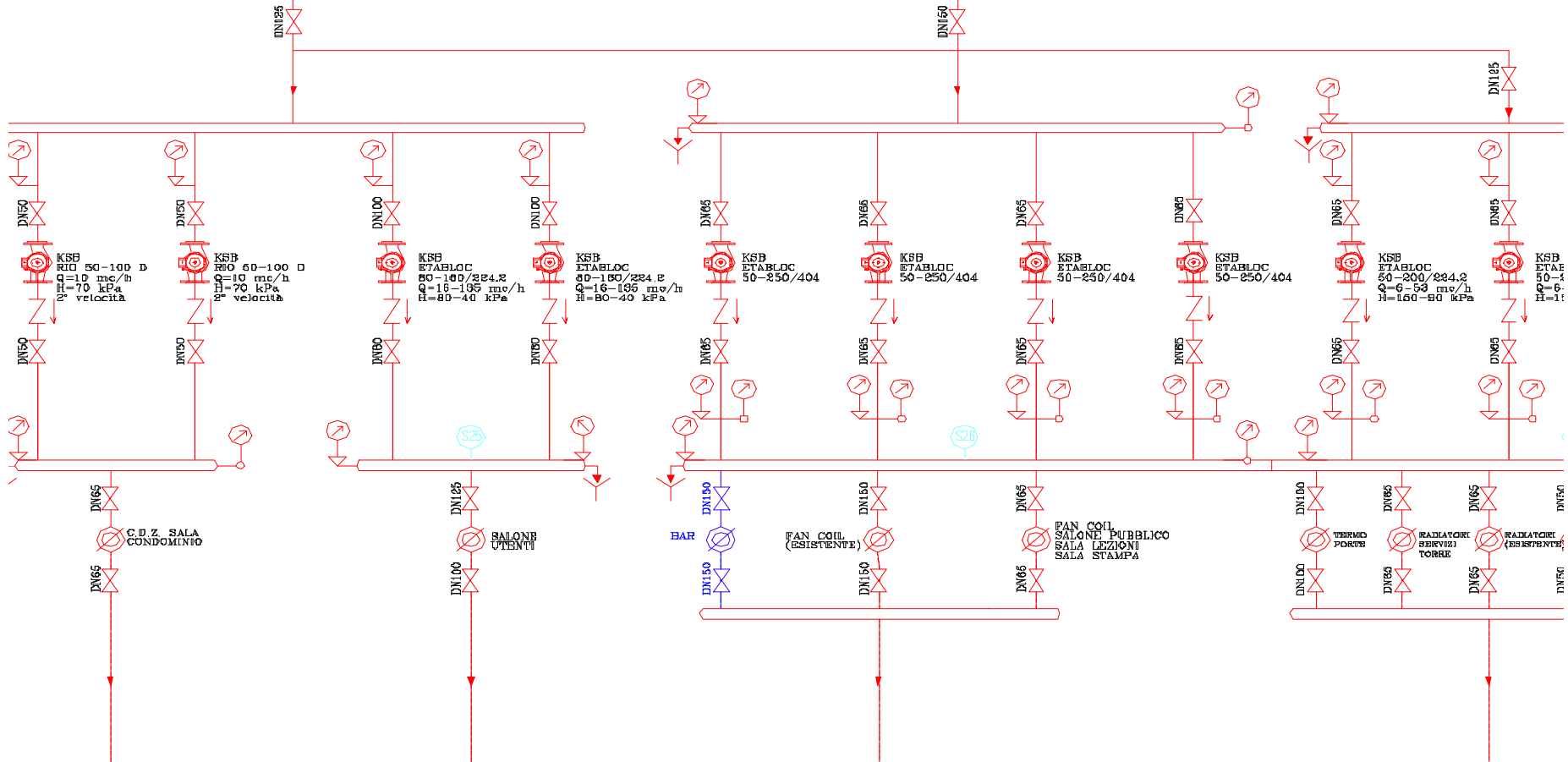

H

eat Generator Boiler and Pumps

Boiler Identification (X2)

Manufacture/Model	Viessman / Vitomax 200
Year	2004
Equipment Type	condensing boiler
Fuel Type	Natural gas

Performance Data

Nominal Heating Capacity [kW]	2600
Installed Heating Capacity /m ² GIA	N.A.
Nominal Efficiency [%]	90
Water outlet temperature [°C]	90
Water inlet temperature [°C]	65

Electrical data

Power supply [V/Ph/Hz]	400/3/50
Start-up amps [A]	



Auxiliary Equipment

Pumps Electric Demand [kW]	
Other	/



Monitoring observations

Inspection	
Maintenance status	Satisfactory
Previous inspection/maintenance Reports	Yes Data of last: monthly
Operation time estimated [h]	10000 (since installation)
Operating mode	Automatic
Dirtiness of burner	No
Thermal Insulation (Visual)	Satisfactory (except for some pipes)
Fuel leaks	No
Water leaks	No
Pressure status	Satisfactory
Sensors calibration records	No
Meter readings data	overall monthly gas consumption

Thermal image of the boiler confirm the good state of the shell.

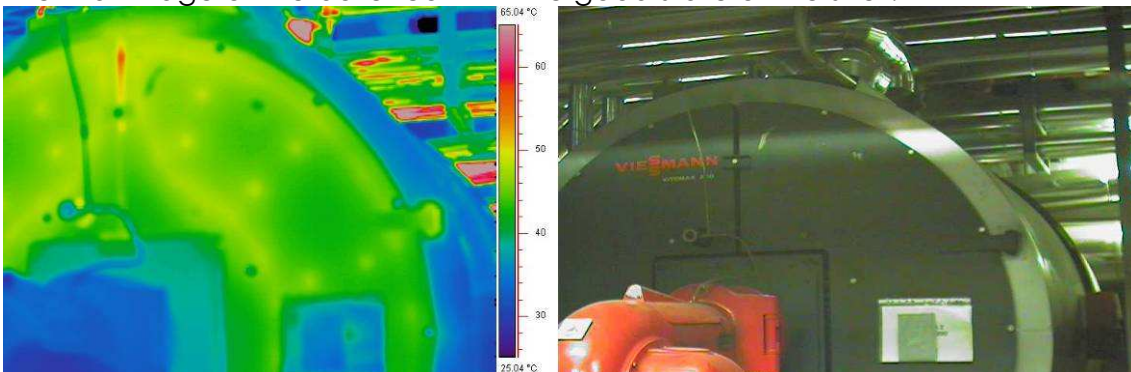

Damaged insulation of hot water collector

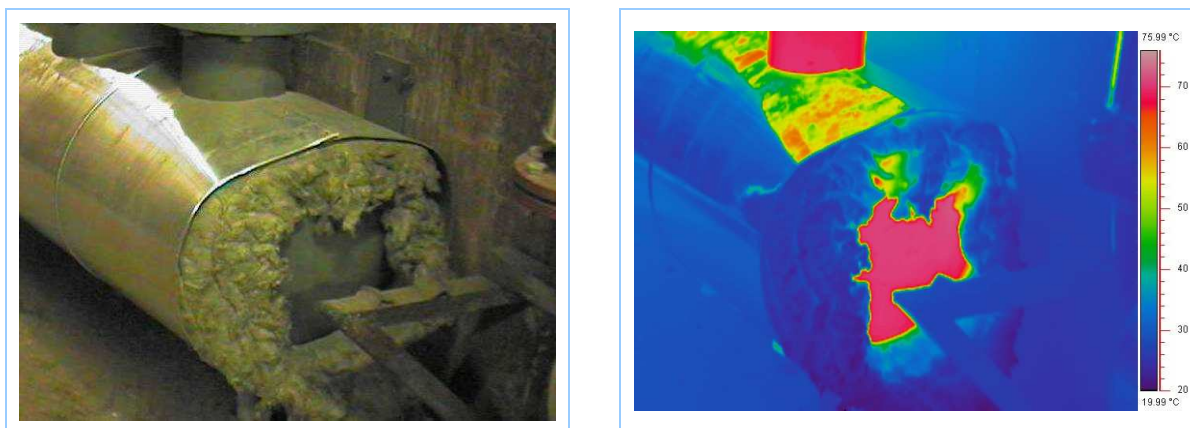

Some hot water circuit show excessive pressure loss



Some pipes of the primary and secondary circuits show insufficient insulation, especially close to motorized valves. Photos below show the main collector of hot water and heat exchanger.

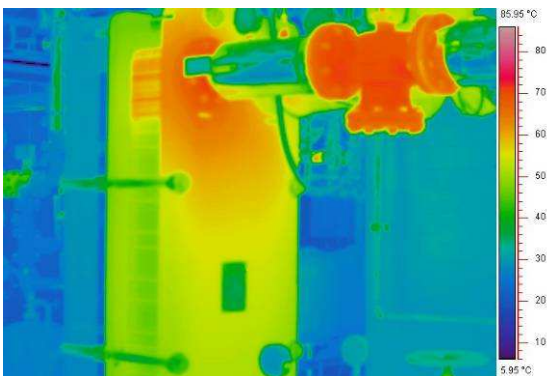
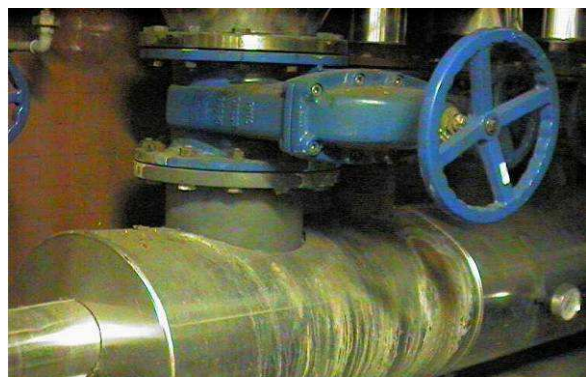
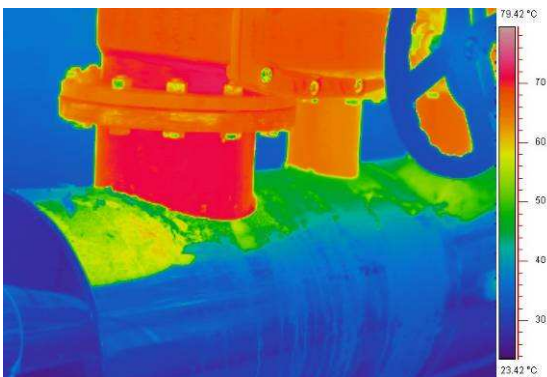
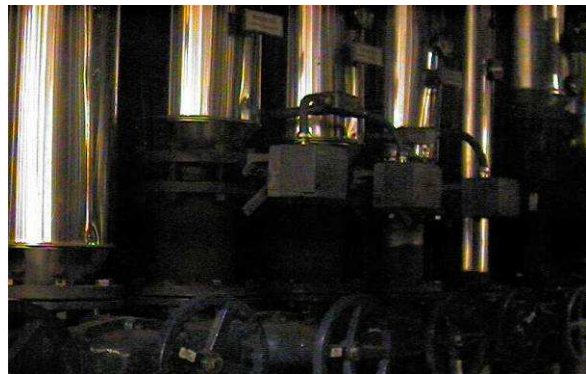
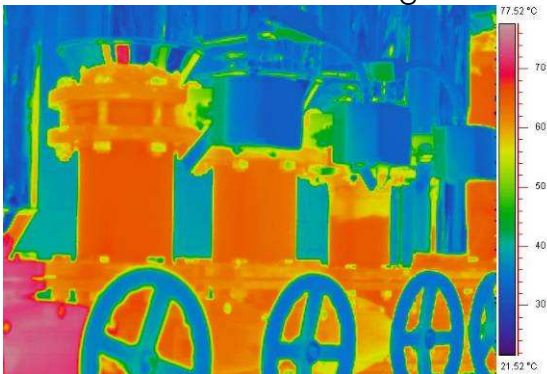

H

eat Generator CHP

CHP Identification

Manufacture/Model	Deutz
Year	2006
Equipment Type	CHP
Fuel Type	NG

Performance Data

Nominal Heating Capacity [kW]	1168
Installed Heating Capacity /m ² GIA	181.4
Nominal Efficiency [%]	
Water outlet temperature [°C]	90
Water inlet temperature [°C]	75



Auxiliary Equipment

Fan Electrical Demand [kW]	5
----------------------------	---



Monitoring observations

Inspection	
Maintenance status	Satisfactory
Previous inspection/maintenance Reports	Yes Data of last: March 2009
Operation time estimated [h]	4794 (year)
Operating mode	Automatic
Fuel leaks	No
Water leaks	No
Pressure status	Satisfactory
Sensors calibration records	No
Meter readings data	Yes

Field measurements	
Electricity production [kWh]	380'000 (monthly average)
Fossil fuels consumption [kWh]	980'000 (monthly average)
Electric voltage [V]	380

Cold Generator

Chiller Identification

Manufacture/Model	Trane RTWB 214
Year	2004
System Type	Water
Compressor Type	Screw
Fuel Type	el.ener gy

Performance Data

Nominal Cooling Capacity [kW]	400
Installed Cooling Capacity W/m ² GIA	82.6
Nominal Electric Power [kW]	91
COP/EER (Eurovent) SEER	4.4
Refrigerant Gas	R134a

Electrical data

Power supply [V/Ph/Hz]	380/3/50
Start-up amps [A]	332

Auxiliary Equipment

Fan Electrical Demand [kW]	N.I.
Pumps Electric Demand [kW]	2 X 3

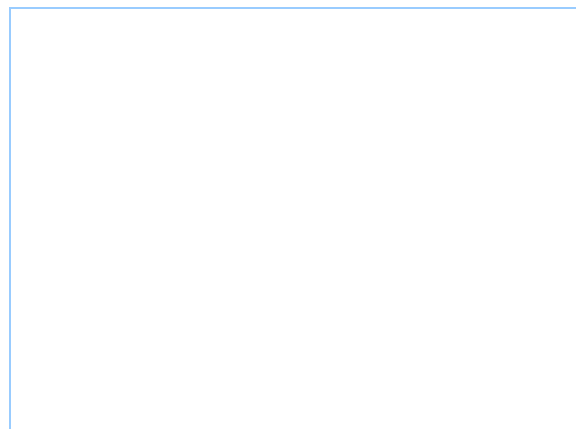
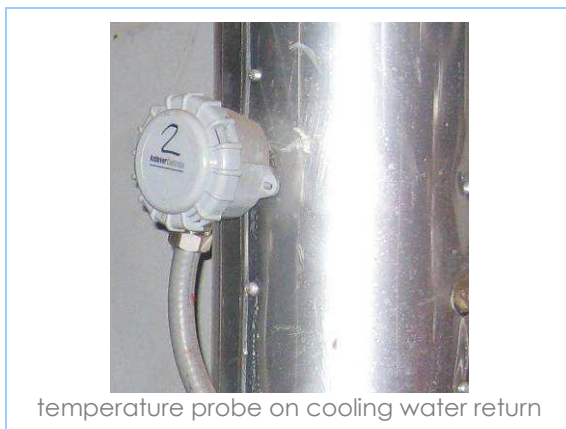

Monitoring observations

Inspection	
Maintenance status	Satisfactory
Previous inspection/maintenance Reports	No
Operation time estimated [h]	760
Operating mode	automatic
Thermal Insulation (Visual)	Satisfactory
Vibration eliminators	Satisfactory
Worn couplings	Satisfactory
Equipment cleanliness	Satisfactory
Compressor oil level	Satisfactory
Compressor oil pressure	Satisfactory
Refrigerant temperature	Satisfactory
Refrigerant pressure	Satisfactory
Chilled water systems leaks	Yes (minor)
Sensors calibration records	No
Refrigerant leaks	No
Location of the equipment	Indoor

Field measurements	
Electricity consumption [kWh]	73'200 (2008)
Electric voltage [V]	381
Electric current [A]	320



Water leaks pictures



Expansion valves

Cold Generator

Chiller Identification

Manufacture/Model	Broad BDH 20
Year	2008
System Type	Absorption

Performance Data

Nominal Cooling Capacity [kW]	195
Installed Cooling Capacity W/m ² GIA	40.3
Nominal Electric Power [kW]	1.8
COP	0.78
Solution	LiBr

Electrical data

Power supply [V/Ph/Hz]	380/3/50
Start-up amps [A]	5

Auxiliary Equipment

Fan Electrical Demand [kW]	N.I.
Pumps Electric Demand [kW]	2 X 3



Monitoring observations

Inspection	
Maintenance status	Satisfactory
Previous inspection/maintenance Reports	No
Operation time estimated [h]	700
Operating mode	automatic
Thermal Insulation (Visual)	Satisfactory
Vibration eliminators	Satisfactory
Worn couplings	Satisfactory
Equipment cleanliness	Satisfactory
Compressor oil level	N.A.
Compressor oil pressure	N.A.
Refrigerant temperature	Satisfactory
Refrigerant pressure	Satisfactory
Chilled water systems leaks	No
Sensors calibration records	No
Refrigerant leaks	No
Location of the equipment	Indoor

Field measurements	
Electricity consumption [kWh]	N.A.
Electric voltage [V]	381
Electric current [A]	3

E

nergy consumption data

Metering information

This section shows how the metering was arranged in the Case Study. The meters monitored the energy consumption of the various parts of the HVAC system, along with other building related consumptions and data, at 15 minute intervals. The metering is carried out in accordance to Policity project. In the framework of the Policity project sensors was installed and readings stored in the last two years. The information available is summarized in the table below:

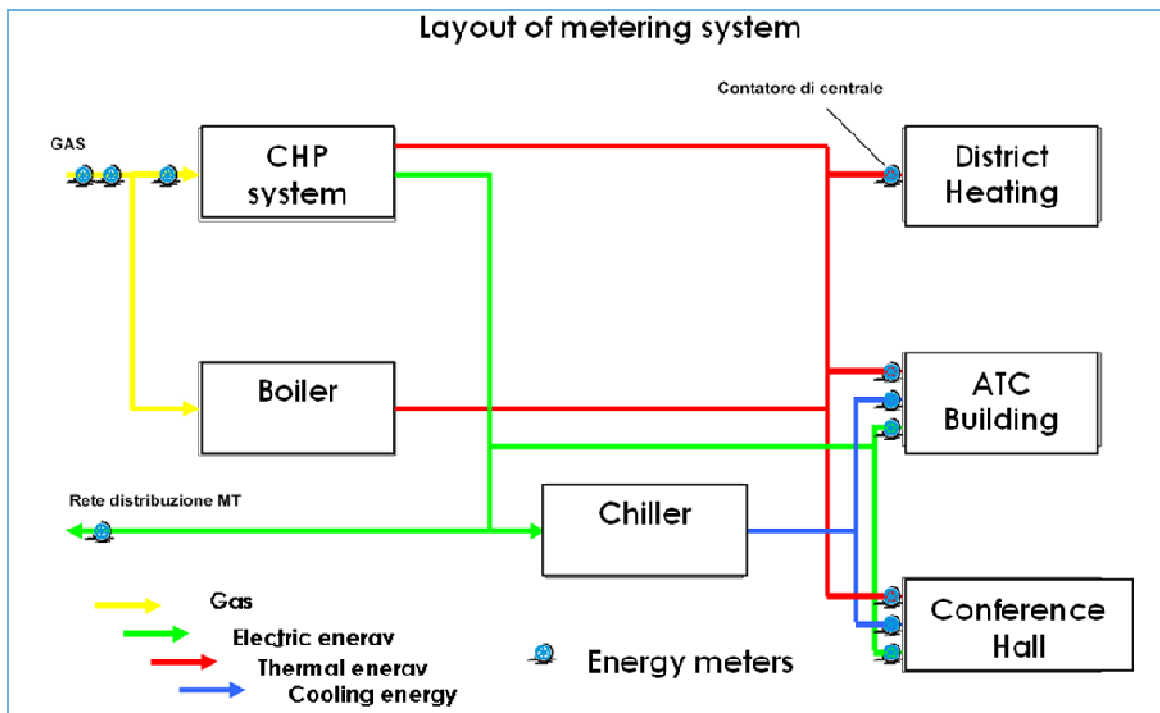

Monitoring observations

Heating [kWh]

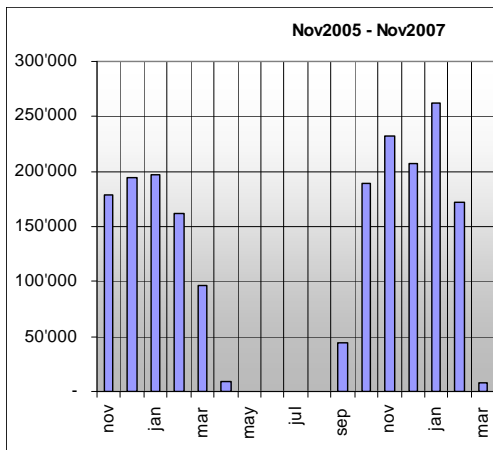

Cooling el. consumption [MWh]

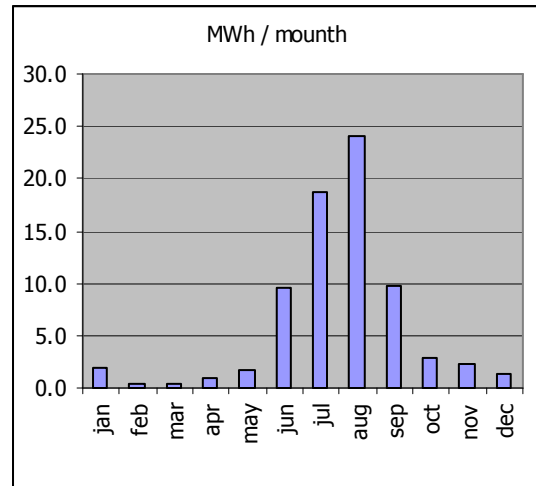

Electricity [MWh/month]

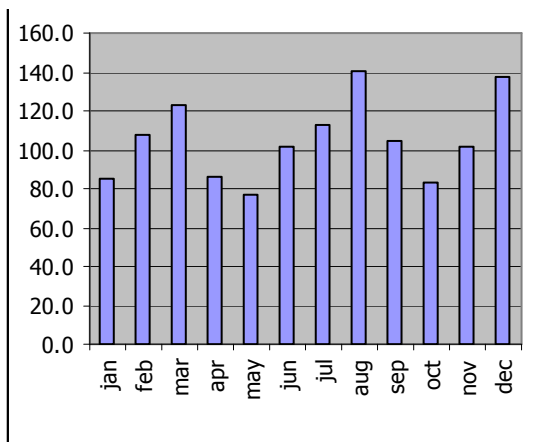

Cooling power [MWh/month]

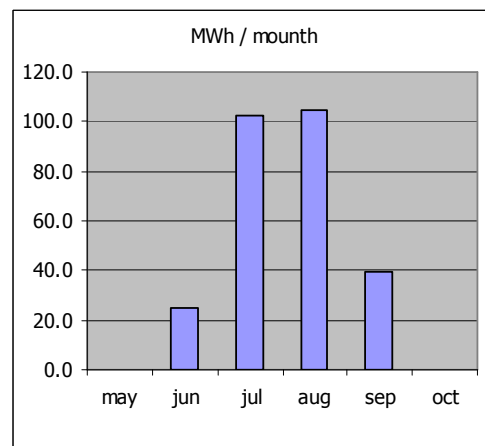

Monitoring cooling station

Consumption analysis was focused on electric consumption of cooling station. This consumption comprises one electric chiller, one absorption chiller, one pump for the condensing circuits (3 kW), and four pumps for evaporators circuit (3 kW each). In the image below the schematic plant view of cooling station is shown.

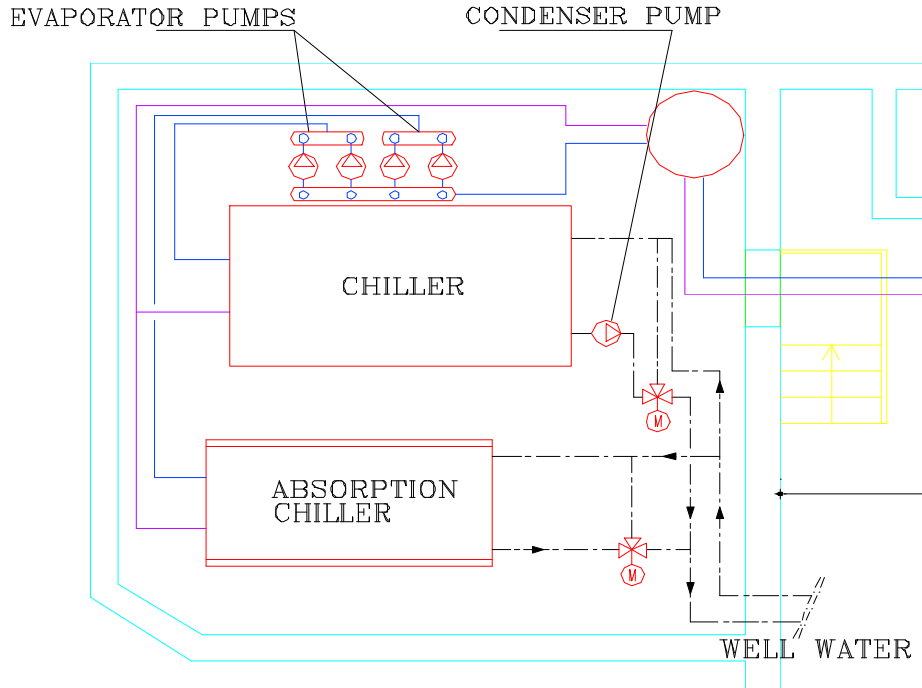

The analysis of electrical consumption over 2008 summer season shows a distributed load (due to circulation pumps) with some peaks of consumption (due to the electric chiller operation). At the end of the season, the fact that the electric chiller was almost always off is particularly appreciable. The absorption chiller was sufficient to provide cooling power. The operation schedule was five days per week (with some exceptions on Saturday) from 6:00 to 18:00. By the middle of July the peak consumption was deeply reduced; in fact on the 15 July the absorption chiller was operative, as seen in the graph below. The new schedule of the electric chiller seems from 7:00 to 17:00.

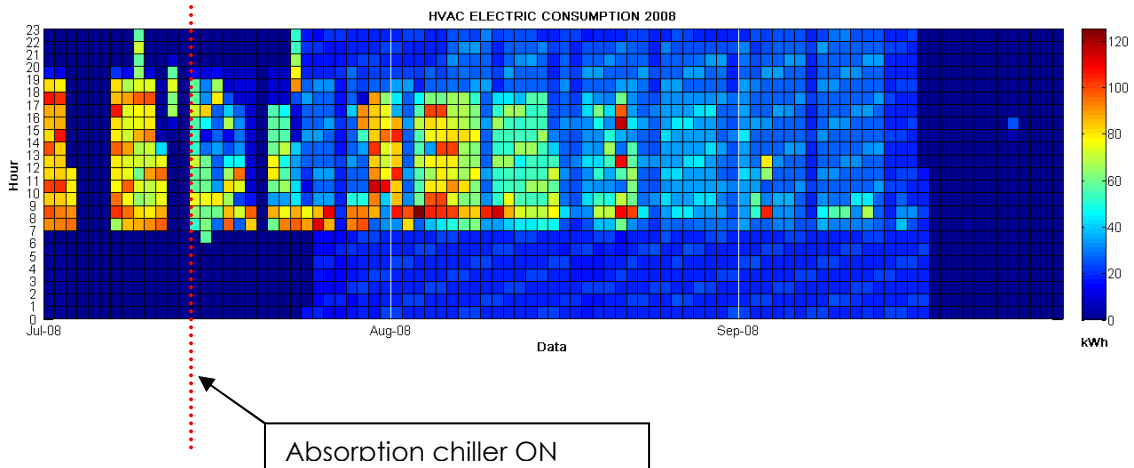

During the 2009 summer season a similar operation strategy for the cooling station was expected. The 2009 season was characterized by mean temperatures higher than 2008, as seen in the **Environment parameters** section. The graph of hourly consumption shows higher loads during the whole day; moreover the time schedule appears to be changed. From the graph we can identify this schedule: Mon-Fri 4:00-16:00. The operation hours during the day were increased (12 hours, instead of the 10 hours of 2008).

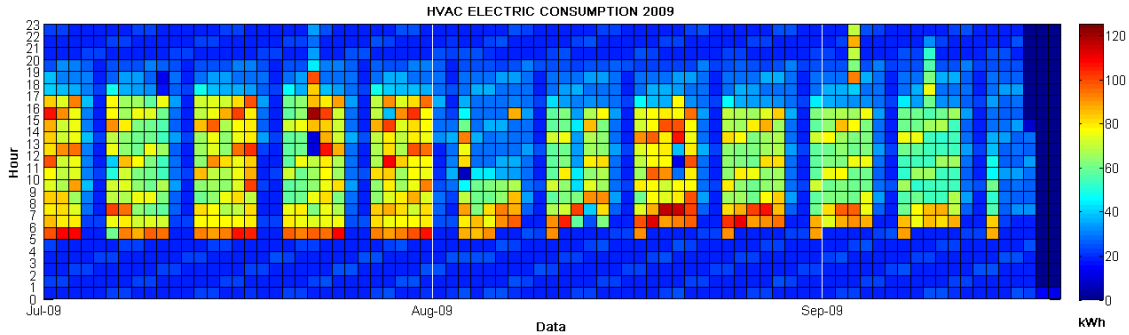

The climatic conditions are always the major cause for higher consumption, nevertheless in this case study the higher consumption was due to different schedule. The difference between 2008 and 2009 season was high, almost 50 % more on the overall summer season.

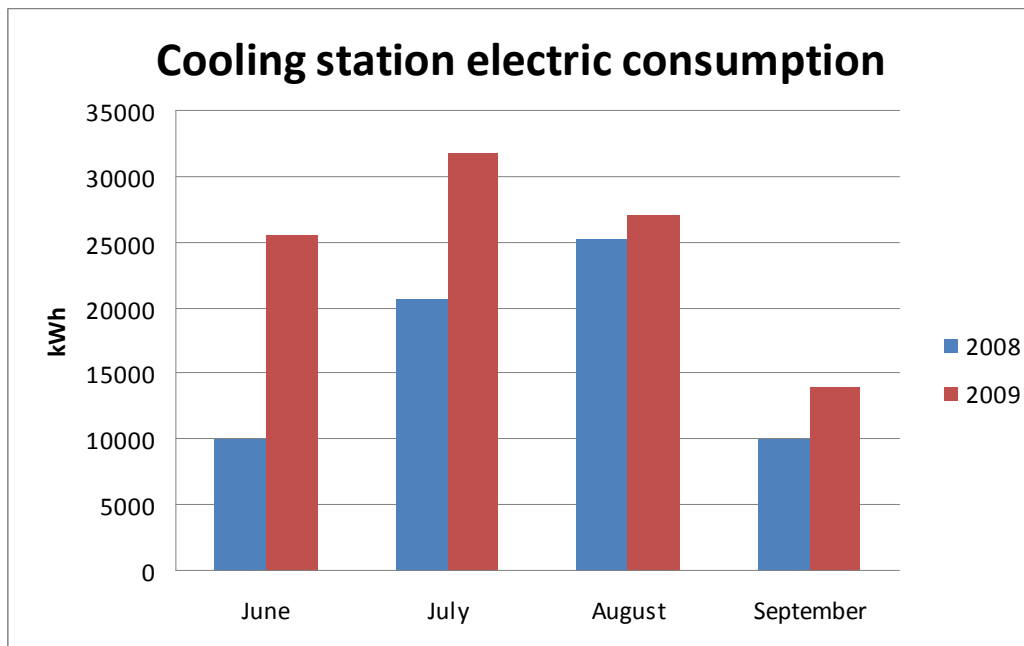

To analyze the cooling station electrical consumption, two weeks with similar average external temperature were chosen. In the graph below the daily cooling station consumption for the considered week is shown:

- 28 July - 03 August for 2008 season
- 13 July - 19 July for 2009 season

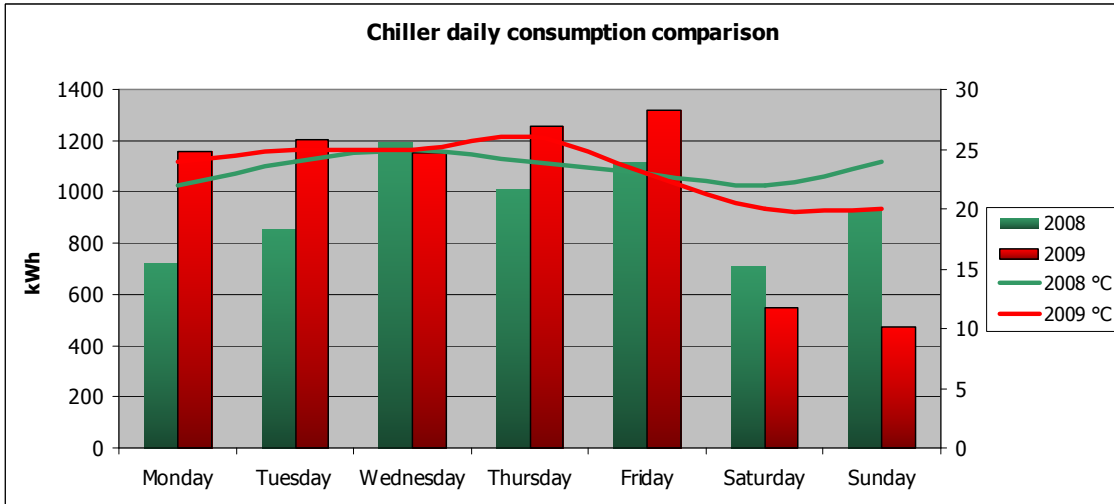

Analyzing the hourly consumption on Monday, the different schedules should be appreciated. As seen in the graph below, there is a common base load consumption due to the pumps, ranging between 18 and 22 kW. In 2008, between 6:00 and 7:00, the input increase to 35 kW: it implies that around this hour the electric chiller starts to operate at minimum load. Between 9:00 to 10:00 a peak consumption appears, due to almost full load of the electric chiller. In 2009 the chiller starts at 4:00 at full load.

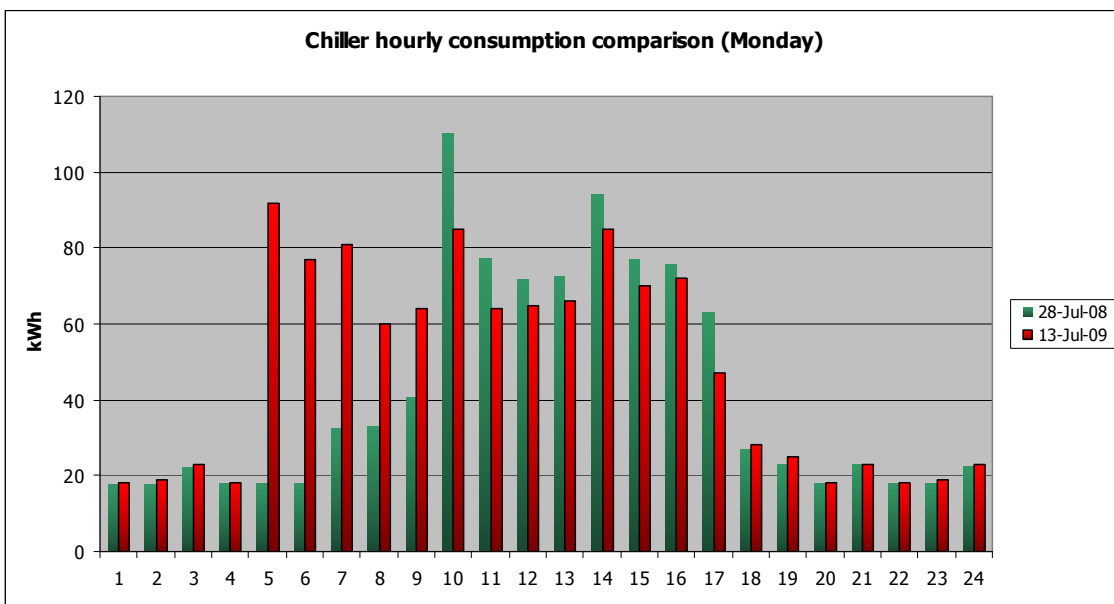

Similar considerations should be made for Wednesday consumption, as seen in the graph below. Notice that on 30 July 2008 and 15 July 2009 the external daily average temperature was the same. Considering those two days, in occupation hour, the consumption of 2009 almost doubled that of 2008

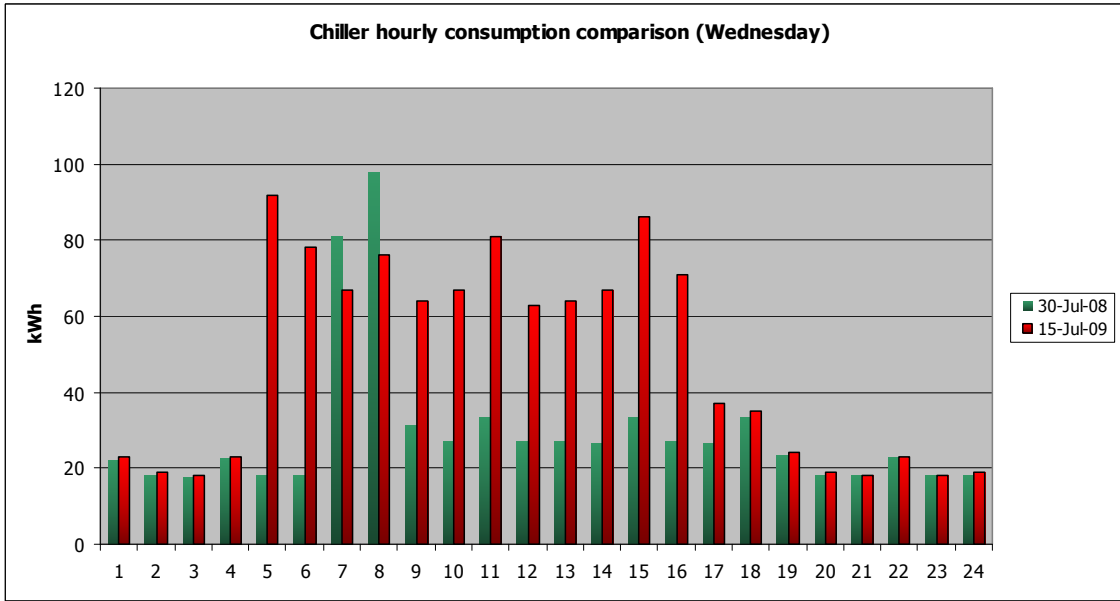

To compare the system performance as a function of external temperature during 2008 and 2009, the linear regression technique was used. In the graph below the energy signature for work days is given. It clearly appears that in 2009 the system was consuming more electric energy than in 2008, even at the same average external temperature.

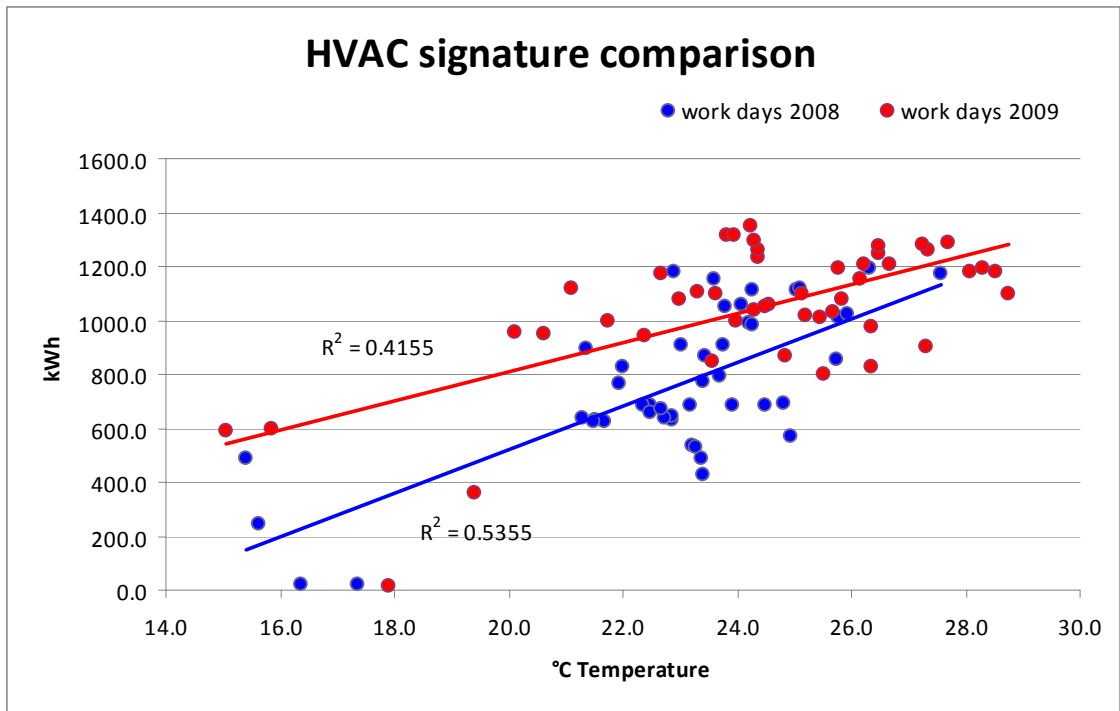

Talking with the building owner and with the Energy Manager, further information was obtained:

1. In October 2008 the HVAC system manager was changed
2. During spring/summer 2009 the glazed façade on north side of the building was replaced: the original double glazed windows were replaced by 4 glass low emissivity windows.

Considering such information and the overall consumption of 2009 summer season, it should be concluded that something in the process was not functioning as expected.

On one side, the sealing of north façade with almost zero permeability windows, decrease the heating energy request in winter, while increase the cooling request in summer. This is due to the drastic reduction of thermal and air exchanges during summer night, when the air temperature inside the building is higher than external temperature.

On the other side, the new HVAC system manager has less knowledge about the system, so he decided the temperature and schedule set point with a big safety margin. This is clearly visible in the carpet plot. In 2009 the system was always started 2-3 hours earlier with respect of 2008. This implies the working of electric chiller alone (the absorber chiller is always turned on with the CHP system, after 8:00 AM), and so a higher consumption of the whole system.

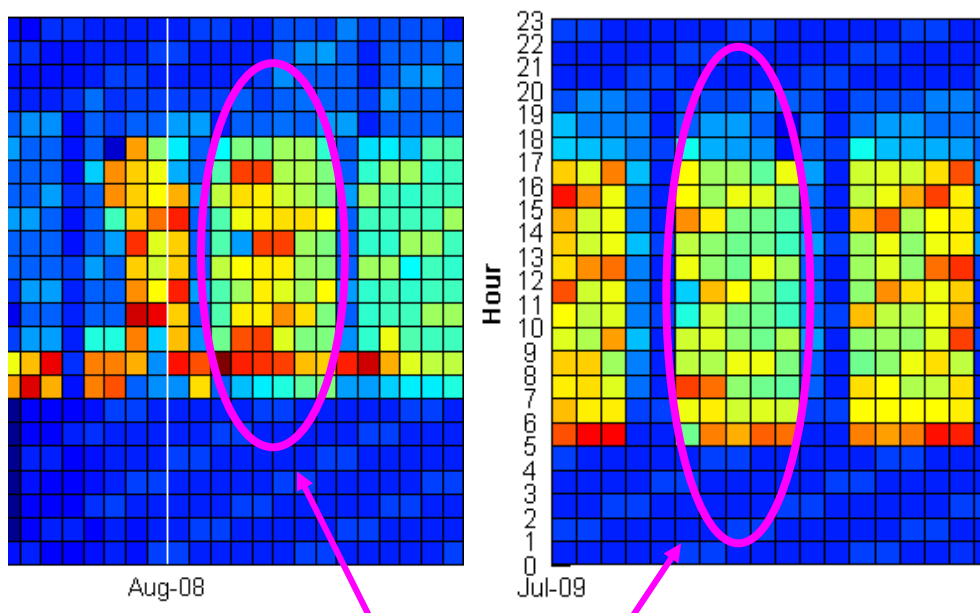

The operational hours are more in 2009, almost 2 hours per day

Timing table for first inspection

Inspection Item	Short Description	Time (mins)	Savings	Notes
PI1	Location and number of AC zones	20		
PI2	Documentation per zone	40		
PI3	Images of zones/building	15		
PI4	General zone data/zone	14		
PI5	Construction details/zone	17		
PI6	Building mass/air tightness per zone	15		
PI7	Occupancy schedules per zone	8		
PI8	Monthly schedule exceptions per zone	2		
PI9	HVAC system description and operating setpoints per zone	35		
PI10	Original design conditions per zone	30		
PI11	Current design loads per zone	28		
PI12	Power/energy information per zone	10		
PI13	Source of heating supplying each zone	4		
PI14	Heating storage and control for each zone	15		
PI15	Refrigeration equipment for each zone	15		
PI16	AHU for each zone	5		
PI17	Cooling distribution fluid details per zone	10		
PI18	Cooling terminal units details in each zone	10		
PI19	Energy supply to the system	1		
PI20	Energy supply to the building	1		
PI21	Annual energy consumption of the system	35		The Building is provided with a complete monitoring system, that allows to obtain data about electrical consumption
PI22	Annual energy consumption of the building	25		The Building is provided with a complete monitoring system, that allows to obtain data about electrical consumption
	TOTAL TIME TAKEN (minutes)	355		
	TOTAL (seconds/m²)	3.31	Area (m ²)	6440

Centralised system inspection data

Inspection Item	Short Description	Time (mins)	Savings	Notes
PC1	Details of installed refrigeration plant	25		
PC2	Description of system control zones, with schematic drawings.	15		
PC3	Description of method of control of temperature.	15		
PC4	Description of method of control of periods of operation.	2		
PC5	Floor plans, and schematics of air conditioning systems.	16		
PC6	Reports from earlier AC inspections and EPC's	0		not available
PC7	Records of maintenance operations on refrigeration systems	4		
PC8	Records of maintenance operations on air delivery systems.	4		
PC9	Records of maintenance operations on control systems and sensors	0		not available
PC10	Records of sub-metered AC plant use or energy consumption.	15		Advanced BMS
PC11	Commissioning results where relevant	0		not available
PC12	An estimate of the design cooling load for each system	45		
PC13	Records of issues or complaints concerning indoor comfort conditions	0		not available
PC14	Use of BMS	14		
PC15	Monitoring to continually observe performance of AC systems			
C1	Locate relevant plant and compare details	35		
C2	Locate supply the A/C system and install VA logger(s)	160		
C3	Review current inspection and maintenance regime	5		
C4	Compare system size with imposed cooling loads	5		
C5	Estimate Specific Fan Power of relevant air movement systems	4		on label data
C6	Compare AC usage with expected hours or energy use	25		compare mesures of BMS with expected occupancy
C7	Locate refrigeration plant and check operation	10		
C8	Visual appearance of refrigeration plant and immediate area	3		
C9	Check refrigeration plant is capable of providing cooling	5		
C10	Check type, rating and operation of distribution fans and pumps	10		already done in C1
C11	Visually check condition/operation of outdoor heat rejection units	15		

C12	Check for obstructions through heat rejection heat exchangers	10		
C13	Check for signs of refrigerant leakage	9		3 units
C14	Check for the correct rotation of fans	0		not possible
C15	Visually check the condition and operation of indoor units	90		10 min per floor
C16	Check air inlets and outlets for obstruction	20		in addition to C15
C17	Check for obstructions to airflow through the heat exchangers	20		in addition to C15
C18	Check condition of intake air filters.	10		in addition to C15
C19	Check for signs of refrigerant leakage.	10		in addition to C15
C20	Check for the correct rotation of fans	30		in addition to C15
C21	Review air delivery and extract routes from spaces	15		in addition to C15
C22	Review any occupant complaints	0		not available
C23	Assess air supply openings in relation to extract openings.	15		The building has only 2 little UTA for canteen and conference room
C24	Assess the controllability of a sample number of terminal units	20		
C25	Check filter changing or cleaning frequency.	8		
C26	Assess the current state of cleanliness or blockage of filters.	4		
C27	Note the condition of filter differential pressure gauge.	2		
C28	Assess the fit and sealing of filters and housings.	3		
C29	Examine heat exchangers for damage or significant blockage	2		
C30	Examine refrigeration heat exchangers for signs of leakage	2		
C31	Note fan type and method of air speed control	2		
C32	Check for obstructions to inlet grilles, screens and pre-filters.	4		
C33	Check location of inlets for proximity to sources of heat	2		
C34	Assess zoning in relation to internal gain and solar radiation.	15		
C35	Note current time on controllers against the actual time	10		
C36	Note the set on and off periods	6		
C37	Identify zone heating and cooling temperature control sensors	5		per floor
C38	Note zone set temperatures relative to the activities and occupancy	13		per zone
C39	Check control basis to avoid simultaneous heating and cooling	6		
C40	Assess the refrigeration compressor(s) and capacity control	210		with climacheck

C41	Assess control of air flow rate through air supply and exhaust ducts	15		with measurement of air flow at the first and the last of each air channel. The building has only 2 little UTA for canteen and conference room
C42	Assess control of ancillary system components e.g. pumps and fans	10		
C43	Assess how reheat is achieved, particularly in the morning	0		not available
C44	Check actual control basis of system	8		
TOTAL TIME TAKEN (minutes)		1'008		
TOTAL (seconds/m²)		9.39	Area (m ²)	6440

M Main Eco's identified

ECO CODE	DESCRIPTION	ACTION	Saving
E2.4	Correct excessive envelope air leakage	partially windows substitution	-0.6-4% of HVAC consumption in summer -1.5-7.3% of heat consumption in winter
E2.6	Apply night time over ventilation	users or automatic devices	1.5-5% of summer HVAC consumption
E3.1	Upgrade insulation of flat roofs externally	roof insulation	-0.6 on summer HVAC consumption
E3.7	Locate and minimize the effect of thermal bridges	already applied, insulation of overhangs	11.5% on heating energy in winter
E3.9	Use double or triple glaze replacement	partially applied, spot measurements	24.17% on heating energy in winter
P2.12	Consider the possibility of using waste heat for absorption system	applied with CHP, measured by BMS	Value dramatically different between simulation and measurement

ECO E 2.6, Apply night time over ventilation

The analysis of the electric chiller consumption during work days shows that the system operation starts at 8:00 AM. In the first hours of operation the consumption is higher: the system has to reach the set point temperature, after being off for the whole night. If night time over ventilation was provided, the refrigeration power in the first hours of the morning would be lowered.

In the further tables the ECO assessment is resumed:

Chiller Consumption

2008 07 June-16 sept	73'204 kWh
2009 19 May-17 sept	111'021 kWh

Chiller consumption in summer, aggregated by hour

	2008	2009
8:00-		
9:00	5'496	6'937 kWh
9:00:10:00	4'227	6'508 kWh
10:00-11:00	4'058	5'917 kWh

We assume that, in presence of night time over ventilation, the hourly consumption between 8:00 and 10:00 in the morning should be equal to consumption between 10:00 and 11:00. According to this calculation the potential savings are estimated in 1.45-2.19% of chiller annual consumption.

	2008	2009	
Potential saving	1'606	1'611	kWh
	2.19%	1.45%	

POLITO CS-ATC HVAC System Consumption, 8:00-11:00 , Work day

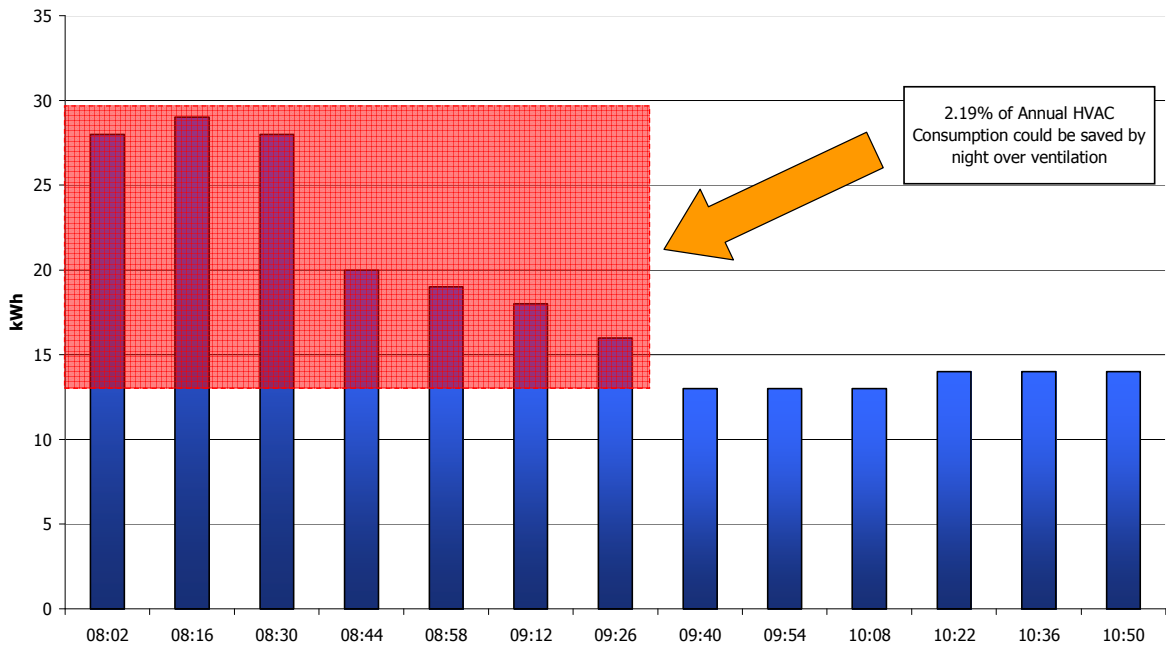

The calculation method most likely underestimates the potential saving, because in the first hours of the day the sun radiation and internal load are less intense than at 11:00. For this reason potential saving could be at least equal to 5% of chiller consumption.

ECO P 2.12, Consider the possibility of using waste heat for absorption system

The system analyzed already had an absorption chiller. This unit was 10 years old and was replaced in summer 2008 by a new unit. Economic and energy analysis was provided. The cooling load was monitored by Policity sensors, as seen in the graph below.

Cooling load of ATC (kWh)

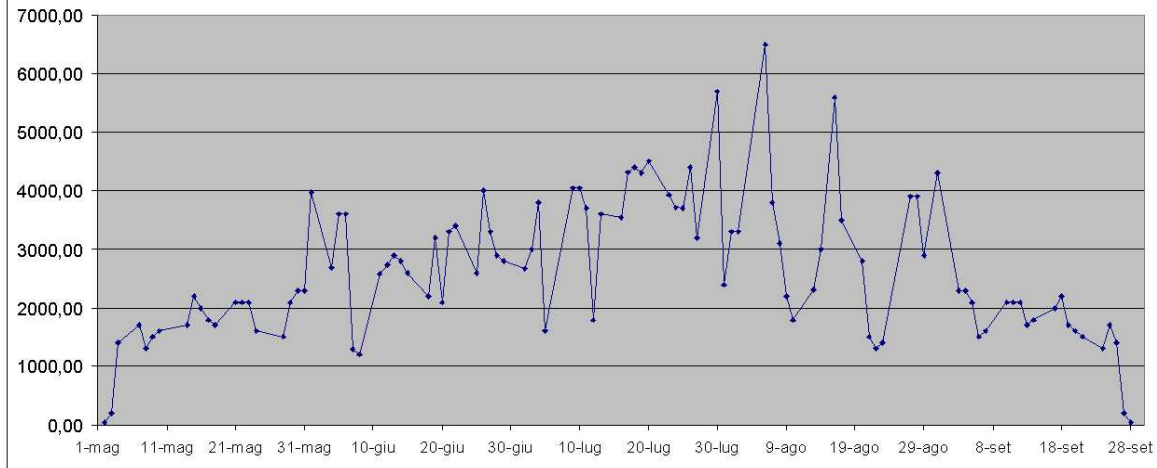

The analysis assumes that the waste heat from CHP system should be directed to an absorption chiller. The base cooling load is then provided by the absorption unit, while the peak load is provided by the existent electric chiller; the graph below shows the load subdivision between the two chillers.

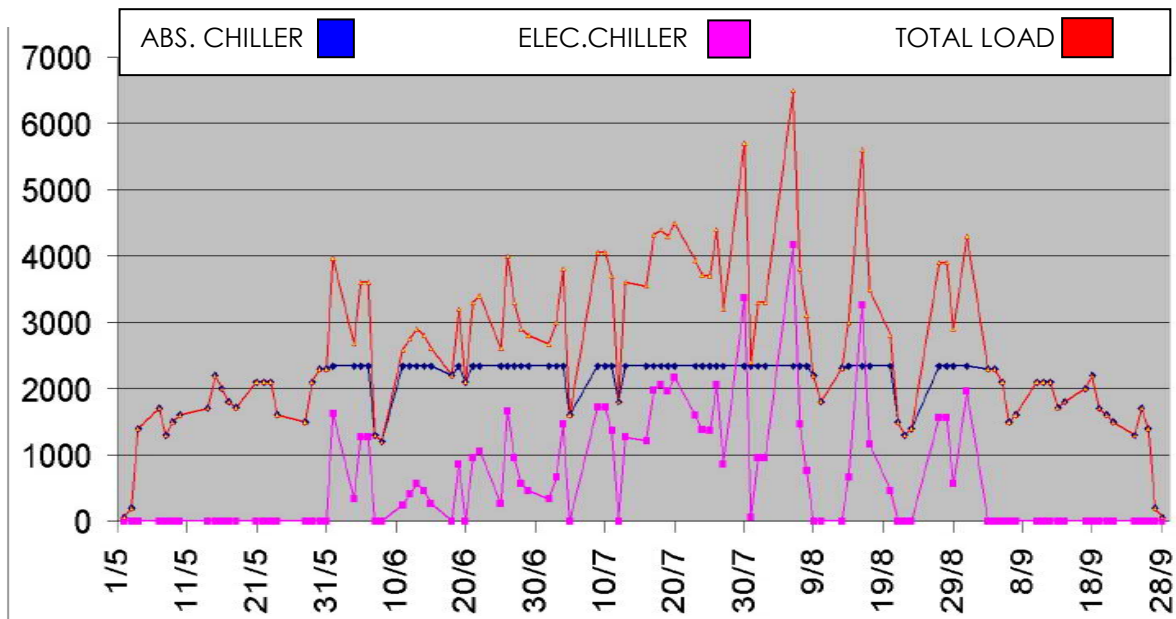

With this hypothesis, the electric chiller is turned on just on the hottest day of the summer season. The graph below shows the ideal operation load for the two units during the hot season. RTWB represents the electric chiller, while BDH represents the absorption unit.

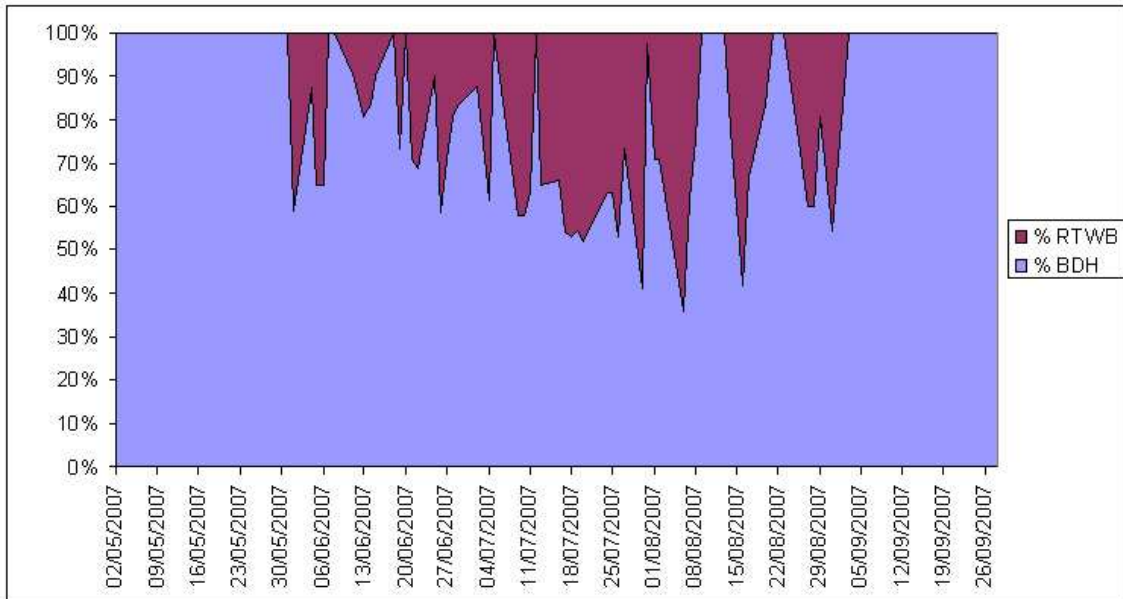

As seen in the graph, the electric chiller ideally works for a limited amount of time, and it can be turned on just from June until the end of August.

Under this hypothesis the payback time for the considered unit was estimated in 9 years, and the saving on electric consumption of the chiller was estimated in 75.5%.

The unit was installed and started for the first time in July 2008 and became fully operative in August 2008. Measurements during summer season permit real quantifying of this ECO.

month	Electric Consumption MWh	Cooling energy delivered MWh	COP
Aug-07	17.8	60.41	3.4
Sep-07	12.1	33.31	2.8
Aug-08	26.0	104.8	4.0
Sep-08	9.7	39.4	4.0

The above table indicates that the COP of the system sensibly increased after the absorption chiller was operated. In the next table the consumption of Aug-Sep 2008 are compared with a hypothetical consumption of the same months without the absorption chiller installed. For this comparison we use the COP of 2007 season.

El. Consumption (MWh)	abs. Chiller	No abs. Chiller	%
Aug-08	26.0	30.8	15.7%
Sep-08	9.7	14.3	31.9%
Total	35.7	45.1	20.8%

The overall result is a 20.8% saving on total chiller electric consumption. This is a good operational result, but dramatically lower than the 75.5% assumed in the simulation.

The major explanation for the different values is that in current operation the absorption unit is not working as stated in the simulation. The nominal performance of the unit is calculated with inlet hot water at 90°C. In the ATC building the hot water to the absorption unit is provided by a combined heat and power system, an IC engine rated at 1 MW electric power.

The installation of CHP was previous to the installation of the chiller; its circuit was designed for a maximum temperature of 90°C. In operation, when the water temperature reaches 85°C, the system stops due to safety valves. For this reason the inlet water to the absorption unit is delivered at 83-84°C, and the COP of the unit is decreased.

Other reasons that affect the performance are that CHP unit is turned on, for cost reasons, just from 8:00 AM to 7:00 PM. Between this hour the electric energy produced by the CHP is sell at the maximum cost (peak hour). This implies that the absorption unit cannot be turned on before 8:00 AM. Moreover, the unit needs some time (almost one hour) to provide full performance.

E COs assessment with tools sensitivity analysis

To estimate the potential ECOs savings, a sensitivity analysis was run. The values of different parameters (listed below) was fixed at design value, then decreased (and increased): the results of different simulations was recorded. The following parameters were modified and taken into account into the simulation:

- Infiltration Rate
- Windows U-value
- Upgrade insulation of flat roofs externally
- Opaque Frontages U-value
- Replace lighting equipment with low consumption types
- Replace electrical equipment with Energy Star or low consumption types

A design point is set for each of them, and reasonable variations from this value are evaluated using the same basis for each of them, so that a consistent comparison could be done.

Infiltration Rate

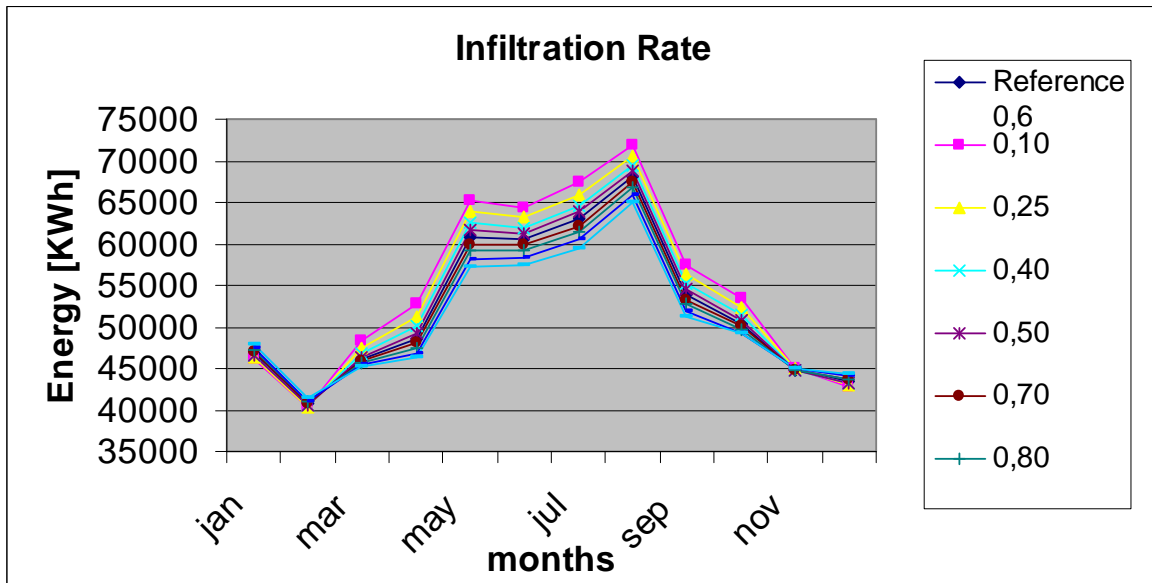

Difference %

	0,10	0,25	0,40	0,50	Reference 0,6	0,70	0,80	0,95	1,10
jan	1,59	1,28	0,76	0,42		-0,45	-0,86	-1,40	-2,05
feb	0,79	0,69	0,36	0,16		-0,23	-0,56	-1,06	-1,72
mar	-5,10	-2,97	-1,49	-0,56		0,48	0,86	1,36	1,69
apr	-8,40	-5,53	-2,94	-1,37		1,20	2,38	3,71	4,74
may	-7,35	-5,04	-2,82	-1,37		1,31	2,50	4,25	5,84
jun	-6,44	-4,36	-2,38	-1,16		1,06	2,10	3,57	5,03
jul	-7,00	-4,73	-2,59	-1,28		1,28	2,44	4,05	5,61
aug	-5,67	-3,79	-2,11	-1,03		0,99	1,93	3,26	4,51
sep	-6,73	-4,52	-2,54	-1,21		1,11	2,13	3,56	4,98
oct	-6,02	-3,66	-1,95	-0,93		0,76	1,46	2,16	2,56
nov	-0,77	-0,34	0,03	-0,02		-0,13	-0,20	-0,50	-0,82
dec	1,62	1,11	0,66	0,37		-0,33	-0,63	-1,26	-2,04
	-4,13	-2,65	-1,42	-0,66	mean	0,59	1,13	1,81	2,36

Energy consumption considerations

The electrical consumption has a significant variation; a further insight on the fuel consumption would be useful, in order to make an overall energy balance and draw meaningful conclusions on the results that could be expected by changing the infiltration rate on a real building.

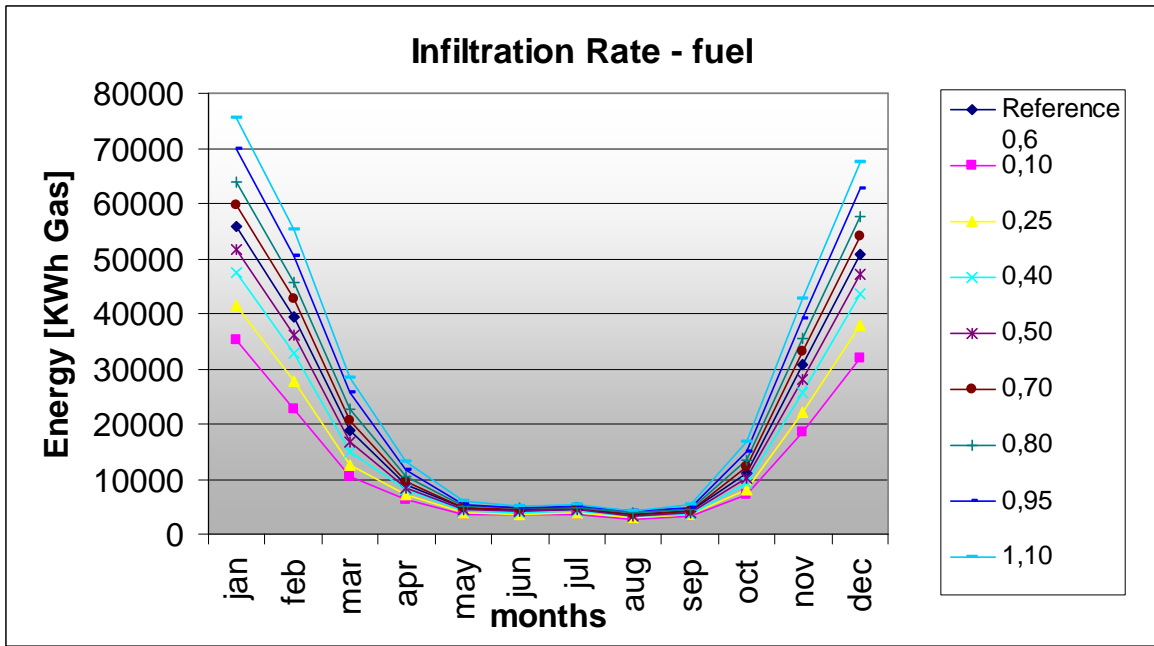

Balance

	0,10	0,25	0,40	0,50	Reference 0,6	0,70	0,80	0,95	1,10
jan	-21321,00	-15019,00	-8548,00	-4283,00		4279,00	8475,00	14644,00	20735,00
feb	-16928,00	-11834,00	-6635,00	-3268,00		3283,00	6598,00	11479,00	16445,00
mar	-5860,00	-4790,00	-2957,00	-1605,00		1712,00	3519,00	6249,00	9029,00
apr	1387,00	793,00	336,00	107,00		23,00	118,00	834,00	1856,00
may	3436,00	2337,00	1286,00	612,00		-577,00	-1075,00	-1763,00	-2306,00
jun	3060,00	2062,00	1109,00	530,00		-476,00	-930,00	-1560,00	-2190,00
jul	3472,00	2373,00	1298,00	639,00		-634,00	-1196,00	-1958,00	-2684,00
aug	3034,00	2005,00	1109,00	540,00		-514,00	-1001,00	-1676,00	-2296,00
sep	2714,00	1835,00	1029,00	481,00		-430,00	-761,00	-1111,00	-1358,00
oct	-918,00	-1127,00	-856,00	-492,00		683,00	1493,00	2908,00	4463,00
nov	-11720,00	-8369,00	-4909,00	-2436,00		2493,00	4954,00	8687,00	12399,00
dec	-19433,00	-13290,00	-7474,00	-3724,00		3622,00	7126,00	12404,00	17769,00
	-59077,0	-43024,0	-25212,0	-12899,0	sum	13464,0	27320,0	49137,0	71862,0
	-7,35	-5,25	-3,01	-1,52	sum %	1,54	3,07	5,39	7,68

The green results (negative) mean a net energy saving, while the red ones a net energy consumption.

Conclusions

High values of the infiltration rate, evaluated in volumes per hour, lead to electricity savings in summer, due to night infiltration that provides cold fresh air, while increase the energy demand in winter, because conditioned warm air is replaced by cold external air. Low values of the infiltration rate go in the opposite direction.

Stronger effects are shown for lower values. Looking at the fuel demand (natural gas needed on winter to heat the building) it can be seen that there is



a huge effect by air infiltration.
 Percentage evaluation may be deceptive, because in summer low consumption (mainly heat losses of the boiler and the low hot water demand) make even a 50% saving negligible, because of its small magnitude.
 In conclusion, it will be interesting and cost-effective to install a free cooling solution which permits intake of fresh air only in summer nights.

Windows U-value

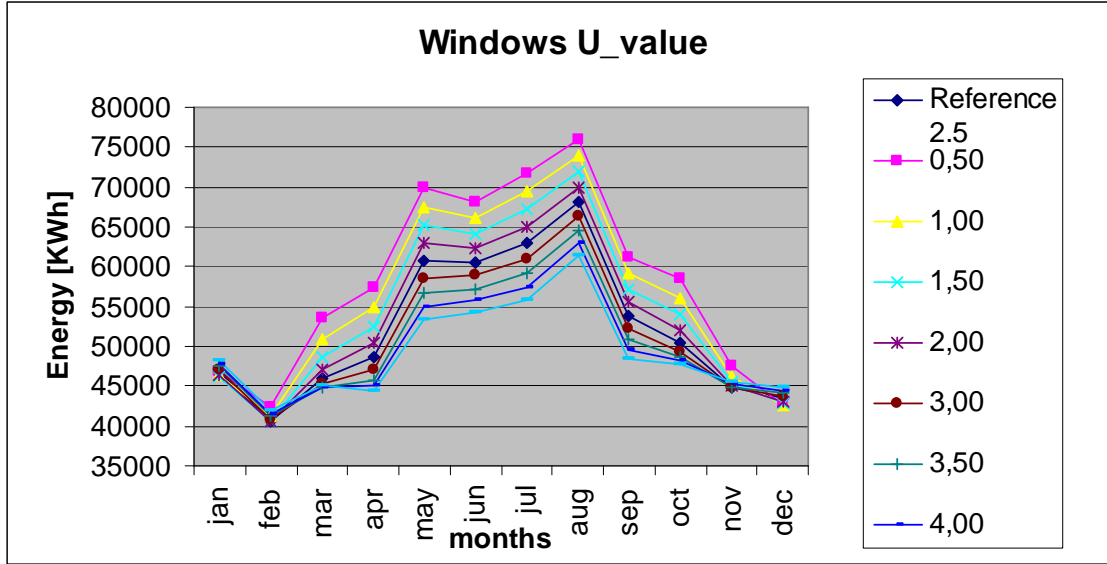

Difference

	0,50	1,00	1,50	2,00	Reference 2,5	3,00	3,50	4,00	4,50
jan	-0,17	0,84	1,18	0,77		-0,75	-1,36	-2,02	-2,76
feb	-4,23	-1,26	0,08	0,27		-0,61	-1,41	-2,22	-3,17
mar	-16,58	-10,67	-5,66	-2,39		1,64	2,40	2,44	2,10
apr	-18,04	-12,93	-8,17	-3,92		3,22	5,63	7,45	8,83
mag	-15,20	-11,19	-7,33	-3,65		3,51	6,70	9,67	12,17
jun	-12,75	-9,38	-6,08	-2,96		2,73	5,41	7,92	10,25
jul	-13,79	-10,10	-6,60	-3,20		3,13	6,00	8,84	11,47
aug	-11,71	-8,52	-5,54	-2,65		2,55	5,04	7,48	9,69
sep	-13,53	-9,87	-6,38	-3,21		2,80	5,56	7,83	10,15
oct	-16,22	-11,28	-6,97	-2,98		2,04	3,29	4,41	5,27
nov	-6,15	-3,31	-1,61	-0,49		-0,04	-0,42	-1,01	-1,63
dec	1,85	2,08	1,52	0,78		-0,67	-1,46	-2,29	-3,12
	-10,54	-7,13	-4,30	-1,97	mean	1,63	2,95	4,04	4,94

Balance

	0,50	1,00	1,50	2,00	Reference 2.5	3,00	3,50	4,00	4,50
jan	-30630	-24535	-17201	-8901		9461	19117	28897	38877
feb	-20668	-17549	-12887	-6810		7264	14887	22755	30931
mar	-5571	-6334	-5611	-3205		4037	8598	13539	18867
apr	5717	3279	1320	407		207	1480	3518	6030
may	7981	5679	3558	1699		-1351	-2202	-2686	-2945
jun	8476	6224	4066	2019		-1930	-3652	-5223	-6467
jul	7002	5138	3316	1604		-1452	-2871	-4183	-5365
aug	7977	5822	3795	1836		-1791	-3419	-5020	-6491
sep	7164	5181	3339	1585		-1496	-2764	-3866	-4796
oct	3027	1635	611	22		870	2116	3776	5832
nov	-8758	-8376	-6697	-4024		5131	10924	17140	23537
dec	-27231	-22866	-16191	-8471		8880	18074	27539	37184
	-45514,0	-46702,0	-38582,0	-22239,0	sum	27830,0	60288,0	96186,0	135194,0
	-5,57	-6,04	-4,94	-2,79	sum %	3,28	6,85	10,50	14,16

Conclusions

Electricity: stronger effects are on March, April, September and October, months in which during the day there is less difference between ambient temperature and indoor conditions.

Lower values are affecting more the electrical consumption.

Something similar to the infiltration rate effect happens: the lower the transmittance, the higher the consumption.

This is because it's electricity spent in higher cooling demand caused by internal gains (lighting and appliances, people activities etc) and fans and pumps that need to circulate more air.

Fuel: the higher the fuel demand, the stronger the effect; furthermore, there's a sort of asymmetry. Indeed, losses are higher with high values of the transmittance than savings with low values.

The overall energy balance goes in favor of low values of the transmittance, up to 6%.

Curiously, the maximum savings are not obtained with the minimum value.

Upgrade insulation of flat roofs externally

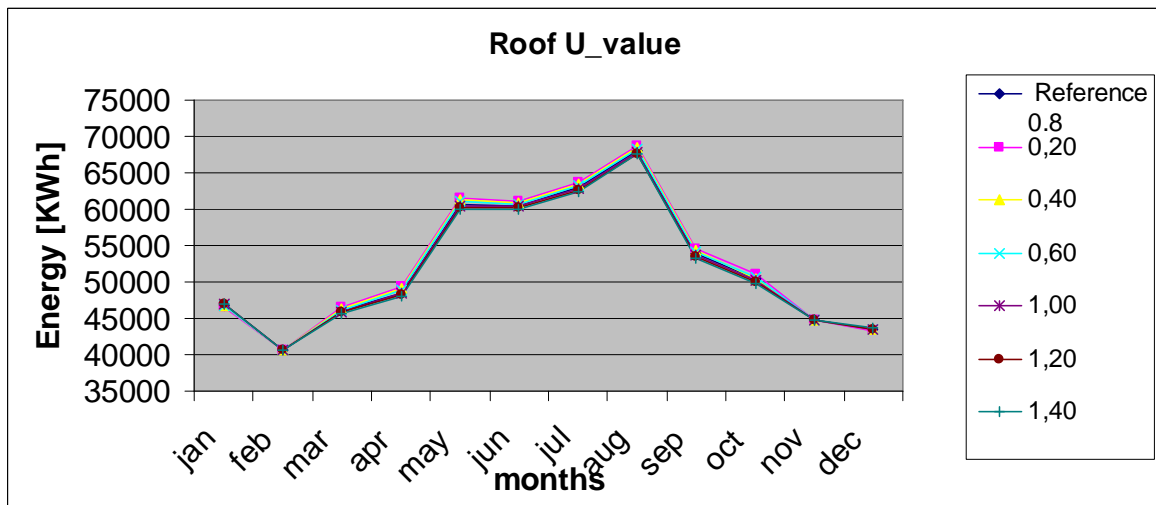

Difference %

	0,20	0,40	0,60	Reference 0.8	1,00	1,20	1,40
jan	0,46	0,30	0,17		-0,16	-0,31	-0,44
feb	0,14	0,09	0,02		0,02	-0,08	-0,19
mar	-0,90	-0,55	-0,24		0,23	0,50	0,74
apr	-1,44	-0,95	-0,50		0,42	0,84	1,29
may	-1,26	-0,87	-0,44		0,40	0,77	1,19
jun	-0,83	-0,56	-0,29		0,26	0,51	0,75
jul	-0,91	-0,62	-0,31		0,30	0,62	0,91
aug	-0,82	-0,55	-0,26		0,26	0,54	0,80
sep	-1,24	-0,80	-0,41		0,41	0,77	1,14
oct	-1,31	0,05	-0,39		0,39	0,75	1,08
nov	-0,15	-0,13	-0,06		-0,06	-0,03	-0,02
dec	0,35	0,21	0,13		-0,12	-0,19	-0,32
	-0,66	-0,36	-0,21	mean	0,20	0,39	0,58

Conclusions

There are few variations, mostly contained into 1% with a maximum value of -0.66% average after a 75% variation of the parameter. Opposite influences between summer and winter, with stronger variations on spring and autumn.

Opaque-Frontages U-value

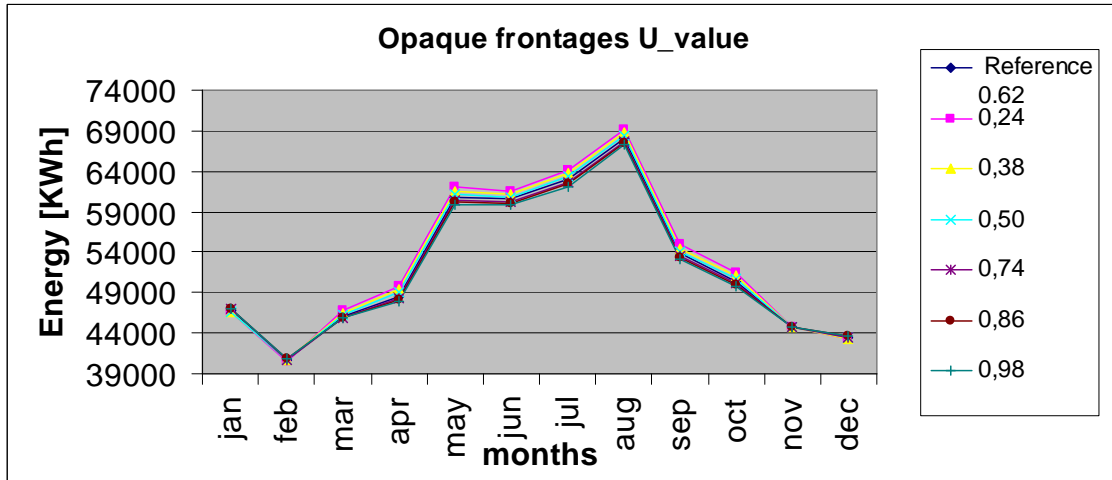

Difference %

	0,24	0,38	0,50	Reference 0.62	0,74	0,86	0,98
jan	0,62	0,43	0,24		-0,20	-0,34	-0,49
feb	0,23	0,13	0,03		-0,03	-0,30	-0,37
mar	-1,74	-0,84	-0,48		0,43	0,16	0,37
apr	-2,68	-1,56	-0,81		0,71	0,99	1,49
may	-2,12	-1,25	-0,75		0,66	0,87	1,44
jun	-1,69	-1,04	-0,55		0,50	0,74	1,16
jul	-1,78	-1,12	-0,56		0,55	0,92	1,40
aug	-1,50	-0,96	-0,48		0,47	0,73	1,11
sep	-2,05	-1,30	-0,62		0,60	0,86	1,31
oct	-2,22	-1,34	-0,65		0,56	0,75	1,11
nov	-0,25	-0,03	-0,10		-0,03	-0,20	-0,23
dec	0,57	0,32	0,18		-0,14	-0,25	-0,39
	-1,22	-0,71	-0,38	mean	0,34	0,41	0,66

Conclusions

There is higher influence on lower values, maybe because there is more irreversibility due to higher gradients: indeed, the higher the gradient, the higher the irreversibility and the losses during the process, and consequently the higher the energy spent.

It can be seen that there's an opposite influence on winter with respect to the rest of the year, but the overall result is contained into a 1% variation, making this parameter not so relevant.

Replace lighting equipment with low consumption types

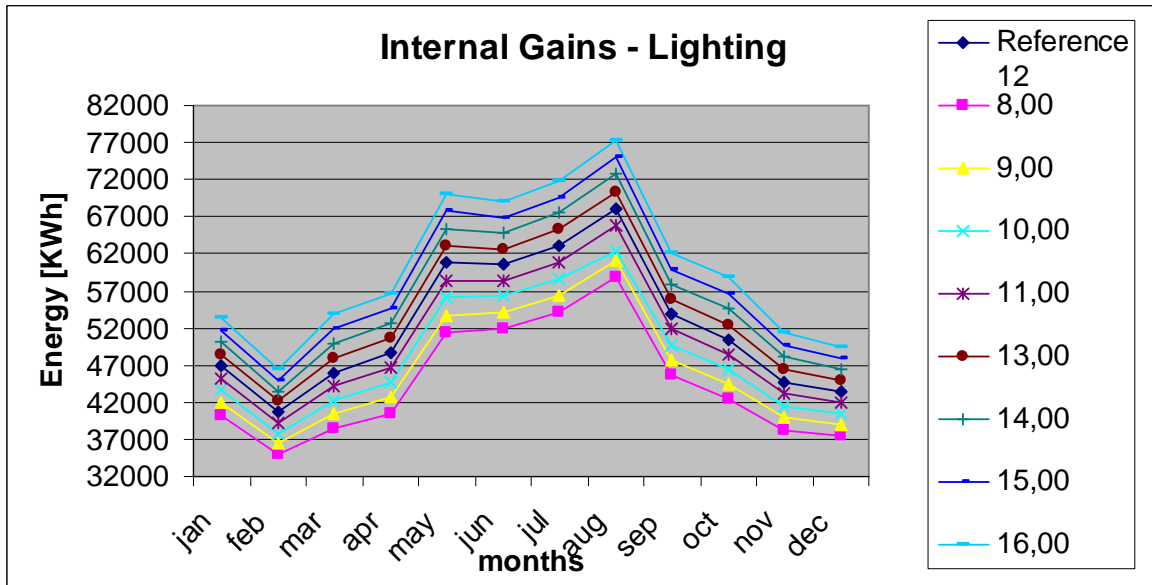

The various are translated exactly up or down with respect to the reference point.

Difference %

	8,00	9,00	10,00	11,00	Reference 12	13,00	14,00	15,00	16,00
jan	13,89	10,35	6,90	3,41		-3,42	-6,86	-10,28	-13,73
feb	14,02	10,59	7,14	3,60		-3,63	-7,11	-10,69	-14,32
mar	16,23	12,24	8,14	4,11		-4,13	-8,30	-12,60	-16,94
apr	16,49	12,31	8,21	4,10		-4,18	-8,37	-12,53	-16,80
may	15,35	11,50	7,63	3,82		-3,88	-7,67	-11,52	-15,34
jun	14,08	10,54	7,03	3,53		-3,56	-7,08	-10,63	-14,16
jul	14,09	10,58	7,07	3,54		-3,53	-7,06	-10,58	-14,10
aug	13,69	10,25	8,31	3,42		-3,41	-6,84	-10,26	-13,69
sep	15,11	11,34	7,56	3,79		-3,78	-7,61	-11,41	-15,20
oct	15,74	11,93	8,05	4,07		-4,16	-8,30	-12,46	-16,59
nov	14,45	10,89	7,27	3,59		-3,75	-7,44	-11,16	-14,98
dec	13,80	10,34	6,90	3,46		-3,44	-6,89	-10,32	-13,72
	14,74	11,07	7,52	3,70	mean	-3,74	-7,46	-11,20	-14,97

Conclusions

As hinted by the previous curves, there's a sort of translation up or down, with maximum variations around 15% with respect to the mean value of the variation itself.

The distribution is almost symmetric, suggesting that the electricity consumptions here considered come mostly from the lighting devices, increasing or decreasing evenly the contribution of the HVAC system to maintain the indoor climatic conditions.

It is also interesting to observe that reducing the lighting consumption by 33% produce and overall 15% energy saving.

As seen before, lighting devices account for almost half of the overall electrical consumption.

Replace electrical equipment with Energy Star or low consumption types

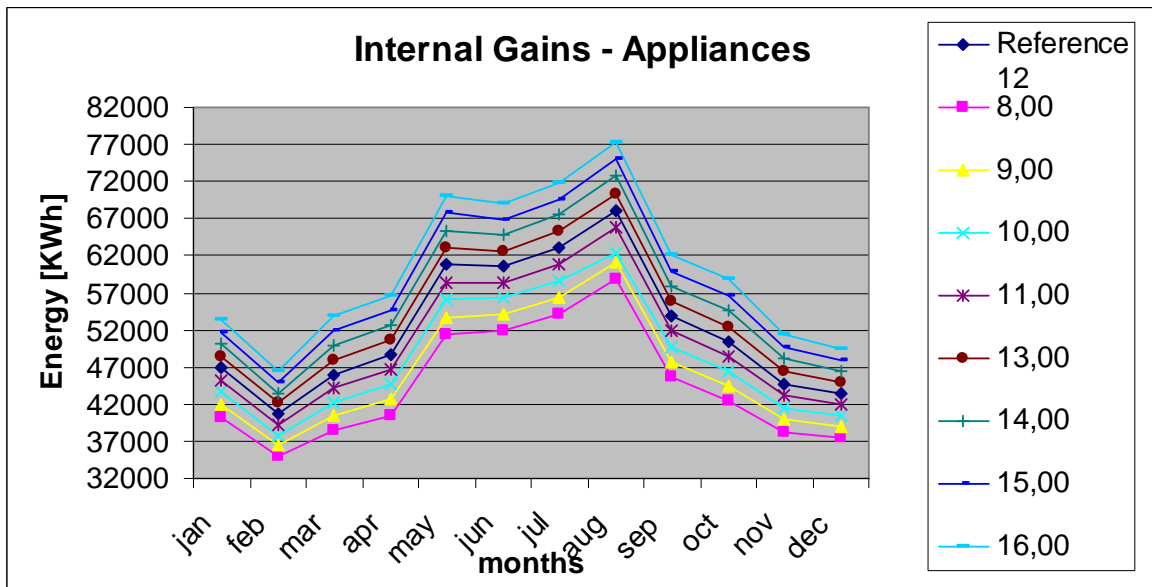

Difference %

	8,00	9,00	10,00	11,00	Reference 12	13,00	14,00	15,00	16,00
jan	13,89	10,35	6,90	3,41		-3,42	-6,86	-10,28	-13,73
feb	14,02	10,59	7,14	3,60		-3,63	-7,11	-10,69	-14,32
mar	16,23	12,24	8,14	4,11		-4,13	-8,30	-12,60	-16,94
apr	16,49	12,31	8,21	4,10		-4,18	-8,37	-12,53	-16,80
may	15,35	11,50	7,63	3,82		-3,88	-7,67	-11,52	-15,34
jun	14,08	10,54	7,03	3,53		-3,56	-7,08	-10,63	-14,16
jul	14,09	10,58	7,07	3,54		-3,53	-7,06	-10,58	-14,10
aug	13,69	10,25	8,31	3,42		-3,41	-6,84	-10,26	-13,69
sep	15,11	11,34	7,56	3,79		-3,78	-7,61	-11,41	-15,20
oct	15,74	11,93	8,05	4,07		-4,16	-8,30	-12,46	-16,59
nov	14,45	10,89	7,27	3,59		-3,75	-7,44	-11,16	-14,98
dec	13,80	10,34	6,90	3,46		-3,44	-6,89	-10,32	-13,72
	14,74	11,07	7,52	3,70	mean	-3,74	-7,46	-11,20	-14,97

Balance

	0,50	1,00	1,50	2,00	Reference 2.5	3,00	3,50	4,00	4,50
jan	-893,00	-657,00	-461,00	-229,00		285,00	630,00	996,00	1412,00
feb	-1688,00	-1317,00	-936,00	-496,00		536,00	1057,00	1651,00	2300,00
mar	-5521,00	-4197,00	-2820,00	-1444,00		1477,00	3020,00	4652,00	6317,00
apr	-7757,00	-5797,00	-3871,00	-1938,00		1979,00	3977,00	5968,00	8015,00
may	-9322,00	-6981,00	-4635,00	-2322,00		2353,00	4658,00	6992,00	9316,00
jun	-8516,00	-6376,00	-4255,00	-2134,00		2155,00	4279,00	6427,00	8566,00
jul	-8871,00	-6662,00	-4453,00	-2231,00		2225,00	4451,00	6667,00	8884,00
aug	-9320,00	-6979,00	-5657,00	-2325,00		2324,00	4659,00	6984,00	9322,00
sep	-8127,00	-6096,00	-4063,00	-2037,00		2030,00	4093,00	6138,00	8175,00
oct	-6613,00	-5055,00	-3467,00	-1785,00		1857,00	3731,00	5625,00	7524,00
nov	-2232,00	-1733,00	-1206,00	-599,00		750,00	1530,00	2384,00	3330,00
dec	-301,00	-247,00	-203,00	-117,00		135,00	298,00	485,00	696,00
	-69161,0	-52097,0	-36027,0	-17657,0	sum	18106,0	36383,0	54969,0	73857,0
	-8,71	-6,42	-4,36	-2,09	sum %	2,05	4,04	5,99	7,88

Conclusions on Internal Gains

As it was hinted before, the internal gains help the heating plant to heat the building, and so we have absolutely no influence in summer (talking in terms of fuel, electrical energy for cooling is, instead, deeply influenced), which translates in net savings when lighting or/and appliances consumptions are reduced.

This effect is lowered in winter, because the heating plant need to substitute to those heat sources.

Taking into account primary energy balance, the efficiency of heating provided by thermal plant is higher than those provided by internal appliances.

Overall conclusions

This case study presents a 1970's office building with a glazed facade and a totally refurbished HVAC system.

- 1. Night time free cooling could provide medium energy savings (5-10%), but it is difficult to implement**
- 2. High performance and cost mixed HVAC system, with absorption unit, could consume as a standard one if the operation strategy is not adequate**
- 3. Substitution of windows with low permeability and U-value ones should be adequately considered in respect of cooling loads raising**
- 4. Absorption chiller installation with CHP system has to be evaluated really carefully, paying attention to load profiles of the building, and to costs/benefits of producing and selling electrical energy**
- 5. "Over cooling" of some zone should be reduced, in order to increase the comfort and decrease the consumption**
- 6. Occupants' education should save energy around 5 %, almost costless.**