

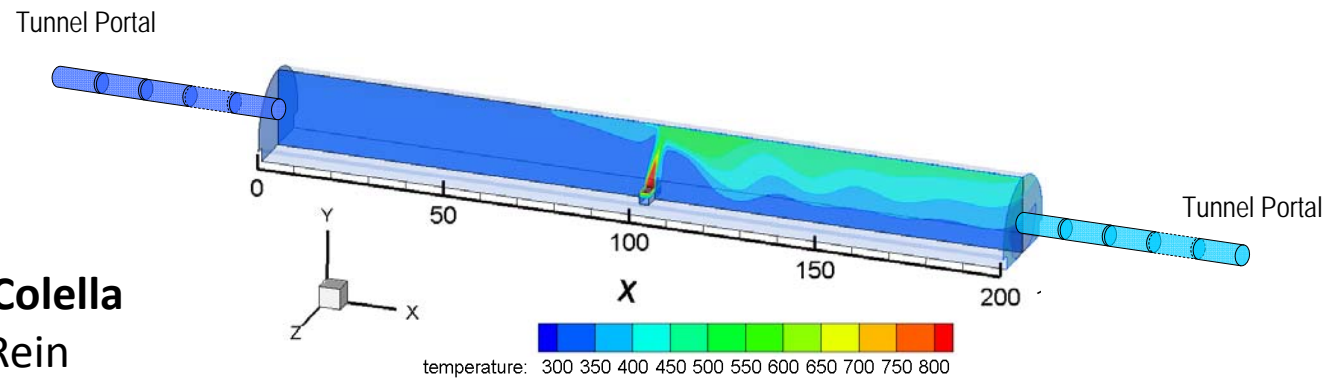

GDR CNRS n°2864
17-18 June 2010



Multiscale analysis of tunnel ventilation flows and fires



Dr. Francesco Colella

Dr. Guillermo Rein

Prof. Vittorio Verda

Prof. Romano Borchiellini

Prof. Jose L. Torero

Dipartimento di Energetica – Politecnico di Torino

Introduction - Ventilation system



The most widespread safety system in tunnels is the ventilation system

➤ Normal operating conditions

- visibility
- pollutant concentrations

➤ Emergency conditions

- Smoke management
- safe evacuations
- fire fighting

Introduction - Ventilation system



The flow conditions within tunnels are dependent on the combined influence of:

- Ventilation devices (axial and jet fans)
- Tunnel layout (slopes)
- Boundary conditions at the portals
- Blockages within the domain
- Fire size and Location
- Comprehensive analysis has to consider the whole system and not simply a part of it

1D Network model - characteristics



- Fast simulations
- Straightforward definition of boundary conditions
- Predict the global behaviour of coupled systems
- Well established for design purposes

BUT

- Need calibration constants
- Provides only ballpark figures

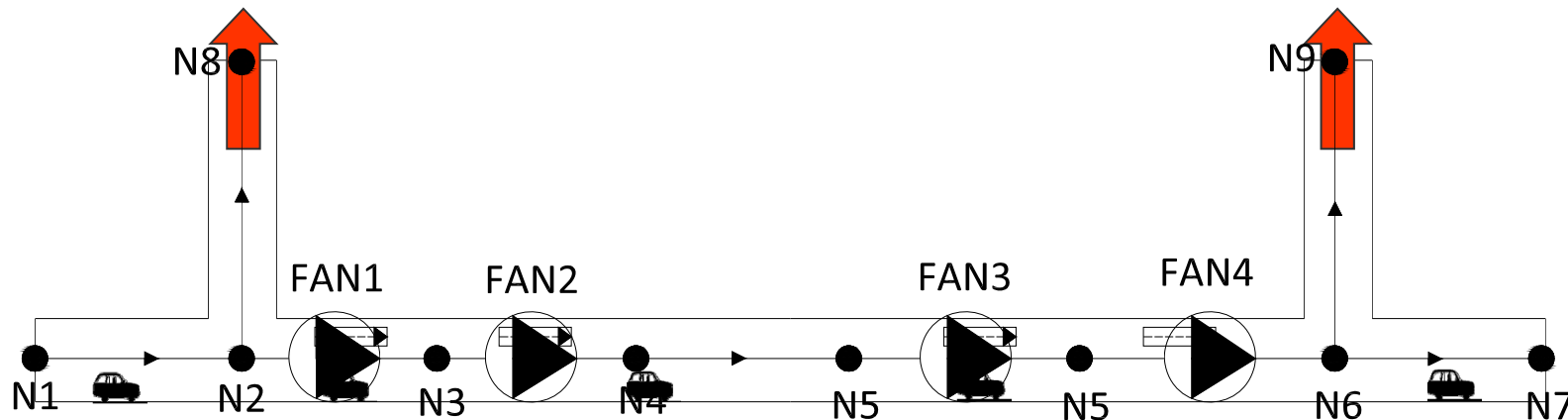

CFD model - characteristics



- Detailed flow field representation
 - Well established for design verification
- BUT**
- Large computational time
 - Not affordable for long tunnels or for analysis of ventilation strategies
 - Still limited results due to uncertainties in modelling turbulence, combustion, radiation and pyrolysis of condensed fuels
 - “Acceptable” accuracy for global quantities (i.e. back-layering distance)
 - “Poor” predictions of local flow field data

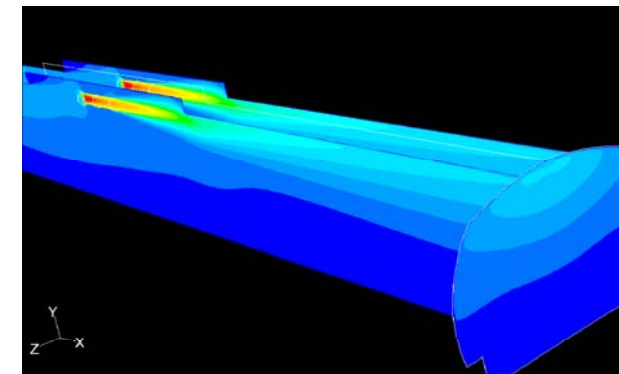
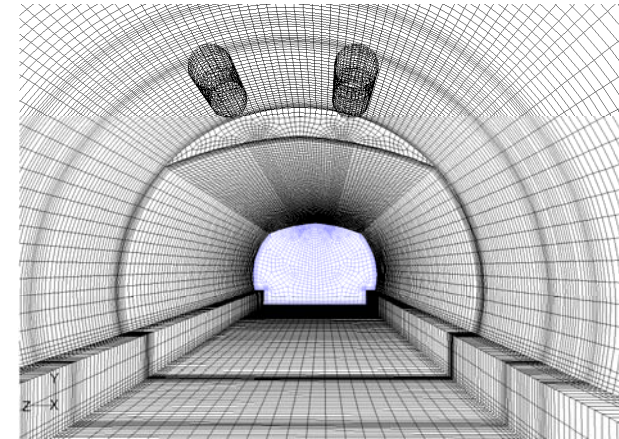

CFD vs. 1D computing time

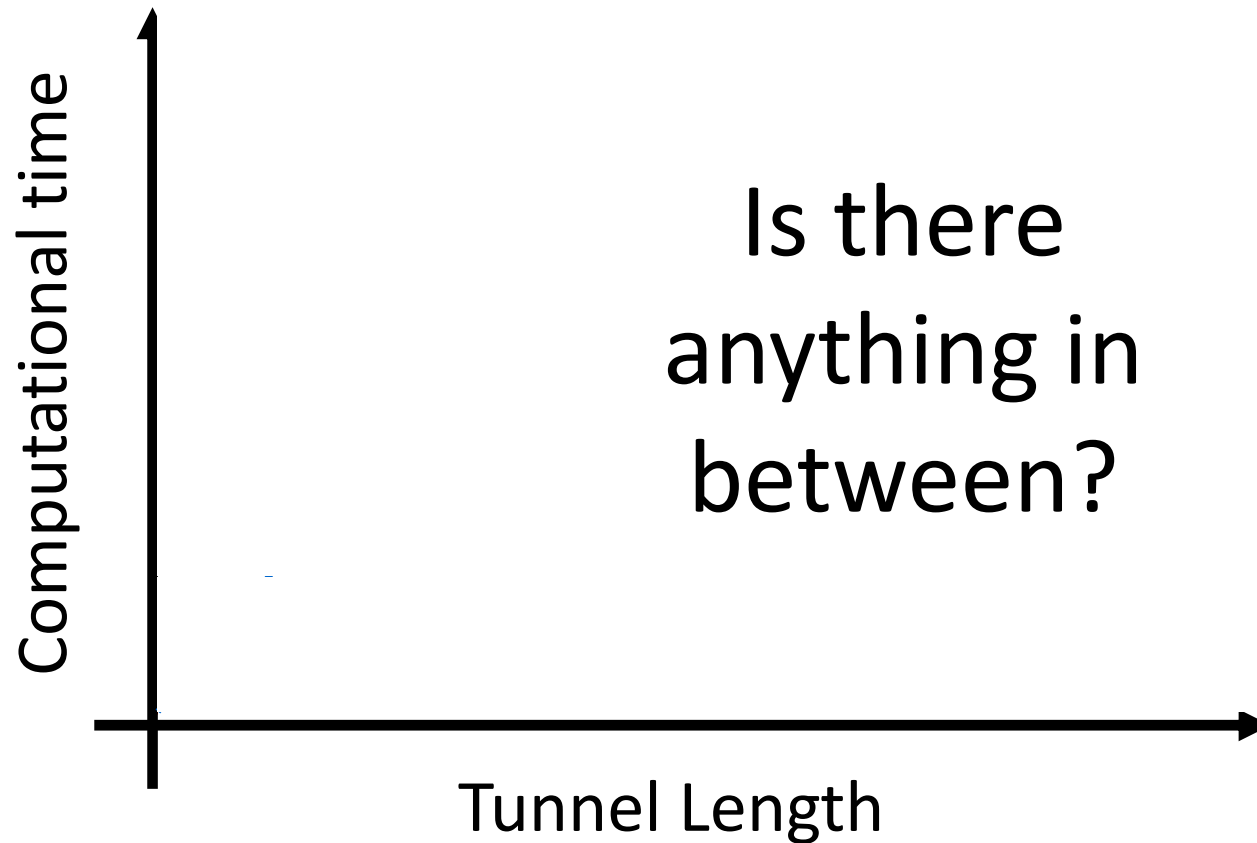

Multiscale model - introduction



Typical velocity contours in presence of jet fans

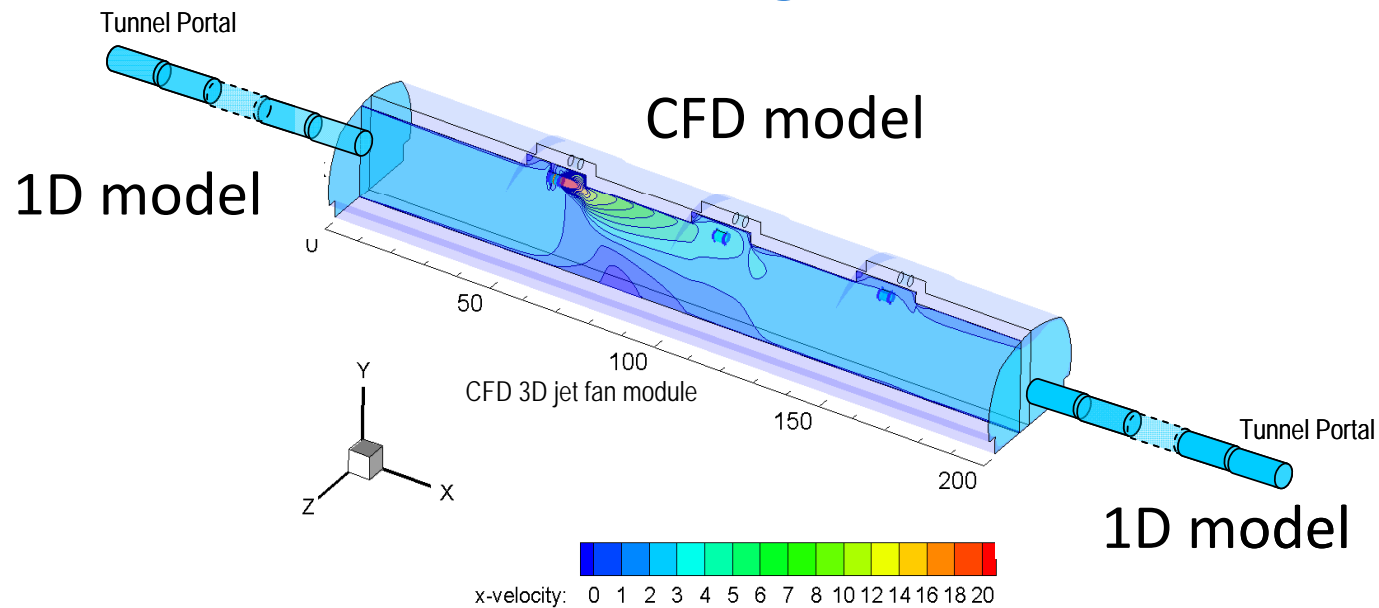
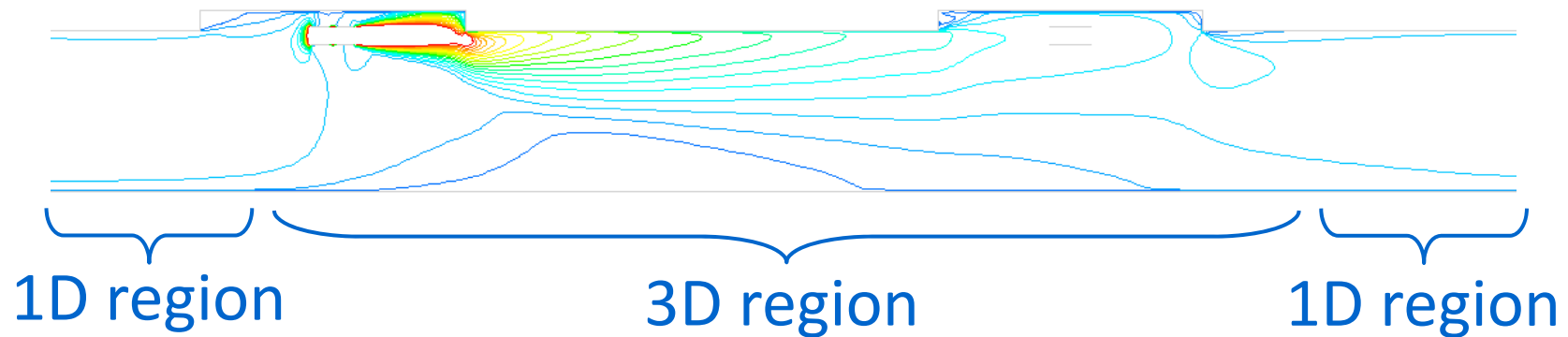

Multiscale model - introduction



Typical temperature contours in presence of fire

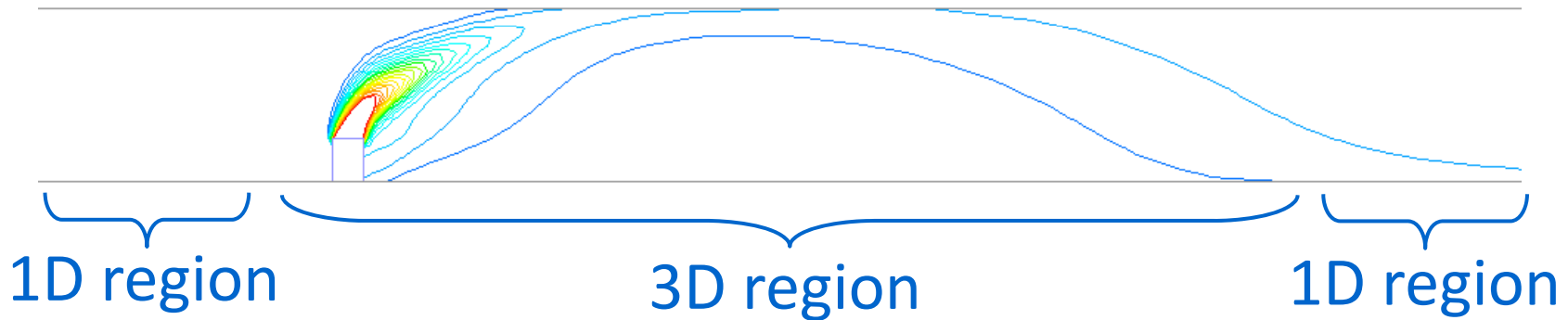

1D model

CFD model

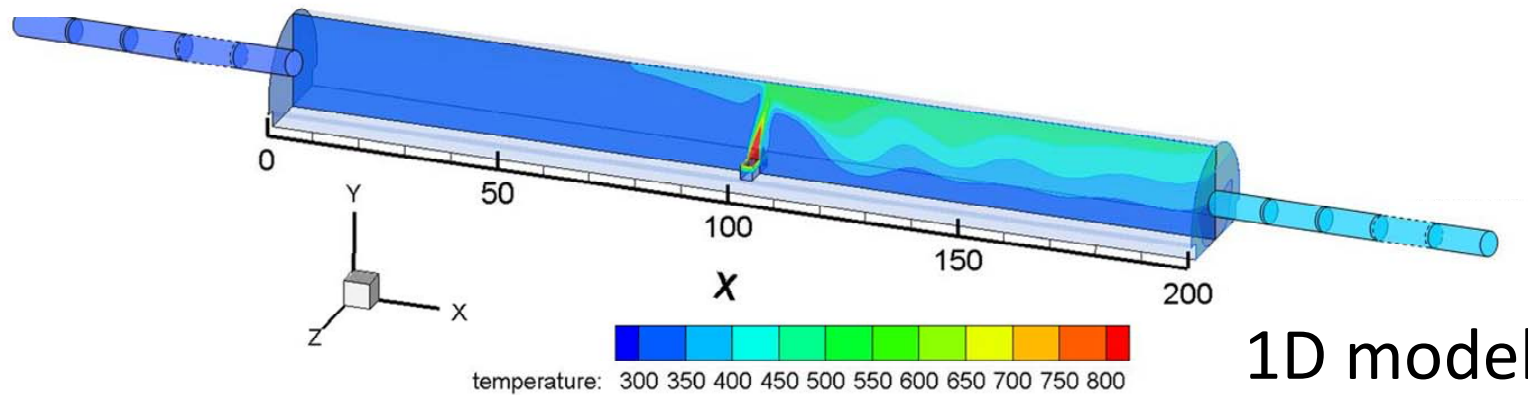

Multiscale – coupling procedure



Physical decomposition of the domain

1D Regions

- Low velocity/temperature gradients
- Mono-dimensional models can be used

3D Regions

- High velocity/temperature gradients
- CFD models must be adopted

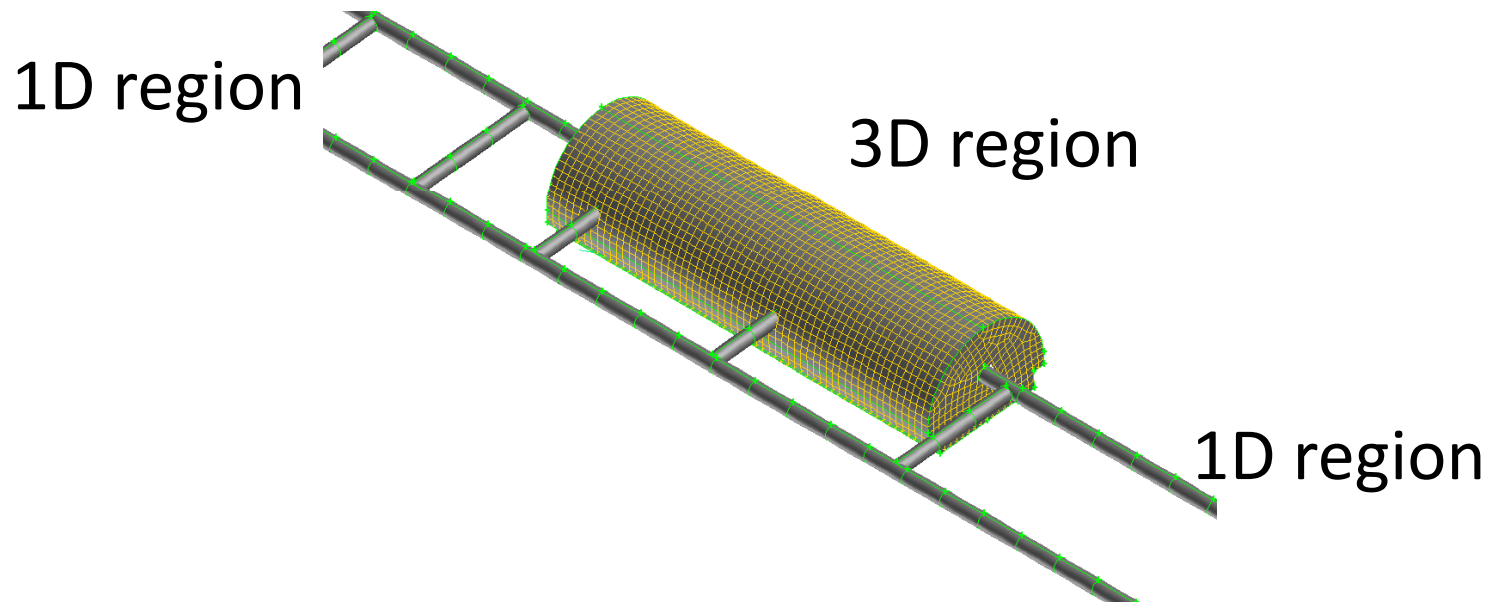

Multiscale – coupling procedure



- Based on Dirichlet-Neumann methods
- Use non-overlapping domain decomposition
- Neumann-type boundary condition applied to the CFD sub-domain interfaces
- Dirichlet-type boundary condition applied to the 1D sub-domain interfaces.
- The model guarantees the continuity of average pressure, velocity and temperature values at the 1D-CFD interfaces

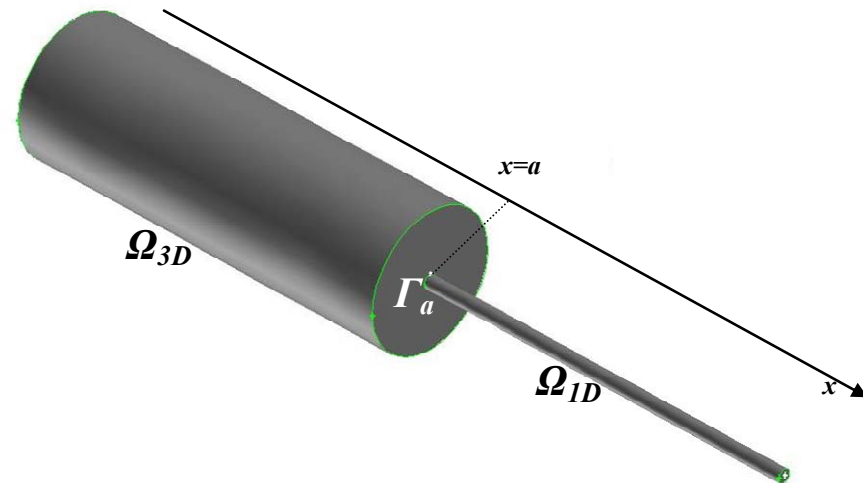
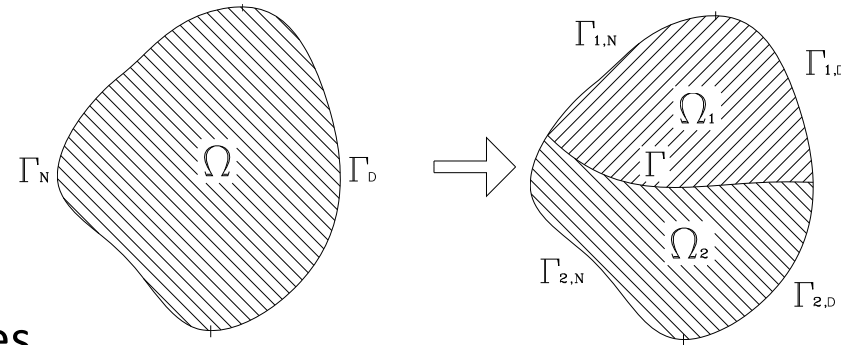

Multiscale – coupling procedure



Coupling stages

1 - Full 1D model



2 - CFD model near field

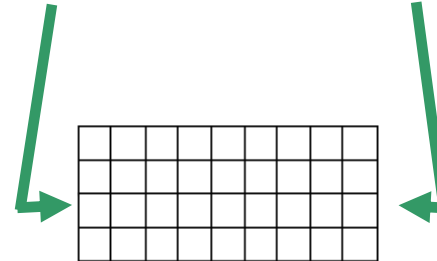

3.a – 1D model far field } *K-times*
3.b - CFD model near field }

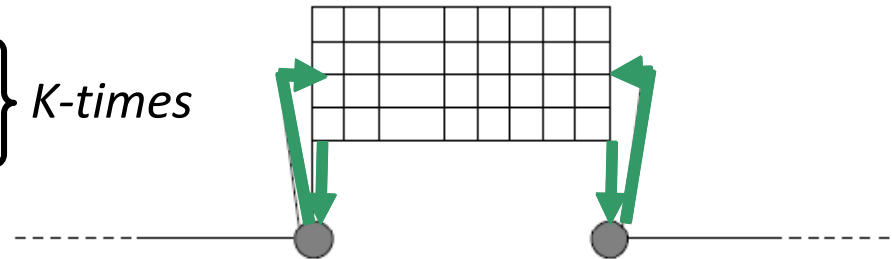

Proceed to the next time step when some global convergence is reached

Multiscale - characteristics



- Dramatic reduction of the computational time (up to 2 orders of magnitude for a 1.2 km long tunnel)
- As accuracy as CFD
- Successfully used for parametric studies

BUT



- The placement of the 1D-3D interfaces is an issue
- Higher set up time than CFD
- The CFD solver has to be accessed by the user during the iteration algorithm (i.e. compiled UDF for FLUENT)

Simulation of tunnel ventilation flow

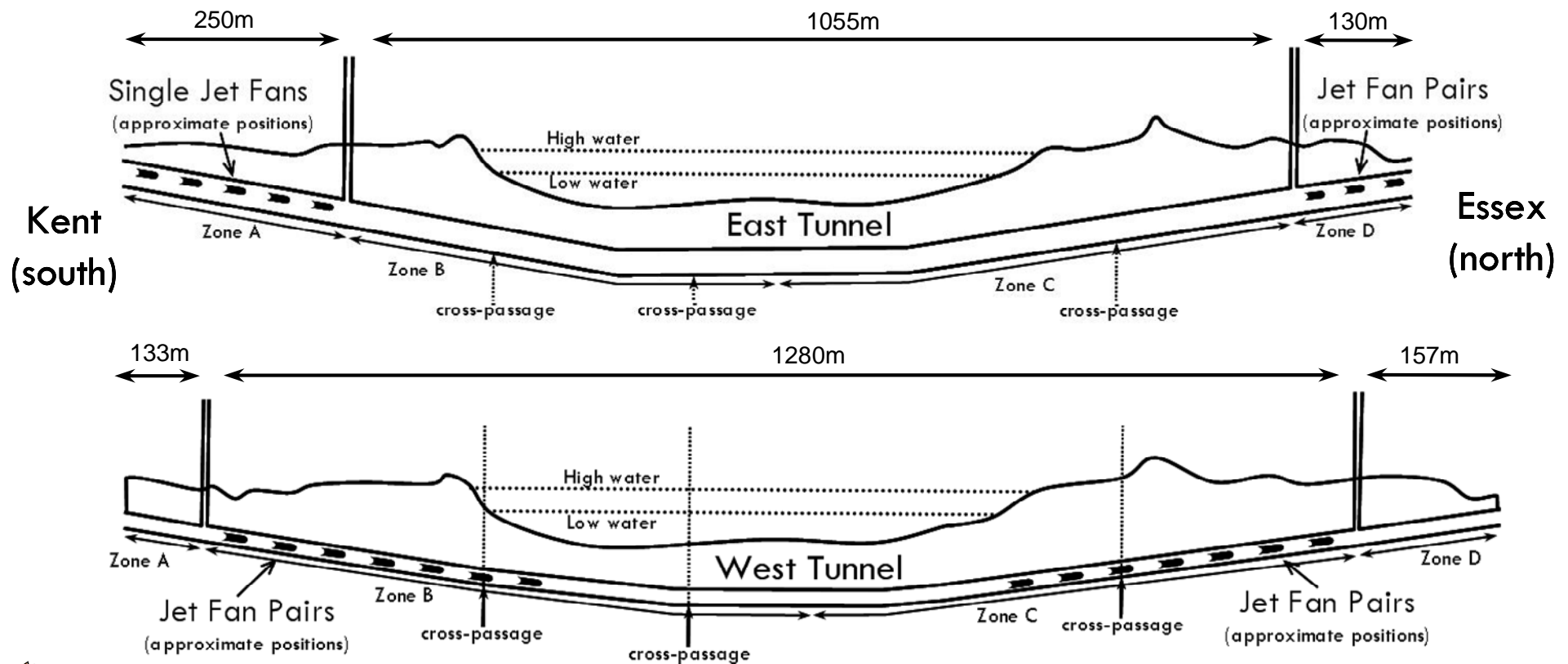

East & West Dartford tunnels (UK)



 Colella, F., et al (2010), *Tunnel. Underg. Space Technol.*
 Colella F et al (2009) *Building and Environment*

Simulation of tunnel ventilation flow



East & West Dartford tunnels (UK)

- ≈ 1500 m long with hybrid ventilation system
- **East tunnel** diam 9.5 m (1980)
- **West tunnel** diam 8.6 m (1963)
- 2 supply & extraction ventilation stations in the vicinity of the portals
- 28 jet fans in the **West Tunnel**
- 11 reversible jet fans in the **East tunnel**



Colella, F., et al (2010), *Tunnel. Underg. Space Technol.*



Colella F et al (2009), *Building and Environment*

Simulation of tunnel ventilation flow



West Tunnel Jet fan near field

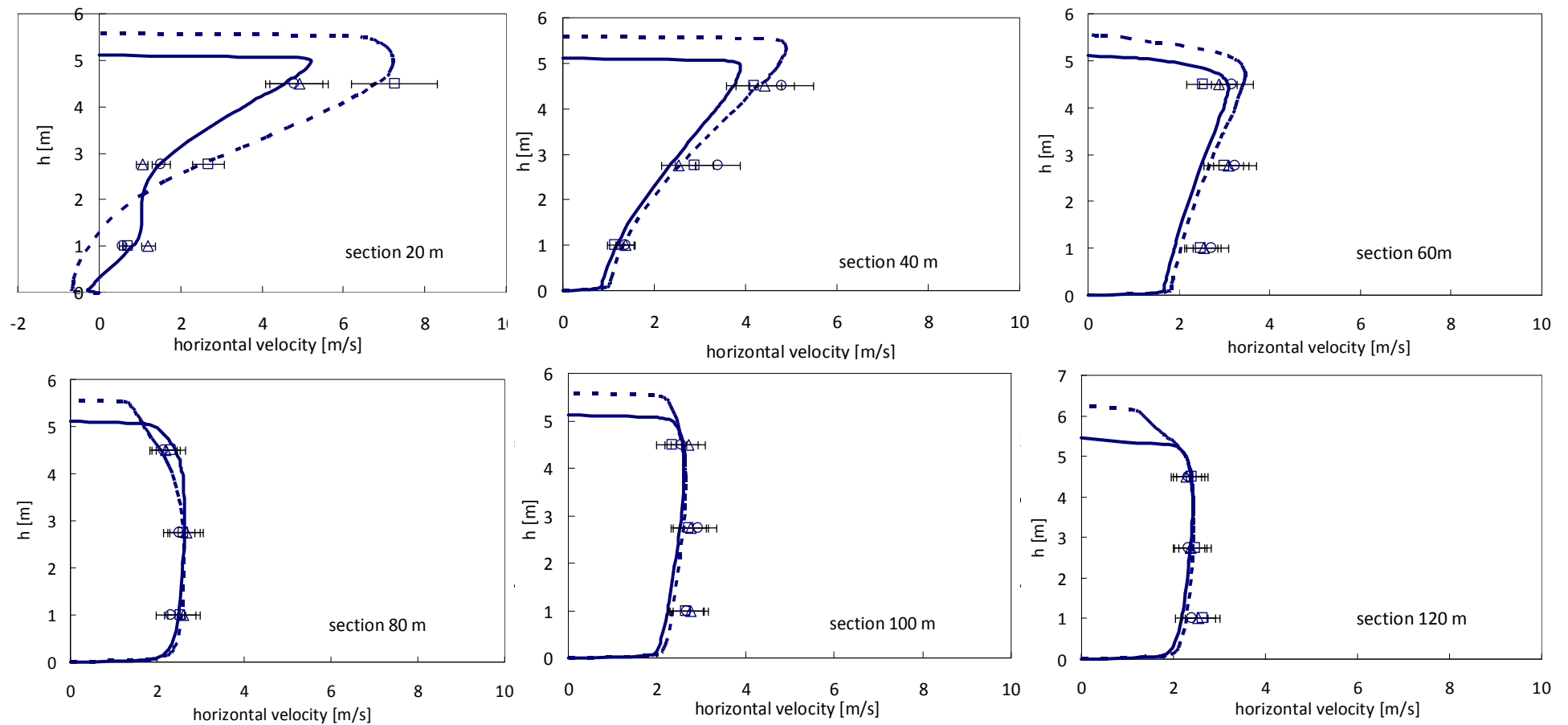

Simulation of tunnel fire scenarios

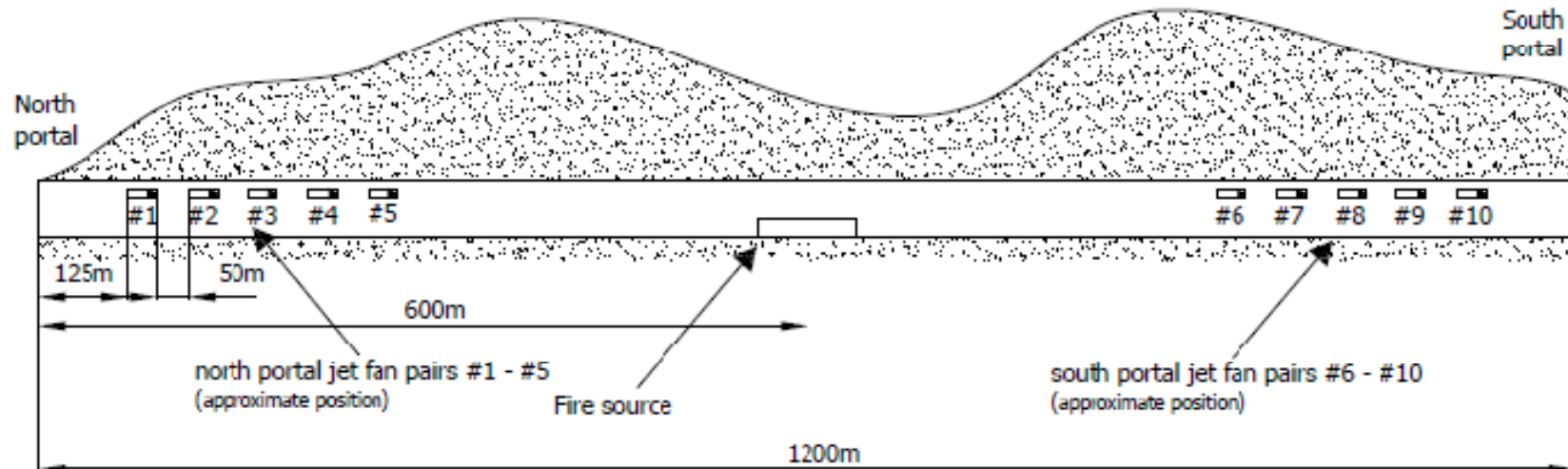

- 1200 m long longitudinally ventilated
- 10 pairs of jet fans (50m spaced, 34 m/s discharge air velocity)
- Fire located in the centre of the tunnel
- Fire max HRR: from 10 MW to 100 MW

Simulation of tunnel fire scenarios

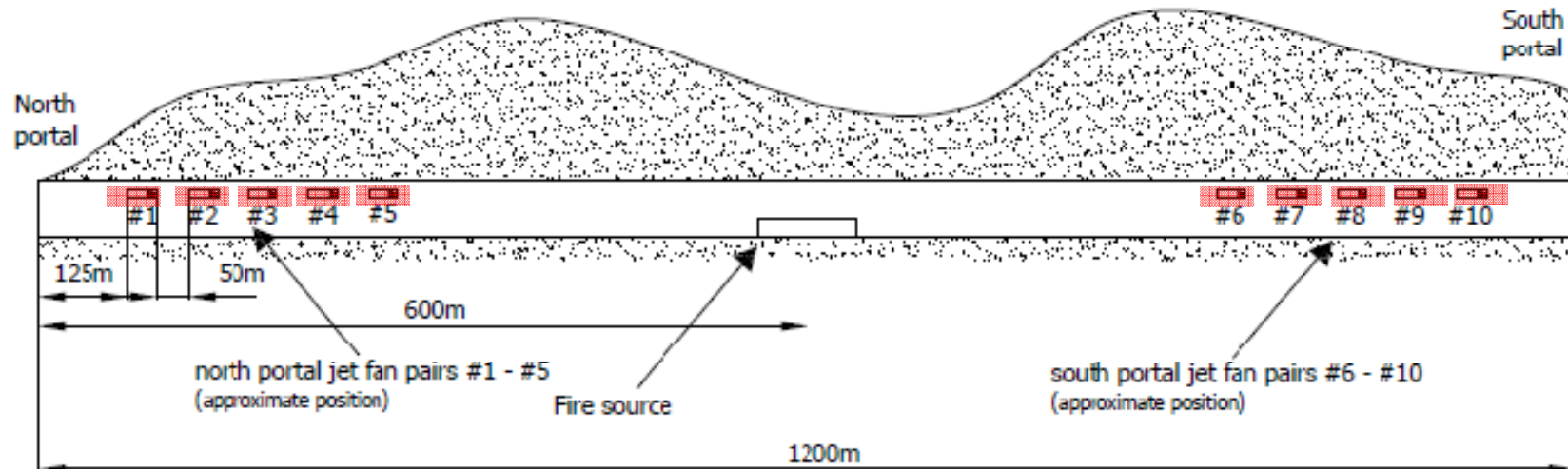

➤ Ventilation scenarios

- Scenario 1: 3 jet fan pairs
- Scenario 2: 5 jet fan pairs
- Scenario 3: 10 jet fan pairs

Simulation of tunnel fire scenarios



Fire near field

Multiscale arrangement

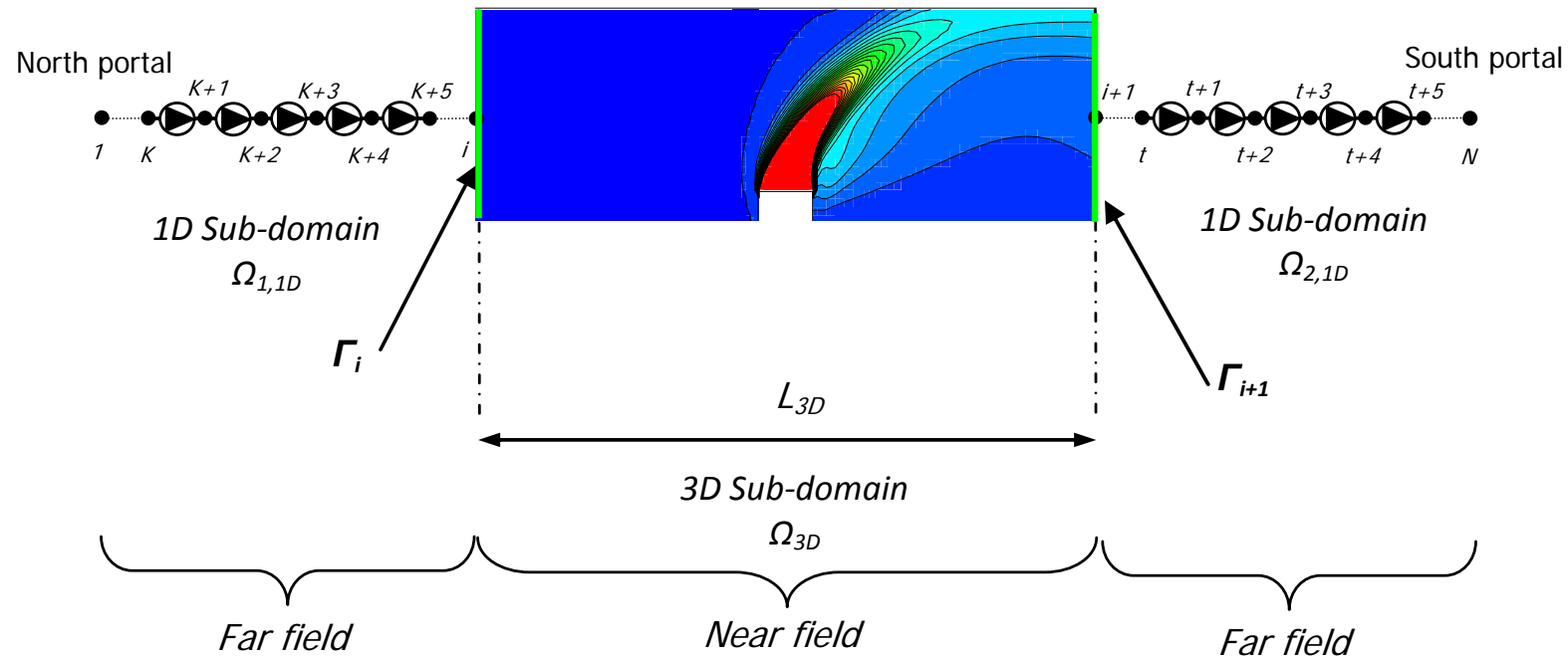

Steady state results



Comparison to full CFD solutions (30 MW fire)

Scenario 1: 3 Jet fan pairs

full CFD

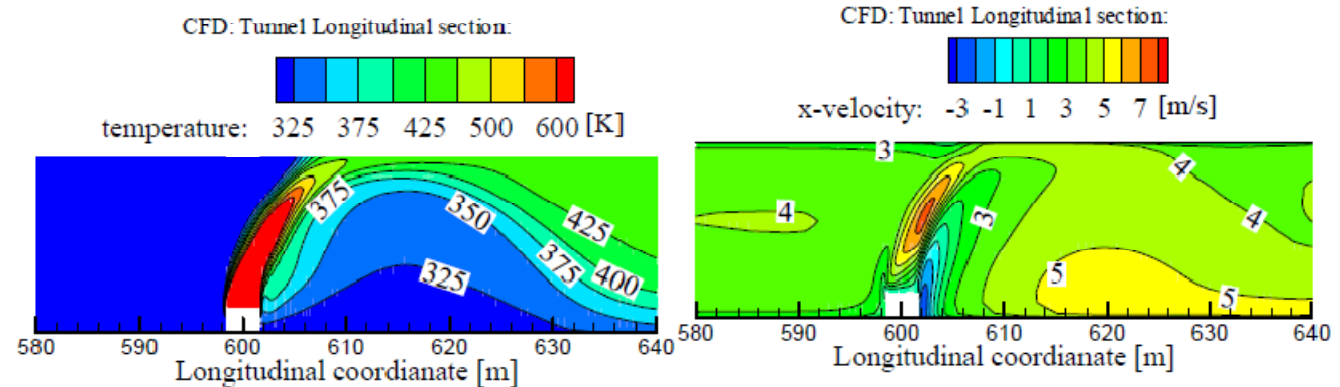

Multiscale

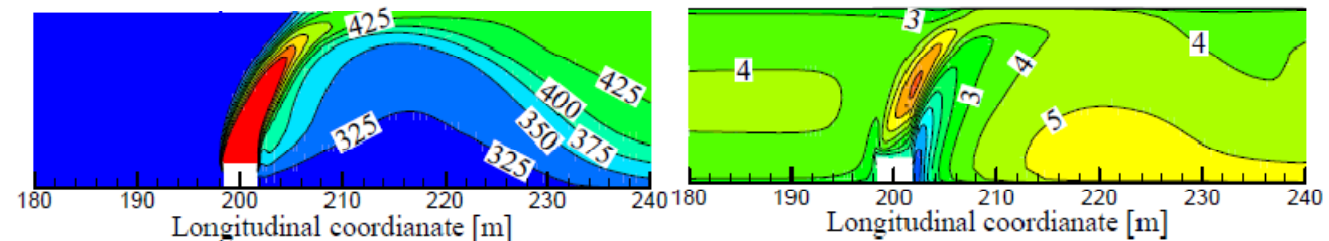

Highly accurate results are achieved!

 Colella F., et al., *Fire Technology*, (in press).

Time dependent results

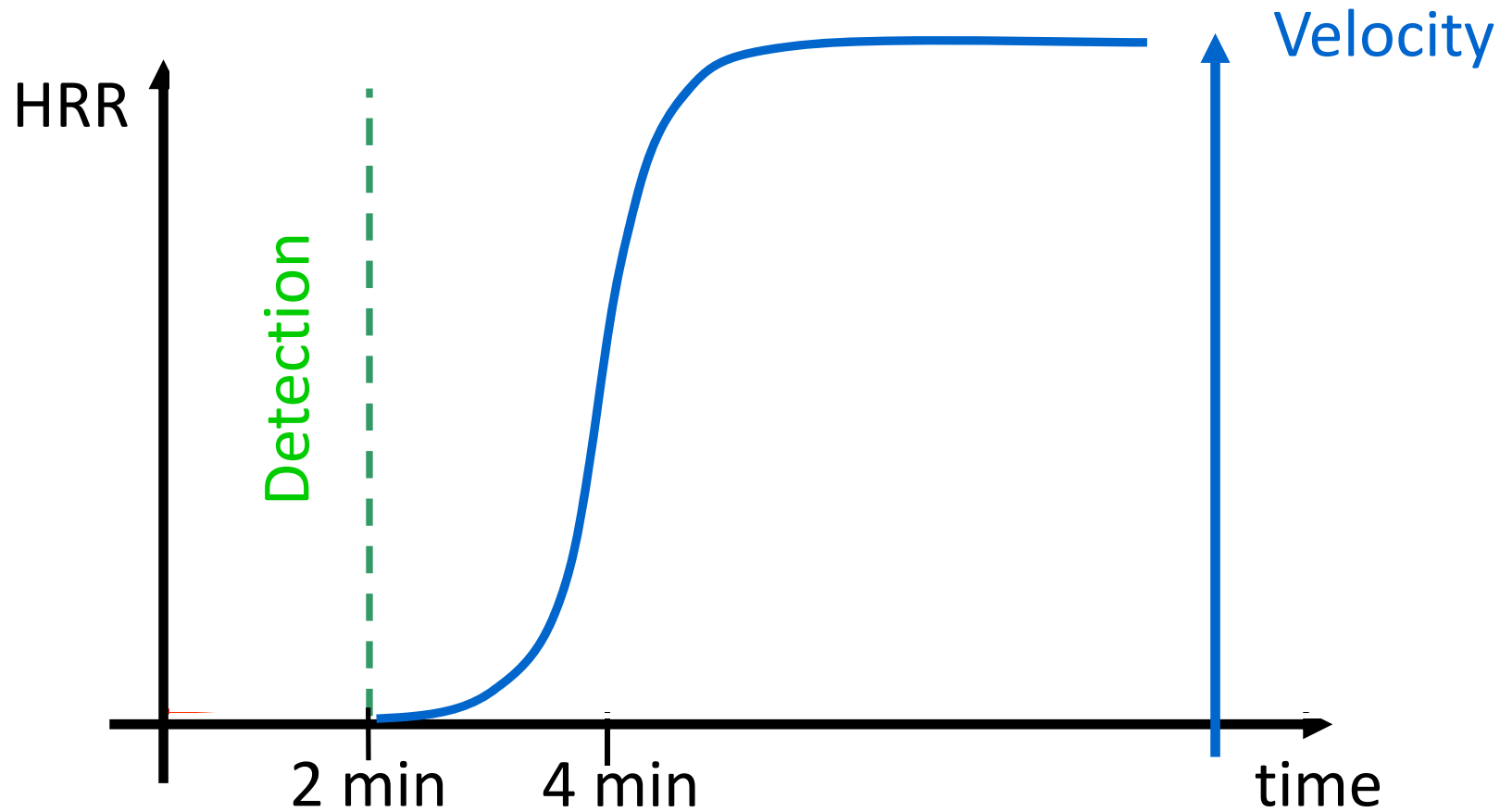

Time dependent results



Multiscale results: 2 minutes

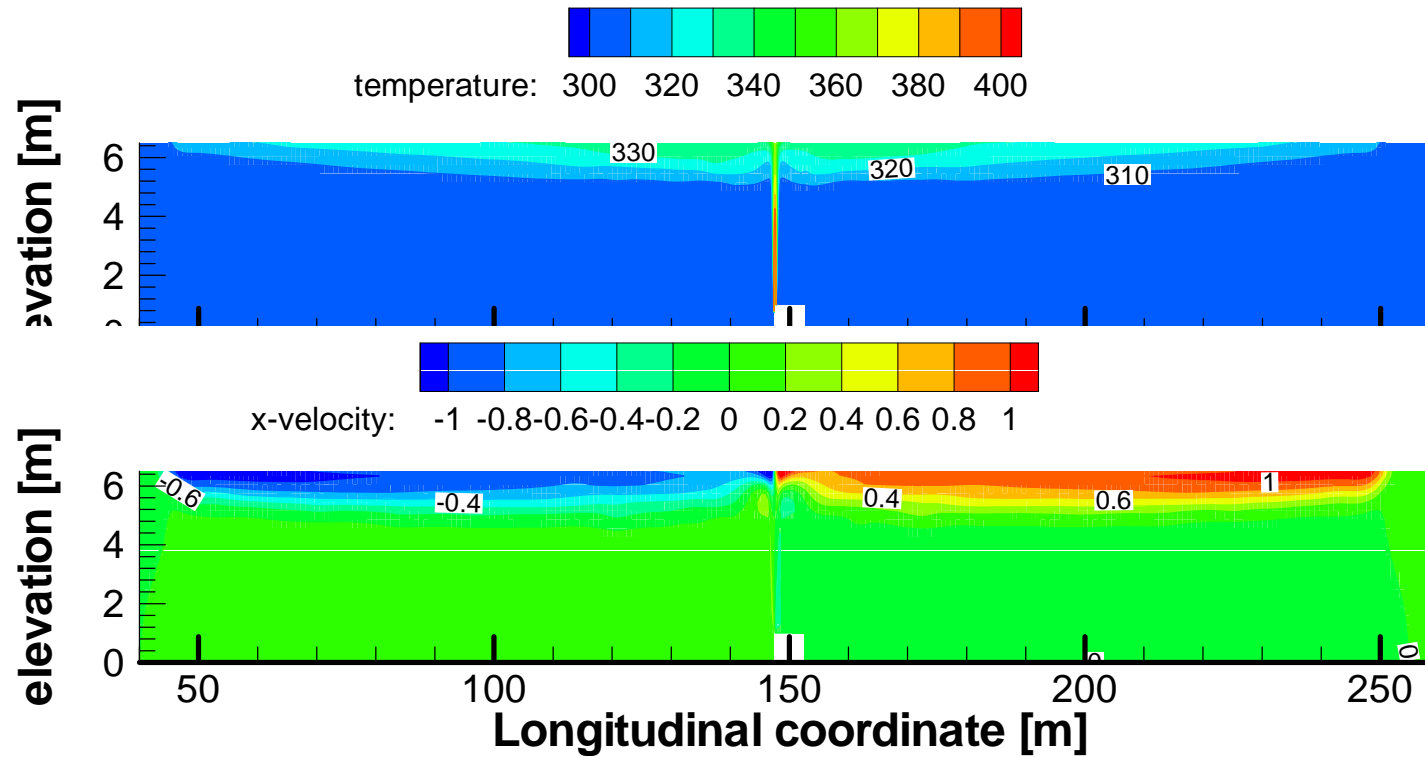

Time dependent results



Multiscale results: 3 minutes

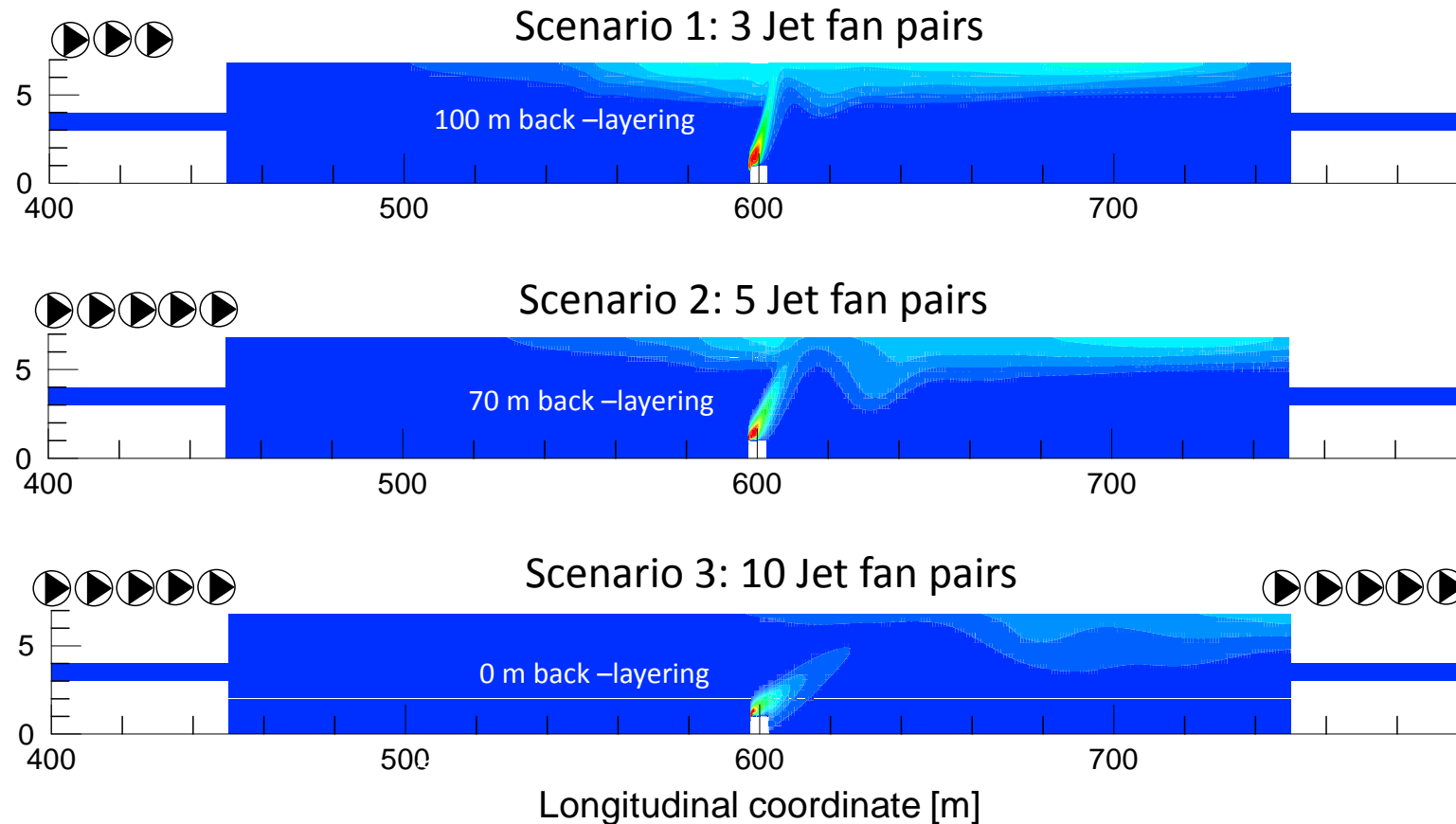

Time dependent results



Multiscale results: 5 minutes

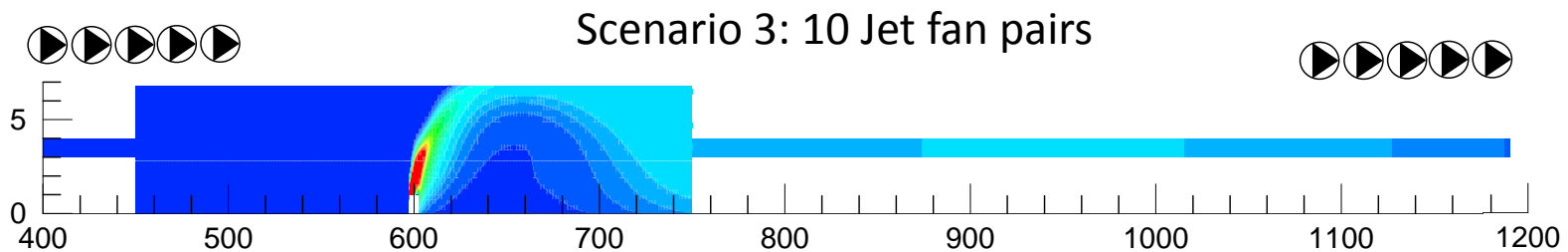
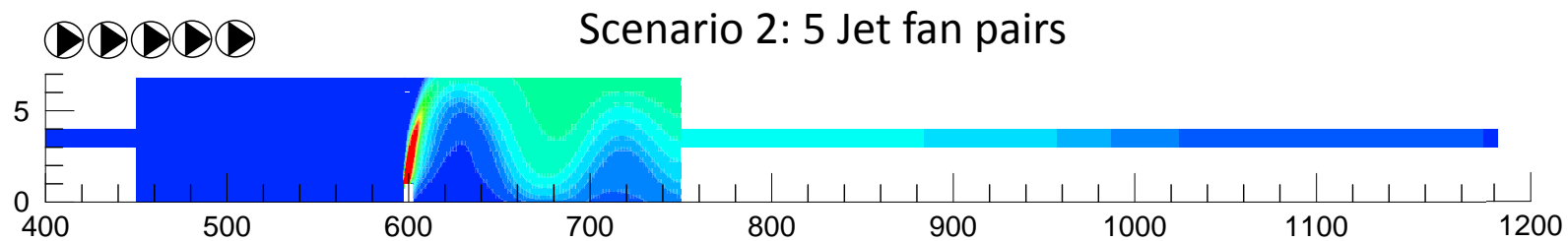
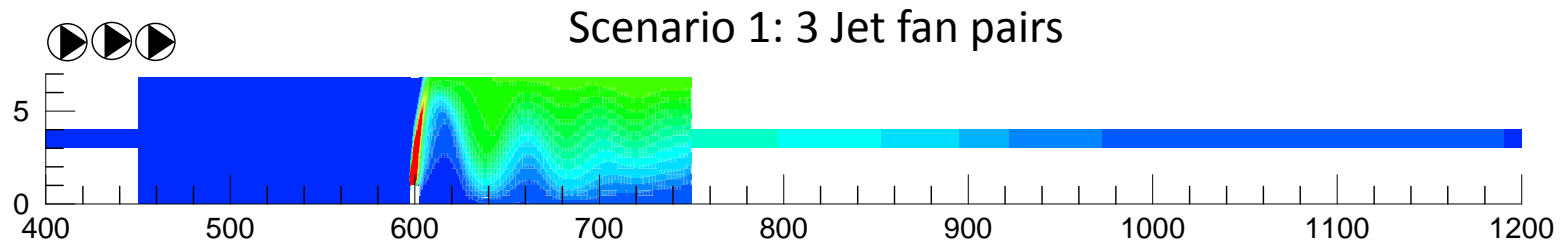

Conclusions (1)



Several numerical techniques have been used to deal with ventilation and fire induced flows in tunnels

- 1D and CFD models
- Multiscale models
 - Dramatic reduction of the computational time (up to 2 orders of magnitude)
 - As accurate as full CFD
 - Results agree well with experimental measurements
 - **Allow for full coupling of fire and ventilation system and complete analysis of ventilation system response**
 - Well suited to conduct parametrical studies, sensitivity analysis, redundancy studies and Detection/Activation/propagation problems

Conclusions (2)



Evaluation of Fire throttling effect

(... the additional fire induced pressure losses due to sudden air expansion, higher velocities, buoyant effects and localized losses in the plume region. amplified for larger fires and longer tunnels...)

- Require a global simulation of tunnel and ventilation system to be evaluated
- **Can be significant for large fires (>100 MW) and long tunnels!**
- The number of jet fan pairs required to achieve critical velocity is highly dependent of the fire size

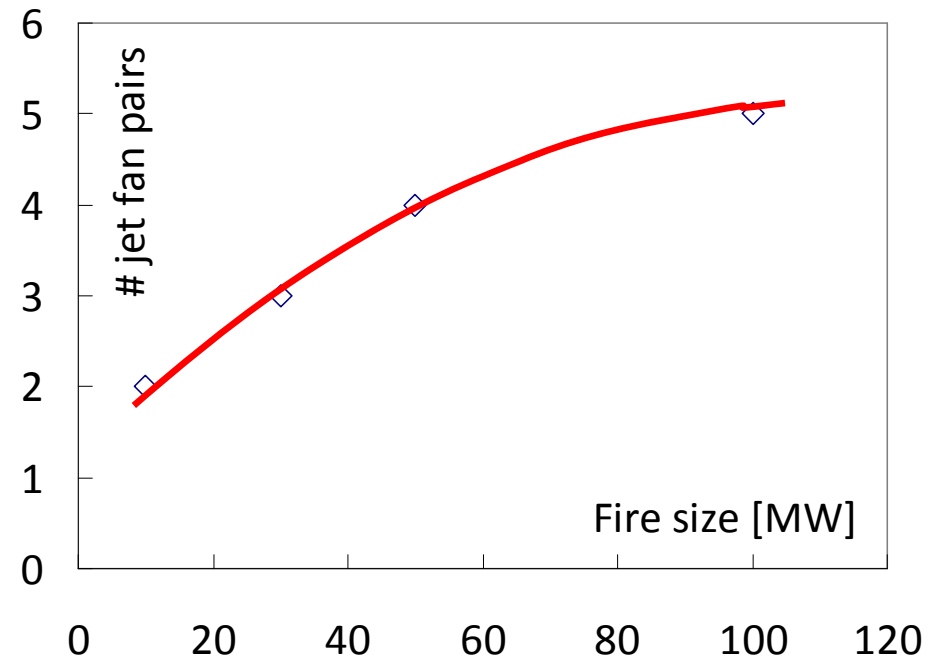

Conclusions (3)



Evaluation of the ventilation system response (Time required to remove back-layering)

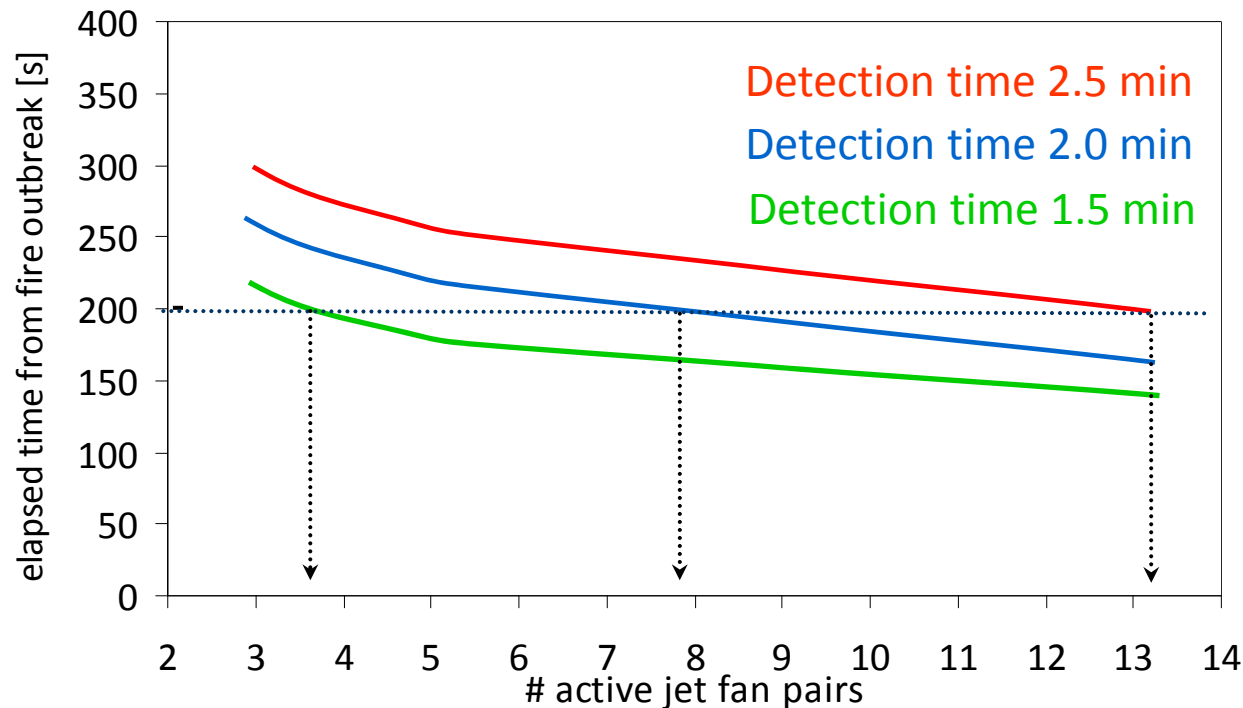

Significant impact of detection time on ventilation system response!

List of publications



Any questions?

Tunnel ventilation models - Network

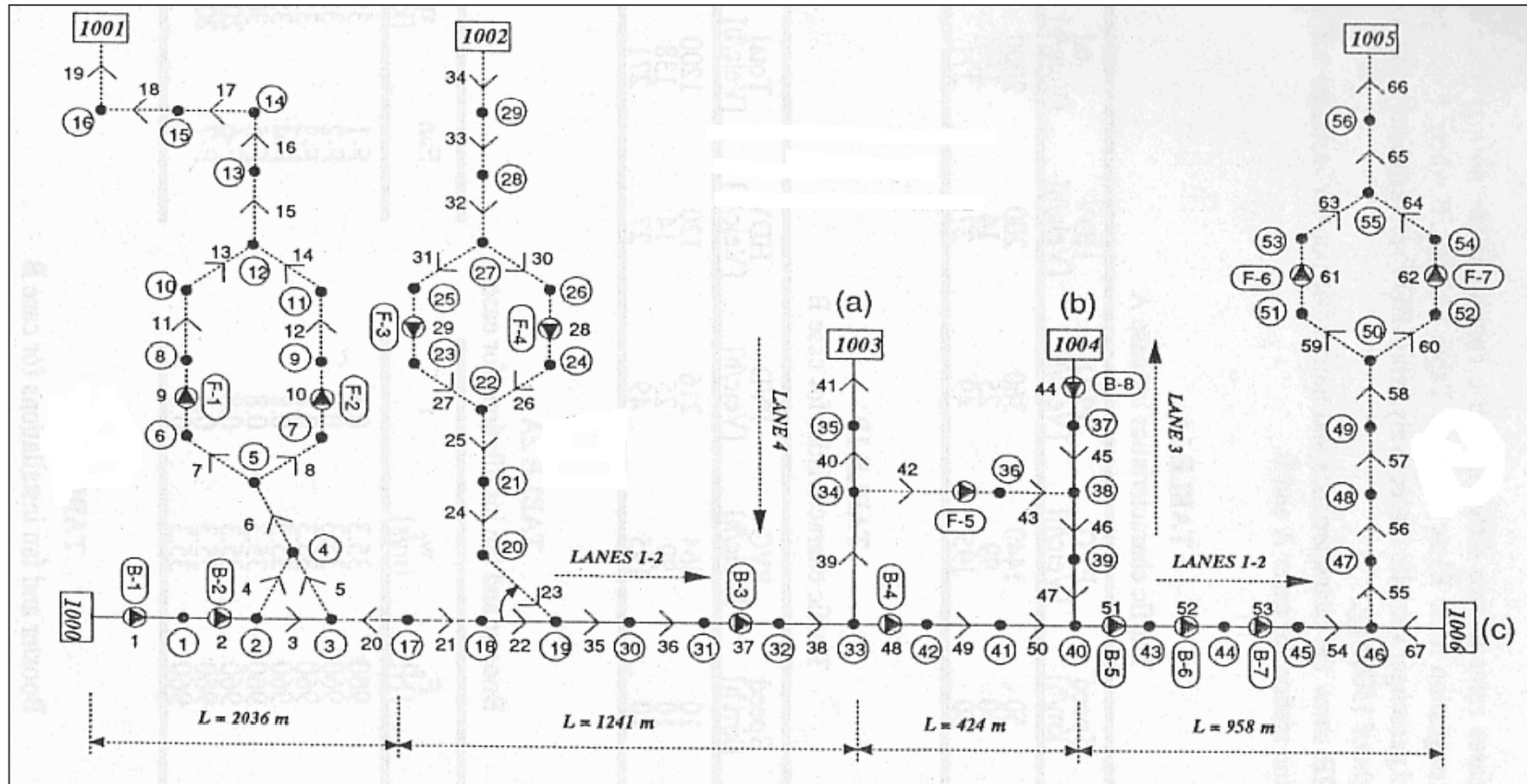

Modelling techniques – 1D Network

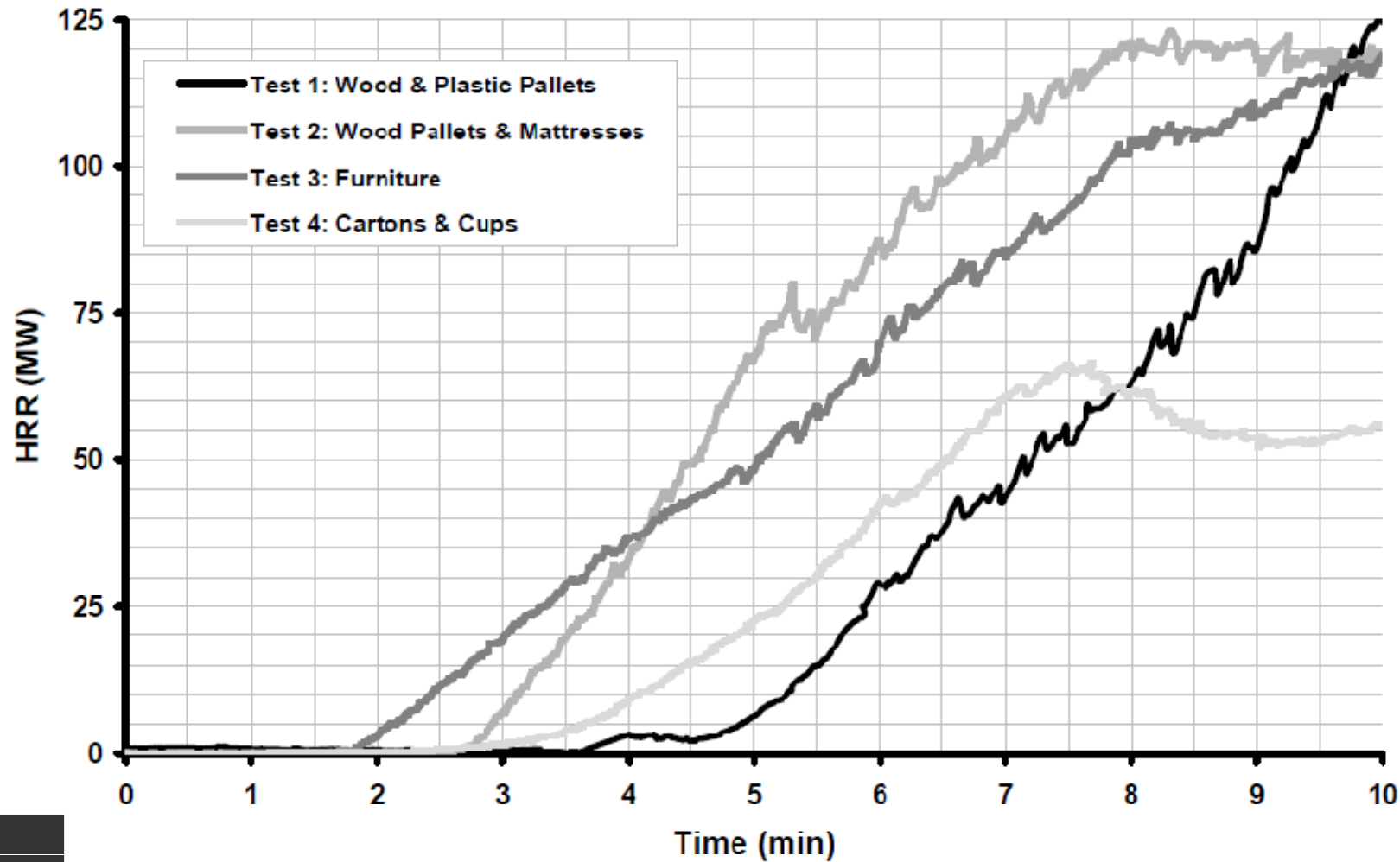

Modelling techniques – 1D Network



Jet fan characteristic curve

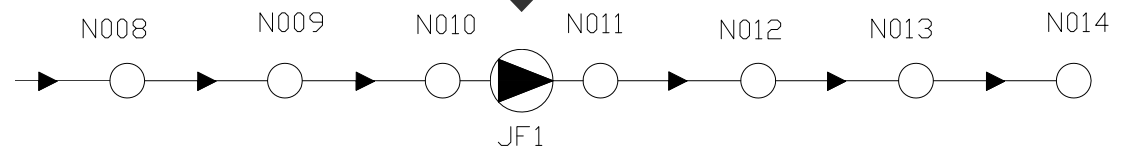
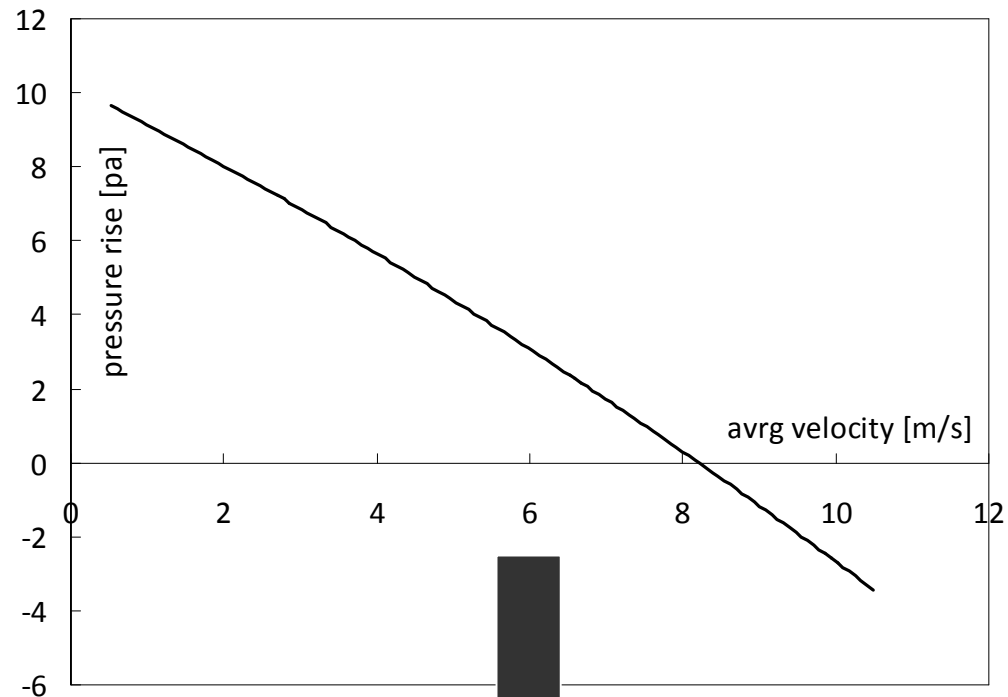

Multiscale – coupling procedure



- Residuals
- continuity
 - x-velocity
 - y-velocity
 - energy
 - k
 - epsilon

