

Seismic assessment and rehabilitation of a historical theatre based on a macro-element strategy

Original

Seismic assessment and rehabilitation of a historical theatre based on a macro-element strategy / Cennamo, C.; Chiaia, Bernardino; D'Angelo, S.; Ferretti, D.. - In: INTERNATIONAL JOURNAL OF ARCHITECTURAL HERITAGE. - ISSN 1558-3058. - STAMPA. - 5:(2011), pp. 264-295. [10.1080/15583050903560256]

Availability:

This version is available at: 11583/2382653 since:

Publisher:

Taylor & Francis Group, LLC

Published

DOI:10.1080/15583050903560256

Terms of use:

This article is made available under terms and conditions as specified in the corresponding bibliographic description in the repository

Publisher copyright

(Article begins on next page)

SEISMIC ASSESSMENT AND REHABILITATION OF A HISTORICAL THEATER BASED ON A MACRO-ELEMENT STRATEGY

Claudia Cennamo,¹ Bernardino M. Chiaia,² Sara D'Angelo,³ and Daniele Ferretti⁴

¹*Dipartimento di Cultura del Progetto, Seconda Università di Napoli, Aversa, Italy*

²*Dipartimento di Ingegneria Strutturale e Geotecnica, Politecnico di Torino, Torino, Italy*

³*Facoltà di Ingegneria, UTIU Università Telematica Internazionale Uninettuno, Roma, Italy*

⁴*Dipartimento di Ingegneria Civile, dell'Ambiente, del Territorio e Architettura, Università degli Studi di Parma, Parma, Italy*

The structural and seismic assessment of the 19th-century Petruzzelli theater in Bari (Italy) is presented. The macro-elements strategy was adopted to dismantle the whole structure in parts. The steel dome was verified through dynamic multi-modal analysis based on finite element model. Each masonry macro-element was firstly verified through a kinematic analysis aiming at excluding local collapse mechanisms. Afterwards, a nonlinear static analysis was carried out in order to evaluate its overall seismic capacity. The effectiveness of linear or nonlinear analyses and of the macro-element strategy compared with other modeling techniques is also discussed. After highlighting the structural deficiencies of the theater, upgrading solutions are proposed with consideration of the safety needs and the architectural preservation requirements based on the historical importance of the building.

KEY WORDS: masonry structures, macro-elements, vulnerability analysis, seismic retrofit, architecture of theater

1. INTRODUCTION

This work deals with the vulnerability analysis and seismic assessment of the Petruzzelli theater in Bari (Italy), a masonry building constructed in 1898 (Figure 1), which had been severely damaged by a fire in 1991. The article describes the seismic assessment of the building, which was committed to the authors by two Italian contractors.

The problem of interpreting the “masonry” material through a detailed structural model and of developing a proper mathematical model that is able to take into account all the mechanical characteristics is still not completely solved. This continued problem is due also to the fact that the architectural heritage in Europe and Asia is predominantly made of a variety of masonry structures including, under the term *masonry*, a wide range



Figure 1. View of the theater in a historical picture.

of materials with predominant inelastic behavior. Owing to the variability of the materials and of the construction techniques, and also to the difficulty to individuating the structural components (compared with modern reinforced concrete and steel structures), the studies on the mechanics of masonry are controversial, and cannot be carried without knowledge of construction techniques and materials characterization. In another regard, as many historical monuments testify with their remarkable durability, the construction methods of the past and the robustness of masonry buildings (if built “in accordance with the best practice”), have been able to withstand loads and ageing actions and even catastrophic events, like earthquakes, landslides, bombings or, as in the case presented here, fire.

Therefore, the approach to the analysis and retrofit design of the Petruzzelli theater, was based first on the evaluation of the original construction solutions and then on the maintenance of the basic static and architectural conception. The great variety of masonry textures does not allow the general usage of a single mechanical model, but it is necessary to consider the multitude of possible characteristics of the masonry, using a modeling strategy adherent to the real behavior.

The starting point is represented by the so called no-tension material (NTM) model. As well known from experimental evidence, volcanic tuff material (the basic constituent of the masonry of the theater) shows adequate compression strength associated to a very low tensile strength. In the past, in fact, these structures were designed for compression only, preventing the onset of traction, since also mortar bed-joints possess low resistance to tensile forces. However, in the case of structures formed by overlapping of regular rows of square blocks (i.e., the case of the walls constructed according to the “cultured” tradition), preferential fracture directions can be identified. When the joints are sufficiently staggered

with each other, assuming that there is no breakdown of individual stone elements and that damage spreads only through the joints, a reliable value of tensile strength can be introduced.

If one considers a masonry block subject to axial compression σ_y (MPa) in the vertical direction, and to traction in the horizontal direction, one can quantify a semi empiric value of tensile strength σ_t (MPa) acting during the process of crack opening, as proportional to the overall frictional force, i.e. to the density ω of brick rows along the panel height (m^{-1}), to the width s of the contact area between two overlapping blocks (m), and to the coefficient of friction f , as shown in Equation 1:

$$\sigma_t = -fs\omega\sigma_y \quad (1)$$

This relationship (Baratta and Voiello 1986) can be used when considering the shape of the masonry walls as bounded by preferential (or already existing) fracture surfaces. However, in a conservative approach, friction between walls can be neglected at the ultimate state.

Once the material model is chosen, the problem of identifying the overall structural behavior must be tackled. In this respect, it is very important to evaluate the stiffness relations between the structural elements, the connections between adjacent walls, and the force flow scheme, based mainly on the geometry of the bodies as the original designers conceived. Since the results of simple “art rules”, which are intuitive and somehow empirical, still resist the flow of centuries, some scientists have claimed the essential role of a specific approach for assessing the seismic safety (Giuffrè 1996).

Within the frame of the 2007 *Guidelines for the Evaluation and Mitigation of Seismic Risk to Cultural Heritage* and of the Eurocode 8 (2005), the seismic analysis of a structure can be performed by means of four approaches. The first two approaches—the (linear) lateral force analysis and the (linear) multimodal response spectrum analysis—require the so-called behavior factor q . For standard (regular) masonry structures, q is assigned by the Eurocode. But for a complex structure such as the Petruzzelli theater, which is made of different materials (e.g., steel, reinforced concrete and masonry) and of different structural elements, q is unknown. In principle, in the absence of any ductility, the minimum value $q = 1$ (that means, linear elastic behavior of the structure up to failure) could be used, but results would be too conservative. As a consequence, the seismic assessment would prescribe important retrofittings, even for the moderate earthquakes that the structure was able to resist in the past without significant damage. Moreover, $q = 1$ would produce unjustifiable retrofitting, that would alter the original structural conception of the building. For complex buildings, therefore, nonlinear approaches are preferred when the structure can display sufficient ductility (Magenes 2006; Galasco et al. 2004).

The third approach—the nonlinear time-history dynamic analysis—besides large computational efforts, requires knowledge of the cyclic (and anisotropic) constitutive laws of the different materials. These laws are very difficult to be calibrated on historical masonry because experimental tests are often not feasible and, if theoretically feasible, scarcely reliable. When the knowledge of material properties or structural detailing is poor, this powerful method may not be able to improve the accuracy of the analysis. Moreover, the above approach shows many computational problems (e.g., numerical convergence) when fractures and damage spread through the structure, making difficult to estimate the real collapse behavior.

In the framework of the fourth approach—nonlinear static analysis—the constitutive laws are monotonic and time behavior is not required. However, this method is applicable with the exception of complex masonry structures, for which appropriate procedures accounting for the peculiarities of the construction typology need to be used (Eurocode 8 2005). This use of appropriate procedures is even more important when a steel dome is placed upon a (nonregular) masonry structure, as in the considered case.

To overcome these problems, the structural analysis was based on the macro-elements strategy proposed by the recent Italian Guidelines (2007) for the conservation of architectural heritage in the seismic areas, which are inspired by the seismic Eurocode 8 (2005). The macro-element strategy of modelization—dismantling a complex structure in simple parts—represents one of the most flexible and effective tools for the structural analysis and assessment of historical churches, mainly due to materials heterogeneity and typological complexity, which are factors normally encountered also when dealing with historical buildings and theaters (Guidelines 2007; Lourenço 2001).

The Petruzzelli theater is one of the first case studies based on these 2007 Guidelines, which are today mandatory for all the historical buildings in Italy. The main issue was to divide the complex structure in simpler and more regular parts called *macro-elements*, which were analyzed separately, and to explain how to model them. In this way, the continuum behavior of the whole building under small loads is missed (e.g., the *damage limit state* is not modeled), but the ultimate (*collapse*) limit state is correctly modeled provided the correct choice of the macro-elements is made.

To recognize the structural macro-elements, an in-depth survey of the building's structural organism was carried out. As is well known, when fractures and detachments are evident, individuation of the macro-elements is trivial. Instead, when they are not present (or not visible due to previous retrofit), the choice of the macro-elements must be carried out with great accuracy, taking into account not only the original architectural and functional destination, but also the most probable patterns of weakness where fractures will appear under the earthquake.

In the case of historical buildings and theaters it is not clear how to define the macro-elements. Thus, the Petruzzelli theater is presented as a paradigmatic example to show the problems encountered defining the macro-elements and modeling them. In the Petruzzelli theater, the selected macro-elements are the following: the frame system constituted by the steel dome and the suspended wood false dome, the parts of the masonry walls delimited by weakness lines, the wood and reinforced concrete roofs, the scenic tower, the pediment front above the main entrance, the stage block, the lights carrying steel bridge, and the concrete foundations. The steel dome was verified through dynamic modal analysis based on a finite element model. Each masonry macro-elements was first verified through a kinematic analysis aiming at excluding local collapse mechanisms. Afterwards, a nonlinear static analysis was carried out to evaluate its overall seismic capacity. The selected macro-elements are generally linked with one another through unilateral and smooth constraints, which ensure a realistic transmission of actions among the different parts of the structure. Finally, specific rehabilitation and consolidation solutions are proposed in the paper, aiming at solving the structural deficiencies revealed in the assessment phase, and taking into account at the same time the architectural requirements coming from the historical importance of the building.

To help the readers, a brief excerpt of the calculations prescribed by the 2007 Guidelines is presented in the Appendices, and the reader is directed to the references for what concerns their mechanical bases. However, the purpose of the article is not to present

a technical report (i.e., a quantitative analysis), but instead to discuss the advantages and the limits of the Italian standards, showing which theoretical improvements are still necessary. To analyze the Petruzzelli theater, several issues had to be solved, since the 2007 Guidelines and the case histories published in the literature are mainly based on churches and not on historical theaters.

2. HISTORICAL BACKGROUND

The history of the Petruzzelli theater in Bari (Italy) began in 1896 when the Petruzzelli brothers felt the need to have a cultural container fit to a town eager to reach the cultural level of the other Italian cities. Two years later, in October 1898, the construction of the building started, and the theater was opened in February 1903. The plan scheme was that of a classical theater for opera and concert events (Figure 2).

The theater was enriched by precious wall paintings. Wood chairs, statues, and beautiful architectural solutions made it a jewel well renowned in Italy and Europe. The Petruzzelli theater rapidly became the symbol of a town willing to have the role of a small European capital. Much dramatically, the doors of the Petruzzelli theater have been shut until 2009, since in the night of October 26, 1991, a great fire (of unknown origin) completely destroyed the inner parts of the buildings, provoking collapse of the steel dome and damaging, to a variable extent, also several floors and vaults, and even a small part of the principal masonry walls (Figure 3).

Immediately after the fire, the population of Bari started pressing for the restoration of the theater. Unfortunately, due to a long controversial legal and economical situation, the

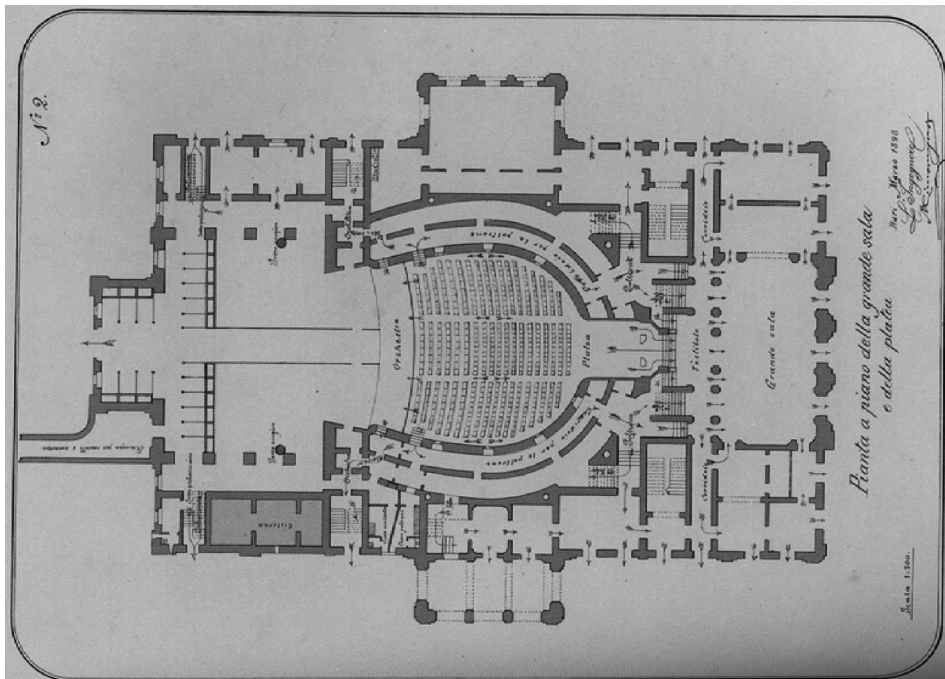

Figure 2. View of the original plan of the theater.

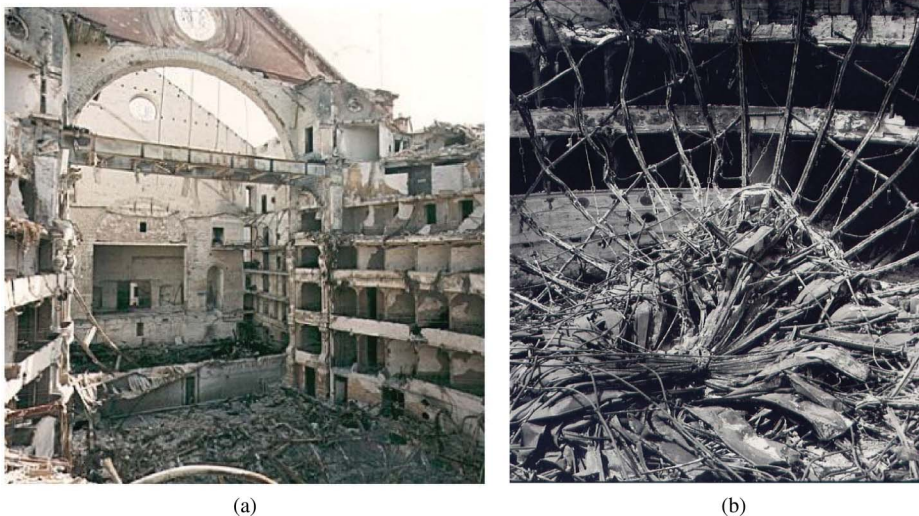

Figure 3. Photographs of the theater damage after the fire: global view (a, left); collapsed steel dome (b, right).

retrofit design and the rehabilitation works were delayed for more than 10 years, despite the conspicuous funds assigned from the central government. Only in 1994 the steel dome was rebuilt, in order to protect the indoor spaces from bad weather conditions.

In 2001 the project of structural rehabilitation and functional reorganization, was approved. The project was based on two hypotheses: maintain and respect the original structure and materials, and enrich the building with modern safety measures and new functions (ATP Berardi et al. 2003). The intent was to restore the appearance of the theater before the fire, with exactly the same decorations, interiors and structure, at the same time introducing new functional spaces. However, the new structure was designed according to the codes holding at that time, and therefore it was not fulfilling the new anti-seismic rules for cultural heritage introduced later (Ordinance 3274 2003; Guidelines 2007). Therefore, a completely new assessment of vulnerability and seismic retrofit was necessary, and its conception is described here.

3. HYPOTHESES FOR STRUCTURAL MODELIZATION

3.1. Codes and Reference Standards

The seismic analyses and verifications of the structures were performed in accordance with the Italian standards Ordinance 3274 (2003), Ordinance 3431 (2005), and Guidelines (2007), the latter specific standards for historical buildings, and with the Eurocode 8 Part 3 (Eurocode 8 2005). These new standards, also based on the capacity design strategy, represent an innovative approach for the seismic design. With specific reference to the cultural heritage, the Guidelines (2007), allows the designer to take into account the specific characteristics of historical buildings, and let the requirements be in some sense “relaxed”, to avoid heavy retrofits and conducting the designer to exploit at its best the original inherent robustness and strength of the old building rather than modifying its structural conception.

3.2. Material Properties and Seismic Action

The structure of the masonry walls of the Petruzzelli theater appears to be particularly consistent and well built. Despite the terrible thermal shock, no major cracks were detected, with the exception of a series of small cracks on the sidewalls in the area of the foyer (ATP Berardi et al. 2003). The masonry consists of square cut blocks of limestone tuff, with good quality lime mortar bed-joints. The specific weight is approximately equal to 18 kN/m^3 . Due to preservation rules, it was not possible to perform a complete experimental campaign to measure the mechanical properties of the tuff masonry. Considering the dimensions of the tuff blocks, measuring the shear strength in-situ would require testing masonry panels of huge dimensions (larger than 1 m square); however, this testing is not acceptable because of the historical importance of the building. For this reason, following the 2007 Guidelines, reference is made to the conventional average values of the mechanical parameters for similar materials published in Table 11.D.1 of the Ordinance 3431 (2005). Due to the high compression strength of the limestone tuff used (i.e., larger than 780 N/cm^2), and in accordance with Table 11.D.2, the average strength values are multiplied by a factor 1.2 to consider the good quality of the mortar, and by another factor equal to 1.2, to take into account the presence of connecting elements within the thickness of the walls. The final values substantially agree with the ones measured by Ceroni et al. (2004) for a similar tuff masonry confirming that such approach provides reasonable values when applied to limited geographical regions, characterized by the same building traditions (Magenes 2006).

The design values of the mechanical properties of the materials are eventually obtained by dividing the average values of strength by the so-called “confidence factor” F_c introduced by the Guidelines (2007). This factor is a function of the level of knowledge KL of the structure under examination, and gradually decreases with the accuracy of the investigation. In the case of ancient historical building, the Guidelines (2007) provide $1.00 \leq F_c \leq 1.35$, and define four levels of accuracy related to the different aspects of the building knowledge (i.e., geometric survey, materials and construction survey, mechanical properties of the materials, terrain and foundations). In the case of the Petruzzelli theater, F_c turns out to be equal to 1.21.

The mean and design values of the elastic moduli E and G , of the compression strength f_m and of the shear strength τ_0 are reported in Table 1.

This table summarizes the mechanical properties of the steel of the dome structure (i.e., steel type Fe360 or S235 according to Eurocode 3 classification), including the ultimate and the yielding strength (respectively, f_t and f_y), the elastic modulus E , and the ultimate strain ε_t . These values are those prescribed by the Codes at the time of the design operations.

The elastic spectrum is defined according to the Ordinance 3274 (2003). More specifically, the city of Bari is classified as Zone III and the soil is a limestone lithotype with

Table 1. Mechanical properties of the masonry and steel

Masonry	$f_m(\text{N/cm}^2)$	$\tau_0(\text{N/cm}^2)$	$E(\text{N/mm}^2)$	$G(\text{N/mm}^2)$
Mean	504	12.7	3096	516
Design	417	10.5	2560	425
Steel	$f_t(\text{N/mm}^2)$	$f_y(\text{N/mm}^2)$	$E(\text{N/mm}^2)$	ε_t
Characteristics.	360	235	200000	24%

good mechanical characteristics, which can be classified as “type A”. Since no unfavorable typological conditions exist, the peak ground acceleration was considered equal to $S a_g = 0.15g$, where $S = 1$ is a soil-related parameter. Referring to the Guidelines (2007) and due to the specific character of the building, $S a_g$ was multiplied by a relevance factor $\Gamma_1 = 1.2$, i.e., the value corresponding to a *highly important* building with *very frequent* use. The horizontal and vertical elastic response spectra are shown later in Figure 15a.

3.3. The Macro-Element Strategy for Structural Analysis

The tradition of correct building of squared stone masonry, which Vitruvius attributes to the Greek tradition, became the *opus quadratum* in the Roman age. It developed into the construction of masonry consisting of perfectly squared blocks, by superposing two rows of bricks: the *ortostati*, namely blocks aligned with the longest side in the direction of the wall, and the *diatoni*, where the blocks had their longest side orthogonal to the wall (Figure 4).

Unlike chaotic masonry (e.g., from the popular tradition), the construction of walls like those present in the Petruzzelli theater, obeys strict geometric rules, both as regards the brick shape, and as regards their mutual position. For the optimal performance of the structure, mortar was interposed between the stone elements, with great accuracy and regularity, and therefore the Petruzzelli masonry obeys the so-called “art rules”. Therefore, masonry crumbling can be excluded and a structural analysis is feasible.

Giuffrè (1991), in fact, observed that masonry elements made according to the “art rules” possess monolithic wall behavior, even without mortar, and can be considered the first archetypal and intuitive expression of a macro-element. A *macro-element* then was defined as the basic structural component made of small pieces, which together behave as a whole (Giuffrè 1991). The macro-element definition was developed and extended later by Doglioni, Moretti, and Petrini (1994) with reference to old churches (Figure 5). The authors affirmed:

a macro-element is a part of a structure recognizable from the constructive point of view, that can coincide—but not necessarily coincides—with a part identifiable also under the architectural and functional points of view (e.g., façade, apses, chapels); it generally includes an entire wall or a floor, but it often includes more walls and

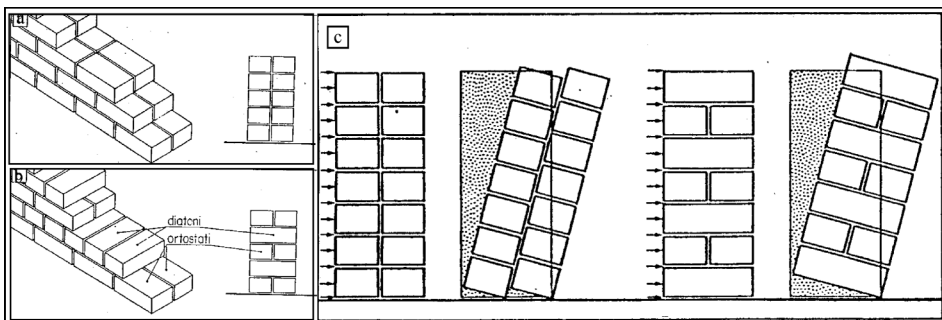

Figure 4. Illustrations of the simple assembled brick wall (a), the ortostati and diatoni masonry wall (b), and different behavior between the wall represented in (a) and the wall in (b) (Giuffrè 1991).

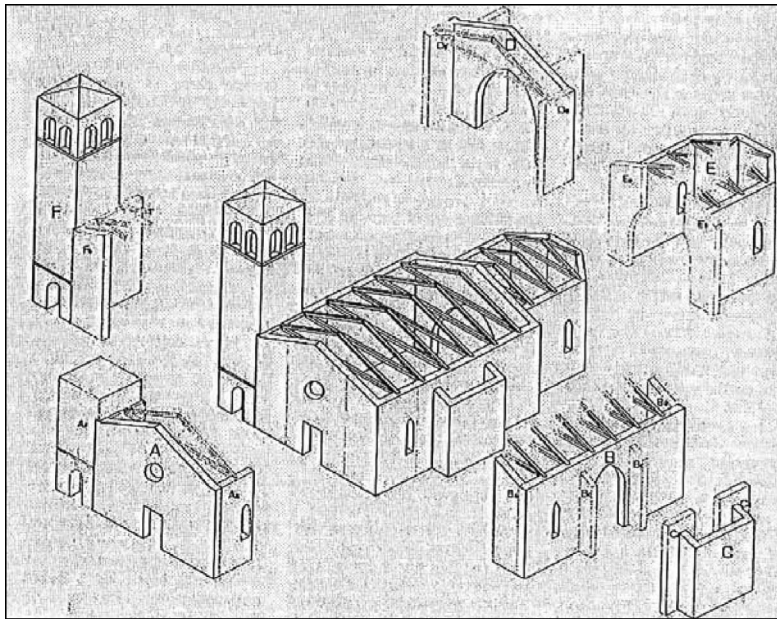

Figure 5. Subdivision of a church in macro-elements (Doglioni, Moretti, and Petrini 1994).

horizontal elements, connected one with each other, constituting a unitary part even if generally linked and not independent from the rest of the construction (320).

The Ordinance 3274 (2003) adopted the definition of Doglioni Moretti, and Petrini (1994), asserting that this kind of analysis "has a real meaning if the monolithic behaviour of the masonry wall is ensured, and local collapses due to masonry crumbling can be excluded" (128). Starting from this definition, it is clear that a modeling technique based on macro-elements is actually possible when a monolithic part of masonry (which does not mean rigid body) can be clearly recognizable.

In order to avoid confusion, it is worth to point out that, the concepts of macro-element and of macro-block (i.e., a part of the structure with rigid body behavior) are not the same. As will be shown in the following, the definition of a macro-element is independent of the model adopted for its analysis. In fact, for example here, the steel dome macro-element was modeled as a linear elastic spatial truss, the masonry walls were modeled by means of a nonlinear pushover analysis, whereas the pediment collapse was analyzed through a rigid body tilting mechanism.

The macro-elements can be identified starting from the knowledge of the seismic behavior of similar buildings already damaged by previous earthquakes. This knowledge is the case, for example, of old churches, where typical collapse mechanisms are very often detected, and therefore an abacus of macro-elements has been defined. In addition, they can be recognized by observing possible crack paths, not necessarily due to the earthquakes. The degree of connection among the masonry walls has also to be considered, together with the masonry texture, as the presence of metallic ties and the interaction with other elements of the structure and/or with nearby buildings. Thus, in the theater, the definition of macro-elements is the key issue. Generally the parts are not completely independent

but interact with each other through unknown forces and ignoring these forces violates equilibrium. This is the main objection for the analysis of buildings with macro-elements (De Sortis, Decanini, and Sorrentino 2009).

A solution can be obtained by cutting the structure in zones where the interactions with other macro-elements can be easily modeled, or where interaction forces are known (e.g., null). In particular, the existing cracked zones are usually preferred, especially if the cracks were generated by earthquakes. If the friction between the lips of the cracks is negligible, they behave like structural joints. Along the cracks the macro-elements can be linked with one another through unilateral and smooth constraints, which ensure a realistic transmission of actions among the different parts of the structure. Instead, when fractures and detachments are not present (or not visible due to previous retrofit), the choice of the macro-elements can be carried out considering the most probable patterns of weakness where fractures will appear under the earthquake (e.g. openings, chimneys hidden into the walls, and poorly connected orthogonal walls). Of course this approach is possible for the collapse limit state only.

Following this general rules, in the case of Petruzzelli theater, the timber roofs, the lights carrying steel bridge and the steel dome were easily identified as macro-elements, considering their peculiar architectural and functional destinations. The interaction with the masonry building was introduced through simplified models of the masonry that are able to represent its dynamic “filtering effect”.

The definition of the macro-elements for the masonry building was more complex. In order to recognize the crack patterns and the weak zones, an in-depth survey of the building’s structural organism was carried out. This survey permitted observation that some parts of the masonry building were connected by very weak lintels represented by masonry arches. According to the Ordinance 3274 (2003), the strength of these lintels must be considered null (although they fail only when a conventional displacement/rotation is attained). In other words, since the lintels are not able to transmit actions, they naturally divide the building into macro-elements. Thus, the selected masonry macro-elements were the scenic tower, the pediment front above the main entrance, and the stage block. Figure 6 schematically shows a plan view of the theater, highlighting the areas where the macro-elements are located.

4. ASSESSMENT AND HYPOTHESIS OF STRUCTURAL UPGRADE

The global seismic verification of the building has been carried out by considering the previously described macro-elements. The steel dome was verified through a dynamic modal analysis based on a finite element model. Each masonry macro-element was firstly verified through a kinematic analysis aiming at excluding local collapse mechanisms. Afterwards, a nonlinear static analysis was carried out in order to evaluate its overall seismic capacity.

4.1. Steel Dome and Suspended Timber False-Dome

The finite element structural model for the seismic assessment of the steel structure is constituted of the main supporting masonry walls and of all the steel elements belonging to the dome (Figure 7). Including the masonry structure, although in a simplified way, permits to model its filtering effect and the interaction among structural

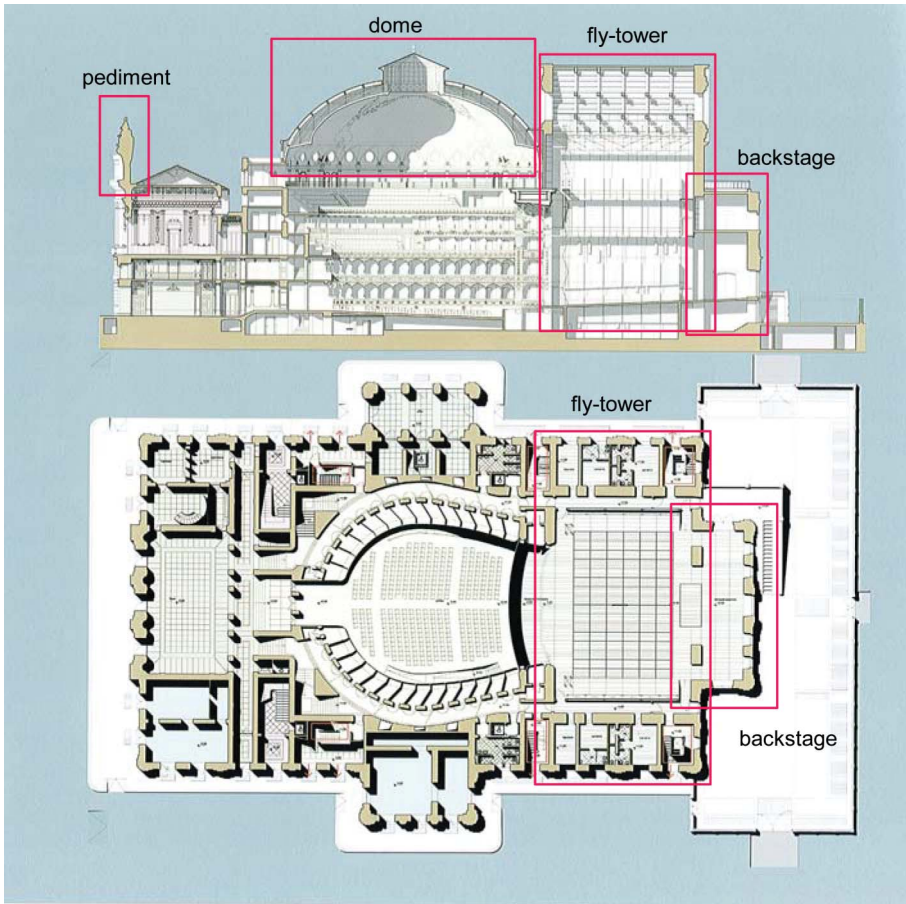

Figure 6. Illustrations of the plan view and location of the macro-elements.

elements having very different stiffness. The dome is made of 36 sectors, i.e. 36 trussed meridians that lay on 36 cruciform columns, eight parallel tension rings (one trussed bottom ring, six intermediate rings with cruciform cross section, one top ring with a compact cross-section).

As shown in Figure 8a, the structure is X-braced along the first circular ring, while in the upper rings only one brace for each field is present. Most columns are supported by perimeter walls. In the area above the stage, columns originate from a steel girder, constituted of two main beams simply supported by the masonry, connected by orthogonal beams (Figure 8b). The timber false-dome will be suspended to the dome steel structure by means of cables departing from each meridian beam. The mechanical properties of steel are summarized in Table 1.

4.1.1. Seismic assessment The seismic assessment has been carried according to the damage and collapse limit state approach. In particular the following verifications have been conducted:

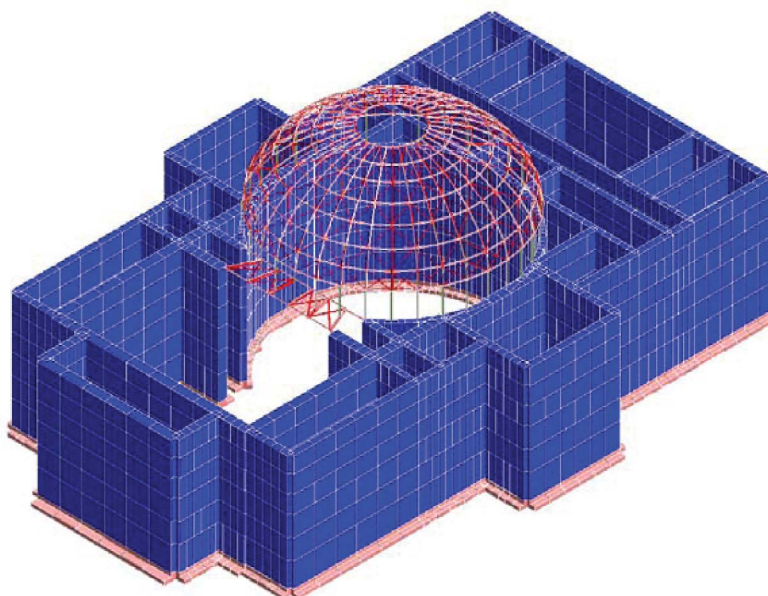

Figure 7. Three-dimensional (3D) view of the computational model of the steel dome supported by the masonry walls and the steel girder.



Figure 8. Photographs of the view of the dome bracing system (a), and the dome support to the girder and to masonry (b).

- Gravity loads: Considering the combinations involving gravity loads only, the columns supported by the steel girder and some elements belonging to the inferior ring, do not satisfy the checks.
- Seismic load: the multimodal response spectrum analysis was carried out. The seismic action intensity is defined in Section 3.2. The behavior factor $q = 1.5$ is adopted, according to the Ordinance 3431 (2005) with reference to masonry-steel mixed structures. The corresponding horizontal design spectrum is represented in Figure 15a. As

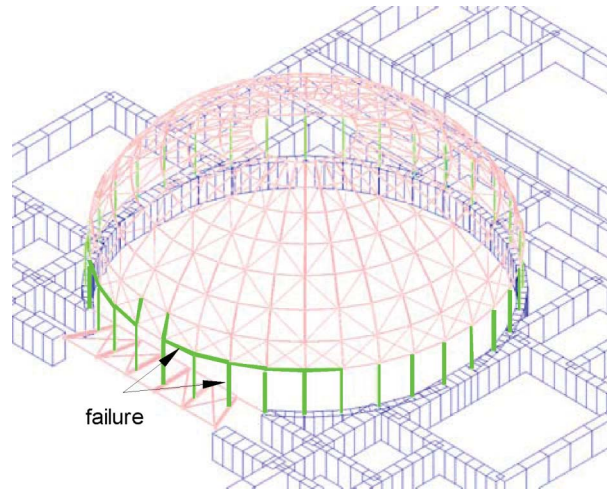

Figure 9. Illustrations of the steel elements at the bottom rings not satisfying the collapse limit states checks under seismic condition (failing elements are represented with a thick line).

shown in Figure 9, all the columns at the base of the dome do not satisfy the limit damage checks. Moreover, large displacements of the dome are predicted: approximately 5.5 cm for the most severe combinations of loads, 2.8 cm in the horizontal direction; 4.8 cm in the vertical direction. The relative displacement between the bottom and top rings was close to 8 cm in the horizontal direction due to the anti-phase oscillation of the rings.

As shown in Figure 10a, a peculiar solution had been conceived by the original designers, which was maintained in the reconstructed dome. The vertical steel columns of the dome are practically hinged at the base. In the numerical model, the boundary conditions at the connection between steel columns and masonry were modeled through hinges with linear



Figure 10. Photographs of the rigid steel frame solution (a), and timber solution adopted by a Japanese Torii (b).

elastic rotational springs, whose stiffness has been defined considering the real constructed node scheme according to Appendix J (rotational stiffness of column joints) of Eurocode 3 (2003).

The horizontal resistance of the first ring (which is not braced) is ensured by the stiff horizontal truss beam that connects the top of the columns. This is practically the same solution adopted, since centuries ago, at the bases of timber Japanese gates (the so-called *Torii*, Figure 10b), whose frames composed of columns hinged at the base and connected at the top to a couple of timber beams by means of movable joints, have overcome a multitude of earthquakes with success. Regarding the drawbacks of this solution (e.g., deformability), in order to keep the original structural scheme of the dome, the horizontal stiffness of the complex was increased by using a rigid flooring system.

4.1.2. Hypothesis of structural upgrade The analyses highlighted that stiffening of the floor allows to reduce considerably the amplification of the seismic effects in the bearing masonry elements, and to reduce substantially the seismic displacements at the base dome level and the relative displacements between the base and the top of the steel dome. The rigid floor will be realized by welding steel plates to the existing I-beams below the concrete floor. Moreover, in order to exploit the in-plane stiffness of the concrete floor, the base ring of the dome will be connected to concrete by means of a string course (Figure 11).

4.2. Masonry Structures

The seismic assessment of the masonry macro-element was performed in two steps. The first step considered the out-of-plane local failure mechanisms that may occur in some parts of the macro-element. Then, the second step dealt with the whole macro-element analyzing the in-plane behavior of its masonry walls.

4.2.1. Local failure mechanisms In historical masonry buildings, the prescriptions introduced in modern seismic codes to prevent local out-of-plane failures are frequently unsatisfied. Moreover, poor brickwork connections or lack of ties, bond beams, and rigid horizontal floors are commonly seen. Therefore, when analyzing the seismic behavior of historical masonry buildings, it is crucial to start by checking the local mechanisms (Guidelines 2007). In the case of churches, the choice of the most vulnerable mechanisms



Figure 11. Photographs of the present configuration of the floor around the base of the steel dome (a), and localization of the string course at the concrete floor level (b).

is supported by abacus based on the experience of several case histories (Ordinance 3274; 2003; Guidelines 2007). For theaters, similar charts are not available and the choice of the local mechanism is guided mainly by the survey of existing vulnerability indicators, like weakness produced by cracks, voids or poor connections (as noted Section 3.3). In this work, according to the Guidelines (2007), the local mechanisms have been analyzed by means of the two procedures described in the Annex 11.C of the Ordinance 3274 (2003): linear kinematic analysis (LKA) and nonlinear kinematic analysis (NLKA).

The mechanism is modeled by means of pin-connected rigid blocks made of a no-tension material with infinite compressive strength (thus the pins are placed at the corners of the blocks). Moreover, friction and fracture energy involved during the separation of the blocks are neglected.

In LKA the equilibrium of the mechanism was studied by means of the principle of virtual works to obtain the acceleration a_0 , which activates the mechanism. Then, the corresponding acceleration a_0^* of an equivalent linear single degree of freedom (SDOF) system was computed. This was compared to the acceleration demand a_d prescribed by the Ordinance in the Appendix 11.C (Ordinance 3431 2005). In particular, the Ordinance simply prescribes that the design spectrum adopted in the calculations be the one corresponding to the behavior factor $q = 2.0$ (which, incidentally, is the value prescribed for nonstructural elements like partitioning walls and ceilings), without the necessary distinction between different typologies of masonry and mechanisms. This reduces the demand, thanks to nonlinearities, and provides a less conservative approach that can be justified under a sufficiently ductile mechanism behavior.

In another regard, in this case the capacity curves of most macro-elements will show that a certain ductility of the old unreinforced masonry exists (Figure 15b, c in section 4.2.2), and this justifies a value of $q > 1$. Moreover, the masonry possesses an overall good quality, even after the fire, and has already experienced important earthquakes (such as the November 1980 earthquake in southern Italy) without significant damage (which would not be explicable by using $q = 1$). The seismic assessment is considered verified if the ratio capacity/demand $a_0^*/a_d \geq 1$. The analytical details are summarized in Appendix I.

In NLKA the equilibrium of the local mechanism was studied step by step considering subsequent current configurations. The corresponding accelerations, which are obtained again by means of the principle of virtual works, permit to obtain a non linear capacity curve which takes into account the evolution of the applied forces during motion (i.e., to take into account the failure of a steel tie). This curve was then transformed into the capacity curve of an equivalent nonlinear SDOF system, which was used to define a secant linear SDOF system. The curves are depicted in Figure 12 together with the demand curve, which corresponds to the pseudo acceleration elastic response spectrum prescribed by the Ordinance 3274 (2003) for non-structural elements (in the acceleration-displacement form according to Mahaney et al. 1993; Freeman 1998). The demand displacement Δ_d can be obtained from the intersection between the demand curve and the capacity curve of the secant system (Figure 12). This is then compared to a conventional displacement capacity d_u^* : the structure is verified if the ratio capacity/demand $d_u^*/\Delta_d \geq 1$. The analytical details are summarized in Appendix I.

According to the Guidelines (2007), to take into account the model uncertainties, the capacities a_0^* or d_u^* must be divided by the confidence factor F_c . The considered collapse mechanisms of masonry elements are represented in Table 2. Results of kinematic analyses, which are ranked from the more to the less vulnerable in the bar-charts of Figure 13, are discussed in the next paragraphs.

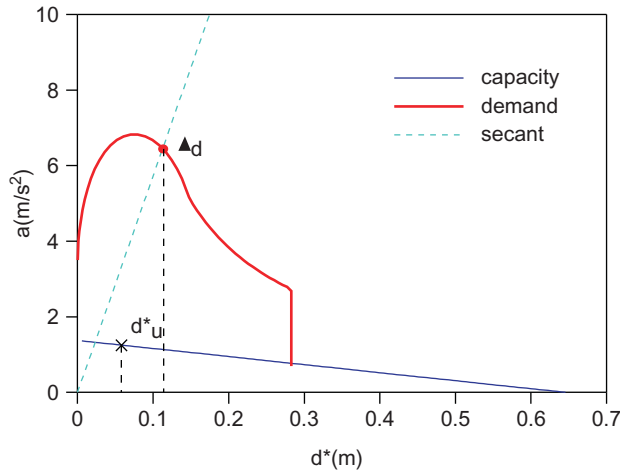

Figure 12. Graph of the nonlinear kinematic analysis (mechanism M1).

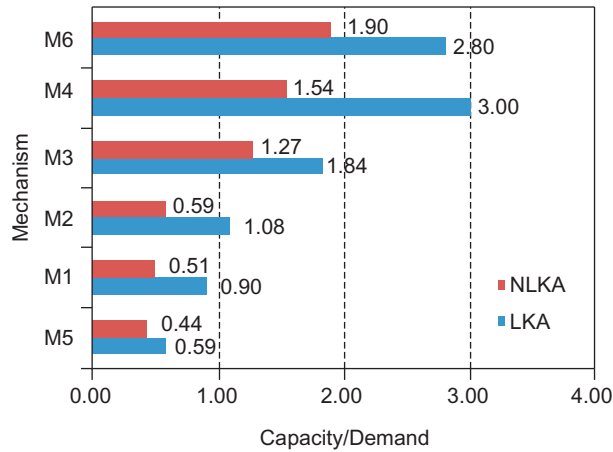
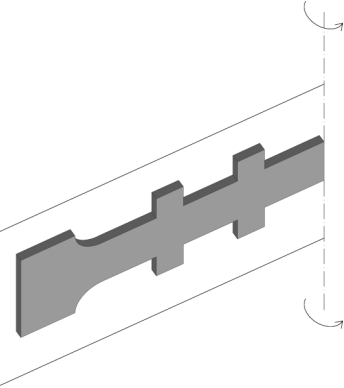

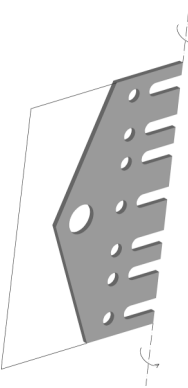
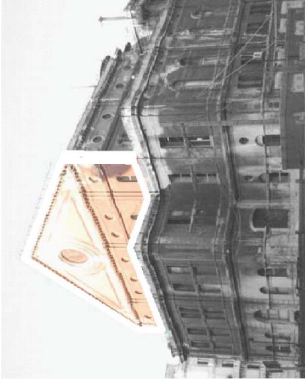

Figure 13. Graph of the results of linear (LKA) and nonlinear kinematic analyses (NLKA).

4.2.2. Global failure mechanisms The global behavior of the masonry macro-elements was studied by non-linear static analysis (pushover) according to Ordinance 3274 (2003) and Guidelines (2007). The regular geometry and the layout of the openings suggested to model the masonry walls with equivalent planar frames. In particular, Figure 14 shows a portion of a wall and its equivalent frame model made of horizontal and vertical shear deformable beams, connected by rigid links (thick lines in Figure 14). The approach, although simplified with respect to two or three-dimensional finite elements (plates and bricks), was shown to provide reliable results (Kappos et al. 2002; Roca et al. 2005) and was prescribed by the Ordinance 3274 (2003) for new as well as for existing masonry structures. At the edges of the beams, perfectly plastic hinges with limited ductility are introduced to model nonlinear flexural behavior. Failure occurs when the ultimate rotation is attained. To represent nonlinear shear behavior, a perfectly plastic shear

Table 2. Abacus of mechanisms

Zone	Mechanism	Scheme	Picture
Entrance	M1		
Fly Tower Pediment	M2		

Fly Tower Pediment M3

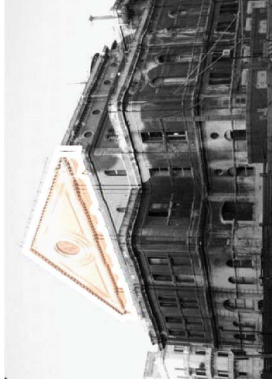
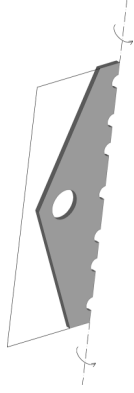

Fly Tower Pediment M4



(Continued)

Table 2. (Continued)



Zone	Mechanism	Scheme	Picture
Entrance Pediment	M5	 <p>A 3D schematic diagram of a pediment mechanism. It shows a dark grey, curved, dome-like structure with a pointed top, mounted on a base. The structure is shown in a perspective view, with a dashed line indicating its vertical axis. The base is a simple rectangular block.</p>	 <p>A photograph of a building's entrance. The entrance is framed by a large, ornate pediment. The pediment is dark red and has a white outline. The building is made of dark stone or brick and has several arched windows above the entrance.</p>
Backstage	M6	 <p>A 3D schematic diagram of a backstage mechanism. It shows a dark grey, T-shaped structure with a central vertical column and a horizontal base. The structure is shown in a perspective view, with a dashed line indicating its vertical axis. The base is a simple rectangular block.</p>	 <p>A photograph of a building's backstage area. The backstage is a dark, rectangular structure with a white outline. The building is made of dark stone or brick and has several arched windows above the backstage.</p>



Figure 14. Photograph of the lateral wall of the fly tower and its frame model.

hinge is introduced in the middle of the beam. Failure occurs when ultimate displacement is reached. Details of the model are summarized in Appendix II. Of course the approach does not permit to study the typical cross-shaped shear cracks into the beams. However, it allows to reproduce correctly its global deformability, shear strength and failure. The conventional definition of ultimate displacements proposed by the codes (Eurocode 8 2005; Ordinance 3274 2003) is based on the results of several cyclic tests. The use of plastic hinges permits a straightforward check of the attainment of ultimate rotation/displacement and to set the value of the moment/shear equal to zero.

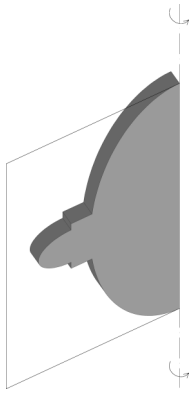
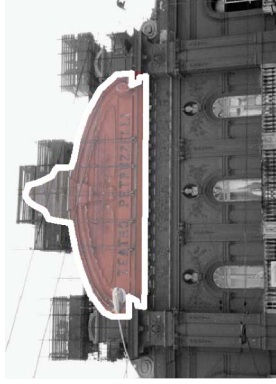
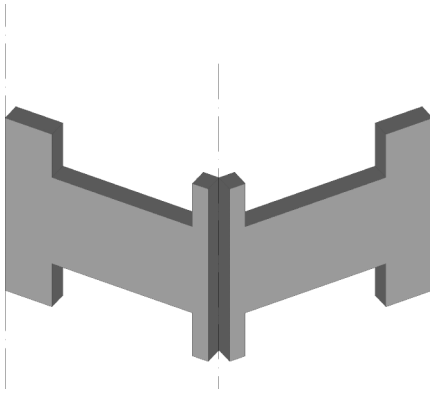
The model is completed with horizontal rigid diaphragms, which are introduced to represent the newly constructed reinforced concrete slabs, whose reactions are applied directly to the frames. The original horizontal diaphragms of the theater are realized with steel beams and brittle masonry vaults retrofitted with a reinforced concrete tapping (thickness, 40–50 mm) which was not well connected to the walls, therefore they were considered as deformable. As pointed out by Magenes (2006),

usually retrofitting interventions may lead to a stiffening of the diaphragm, but not to the extent where it can be considered as rigid, in a global analysis. In such situations, all methods of analysis currently available to designers tend to give a rather approximate picture of the response (17).

Orthogonal frames are considered as connected to each other, as the assembly of masonry is efficient. The vertical loads are represented by the dead weight of masonry and by the reactions of floors and of roof trusses.

Two distributions of horizontal seismic forces, which are required by the Ordinance, were applied alternatively for the orthogonal directions x and y : proportional to the masses (M_x , M_y), and proportional to the displacements of the first vibration mode (FVM $_x$, FVM $_y$). The latter distributions are less important because, according to Tomazevic (1999), in masonry buildings with deformable floors, the distribution of seismic forces close to collapse is nearly uniform, i.e., proportional to the masses. In the case described here, a force distribution was applied proportional to the first mode (assuming rigid floors), to investigate the possible effects of floors.

Increasing the horizontal forces, the pushover curve, which represents the resultant of horizontal forces vs. the horizontal displacement of a reference point, was obtained. This non-linear curve was then transformed into the capacity curve of an equivalent elastic-plastic SDOF system with ultimate displacement d_u^* (Figure 15b and 15c). The demand curve, which is represented by the elastic spectrum provided by the Guidelines (2007), was used to compute the demand displacement d_{max}^* . The safety criterion was fulfilled when the ratio capacity/demand $d_u^*/d_{max}^* \geq 1$.

In Figure 15b, (backstage under M_y load condition), $d_{max}^* > d_u^*$, i.e. the macro-element collapses. Instead, in Figure 15c, (fly tower under M_y load condition), $d_{max}^* < d_u^*$ i.e. the macro-element does not collapse. In this case, the corresponding structural displacement d_{max} should be calculated (see Appendix 2) and all member checks should be made for this value of displacement. Differently to most cases of reinforced concrete frames, in our case the structural members are ductile since they are modeled by means of plastic hinges, and therefore the force checks are automatically satisfied since the moment and the

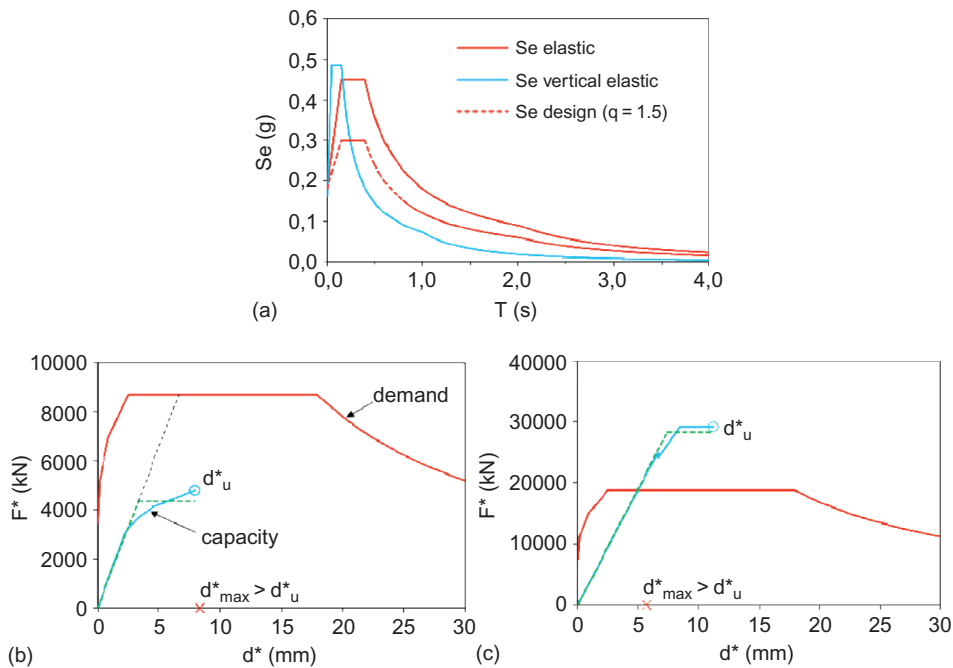

Figure 15. Graph of an example of pushover analysis: Response spectra (a); pushover analysis of the backstage (M_y) (b); notice that $d_{max}^* > d_u^*$ (i.e., the macro-element collapses); and pushover analysis of the fly tower (M_y) (c). In this case, $d_{max}^* < d_u^*$ (i.e., the macro-element does not collapse).

shear are limited by the maximum design values, respectively M_u and V_t , which activate plastic hinges. Checks are then carried out in terms of maximum rotation/displacement. The results of the analyses, which are ranked from the most to the less vulnerable in the bar-charts of Figure 16, are discussed in the next paragraphs.

4.2.3. Backstage The backstage macro-element (Figure 6) is connected to the rest of the structure by slender horizontal masonry beams whose capacity to transfer the forces is virtually negligible (zone A in Figure 17). Indeed, the load-carrying capacity of horizontal masonry beams requires the presence of effective lintels and the activation of a strut and tie mechanism, which can reasonably arise only if appropriate ties or tensile-resisting elements (e.g., reinforced concrete floors) are able to equilibrate the horizontal compression strut in the masonry (e.g., Ordinance 3274 2003). This is not the case of the backstage beams, where ties and horizontal floors were absent. Therefore, their ultimate moment is put equal to zero and their contribution is conservatively neglected. For this reason, the backstage could be considered independent of the fly-tower.

Starting from local mechanisms, the introduction of a new reinforced concrete rigid diaphragm connected to the external walls (zone B in Figure 17) was conceived. This represents a restraint that reduces the risk of out-of plane overturning of the external walls. In this case, mechanism M6 was made of two rigid blocks that rotate with respect to the upper and lower floors (Table 2).

Results of LKA and NLKA show that the mechanism M6 is not likely to occur (Figure 13). Then, the pushover analysis was applied to study the in-plane behavior of the walls of the macro-element. Figure 18 shows the finite element model in which rigid horizontal diaphragms were introduced to simulate the new reinforced concrete floor slabs. The results of pushover analyses for the four load combinations are summarized in Figure 16. The minimum ratio capacity/demand = 0.95 was obtained for the load combination M_y , whose corresponding pushover curve is plotted in Figure 15a.

Failure occurs in the horizontal masonry beams (e.g., the lintels), when the ultimate rotation is attained. It is worth to note that no structural upgrade was suggested in this case, because according to the Guidelines (2007), the values of the ultimate rotation are considered conservative under the model uncertainties. In fact, the ultimate value

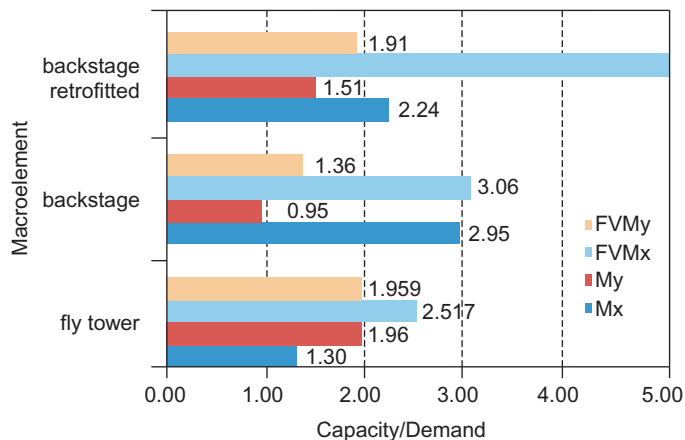

Figure 16. Graph of the results of pushover analyses.

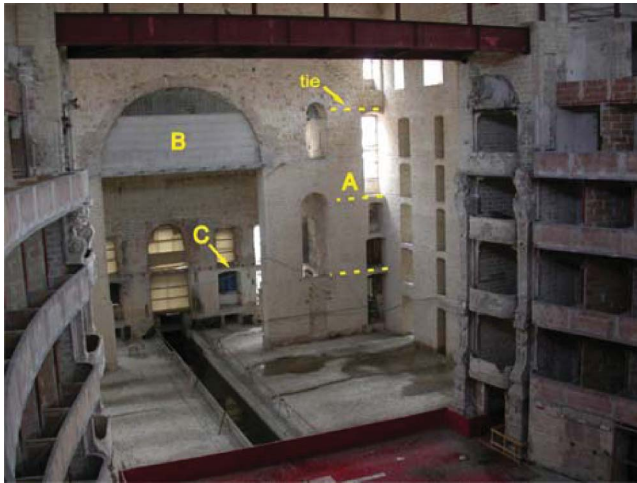

Figure 17. Photograph of the structural upgrade of the backstage by means of ties.

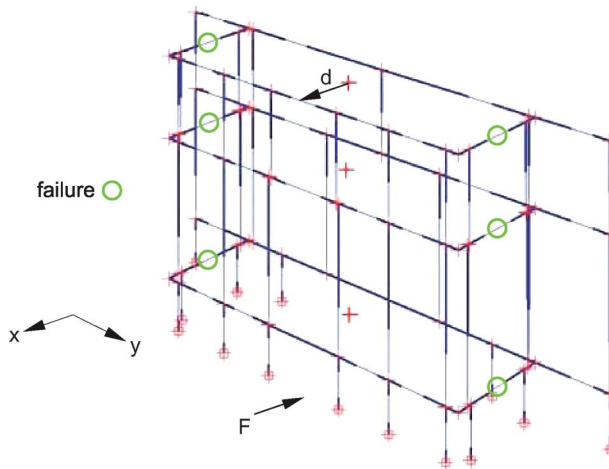

Figure 18. Three-dimensional finite element model of the backstage.

(Appendix II) is defined as a constant, independently of the true material behavior, of the lintel shape (e.g. arch, beam) and of the presence of strengthening elements (e.g., steel ties), which improve its ductility.

Although the structural contribution of the horizontal beams which link the backstage to the fly tower was neglected in the global calculation, their ultimate rotation can be attained, i.e., decompression caused by the relative motion of the two macro-elements may lead to their brittle failure. For this reason, it was suggested to place steel ties or CFRP strips which permit to improve the structural behavior of the horizontal beams (Figure 17).

4.2.4. Fly tower Because of the slenderness of its high walls, the fly tower macro-element is one of the most vulnerable (Figure 6). In particular, the walls of the lateral

wings are restrained by four floors and by a reinforced concrete tie-beam at the top (Figure 19). However, this beam does not link the two triangular pediments above proscenium arch and backstage, and their out-of-plane overturning is therefore possible. For this reason, the behavior of the pediment was studied by means of kinematic analyses considering three possible mechanisms M2, M3, and M4 (Table 2). Results of LKA and NLKA, which are summarized in the bar chart of Figure 13, show that mechanism M2 is the most vulnerable for both the approaches. To avoid it, the reinforcement of the local connections between pediment and transversal walls was suggested, by introducing steel ties.

Once the local mechanisms were excluded, it was possible to analyze the in-plane behavior of the walls. In Figure 14, a particular of the lateral wall and its frame model has been depicted. Pushover analysis of the fly tower was performed considering the interaction with the backstage because, after the structural upgrade, the two macro-elements will be linked together. The finite element scheme with the first three vibration modes is depicted in Figure 20. The modal analysis was carried under the hypothesis of rigid floors, since under the (more realistic) hypothesis of deformable floors, each walls behaves almost independently.

The pushover analysis shows that the vulnerability is transferred to the horizontal beams of the backstage (zone C in Figure 17) with a minimum capacity/demand ratio = 1.30, which fulfils the seismic assessment (Figure 16).

4.2.5. Entrance Considering the entrance macro-element (Figure 6), it was noted that the pediment on the frontispiece of the theater is very high. Moreover, heavy marble statues elevate its center of gravity, increasing the risk of tilting at the base. The corresponding mechanism M5 is depicted in Table 2. The results of LKA and NLKA are summarized in Figure 13. Both the analyses put forward that the frontispiece pediment is seriously exposed to the risk of rocking at the base.

A second problem of the entrance macro-element was represented by out-of plane rocking of the external walls, which are very high because of the absence of intermediate floors in the foyer. The corresponding mechanism M1 of rocking with respect to the base is depicted in Table 2. Both LKA and NLKA show that M1 is less dangerous than M5 but still important (Figure 13). Notwithstanding, it should be considered that in mechanism M1, the restrain of the roof diaphragm and the friction across the walls have been neglected, therefore the results are somehow conservative.



Figure 19. Photograph of the fly tower: particular of the reinforced concrete tie-beam.

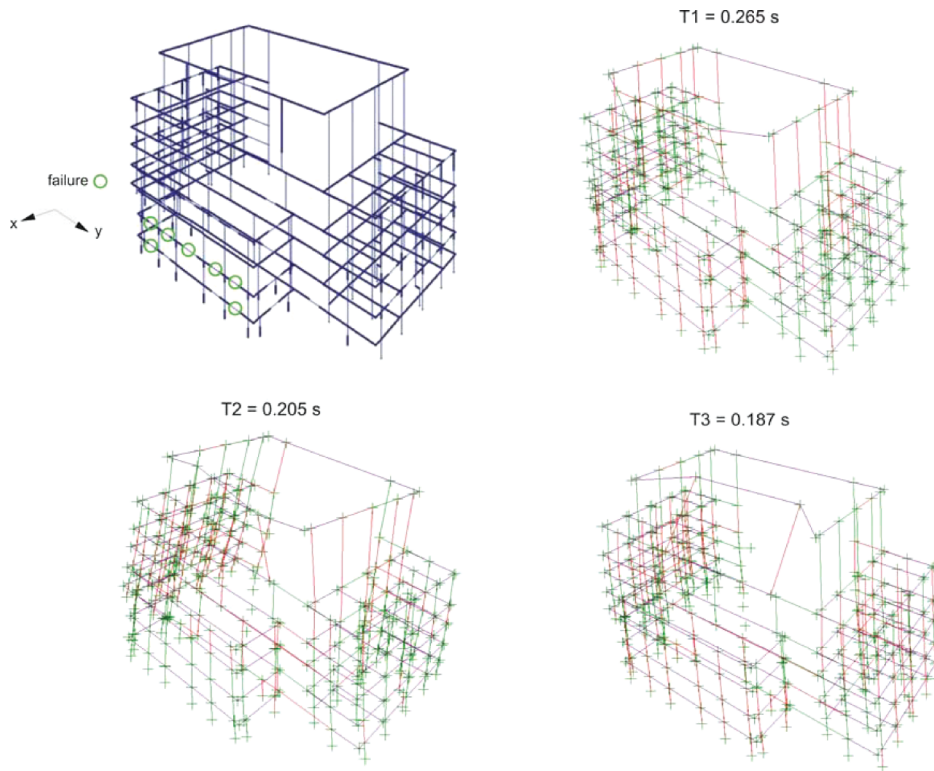

Figure 20. Finite element model and vibration modes of backstage and fly-tower.

5. DISCUSSION OF THE RESULTS AND CONCLUSIONS

In this work the macro-element strategy, already proposed for the seismic analysis of churches, was adapted to the case of an historical theater. This strategy, according to the Italian standards, presents a series of advantages compared to other techniques.

- The approach permits to divide the whole building in parts that are more regular and homogeneous. This division allows adoption of straightforward techniques that are specific for each element, simplifying the analysis and improving its reliability.
- Simpler models permit to investigate easily the sensitivity of the results with respect to the uncertain parameters (e.g., mechanical properties of the materials, stiffness of floors, fracture behavior). Moreover, their results are more clearly understandable and provide an immediate focus on the most efficient retrofit solution.
- In a global model, the severe damage of a small weak part of the structure (e.g., overturning of the pediment of the theater) usually implies strong nonlinearities with associated numerical problems. This makes difficult to study the behavior of the portions of the building that are more robust and not affected by localized collapse. Instead, in the macro-element strategy, this problem is solved.
- A global nonlinear model must take into account existing cracks and discontinuities by means of nonlinear constitutive laws (e.g., contact forces, smeared damage, softening

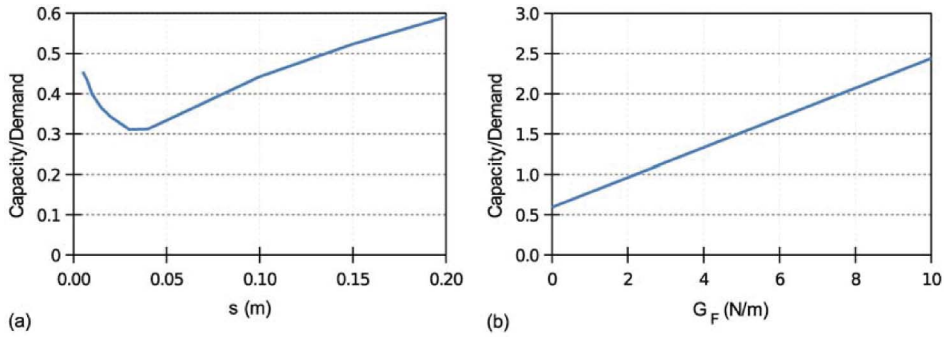

Figure 21. Graph of the capacity/demand as a function of the allowable beam slippage s (mechanism M1) (a), and the capacity/demand as a function of fracture energy G_F (b).

cracks). By using macro-elements, the main discontinuities are simply the boundaries of the model.

- This strategy can be extrapolated to other building typologies, provided two conditions are satisfied. First, local collapse modes must prevail on the global behavior, as is the case of most historical structures where different parts are normally not efficiently connected with each other. Second, application of the macro-element strategy to masonry buildings requires sufficient expertise and “structural feeling” by the designer. Calculations, in fact, cannot be encoded into a black box procedure and the Code rules still leave many degrees of freedom to the designer.

Notwithstanding, it is worth to highlight also the uncertainties associated with this strategy. For example, the kinematic analyses are still affected by some model uncertainties.

- As already discussed (Section 4.2.1), in the case of LKA, the problem of assigning a reliable value to the factor q is still open. The simplistic choice of the Codes is questionable, and results are quantitatively affected by this choice. Considering, e.g., the results reported in Figure 13, one notes that nonlinear kinematic analyses (NLKA) in our case are always more conservative than the linear approach. This is due to two factors, i.e., the use of the parameter q in LKA and a more reliable limit state (the lack of beam support, see next comment).
- In the case of NLKA, the capacity displacement d_u^* depends also on a displacement d_{k2} corresponding to the lack of stability of the structure, like the lack of support of a beam. In the Petruzzelli theater the support of the steel beams of the floors is approximately 150 mm. A slippage $s = 50$ mm of the beams produced by rocking of the walls was considered incompatible, but different values lead to different results. In particular, Figure 21 a shows the ratio capacity/demand for mechanism M1 as a function of the allowable slippage s . A reduction of s produces the reduction of the period of the secant system, i.e., a reduction of the demand, and thus the structural safety improves. The definition of the maximum slippage s therefore requires particular attention.
- In NLKA, a second issue to deal with is the fracture energy of the material. If the blocks are not yet pre-cracked, the fracture energy G_F involved in the formation of the mechanism may have an important role. Unfortunately only a few data on Mode I and Mode II fracture energy of masonry are available in the literature (Bocca, Carpinteri, and Chiaia 1997; Rots 1997). Notwithstanding, the sensitivity of the results with respect to

G_F was investigated. Figure 21b shows that, if $G_F = 2.0$ N/m, which seems plausible for good quality tuff masonry, the capacity/demand ratio becomes larger than unity. This means that, in the absence of pre-existing structural cracks within the tuff blocks, a brittle crack is not likely to be activated by the loads, and therefore the mechanism would not be critical.

The study shows that pushover analyses are affected by important uncertainties too.

- The analyses show that failure occurred in the horizontal masonry beams, which are very weak. As pointed out by the Guidelines (2007), the ultimate displacements proposed in the Ordinance 3274 (2003) for horizontal masonry beams are conservative, since the typology and the effectiveness of lintels, as the effect of structural elements which are able to carry tensile forces or improve the ductility, are not considered.
- The assessment of the stiffness and strength of horizontal floors is important and affected by uncertainty. As reported in Figure 16, assuming rigid floors provides higher tensile capacity and the lintels do not fail under a force distribution proportional to the first vibration mode. For this reason, the ratio capacity/demand increases considerably with respect to the analyses carried with deformable floors (i.e., with force distribution proportional to the masses).
- Another source of uncertainties is the distribution of horizontal seismic forces adopted for pushover analysis. Since the macro-element is irregular, the adopted distributions of forces could represent the earthquake in a wrong way. In this case, the Guidelines (2007) suggest to adopt adaptative pushover analyses, which update the distribution of forces at every load step. In reinforced concrete frames (and especially concrete bridges), adaptative pushover analyses are effective, although the choice of the adaptative criterion is still under research (Casarotti, Pinho, and Calvi 2007). The main advantage of this technique is the possibility to extend pushover analysis to cases where the first vibration mode is not dominant (e.g., complex irregular structures). In another regard, to our knowledge, the reliability of adaptive pushover analysis to masonry structures with deformable floors has not been adequately investigated in the literature. Moreover, it was proved that, in masonry buildings with deformable floors, the distribution of seismic forces close to collapse is nearly uniform, i.e. proportional to the masses (Tomazevic 1999). A force distribution proportional to the first vibration mode is not significant because it represents the behavior of few walls, which vibrate independently with one another. In this case, the improvements that consider an adaptative definition of the vibration mode during the evolution of damage are not necessary. Moreover, nonlinear pushover analysis is based on the hypothesis that the dynamic behavior of the structure can be represented by an equivalent SDOF system. Even within the framework of this important approximation, it is not proved that a different distribution of the seismic forces can lead to more precise results or give just an illusion of precision (Papanikolaou, Elnashai, and Pareja 2006, De Sortis, Decanini, and Sorrentino 2009).
- In any case, the macro-element strategy is well suited only for collapse analysis. If designers are interested in assessing the onset of cracks and damage (i.e., damage limit state), the starting hypotheses of the strategy do not hold, and different global techniques (e.g., modal analysis) must be employed.

In conclusion, the work highlighted advantages and disadvantages in the approach proposed by the 2007 Guidelines. The uncertainties are partly due to the peculiarity of the considered structure (e.g., complexity, multi-materials, historical value) and partly to the

chosen modeling strategy (macro-elements). In another regard, most uncertainties are conservative, like in the case of the ultimate rotation of plastic hinges (see the backstage lintels, Section 4). Also, the contribution of friction and fracture energy should certainly increase the safety factors against collapse.

The above modeling uncertainties could be overcome provided further research is carried on real structures. The development of non-invasive experimental techniques, coupled with refined mechanical theories based, e.g., on fracture mechanics, should provide insights into the real behavior of these complex structures. In any case, considering the state of the art, the adopted modeling approach, exploiting regularity and simplicity of the macro-elements, reduces most of the uncertainties and represents the most reliable approach with regard to collapse behavior.

REFERENCES

- A. T. P. Berardi, Civita, Comes Studio, Giannini, Studio SMN, Studio Sylos Labini, and Studio Vitone. 2003. Petruzzelli Theater. Restoration and functional renovation project. *Giornale d'Architettura* 21: 90–99.
- Baratta, A., and G. Voiello. 1986. Modelli matematici per l'analisi delle strutture murarie, *Restauro* 87/88: 81–125.
- Bocca P., A. Carpinteri, and B. Chiaia. 1997. Size dependence of strength and fracture properties of brick masonry walls. *Journal of Engineering Mechanics—ASCE* 123(8): 816–822.
- Casarotti C., R. Pinho, and G.M. Calvi. 2007. *Adaptive pushover-based methods for seismic assessment and design of bridge structures*. Pavia, Italy: IUSS Press.
- Ceroni, F., G. Manfredi, G. Marcari, M. Pecce, and S. Voto. 2004. *Analysis and mechanical characterisation of tuff masonry*, 15th Congresso C.T.E. Bari, Italy: Collegio dei Tecnici della Industrializzazione Edilizia CTE, Milan, Italy.
- De Sortis, A., L. Decanini, and L. Sorrentino. 2009. *Seismic analysis of masonry buildings according to the new Italian Code, XIII Congress ANIDIS*. Bologna, Italy: Imready, Republic of San Marino.
- Dogliani F., A. Moretti, and V. Petrini. 1994. *Le chiese e il terremoto. Dalla vulnerabilità constatata del terremoto del Friuli al miglioramento antisismico nel restauro, verso la politica di prevenzione*. Trieste, Edizioni LINT.
- Eurocode 3. 2003. *Design of steel structure—Part 1-1: General rules and rules for buildings*, CEN–EN 2003–1–1. Brussels, Belgium: European Committee for Standardization.
- Eurocode 8. 2005. *Design of structures for earthquake resistance, Part 3: Assessment and retrofitting of buildings*, CEN–EN 1998–3. Brussels, Belgium: European Committee for Standardization.
- Fajfar, P., and P. Gašperšič. 1996. The N2 method for the seismic damage analysis of R.C. buildings. *Earthquake Engineering and Structural Dynamics* 25(1): 31–46.
- Freeman, S.A. 1998. Development and use of capacity spectrum method. In *Proceedings of the 6th U.S. National Conference on Earthquake Engineering* [CD-ROM]. Seattle, WA: EERI.
- Galasco A., S. Lagomarsino, A. Penna, and S. Resemini. 2004. Non-linear seismic analysis of masonry structures. In *Proceedings of the 13th WCEE*. Vancouver: WCEE.
- Giuffrè A. 1991. *Lecture sulla meccanica delle murature storiche*. Rome: Edizioni Kappa.
- Giuffrè, A. 1996. A mechanical model for statics and dynamics of historical masonry buildings. In *Protection of the Architectural Heritage Against Earthquakes*, eds., V. Petrini and M. Save. CISM Courses and Lectures 359. Vienna: Springer-Verlag.
- Guidelines. 2007. *Guidelines for evaluation and mitigation of seismic risk to cultural heritage*. Rome, Gangemi.
- Kappos, A., G. G. Penelis, and C. G. Drakopoulos. 2002. Evaluation of simplified models for lateral load analysis of unreinforced masonry buildings. *Journal of Structural Engineering, ASCE* 128(7): 890–897.

- Lourenço, P. B. 2001. Analysis of historical constructions: from trust-lines to advanced simulations. In *III Structural Analysis of Historical Constructions*. Guimarães, Portugal: University of Minho, Portugal.
- Magenes, G. 2006. Masonry building design in seismic areas: Recent experiences and prospects from European standpoint. In *Proceedings of the First European Conference on Earthquake Engineering and Seismology*. Geneva, Switzerland, September 3-8 2006, 1–21.
- Mahaney J. A., S. A. Freeman, T. F. Paret, and B. E. Kehoe. 1993. The capacity spectrum method for evaluating structural response during the Loma Prieta earthquake. In *Proceedings of the 1993 National Earthquake Conference*. 501–510, Memphis, TN: Center for Earthquake Research and Information.
- Ordinance 3274. 2003. *Technical rules for the design, evaluation and seismic retrofitting of buildings*. Italian Prime Minister Ordinance, Rome, Italy.
- Ordinance 3431. 2005. *Last modifications and integrations to the Ordinance 3274 of March 20, 2003*. Italian Prime Minister Ordinance, Rome, Italy. Available at: <http://www.eucentre.it/index.php/content/view/612/153/>
- Papanikolaou V. K., A. S. Elnashai, and J. F. Pareja. 2006. Evaluation of conventional and adaptive pushover analysis II: Comparative results. *Journal of Earthquake Engineering* 10(1): 127–151.
- Roca, P., C. Molins, and A. R. Mari. 2005. Strength capacity of masonry wall structures by the equivalent frame method. *Journal of Structural Engineering, ASCE* 131(10): 1601–1610.
- Rots, J. 1997. *Structural masonry: An experimental/ numerical basis for practical design rules*. London: Taylor & Francis.
- Tomažević, M. 1999. *Earthquake-resistant design of masonry buildings*. London: Imperial College Press.

APPENDIX I: KINEMATIC ANALYSIS

In this work, linear and nonlinear kinematic analyses are performed following the procedures proposed in (Ordinance 3274 2003; Ordinance 3431 2005) are briefly summarized. For both, the approaches a portion of the structure is modeled by means of pin-connected rigid blocks (i.e., no-tension material with infinite compressive strength) by neglecting fracture energy and friction between the blocks.

The blocks are subjected to self-weights P_i and to their corresponding seismic forces αP_i , to the seismic forces transmitted by other structures αP_j , and to generic forces F_h (Figure 22a). The kinematics of the system is governed by the generalized displacement d_k of a point K, usually chosen in the center of mass of the system (Figure 23).

The relationship between d_k and the unknown multiplier α is obtained by writing the equilibrium in the current configuration, by means of the principle of virtual works as shown in Equation 2:

$$\alpha \left(\sum_{i=1}^n P_i \delta_{x,i} + \sum_{j=n+1}^{n+m} P_j \delta_{x,j} \right) - \sum_{i=1}^n P_i \delta_{y,i} - \sum_{h=1}^o F_h \delta_h - L_{if} = 0 \quad (2)$$

where Δ_x is the horizontal virtual displacement, Δ_y is the vertical virtual displacement, and L_{if} represents the work done by the internal forces, which are supposed to be null, since the fracture energy G_F is neglected.

In LKA the initial configuration is studied (Figure 22a). In NLKA, increasing d_k step by step, subsequent configurations are investigated up to the failure displacement d_{k0} is attained, which is characterized by $\alpha = 0$.

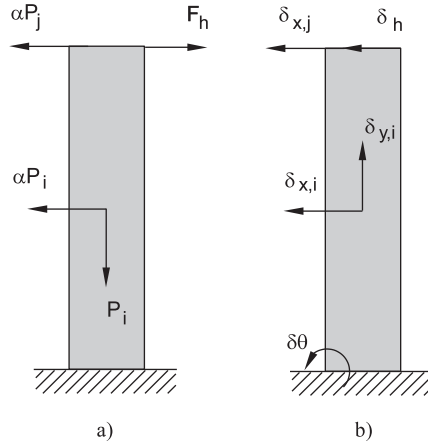

Figure 22. Illustrations of the rigid block: system of forces (a) and system of displacements (b).

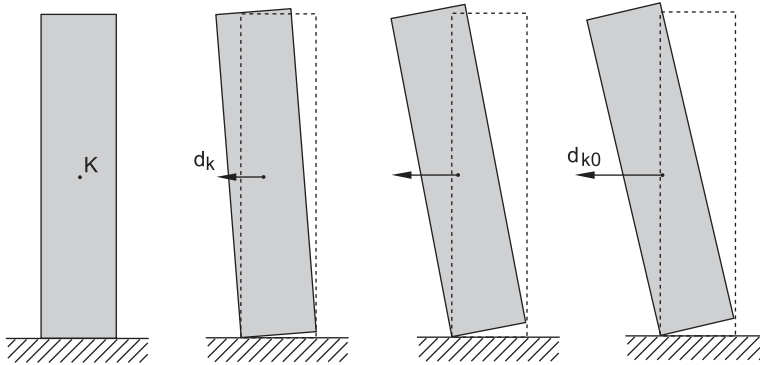

Figure 23. Illustration of the subsequent configurations of the rigid block for nonlinear kinematic analyses (NLKA).

The solution permits to plot the capacity curve $\alpha - d_k$, which is piecewise nonlinear if the forces display a variation (e.g. yielding or rupture of a tie).

The results are used to define the behavior of an equivalent SDOF system, which is expressed in terms of acceleration a^* and displacement d^* . In particular, the mass M^* of the SDOF system is computed as shown in Equation 3:

$$M^* = \frac{\left(\sum_{i=1}^{n+m} P_i \delta_{x,i} \right)^2}{g \sum_{i=1}^{n+m} P_i \delta_{x,i}^2} \quad (3)$$

where g is the gravitational acceleration. The seismic spectral acceleration a^* is shown in Equation 4:

$$a^* = \alpha \frac{\sum_{i=1}^{n+m} P_i}{M^*} \quad (4)$$

The spectral displacement d^* is obtained as shown in Equation 5:

$$d^* = d_k \frac{\sum_{i=1}^{n+m} P_i \delta_{x,i}}{\delta_{x,k} \sum_{i=1}^{n+m} P_i} \quad (5)$$

where $\delta_{x,k}$ is the horizontal virtual displacement of the point K. All the virtual displacements are computed at the initial configuration.

In LKA, the ultimate limit state is verified if $a^* > a_d$ shown in Equation 6, where:

$$a_d = \frac{a_g S}{q} \left(1 + 1.5 \frac{Z}{H} \right) \quad (6)$$

with soil factor $S = 1.0$ and behavior factor $q = 2.0$ (i.e. the same value adopted for non structural collapsing elements, see Appendix 11.C in the Ordinance 3431, 2005); moreover Z is the height of the center of mass of the mechanism, H is the height of the structure, both with respect to the foundations.

In NLKA the ultimate displacement d_u^* , i.e. the capacity of the system, is defined conventionally for $d_k = \min(d_{k1}, d_{k2})$ where $d_{k1} = 0.4d_{u,k}$ is computed considering only the forces which do exist up to failure, and d_{k2} is the displacement which is incompatible with the stability of the structural elements (e.g. lack of beam support). The demand is defined by considering the pseudo acceleration spectrum for non structural elements, which tries to reproduce the dynamic filtering effect of the whole structure by means of the ratio Z/H . The spectrum is transformed in the ADSR form (Freeman 1998) and superimposed to the capacity curve (Figure 12). The nonlinear system is replaced by a secant linear system defined conventionally for $d_s^* = 0.4d_u^*$. The intersection between its capacity line and the demand curve identifies the demand displacement of the secant system, which is related to Δ_d . The structure is finally verified if $\Delta_d \leq d_u^*$ (Figure 13).

APPENDIX II: PUSHOVER ANALYSIS

The in-plane behavior of the walls of the macro elements is studied by means of pushover analysis according to Ordinance 3274 (2003) and Ordinance 3431 (2005). Two distributions of horizontal seismic forces are considered for each orthogonal direction x and y (Ordinance 3274, 2003; Ordinance 3431, 2005), respectively proportional to the masses (M_x, M_y), and to the displacements of the first vibration mode shape (FVM $_x$, FVM $_y$).

The masonry walls are modeled with equivalent planar frames. In particular, piers and spandrels are modeled with linear-elastic Timoshenko beam elements connected by rigid links (Guidelines 2007; Ordinance 3274 2003; Ordinance 3431 2005). The nonlinear behavior of the masonry is introduced through perfectly plastic hinges with limited ductility (Figure 24).

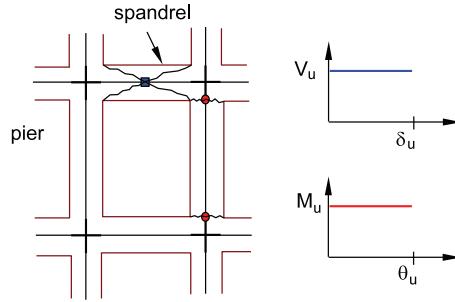

Figure 24. Illustration of the frame model with perfectly plastic hinges.

In particular, at both the ends of each beam, a flexural hinge is activated when the ultimate moment M_u is reached shown in Equation 7, where:

$$M_u = \left(\frac{1}{2} l^2 t \sigma_0 \right) \left(1 - \frac{\sigma_0}{0.85 f_d} \right) \quad (7)$$

and l is the width of the beam, t is the thickness of the beam, $\sigma_0 = P/lt$, P is the axial load, f_d is the design compressive strength of masonry. Failure occurs when the ultimate rotation θ_u is attained.

In the middle of the beams a perfectly plastic shear hinge may be activated. According to the Guidelines (2007), in existing buildings diagonal shear failure is more likely to occur than sliding shear failure, therefore the shear strength V_t can be expressed according to Turnesek-Cacovic criteria (Ordinance 3274, 2003; Ordinance 3431, 2005)

$$V_t = l t \frac{f_{id}}{b} \sqrt{1 + \frac{\sigma_0}{f_{id}}} \quad (8)$$

where $f_{id} = 1.5 \tau_d$; τ_d is the design shear strength of masonry; $b = h/l$; h is the beam length. Failure conventionally occurs when the ultimate drift displacement of the beam reaches the value $h/250$. Figure 18 shows the model and the reference point whose displacement is used to plot the pushover curve. The pushover curve is interrupted when the ultimate displacement d_u is reached. Because of the uncertainties to define this displacement, two solutions proposed in (Guidelines 2007) are employed: (a) elastic-perfectly plastic hinges with ultimate rotation/drift and pushover curve interrupted when the base shear displays a softening reduction conventionally fixed as 20%; (b) limited total ductility, i.e., the pushover curve is interrupted when the displacement is three times the displacement corresponding to the formation of the first plastic hinge.

The pushover curve of the structure is transformed into the one of a SDOF system by means of the participation factor Γ (Fajfar and Gašperšič 1996; Ordinance 3431 2005). Then, the curve is linearized according to the Ordinance 3431 (2005) with a secant line that passes through the point corresponding to the 70% of the maximum base shear (Figure 15). The horizontal branch is obtained to balance the energies, which is the areas under the curves. The demand displacement d_{\max}^* is obtained by following the procedure described in Fajfar and Gašperšič (1996) and Ordinance 3274 (2003). Then, the demand displacement of the structure is computed as $d_{\max} = \Gamma d_{\max}^*$.

The collapse limit state is fulfilled if the ratio capacity/demand $d_u/d_{\max} \geq 1$.