

Fuzzy Logic Position Control of a Shape Memory Alloy Wire

Original

Fuzzy Logic Position Control of a Shape Memory Alloy Wire / Raparelli, Terenziano; Belforte, Guido; Maffiodo, Daniela. - STAMPA. - (2009), pp. 1-9. (Intervento presentato al convegno Proceedings of the RAAD 2009, 18th Int. Workshop on Robotics in Alpe-Adria-Danube Region tenutosi a Brasov, Romania nel May 25-27).

Availability:

This version is available at: 11583/2144482 since:

Publisher:

Printech Pub, Politehnica University of Bucharest:

Published

DOI:

Terms of use:

This article is made available under terms and conditions as specified in the corresponding bibliographic description in the repository

Publisher copyright

(Article begins on next page)

Fuzzy logic position control of a Shape Memory Alloy wire

D. Maffiodo, T. Raparelli, G. Belforte

*Department of Mechanics, Politecnico di Torino
Corso Duca degli Abruzzi 24, 10129 Turin, Italy*

E-mail: {daniela.maffiodo, terenziano.raparelli, guido.belforte}@polito.it

Abstract. Due to the thermomechanical characteristics of Shape Memory Alloy wires, it is important to develop control systems in order to design new applications for these smart materials. This work presents three SMA wire position controls: a classic PD control with PWM modulation is compared to two different fuzzy logic controls. They are implemented on a SMA wire (Flexinol®) with a diameter of 250 μ m and a length of about 200 mm.

The so called Fuzzy logic is particularly suitable in case of uncertain conditions and in presence of data acquisition noise and it is widely used to model and control time dependent and/or non linear processes.

The experimental tests comprise square wave response tests, sinusoidal wave tests and multiple step response tests. Interesting results are a maximum error during stability phase with the fuzzy logic control of about 2%, four times smaller than that obtained with the PD control, with reduced fluctuations amplitude. The PD control with fuzzy supervisor is a control more simple than the fuzzy control and lead to similar results for the sinusoidal tests and multiple step response tests, with fluctuation amplitude of about 0,01 mm, much more less than those observed with the PD or the fuzzy control.

Keywords. Position control, fuzzy logic, shape memory alloy

1. Introduction

At present Shape Memory Alloy (SMA) Wires are employed as actuators in various industrial, aeronautical and space applications and sometimes represent a good alternative to traditional actuators, as well in robotics (Reynaerts and Van Brussel, 1998). SMA wires are particularly suitable to design solutions characterized by high power weight ratio, small devices and simple design, furthermore they are an optimum solution when they are employed at the same time as sensors and actuators.

However their thermomechanical characteristics depend on a number of variables. The constitutive models made by various researchers (Tanaka, 1986; Liang and Rogers, 1990; Brinson 1990, Boyd and Lagoudas, 1998) try to consider the non linearity, hysteresis, non repeatability of the wire.

Therefore a way to design SMA wires applications without knowing every aspect of the thermomechanical characteristics is firmly hoped and this can be made applying control methods to the wire considered as a "black box". Some researchers (Ma and Song, 2003a,b) designed a PD control, using

pulse-width pulse-frequency (PWPF) or PWM modulation with the aim to reduce energy consumption. Results demonstrate the better stability and energy saving of the latter solution. An interesting solution (Song et al., 2003) is to apply neural networks to compensate for wire hysteresis. A possible solution is a SMA wire position control (Raparelli et al, 2002) where the feedback signal is the simple linearized law between the wire strain and its electric resistance, in the hypothesis of constant load. The same idea of resistance feedback is the basis of other researchers work (Ma et al., 2004), but the relationship between position and resistance is mapped applying neural networks.

A PID non linear control with hysteresis compensation allows to perform a good position control of SMA actuators (Shameli et al, 2005).

A further possibility of control logic is the so called Fuzzy logic, particularly suitable in case of uncertain conditions and in presence of data acquisition noise. Today this logic, born in '65, is widely used to model and control time dependent and/or non linear processes (Mac Neill and Freiberger 1993; Li and Gupta, 1995).

This article presents three SMA wire position controls: a classic control (PD with PWM modulation), a fuzzy logic control and a hybrid control (PWM control with fuzzy supervisor). The controlled actuator is a Ni-Ti wire (Flexinol® 250 HT) having 250 mm diameter, 200 mm in length and with one-way shape memory effect.

The study on the optimization of SMA wire position controls allows to design more reliable and efficient applications. As an example, some researchers (Yang and Wang, 2008) designed a SMA-actuated humanoid flexible gripper and studied the related control. More generally, the control scheme implemented makes possible to improve the performances of a wide range of applications: from robots and parallel manipulators to minimal invasive surgery applications, from grippers to artificial limbs.

2. Test bench

The selected SMA wire shows the contracted shape at temperatures beyond 70°C. To obtain the return to the other crystalline form, it is necessary to cool it and to apply a bias tension on the wire axis direction (at least 35 MPa). The heating is obtained with Joule effect, the cooling is on calm air. Having one wire end fixed, it is possible to consider the wire shortening, caused by heating, as the displacement towards high of the free end of the SMA wire. The words “position control” will refer to the position of the free end with respect to the fixed one. The wire must be firmly constrained, under mechanical strain and heated by electric current, moreover a sensor is necessary to measure the reached position of the free wire end.

Fig. 1 shows a sketch of the whole control test bench. The wire layout is simple and efficient: the SMA wire (2) is vertically arranged and connected at its ends to an insulated electric wire. On the upper side this wire is connected to the structure (1), on the lower side there is a suspended mass (3) of about 1 kg. The cursor of a LVDT Shaevitz E200 position sensor (4) is rigidly connected to the mass, sliding inside an external cylinder, fixed to the structure. The arrow beside the wire indicate the heating/shortening direction.

The PC (7), with the help of a adequate software, executes the position control of the SMA wire. The acquisition device DAQ NI PCI-6052E (6) is the interface between mechanical system and control system. The amplification device (5) has two goals: to amplify the low power signal from DAQ and to acquire the electric current magnitude flowing into the SMA wire.

In particular, the DAQ NI PCI-6052E makes the acquisition of the feedback SMA wire position signal from the LVDT sensor, of the signal representing the potential drop between the SMA wire ends and of the potential difference at a known resistance in series

with the SMA wire. Moreover it transmits the command signal necessary to control the SMA wire. The sample time is 0,0001 seconds.

3. The control logic

The control is developed considering the SMA wire as a “black box”. The input is the thermal power supplied to the wire; the outputs are the generated force and the displacement of a wire end. Temperature and electric resistance of the wire are internal variables.

Actually, the thermal power supplied to the SMA wire is the difference between the power supplied by Joule effect and the continuously dispersed power by conduction, convection and radiation.

Total power supplied is known, and represented by the product. The dispersed power is unknown and not considered. During the heating it represents a drawback, but it is essential during the cooling to obtain the austenite-martensite transformation and it depends on environmental conditions (e.g. temperature, ventilation...), that aren't controlled or monitored during this study.

Except for the acceleration phase, the SMA wire generated force is equal to the constant load applied. The wire end displacement, corresponding to the wire contraction, is measured by the position transducer LVDT. The electric resistance, an internal variable, is indirectly obtained as the ratio V_{SMA}/I_{SMA} , the temperature is not measured.

4 The control method

Three different closed loop control methods have been studied, each one developed with Matlab/Simulink software.

4.1. PD Control PWM modulated

The proportional derivative control with PWM (pulse width modulation) modulator is shown in Fig. 2. The desired position is the control input, compared with the position feedback obtained with the LVDT sensor. The difference between the two signals is the positioning error, subsequently multiplied by the proportional gain K_P ; its derivative is amplified by means of the derivative gain K_D ; the sum of these signals represents the command signal V_{OUT} that is processed by the PWM, then furnishing the corresponding wave train. Fig. 3 shows an example of the generated PWM output.

The triangle waveform (frequency $f=10$ Hz, amplitude $A=2V$) is compared to the reference signal. This difference represents the relay input signal. When the reference signal value is more than the modulation waveform, the PWM signal is in the high state, otherwise it is in the low state. The saturation block limits the maximum output for safety reasons.

Output frequency is obviously the same as the carrier wave frequency, so the period is $T=0,1s$.

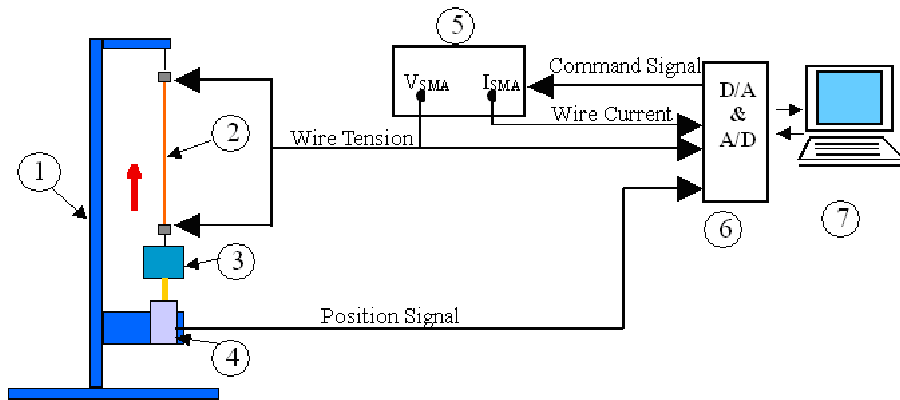

Fig. 1. Control test bench sketch

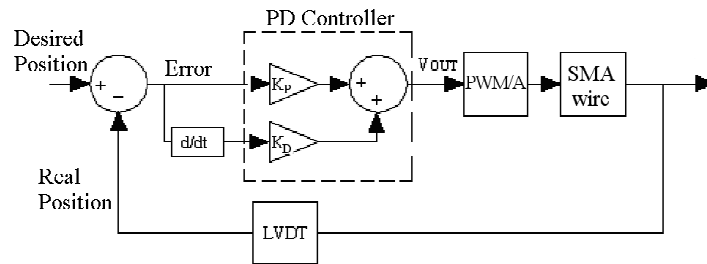

Fig. 2. Block diagram of the PD control with PWM modulator

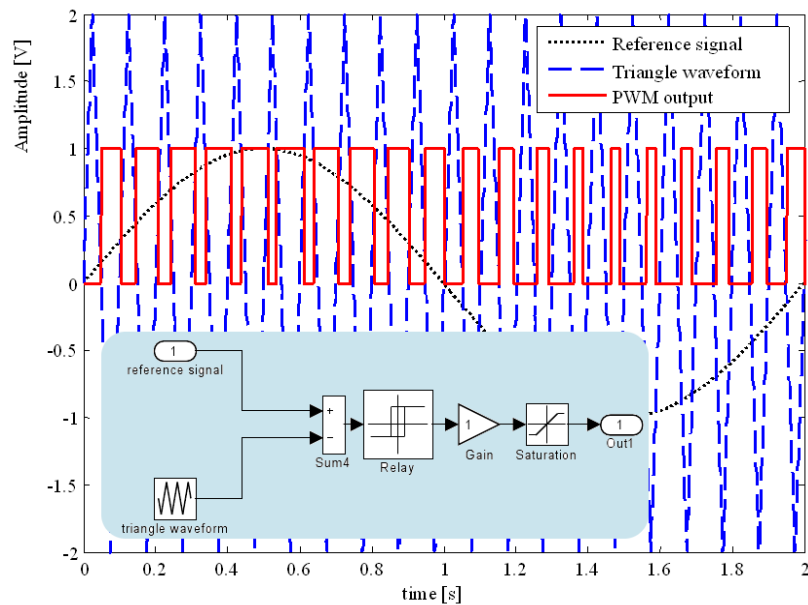

Fig. 3. PWM subsystem

4.2. Fuzzy Logic Control

Fig. 4 shows the block diagram of the SMA wire controlled with fuzzy logic. It looks similar to the PD control, but the PWM modulator is eliminated.

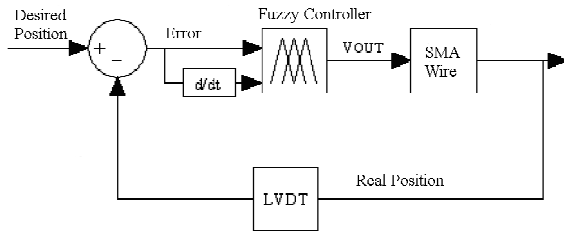

Fig. 4. Fuzzy Logic Control

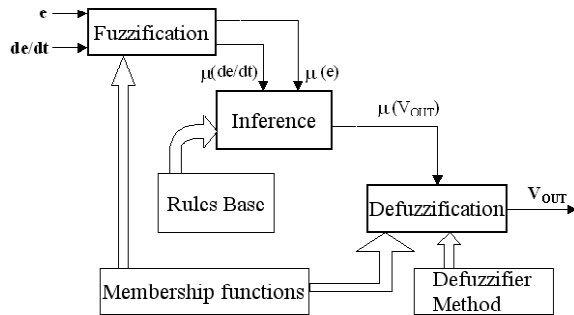

Fig. 5. Fuzzy logic controller block

Control input and output are nominally the same as in PD control, but the inside process is deeply different. Figure 5 shows the block diagram of the fuzzy logic control.

Into the fuzzy control the error and derivative error variables are defined and split up in five different levels using linguistic variables: negative big, negative small, zero, positive small, positive big. The V_{OUT} output variable is described by seven linguistic variables: very low, low, mean low, mean, mean high, high, very high.

Fig. 6 shows the membership functions for the error variable. Since the stroke of the considered actuator is equal to 8 mm, the absolute value maximum error is equal to 8. Triangular and trapezoidal membership functions were chosen to reduce computational costs. Trapezoidal wide negative big and positive big are working when the error is big, e.g. in case of step signal, Negative small, zero and positive small are the membership functions taking part in the following of sinusoidal position input signals.

Fig. 7 shows the membership functions for the derivative error variable. The membership function range (-5/+5 mm/s) was experimentally evaluated.

Fig. 8 shows the membership functions for the output variable, tension V_{OUT} . There are 5 narrow triangular and 2 trapezoidal membership functions with no intersections. The V_{OUT} range is 0/3,8 V; having null input tension is necessary to allow the maximum cooling speed (environmental conditions permitting); the highest tension allow the maximum heating speed. Note that the V_{OUT} tension is not

exactly the wire supply tension V_{SMA} because there is a serial resistance necessary to measure the electric current flowing into the wire.

The maximum tension value is 3,8 V to avoid the risk of overheat. This value was experimentally evaluated.

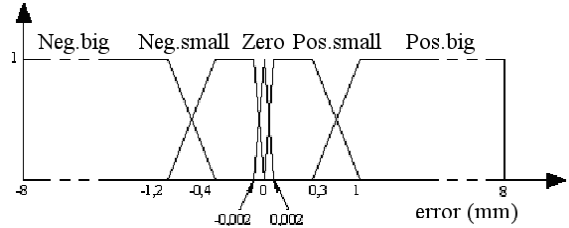

Fig. 6. Membership functions of the error variable

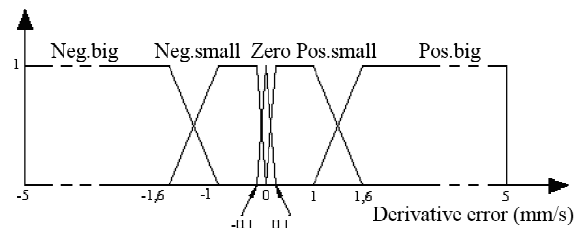

Fig. 7. Membership functions of the derivative error variable

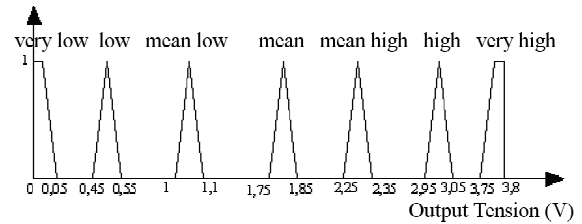

Fig. 8. Membership functions for the output variable, tension V_{OUT}

The rule set is composed by 9 rules:

1. IF error is neg.big THEN tension is very low;
2. IF error is neg.small THEN tension is low;
3. IF error is neg.small AND derivative error is pos.big THEN tension is mean high;
4. IF error is zero AND derivative error is neg.small THEN tension is mean low;
5. IF error is zero THEN tension is mean;
6. IF error is zero AND derivative error is pos.small THEN tension is mean high;
7. IF error is pos.small AND derivative error is neg.big THEN tension is mean low;
8. IF error is pos.small THEN tension is high;
9. IF error is pos.big THEN tension is very high.

To explain the rule set it is necessary to note that negative error means that reached position is bigger than desired position, so it is necessary to cool the wire, decreasing applied tension; vice versa for positive error. Negative derivative error means that

error is decreasing (when error is positive, its absolute value is decreasing; when error is negative, its absolute value is increasing); vice versa for positive derivative error.

Moreover big derivative error (positive or negative) means that error variation speed is high; vice versa for little derivative error. These qualitative obvious observations are the foundations of the inference rule set.

Rules 1,2, 5, 8 and 9 are simple and based only on the error value. Rules 4 and 6 operate in case of stability state (zero error means that its value is between $-0,002 e +0,002$ mm) and derivative error is small (between -1 and $+1$). Referring to rule 6, small derivative error means that error “will be” positive and the control operate to increase output tension, similarly for rule 4. Rule 3 and 7 have the task to avoid overshoots. During both heating and cooling step tests derivative error value was bigger than 1,5 only when error was big (negative big and positive big derivative error). As an example, if error is rapidly decreasing during heating, without rule 7 the control will supply high tension close to the desired position with the risk of exceeding it. With rule 7 the fuzzy control supplies a mid low tension (about 1 V) with the aim of decreasing the error speed. When error is low, other rules will work.

Note that, during a stability phase (zero error), an external noise (e.g. a convection increase) involves rule 8, not 7, because error becomes little positive or negative. This means that the system is well-built.

4.3. PD Control with fuzzy supervisor

Last control solution is a PD control with fuzzy supervisor. The fuzzy subsystem is used to calibrate the K_D parameter of a PD controller; the derivative is used to damp the system response, so it is profitable to increase it at the transition phase end. Experimental tests aiming to determine the right value for parameter K_P and K_D show that, for a fixed K_P value, a high K_D value is important during the transition phase and a low K_D value is useful to reduce vibrations during the stability phase.

The designed fuzzy subsystem, shown in Fig. 9, provides the most suitable derivative value, evaluating only the position error.

Fig. 10 shows the fuzzy block: the input is the position error and the output is the K_D value. Fig. 11 shows the membership functions for the fuzzification, Fig. 12 the membership functions for the defuzzification phase.

The rules set is very simple, only three rules:

1. IF error is negative THEN K_D is big
2. IF error is null THEN K_D is small
3. IF error is positive THEN K_D is big

Therefore the fuzzy block output is a big derivative gain (about 9) when the system is far from the stability state and a little one (about 0.1) within the stability state.

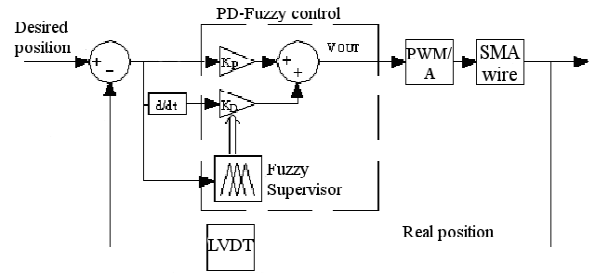

Fig. 9. PD control with fuzzy supervisor

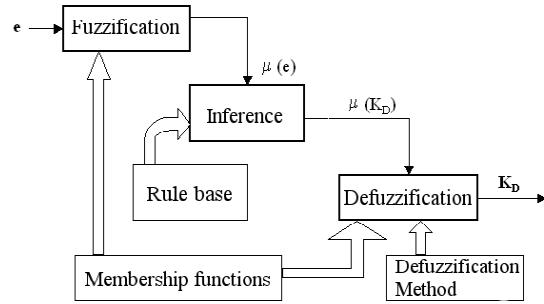

Fig. 10. Fuzzy block

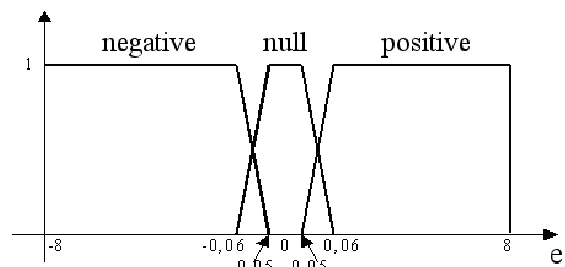

Fig. 11. Membership functions for the fuzzification



Fig. 12. Membership functions of the output variable K_D

5. Experimental tests and results

Square wave response and sinusoidal wave response with different frequencies and a multiple step response test were carried out for the three different controls.

The square wave test, with frequency value of 1/20 Hz, allows to evaluate the maintenance of two predetermined positions corresponding to a SMA wire contraction of 1 mm and of 7 mm. Sinusoidal wave frequencies were assumed to be equal to 1/60, 1/30, 1/20 e 1/15 Hz. The multiple step response test foresees a command signal with 5 upward slopes and 5 downward slopes. Each step corresponds to a 1 mm

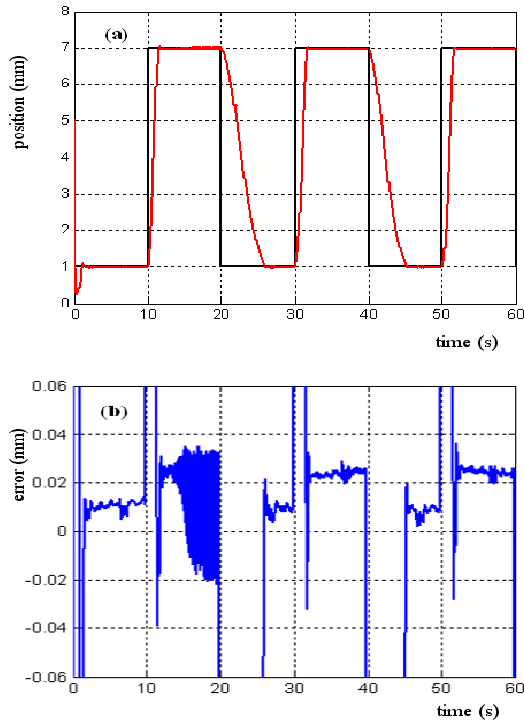

Fig. 13. (a) Square wave response test with PD control and PWM modulator, $f=1/20$ Hz, 1kg bias load; (b) Corresponding position error

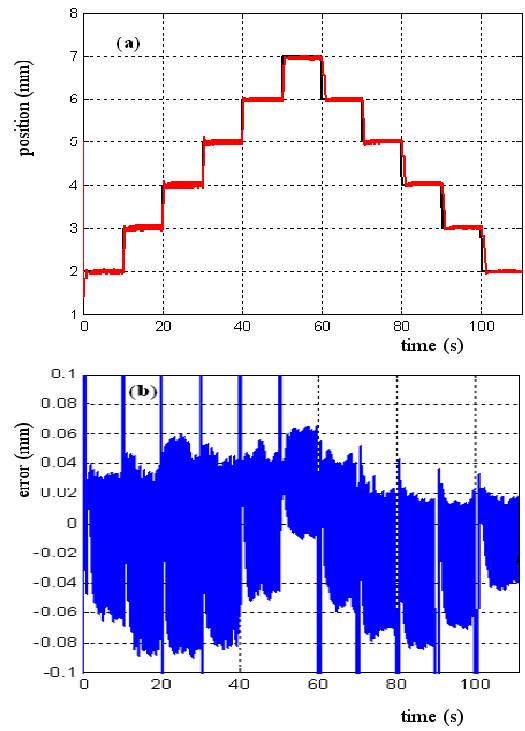

Fig. 15. (a) Multiple step response test with PD control and PWM modulator (1kg bias load); (b) Corresponding position error

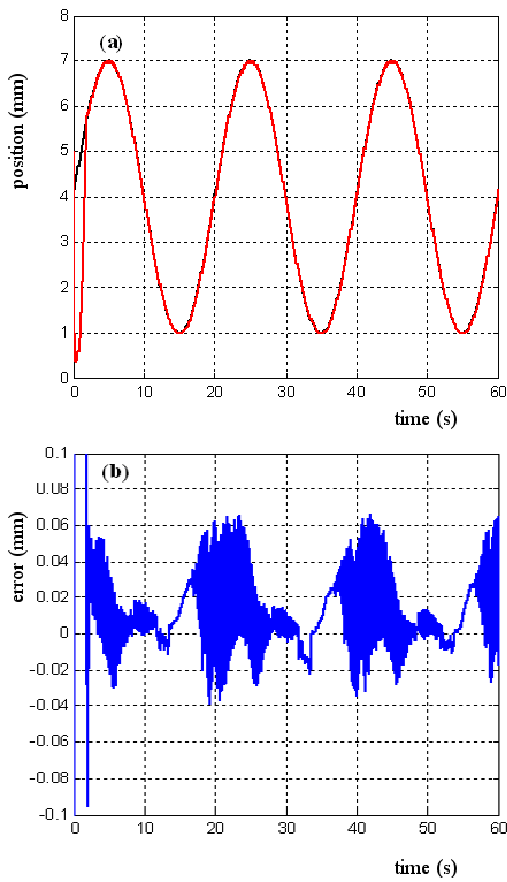

Fig. 14. (a) Sinusoidal wave test example with PD control and PWM modulator: $f=1/20$ Hz; 1kg bias load ; (b) Corresponding position error

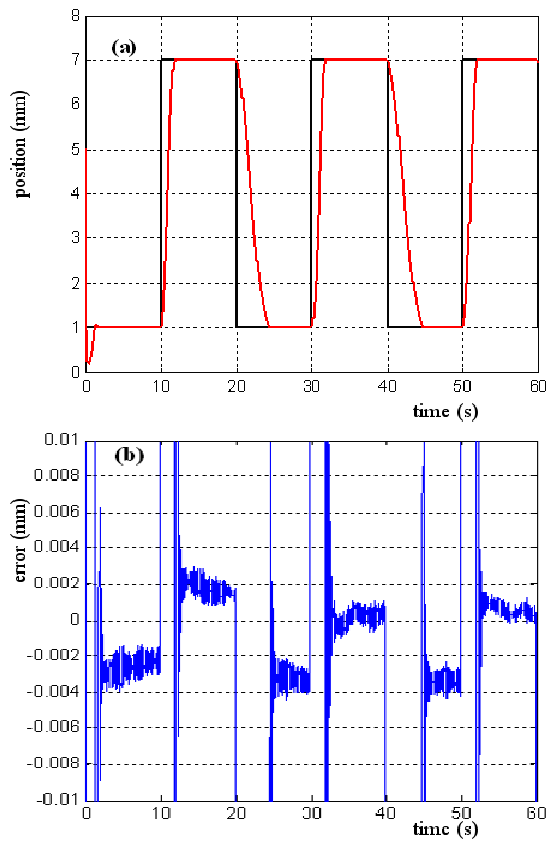

Fig. 16. (a) Square wave response test with Fuzzy control, $f=1/20$ Hz, 1kg bias load; (b) Corresponding position error

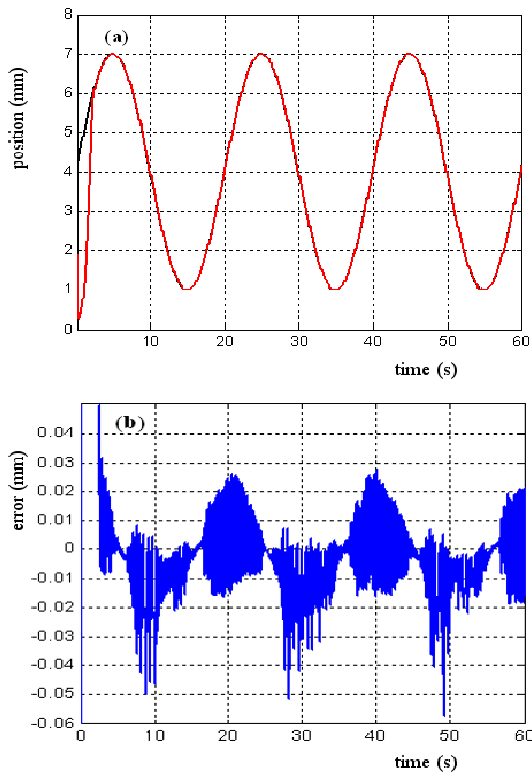

Fig. 17. (a) Sinusoidal wave test example with Fuzzy control: $f=1/20$ Hz; 1kg bias load ; (b) Corresponding position error

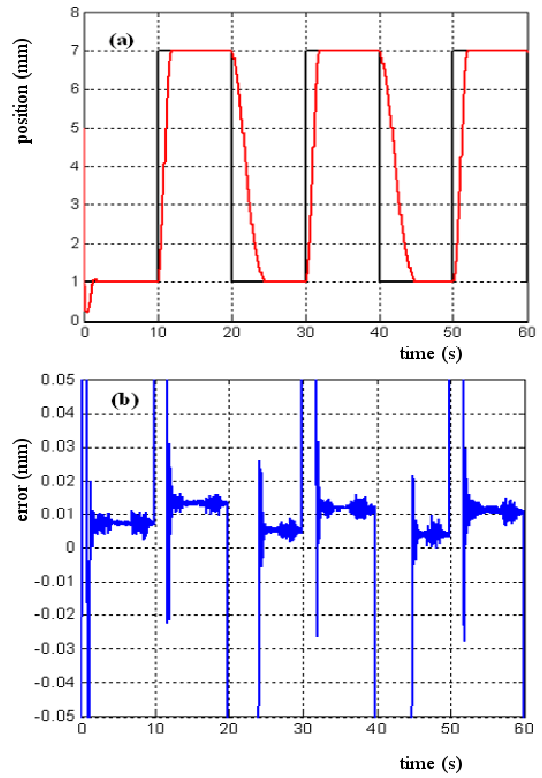

Fig. 19. (a) Square wave response test with PD control Fuzzy supervisor, $f=1/20$ Hz, 1kg bias load; (b) Corresponding position error

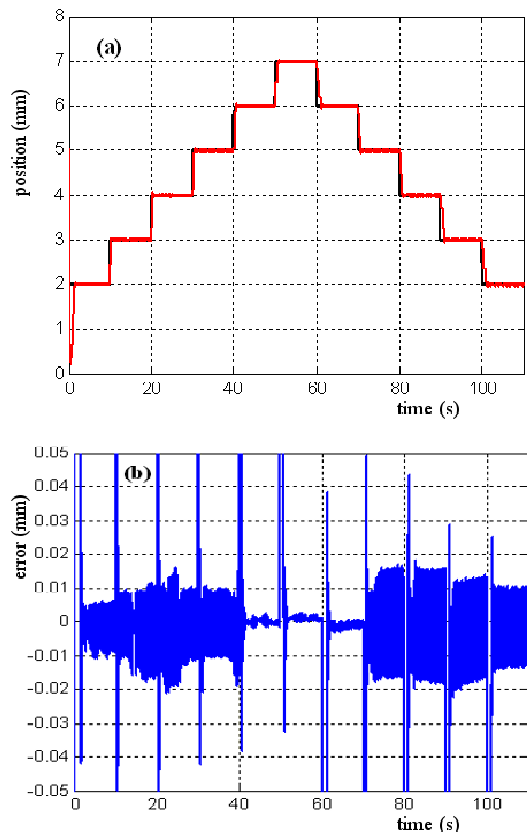

Fig. 18. (a) Multiple step response test with Fuzzy control (1kg bias load); (b) Corresponding position error

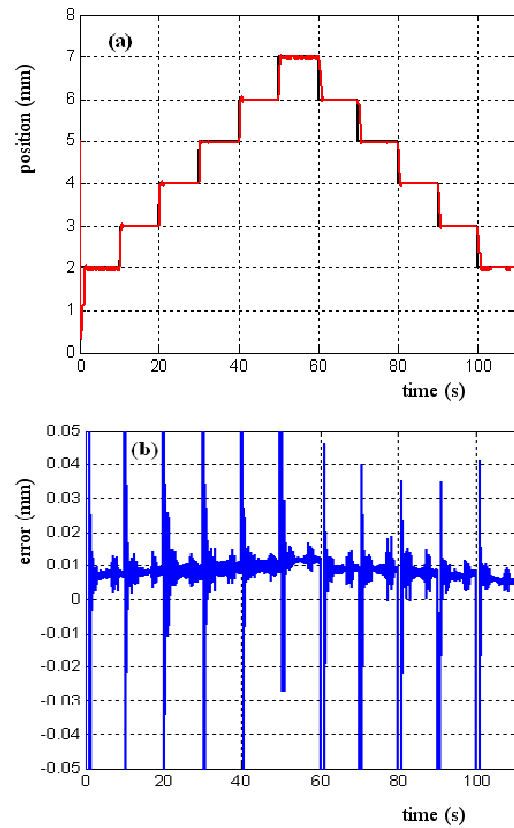

Fig. 20. (a) Multiple step response test with PD control and Fuzzy supervisor (1kg bias load); (b) Corresponding Position error

contraction (or relaxation) of the SMA wire and lasts 10 seconds; the whole command signal being from 2 to 7 mm of the actuator wire range. This test allows the study of the wire aptitude to keep the stability state during a sufficiently long period of time. The maximum error observed during a stability phase of a single test is considered the error of that test, and the maximum overshoot observed during all up and downwards steps of a single test is considered as the overshoot of that test.

5.1. PD control with PWM modulator results

Different experimental tests demonstrate that it is not possible to choose a couple of values for K_P and K_D allowing to minimize stability phase error and overshoot at the same time. $K_P=60$ and $K_D=4$ are the compromise values used for the tests.

The square wave response tests (Fig. 13) showed a maximum stability phase error less than 0,04 mm, corresponding to 0,67%. Heating lasts about 2 seconds and it is always faster than cooling, however this process depends on environmental conditions.

The sinusoidal wave tests demonstrate little differences between the different frequencies, a maximum error of about 1,33% and fluctuation around the desired positions with maximum amplitude of 0,14 mm and 10Hz frequency. Fig. 14 shows an example of sinusoidal wave test.

Fig. 15 shows an example of multiple step response test. Part a) highlights the good correspondence between desired position and reached position, but part b) shows rather high fluctuations during the stability phase (maximum amplitude of 0,15 mm and 10 Hz frequency). The maximum error is about 9%.

5.2. Fuzzy logic control results

The set up phase for the fuzzy logic control was a delicate operation.

The square wave response (Fig. 16) showed a maximum stability phase error less than 0,005 mm (corresponding to 0,08%), about 10 times smaller than that obtained with the PD control with PWM modulator.

The sinusoidal wave tests demonstrate little differences between the different frequencies, a maximum error of about 1%. Fluctuations around the desired positions have maximum amplitude of 0,11 mm and 3 to 5 Hz frequency and occur when the actuator wire position reaches central values of the actuator stroke; when sinusoidal is at minimums and maximums the fluctuations are almost null. For these tests, this control has similar behaviours as the previous one, having little lower maximum error and similar fluctuation amplitude. As an example, Fig. 17 shows the results of a sinusoidal wave test with 1/20 Hz frequency.

Fig. 18 shows the results of a multiple step response test. The correspondence between the desired position and the real position is excellent. The

maximum error during stability phase is about 0,02 mm (2%), 4 times smaller than that obtained with the PD control with PWM modulator. Fluctuations have maximum amplitude of 0,04 mm, much more less than those observed previously, and frequencies of 5-6 Hz

5.3. PD control and fuzzy supervisor with PWM modulator results

Experimental tests showed that decreasing K_D values, with K_P constant, originate high overshoots and low position errors in stability state while increasing K_D lead to high oscillations and errors in stability state but negligible overshoots. This information induced to build a "supervisor" block able to choose the right K_D value depending on the position to be controlled: a fuzzy supervisor.

Square wave response tests with fuzzy supervisor (Fig. 19) show maximum error in stability state less than 0,33%, corresponding about to one half of the corresponding error in case of simple PD control and PWM modulator; moreover the error decreases with no overshoot increase. The sinusoidal wave tests don't demonstrate important advantages of the supervisor, showing comparable errors and oscillations.

Fig. 20 shows the results of a multiple step response test with the fuzzy supervisor.

The correspondence between the desired position and the real position is excellent. The maximum error during stability phase is less than 2%, similar to the value obtained with the fuzzy control. Fluctuations have maximum amplitude of 0,01 mm, much more less than those previously observed, both with the PD control with PWM modulation and the fuzzy control.

6. Conclusions

Due to the thermomechanical characteristics of Shape Memory Alloy wires, it is important to develop control systems in order to design new applications for these smart materials. This work presents and compares three SMA wire position controls: a PD control with PWM modulation, a fuzzy logic control and a PWM control with fuzzy supervisor. The experimental tests comprised square wave response tests, sinusoidal wave tests and multiple step response tests. Interesting results are a maximum error during stability phase with the fuzzy logic control four times smaller than that obtained with the PD control, with reduced fluctuations amplitude. The PD control with fuzzy supervisor is a control more simple than the fuzzy control and lead to similar results for the sinusoidal tests and step response tests, with fluctuation amplitude much more less than those observed with the PD or the fuzzy control.

Indeed the best of these control systems can be used in many applications, such as in flexible actuators and grippers. The reliability of the control system could allow simple design solutions for various robots and robotic end-effectors.

Moreover, the future work will be the study of the possibility to create a resistance feedback control. The relationship between electric resistance and position of the wire would be experimentally determined, then the position control would be modified comparing the reached position with this “foreseen position”. To implement these position controls on different SMA actuators will allow to evaluate their real performances.

7. References

- Boyd, J.G. and Lagoudas, D.C. 1998. A thermodynamic constitutive model for the shape memory materials part I. The monolithic shape memory alloys. *International Journal of Plasticity*, Vol.6, pp.805-842.
- Brinson, L.C. 1990. One-dimensional constitutive behaviour of shape memory alloys: thermo mechanical derivation with non-constant material function. *Journal of Intelligent Material and Structures*, Vol. 7, pp.108-114.
- Li, H. and Gupta, M. 1995. *Fuzzy logic and intelligent systems*. International series in intelligent technologies, Kluwer Academic Publishers.
- Liang, C. and Rogers, C. A. 1990. One-dimensional thermomechanical constitutive relations for shape memory material. *Journal of Intelligent Material and Structures*, Vol. 1, pp.207-234.
- Ma, N. and Song, G. 2003. Control of shape memory alloy actuators using pulse-width pulse-frequency (PWPF) modulation. *Journal of Intelligent Material Systems and Structures*, Vol. 14, pp.15-22.
- Ma, N. and Song, G. 2003. Control of shape memory alloy actuators using pulse width modulation. *Smart Materials and Structures*, Vol. 12, pp.712-719.
- Ma, N., Song, G and Lee, H-J. 2004. Position control of shape memory alloy actuators with internal electrical resistance feedback using neural networks. *Smart Materials and Structures*, Vol. 13, pp.777-783.
- Mac Neill, D. and Freiberger, P. 1993 *Fuzzy logic*. Simon & Schuster, NY.
- Raparelli, T., Zobel, P. B. and Durante, F. 2002. SMA wire position control with electrical resistance feedback. *Conf. On Structural Control*, Como, Italy, Vol. 2, pp.391-398.
- Raparelli, T., Zobel, P. B. and Durante, F. 2008 Mechanical Design of a 3-dof Parallel Robot Actuated by Smart Wires *Proc. of EUCOMES 08 The 2nd European Conf. on Mechanism Science*, pp. 271-278
- Reynaerts, D and Van Brussel, H. 1998. Design aspects of shape memory actuators. *Mechatronics*, vol.8, pp.635-656.
- Shameli, E., Alasty, A. and Salarieh, H. 2005. Stability analysis and nonlinear control of a miniature shape memory alloy actuator for precise applications. *Mechatronics*, Vol. 15, pp.471-486.
- Song, G., Chaudhry, V. and Batur, C. 2003. A neural network inverse model for a shape memory alloy wire actuator. *Journal of Intelligent Material Systems and Structures*, Vol. 14, pp.371-377.
- Sreekumar, M., Nagarajan, T., Singaperumal M., Zoppi, M., Molino, R. 2007. Critical review of current trends in shape memory alloy actuators for intelligent robots *Industrial Robot: An International Journal*. Vol. 34, pp. 285 – 294.
- Yang, K., Wang, Y. 2008. Design, drive and control of a novel SMA-actuated humanoid flexible gripper *Journal of Mechanical Science and Technology*, Vol. 22, N. 5, pp. 895-904
- Tanaka, K. 1986. A thermomechanical sketch of shape memory effect: one-dimensional tensile behaviour. *Res. Meccanica*, Vol.18, pp.251-263.