

Computer Aided Inspection: design of customer oriented benchmark for non contact 3D scanners evaluation

Original

Computer Aided Inspection: design of customer oriented benchmark for non contact 3D scanners evaluation / Vezzetti, Enrico. - In: INTERNATIONAL JOURNAL, ADVANCED MANUFACTURING TECHNOLOGY. - ISSN 0268-3768. - (2008), pp. 1-13. [10.1007/s00170-008-1562-x]

Availability:

This version is available at: 11583/1662692 since:

Publisher:

Published

DOI:10.1007/s00170-008-1562-x

Terms of use:

This article is made available under terms and conditions as specified in the corresponding bibliographic description in the repository

Publisher copyright

(Article begins on next page)

NOTICE: this is the author's version of a work that was accepted for publication in "International Journal of Advanced Manufacturing Technology". Changes resulting from the publishing process, such as peer review, editing, corrections, structural formatting, and other quality control mechanisms may not be reflected in this document. Changes may have been made to this work since it was submitted for publication. A definitive version was subsequently published in International Journal of Advanced Manufacturing Technology, April 2009, Volume 41, Issue 11-12, pp 1140-1151, DOI:10.1007/s00170-008-1562-x. The final publication is available at link.springer.com

Computer Aided Inspection: design of customer oriented benchmark for non contact 3D scanner evaluation

Enrico Vezzetti

Dipartimento di Sistemi di Produzione ed Economia dell'Azienda
Politecnico di Torino

Abstract

Many different applications of online product inspections have found a significant advantage by the use of 3D scanners, especially when working with complex surfaces (FREE-form,...), where traditional inspection tools proved to have significant limitations. Unfortunately, there are not only success stories, but also several situations in which the approach towards 3D scanner technologies has been unsuccessful. This is mainly due to the fact that it is hard to understand which is the best 3D scanner solution to adopt, and which working protocol is to be followed in order to obtain the best results from a specific application.

These problems are often caused by the absence of a long expertise in 3D scanners and by the presence of inappropriate technical sheets. These last are in fact quite fragmented, inhomogeneous and only provide little information about the device behavior in the different working scenarios, since they tend to be more oriented to the theoretical metrological performances.

Most of the times, this information is not useful for users, who need to have a unique map showing both 3D scanner technical performances and their correlations to the different working scenarios, in order to be able to compare the several available systems and to get a better understanding of their usage.

In order to provide a solution to this problem, this paper proposes to create a customer benchmarking methodology, that is a mixture of benchmark geometry designs and experiment sets. This benchmarking methodology will be focused on the simulation of a computer aided inspection working scenario and carried out by using the Quality Function Deployment (QFD) method, in order to be oriented towards customer needs.

Keywords: Reverse Engineering, 3D scanner, Laser Scanner, Quality Function Deployment

1.0 Introduction

Surface inspection is usually a bottleneck in many production processes. There are a great number of manufacturing processes which attempt to carry out an inspection of surface defects (steel strip, hot steel slabs, plastic plates and tile surfaces). Normally, these processes are developed through visual inspection. For this reason, they deeply depend on human inspectors, whose performance is generally inadequate, subjective and variable. In order to solve this problem, which is particularly important when companies have to verify complex surfaces (Free-Form), for which the use of classical tools, such as metrological tools, is not suitable, it is necessary to move towards different kinds of solutions such as 3D scanners. These new solutions must be able to automatically collect the morphological information of the analyzed product and compare the results obtained with a specimen. This process could be implemented through the use of computer aided inspection software [1-5]. When the analyzed surface is not very extensive, it is possible to adopt coordinate measure machines (CMM), thanks to their high precision level and good integration with smart computer aided inspection software. However when the dimensions of the object are bigger, the use of these contact tools is quite limited, because of their reduced acquisition rate and flexibility. Hence, when performing inspections, it is generally preferred to adopt a different typology of metrological device, that is non contact 3D scanner, mainly characterized by non contact technologies, which guarantee an high speed rate even on big objects.

Unfortunately, this strong attention to 3D scanner systems has incited many of the providers working in the artificial vision system, to propose their own tools, in the attempt to cover the highest portion of this new market. Even though some of the tools they proposed are remarkably good for general purpose applications, some others present limitations which are not so easy to understand when reading the technical sheets. In fact, these technical documents are often incomplete and fragmented, and the information they provide about 3D scanner performances is usually not enough for the user to understand whether the device can provide the performances he/she needs for his/her application. As contrary effect, many of the users who wish to introduce a 3D scanner into their organizations do not have a clear idea of which is the right tool for their applications. That is why they sometimes abandon the idea or adopt a non-

efficient technology. In both cases users end up being confused or scorched by the situation, and tend to maintain a certain distance from technology.

Some people understood this problem and asserted that it is necessary to combine a single map of all the numerous technical performances with respect to every technology and maker. According to them, this is the only way to help users in their selection process, trying to direct them immediately to the right solution or, at least, close to it. Some studies have already proposed some 3D scanner comparisons, but they are mainly limited on photogrammetry [6-9] and tend to look at the systems more as metrological tools than as 3D scanners employed in reverse engineering applications. These works usually present only little performance information as standardized metrological data, and do not provide an exhaustive set of the data obtained by simulating the 3D scanner behavior with respect to different possible applications, in order to help users understand whether the 3D scanner could fit their specific application or not [10,11].

None of these works look at the development of a benchmarking procedure from the customers' point of view; besides none of these studies use the same procedure to analyze the behavior of non-contact 3D scanners, thus contributing to further confusing users.

In the attempt to fill the lack of clear information, this paper aims at proposing the design of a 3D scanner benchmarking procedure through the adoption of a Quality Function Deployment approach, in order to steer the design in the direction of computer aided inspection and customer needs.

3.0 Benchmarking Methodology Design

When implementing a non contact reverse engineering solution, users are not often interested into the metrological performances of the device. Instead, they tend to be more interested in knowing how they are correlated with the scenario in which they will work, in the attempt to understand whether the tool they are observing fits their applications or not. Hence, to guarantee the development of a benchmarking procedure as close as possible to the customer needs, hence suited to easily compare several different non contact 3D scanners for morphological inspection of manufactured products, this paper proposes to adopt the Quality Function Deployment (QFD) approach.

3.1 Design by Quality Function Deployment (QFD)

In order to establish a correlation between the 3D scanner performances and the actual needs of the customers/users, this paper proposes to employ the Quality Function Deployment [12-14] approach. Even if QFD is normally adopted to establish which technical parameters are the most important and should characterize the development of a new product [15], this paper employs the QFD with the aim of selecting which features are the most suited to help users in the selection of an existing 3D scanner.

3.1.1 Customers/Users needs

The first step of the QFD method is based on the identification of the customers/users needs. This information has been collected through a series of interviews made on a sample of manufacturing companies which employ computer aided inspection solutions in their normal activity. At the beginning, the interviewer has left to the interviewed persons the possibility to freely explain which needs they consider to be the most important for computer aided inspection operations, without having to answer to specific questions.

The "Raw Data" collected have then been managed in order to better express customer needs ("Reworded Data"), and to show possible similarities between the information given by different customers, thanks to the use of Hierarchical Cluster Analysis [16].

When working on the reworded data, interviewed persons have been asked to express a relative importance for every different need on a scale from 0 to 10.

Thanks to this relative importance value (d_i), expressed with respect to every need, it has been possible to create an organized "importance list" (Tab.1).

Customer Needs	Aggregated Customer Needs	Relative importance d_i
Able to work with little size objects	To provide reliable morphological information working over objects of different dimensions	20%
Able to work with big size objects		
Able to work with medium size objects		
Able to work over different color surfaces	To provide reliable morphological information working over different kind of surfaces	30%
Able to work over non uniform surfaces		
Able to work over undercut geometries	To provide reliable morphological	50%

Able to work over free-form geometries	information working over complex objects (different curvatures)	
--	---	--

Table 1: Customer needs list and relative importance

3.1.2 3D Scanner Specifications

The second step of the QFD method consists in the definition of the possible 3D scanner measurable specifications. A non-contact measuring sensor is a device which is able to create a correlation between the pixels of the picture taken by the sensor and the corresponding 3D points of the framed part area, by using a CCD camera combined with a suitable lighting device. Most 3D non contact scanners employ triangulation and can be divided into passive or active systems [17]. Passive systems, such as stereo or photogrammetric systems, only use cameras with natural light, while active systems employ artificial light patterns. The majority of the systems used in industrial setting are active, since they are able to project different form of illumination lights onto the object and to measure the position of the illumination on the object, using cameras or other light sensing sensors. A typical triangulation device projects a point or a line of laser light onto an object and then observes the intersection of the object and the laser through digital cameras. The camera views the intersection of laser and object as a curve or a line, depending on the shape of object's surface. The three-dimensional coordinates (x, y, z) of the stripe/object points are then computed by triangulation [18].

Another common triangulation technique is grid coding. Sensors of this type are often referred to as area-based sensors, because they measure a square or rectangular area and not a point or a line, as does the laser triangulation technique described above. In this solution, a series of binary patterns, consisting of black and white stripes, are projected onto the object over a short period of time. These patterns can be produced in many different ways. Each pattern has a different spacing (period, or frequency) between the stripes. As a striped pattern is projected onto the object, a camera captures the scene. At the end of the projection period, which usually only takes a few seconds, images are analyzed and a dense point cloud is generated.

Leaving aside the specific technology employed, it is possible to characterize a non-contact 3D scanner, from a general point of view [19], thanks to the following list of technical specifications [20,21,22]:

- **Weight:** it represents the weight of the entire 3D scanner with all its accessories
- **Acquisition rate:** the rate at which a ranging sensor can acquire range samples.
- **Repeatability:** the degree to which repeated measurements of the same quantity vary about their mean
- **Accuracy:** the degree of conformance between a measurement of an observable quantity and a recognized standard or specification that indicates the true value of the quantity.
- **Resolution:** the minimum dimension of an object feature that the 3D scanner is able to acquire
- **Depth of Field:** it refers to the interval of distance through which a stationary reference ranging system can measure without resorting to a change in configuration.
- **Working Volume:** any active ranging, range imaging, or position tracking system has a practical maximum distance that it can measure. This is due to the fact that the controlled energy, whether propagated as a wave or established as a field, must spread before reaching the detector. The spreading inevitably increases with distance and all detectors, no matter what form of energy they measure, require a certain minimum amount to exceed their inherent "noise floor"
- **Dimensions:** the dimension represents the size of the entire 3D scanner device with all its components and accessories

3.1.3 The correlation matrix

Once having defined the customers needs and the technical specifications, it is necessary to identify which correlation level exists between technical specifications and user needs. Hence, it is essential to understand which technical specifications can better fit customer needs. These tables have been evaluated by several independent 3D scanner technicians, who have been in charged of suggesting the level of correlation r_{ij} existing between technical specifications and user needs, by employing three different values (5 – 3 – 1). By managing the collected data, it has then been possible to define an average correlation matrix (Tab.2).

<u>Correlation Level</u> r_{ij}	Depth of Field	Weight	Acq. Rate	Repeat.	Accur.	Resol.	Working Vol.	Dimen.
Different Dimensions	5	3	3	5	5	5	5	3
Different surfaces	1	1	1	5	5	5	1	1
Complex surfaces	3	3	1	5	5	5	3	3

Table 2: Correlation matrix between customer needs and technical specifications (r_{ij})

The final step of the QFD approach consists in the evaluation of the absolute importance level w_j , which is to be found inside the technical specifications, and the relative level w_j^* . This evaluation is essential in order to focus the attention on the most significant technical specifications while starting the benchmarking strategy design. Moreover, this evaluation allows the design of a set of tests based on customer needs (Tab.3). This final information (about customer needs) can be obtained by following the **Independent Scoring Method**, that is a combination of the correlation r_{ij} , the customer needs, the technical specifications and the relative importance of the specific customer needs d_i :

$$w_j = \sum_{i=1}^n d_i \cdot r_{i,j} \quad (1)$$

where n = customer needs number and m = technical specification number

$$w_j^* = \frac{w_j}{\sum_{j=1}^m w_j} \quad (2)$$

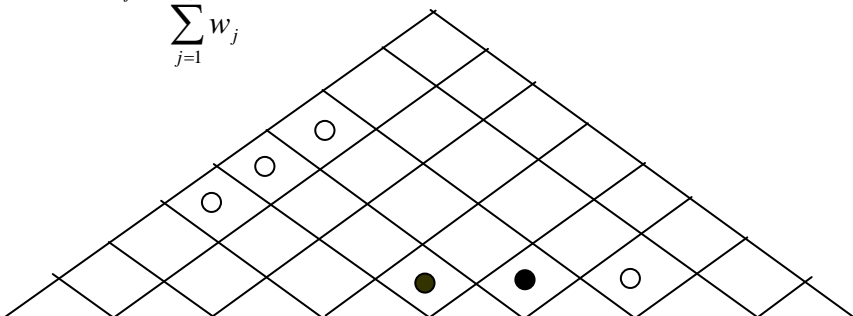

	Depth of Field	Weight	Acq. rate	Repeat.	Accur.	Resol.	Working Vol.	Dimen.
Different Dimensions	5	3	3	5	5	5	5	3
Different surfaces	1	1	1	5	5	5	1	1
Complex surfaces	5	3	1	5	5	5	3	3
<u>Relative Importance</u> w_j^*	13%	9%	5%	18%	18%	18%	10%	9%

Table 3: Correlation matrix between customer needs, technical specifications and relative importance of the technical specifications

3.1.4 Benchmarking Strategy Definition

Following the suggestions extracted from the results previously obtained through the QFD implementation, it is possible to infer that the 3D scanner technical specifications which better suit customer needs are: **accuracy**, **repeatability**, **resolution** and **depth of field**, values which show a percentage higher than 10%.

Before starting the actual benchmark design, it is necessary to complete the QFD scheme, focusing the attention on the triangular roof of the scheme. This section of the table provides other important information for the benchmarking design, explaining that some of these technical specifications are correlated between themselves. Some of them, represented by a black circle in the QFD scheme, show positive correlations, which means that when increasing one parameter, the correlated ones will also increase as a consequence. Some other specifications, represented by a white circle in the scheme, have a different behavior and show a negative correlation, which means that when a technical specification increases, its correlated parameter decreases its performances (Tab.3).

Starting from the information given by the independent technicians, the first positive correlation found shows that it is possible to obtain an increase of **accuracy** by positively improving the **repeatability** and **resolution** performances. As far as negative correlations are concerned, it is possible to identify that as the **working volume grows**, the **resolution** tends to worsen. Similarly, **as the depth of field**, which is necessary for the acquisition of a big object, increases, **resolution**, **accuracy** and **repeatability** decrease.

After this last information, it is necessary to make some considerations on the technical specifications that the QFD method has identified as the most important. First of all, it is possible to understand that both the **working volume** and the **depth of field** depend on the **resolution**, **accuracy** and **repeatability** *acceptability level*, as explained by the correlation shown in the QFD scheme roof.

For this reason, it is quite clear that **depth of field** and **working volume** are two of the most important parameters for defining the working scenario of the benchmarking procedure. On the other hand, resolution, accuracy and repeatability are the performance parameters to measure in order to understand until which level the 3D scanner is able to give acceptable values, when being moved within its working scenario, thus modifying the acquisition conditions. Hence, in order to complete the benchmarking procedure design, it is necessary to synthesize the working conditions in which the customer wishes to employ the 3D scanner. To simulate the working scenario in the best possible way, it is essential to identify which parameters are likely to vary during computer aided inspection operations. Starting from the customer needs' column of the QFD scheme, it is possible to identify the following points:

- Working with different dimension objects (*degrees of freedom*)
- Working with different geometries (*number and type*)
- Working with different surface typologies (*color*)

Starting from this information, it is possible to begin the design of the benchmarking strategy, which consists of (Fig.1) two main steps: the creation of a measuring geometry (**Benchmark Geometry**) and the design of a **set of experiments**. It is important to mention that in the latter step, the working parameters values have been modified to better simulate the computer aided inspection scenario. The whole benchmarking strategy has been designed (Tab.4) by adopting a top down refining design approach, that is the Work Break Down Structure (WBS). The reason of this choice is that this approach, which is typical of the project management literature [23,24] and of the rules of design for experiment strategies (DOE)[23], is able to give an organized and global description of 3D behavior in different working conditions.

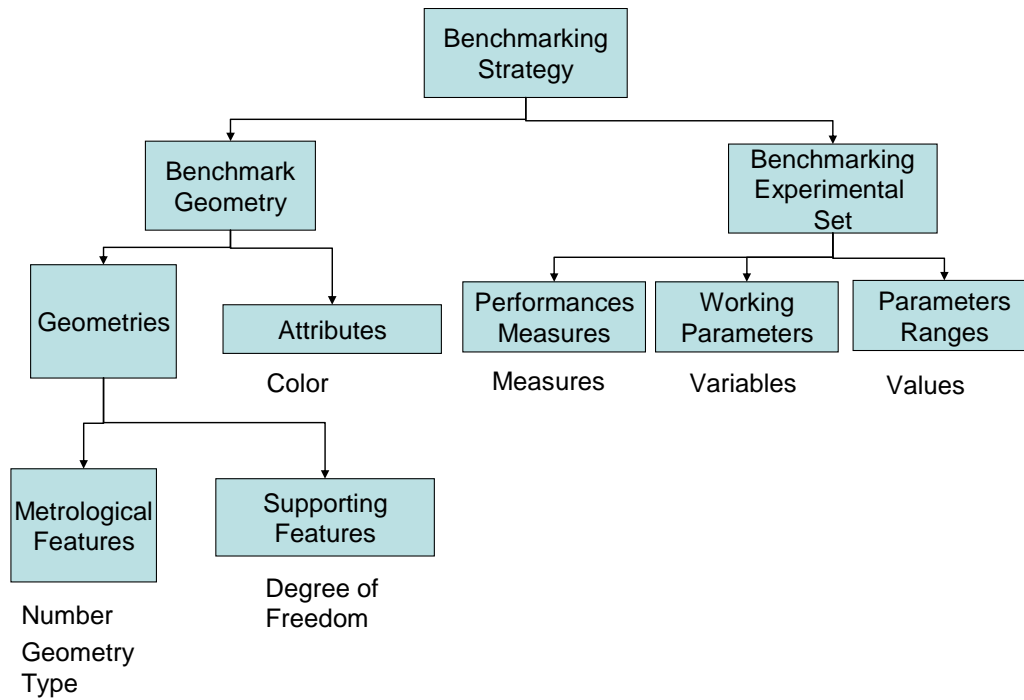

Figure 1: Benchmarking strategy refining top down design synthesis

Level I	Level II	Level III	Level IV
<p>Necessity to measure accuracy, repeatability and resolution: considering that the most frequently employed geometries for calibration and measuring procedure are spheres, this benchmark will employ spheres: THE USE OF TWICE MEASURED SPHERES FOR REPEATABILITY EVALUATION</p>			
	<p>Necessity to measure accuracy, repeatability and resolution with different curvature values: considering the presence of spheres which verify the behavior of the scanner for different curvatures, it is possible to employ more than one diameter: THE USE OF 3 SPHERES WITH DIFFERENT DIAMETERS FOR ACCURACY EVALUATION BY MEASURING THEIR CENTER RELATIVE DISTANCE ALONG X,Y,Z</p>		
		<p>Necessity to measure accuracy, repeatability and resolution of different surfaces: considering the necessity to know which are the performances of the system in different operative conditions, it is necessary to work on a surface as close as possible to the lambertian one, in order to know which are the best performances. For this reason considering the presence of photogrammetric systems, (which acquire the object surface with the help of natural or artificial light, although in general can work even with light reflection), it is necessary to employ opaque and with white colored surfaces: THE USE OF THREE OPAQUE AND WHITE COLORED SPHERES</p>	
	<p>Necessity to measure the accuracy, repeatability and resolution of different surfaces: considering the necessity to measure the accuracy, repeatability and resolution of different surface complexities, and considering the use of non-contact 3D scanners, it is essential to know which is the behavior of the device, depending on the different possible reflection configurations: THE USE OF A FLEXIBLE SUPPORTING STRUCTURE, which ALLOWS THE ROTATION OF THE THREE SPHERES ALONG THE X AXIS</p>		
		<p>Necessity to measure the accuracy, repeatability and resolution of different dimension objects: considering the necessity to use only one benchmark geometry to verify how change the scanner behavior in order to adapt to different object dimension, it is necessary to have a movable benchmark. This movable structure is essential to verify the resolution and accuracy of the 3D scanner with respect to distant objects , and also to simulate acquisition of big objects. Besides, It is necessary to evaluate the 3D scanner depth of</p>	

		field range, that is the range in which resolution and accuracy do not show significant variations: THE USE OF A FLEXIBLE AND LIGHT SUPPORTING STRUCTURE WHICH ALLOWS SIMPLE MOVEMENTS AND STABLE LOCATIONS	
			Necessity to measure the accuracy, repeatability and resolution when working with different distances between the 3D scanner and the object: considering the necessity to use only one benchmark to simulate the acquisition of different dimension objects, it is necessary to locate this benchmark at different distances. In order to understand the behavior of the 3D scanner with respect to different dimensions, it would be interesting to propose at least two different distance values ,around the suggested operative value given by the maker (calibration distance): THE USE OF A FLEXIBLE AND LIGHT SUPPORTING STRUCTURE WHICH ALLOWS SIMPLE MOVEMENTS AND STABLE LOCATIONS, THUS ALLOWING TO SET AT LEAST TWO DIFFERENT DISTANCE VALUES AROUND THE CALIBRATION VALUES
			Necessity to measure the accuracy and resolution when working with different distances between the 3D scanner and the object: as far as the necessity to acquire a big object is concerned, evaluating behavior of the 3D scanner with respect to different distances is not enough. it is also essential to evaluate its behavior inside its depth of field. Therefore, it is necessary to analyze the variation of resolution and accuracy when moving the focusing point away from the average value (that is the one given by the 3D scanner) and also to establish which is the operative range in which the scanner gives reliable values. THE USE OF A FLEXIBLE AND LIGHT SUPPORTING STRUCTURE WHICH ALLOWS SIMPLE MOVEMENTS AND STABLE LOCATIONS, WHILE PERMITTING TO SET TWO OR MORE DISTANCE VALUES, EITHER LOWER OR HIGHER THAN THE CALIBRATION DISTANCE BETWEEN THE OBJECT AND THE 3D SCANNER
		Necessity to measure accuracy and resolution on non ideal surfaces: since knowing which is the behavior of the 3D scanner with respect to a non-uniform surface is also very important, it has been decided to introduce a black surface into the test procedure. considering the necessity to know also what is the behavior of the non contact 3D scanner over a surface that presents non uniform surface conditions, it is possible to introduce a black surface: USE OF A FLEXIBLE AND LIGHT black SUPPORTING STRUCTURE THAT ALLOWS SIMPLE MOVEMENTS AND STABLE LOCATIONS	

Table 4: Benchmarking strategy top down design steps

Once having defined which formalized features must characterize the benchmark geometries and attributes, it is possible to start the actual design process. The first step of the design consists in the identification of a measuring platform, through the using of three white spheres inserted in a black supporting plane, which guarantees them a thorough stability. The location of the spheres inside the supporting plane has been obtained through the making of three calibrated holes, whose height exceeds the sphere radius by 1 mm, in order to guarantee the acquisition of only half of the spheres.

In order to render the structure as flexible and light as possible, the supporting plane does not have to be a perfect disc and its weight has to be reduced by introducing three big fillets. At first, while designing the structure with a top-down design approach, it had been decided to employ three different diameter spheres; however it has been impossible to find three spheres with different diameters. Therefore, only two different kind of calibrated spheres have been used in the final version of the benchmark geometry. Two spheres with diameter $d_1 = 10 \text{ mm}$, and one with diameter $d_2 = 5 \text{ mm}$ (Fig.2) have been selected in order to render the structure homogeneous and balanced.

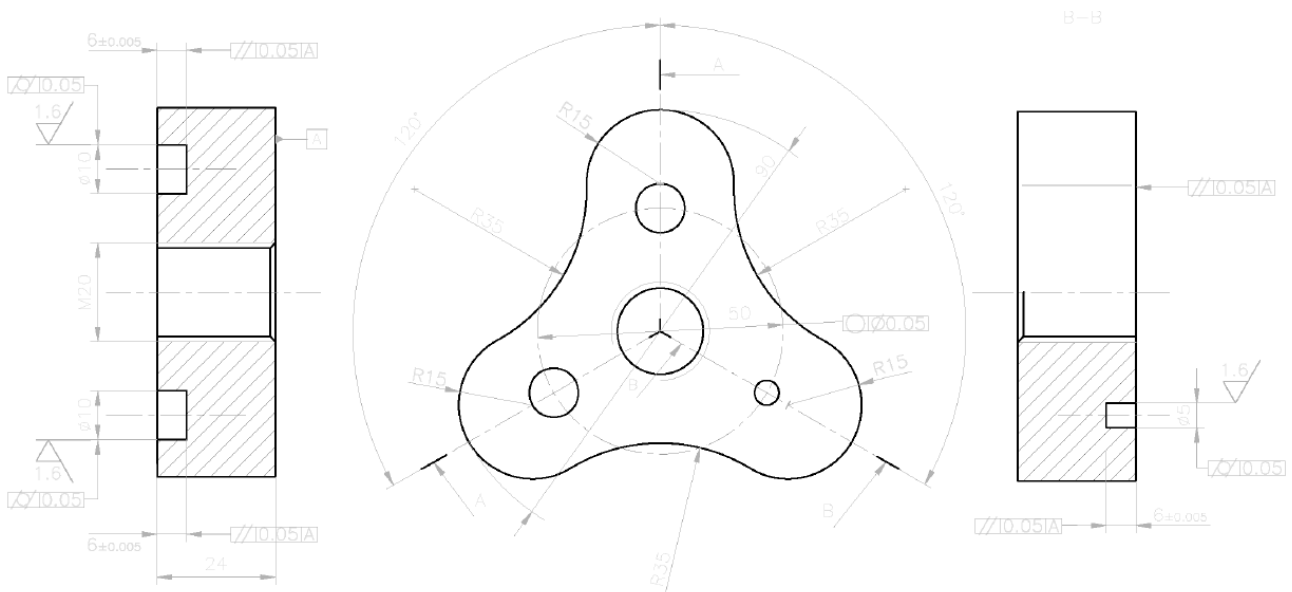

Figure 2: Measuring Platform design drawing

Once having defined the geometry and the attributes of the measuring platform, attention must be focused on designing an appropriate supporting structure. The ideal structure must not only be able to support the platform stability, but also to allow simple movements of the entire benchmark and a stable rotation of the measuring platform along the measuring axis x (Fig.3)

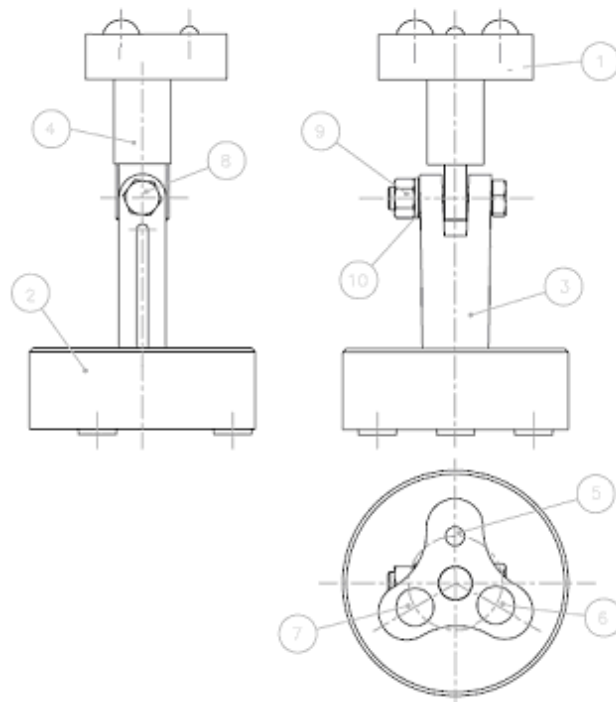

Figure 3: Benchmark design drawing

Once having assembled all the different benchmark components and having calibrated the entire structure with the help of a Coordinate Measuring Machine, the benchmark building process can be considered concluded. At this point, the benchmark is ready to start the testing procedure (Fig.4). The first calibration step consists in defining the measuring work-frame, which must be placed in the center of one of the spheres with diameter $d=10$ (Fig.5) (Tab.1). The centers offset between the three spheres has been employed as a

reference to measure the average accuracy level of the 3D scanner. Hence, the offset of the point cloud obtained in the benchmarking procedure has been compared with the one obtained with the CMM (calibration) in the first experiment .



Figure 4: Final benchmark assembly

	Sphere 1 (d = 10 mm)	Sphere 2 (d = 10 mm)	Sphere 3 (d = 5 mm)	Supporting Platform planarity [mm]
X [mm]	0,000	43,305	21,787	0,03
Y [mm]	0,000	0,155	-37,434	
Z [mm]	0,000	0,000	0,523	

Table 5: Benchmark first calibration values

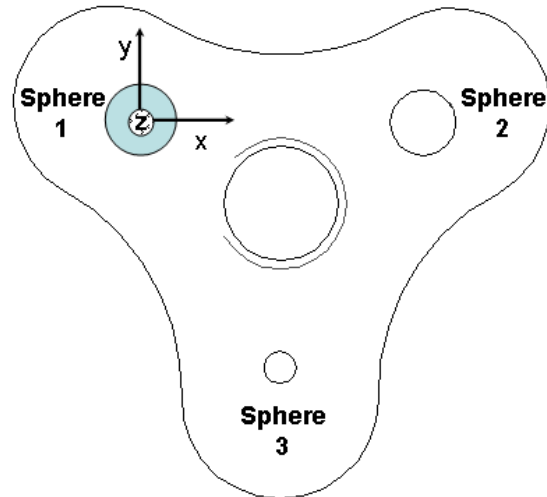

Figure 5: Benchmark first calibration strategy

Starting from the criteria that the Design for Experiment strategy (DOE) gave for every identified variable (that is *distance*, *measuring platform slope* and *depth of field*), two values have been chosen and a set of eight experiments has been conceived. Starting from the distance parameter, two values have been selected in order to increase and decrease the calibration distance of a factor of 25%. This choice is justified by the necessity to understand what happens to the 3D scanner when being moved farther from or closer to the calibration value during the acquisition process.

As far as the depth of field is concerned, the behavior of the system has been verified offsetting the focalizing distance with the two values in front of the surface, and reducing the calibration distance of a factor of 2,5% and a factor of 5%. This choice is explained by the need to understand the behavior of the 3D scanner with respect to two different values inside the 3D Scanner depth of field.

As far as the surface slope is concerned, the reference value is represented by an angle which allows a perfect parallelism between the 3D scanner head and the object surface. Starting from this value, two experimental parameters have then been obtained by increasing and decreasing the slope of a factor of 25% (Tab.6).

Test number	Object distance	Depth of Field	Benchmark Slope
1	-	-	-
2	+	-	-
3	-	+	-
4	+	+	-
5	-	-	+
6	+	-	+
7	-	+	+
8	+	+	+

Table 6: Experimental set

Each experiment has been developed twice, in order to evaluate the repeatability of the device in every possible working condition. As far as the average accuracy (Ac) is concerned, its variations along the different axes (Ac_x , Ac_y , Ac_z) have been evaluated through the employment of the three sphere offsets which have been measured along the different axis and of the values obtained with the CMM machine during the first calibration operation.

The last pieces of information concerning accuracy have been obtained through the planarity evaluation of the supporting platform. The resolution (Re) has then been estimated by measuring the distance between two following points along the x, y and z acquisition axes (Re_x, Re_y, Re_z), over the grid of the acquired spheres. (Tab.7)

Sphere 1 [mm]	Sphere 2 [mm]	Sphere 3 [mm]	Supporting Platform [mm]
$\Delta x, \Delta y, \Delta z$ sphere center coordinates [mm]	$\Delta x, \Delta y, \Delta z$ sphere center coordinates [mm]	$\Delta x, \Delta y, \Delta z$ sphere center coordinates [mm]	Planarity

a)

Sphere 1 [mm]	Sphere 2 [mm]	Sphere 3 [mm]	Supporting Platform [mm]
Grid pitch along x [mm]	Grid pitch along x [mm]	Grid pitch along x [mm]	Grid pitch along x [mm]
Grid pitch along y [mm]	Grid pitch along y [mm]	Grid pitch along y [mm]	Grid pitch along y [mm]
Grid pitch along z [mm]	Grid pitch along z [mm]	Grid pitch along z [mm]	Grid pitch along z [mm]

b)

Table 7: Experimental set of measures and comparisons a) accuracy b) resolution

4.0 Benchmarking experimental test

In order to verify how the benchmark works, a 3D laser scanner with a middle lens set has been employed in the experimental validation phase (Tab8, 9).

The first test has been implemented by working with a middle optic and by locating the benchmark at a distance of 600 mm, provided by the 3D scanner maker for the 3D Scanner calibration. By fixing the slope of the acquired surface at 45° , this surface has been located parallel to the 3D scanner acquisition head. While the measures developed on the spheres have been presented in the table, it has not been possible to obtain consistent information about the plane, since the point of cloud has not provided satisfactory data about it (Fig.6)

Test number (il simbolo del num. è #)	Object distance [mm]	Depth of Field [mm]	Benchmark Slope	Accuracy [mm]	Resolution along x [mm]	Resolution along y [mm]	Resolution along z [mm]	Repeatability
0	800	800	45°	+/- 0.35	0.20	0.20	0.05	0.82

Table 8: Central values experimental results

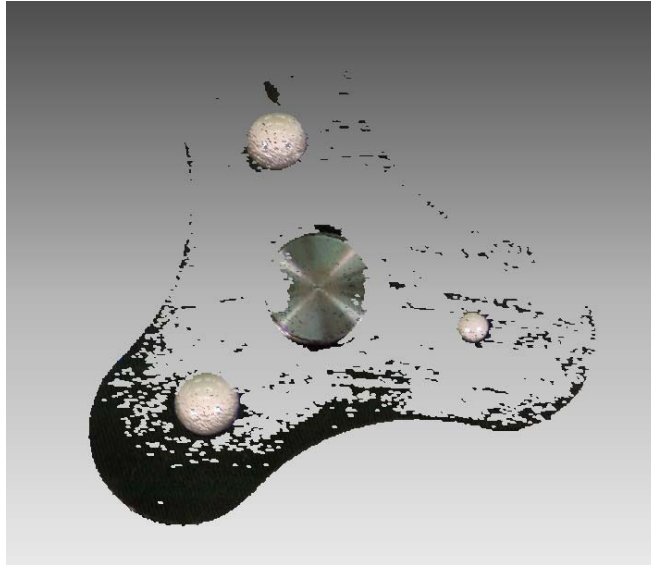

Figure 6: Point cloud acquired inside the depth of field

Test number	Object distance [mm]	Depth of Field [mm]	Benchmark Slope	Accuracy along x [mm]	Accuracy along y [mm]	Accuracy along z [mm]	Resolution along x [mm]	Resolution along y [mm]	Resolution along z [mm]	Repeatability
1	600	-20	34	0.60	0.82	0.74	0.20	0.20	0.07	0.82
2	1000	-20	34	1.00	1.01	1.89	0.35	0.35	0.09	0.75
3	600	-40	34	0.65	1.45	1.62	0.25	0.25	0.08	0.78
4	1000	-40	34	1.10	1.99	1.49	0.37	0.37	0.10	0.65
5	600	-20	56	0.70	0.79	1.61	0.20	0.20	0.08	0.76
6	1000	-20	56	1.25	1.98	2.08	0.40	0.40	0.12	0.70
7	600	-40	56	0.70	0.94	1.47	0.27	0.27	0.12	0.77
8	1000	-40	56	1.30	1.53	1.60	0.39	0.39	0.15	0.62

Table 9: Design for experiment results

The analyzed results show that the 3D scanner maintains rather constant its accuracy and resolution values within the whole depth of field. However, once the device tries to acquire a feature located outside its depth of field, which has been estimated at 40 mm beyond the focusing plane, the 3D scanner proved not to be able to provide a consistent point cloud, and could only produce some noise.

Moreover, thanks to these tests, it has been possible to observe that immediately outside the depth of field, the performances of the 3D scanner collapse, instead of gradually decreasing.

When the object is moved farther from the calibration distance, the resolution values present a significant decreasing along all the axis; accuracy and repeatability also show a similar behavior.

As far as the supporting plane is concerned, tests have shown that when working on dark surfaces, without any color treatment, the 3D scanner is not able to provide stable and consistent morphological data.

Moreover, also when working with the white spheres in an optimal setting, the 3D scanner provides a significant level of noise, due to its low level of accuracy. (Fig.8).

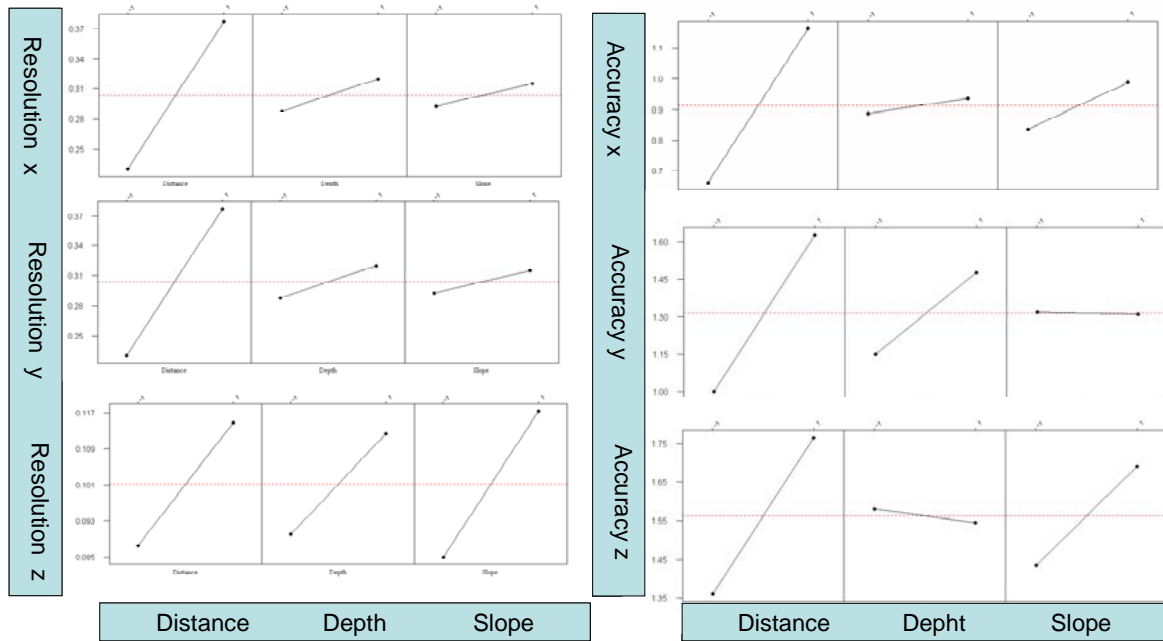

Figure 7: 3D laser scanner performances: a) resolution b) accuracy

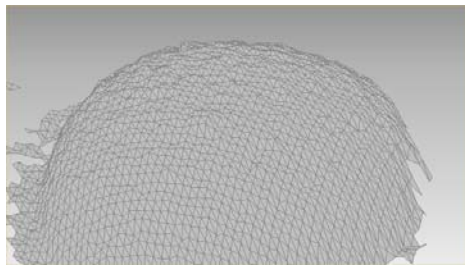

Figure 8: a detailed Point cloud acquired over one of the spheres

5.0 Conclusions

Nowadays it does not exist any stable and codified procedure which can be used to set the working parameters during the acquisition process, and which can guarantee the best 3D scanner performances during specific applications. As a consequence, there is a great need to identify a formalized methodology which could help users to make an optimal selection of the working variables. The development of this benchmarking strategy can be considered as the starting point for the design of a standardized protocol for the acquisition of physical object in different possible working scenarios. Only the presence of an organized database of the performances will render it possible to design a structured model able to characterize the 3D scanner, in relation with working parameters and environment variables. The availability of an organized benchmarking procedure, such as the one presented in this paper, close to the customers needs and to their applications, will not only help users to select the 3D scanner which better fits their necessities, but will also support 3D scanner makers in providing their scanners with a smart software able to assist users during the acquisition setting. Besides, it would be very useful to develop customer oriented benchmarking strategies in other contexts where 3D scanners are normally employed, such as medicine or archeology, in order to obtain a complete and reliable description of the 3D scanner scenario. Moreover, the use of a benchmarking procedure in these alternative domains could turn out to be very useful, since it will partially compensate the users' lack of experience.

7.0 References

- [1] Yau H.T., Menq C.H., Automated CMM path planning for dimensional inspection of dies and moulds having complex surfaces, International Journal of Machine Tools and Manufact., 1995, 5.

- [2] Lartigue C., Mehdi C. Thibaut F., Scan planning strategy for a general digitized surface, *JCISE V(6)*, 2006, 12
- [3] Wu Y., Singh P., Kaucic R., Chen J., Little F., Multimodal industrial Inspection and Analysis, *JCISE V(7)*, 2007, 3
- [4] Sarfraz M., Computer-aided reverse engineering using simulated evolution on NURBS Virtual and Physical Prototyping; December 2006; Volume 1 No. 4 Pages 243 - 257
- [5] Creehan K., Bidanda B., Computer-aided reverse engineering of the human musculoskeletal system Virtual and Physical Prototyping; June 2006; Volume 1 No. 2 Pages 83 - 91
- [6] Marshall S.J., Whiteford D.N., Rixon R.C., Assessing the performance of 3D whole body imaging systems, *Proc. 6th Numérisation 3D/Scanning 2001 Congress, Paris, France, 2001.*
- [7] Rioux M, Colour 3-D electronic imaging of the surface of the human body, *Optics and Lasers in Engineering*, 28: 119-135; 1997 NRC Also, *SPIE Proceedings, Automatic Systems for the Identification and Inspection of Humans*, San Diego, CA. July 28-29, 1994. Vol. 2277. pp. 42-54. NRC 3834
- [8] El-Hakim S.F., Beraldin J.-A., Blais F., A Comparative Evaluation of Passive and Active 3-D Vision Systems, *Proc. Dig. Photogram.*, St-Petersburg, June 25-30, 1995.
- [9] Paakkari J., Moring I., Method for evaluating the performance of range imaging devices, *Proc. Industrial Applications of Optical Inspection, Metrology, and Sensing, SPIE-1821*, 350-356, 1992.
- [10] Besl P.J., (1988) Range imaging sensors, *Machine Visions and Applications*, Vol 1, pp. 127-152
- [11] Prieto F, Redarce T, Lepage R, Boulanger P. An automated inspection system. *Int J Adv Manufact Technol* 2002;19:917–25.
- [12] Kogure M., Akao Y., (1983), "Quality Function Deployment and Cwqc Japan" *Qualità Progress*, n.16, pp. 25-29.
- [13] Almannai B., Greenough R., Kayasdasdas J., A decision support tool based on QFD and FMEA for the selection of manufacturing automation technologies, *Robotics and Computer-Integrated Manufacturing*, Volume 24, Issue 4, August 2008, Pages 501-507
- [14] Kwong C.K., Chen Y., Bai H., Chan D.S.K., A methodology of determining aggregated importance of engineering characteristics in QFD, *Computers & Industrial Engineering*, Volume 53, Issue 4, November 2007, Pages 667-679
- [15] Asi (1987), "Quality Function Deployment", Executive Briefing, American Supplier Institute Inc., Dearborn (Mi)
- [16] Strand T.C., (1985), Optical three-dimensional sensing for machine vision, *Optical Engineering*, Vol 24 N°1, pp 33-40
- [17] Clark J., Wallace A.M., Pronzato G. (1998), Measuring range using triangulation sensors with variable geometry, *IEEE Trans on Robotics and Automation*, Vol.14 N°1, pp 54-60
- [18] <http://www.simple3d.com>
- [19] Clark J., Implementing non-contact digitization techniques within the mechanical design process, *Sensor Review*, Vol 20 N°3, pp195-201
- [20] Lockett S. (1999), Reverse Engineering: an overview and a real time industrial case study, *Time compression Technologies*, Vol. 7, N° 3, pp 54-60
- [21] American National Standard for Automated Vision Systems - Performance Test - Measurement of Relative Position of Target Features in Two-Dimensional Space. ANSI/AVA A15.05/1 – 1989
- [22] Urban, G.L., Hauser, J.R. (1993), *Design and Marketing of New Products*, Prentice-Hall, Englewood Cliffs (Nj), cap 10, pp.267-279
- [23] Box, G. E, Hunter, W.G., Hunter, J.S., Hunter, W.G., "Statistics for Experimenters: Design, Innovation, and Discovery", 2nd Edition, Wiley, 2005, ISBN: 0471718130
- [24] Kerzner H., *Advanced Project Management*, Wiley; 2nd edition (December 1, 2004), ISBN 978-0471472841