

Accuracy Improvement of Real-Time Load-Pull Measurements

*Original*

Accuracy Improvement of Real-Time Load-Pull Measurements / Teppati, Valeria; Ferrero, ANDREA PIERENRICO; D., Parena; Pisani, Umberto. - In: IEEE TRANSACTIONS ON INSTRUMENTATION AND MEASUREMENT. - ISSN 0018-9456. - STAMPA. - 56:2(2007), pp. 610-613. [10.1109/TIM.2007.891049]

*Availability:*

This version is available at: 11583/1678778 since:

*Publisher:*

Elsevier

*Published*

DOI:10.1109/TIM.2007.891049

*Terms of use:*

openAccess

This article is made available under terms and conditions as specified in the corresponding bibliographic description in the repository

*Publisher copyright*

(Article begins on next page)

# Accuracy Improvement of Real-Time Load-Pull Measurements

Valeria Teppati, *Member, IEEE*, Andrea Ferrero, *Member, IEEE*, Daniela Parena, and Umberto Pisani

**Abstract**—This paper describes a new procedure aimed to improve the effectiveness of real-time load-pull calibration. Load-pull measurement accuracy is strongly affected by calibration residual uncertainty. The novel methodology reduces this uncertainty contribution by means of error terms optimization. The proposed method has been tested with simulations and applied to actual measurement data. Considerable improvements have been achieved.

**Index Terms**—Directional couplers, microwave devices, microwave measurements, microwave phase shifters, microwave power amplifiers, tuners, uncertainty.

## I. INTRODUCTION

LOAD-PULL systems offer a powerful tool for nonlinear device characterization and design by measuring the large-signal performances of a device under test (DUT) with different load impedance values [1], [2]. The enhancement of load-pull measurement accuracy is a must, especially when dealing with devices having high input and output reflection coefficients. Load-pull systems can use passive tuners or active loads [3], [4]; in both cases, impedance values and reflection coefficients are measured by a vector network analyzer (VNA), directly (real-time systems), or by means of tuner precharacterization.

Let us consider a VNA-based real-time load-pull system, such as the one sketched in Fig. 1. The two reflectometers take the incident and reflected waves at ports 1 and 2 and provide them to the VNA for measurement. The reflection coefficient seen at port 2 ( $\Gamma_L$ ) can be varied with an active (e.g., active loop) or passive (e.g., tuner) load tuning system. This system allows for real-time measurements of  $\Gamma_L$ ,  $\Gamma_{in}$ , input and output power, and gain of an active DUT.

The system is generally calibrated in two steps: 1) A traditional two-port calibration is carried out at the DUT reference planes, and 2) a power meter measurement is performed for absolute power-level calibration [4], [5]. As a consequence, the overall uncertainty strongly depends on the accuracy of power-level measurements. This issue has been extensively investigated in [6] and [7]. In [6], a method for the evaluation of active real-time load-pull uncertainty for power, gain, and power-added efficiency (PAE) was given, whereas in [7], real-time and nonreal-time load-pull uncertainties were compared.

This paper is focused on the development of an optimization methodology to improve real-time load-pull measurement accuracy.

In Section II, we define the problem and describe the optimization technique. Section III shows the preliminary simula-

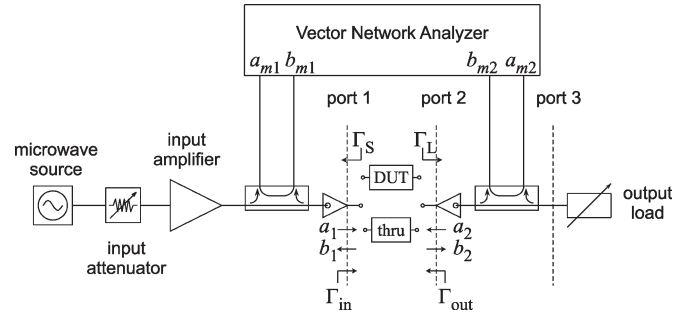

Fig. 1. Simplified scheme of a VNA-based real-time load-pull system.

tions, which are aimed to test the proposed method, whereas Section IV presents the measurement procedure, the experimental setup, and the measurement results. Eventually, some conclusions are briefly discussed.

## II. PROBLEM DEFINITION

The real-time load-pull test set sketched in Fig. 1 allows for real-time measurement of input power  $P_{in}$ , output power  $P_{out}$ , gain  $G$ , and PAE of a DUT. In particular, operating gain is defined as

$$G = \frac{P_{out}}{P_{in}} = \frac{|b_2|^2 - |a_2|^2}{|a_1|^2 - |b_1|^2} = \frac{|b_2|^2(1 - |\Gamma_L|^2)}{|a_1|^2(1 - |\Gamma_{in}|^2)} \quad (1)$$

whereas the available gain is defined as

$$G_{av} = \frac{P_{out}}{P_{av}} = \frac{|b_2|^2(1 - |\Gamma_L|^2)(1 - |\Gamma_S|^2)}{|a_1|^2|1 - \Gamma_{in}\Gamma_S|^2} \quad (2)$$

where  $a_i$  and  $b_i$  ( $i = 1, 2$ ) are the incident and reflected waves, and  $\Gamma_{in} = b_1/a_1$  and  $\Gamma_L = a_2/b_2$  are the reflection coefficients at the input and output ports, respectively.

In [6], uncertainty contributions due to VNA measurement repeatability, power-level uncertainty, and connection repeatability were taken into account.

In this paper, we will consider only the residual calibration uncertainty contributions that are independent from the power-level measurement, regardless of their origin.

The basic idea of this paper is to enhance the measurement accuracy by optimizing the calibration coefficients (*calset* hereafter) and exploiting a load-pull map of a thru device versus  $\Gamma_L$  at single frequency.

The gain of a thru device is equal to 0 dB, by definition, since  $a_1 = b_2$  and  $b_1 = a_2$  and should not vary with  $\Gamma_L$ . If affected by uncertainty, instead,  $|G|$  dramatically increases with  $|\Gamma_L|$ . This effect has been demonstrated in [6]–[8], and in this paper, it is exploited to optimize the calset.

Manuscript received July 11, 2006; revised October 30, 2006.

The authors are with the Dipartimento di Elettronica, Politecnico di Torino, 29-10129 Torino, Italy (e-mail: valeria.teppati@polito.it).

Digital Object Identifier 10.1109/TIM.2007.891049

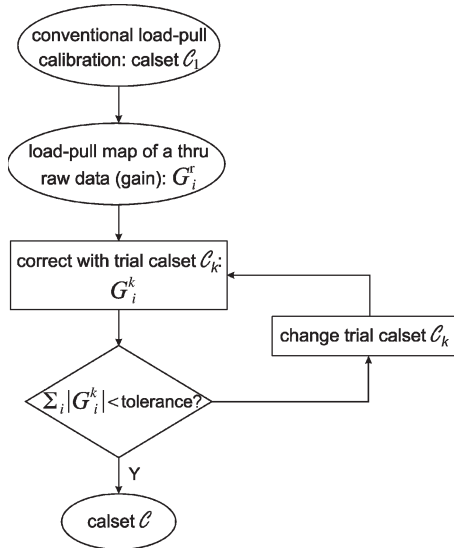

Fig. 2. Flowchart representing the steps of the optimization procedure introduced in this paper.

The steps of the proposed optimization technique are summarized in Fig. 2.

First, the system is calibrated with a conventional method, e.g., thru–reflect–line (TRL), and the resulting calset is stored in a vector  $\mathcal{C}_1 = [c_1 \ c_2 \ \dots \ c_7]$ .

Then, a load-pull of a thru device is performed on the entire Smith chart while measuring raw waves  $a_{1i}^r$ ,  $b_{1i}^r$ ,  $a_{2i}^r$ , and  $a_{2i}^s$  for each load condition  $i$ , with  $i = 1, \dots, N$ .

The calset  $\mathcal{C}_1$  is now taken as a starting point for an optimization loop. At each  $k$  step of the optimization, a new trial calset  $\mathcal{C}_k$  is computed. The raw data  $a_{1i}^r$ ,  $b_{1i}^r$ ,  $a_{2i}^r$ , and  $a_{2i}^s$  are corrected with this  $k$ th trial calset, and for each load condition  $i$ , the corrected gain  $G_i^k$  (in decibels) is computed.

The minimizing function  $\mathcal{F}_k = \sum_{i=1}^N |G_i^k|$  is then evaluated. This quantity can also be taken as a figure-of-merit, which quantitatively represents how good our calibration is.

These steps are repeated until  $\mathcal{F}_k$  (or its variation at each iteration step) reaches below tolerance. The minimization is performed with a Nelder–Mead multidimensional nonlinear minimization algorithm, which is implemented in MATLAB<sup>1</sup> (function `fminsearch`). Convergence is generally reached after 200–300 iterations and can be monitored by plotting  $\mathcal{F}_k$  for each iteration.

Note that the gain, which is defined in (1), is a function of ratio quantities; for this reason, only the seven classical error coefficients affecting gain uncertainty can be optimized with this technique, whereas the power coefficient cannot be optimized [4].

### III. SIMULATION RESULTS

As a starting point for simulations, different on-wafer calibration standards (opens, shorts, loads, lines, and thrus) were measured, and measurements were repeated several times.

With these data, a mean calset and its standard deviation were computed, with conventional line–reflect–match (LRM), short–open–load–reciprocal (SOLR), and TRL calibrations.

<sup>1</sup>MATLAB is a registered trademark of The Mathworks Inc., Natick, MA.

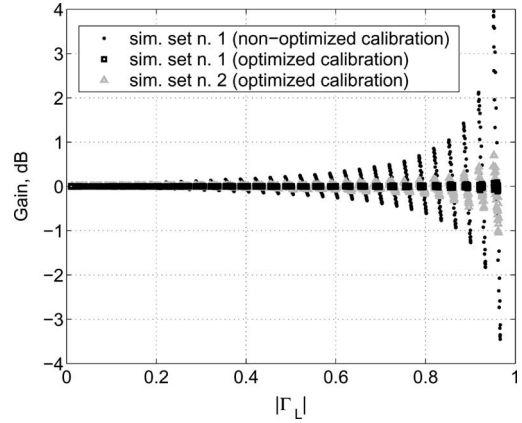

Fig. 3. Simulation results for thru gain versus  $|\Gamma_L|$ : effect of optimization on two different simulated data sets.

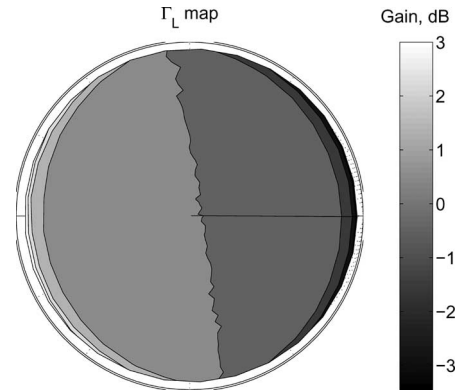

Fig. 4. Simulated contours of an on-wafer thru gain. Data (simulated set n. 1) are corrected with the mean calset.

A set of “ideal” reflection coefficients  $\Gamma_L = \Gamma_{in}$ , which are expected from a thru connection, is then created on a regular pattern on the Smith chart. The magnitude and phase are linearly spaced from 0 to 0.96 and from  $0^\circ$  to  $360^\circ$ , respectively.

With these ideal reflection coefficients and the mean calset, a set of realistic raw data is computed by means of a reverse deembedding procedure.

A small Gaussian perturbation is then applied to the realistic raw data and to the mean calset. This perturbation has been evaluated on the basis of the calset standard deviation. We call this set of simulated measurement “simulated set n. 1.”

We now apply the optimization algorithm to simulated set n.1, obtaining an optimized calset. Simulated set n. 1 can be corrected with the optimized calset and with the original calset. In Fig. 3, we plot the gain (in decibels) as a function of  $|\Gamma_L|$  for these two sets of corrected data (dots: original calset; squares: optimized calset). The dispersion of gain values is strongly reduced by the use of the optimized error coefficients.

In Fig. 4, simulated set n. 1 corrected with the nonoptimized calset is plotted as load-pull gain contours to show its variation versus  $\Gamma_L$  phase.

Finally, a second set of perturbed raw data, which is not correlated with the first one (“simulated set n. 2”), is corrected with the optimized calset, and the results are plotted in Fig. 3 (triangles). Also, the algorithm is still effective on these data, which were not involved in the minimization procedure.

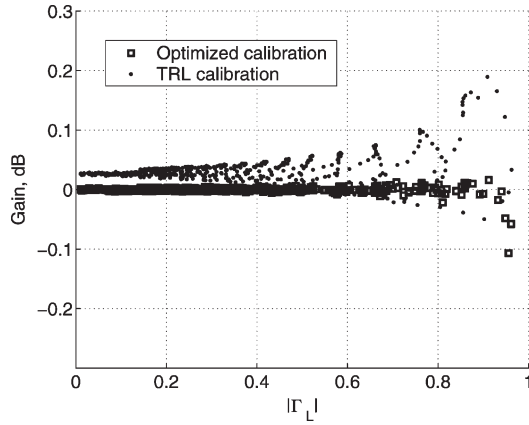

Fig. 5. Thru gain versus  $|\Gamma_L|$ , corrected with TRL algorithm (dots) and with optimized calset (squares).

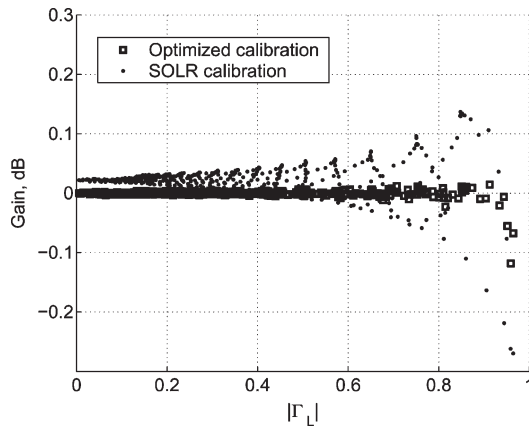

Fig. 6. Thru gain versus  $|\Gamma_L|$ , corrected with SOLR algorithm (dots) and with optimized calset (squares).

Therefore, simulation results are consistent with expectations and confirm the validity of the proposed methodology.

#### IV. MEASUREMENT RESULTS

In order to validate this method also in an actual case, some measurements have been performed in on-wafer environment. The experimental setup used for on-wafer measurements is the real-time load-pull system, as sketched in Fig. 1.

The test procedure consists of the following steps:

- 1) load-pull calibration with TRL and SOLR algorithms: raw measurements of standard devices are acquired, then external processing is applied, avoiding contact repeatability uncertainty;
- 2) thru connection;
- 3) sweep of  $\Gamma_L$  and measurement of raw waves;
- 4) calset optimization, minimizing gain error on the whole Smith chart;
- 5) active device load-pull measurement and error correction with optimized and nonoptimized calsets.

The effect of the proposed algorithm is shown in Figs. 5 and 6.

In Fig. 5, gain measurements of a thru device while sweeping  $\Gamma_L$  are corrected with a conventional TRL calibration procedure

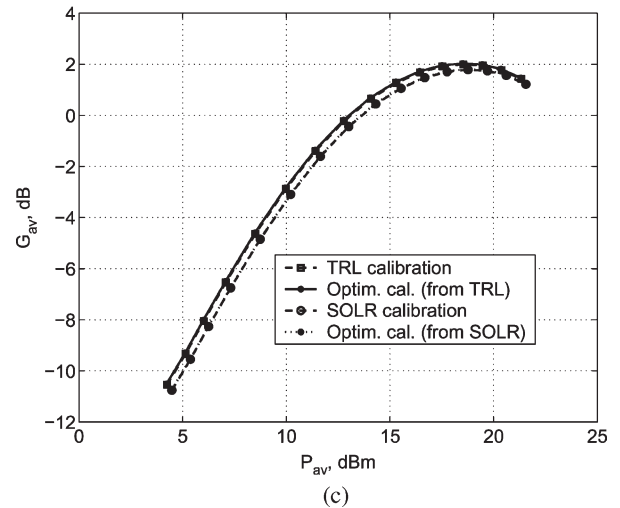
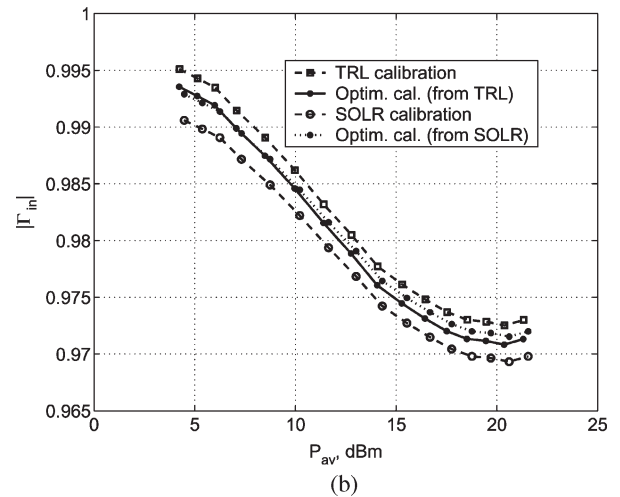
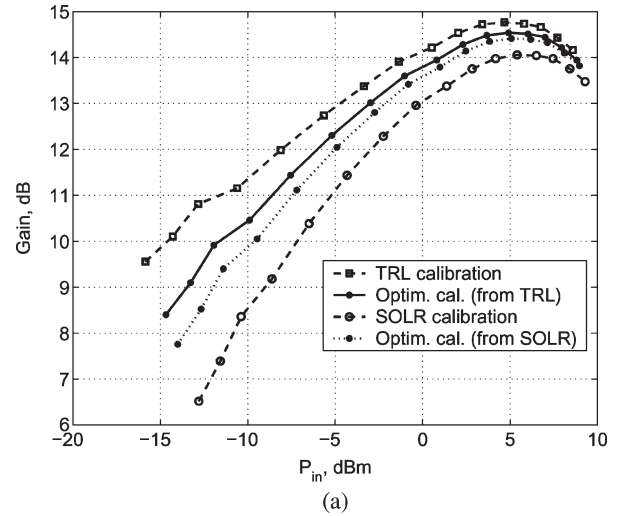

Fig. 7. Power sweeps of a GaN device in class B, on  $\Gamma_L = 0.60^\circ$ , for (a) gain, (b)  $|\Gamma_{in}|$ , and (c) available gain. Same raw data are corrected with TRL (squares), RSOL (circles), and optimized (dots) calsets. The optimized calsets are obtained from two different starting points, namely TRL calset (continuous line) and RSOL calset (dotted line).

(dots) and with the optimized error coefficients (squares). The dispersion of gain values with respect to 0 dB is evident, especially for  $|\Gamma_L| > 0.8$ . As  $|\Gamma_L|$  increases, the improving effect of the optimized calibration becomes more evident. In

this case, we can conclude that the calset optimization algorithm reduces the gain spreading from  $-0.1$  to  $0.2$  dB to  $-0.1$  to  $0.02$  dB.

The comparison between SOLR method and optimized calset is shown in Fig. 6. SOLR calibration has a higher  $\mathcal{F}$  factor than TRL calibration; thus, the optimization algorithm is more effective in this case. The optimized calset reduces the gain spreading from  $-0.27$  to  $1.4$  dB to  $-1.2$  to  $0.02$  dB, as shown in Fig. 6.

As a final verification, an extensive load-pull characterization has been performed on a  $2 \times 50$   $\mu\text{m}$  gate periphery GaN high-electron mobility transistor device, which is biased in class A and class B ( $V_{DS} = 15$  V, and  $V_{GS} = -2.6$  and  $-5.5$  V, respectively).

As expected, operating gain  $G$  shows the most sensible change when the optimized correction is applied. In Fig. 7, a power sweep in class B is shown. It is performed on  $\Gamma_L = 0.64 - 14^\circ$ , which is the optimum for output power at 2-dB compression. Curves are obtained by correcting the same raw data with TRL (squares), SOLR (circles), and optimized calsets (dots). The two different optimized calsets are obtained, taking the TRL calset (continuous line) and the SOLR calset (dotted line), respectively, as starting points for the optimization.

We notice impressive differences between TRL and SOLR measurements, especially for low input power. The problem is due to a very high  $\Gamma_{in}$  for low power, which is affected by great uncertainty. Both the  $P_{in}$  and, consequently, the operating gain are affected by an incorrect  $\Gamma_{in}$  measurement.  $|\Gamma_{in}|$  is shown in Fig. 7(b): It varies between 0.99 and 0.97 as the available power  $P_{av}$  increases, explaining the behavior in Fig. 7(a). Optimized calibration results fall between the TRL and SOLR results and, reasonably, are more reliable.

Finally, in Fig. 7(c), the available gain ( $P_{out}/P_{av}$ ) is plotted versus available power  $P_{av}$ . In this way, we eliminate the effect of incorrect  $\Gamma_{in}$  measurement, and all calibrations give coherent results, as expected. Thus, the effect of the optimized calibration has been a more reliable  $\Gamma_{in}$  measurement in a very critical case.

## V. CONCLUSION

In this paper, a novel method to improve the calibration of real-time load-pull systems has been presented. It exploits a thru standard characterization versus load reflection coefficient. On the basis of measurement and simulation analysis, the optimization algorithm that is implemented proves to be effective in reducing the residual calibration uncertainty, especially for high reflection coefficients.

## REFERENCES

- [1] G. Heiter, "Characterization of nonlinearities in microwave devices and systems," *IEEE Trans. Microw. Theory Tech.*, vol. MTT-21, no. 2, pp. 797–805, Dec. 1973.
- [2] J. Cusack, S. Perlow, and B. Perlman, "Automatic load contour mapping for microwave power transistors," *IEEE Trans. Microw. Theory Tech.*, vol. MTT-22, no. 12, pp. 1146–1152, Dec. 1974.
- [3] F. Sechi, R. Paglione, B. Perlman, and J. Brown, "A computer controlled microwave tuner for automated load pull," *RCA Rev.*, vol. 44, no. 4, pp. 566–583, Dec. 1983.
- [4] A. Ferrero and U. Pisani, "An improved calibration technique for on-wafer large-signal transistor characterization," *IEEE Trans. Instrum. Meas.*, vol. 47, no. 2, pp. 360–364, Apr. 1993.

- [5] I. Hecht, "Improved error-correction technique for large-signal load-pull measurements," *IEEE Trans. Microw. Theory Tech.*, vol. MTT-35, no. 11, pp. 1060–1062, Nov. 1987.
- [6] A. Ferrero, V. Teppati, and A. Carullo, "Accuracy evaluation of on-wafer load-pull measurements," *IEEE Trans. Microw. Theory Tech.*, vol. 49, no. 1, pp. 39–43, Jan. 2001.
- [7] A. Ferrero and V. Teppati, "Experimental comparison of active and passive load-pull measurement technologies," in *Proc. 30th Eur. Microw. Conf.*, 2000, pp. 1–4.
- [8] C. Tsironis, *Accuracy and Verification of Load Pull Measurements*, 1994, St. Laurent, QC, Canada: Focus Microwaves Inc. Application Note No. 18.



**Valeria Teppati** (S'01–M'03) was born in Torino, Italy, on October 20, 1974. She received the degree in electronic engineering and the Ph.D. degree in electronic instrumentation from the Politecnico di Torino in 1999 and 2003, respectively.

Since 2003, she has been a Research and Teaching Assistant with the Dipartimento di Elettronica, Politecnico di Torino. Her research interests and activities include microwave device design, linear and nonlinear measurement design, calibration, and uncertainty.



**Andrea Ferrero** (S'87–M'92) was born in Novara, Italy, on November 7, 1962. He received the degree in electronic engineering and the Ph.D. degree in electronics from the Politecnico di Torino, Torino, Italy, in 1987 and 1992, respectively.

In 1988, he joined Aeritalia Company as a Microwave Consultant. During 1991, he joined the Microwave Technology Division, Hewlett Packard, Santa Rosa, CA, as a Summer Student. In 1995, he was with the Department of Electrical Engineering, Ecole Polytechnique de Montréal, Montréal, QC, Canada, as a Guest Researcher. In 1998 and 2006, respectively, he became an Associate and Full Professor in electronic measurements with the Dipartimento di Elettronica, Politecnico di Torino, where his main research activities are in the area of microwave measurement techniques, calibration, and modeling.



**Daniela Parena** was born in Chieri, Torino, Italy, on January 9, 1966. She received the degree in physics from the University of Torino in 1992. Since 2004, she has been working toward the Ph.D. degree in metrology at the Dipartimento di Elettronica, Politecnico di Torino.

From 1992 to 1996, she was with the Italian National Institute for Nuclear Physics (INFN), Torino, and the European Council for Nuclear Research (CERN), Geneva, Switzerland, under a fellowship. From 1996 to 2003, she was a Technician in a railway manufacturing company. Her research interests and activities include mainly linear and nonlinear measurements with microwave devices, VNA calibration techniques, and measurement uncertainty analysis.



**Umberto Pisani** received the Dr. Ing. degree in electronic engineering from the Politecnico di Torino, Torino, Italy, in 1967.

In 1968, he joined the Dipartimento di Elettronica, Politecnico di Torino, as an Assistant Professor, where he became an Associate Professor in 1982 and a Full Professor in electronics in 1989. He has conducted research in the area of active and passive device characterization and modeling, mainly for use with microwaves. In this field, he contributed in the development of experimental techniques, for the testing of bipolar transistors and MESFETs, in linear and large-signal regimes, and in the design of solid-state broad-band amplifiers and power stages for satellite applications.