

Multiport vector network analyzer calibration: a general formulation

Original

Multiport vector network analyzer calibration: a general formulation / Ferrero, ANDREA PIERENRICO; F., Sanpietro; U., Pisani. - In: IEEE TRANSACTIONS ON MICROWAVE THEORY AND TECHNIQUES. - ISSN 0018-9480. - 42:(1994), pp. 2455-2461.

Availability:

This version is available at: 11583/1400359 since:

Publisher:

IEEE

Published

DOI:

Terms of use:

This article is made available under terms and conditions as specified in the corresponding bibliographic description in the repository

Publisher copyright

(Article begins on next page)

Multiport Vector Network Analyzer Calibration: A General Formulation

Andrea Ferrero, *Member, IEEE*, Fernando Sanpietro, and Umberto Pisani

Abstract—An overall calibration theory for Multiport Network Analyzers (MNWA) is presented. A general algorithm is developed to exploit the redundancy inherent in MNWA self-calibration. Linear dependency conditions given by using one-port or two-port standards to calibrate a MNWA are analyzed, by deriving novel criteria for multiport self-calibration. It is theoretically and experimentally demonstrated that an n -port test set can be calibrated by using only one two-port standard and one load. The excellent accuracy reached by means of this new theory opens new alternatives to a metrological qualification of MNWA for n -port device testing.

I. INTRODUCTION

MULTIPORT network analyzer calibration has been recently studied by several authors to extend usual calibration algorithms, developed for 2-port network analyzer to n -port port test set [1], [2]. References [3], [4] suggested extension of the through-short-delay (TSD) technique to a general n -port, taking into account the errors due to signal leakage between port pairs. The test set calibration was carried out by means of three n -port standards. Another technique [5] is based on several partial two-port measurements properly combined to account for the mismatch errors of the other $n-2$ ports; this technique is practically unrealizable when devices with more than three ports are considered due to the large amount of 2-port measurements to be performed.

More recently, the authors and others introduced a new solution for a true multiport test set hardware and a calibration technique which used commercially available one or two-port standards [1]. In that paper, an iterative procedure for the standard connections was used but the potential to reduce the number of measurements by redundancy in an n -port system was not considered.

A novel formal approach to the MNWA calibration problem, which exploits the self-calibration capabilities of the test set was introduced by the authors earlier [6], where an inclusive analysis was carried out and the case of a 3-port network analyzer was presented.

Here we generalize the concept outlined there by introducing a general equation which links the scattering parameters of standards or unknown devices and their corresponding measurements to a suitable set of error coefficients.

Manuscript received April 1, 1994; revised July 11, 1994. This work was supported in part by the National Research Council of Italy (CNR) and in part by Hewlett-Packard of Italy.

The authors are with Department of Electronics, Politecnico di Torino, Corso Duca degli Abruzzi 24, 10129 Torino, Italy.
IEEE Log Number 9405432

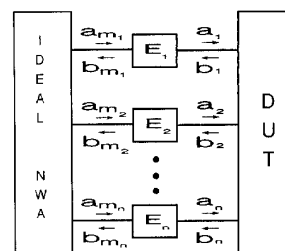

Fig. 1. Generalized model of a multiport test set.

The calibration problem is unified from a mathematical point of view and it can be treated by solving a linear system built in a straightforward manner from measurements. Any combination of standards can be used, provided that the equations generated by their measurements produce enough linear independent equations to evaluate all the error coefficients.

This paper presents the theoretical criteria needed to combine enough standard measurements into a consistent linear system and consequently to define a consistent calibration procedure. The user is free to best fit the particular application, taking advantage of the excess of measurement achievable by manifold test ports.

The paper is organized as follows: a general de-embedding formula for an n -port network analyzer is derived in Section II; a general equation to solve the calibration problem is given in Section III; an analysis of linear independence conditions which are imposed by one or two-port standards used to calibrate a MNWA is presented in Section IV; and finally, some experimental results are presented in Section V.

II. MULTIPORT DE-EMBEDDING FORMULATION

An actual MNWA, after a proper switch correction procedure detailed in [1], can be seen as an error-free NWA which measures the raw scattering matrix \mathbf{S}_m and a set of n 2-port networks, i.e., the error boxes, which tie the ideal NWA to the DUT as shown in Fig. 1.

Each error box is defined by a pseudo-scattering matrix \mathbf{E}_i , where $i = 1, \dots, n$:

$$\mathbf{E}_i = \begin{bmatrix} e_i^{00} & e_i^{01} \\ e_i^{10} & e_i^{11} \end{bmatrix}. \quad (1)$$

In a multiport system the error coefficients become elements of four diagonal matrices Γ_{ij} :

$$\begin{aligned} \bullet \Gamma_{00} &= \text{diag}(e_1^{00}, \dots, e_i^{00}, \dots, e_n^{00}) \\ \bullet \Gamma_{01} &= \text{diag}(e_1^{01}, \dots, e_i^{01}, \dots, e_n^{01}) \\ \bullet \Gamma_{10} &= \text{diag}(e_1^{10}, \dots, e_i^{10}, \dots, e_n^{10}) \\ \bullet \Gamma_{11} &= \text{diag}(e_1^{11}, \dots, e_i^{11}, \dots, e_n^{11}). \end{aligned} \quad (2)$$

After some matrix algebra, detailed in [1], it results

$$\mathbf{S}_m = \Gamma_{00} + \Gamma_{01}[\mathbf{I} - \mathbf{S}\Gamma_{11}]^{-1}\mathbf{S}\Gamma_{10} \quad (3)$$

where \mathbf{I} is the n -dimensional unitary matrix and \mathbf{S} is the scattering matrix of the multiport device under test.

Equation (3) can be written in the form

$$\Gamma_{01}^{-1}(\mathbf{S}_m - \Gamma_{00})\Gamma_{10}^{-1} = (\mathbf{I} - \mathbf{S}\Gamma_{11})^{-1}\mathbf{S} \quad (4)$$

or

$$\begin{aligned} \Gamma_{01}^{-1}\mathbf{S}_m\Gamma_{10}^{-1} - \mathbf{S}\Gamma_{11}\Gamma_{01}^{-1}\mathbf{S}_m\Gamma_{10}^{-1} - \Gamma_{01}^{-1}\Gamma_{00}\Gamma_{10}^{-1} \\ + \mathbf{S}\Gamma_{11}\Gamma_{01}^{-1}\Gamma_{00}\Gamma_{10}^{-1} = \mathbf{S}. \end{aligned} \quad (5)$$

By introducing

$$\Delta = \Gamma_{00}\Gamma_{11} - \Gamma_{01}\Gamma_{10} \quad (6)$$

we note that Δ is also a diagonal matrix; in the following each element of its diagonal is annotated as Δ_i ($i = 1 \dots n$).

By rearranging (5) we obtain

$$\begin{aligned} \Gamma_{01}^{-1}\mathbf{S}_m\Gamma_{10}^{-1} - \mathbf{S}\Gamma_{11}\Gamma_{01}^{-1}\mathbf{S}_m\Gamma_{10}^{-1} - \Gamma_{01}^{-1}\Gamma_{00}\Gamma_{10}^{-1} \\ + \mathbf{S}\Delta\Gamma_{01}^{-1}\Gamma_{10}^{-1} = 0. \end{aligned} \quad (7)$$

Define the diagonal matrix \mathbf{K} as

$$\mathbf{K} = e_1^{01}\Gamma_{01}^{-1}. \quad (8)$$

Equation (7) becomes

$$\mathbf{K}\Gamma_{00} + \mathbf{S}\mathbf{K}\Gamma_{11}\mathbf{S}_m - \mathbf{S}\mathbf{K}\Delta - \mathbf{K}\mathbf{S}_m = 0. \quad (9)$$

The de-embedding equation in agreement with this notation is

$$\mathbf{S} = \mathbf{K}(\mathbf{S}_m - \Gamma_{00})(\Gamma_{11}\mathbf{S}_m - \Delta)^{-1}\mathbf{K}^{-1}. \quad (10)$$

The goal of a selected calibration procedure is to compute \mathbf{K} , Γ_{00} , Γ_{11} , and Δ , from a proper set of standard network measurements.

III. GENERAL THEORY OF CALIBRATION

Matrix equation (9), can be also seen as n^2 equations of the form

$$\begin{aligned} \delta_{ij}k_i e_i^{00} + \sum_{q=1}^n S_{iq}k_q e_q^{11} S_{mqj} - S_{ij}k_j \Delta_j - k_i S_{mij} = 0 \\ (i = 1, \dots, n) \\ (j = 1, \dots, n) \end{aligned} \quad (11)$$

where δ_{ij} is the kronecker symbol ($\delta_{ij} = 1$ if $i = j$ otherwise $\delta_{ij} = 0$) and $k_i = (K)_{ii} = e_1^{01}/e_i^{01}$ ($i = 1, \dots, n$). Equation (11) is a general relationship which links error coefficients, standard or DUT parameters S_{ij} and their corresponding measurements S_{mij} . This equation can be applied to each

standard measurement regardless the number of standards or their connections. It is also linear in a proper set of error coefficients.

Since $k_1 \stackrel{\text{def}}{=} 1$, there are $(4n-1)$ global unknowns and these can be rearranged in a vector \mathbf{u} as follows

$$\begin{aligned} \bullet u_i &= k_i e_i^{00} (i = 1, \dots, n) \\ \bullet u_i &= k_{i-n} e_{i-n}^{11} (i = n+1, \dots, 2n) \\ \bullet u_i &= k_{i-2n} \Delta_{i-2n} (i = 2n+1, \dots, 3n) \\ \bullet u_i &= k_{i-3n+1} (i = 3n+1, \dots, 4n-1). \end{aligned} \quad (12)$$

A stack of $4n-1$ linear independent equations like (11) can be easily arranged to give a linear system

$$\mathbf{N}\mathbf{u} = \mathbf{g} \quad (13)$$

which defines the entire calibration problem.

Vector \mathbf{g} contains only elements like S_{mij} or zeros while the matrix \mathbf{N} contains also the standards S_{ij} parameters. The way to build the matrix \mathbf{N} can be generally unlimited as long as such standard device combinations provide $(4n-1)$ linear independent equations. The criteria which give independent equations are analyzed in Section IV.

By using a proper set of standards, \mathbf{N} is a full rank matrix and the solution of (13) is straightforwardly obtained as

$$\mathbf{u} = \mathbf{N}^{-1}\mathbf{g}. \quad (14)$$

Once \mathbf{u} is known the error coefficient matrices Γ_{00} , Γ_{11} , and \mathbf{K} follow from (12) as

$$\begin{aligned} \bullet \Gamma_{00} &= \text{diag}(u_1, u_2/u_{3n+1}, \dots, u_i/u_{3n+i-1}, \dots) \\ & \quad (i = 2, \dots, n) \\ \bullet \Gamma_{11} &= \text{diag}(u_{n+1}, u_{n+2}/u_{3n+1}, \dots, u_{n+i}/u_{3n+i-1}, \dots) \\ & \quad (i = 2, \dots, n) \\ \bullet \Delta &= \text{diag}(u_{2n+1}, u_{2n+2}/u_{3n+1}, \dots, u_{2n+i}/u_{3n+i-1}, \dots) \\ & \quad (i = 2, \dots, n) \\ \bullet \mathbf{K} &= \text{diag}(1, u_{3n+1}, u_{3n+2}, \dots, u_{3n+i}, \dots) (i = 1, \dots, n). \end{aligned} \quad (15)$$

This new approach frees the user to combine whichever standard connection procedure is preferred. This overcomes any limits standard set definition allowing the user fit the device under test port characteristic to the test port geometry.

As example we consider the case of a two port test set where $4 * 2 - 1 = 7$ error coefficients are required, if the following standards combination is used:

- 1) a *thru*, which gives \mathbf{S}_m^T , i.e., 4 equations,
- 2) a perfectly matched load connected at port 1, which provides Γ_{m1}^L , i.e., 1 equation,
- 3) a perfectly matched load connected at port 2, which provides Γ_{m2}^L , i.e., 1 equation,
- 4) an ideal short connected at port 1, which provides Γ_m^S , i.e., 1 equation.

This results in seven equations like (11) which establish a calibration system (13):

$$\begin{bmatrix} 1 & 0 & 0 & S_{m21}^T & 0 & 0 & 0 \\ 0 & 0 & 0 & S_{m22}^T & 0 & -1 & 0 \\ 0 & 0 & S_{m11}^T & 0 & -1 & 0 & -S_{m21}^T \\ 0 & 1 & S_{m12}^T & 0 & 0 & 0 & -S_{m22}^T \\ 1 & 0 & 0 & 0 & 0 & 0 & 0 \\ 0 & 1 & 0 & 0 & 0 & 0 & -\Gamma_{m2}^L \\ 1 & 0 & -\Gamma_m^S & 0 & 1 & 0 & 0 \end{bmatrix} \times \begin{bmatrix} e_1^{00} \\ k_2 e_2^{00} \\ e_1^{11} \\ k_2 e_2^{11} \\ \Delta_1 \\ k_2 \Delta_2 \\ k_2 \end{bmatrix} = \begin{bmatrix} S_{m11}^T \\ S_{m12}^T \\ 0 \\ 0 \\ \Gamma_{m1}^L \\ 0 \\ \Gamma_m^S \end{bmatrix}. \quad (16)$$

The linear system defined by (16) is given as an example case of the proposed general formulation and for two-port NWA, is similar to the solution of [7].

A detailed analysis is required to build a set of linear independent equations and it is presented in the next section.

IV. CONDITIONS FOR CONSISTENT CALIBRATION

The choice of standards and the relative connections required to calibrate a MNWA ($n \geq 3$) is considered next. We limit our considerations to standards with one or two-ports, since they are commercially available.

The task is to determine: **how many independent equations are provided by one or two-port standards, when they are connected in all the possible ways to a MNWA?**

A. One-Port Standard Combinations

We consider different one-port standards which are alternately connected to each test port. Each one-port standard connection provides a single independent equation, but a maximum of $3n$ linear independent equations can be obtained from one port measurements regardless the number of connections or standards used.

Since the error coefficients $k_i = e_1^{01}/e_k^{01}$ are functions of different error boxes and in general for each error box $e_i^{01} \neq e_i^{10}$, it is physically impossible to obtain useful informations on k_i coefficients only by means of reflection measurements. This statement can be easily proven by taking equation (11) in a general one port case, i.e., a one port standard defines by its reflection coefficient Γ connected at port p :

$$k_p e_p^{00} + \Gamma k_p e_p^{11} \Gamma_m - \Gamma k_p \Delta_p - k_p \Gamma_m = 0 \quad (17)$$

where the term k_p can be immediately simplified. Since $(n-1)$ are the k_i coefficients among $(4n-1)$ error coefficients, **then: only $3n$ linear independent equations can be provided by using one-port standards alone.**

B. Combinations of One-Port and Two-Port Standards

When a combination of one-port and two-port standards is used, some additional constraints apply to the problem solution.

In general two practical common situations occur:

- 1) we do not have connector gender problems thus each port can be connected to all the others by the same two-port standard.
- 2) we do have connection gender problems and the standard cannot be reversed nor used to connect all the port pairs.

In the following we will prove that a single one-port standard joined with a two-port one is enough to solve the calibration for case 1) but at least two one-port standards joined with a two-port one are necessary to solve the problem for case 2).

If gender problems are present (case 2) there are at least $(n-1)$ possible connections which give $4n-4$ equations. The following general criteria will be proven:

CRITERIA A: If $(4n-4)$ linear independent equations are given by a single two-port standard at least two different one-port standards properly connected, are required to give the remaining three equations and solve the calibration problem.

We first reduce the problem to the 3-port case. An uncalibrated 3-port MNWA is the first case where a single two-port standard can provide more equations than error coefficients.¹ Consider a 3-port system already fully calibrated: if we add one more port, the dimension of the subspace defined by the columns of matrix \mathbf{N} in (13) will be $(12-1+4)$, since 4 more unknowns have to be added. The corresponding dimension of the subspace defined by the rows of \mathbf{N} , i.e., the whole number of independent equations, will also increase by 4. So while the test-set complexity increases by one port, the contribution of whichever two-port standard can not be more than 4 independent equations, despite the number of its possible connections. Furthermore the four independent equations are immediately obtained by a single connection of a two-port standard between one of the 3-port and the added one. This procedure stands up to n ports and the following analysis of 3-port redundancy yields to general conclusions because the error coefficients of each extra port are computed by a single two-port standard connection.

To prove criteria A we label three generic ports i, j, k and assume the following combination:

- a two-port standard connected first between ports i and j and then between ports i and k ($4n-4=8$ equations).
- a one-port standard connected in turn to ports j and k (2 equations),
- a different one-port standard connected to port i (1 equation).

The number of independent equations provided by this set of 11 measurements is 10 rather than 11, proven as follows.

¹In a 3-port network analyzer the error coefficients are $3*4-1=11$ while all the possible connections of a 2-port standard network (i.e., 1-2, 1-3, 2-3 and the reversed 2-1, 3-1, 3-2) provide 24 measurements.

Define a two-port standard by its scattering matrix:

$$\mathbf{S} = \begin{bmatrix} S_{11} & S_{12} \\ S_{21} & S_{22} \end{bmatrix}. \quad (18)$$

Without loss of generality we define one of the three port to port 1, such that $k_1 \stackrel{\text{def}}{=} 1$ and the other as ports 2 and 3.

Once the two-port standard is connected between port 1 and port 2 four equations result like (11) which can be arranged as follows:

$$\underbrace{\begin{bmatrix} S_{11}S_{m11}^A & -S_{11} & 1 & S_{12}S_{m21}^A & 0 & 0 & 0 \\ S_{21}S_{m11}^A & -S_{21} & 0 & S_{22}S_{m21}^A & 0 & 0 & -S_{m21}^A \\ S_{11}S_{m12}^A & 0 & 0 & S_{12}S_{m22}^A & -S_{12} & 0 & 0 \\ S_{21}S_{m12}^A & 0 & 0 & S_{22}S_{m22}^A & -S_{22} & 1 & -S_{m22}^A \end{bmatrix}}_{\mathbf{A}_{11} \quad \mathbf{A}_{12}} \times \begin{bmatrix} e_1^{11} \\ \Delta_1 \\ e_1^{00} \\ k_2 e_2^{11} \\ k_2 \Delta_2 \\ k_2 e_2^{00} \\ k_2 \end{bmatrix} = \begin{bmatrix} S_{m11}^A \\ 0 \\ S_{m12}^A \\ 0 \end{bmatrix}. \quad (19)$$

We define

$$\mathbf{e}_1 = [e_1^{11} \quad \Delta_1 \quad e_1^{00}]^T \quad (20)$$

$$\mathbf{e}_2 = [k_2 e_2^{11} \quad k_2 \Delta_2 \quad k_2 e_2^{00} \quad k_2]^T \quad (21)$$

$$\mathbf{t}_A = [S_{m11}^A \quad 0 \quad S_{m12}^A \quad 0]^T. \quad (22)$$

Equation (19) is now written in matrix form as

$$[\mathbf{A}_{11} \mathbf{A}_{12}] \begin{bmatrix} \mathbf{e}_1 \\ \mathbf{e}_2 \end{bmatrix} = \mathbf{t}_A \quad (23)$$

$$\mathbf{A}_{11} \mathbf{e}_1 + \mathbf{A}_{12} \mathbf{e}_2 = \mathbf{t}_A. \quad (24)$$

Connecting the same network between port 1 and port 3, we have

$$\underbrace{\begin{bmatrix} S_{11}S_{m11}^B & -S_{11} & 1 & S_{12}S_{m31}^B & 0 & 0 & 0 \\ S_{21}S_{m11}^B & -S_{21} & 0 & S_{22}S_{m31}^B & 0 & 0 & -S_{m31}^B \\ S_{11}S_{m13}^B & 0 & 0 & S_{12}S_{m33}^B & -S_{12} & 0 & 0 \\ S_{21}S_{m13}^B & 0 & 0 & S_{22}S_{m33}^B & -S_{22} & 1 & -S_{m33}^B \end{bmatrix}}_{\mathbf{B}_{11} \quad \mathbf{B}_{12}} \times \begin{bmatrix} e_1^{11} \\ \Delta_1 \\ e_1^{00} \\ k_3 e_3^{11} \\ k_3 \Delta_3 \\ k_3 e_3^{00} \\ k_3 \end{bmatrix} = \begin{bmatrix} S_{m11}^B \\ 0 \\ S_{m13}^B \\ 0 \end{bmatrix}. \quad (25)$$

Let

$$\mathbf{e}_3 = [k_3 e_3^{11} \quad k_3 \Delta_3 \quad k_3 e_3^{00} \quad k_3]^T \quad (26)$$

$$\mathbf{t}_B = [S_{m11}^B \quad 0 \quad S_{m13}^B \quad 0]^T. \quad (27)$$

Equation (25) becomes

$$\mathbf{B}_{11} \mathbf{e}_1 + \mathbf{B}_{12} \mathbf{e}_3 = \mathbf{t}_B. \quad (28)$$

Connecting a load Γ at port 2 it results

$$\mathbf{g}_2^T \mathbf{e}_2 = 0 \quad (29)$$

where

$$\mathbf{g}_2^T = [\Gamma \Gamma_{m2} \quad -\Gamma \quad 1 \quad -\Gamma_{m2}]. \quad (30)$$

Once the same load Γ is connected at port 3 an equation similar to (29) is obtained

$$\mathbf{g}_3^T \mathbf{e}_3 = 0 \quad (31)$$

where

$$\mathbf{g}_3^T = [\Gamma \Gamma_{m3} \quad -\Gamma \quad 1 \quad -\Gamma_{m3}]. \quad (32)$$

If a different load Γ_1 is connected at port 1, the following equation can be written:

$$\mathbf{g}_1^T \mathbf{e}_1 = \Gamma_{m1} \quad (33)$$

where

$$\mathbf{g}_1^T = [\Gamma_1 \Gamma_{m1} \quad -\Gamma_1 \quad 1]. \quad (34)$$

Combining (29) with (24) and (28) with (31) we get

$$\begin{cases} \mathbf{g}_1^T \mathbf{e}_1 = \Gamma_{m1} \\ \mathbf{g}_2^T \mathbf{A}_{12}^{-1} \mathbf{A}_{11} \mathbf{e}_1 = \mathbf{g}_2^T \mathbf{A}_{12}^{-1} \mathbf{t}_A \\ \mathbf{g}_3^T \mathbf{B}_{12}^{-1} \mathbf{B}_{11} \mathbf{e}_1 = \mathbf{g}_3^T \mathbf{B}_{12}^{-1} \mathbf{t}_B. \end{cases} \quad (35)$$

Equation (35) forms the linear system

$$\begin{bmatrix} \Gamma_1 \Gamma_{m1} & -\Gamma_1 & 1 \\ a_A b_A & -a_A c_A & d_A c_A \\ a_B b_B & -a_B c_B & d_B c_B \end{bmatrix} \begin{bmatrix} e_1^{11} \\ \Delta_1 \\ e_1^{00} \end{bmatrix} = \begin{bmatrix} \Gamma_{m1} \\ d_A b_A \\ d_B b_B \end{bmatrix} \quad (36)$$

where the coefficients a_A , d_A , a_B and d_B are functions of the two-port network S_{ij} and of Γ . Since Γ is the same

$$\begin{aligned} a_A &= a_B = -\Gamma S_{11} + \Delta_S \\ d_A &= d_B = -\Gamma + S_{22} \end{aligned} \quad (37)$$

while b_A , b_B , c_A and c_B are obtained as follows:

$$\begin{aligned} b_A &= -\Gamma_{m2} S_{m11}^A + \Delta_m^A \\ b_B &= -\Gamma_{m3} S_{m11}^B + \Delta_m^B \\ c_A &= -\Gamma_{m2} + S_{m22}^A \\ c_B &= -\Gamma_{m3} + S_{m33}^B \end{aligned} \quad (38)$$

$$\Delta_S = S_{11} S_{22} - S_{21} S_{12}$$

$$\Delta_m^A = S_{m11}^A S_{m22}^A - S_{m21}^A S_{m12}^A$$

$$\Delta_m^B = S_{m11}^B S_{m33}^B - S_{m31}^B S_{m13}^B. \quad (39)$$

The solution of the (36) is

$$\begin{bmatrix} e_1^{11} \\ \Delta_1 \\ e_1^{00} \end{bmatrix} = \begin{bmatrix} \frac{d}{a} \\ \frac{d}{a} \Gamma_{m1} \\ \Gamma_{m1} \end{bmatrix} \quad (40)$$

which is physically inconsistent because it leads to

$$\Delta_1 = e_1^{11} e_1^{00}. \quad (41)$$

This contradictory solution is due to the conditions imposed by (37).

If we use two different one-port standards at ports 2 and 3: $a_A \neq a_B$ and $d_A \neq d_B$ thus the calibration is consistent. Since the structure of the first row of (36) is dissimilar from the other two, Γ_1 at port 1 does not affect the calibration consistence and in particular can be selected equal to one of the other two loads. In conclusion a single load is not enough to complete the calibration when a two-port standard gives only $4n - 4$ linear independent equations but also two loads have to be properly connected. Furthermore note that if the two-port standard has $S_{11} = S_{22} = 0$ and the two different Γ are an ideal open and an ideal short, the system (36) still leads to an inconsistent solution ($e_1^{11} = 1$).

If we do not have connector gender problems (case 1) we need to compute the maximum number of independent equations provided by using a two-port standard network alone. We let l the number of independent equations given by a single two-port standard connected in all the possible ways to a 3-port test-set, then in a n -port test-set, where the increased ports are $(n - 3)$, the whole number of independent equations will be $l + 4(n - 3)$. As already pointed out each added port means four independent equations.

The evaluation of l is cumbersome, and it is treated out in appendix A by using the new formulation adopted here. It results that $l = 10$. Thus the maximum number of independent equations given by all $\binom{n}{2}$ possible connections of a two-port standard to an n -port test-set ($n \geq 3$) will be $(4n - 2)$.

This result leads in straightforward manner to the conclusion that **CRITERIA B: the calibration of MNWA ($n \geq 3$) can not be carried out by a single two-port standard alone even if the number of measurements (i.e., equations) obtainable by its multiple connections $\binom{n}{2}$ is greater than the number of error coefficient $(4n - 1)$.**

Since we have $(4n - 2)$ linear independent equations, it is necessary to connect at least one more standard which gives an extra equation. Therefore the calibration of a MNWA, if no particular connections problems exist, can be solved by using only one two-port standard and one known load.

V. EXPERIMENTAL RESULTS

The experimental results were obtained on a 3-port test-set shown in Fig. 2, where the use of 7 mm connectors and flexible arms allows an easy connection between ports. This propitious circumstance allows the use of 3 *thrus* as two-port standards which provide 10 linear independent equations. An usual sliding load procedure applied to port 1 gives the directivity term E_D of the port 1 reflectometer [8], thus the remaining equation becomes

$$e_1^{00} = E_D \tag{42}$$

The calibration procedure is summarized as follows:

- 1) sliding load at port 1
- 2) thru between ports 1 and 2
- 3) thru between ports 1 and 3
- 4) thru between ports 2 and 3

Since three port standards are not available, the 3-port test set was verified by an accurate validation of coaxial 7 mm one and two-port standards.

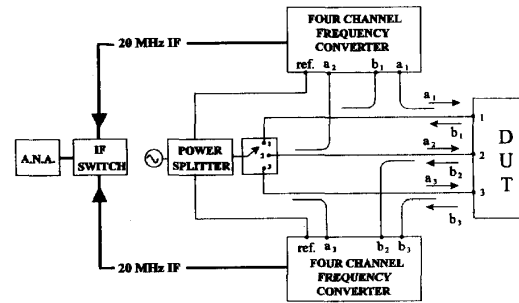

Fig. 2. Block diagram of a three-port S -parameter test-set.

Since each two port device can be connected in different ways, i.e., 1 - 2, 2 - 3, 1 - 3, to the multiport NWA every figure reports two traces which identify the whole spread of measurements obtained.

A comparison between a 20 cm airline measured by this new technique and a commercial 2-port NWA calibrated with a TRL algorithm is shown in Fig. 3. The slightly different plots for S_{11} could be ascribed to the small differences between the reference impedances of the TRL line and the sliding load.

Fig. 4 shows the transmission S -parameters of a 30 dB standard attenuator measured between ports 1 and 3.

VI. CONCLUSION

A general formulation of the MNWA calibration problem was presented, which provides a unified mathematical approach and defines some general criteria for calibration consistency. One application of the theory leads to definition of the minimum number of required standards and demonstrates the possibility of a n -port test-set calibration by means of only one two-port standard and one sliding-load. The accuracy reached by this calibration is verified by experimental results obtained on a 3-port test-set.

APPENDIX A

The number of independent equations l given by a single two-port standard in all possible connections at a 3-port MNWA is derived as follows.

Without loss of generality and for mathematical simplicity, a *thru* is used as two-port standard. Each *thru* connection (1 - 2, 1 - 3, 2 - 3) provides an equation like (24). In particular

$$A_{11}e_1 + A_{12}e_2 = t_A \tag{43}$$

$$B_{11}e_1 + B_{12}e_3 = t_B \tag{44}$$

$$C_{11}e_2 + C_{12}e_3 = 0. \tag{45}$$

By solving (43) and (44) for e_2 and e_3 and by substituting into (45) we have

$$(C_{11}A_{11}^{-1}A_{11} + C_{12}B_{12}^{-1}B_{11})e_1 = C_{11}A_{12}^{-1}t_B + C_{12}B_{12}^{-1}t_B. \tag{46}$$

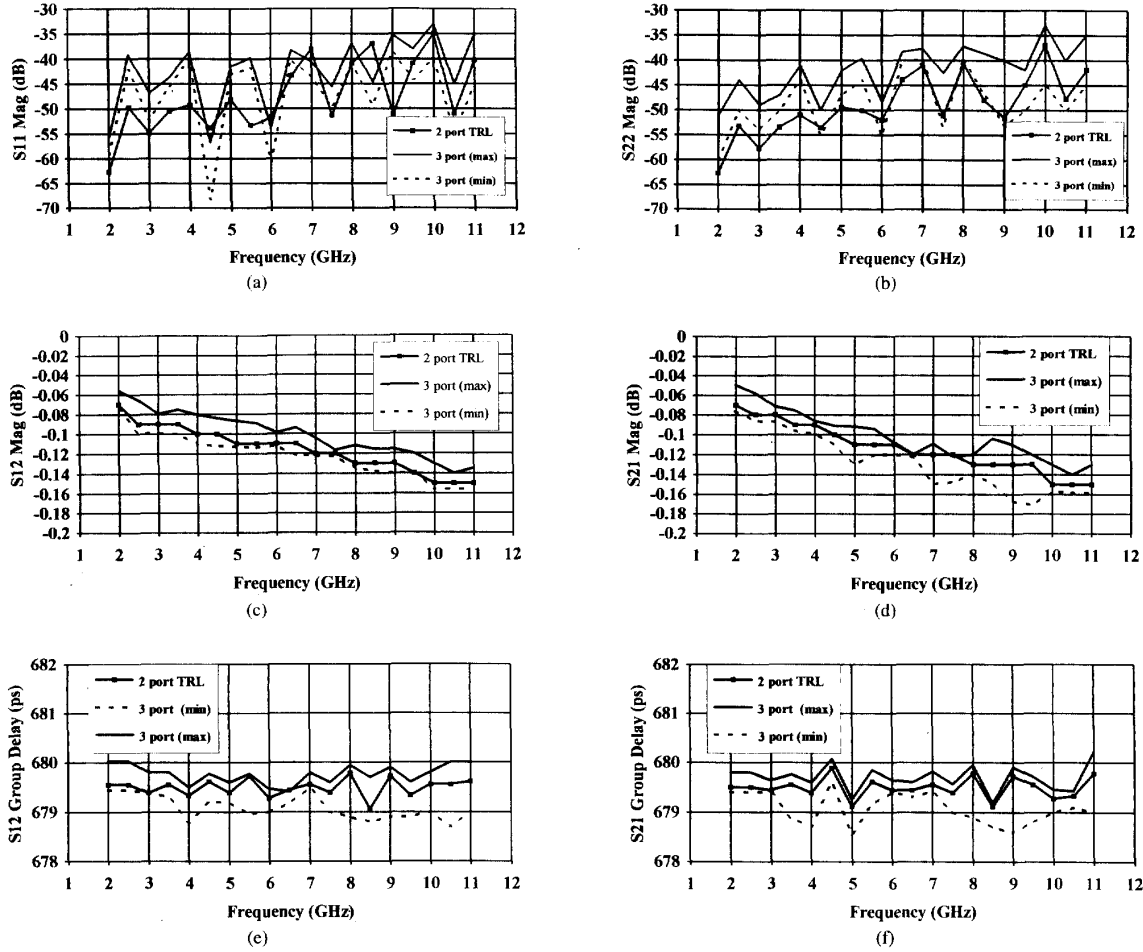

Fig. 3. (a), (b) Coaxial airline S -parameters (20.35 cm nominal length) (c), (d) Coaxial airline transmission S -parameters (20.35 cm nominal length) (e), (f) Coaxial airline group delay (20.35 cm nominal length).

Equation (46) is a linear system of four equations in three unknowns (e_1 elements) of the form

$$\underbrace{\begin{bmatrix} S_{m12}^A + S_{m11}^A a & -a & b \\ S_{m11}^B & -b & a \\ S_{m11}^A d & -d & c \\ S_{m12}^B + S_{m11}^B c & -c & d \end{bmatrix}}_{\mathbf{Z}} \begin{bmatrix} e_1^{11} \\ \Delta_1 \\ e_1^{00} \end{bmatrix} = \begin{bmatrix} S_{m11}^B b \\ S_{m12}^A + S_{m11}^A a \\ S_{m12}^B + S_{m11}^B c \\ S_{m11}^A d \end{bmatrix} \quad (47)$$

where

$$\begin{aligned} a &= (S_{m11}^C - S_{m22}^A) / S_{m21}^A \\ c &= (S_{m33}^C - S_{m33}^B) / S_{m31}^B \\ b &= S_{m32}^C / S_{m31}^B \\ d &= S_{m23}^C / S_{m21}^A \end{aligned} \quad (48)$$

If the rank of the coefficient matrix \mathbf{Z} was 3, then the overall number of independent equations l , will be $(3 + 8)$ because

4 independent equations are given from each matrix equation (43) and (44). But the solution of (47) is

$$\begin{bmatrix} e_1^{11} \\ \Delta_1 \\ e_1^{00} \end{bmatrix} = \begin{bmatrix} 1 \\ (aS_{m11}^A - bS_{m11}^B + S_{m12}^A) / (a - b) \\ (aS_{m11}^A - bS_{m11}^B + S_{m12}^A) / (a - b) \end{bmatrix} \quad (49)$$

This is an inconsistent solution since two error coefficients are equal and the source match of port 1 (i.e., e_1^{11}) is unitary, which is physically impossible. Thus the independent equations given by all connections must be less than 11. If we remove two equations from (47) and we add an equation from a measurement of a load Γ at port 1, like (33), the linear system so defined has a consistent solution. Thus the number of independent equations obtained from the three possible connections plus one more load measurement equation is 11. Hence

$$l = 10. \quad (50)$$

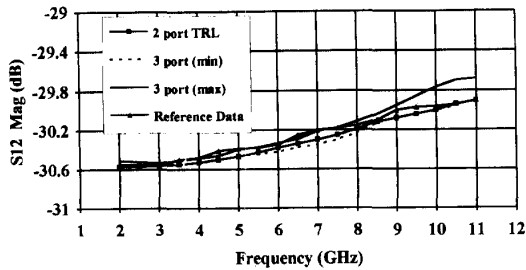

(a)

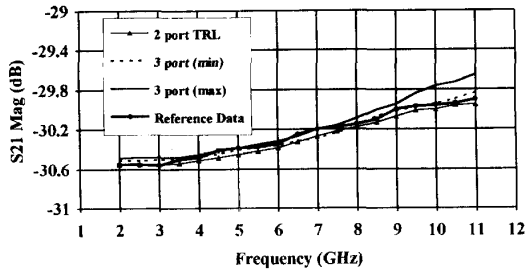

(b)

Fig. 4. 30 dB Coaxial attenuator transmission *S*-parameters.

ACKNOWLEDGMENT

The authors are indebted with K. Kerwin of HP Microwave Technology Division for helpful discussions and interesting suggestions.

REFERENCES

[1] A. Ferrero, U. Pisani, and K. J. Kerwin, "A new implementation of a multiport automatic network analyzer," *IEEE Trans. Microwave Theory Tech.*, vol. 40, pp. 2078-2085, Nov. 1992.
 [2] A. Ferrero and U. Pisani, "Three port network analyzer: an original implementation with a simplified calibration procedure," *1992 Asia-Pac. Microwave Conf.*, Adelaide, Australia, Aug. 11-13, 1992, pp. 915-918.
 [3] R. A. Speciale, "A Generalization of the TSD network-analyzer calibration procedure, covering *n*-port scattering-parameter measurements, affected by leakage errors," *IEEE Trans. Microwave Theory Tech.*, vol. MTT-25, pp. 1100-1115, Dec. 1977.
 [4] ———, "Multiport network analyzers: Meeting the design need," *MSN*, June 1980, pp. 67-89.
 [5] J. C. Tippet and R. A. Speciale, "A rigorous technique for measuring the scattering matrix of a multiport device with a 2-port network analyzer,"

IEEE Trans. Microwave Theory Tech., vol. MTT-30, pp. 661-665, May 1982.
 [6] A. Ferrero, F. Sanpietro, and U. Pisani, "Accurate coaxial standard verification by multiport vector network analyzer," *1994 MTT-S Dig.*, San Diego, CA, pp. 1365-1368, 1994.
 [7] K. I. Silvonen, "A general approach to network analyzer calibration," *IEEE Trans. Microwave Theory Tech.*, vol. 40, pp. 754-759, Apr. 1992.
 [8] *HP 8510B Reference Manual*, Santa Rosa CA, 1985.
 [9] G. H. Golub and C. F. van Loan, *Matrix Computations*. Baltimore, MD: Johns Hopkins University Press, 1983.
 [10] G. F. Engen and C. A. Hoer, "Thru-reflect-line: An Improved technique for calibrating the dual six-port automatic network analyzer," *IEEE Trans. Microwave Theory Tech.*, Vol. MTT-27, pp. 987-993, Dec. 1979.

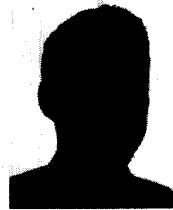

Andrea Ferrero (S'86-M'88) was born in Novara, Italy, in 1962. He received the electronic engineering degree in 1987 and the Ph.D. degree in electronics in 1992, both from the Politecnico di Torino.

In 1988, he joined the Aeritalia company as a microwave consultant. In 1991, he joined the Microwave Technology Division, Hewlett-Packard, Santa Rosa, as a summer student. Currently, he is a Researcher at the Politecnico di Torino, where his main research activities are in the area of microwave measurement techniques, calibration and modeling.

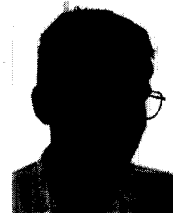

Ferdinando Sanpietro was born in Torino, Italy, in 1961. He received the electronic engineering degree in 1989 from the Politecnico di Torino. Currently, he is pursuing the Ph.D. degree in electronic engineering at the same university.

In 1992, he joined the Microwave System Division, Hewlett Packard in Santa Rosa. His research interests include microwave device modeling, measurement techniques and calibration.



Umberto Pisani was born in Sora, Italy, in 1943. He received the electronic degree from Politecnico di Torino in 1967.

In 1982, he became Associate Professor, and in 1989 Full Professor in Electronics. He has conducted research in the area of active and passive device characterization and modeling, mainly of microwaves. He is presently interested in the MMIC device on-wafer characterization and measurements.