

Enabling Coherence Between Energy Policies and SDGs Through Open Energy Models: The TEMOA-Italy Example

Original

Enabling Coherence Between Energy Policies and SDGs Through Open Energy Models: The TEMOA-Italy Example / Nicoli, Matteo; Alfano, Maria Elena; Amir Kavei, Farzaneh; Balbo, Alessandro; Colucci, Gianvito; Lerede, Daniele; Mosso, Daniele; Savoldi, Laura - In: Aligning the Energy Transition with the Sustainable Development Goals / Labriet M., Espegren K., Giannakidis G., Ó Gallachóir B.. - ELETTRONICO. - [s.l.] : Springer, 2024. - ISBN 978-3-031-58897-6. - pp. 97-118 [10.1007/978-3-031-58897-6_5]

Availability:

This version is available at: 11583/2989457 since: 2024-06-15T13:24:37Z

Publisher:

Springer

Published

DOI:10.1007/978-3-031-58897-6_5

Terms of use:

This article is made available under terms and conditions as specified in the corresponding bibliographic description in the repository

Publisher copyright

(Article begins on next page)

Lecture Notes in Energy 101

Maryse Labriet
Kari Espegren
George Giannakidis
Brian Ó Gallachóir *Editors*

Aligning the Energy Transition with the Sustainable Development Goals

Key Insights from Energy System
Modelling

OPEN ACCESS

 Springer

Lecture Notes in Energy

Volume 101

Lecture Notes in Energy (LNE) is a series that reports on new developments in the study of energy: from science and engineering to the analysis of energy policy. The series' scope includes but is not limited to, renewable and green energy, nuclear, fossil fuels and carbon capture, energy systems, energy storage and harvesting, batteries and fuel cells, power systems, energy efficiency, energy in buildings, energy policy, as well as energy-related topics in economics, management and transportation. Books published in LNE are original and timely and bridge between advanced textbooks and the forefront of research. Readers of LNE include postgraduate students and non-specialist researchers wishing to gain an accessible introduction to a field of research as well as professionals and researchers with a need for an up-to-date reference book on a well-defined topic. The series publishes single- and multi-authored volumes as well as advanced textbooks.

****Indexed in Scopus and EI Compendex**** The Springer Energy board welcomes your book proposal. Please get in touch with the series via Anthony Doyle, Executive Editor, Springer (anthony.doyle@springer.com)

Maryse Labriet • Kari Espegren
George Giannakidis • Brian Ó Gallachóir
Editors

Aligning the Energy Transition with the Sustainable Development Goals

Key Insights from Energy System Modelling

 Springer

Editors

Maryse Labriet
Eneris Environment Energy Consultants
Madrid, Spain

Kari Espegren
Energy Systems Analysis
Institute for Energy Technology
Kjeller, Norway

George Giannakidis
MRC Energy Consultants & Advisors
Greece
Marousi, Attiki, Greece

Brian Ó Gallachóir
MaREI Centre, Sustainability Institute
University College Cork
Cork, Ireland



ISSN 2195-1284

ISSN 2195-1292 (electronic)

Lecture Notes in Energy

ISBN 978-3-031-58896-9

ISBN 978-3-031-58897-6 (eBook)

<https://doi.org/10.1007/978-3-031-58897-6>

This work was supported by Energy Technology Systems Analysis Program

© The Editor(s) (if applicable) and The Author(s), under exclusive license to Springer Nature Switzerland AG 2024, corrected publication 2024. This book is an open access publication.

Open Access This book is licensed under the terms of the Creative Commons Attribution 4.0 International License (<http://creativecommons.org/licenses/by/4.0/>), which permits use, sharing, adaptation, distribution and reproduction in any medium or format, as long as you give appropriate credit to the original author(s) and the source, provide a link to the Creative Commons license and indicate if changes were made.

The images or other third party material in this book are included in the book's Creative Commons license, unless indicated otherwise in a credit line to the material. If material is not included in the book's Creative Commons license and your intended use is not permitted by statutory regulation or exceeds the permitted use, you will need to obtain permission directly from the copyright holder.

The use of general descriptive names, registered names, trademarks, service marks, etc. in this publication does not imply, even in the absence of a specific statement, that such names are exempt from the relevant protective laws and regulations and therefore free for general use.

The publisher, the authors and the editors are safe to assume that the advice and information in this book are believed to be true and accurate at the date of publication. Neither the publisher nor the authors or the editors give a warranty, expressed or implied, with respect to the material contained herein or for any errors or omissions that may have been made. The publisher remains neutral with regard to jurisdictional claims in published maps and institutional affiliations.

This Springer imprint is published by the registered company Springer Nature Switzerland AG
The registered company address is: Gewerbestrasse 11, 6330 Cham, Switzerland

If disposing of this product, please recycle the paper.

Foreword

Energy is at the centre of many of today's most pressing challenges, and progress towards Sustainable Development Goal 7 (SDG7) on universal access to affordable, reliable, sustainable and modern energy is crucial to human development. Importantly, the transition to clean energy has synergies with many other development goals—including on poverty, climate change and economic growth.

Developing strategies to meet these goals and address the complex interactions between them demands a deep understanding of energy systems and the potential impacts of different policy choices on pathways towards the energy transition. Energy system modelling and scenario analysis is an invaluable tool towards this aim.

First initiated in 1976, shortly after the International Energy Agency (IEA) was founded, the Energy Technology Systems Analysis Programme (ETSAP) is an important part of the IEA Technology Collaboration Programme and has a unique and long-standing role in advancing energy modelling and analysis across the world. Today, ETSAP's main energy system model generator—TIMES (The Integrated Markal-Efom System)—is used by modelling teams in around 200 institutions across 70 countries. The different chapters of this book illustrate the depth of insights provided by energy systems modelling, which goes beyond energy security to incorporate a wide range of social and environmental concerns across the energy value chain, including the critical minerals and metals used in key clean energy technologies.

As the IEA celebrates its 50th anniversary in 2024, systems analysis of the kind enabled by ETSAP's modelling tools has never been more important. These tools have been used by the IEA for decades to assess clean energy technologies in the global context and to develop scenarios that illustrate the impact of different policy choices for energy transition pathways. In 2023, our update to the IEA Net Zero Emissions by 2050 Scenario showed that the pathway to achieve net zero by mid-century remains open, thanks to remarkable growth in clean energy. The scenario also meets key energy-related development goals, in particular SDG 7.

ETSAP's first book published as part of Springer's Lectures in Energy Series, *Informing Energy and Climate Policies Using Energy Systems Models*, focused on tools and methodologies useful to support energy and climate policies. The second book, *Limiting Global Warming to Well Below 2°C: Energy System Modelling and Policy Development*, focused on applications of energy systems models for policy-making, in the context of the Paris Agreement on climate change. This latest ETSAP book explores the strategies required to align emissions reduction goals in the energy system with the broader ambitions of the SDGs, illustrating that technology and system transformations are needed in different parts of the energy sector, and at all levels—multilateral, national and local.

As 2030 draws ever closer, the insights contained in this book illustrate the depth and complexity of energy modelling today and its utility for decision-making on the energy transition. I hope that readers will be inspired by the case studies it contains and the potential for energy system modelling to inform ambitious action to accelerate the clean energy transition.

Executive Director
International Energy Agency, Paris, France

Dr. Fatih Birol

Preface

This book offers a unique perspective about the value of energy systems models in informing the sustainable development challenges faced by humanity. It sheds light on the imperatives for, and feasibility of, the energy transition to a zero-emissions future in the larger context of the Sustainable Development Goals. It illustrates how energy systems models are being improved and utilised to answer complex policy questions combining climate strategies, sustainable energy pathways, energy security, optimal investments, innovation, industrial development, and their impacts on society and resources.

This responds directly to the need to combine global ambitions in a more holistic and coherent way to pave the way for concrete and urgent steps to a sustainable future.

The book collates selected contributions of more than 15 teams of the IEA Energy Technology Systems Analysis Program (IEA-ETSAP), one of the longest running technology collaboration programmes of the International Energy Agency (IEA). A key objective of the partnership is to promote and support the development and application of technical economic tools to assist decision making with optimal energy and climate strategies.

This book constitutes a natural follow-up to the two previous books by IEA-ETSAP in Springer's Lecture Notes in Energy series: *Informing Energy and Climate Policies Using Energy Systems Models*, edited in 2015, prior to the Paris Agreement on climate change, and *Limiting Global Warming to Well Below 2 °C*, edited in 2018, the year of the Talanoa Dialogue to take stock of collective action and inform the Nationally Determined Contributions (NDCs).

The editors are very grateful to the chapter authors and peer reviewers who willingly shared their expertise and contributed with their valuable time, without which this book would not have been possible. In addition, we acknowledge and appreciate the English language revision support provided by Evan Boyle,

Tomas Mac Uidhir, Duncan Mathews and Fionn Rogan from University College Cork.

The views opinions, findings, and conclusions or recommendations expressed in this book are strictly those of the authors of the chapters. They do not necessarily reflect the views of any single or all Contracting Parties of ETSAP. The Contracting Parties of ETSAP take no responsibility for any errors or omissions in, or for the correctness of, the information contained in this book.

Madrid, Spain
Kjeller, Norway
Athens, Greece
Cork, Ireland
February 2024

Maryse Labriet
Kari Espegren
George Giannakidis
Brian Ó Gallachóir

Contents

Introduction	1
Maryse Labriet, Kari Espegren, George Giannakidis, and Brian Ó Gallachóir	
Part I Adapting Energy System Models to Inform SDGs	
Low Energy Demand Scenarios for OECD Countries: Fairness, Feasibility and Potential Impacts on SDGs	17
Rachel Freeman, Pernille Merethe Sire Seljom, Pieter Valkering, and Anna Krook-Riekkola	
Implications of the Net Zero Transition Scenarios on SDG Indicators: Linking Global Energy System, CGE and Atmospheric Source-Receptor Models	41
Maksym Chepeliev, George Giannakidis, Amit Kanudia, and Dominique van der Mensbrugge	
Accelerating the Performance of Large-Scale TIMES Models in the Modelling of Sustainable Development Goals	67
Evangelos Panos and Aymane Hassan	
Enabling Coherence Between Energy Policies and SDGs Through Open Energy Models: The TEMOA-Italy Example	97
Matteo Nicoli, Maria Elena Alfano, Farzaneh Amir Kavei, Alessandro Balbo, Gianvito Colucci, Daniele Lerede, Daniele Mosso, and Laura Savoldi	

Part II Using Energy System Modelling to Support the Transition to Renewable Energy	
Assessing the Impact of Climate Variability on Wind Energy Potential in Decarbonization Scenarios in Energy Systems Models	121
Bryn Stecher, Taiba Jafari, Lewis Wu, Olexandr Balyk, Áine Greene, and James Glynn	
Clean and Affordable Norwegian Offshore Wind to Facilitate the Low-Carbon Transition	145
Kristina Haaskjold and Pernille Seljom	
Will the Nordics Become an Export Hub for Electro Fuels and Electricity?	169
Kenneth Karlsson, Andrea Marin Radoszynski, Marie Münster, Lissy Langer, Ioannis Kountouris, Johannes Felipe Giehl, Jenny Westerberg, Sidsel A. Nissen, Alexander Daabeck, Mathias Bache, Lars Hedemann, Julia Kirch Kirkegaard, and Julia Hansson	
Transition Pathways for a Low-Carbon Norway: Bridging Socio-technical and Energy System Analyses	197
Miguel Chang, Kari Espegren, Kristina Haaskjold, Eva Rosenberg, Sigrid Damman, Tuukka Mäkitie, Paolo Pisciella, Allan Dahl Andersen, and Tomas Moe Skjølvold	
Part III Informing Energy Security with Energy System Models	
Modelling of Demands of Selected Minerals and Metals in Clean Energy Transition with 1.5–2.0 °C Mitigation Targets	225
Tiina Koljonen, Antti Lehtilä, Kirsikka Kiviranta, Kati Koponen, and Lassi Similä	
Emission Free Energy Carriers and the Impact of Trade to Achieve the 1.5 °C Target: A Global Perspective of Hydrogen and Ammonia . . .	247
Felix Lippkau, Ganesh Deepak Rupakula, and Markus Blesl	
Net-Zero Transition in Ukraine: Implications for Sustainable Development Goal 7	271
Maksym Chepeliev, Oleksandr Diachuk, Roman Podolets, Andrii Semeniuk, and Galyna Trypolska	
Align Algeria’s Energy Diversification Strategies with Energy and Climate Sustainable Development Goals	295
Naïma Chabouni, Charlène Barnet, Edi Assoumou, Nadia Maïzi, and Sandrine Selosse	

Part IV Engaging with Policy-Makers on Energy System Models

Integrating Sustainable Development Goals to Assess Energy Transition Scenarios in Municipalities of Northern Sweden 325
Parvathy Sobha and Anna Krook-Riekkola

Translating Research Results into Policy Insights to Underpin Climate Action in Ireland 349
Brian Ó Gallachóir, Paul Deane, and Fionn Rogan

Retrospective of Prospective Exercises: A Chronicle of Long-Term Modelling and Energy Policymaking in France 375
Nadia Maïzi, Edi Assoumou, and Ariane Millot

Correction to: Aligning the Energy Transition with the Sustainable Development Goals C1
Maryse Labriet, Kari Espegren, George Giannakidis,
and Brian Ó Gallachóir

The original version of this book was previously published without open access. A correction to this book is available at https://doi.org/10.1007/978-3-031-58897-6_17

Introduction



**Maryse Labriet, Kari Espegren, George Giannakidis,
and Brian Ó Gallachóir**

Abstract The tools and capabilities offered by ETSAP have been shaped by the evolving challenges related to the energy systems, from the oil crisis of the 70s, the air pollution concern of the 80s to the climate challenge from the 90s and now, the more holistic perspective of the Sustainable Development Goals (SDGs). The book collates together 15 case studies at global, regional (eg. Europe, Nordic countries), national (eg. Algeria, France, Ireland, Italy, Norway, Ukraine) and local scales (eg. Swedish municipalities), examining the co-benefits and trade-offs across SDGs associated directly or indirectly with the changes in the energy systems. The case studies discuss the needed adaptation of energy systems models to inform SDGs, including both endogenous improvements and novel applications of the models. They illustrate how energy systems models are used to assess the role of renewable energy and energy security in the implementation of the energy transition, considering the challenges of variable sources of energy, materials scarcity, and dependence on international energy markets, amongst others. The book also demonstrates how energy systems models are used to interact with policymakers in national and municipal debates. The book is the third of a series already edited by IEA-ETSAP. Its responds to the requirement of combining global ambitions in a more holistic and coherent way to pave the way for concrete and urgent steps to a sustainable future.

M. Labriet (✉)

Eneris Environment Energy Consultants, Madrid, Spain

e-mail: maryse.labriet@enerisconsultants.com

K. Espegren

Energy Systems Analysis, Institute for Energy Technology (IFE), Kjeller, Norway

e-mail: Kari.Espegren@ife.no

G. Giannakidis

MRC Energy Consultants & Advisors Greece, Marousi, Attiki, Greece

e-mail: ggiannakidis@mrc-consultants.com

B. Ó Gallachóir

MaREI Centre, Sustainability Institute, University College Cork, Cork, Ireland

e-mail: b.ogallachoir@ucc.ie

© The Author(s) 2024

M. Labriet et al. (eds.), *Aligning the Energy Transition with the Sustainable Development Goals*, Lecture Notes in Energy 101,

https://doi.org/10.1007/978-3-031-58897-6_1

Key Messages

- The MARKAL/TIMES models and capabilities offered by the IEA-ETSAP Technology Collaboration Programme have been shaped by the evolving challenges related to the energy systems over the last 45 years.
- The transition to a net zero emissions future must consider the broader social, economic, and environmental sustainability of the new system, given the inextricable linkages between climate, energy systems and the overall development of societies.
- Fifteen case studies reveal how energy systems models are adapted and used to inform progress on SDGs, to assess the role of renewable energy and energy security and to engage with policymakers.
- MARKAL-TIMES models are shown to be relevant and useful in supporting decision-makers from all around the World in defining the required energy transition in the larger context of other SDGs imperatives.

1 The IEA Energy Technology Systems Analysis Program: From the Oil Crisis to the Sustainable Development Goals

1.1 IEA-ETSAP Technology Collaboration Programme

The transition to net zero greenhouse gas emissions energy systems has become a priority in energy policy making, as countries seek to deliver on the Paris Agreement. The path towards a radically different energy system is essential to reach the Sustainable Development Goals (SDGs) on energy (SDG7) and on climate (SDG13). The path must also however consider the broader social, economic, and environmental sustainability of the new system, given the inextricable linkages between climate, energy systems and the overall development of societies.

In this context, a joint international programme of energy systems analysis is now even more necessary than when Energy Technology Systems Analysis Program (ETSAP) began nearly 50 years ago under the aegis of the International Energy Agency (IEA) in response to the pressures arising from the first oil crisis. Decision makers need robust policy analyses that encompass the global, regional, national, and local factors with increasing detail and that address the trade-offs and synergies inherent in the SDGs.

This international collaboration has its origins in 1976, when a group of member countries of the IEA formed a collaborative project to tackle one of their most pressing problems, namely, to determine what research, development and demonstration actions were appropriate to “ensure a smooth transition from economies primarily based on oil to what became known as ‘post oil’ economies” (Brady and Hanna 1984). The context for this was significant. The world was still in shock following the 1973 oil crisis and was unsure what was coming next (in fact another shock in 1979). What was clear from this first meeting was that the necessary analytical tools to explore how to envision or chart a path to ‘post oil’ economies did not exist. ETSAP, the Energy Technology Systems Analysis Programme was

born! The initial collaboration involved over 50 experts and the collective computing strengths of two major international laboratories, the Brookhaven National Laboratory (BNL) in the USA and the Kernforschungsanlage (KFL) in (then) West Germany. This unique international collaboration yielded results and impacts quickly, having developed the MARKAL modelling tool by 1979 (Gargiulo and Ó Gallachóir 2013), the year that the need for this modelling tool was brought into sharp focus, given the second oil crisis that was underway.

Formally established in 1980, IEA-ETSAP is a unique network of energy modelling teams from approximately 70 countries and is one of the longest running of the 39 Technology Collaboration Programme (TCP) of the IEA. The overarching objective of the partnership is to assist decision makers in defining optimal energy and climate policies through the development, promotion and support of an energy-economy-environment-engineering (4E) analytical capability, mainly based on the MARKAL (MARKet ALlocation) and subsequently the TIMES (The Integrated MARKAL-EFOM System) family of techno-economic energy systems models. IEA-ETSAP has built since the outset a continuous exchange of information and experiences related to energy modelling, energy systems analysis and energy technology assessment, stimulating cooperative studies and benefiting from common analysis. IEA-ETSAP is also engaged with other international bodies, such as the Energy Modelling Forum (EMF), the Intergovernmental Panel on Climate Change (IPCC), other IEA-TCPs and the International Renewable Energy Agency (IRENA).

Resulting from the collaborative development of open source MARKAL and TIMES energy systems model generators and the non-stop efforts by IEA-ETSAP in building modelling capabilities Worldwide, nearly 200 teams of IEA-ETSAP tool users independently offer their capabilities to local, national and international organizations, actively contributing to climate change mitigation analysis, building energy models, compiling scenarios, and conducting analyses, with a common, comparable and combinable methodology.

1.2 Building and Adapting Modelling Tools and Capabilities to Evolving Challenges

The tools and capabilities offered by ETSAP have been shaped by the evolving challenges related to changing energy systems. The first oil crisis in 1973 led to the emergence of more comprehensive analytical tools and capabilities to better understand the energy supply and demand dynamic, address long-term energy security, and inform optimal energy planning. This was the initial motivation of modelling development by ETSAP. During the 1980s, air pollution and acid rain became a serious concern which raised the need to better represent the interactions between energy activities and the environment. It became essential that energy systems models could carefully evaluate the performance, cost, and timing of cleaner energy technologies but also the new energy and environment instruments like cap-and-

trade systems that emerged in the United States of America as emission abatement incentives.

Greenhouse gases and climate change emerged as a priority from the 1990s. Energy systems models developed by ETSAP, including national models and the global TIMES Integrated Assessment Model (TIAM), played a key role in the definition of national policies and global agreements, such as the Kyoto Protocol in 1997 and the Paris Agreement in 2015. The capacity of the models to tackle local, national, regional, and global scales was fundamental to building Nationally Determined Contributions, to exploring least-cost solutions to global environmental challenges such as climate change and to evaluating credible international agreements addressing concerns regarding the potential for countries becoming free-riders.

The United Nations 2030 Agenda for Sustainable Development and its 17 SDGs (Table 1) reinforced the fundamental importance of considering the interaction of energy systems with the other dimensions of development, such as land use, water, agriculture, materials use, economic growth, employment, resource conservation, equity, to name but a few. The integration of these dimensions into energy systems

Table 1 The 17 SDGs

Goal 1. End poverty in all its forms everywhere
Goal 2. End hunger, achieve food security and improved nutrition and promote sustainable agriculture
Goal 3. Ensure healthy lives and promote well-being for all at all ages
Goal 4. Ensure inclusive and equitable quality education and promote lifelong learning opportunities for all
Goal 5. Achieve gender equality and empower all women and girls
Goal 6. Ensure availability and sustainable management of water and sanitation for all
Goal 7. Ensure access to affordable, reliable, sustainable and modern energy for all
Goal 8. Promote sustained, inclusive and sustainable economic growth, full and productive employment and decent work for all
Goal 9. Build resilient infrastructure, promote inclusive and sustainable industrialization and foster innovation
Goal 10. Reduce inequality within and among countries
Goal 11. Make cities and human settlements inclusive, safe, resilient and sustainable
Goal 12. Ensure sustainable consumption and production patterns
Goal 13. Take urgent action to combat climate change and its impacts (acknowledging that the United Nations Framework Convention on Climate Change is the primary international, inter-governmental forum for negotiating the global response to climate change)
Goal 14. Conserve and sustainably use the oceans, seas and marine resources for sustainable development
Goal 15. Protect, restore and promote sustainable use of terrestrial ecosystems, sustainably manage forests, combat desertification, and halt and reverse land degradation and halt biodiversity loss
Goal 16. Promote peaceful and inclusive societies for sustainable development, provide access to justice for all and build effective, accountable and inclusive institutions at all levels
Goal 17. Strengthen the means of implementation and revitalize the global partnership for sustainable development

Source: United Nations (2015)

models, or the coupling of energy systems models with other sectoral tools have been developed as new research paths for the work undertaken by ETSAP.

Across the evolutions of energy systems modelling over the years, ETSAP developed new methods, such as stochastic programming, to address the many uncertainties in technologies, environmental requirements and levels of socio-economic activity, that characterize the energy systems and policies. The modelling of variable renewables has been another important area for improvement so that energy models could adequately consider the challenges in the flexibility of the system operation. The integration of societal dimensions including human behaviour dynamics has also been continuously improving over the years to refine the demand side of MARKAL/TIMES models, which drives the energy needs to be satisfied.

2 The MARKAL/TIMES Family of Models: Examples and Openness

TIMES (an acronym for The Integrated MARKAL-EFOM System) is a technology rich, bottom-up model generator, which uses linear-programming to generate least-cost energy systems pathways, optimized according to a number of user constraints, over medium to long-term time horizons.

Combining end-use energy service demands, stocks of energy related equipment, characteristics of future technologies, as well as potential of primary energy commodities as inputs, a TIMES model aims to generate whole energy system pathways that deliver energy services at minimum global cost (more accurately at minimum loss of total surplus) by simultaneously making decisions on equipment investment and operation, primary energy supply and energy trade. The scope of the TIMES modelling framework extends beyond purely energy-oriented issues, to include the representation of emissions, and materials, related to the energy system. The framework is highly suited to the analysis of energy-environmental policies, which may be represented with accuracy due to the explicitness of the representation of technologies and fuels in all sectors.

Several major models have been derived from the MARKAL/TIMES framework, each tailored to specific geographic regions, policy objectives, or sectors. The Integrated Assessment Modelling (IAM) community has widely adopted these models, contributing to a global understanding of energy transitions. One notable example is the TIMES Integrated Assessment Modelling framework (TIAM), which extends the TIMES model to encompass a broader perspective, integrating energy, economy, and environment considerations (Loulou 2008; Loulou and Labriet 2008). TIAM has been applied in various studies worldwide, facilitating analyses that span multiple dimensions of sustainability.

The International Energy Agency established a 15 region global Energy Technology Perspectives (ETP) MARKAL model in 2003 that underpinned a series of analyses and reports that explore the long term evolution of the global energy

system. The IEA published nine editions of the Energy Technology Perspectives report using the ETP model. In 2021, the IEA adopted a new hybrid modelling approach (drawing on the strengths of both the IEA-ETP model and the IEA World Energy Outlook model) to develop the world's first comprehensive study of how to transition to an energy system at net zero CO₂ emissions by 2050. The most recent edition of the Energy Technology Perspectives report in 2023 uses this new hybrid Global Energy and Climate (GEC) Model and provides analysis on the risks and opportunities surrounding the development and scaling up of clean energy and technology supply chains in the years ahead, viewed through the lenses of energy security, resilience and sustainability.

In the European context, the JRC-EU-TIMES model is tailored to address the energy and environmental challenges specific to the European Union (EU) (Nijs and Ruiz 2019). Developed by the Joint Research Centre (JRC), the research arm of the European Commission, EU-TIMES serves as a powerful tool for strategic energy planning and policy analysis within the EU context. This model enables policymakers and stakeholders to assess the complex interactions between energy systems, economic dynamics, and environmental considerations, providing valuable insights for the evaluation of sustainable energy policies.

National, regional and local TIMES models exist in an ever increasing number of countries around the world that have been developed by the 200 TIMES modelling teams that currently exist in 70 countries. A number of these are presented in this book and the two previous ETSAP books published by Springer, i.e. Giannakidis et al. (2015, 2018).

The TIMES framework source code is available under a GNU General Public Licence v3.0 since January 2020 and can be download from GitHub (<https://github.com/etsap-TIMES>). Documentation is available online (Goldstein et al. 2016; Loulou et al. 2016a, b). There are multiple ETSAP initiatives underway to increase the transparency of TIMES models and their results. There is a growing number of open-source TIMES models (for example the JRC-EU-TIMES model, UK TIMES model and the TIMES Ireland Model) in addition to available datasets tailored for use in TIMES models, and web based user interfaces (IEA-ETSAP 2022, 2023). More information on IEA-ETSAP activities, tools and users can be found at www.iea-etsap.org.

3 This Book: Net Zero Emissions, SDGs, and Energy Security

Adapting energy systems modelling approaches to explore the energy sector and related environmental and economic dimensions in a more holistic context has been central to the recent activities of the IEA-ETSAP. More particularly, the 2020–2022 work program of IEA-ETSAP has focused explicitly on Energy Systems and Sustainable Development Goals.

Driven by the SDGs 7 on accessible, affordable clean energy and 13 on climate action, the recent developments and applications of MARKAL/TIMES models have enabled improved understanding and better informed pathways to net zero GHG emissions systems, together with the interaction of energy systems with materials use, land use, water and agriculture, the integration of biomass sustainability in the analyses, the improved modelling of variable renewable energy and of human behaviour in energy needs, while also examining the co-benefits and trade-offs across SDGs associated directly or indirectly with the changes in the energy systems.

The topic of energy security has become a very live issue geopolitically in recent years, after receiving a relatively lower focus of attention in recent decades. This reinforces the need to align the dual goals of achieving energy security and net zero emissions energy systems, always within the overall context of progressing towards the Sustainable Development Goals.

This book uniquely collates together a range of concrete analyses from all around the World and at different scales that inform the pathways for the energy transition in the larger context of the SDGs imperatives. The book illustrates how energy systems models contribute to aligning two distinct global ambitions, namely delivering the energy transition to a zero emissions future and achieving the sustainable development goals. It increases the evidence base for future pathways that not only reduce emissions in the energy system, but also contribute to economic growth, industry and innovation, employment, sustainable cities, responsible consumption and production, energy security, optimal investments, amongst others.

The book is the third of a series already edited by IEA-ETSAP. The first one (Giannakidis et al. 2015) focused on tools, methodologies and case studies of energy systems models supporting energy and climate policies. The second one (Giannakidis et al. 2018) focused on applications of energy systems models for decision-making, especially in the context of the Paris Agreement on Climate Change to achieve a well below 2 °C World. It was written in response to the urgent need for national deep decarbonisation analyses following the Paris Agreement, when the policy focus on climate mitigation shifted from the top-down distributions of global targets to the bottom-up development of Nationally Determined Contributions.

This third book offers a unique and timely perspective on the value of energy systems models in informing the sustainable development challenges faced by humanity and explore the strategies to best align emissions reduction goals in the energy system with the broader ambitions of the sustainable development goals.

The book is carefully structured into four distinct and complementary parts illustrating how energy systems models have been adapted to inform SDGs (Part I), assessing the role of renewable energy (Part II) and energy security (Part III) in the implementation of the energy transition, and demonstrating how energy systems models are used to engage with policymakers (Part IV).

3.1 Part I: Adapting Energy Systems Models to Inform SDGs

Chapter “[Low Energy Demand Scenarios for OECD Countries: Fairness, Feasibility and Potential Impacts on SDGs](#)” by Freeman et al. reviews how low energy demand (LED) scenarios in OECD countries, modelled with energy system optimisation models, treat societal issues like fairness, feasibility, and the potential impacts on the SDGs. LED scenarios can meet national and global net zero targets more economically and with less technological uncertainty compared to non-LED scenarios. Some LED scenario narratives envisage deeply transformative societal changes, while others are more focused on demand reduction with technology improvement measures such as energy efficiency. SDG targets for OECD countries that are most likely to be negatively affected by an LED approach are poverty, overcoming inequality, and participatory decision making. Those more likely to see win-wins include increased access to energy, renewable energy, energy efficiency, and improved use of resources. ESOMs could be improved by expanding their scope to represent the societal transformation parts of LED scenario narratives and the feedback between demand and economy.

Chapter “[Implications of the Net Zero Transition Scenarios on SDG Indicators: Linking Global Energy System, CGE and Atmospheric Source-Receptor Models](#)” by Chepeliev et al. employs a multi-model framework with a global computable general equilibrium model (ENVISAGE), an energy system model (KINESYS) and an atmospheric source-receptor model (TM5-FASST) to provide a detailed representation of the energy-related SDG indicators while accounting for their interactions with climate mitigation and socio-economic dimensions. Out of 17 analysed SDG indicators, 7 experience co-benefits from implementing mitigation efforts, 6 indicators are subject to trade-offs, while the remaining 4 indicators show mixed trends. The identified trade-offs could be substantially reduced through specific policy solutions. Moreover, monetized co-benefits from improved air quality outweigh mitigation costs by more than a factor of two, thus changing trade-offs for the case of economic growth into synergies.

Chapter “[Accelerating the Performance of Large-Scale TIMES Models in the Modelling of Sustainable Development Goals](#)” by Panos and Hassan provide insights into two powerful solver-based methods to accelerate the performance of large-scale TIMES models that integrate SDGs in high spatial and temporal detail. Applied to a European TIMES-based model, a tailored solver parametrisation reduces solution times in shared-memory computer systems by 95%. Solving the model matrix in parallel and across multiple nodes decouples solution times and model complexity. These methods facilitate the use of large-scale TIMES models featuring the assessment of the complex interactions between several SDGs.

Chapter “[Enabling Coherence Between Energy Policies and SDGs Through Open Energy Models: The TEMOA-Italy Example](#)” by Nicoli et al. illustrates how to properly evaluate the implications of energy scenarios as to the overall system sustainability and achievement of the SDGs, using the open-source and open-data TEMOA-Italy combined with a set of indicators reflecting environmental, security,

and social dimensions of the transition. The analysis illustrates the synergies between the net-zero emission target, the limitation of acidification and eutrophication risks and public health, to the detriment of land use, import dependence, and quality of labour. Excluding the deployment of carbon capture technologies forces a lower reliance on fossil fuels and therefore improves geopolitical stability. However, the transition to renewable-heavy systems poses initial challenges to labour quality and import dependence due to critical reliance on imports of renewable technologies.

3.2 Part II: Using Energy System Modelling to Support the Transition to Renewable Energy

Chapter “[Assessing the Impact of Climate Variability on Wind Energy Potential in Decarbonization Scenarios in Energy Systems Models](#)” by Stecher et al. assesses the impacts of climate variability on onshore and offshore wind energy potential, utilizing the wind capacity factor as a comparable value. Adopting global statistical analysis methods and the TIMES United States model (TUSM), the influence of climate variability on wind energy is modelled, providing insights into how specific decarbonization scenarios impact the achievement of SDG 7 on energy and SDG 11 on cities. Results reveal minimal variation in capacity factor values, indicating that wind energy is likely to remain a robust power generation source, regardless of the chosen decarbonization scenario. These findings hold important implications for wind turbine design, deployment strategies, and regional energy planning and policy.

Chapter “[Clean and Affordable Norwegian Offshore Wind to Facilitate the Low-Carbon Transition](#)” by Haaskjold and Seljom explores how Norwegian offshore wind power can be a significant electricity supply contributor to facilitate the Norwegian and European green transition, considering future development in technology, national energy demand, the European power market, as well as social acceptance of energy production and grid expansion. The results obtained with the energy system model IFE-TIMES-Norway, show that the ambitions of the Norwegian government (30 GW offshore wind by 2040) can be economically viable without the necessity of subsidies, depending on the future development of the European power market. Norwegian offshore wind can also enhance energy security (SDG 7) and facilitate greater hydrogen production from electrolysis, contributing to climate mitigation (SDG 13) and new industry development (SDG 9).

Chapter “[Will the Nordics Become an Export Hub for Electro Fuels and Electricity?](#)” by Karlsson et al. discusses the role of the Nordics as a potential export hub for electro fuels and electricity to mainland Europe and abroad, using the TIMES Northern Europe, amongst others. The analysed scenarios confirm the robustness of the conclusion that the Nordics can become a major exporter of hydrogen and electricity. Positive impact goes beyond SDG 13 on climate and

supports several SDGs like SDG 8 on work and economic growth, SDG 6 on water, SDG 9 on industry, amongst others.

Chapter “[Transition Pathways for a Low-Carbon Norway: Bridging Socio-technical and Energy System Analyses](#)” by Chang et al. presents an interdisciplinary approach to analyse different transition pathways towards the sustainable development of a low-carbon society, focusing on Norway and using the IFE-TIMES-Norway. It bridges a socio-technical perspective on sustainability transitions with techno-economic energy systems and regional-economic modelling analyses. The results show that higher levels of decarbonization are possible for Norway. However, potential bottlenecks can slow down the transition, such as the maturity of technology options, the feasibility of novel innovations and infrastructure, and policy developments, and trade-offs between SDG targets emerge, namely economic growth and decarbonization.

3.3 Part III: Informing Energy Security with Energy System Models

Chapter “[Modelling of Demands of Selected Minerals and Metals in Clean Energy Transition with 1.5–2.0 °C Mitigation Targets](#)” by Koljonen et al. explores the future demands of selected minerals and metals in long-term scenarios for the global energy system until 2100 with the TIMES-VTT Integrated Assessment Model, which includes data on metal demands for renewable energy technologies, carbon capture and storage power plant technologies (both fossil and bioenergy), nuclear power, battery technologies, electrolyzers, and electric vehicles. The results suggest that to ensure affordable and clean energy access for all (SDG7) along with climate action (SDG13), global cumulative consumption of cobalt overshoots the identified resources by 2100 without substantive recycling and substitution. Moreover, a rapid expansion of battery metal demands calls for immediate actions to address human rights issues, safe working conditions and protection of local environment in the Global South, where mining activities may increase rapidly (SDG10).

Chapter “[Emission Free Energy Carriers and the Impact of Trade to Achieve the 1.5 °C Target: A Global Perspective of Hydrogen and Ammonia](#)” by Lippkau et al. analyses the most cost-effective global trade routes for supplying green hydrogen and green ammonia, which emerge as pivotal in decarbonizing the industrial sector. Based on the TIMES Integrated Assessment Model (TIAM), the findings of the study suggest that Europe is import dependant and Middle East Asia has the lowest green hydrogen costs, combined with abundant potential, and could be the main exporter if no trade restriction policies are applied. In the case of trade restrictions, exports of hydrogen and ammonia would be more important from Africa, Central and South America and Australia.

Chapter “[Net-Zero Transition in Ukraine: Implications for Sustainable Development Goal 7](#)” by Chepeliev et al. relies on TIMES-Ukraine to study

net-zero transition in Ukraine. The assessment considers the potential implications of the ongoing war in the country. Results suggest that the net-zero transition would help improve some SDG7 dimensions in Ukraine—increase electricity supply and share of renewables, but it would have a very limited effect on the energy intensity and energy dependency of the economy. Energy affordability would improve in the long run, but growing electricity and heat prices could challenge the ambitious climate mitigation efforts in the medium run. Increased international financing, a more competitive domestic environment and higher carbon prices are required to close the major financing gap for achieving the net-zero transition.

Chapter “[Align Algeria’s Energy Diversification Strategies with Energy and Climate Sustainable Development Goals](#)” by Chabouni et al. focuses on the case of Algeria, which is highly dependent on hydrocarbon exports, leaving it vulnerable to fluctuations in international market prices. The TIMES-DZA model for Algeria was used to assess technological configurations of the power and hydrogen sectors of the country by 2070 and their consequences on CO₂ emissions. Enforcing Algeria’s policy targets on renewable and hydrogen leads to a more diversified energy supply, aligning with SDG 7 on energy, but without reducing sufficiently the greenhouse gas emissions, thus not fully aligning with SDG 13 on climate. The addition of a climate target to the current policy targets raises concerns about the feasibility of achieving CO₂ emissions reduction and meeting the gas domestic demand and export requirements.

3.4 Part IV: Engaging with Policymakers on Energy System Models

Chapter “[Integrating Sustainable Development Goals to Assess Energy Transition Scenarios in Municipalities of Northern Sweden](#)” by Sobha and Krook-Riekkola applies a TIMES-based model to represent the municipal energy system of Gällivare in northern Sweden and its potential transition pathways. It proposes a set of well-selected sustainability indicators implemented in the model to assess the sustainability of different pathways. The analysis shows both convergent and divergent pathways. For instance, while the increased use of renewable energy supports urban sustainability (SDG11 on cities) and climate change mitigation (SDG13 on climate), it raises concerns about energy affordability (SDG7 on energy) and material consumption (SDG12 on responsible production and consumption).

Chapter “[Translating Research Results into Policy Insights to Underpin Climate Action in Ireland](#)” by Ó Gallachóir et al. presents innovative processes such as novel communications methods, proactive engagement programmes and co-production processes, to bridge the interface between the energy modelling research ecosystem and policy-making ecosystem. It focuses on a specific case study, namely how energy systems modelling with TIMES models has been used to inform energy and climate mitigation policies in Ireland. Energy systems modelling played a key

role in advancing delivery of SDG 13 on climate, SDG 7 on energy, SDG 12 on sustainable consumption and production, and SDG 17 on partnerships in Ireland. It concludes with a seven stage bridging approach of (1) undertaking scientifically robust research, making methods and results openly and publicly available (2) framing research questions that respond to specific policy needs, (3) translating research results into policy insights (4) improving communications of research findings through use of infographics (5) engaging actively with policy practitioners and policy makers (6) co-production of policy and (7) building absorptive capacity in the policy system.

The final chapter “[Retrospective of Prospective Exercises: A Chronicle of Long-Term Modelling and Energy Policymaking in France](#)” by Maïzi et al. also reflects on the linkage between modellers and policy makers, and how TIMES models can support decision making and catalyse discussions on demands, technical choices, and systemic interactions, based on modelling experiences in France. Using TIMES-France in prospective assessments considering climate strategies, nuclear phase-out, 100% renewable power systems, scarcity of critical materials, etc., the authors show that TIMES models are relevant tools to explore SDG 7 on energy, SDG 8 on economic growth, SDG 9 on industry, SDG 11 on cities and SDG 13 on climate. Although policymakers do not fully harness the wealth of technical insights provided by researchers, the insights from energy system modelling tend to progressively penetrate the public debate and policy-making sphere, which emphasizes the relevance of using prospective and energy system models to address climate change in the global context of SDGs.

3.5 Further Information on Energy Systems Modelling and SDGs

In addition to the cases presented in this book, several other recent applications of TIMES models may be of interest to the reader. Amongst them, studies done by IEA-ETSAP members led to the elaboration of energy and climate plans in Armenia, Italy, Moldavia, Quebec, Serbia, South Korea, Spain, Vietnam, the evaluation of policies and measures for reaching carbon neutrality targets in Finland, Switzerland, the definition of carbon budgets in New Zealand, Ireland, United Kingdom, the information of the nuclear debate in Belgium and local policy planning in Sweden (IEA-ETSAP 2022, 2023).

TIMES modelling was part of the modelling work contributing to the World Bank’s Country Climate and Development Report for Uzbekistan (World Bank Group 2023). Other hot topics researched by IEA-ETSAP teams included, amongst others, the energy-water-land nexus in Germany (Sehn and Blesl 2021), the circular economy in industrial sectors of Spain (Perula Jimenez to be published) and the EU (Lima et al. 2023), and the availability of cobalt in decarbonized scenarios with high electric mobility (Seck et al. 2022).

References

- Brady J, Hanna B (1984) Energy technologies after the 80s. In: Proceedings of the 4th national conference on energy management, Dublin, 23 May 1984
- Gargiulo M, Ó Gallachóir B (2013) Long-term energy models: principles, characteristics, focus, and limitations. *Wiley Interdiscip Rev Energy Environ* 2:158–177. <https://doi.org/10.1002/wene.62>
- Giannakidis G, Labriet M, Ó Gallachóir B, Tosato GC (eds) (2015) Informing energy and climate policies using energy systems models: insights from scenario analysis increasing the evidence base, Lecture notes in energy 30. Springer. <https://doi.org/10.1007/978-3-319-16540-0>
- Giannakidis G, Karlsson K, Labriet M, Ó Gallachóir B (eds) (2018) Limiting global warming to well below 2 °C: energy system modelling and policy development, Lecture notes in energy 64. Springer. <https://doi.org/10.1007/978-3-319-74424-7>
- Goldstein G, Kanudia A, Lehtila A, Remme U, Wright E (2016–updated 2024) Documentation for the TIMES model. Part III. The operation of the TIMES code. Energy Technology Systems Analysis Programme (IEA-ETSAP). <https://iea-etsap.org/index.php/documentation>
- IEA-ETSAP (2022) Annual report 2020–2021. Annex XV—energy systems and sustainable development goals. Energy Technology Systems Analysis Programme. <https://iea-etsap.org/index.php/community/official-documents>
- IEA-ETSAP (2023) Annual report (2022). Annex XV—energy systems and sustainable development goals. Energy Technology Systems Analysis Programme. <https://iea-etsap.org/index.php/community/official-documents>
- Lima A, Simoes S, Aloini D, Zerbinò P, Oikonomou T, Karytsas S, Karytsas C, Seco Calvo O, Porcar B, Herrera I, Slabik S, Dürr H, Genovese A, Bimpizas-Pinis M (2023) Climate mitigation models need to become circular—let’s start with the construction sector. *Resour Conserv Recycl* 190:106808. <https://doi.org/10.1016/j.resconrec.2022.106808>
- Loulou R (2008) ETSAP-TIAM: the TIMES integrated assessment model. Part II: mathematical formulation. *CMS* 5(1–2):41–66. <https://doi.org/10.1007/s10287-007-0045-0>
- Loulou R, Labriet M (2008) ETSAP-TIAM: the TIMES integrated assessment model. Part I: model structure. *CMS* 5(1–2):7–40. <https://doi.org/10.1007/s10287-007-0046-z>
- Loulou R, Goldstein G, Kanudia A, Lehtila A, Remme U (2016a–updated 2021) Documentation for the TIMES model. Part I. TIMES concepts and theory. Energy Technology Systems Analysis Programme (IEA-ETSAP). <https://iea-etsap.org/index.php/documentation>
- Loulou R, Lehtila A, Kanudia A, Remme U, Goldstein G (2016b–updated 2021) Documentation for the TIMES model. Part II. Reference manual. Energy Technology Systems Analysis Programme (IEA-ETSAP). <https://iea-etsap.org/index.php/documentation>
- Nijs W, Ruiz P (2019) 01_JRC-EU-TIMES Full model. European Commission, Joint Research Centre (JRC) [Dataset] PID: <http://data.europa.eu/89h/8141a398-41a8-42fa-81a4-5b825a51761b>
- Péruła a (to be published) Modelling circular economy strategies in TIMES Models. PhD thesis, Universidad Politécnica de Madrid
- Seck GS, Hache E, Barnet C (2022) Potential bottleneck in the energy transition: the case of cobalt in an accelerating electro-mobility world. *Resour Policy* J 75:102516. <https://doi.org/10.1016/j.resourpol.2021.102516>
- Sehn V, Blesl M (2021) Implications of National Climate Targets on the energy-water nexus in Germany: a case study. *J Sustainable Dev Energy Water Environ Syst* 9(1):1080344. <https://doi.org/10.13044/j.sdewes.d8.0344>
- UN (2015) Transforming our world: the 2030 agenda for sustainable development. United Nations. <https://sdgs.un.org/2030agenda> and <https://sdgs.un.org/goals>
- World Bank Group (2023) Uzbekistan country climate and development report, CCDR series. World Bank, Washington, DC. <http://hdl.handle.net/10986/40608>

Open Access This chapter is licensed under the terms of the Creative Commons Attribution 4.0 International License (<http://creativecommons.org/licenses/by/4.0/>), which permits use, sharing, adaptation, distribution and reproduction in any medium or format, as long as you give appropriate credit to the original author(s) and the source, provide a link to the Creative Commons license and indicate if changes were made.

The images or other third party material in this chapter are included in the chapter's Creative Commons license, unless indicated otherwise in a credit line to the material. If material is not included in the chapter's Creative Commons license and your intended use is not permitted by statutory regulation or exceeds the permitted use, you will need to obtain permission directly from the copyright holder.



Part I
Adapting Energy System Models
to Inform SDGs

Low Energy Demand Scenarios for OECD Countries: Fairness, Feasibility and Potential Impacts on SDGs



Rachel Freeman, Pernille Merethe Sire Seljom, Pieter Valkering,
and Anna Krook-Riekkola

Abstract While the sustainable development goals (SDGs) are most challenging for developing countries, they apply equally to OECD member countries and are important to consider during these countries' energy transition. Low energy demand (LED) scenarios, modelled with energy system optimisation models (ESOMs), show that there is potential for meeting national and global climate mitigation targets more economically and with less technological uncertainty, while buying time during the transition. Some LED scenario narratives envisage deeply transformative societal changes, while others are more focused on demand reduction with technology improvement measures such as energy efficiency. In a review of 11 LED modelling studies, demand reductions by 2050, compared to 2020, range from moderately (8%) to much higher (56%) than non-LED scenarios. SDG targets for OECD countries that are most likely to be negatively affected by a LED approach are poverty (1.2), overcoming inequality (10.1), and participatory decision making (16.7). Those SDGs more likely to see win-wins include access to energy (7.1), renewable energy (7.2), energy efficiency (7.3), and use of resources (12.2). When modelling LED scenarios in ESOMs, there should be more representation of the rebound effect and feedback between demand and economy, heterogeneity in societal responses to LED-type policies, and the idea of sufficiency to better reflect the novelty of pathways to achieving LED scenario narratives.

R. Freeman (✉)

University College London, London, UK

e-mail: Rachel.freeman@ucl.ac.uk; rachel.freeman@dnv.com

P. M. S. Seljom

Institute for Energy Technology, Kjeller, Norway

e-mail: pernille.seljom@ife.no

P. Valkering

VITO – Energyville, Boeretang, Belgium

e-mail: pieter.valkering@vito.be

A. Krook-Riekkola

Luleå University of Technology, Luleå, Sweden

e-mail: anna.krook-riekkola@ltu.se

© The Author(s) 2024

M. Labriet et al. (eds.), *Aligning the Energy Transition with the Sustainable Development Goals*, Lecture Notes in Energy 101,
https://doi.org/10.1007/978-3-031-58897-6_2

Key Messages

- LED scenarios can meet national and global net zero targets more economically and with less technological uncertainty compared to non-LED scenarios.
- LED scenarios require unprecedented transformative societal changes and therefore their feasibility is highly uncertain.
- In LED scenarios, SDG targets for societal inequality, fuel poverty, and participatory decision making indicators could be worsened, and win-wins could be seen in SDGs for energy access, renewable energy, energy efficiency, and resource use.
- ESOMs could be improved by expanding their scope to represent the societal transformation parts of LED scenario narratives and the feedback between demand and economy.

1 Introduction

While the sustainable development goals (SDGs) are most challenging for developing countries, they apply equally to countries of the Organisation for Economic Co-operation and Development (OECD) and are important to consider during these countries' transition to net zero emissions of greenhouse gases (GHG). Some SDG targets in OECD member countries are likely to be particularly affected, beneficially, or not, by net zero scenarios that are described as “low energy demand” (LED). LED scenarios explore the potential role of limiting energy demand in net zero pathways, with potential benefits including (but not limited to): faster achievement of net zero; reducing the need for more expensive and technologically challenging mitigation measures such as H₂ fuels and direct air capture; reduced overall cost due to less need for new supply capacity. While LED pathways are in general technologically easier and have lower total cost, they are likely to be more difficult socially and politically.

Scenarios for achieving net zero GHG emissions, towards 2050 and beyond, are commonly assessed using energy system optimisation models (ESOMs), which are mathematical representations of energy systems. ESOMs are comprehensive and scaled at the local, national, regional or global level. ESOMs can be stand-alone or part of a larger model such as a global integrated assessment model (IAM). ESOMs are used to turn scenario narratives into detailed quantified techno-economic pathways to a net zero energy system, based on cost optimisation. These pathways inform policymakers about the potential impacts of different approaches to meeting climate and energy targets, and what policy options exist (Krook-Riekkola 2015; Süsser et al. 2021). Variations in pathways are driven by differences in scenario narratives.

The word “demand” is used in different ways across the energy literature. An *overall* picture of demand could be derived from: (i) Primary energy demand for solid, liquid and gaseous energy sources that either are extracted or imported to the studied region, and used throughout the energy system, e.g. to generate electricity;

(ii) Final energy demand, which is the energy commodities delivered to the end users; users use the energy for creating energy services (i.e. not another energy commodity), e.g. electricity, district heating or some kind of fuel (e.g. natural gas, H₂, ammonia and synthetic fuels); and (iii) Energy services demand (ESD), which is the societal needs either as a service or as goods (in variable units related to the service). In ESOMs, demand is usually represented with ESD as a model input where final energy demand is a model output. Whereas models that only cover the electricity sector typically use final demand as a model input. Consequently, ESD can identify the underlying mechanisms driving each specific type of final demand, such as transport using vehicles (bottom up), or by using ESD projections from sources such as government studies. In many TIMES models (Loulou et al. 2016), for example, ESD in buildings, transport and industry are introduced via exogenous demand projections for the analysed model horizon. Adjustments to ESD can be made by changing the underlying model mechanisms and assessing how these impacts demand, or by increasing or decreasing exogenous projections by a certain percentage. Measures to reduce demand through behavioural change or structural change are rarely included in the model's objective function.

ESOMs primarily focus on techno-economic factors and do not explicitly represent social aspects of energy transition in much detail or depth; those ESOMs that do consider social aspects primarily do so through exogenous assumptions (Krumm et al. 2022). Inclusion of energy justice and fairness dimensions is rarely done, although it is being increasingly added (Vågerö and Zeyringer 2023). ESOMs are sometimes soft-linked to smaller simulation models of a single sector such as transport or buildings, with modelling methods such as agent-based modelling (Bale et al. 2015) and system dynamics (Papachristos 2019). These smaller models provide better representation of heterogeneity and complex system responses within particular sectors, without having to add more complexity to a national or global model. ESOMs can also be linked with CGE models, allowing alignment of demand with the economy (Labriet et al. 2015; Krook-Riekkola et al. 2017).

This chapter reviews published LED studies from a novel angle, namely the way they treat social issues like fairness, feasibility and the potential impacts on the SDGs. This chapter reviews published LED studies to assess which SDGs could be impacted by LED narratives and in which ways. The study was initiated through a series of IEA-ETSAP funded workshops that benefited from attendance and written contributions from over 30 participants (see Acknowledgments). The following steps were taken.

1. A set of 11 LED scenarios are reviewed and the following core characteristics are compared: (i) LED scenario narrative, (ii) scenario modelling approach, (iii) LED mitigation measures in the pathway, (iv) modelled demand reductions, (v) overall benefits from LED. The characteristics vary depending on the purpose and scope of the scenario, the optimisation approach, and the ambition of the LED narrative.
2. LED scenarios narratives are described, along with methodologies used to translate them into modelled pathways. Differences in the boundaries adopted for creating narratives and for modelling are observed, illustrating a lack of clarity.

These differences could be resolved through including more explicitly in ESOMs the drivers needed to achieve LED, and/or providing more detail in LED narratives about which types of measures would be the least disruptive to society and people's access to various energy services.

3. LED scenarios are reviewed for their potential societal impacts in OECD countries. In theory, achieving LED has the potential to decrease energy fairness, relative to current conditions—although impacts from demand reductions will vary for different types of societal actors and under different economic conditions. Additionally, there is high uncertainty about the feasibility of implementing LED pathways since there is little historical evidence of the types of demand changes envisioned in LED scenarios being enacted.
4. The potential impacts of feasibility and fairness concerns related to LED scenarios are applied to a set of selected SDGs that are relevant for OECD member countries currently transitioning towards net zero. The impacts on SDGs can include both benefits and disbenefits, depending on how the LED scenarios are achieved through policies and choice of mitigation measures.

2 Review of Published LED Scenarios

2.1 Scenarios Overview

Table 1 presents highlights from a set of 11 published LED scenarios. Of key interest to this study are the LED narratives, the types of modelling, how energy service demand (ESD) is included in models, and the documented benefits of the LED scenario approach. The choice of which LED studies to include in this study was made by doing a scan of the literature from within and outside the ETSAP community, then selecting a set of LED scenarios that represents the leading approaches at three levels of scale: global, continental/EU and national. LED modelling studies for five OECD countries were included to represent a diversity of conditions for decarbonisation and content focus (sector, energy system, integrated covering all GHG) but staying within the focus on OECD countries. Some of the LED studies include multiple pathways with varying degrees of avoid, shift and improve type interventions (Creutzig et al. 2018). The most ambitious and transformative scenarios from each of the 11 LED scenario publications were selected for analysis.

The LED scenario characteristics presented in Table 1 illustrate how much variety there is in scenarios considered to be LED. This is largely due to the varying geographical areas covered, modelling teams, models used, and purpose of each study. Most studies use established models and introduce exogenous changes to achieve modelling of a LED scenario. The UK CREDS study goes further, introducing methodological novelty by soft linking a TIMES model with several sectoral-level models that are more suitable for modelling demand in detail. Regarding the guiding narrative for modelling, some scenarios focus predominantly on changes to energy demand through efficiency and/or economic changes (e.g. Norway LOW,

Table 1 Summary of reviewed LED scenarios

Scenario name, model name, sources	Type of modelling	LED scenario narrative	Overall benefits from LED
Global IIASA (LED): (Grubler et al. 2018; McCollum et al. 2017, 2020; IIASA 2018)	MESSAGEix-GLOBIOM—global integrated assessment modelling of climate change drivers and impacts. ESD is Exogenous	The Low Energy Demand scenario includes rapid social and institutional changes in how energy services are provided and consumed. Less reliance on stringent climate policy than comparable low-emission scenarios. Strongly focused on energy end-use and energy services.	Downsizing the global energy system dramatically improves the feasibility of a low-carbon supply-side transformation; the scenario meets the 1.5 °C climate target as well as many SDGs without relying on negative emissions technologies (NETs).
Global IEA (NZE): (International Energy Agency 2021)	Hybrid approach, combining WEM (simulation model that replicates competitive energy markets) and ETP (large-scale, partial-optimisation, technology model). ESD is endogenous	The Net-Zero Emissions by 2050 Scenario (NZE) is designed to show what is needed across the main sectors for the world to achieve net zero CO ₂ emissions by 2050.	In the NZE pathway, by 2030 the world economy is 40% larger but uses 7% less energy. There is a major worldwide push to increase energy efficiency. Energy intensity improvements are three times higher than in the last two decades.
Global IMAGE (SSP1): (Bauer et al. 2017; van Vuuren et al. 2017; Riahi et al. 2017)	IMAGE. Global integrated assessment modelling of climate change drivers and impacts. ESD is Exogenous	SSP1 includes sustainable consumption patterns; fast energy efficiency improvements; rapid deployment of renewable energy; economic activity decouples from energy demand; lifestyle changes; social acceptability is low for all technologies except non-biomass renewables.	Challenges to mitigation in SSP1 are low, including consumption patterns, technological change, fossil fuel availability and efficiency improvements. SSP1 assumes decoupling of economic growth and energy demand, achieved by increasing energy efficiency and renewables.
EU CLEVER: (Bourgeois et al. 2023)	Set of modelling tools covering different sectors; ESD is Exogenous	The CLEVER (Collaborative Low Energy Vision for the European Region) narrative combines sufficiency, efficiency, and renewables. It adds representation of the	The CLEVER scenario reaches climate neutrality in 2045, with rather conservative assumptions on GHG sinks, and a 93% decrease in net GHG emissions.

(continued)

Table 1 (continued)

Scenario name, model name, sources	Type of modelling	LED scenario narrative	Overall benefits from LED
		potential for sufficiency and innovation in energy practices.	
Germany LED: (Eerma et al. 2022)	AnyMOD.jl: based linear cost minimising, bottom-up planning model; ESD is Exogenous	The scenario “societal commitment” aims for a strong change of behaviour towards a sustainable lifestyle. The potential for demand reductions based on behavioural changes in the heat, mobility and electricity sectors are estimated based on an extensive literature review.	Behavioural changes achieve total system cost savings of up to 26% and reduce required generation and storage capacity by 31% and 45%, respectively, in the High Ambition scenario.
Ireland LED: (Gaur et al. 2022)	TIMES Ireland. ESD is Exogenous	The Low Energy Demand scenario includes ESD being decoupled from economic growth by shifting travel modes, increasing end-use efficiency, densifying urban settlement, focusing on low-energy intensive economic activities, and changing social infrastructure.	Compared to a business-as-usual growth scenario, steep decarbonisation targets are achieved with a less rapid energy system transformation, lower capital and marginal abatement costs, and with lower reliance on the deployment of novel technologies.
Netherlands LED: (Scheepers et al. 2020)	OPERA energy system planning model; ESD is Exogenous	The Transform scenario describes transformative systemic change, including high awareness and behaviour change, individual and collective action, ambitious government, and company policies.	Total system costs in the TRANSFORM scenario are substantially lowered, compared to the other scenario ADAPT, due to lower energy demand, decreasing technology costs and no CCS.
Nordic CNB: (Wråke et al. 2021)	Nordic TIMES; ESD is Exogenous	The Climate Neutral Behaviour (CNB) scenario reflects Nordic societies adopting additional energy and material efficiency measures in all sectors,	Behavioural change buys time for the transition, reduces pressure on biomass resources, reduces costs of infrastructure expansion. Total system costs are 10%

(continued)

Table 1 (continued)

Scenario name, model name, sources	Type of modelling	LED scenario narrative	Overall benefits from LED
		ultimately leading to lower demand for both.	lower in CNB compared to a scenario considering current national plans, strategies, and targets.
Norway LOW: (Rosenberg et al. 2015)	Norway TIMES; ESD is Exogenous	The LOW activity scenario assumes higher electricity process, with decreased energy demand of industry, the possibility to invest in energy efficiency measures, and decreased transport demand.	In the LOW scenario, net power trade is highest due to decreased domestic energy demand and increased power production. Domestic electricity use is increased rather than exported. Higher economic activity is achieved without a net import of electricity.
UK CREDS LED: (Barrett et al. 2021, 2022)	UK TIMES plus 5 sectoral models (mobility, nutrition, shelter, non-res buildings, materials, and products); ESD is soft linked with sector models	There are two LED scenarios. The “transform demand” scenario has transformative changes in technologies, social practices, infrastructure, and institutions to deliver reductions in energy.	Energy demand reductions lead to less reliance on high-risk carbon dioxide removal technologies, only moderate investment requirements and more space for ratcheting up climate ambition.
UK Transport (LSEV): (Brand and Anable 2019; Anable et al. 2012)	MARKAL MED; UKTCM; STEAM; ESD is soft linked to sector model with energy demand elasticity	In the Combined lifestyle and EV scenario (LSEV), radical changes in travel patterns and travel mode choices lead to relatively fast transformations and new demand trajectories, along with high EV adoption and petrol/diesel phase-out.	Meeting legislated carbon budgets can be achieved by combining radical changes in travel patterns, mode and vehicle choice, vehicle occupancy and on-road driving behaviours, and fast electrification of vehicles.

Ireland LED, Global IEA), while others envisage transformative societal changes that reduce demand (e.g. UK CREDS, Global IMAGE SSP1, Netherlands LED). EU CLEVER presents a novel theoretical approach, using a holistic narrative that combines sufficiency, efficiency and renewables; it achieves the quickest net zero transition of the five national studies. Germany LED models demand reductions from behavioural changes derived from a literature review, giving the narrative a grounding in evidence.

In all the 11 studies, high demand reductions enable meeting net zero targets in time. Indeed, the UK CREDS study finds that ambitious climate targets can *only* be achieved when demand is reduced, compared to a reference scenario. All of the LED scenarios show additional benefits to meeting emissions reduction targets, such as reducing total system costs (UK CREDS, Norway LOW, Nordic CNB, Ireland LED, Netherlands LED), avoiding the need for negative emissions technologies (Global IIASA, EU CLEVER, UK CREDS), buying more time for the transition (Nordic CNB), and achieving high rates of decoupling between economy and emissions (Global IEA, Global IMAGE SSP1). The reviewed scenarios indicate, overall, that the LED approach holds potential for OECD countries to significantly improve the likelihood of achieving their targets, reduce the need for novel and complex technologies, and reduce the total cost of the net zero transition.

2.2 Demand Mitigation Measures

The potential for demand reductions by measure varies considerably by many factors, including: the existing make up of demand side technologies and infrastructure, the types of measures to be applied in each sector, the availability of replacement technologies for mass deployment over time, and the local geography and climate which affects the suitability of measures. It was not possible to determine the relative importance of each measure to achieving annual demand reductions from the review of scenario publications. The precise definitions of the LED scenario pathways—if available at all—differ between studies and therefore do not allow consistent comparison.

The 11 LED scenarios include a wide variety of demand mitigation measures. These can be classified, broadly, as “avoid” (avoiding the demand for energy services), shift (shifting to more efficiently provided energy services), or “improve” (improving the efficiency of end-use technologies and buildings)—as defined in (Creutzig et al. 2018). All the measures reduce total demand, although it should be noted that in Global IIASA LED and Global IEA NZE there are increases in demand in some sectors and end uses. The measures included in the 11 LED scenarios were identified, from the publication sources, and analysed according to types defined by Creutzig et al. (2018). The type allocations were done by the authors, based on knowledge of how the measures are achieved.

Avoid measures are generally very low cost, perhaps saving money for consumers, but the potential for demand savings from avoid type measures is limited since some energy services will always be needed. Thermostats can be lowered in winter but there is a minimum amount of heat needed. The following measures from the LED scenarios were categorised as avoid: car/trip sharing, telework/shorter working week, less freight (as international shipping and aviation, road freight), generic reduction of transport passenger-km, lower speed limit for transport, lower indoor room temperature, reduced living space area, reduced hot water consumption, and reduced office space area.

Shift measures are a crucial part of demand reduction for particular end uses that require sectoral structural changes and can enable deeply transformational changes in demand patterns. They can depend on there being supporting changes in infrastructure such as the building of new public transport networks or the availability of goods with lower environmental impact. The following measures from the LED scenarios were categorised as shift: modal shift passenger transport, modal shift freight transport, lower demand for energy-intensive commodities, alternative production processes in manufacturing (inc. fuel switch), longer-lasting products, and a shift to less energy-intensive sectors in an economy.

Improve measures are the most common type and are the standard type in both transformative scenarios such as EU CLEVER and SSP1, and in the less transformative, more technology focused scenarios. Improve measures have more potential for demand reduction than avoid or shift measures as they can rely on technological changes in end use equipment that are like-for-like replacements (or at least similar-use equipment such as electric vehicles replacing combustion vehicles) and thus are more likely to be widely adopted or even mandated through regulation. In Global IEA NZE, for example, transport electrification contributes to a large share of energy demand reduction in transport compared to shift type interventions like modal shift. The following measures from the LED scenarios were categorised as improve: transport electrification or other fuel switch, efficiency improvement freight transport, smaller cars, buildings renovations, reduced electricity consumption for appliances, demand reduction for heating and cooling, urban planning and densification, heating electrification, smart heating, recycling, alternative materials in construction, efficient technologies, material efficiency, dematerialisation.

Figure 1 illustrates the number of different types of demand mitigation measures in the selected scenarios according to their avoid-shift-improve classification. The overall share of measures is 40% as improve, 35% as avoid, 25% as shift. A broad comparison of total demand reductions in each scenario with the number of measures finds no correlation. It is notable, however, that the two studies with the most methodological innovation and intention to improve modelling of transformative scenario narratives, UK CREDS LED and EU CLEVER, include the most variety of measures.

2.3 Impacts of LED Scenarios

Figure 2 presents a summary of impacts on final energy demand from the reviewed scenarios as changes in final energy consumption in 2050 compared to the baseline year (where data is available). The baseline year is 2020 for all the studies reviewed, except for Netherlands LED for which it is 2030. This approach allowed a consistent comparison between the different LED scenarios. Data for IMAGE SSP1 is an analysis of data downloaded from USS data download facility for IMAGE 3.0 (Stehfest et al. 2014), for Western Europe, scenario SSP1 SPA1 RCP 1.9. Four scenarios (Global IASA LED, Global IMAGE SSP1, EU CLEVER and UK

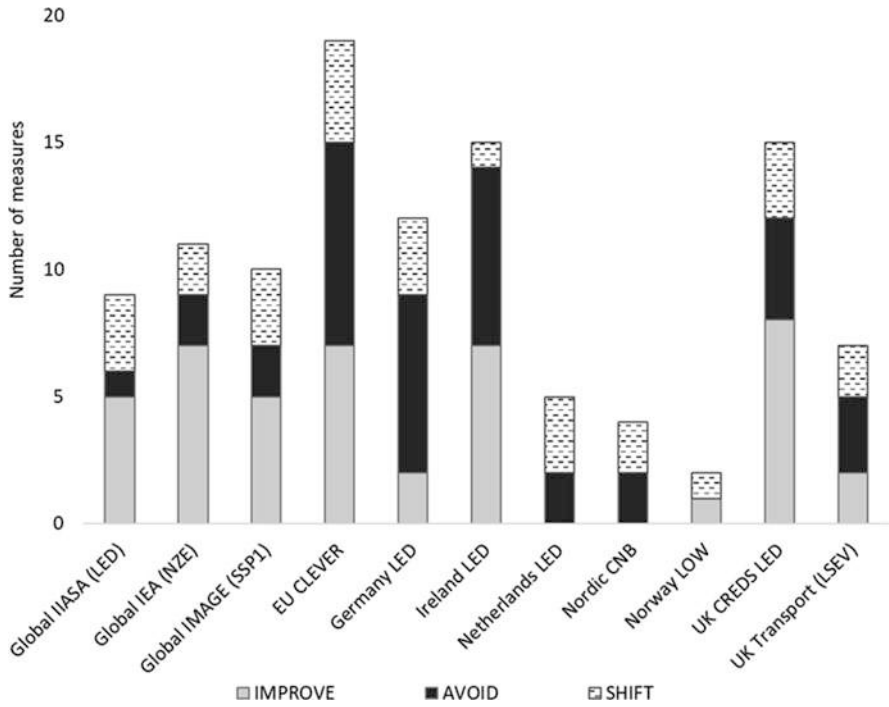

Fig. 1 Count of demand mitigation measures included in LED scenarios, as AVOID, SHIFT, or IMPROVE

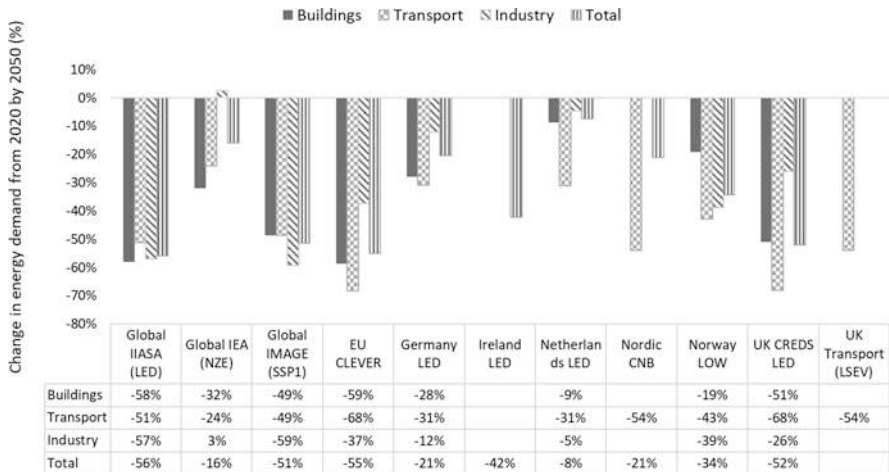

Fig. 2 Demand impacts in selected LED scenarios; percentage change in demand between 2020 and 2050, by sector and overall (where data available)

CREDS LED) achieve a more than 50% reduction in total demand, while UK Transport (LSEV) achieves a 54% reduction in the transport sector (in which has historically been difficult to reduce demand). Without calling into doubt the methodology of the reviewed studies, considering past and current patterns of demand in most countries, a more than 50% reduction in demand within 30 years seems unlikely to be achievable.

The demand impacts shown in Fig. 2 rely on many modelling assumptions. Baseline assumptions are indicators for socio-demographics and economic development and estimates of potential demand savings by measure. Socio-economic assumptions used in global scale LEDs are generally in line with business-as-usual projections, with minor differences. For example, a projection for global population of 9 billion by 2050 in Global IASA LED compared to 9.8 billion in Global IEA NZE. The five national studies also take business as usual projections for population and economic growth, which are typically medium growth estimates from national statistics offices. The much higher demand reductions in the modelled LED pathways are achieved principally through including a wider range of the demand reducing measures described in Sect. 2.2, and/or a higher uptake of those measures. In other words, none of the reviewed LED scenarios assume that lower demand can be achieved through population decline or economic recession.

3 The Feasibility and Fairness of LED Scenarios

There are many, many factors that are already influencing, and will continue to influence, the feasibility of modelled pathways, at the scale of nations, global regions, and globally. For LED scenarios in particular there are four key issues: (i) the economic ability of countries to fund the transition especially in transforming mass consumer technologies, (ii) the ability of those governing the transition to guide it effectively, (iii) whether the expected rate of progress in commercialising and deploying new technologies will be realised, and (iv) societal ability and willingness to implement measures to reduce demand—in particular, shift and avoid measures. LED studies are generally quite limited in addressing the feasibility and fairness aspects of scenarios; however, these issues are particularly important for implementing LED scenarios. Additionally, feasibility and fairness are related, since if policies are, or are felt to be, unfair then there will be less willingness of the public to make them happen, reducing feasibility. We examine here three issue of particular importance for modelling LED scenarios.

3.1 *The Economy and the Rebound Effect (Feasibility)*

3.1.1 Demand and the Economy

It could be argued that LED and economic growth are generally counteractive to each other, since historically the two have been very tightly coupled. A look at historical demand patterns will illustrate that when there are serious economic downturns there are simultaneously decreases in energy demand. However, looking forward, this is not the case in several of the LED narratives. In the EU CLEVER narrative, *'sufficiency proposes a restructuring of society that, when combined with efficiency measures and renewables deployment, has...been shown to increase employment in the long term'* (Bourgeois et al. 2023)—however, this is more of a qualitative statement than an outcome of analysis. The SSP1 narrative envisions *'the emphasis on economic growth shifts toward a broader emphasis on human well-being'* (Riahi et al. 2017). Results of modelling the Shared Socioeconomic Pathways (SSPs) show income levels in the USA (as sample OECD country) growing faster in SSP1 compared to “middle of the road” SSP2 (Dellink et al. 2017); however, this is dependent on exogenous inputs to the scenarios and not a modelled outcome of the future economic implications of a LED scenario. The relationship between LED and economic growth being considered in a positive way in the LED narratives, with expectations that the two are compatible, is a strong departure from the past. In the context that the need to decarbonise is well established across the world, and the LED approach is economically less risky than a high-tech approach, this makes sense. There are also innovations associated with LED that could benefit the economy as a whole, including urban densification, digitization, sharing and circular economies, energy efficiency, environmental awareness, energy independence, and local manufacturing.

A way to improve modelling would be to put in feedback between demand and the economy. In theory, part of the outcomes from LED scenarios should be that significant decoupling between economy and demand is achieved, and so this dynamic is an important part of modelling LED scenarios. Linking ESOMs with macro-economic models by modelling feedback between them is one approach, as proposed in (Krook-Riekkola et al. 2017; Andersen et al. 2019; Crespo del Granado et al. 2018). One example of this method is in (Glynn et al. 2015); however this models economic impacts from climate policies rather than LED policies. Since the precise impacts on the economy from reducing demand are currently not well understood, they are difficult to capture in a macro-economic model. In addition, macro-economic models do not, in general, capture changes in cost structure such as for cost intensive measures that reduce demand; models tend to “overconsume” these services requiring manual model adjustments (Krook-Riekkola et al. 2017).

3.1.2 The Rebound Effect

A significant complication in understanding and modelling demand reductions is the rebound effect. The rebound effect reduces expected savings from efficiency improvements (Stapleton et al. 2016; Freeman et al. 2015); as energy services become more affordable through improved efficiency, supply-demand economics means that there is increased demand for energy services and so savings are reduced. At a macroeconomic level, the rebound effect can act as a “fuel” for economic growth, with its associated growth in use of resources (Ayres and Warr 2009). An analysis of the impact of social trends on energy demand found that in the worst case, the rebound effect from new societal trends could lead to an increase in energy consumption of 40% (Brugger et al. 2021). The rebound effect could act against the demand changes envisaged in LED scenarios.

Most ESOMs acknowledge the rebound effect but its representation in models, including its potential solutions, is generally weak. This is partly due to a lack of relevant research: *‘understanding the macro-level rebounds of demand-led transitions, and their negation, is an important avenue for further work and policy development’* (Barrett et al. 2022). Of the 11 reviewed LED scenarios, several do not mention the rebound effect at all. EU CLEVER makes rebound an important topic: *‘rebound effects and upward consumption trends attest to the fact that efficiency alone cannot realise all of Europe’s resource savings potential’* (Bourgeois et al. 2023). UK CREDS LED mentions its importance: *‘avoiding increased energy demand due to rebound effects requires policies that ensure optimised and shared use of energy services and technologies’* (Barrett et al. 2021). Global IIASA LED calls the rebound effect the “elephant in the room”. A possible starting point for introducing the rebound effect is by adding simple adjustment factors that reduce expected savings from energy efficiency, from published studies of the rebound effect for particular technologies and sectors. A more dynamically responsive way would be to introduce a feedback mechanism that represents the causes of the rebound effect and how it changes over time, as proposed in (Guzzo et al. 2023).

3.2 Price Elasticity (Fairness)

In general, ESD tends to increase along with energy affordability and GDP. Decoupling demand from these factors by more than a few percent is in theory achievable but in practice has rarely been observed except due to economic restructuring in countries that deindustrialise and move to service economies. Measures with the least uncertainty, partly due to there being the most historical evidence, are improve type measures such as energy efficiency, electrification of vehicles, and building renovations, which also impact the lifestyles of people the least. There is a lack of historical evidence that shift and avoid type measures

included in LED pathways are achievable at the mass implementation level expected in LED scenarios.

There are growing concerns that energy transition could reduce the affordability and access to energy services in developed regions. *'Carbon mitigation strategies that neglect any social, geopolitical, and macro-economic considerations, are likely to exacerbate labour market inequalities. . . national and region-specific disparities will result in deeper social divisions'* (Patrizio et al. 2020). The lifestyle changes envisaged in LED scenarios may be, or may be perceived to be, unfair depending on how they are achieved. If LED pathways are in fact particularly unfair in their practical implementation, there is likely to be a public backlash against policies (Patterson 2023) and insufficient willingness and/or ability of societal actors to implement the required changes in the LED pathway (Freeman and Pye 2022; Stern et al. 2022).

One mechanism for provoking society to adopt shift and avoid measures is through energy pricing. In many ESOMs the price elasticity of demand is used to dynamically model changes in demand, including in TIMES (Loulou and Labriet 2008). In practice, price elasticities vary considerably, depending on variables such as fuel type, the maturity of technologies, types of actors by demographics or income level, and the timeline (short or long term). Thus, when modelling the effects of price elasticity it is important to have accurate elasticity values, and to represent enough heterogeneity in the model to reflect the different effects of real-world price elasticities. Example price elasticity studies include (Patankar et al. 2022; Salvucci et al. 2018; Daly et al. 2014; Labandeira et al. 2017). Price elasticities tend to be used in more detailed sector models, and are used in the UK Transport LSEV model but not in others in our set of 11. A lack of representation of the variability in price elasticity across society could mean that modelled LED pathways are insufficiently realistic. Price elasticity is also related to fairness, since policies that use it to reduce demand, such as carbon pricing, are regressive (Nemet and Greene 2022), negatively affecting lower income groups disproportionately.

3.3 *Model Boundaries (Methodology)*

Many IAM scenarios are *'conservative with respect to their assumptions on demand-side transformations. . . suggesting that the power of demand-side changes might be underexplored'* (Brutschin et al. 2021). Partly this is because of the difficulty of modelling innovation to support a LED future, which can include *'many heterogeneous adopters; small granular scale, many iterations; local system integration; and rebound effects'* (Nemet and Greene 2022)—changes which do not fit easily within linear techno-economic models. The energy service cascade (ESD) (Kalt et al. 2019) is a conceptual framework that describes the whole energy chain, and it is useful for examining the role of model boundaries in modelling LED scenarios. Table 2 shows the five elements of the ESC and how they are typically included in LED scenario narratives and ESOMs.

Table 2 The energy service cascade (ESD) and scenario narratives, models, and demand mitigation measures

ESD elements (this column adapted from (Kalt et al. 2019))	Typical inclusion in LED scenario narratives	Typical inclusion in ESOMs
Biophysical and societal structures related to energy conversion chains : natural resources, socio-technical structures, governance structures.	Transformative narratives may envisage socio-technical and governance structures significantly different to those of today.	Structures are represented as economic structure, data on biophysical resources, and governance structure through energy policies. LED measures (e.g. SHIFT measures that enable modal shifts in transport) usually included in model objective function.
Functions : physical actions performed by the energy chain. The relationships between inputs and outputs. E.g. accelerating a vehicle, transmitting thermal energy to a living space. Measurable in physical units but not necessarily energy units.	Usually not described in detail although implied through narratives about different types of fuel switching, electrification, etc.	Represented by data on end-use technologies that perform functions. E.g. types of vehicles that convert final energy into acceleration and motion. Efficiency limits for functions may need to be included (Cullen and Allwood 2010). LED measures (e.g. technology shift, efficiency improvements) sometimes included in model objective function.
Services : what is actually demanded. Services enhance wellbeing but are not identical to wellbeing contributions. A service is only a service if a human beneficiary can be identified.	Narratives often include descriptions of societal demand for services within a larger response to climate change, defined as increases/decreases on a baseline level of service demand.	Model optimisation calculations meet services demand and climate targets at least-cost. Some models include energy price elasticity of services demand. Services examples: travel (pkm/year), floor space (m ² /cap), production of steel (tons/year). LED measures (e.g. reduce services demand, shifting to different energy services) rarely included in model objective function.
Benefits : contribution to aspects of wellbeing. Benefits are the outcome of services, for example, thermal comfort in indoor spaces which contributes to wellbeing, or artificial light which enables activity after sunset such as reading.	Sufficiency is related to benefits, used to define ‘sufficient service demands’ (Bourgeois et al. 2023), and to represent a reasonable minimum consumption level, (Cordroch et al. 2022; Zell-Ziegler et al. 2021; Best et al. 2022; Arnz and Krumm 2023).	Not usually included in ESOMs, but could be included as interventions to reduce energy wastage, so that benefits and services are in line and demand projections are therefore reduced. LED measures (e.g. reducing energy waste, price

(continued)

Table 2 (continued)

ESD elements (this column adapted from (Kalt et al. 2019))	Typical inclusion in LED scenario narratives	Typical inclusion in ESOMs
		responsive demand, active travel) not included in objective function.
<p>Values: individual attitudes, preferences and habits about how benefits are valued, that influence the demand for an energy service. Social groups' perceptions and actions are shaped by shared meanings, heuristics, rules of thumb, routines and social norms (Geels et al. 2018).</p>	<p>Values can be included as a description of general societal attitudes to sustainability and consumption. For example, the relative value given to tackling climate change, ecosystems, material wealth, employment, economic growth, etc.</p>	<p>Not usually included explicitly. In economic terms, values translate into 'willingness to pay for energy services' (Patankar et al. 2022) and climate change mitigation. LED measures (e.g. adjusting societal expectations about what is a "normal" level of ESD in daily practices) not included in objective function.</p>

LED narratives tend to cover more of the ESC than the ESOMs which are used to model the narratives. In particular, the values and benefits part of the ESC are a key part of the more transformative LED narratives, yet these are not directly included in ESOMs as drivers. Differences in the boundaries adopted for narratives and for modelling show a lack of consistency in the process of describing and the modelling LED scenarios. Some essential parts of the narratives are missing in the modelling, which reduces how well the models represent the real-world future described in the LED narratives. Suggestions for improving LED scenario modelling include adding the more subjective aspects (e.g. benefits and values) as model inputs in the form of bespoke indicators influencing society's willingness to change behaviours, or evaluating the fairness of LED pathways off-model. The need for methodological development in modelling is highlighted in (Grubler et al. 2018): '*low energy demand outcomes depend on social and institutional changes that reverse the historical trajectory of ever-rising demand. How these can be endogenously represented in modelling studies remains a critical, multidisciplinary research agenda*'. Of the 11 reviewed LED scenarios, only UK CREDS and EU CLEVER include some methodological developments in line with the call from Grubler et al. for endogenously including social and institutional changes.

4 Impacts of LED Scenarios on SDGs

In this section, the discussion of LED scenarios from the previous sections is applied to a set of selected SDGs that are relevant for OECD member countries transitioning towards net zero. The selected SDG's targets and indicators are presented along with

potential benefits and disbenefits from the LED approach, in a high-level and largely theoretical discussion. The following three assumptions are made as a basis for the discussion: (i) The starting point for OECD countries in 2020 is that they are industrialised and have mature and (generally) reliable and affordable energy supply and distribution. (ii) All OECD countries have established some kind of climate change emissions reduction target (usually net zero by 2050) and will stay committed to achieve it up to 2050 and beyond. (iii) Should the LED approach be adopted by countries, the process of emissions reductions will have a noticeable effect on some of the SDG targets; however, the size and direction of these effects will be affected by a wide range of physical and economic constraints, and the strategies used to pursue the LED approach.

4.1 SDG 1.2: Poverty

Target Reduce at least by half the proportion of people living in poverty (UN World Data Forum 2023).

Indicator 1.2.1 Proportion of population living below the national poverty line (UN World Data Forum 2023).

LED Alignments with SDG If LED policies are done well, such as through mass installation of energy efficiency measure and providing energy services in more efficient ways, household and business expenditure on energy would be reduced and fewer people would be in poverty due to high expenditure on energy.

LED Misalignments with SDG If regressive taxes that rely on energy price elasticity are used to reduce demand or encourage electrification, energy affordability will decline—although perhaps temporarily. Prices of goods and services could increase as a secondary effect of the cost of net zero to the country, forcing more people into fuel poverty. Feedback between economy and demand could force the economy into recession should demand decline quickly, leading to loss of jobs.

4.2 SDG 7.1: Access to Energy

Target Ensure universal access to affordable, reliable and modern energy services (UN World Data Forum 2023).

Indicators 7.1.1 Proportion of population with access to electricity, 7.1.2 Proportion of population with primary reliance on clean fuels and technology (UN World Data Forum 2023).

LED Alignments with SDG In the longer term, a LED approach would reduce the total cost of reaching net zero compared to non-LED scenarios, meaning

lower retail energy prices. Decarbonisation could improve energy security for countries and regions if domestic generation with renewables replaces fuel imports. Digitalisation such as smart meters and smart grid could improve reliability of supply and provide more options for consumers to participate in flexibility markets.

LED Misalignments with SDG Transformative changes happening simultaneously across the energy system have potential to introduce new system risks and vulnerabilities that are difficult to predict or remedy. Distributed control of energy flows and distributed generation could affect the ability of system operators to maintain reliability of supply.

4.3 SDG 7.2: Renewable Energy

Target Increase substantially the share of renewable energy in the global energy mix (UN World Data Forum 2023).

Indicator 7.2.1 Renewable energy share in the total final energy consumption (UN World Data Forum 2023).

LED Alignments with SDG LED scenarios align well with this SDG as they tend to also include high levels of renewables.

LED Misalignments with SDG None.

4.4 SDG 7.3: Energy Efficiency

Target Double the global rate of improvement in energy efficiency (UN World Data Forum 2023).

Indicator 7.3.1 Energy intensity measured in terms of primary energy and GDP (UN World Data Forum 2023).

LED Alignments with SDG LED scenarios align well with this SDG target as they include high levels of ambition for energy efficiency. Energy efficiency improvements can especially benefit lower income groups, although subsidies might be needed to cover upfront costs.

LED Misalignments with SDG Programmes for energy efficiency should ensure that any efficiency improvements do not unintentionally lead to worsened energy services, as has happened in a few cases (e.g. cavity wall insulation creating damp problems in housing in the UK (Eco Experts 2022)).

4.5 *SDG 10.1: Overcoming Income Inequality*

Target Achieve and sustain income growth of the bottom 40% of the population at a rate higher than the national average (UN World Data Forum 2023).

Indicator 10.1.1 Growth rates of household expenditure or income per capita among the bottom 40% of the population (UN World Data Forum 2023).

LED Alignments with SDG If LED scenarios are achieved successfully, the net zero changes could significantly improve a country's economy and international competitiveness, leading to more employment opportunities for lower income groups.

LED Misalignments with SDG Lower income groups may have to take avoid measures to reduce demand because of tight budgets, while higher income groups can afford to implement improve and shift measures. If governance is not done well the burden of demand reduction would be placed on those who can least afford it. Lower demand could lead to negative macro-economic impacts. Declining economies would mean lower wages and/or higher prices that disproportionately impact lower income groups. The closure of fossil fuel industries will lead to job losses and negative impacts on local economies.

4.6 *SDG 12.2: Use of Resources*

Target By 2030, achieve the sustainable management and efficient use of natural resources (UN World Data Forum 2023).

Indicator 12.2.2 Domestic material consumption, domestic material consumption per capita, and domestic material consumption per GDP (UN World Data Forum 2023).

LED Alignments with SDG Most LED scenarios align well with this SDG in that lower energy demand through shift and avoid type measures would reduce the demand for the resources used in providing energy services, both material and by energy vectors.

LED Misalignments with SDG Most LED pathways include very high rates of build of new renewables capacity. If not done with effective planning, this new capacity could cause damage to ecosystems both onshore and offshore. Of particular concern are expectations of increasing supplies of biomass and the accompanying need for land, fertilisers, and water. For scenarios that include mass adoption of electric vehicles and fuel cell technologies, environmental damage is possible from mining due to the need to source increasingly large amounts of metals, and critical and rare minerals, compared to the past.

4.7 *SDG 16.7: Participatory Decision Making*

Target Ensure responsive, inclusive, participatory and representative decision-making at all levels (UN World Data Forum 2023).

Indicator 16.7.2 Proportion of population who believe decision-making is inclusive and responsive, by sex, age, disability and population group (UN World Data Forum 2023).

LED Alignments with SDG This can be achieved within LED scenarios if sufficient consultations with publics is done.

LED Misalignments with SDG There is a danger that the drive towards net zero will lead to governments mandating disruptive changes to energy services to meet ambitious net zero pathway targets, without giving those affected a voice in decision making through open and democratic processes. There are concerns about how much government could and should influence energy consumption. Ideally, some of the LED changes could be achieved through the intrinsic motivation of people, or through beneficial societal innovation in energy services (Geels et al. 2018; Bai et al. 2016).

5 Conclusions

LED scenarios are of particular importance to those planning pathways to net zero in OECD countries. LED modelled pathways typically reach net zero targets in time and at a lower total cost than more technology focused scenarios. LED scenarios can reduce the need for the more risky and expensive technological solutions such as negative emissions technologies and the use of hydrogen as an energy vector, which are included in most non-LED scenarios. However, they also require far deeper and more disruptive changes to the lifestyles of energy consumers.

Eleven LED scenarios were reviewed. High demand reductions in each scenario enable meeting net zero targets in time, and additional benefits such as reducing total system costs, avoiding the need for negative emissions technologies, buying more time for the transition, and achieving high rates of decoupling between economy and emissions. Overall, that the LED approach holds potential for OECD countries to significantly improve the likelihood of achieving their targets, reduce the need for novel and complex technologies, and reduce the total cost of the net zero transition.

LED narratives tend to cover more of the energy services cascade (Kalt et al. 2019) than the ESOMs which are used to model the narratives. In particular, the values and benefits aspects are a key part of the more transformative LED narratives, yet these are not directly included in ESOMs as drivers. Since some essential parts of the narratives are missing in the modelling, this reduces how well the models represent the real-world future described in the LED narratives. Two key issues for LED scenarios are the rebound effect, which could reduce the achievability of

deep demand reductions, and the unfairness of policies that work based on price elasticity, including carbon taxes, if not designed with this in mind. There is a need for methodological development in ESOMs (Grubler et al. 2018), which two of the 11 reviewed LED scenario studies do achieve, endogenously including social and institutional changes to support a LED pathway.

Five types of SDGs are evaluated for the potential alignments and misalignments with LED scenarios: poverty, access to energy, renewable energy, energy efficiency, overcoming inequality, use of resources, and participatory decision making. The SDGs most at risk of declining in an LED scenario are poverty, overcoming inequality, and participatory decision making. The remaining SDGs are likely to be well aligned with LED scenarios.

Acknowledgments This chapter is an output from three series of workshops, that is a part of the project “Improving the modelling of energy behaviour in TIMES models” funded by the Energy Technology Systems Analysis Program (IEA-ETSAP). In addition, Krook-Riekkola work was supported by the Formas research council [grant number 2019-01550]. The authors would like to thank other attendees at the workshops for sharing their knowledge and for valuable discussions, including Parvathy Sobha (LTU), Jonas Forsberg (LTU), Olexandr Balyk (UCC), Hannah Daly (UCC), Ankita Gaur (UCC), Connor McGookin (UCC), Andrew Smith (UCC), Vahid Aryanpur (UCC), Mark Barratt (UCL), Tiina Koljonen (VTT), Antti Lehtila (VTT), James Glynn (CGEP), Taiba Jafari (CGEP), Andrea Moglianesi (VITO), Marco Sanchez (VITO), Negar Namazifard (VITO), Erik Ahlgren (Chalmers), Kushagra Gupta (Chalmers), Maria Gaeta (RSE), Fabio Lanati (RSE), Lidia Stermieri (PSI), Kristina Haaskjold (IFE), Eva Rosenberg (IFE), Miguel Chang (IFE), Lars Even Egner (IFE), Markus Blesl (IER), Drin Marmullaku (IER), Felix Lippkau (IER), Simon Andersen (DEA), Roman Kanala (UNIGE).

References

- Anable J, Brand C, Tran M, Eyre N (2012) Modelling transport energy demand: a socio-technical approach. *Energy Policy* 41:125–138
- Andersen KS, Termansen LB, Gargiulo M, Ó Gallachóir BP (2019) Bridging the gap using energy services: demonstrating a novel framework for soft linking top-down and bottom-up models. *Energy* 169:277–293
- Arnz M, Krumm A (2023) Sufficiency in passenger transport and its potential for lowering energy demand. *Environ Res Lett* 18:094008
- Ayres RU, Warr B (2009) Energy efficiency and economic growth: the ‘rebound effect’ as a driver. In: Herring H, Sorrell S (eds) *Energy efficiency and sustainable consumption: the rebound effect*. Palgrave Macmillan UK, London, pp 119–135
- Bai X, van der Leeuw S, O’Brien K et al (2016) Plausible and desirable futures in the Anthropocene: a new research agenda. *Glob Environ Chang* 39:351–362
- Bale CSE, Varga L, Foxon TJ (2015) Energy and complexity: new ways forward. *Appl Energy* 138:150–159
- Barrett J, Pye S, Betts-Davies S et al (2021) The role of energy demand reduction in achieving net-zero in the UK. Centre for Research into Energy Demand Solutions, Oxford
- Barrett J, Pye S, Betts-Davies S et al (2022) Energy demand reduction options for meeting national zero-emission targets in the United Kingdom. *Nat Energy* 7:726–735
- Bauer N, Calvin K, Emmerling J et al (2017) Shared socio-economic pathways of the energy sector—quantifying the narratives. *Glob Environ Chang* 42:316–330

- Best B, Thema J, Zell-Ziegler C et al (2022) Building a database for energy sufficiency policies. *F1000Res* 11:1–14
- Bourgeois S, Taillard N, Balembois E et al (2023) Climate neutrality, energy security and sustainability: a pathway to bridge the gap through sufficiency, efficiency and renewables. CLEVER (A Collaborative Low Energy Vision for the European Region)
- Brand C, Anable J (2019) Lifestyle, efficiency & limits: modelling transport energy and emissions using a socio-technical approach. *Energy Effic* 12:187–207
- Brugger H, Eichhammer W, Mikova N, Dönitz E (2021) Energy Efficiency Vision 2050: how will new societal trends influence future energy demand in the European countries? *Energy Policy* 152:112216
- Brutschin E, Pianta S, Tavoni M et al (2021) A multidimensional feasibility evaluation of low-carbon scenarios. *Environ Res Lett* 16:064069
- Cordroch L, Hilpert S, Wiese F (2022) Why renewables and energy efficiency are not enough—the relevance of sufficiency in the heating sector for limiting global warming to 1.5 °C. *Technol Forecast Soc Change* 175:121313
- Crespo del Granado P, van Nieuwkoop RH, Kardakos EG, Schaffner C (2018) Modelling the energy transition: a nexus of energy system and economic models. *Energy Strateg Rev* 20:229–235
- Creutzig F, Roy J, Lamb WF et al (2018) Towards demand-side solutions for mitigating climate change. *Nat Clim Chang* 8:268–271
- Cullen JM, Allwood JM (2010) Theoretical efficiency limits for energy conversion devices. *Energy* 35:2059–2069
- Daly HE, Ramea K, Chiodi A et al (2014) Incorporating travel behaviour and travel time into TIMES energy system models. *Appl Energy* 135:429–439
- Dellink R, Chateau J, Lanzi E, Magné B (2017) Long-term economic growth projections in the Shared Socioeconomic Pathways. *Glob Environ Chang* 42:200–214
- Eco Experts (2022) The top 5 problems with cavity wall insulation. <https://www.theecoexperts.co.uk/insulation/cavity-wall-problems>
- Eerma MH, Manning D, Økland GL et al (2022) The potential of behavioral changes to achieve a fully renewable energy system—a case study for Germany. *Renew Sustain Energy Transit* 2:100028
- Freeman R, Pye S (2022) Socio-technical modelling of UK energy transition under three global SSPs, with implications for IAM scenarios. *Environ Res Lett* 17:1–8
- Freeman R, Yearworth M, Preist C (2015) Revisiting Jevons' paradox with system dynamics—systemic causes and potential cures. *J Ind Ecol* 20:341–353
- Gaur A, Balyk O, Glynn J et al (2022) Low energy demand scenario for feasible deep decarbonisation: whole energy systems modelling for Ireland. *Renew Sustain Energy Transit* 2:100024
- Geels F, Schwanen T, Sorrell S et al (2018) Reducing energy demand through low carbon innovation: a sociotechnical transitions perspective and thirteen research debates. *Energy Res Soc Sci* 40:23–35
- Glynn J, Fortes P, Krook-Riekkola A et al (2015) Economic impacts of future changes in the energy system—global perspectives. In: Giannakidis G, Labriet M, Ó Gallachóir B, Tosato G (eds) *Informing energy and climate policies using energy systems models: insights from scenario analysis increasing the evidence base*. Springer International Publishing, Cham, pp 333–358
- Grubler A, Wilson C, Bento N et al (2018) A low energy demand scenario for meeting the 1.5 °C target and sustainable development goals without negative emission technologies. *Nat Energy* 3:515–527
- Guzzo D, Walrave B, Pigosso DCA (2023) Unveiling the dynamic complexity of rebound effects in sustainability transitions: towards a system's perspective. *J Clean Prod* 405:137003
- IIASA (2018) Low energy demand database. <https://iiasa.ac.at/models-tools-data/led>
- International Energy Agency (2021) Net zero by 2050: a roadmap for the global energy sector. Paris

- Kalt G, Wiedenhofer D, Görg C, Haberl H (2019) Conceptualizing energy services: a review of energy and well-being along the Energy Service Cascade. *Energy Res Soc Sci* 53:47–58
- Krook-Riekkola A (2015) National energy system modelling for supporting energy and climate policy decision-making: the case of Sweden. Chalmers University of Technology
- Krook-Riekkola A, Berg C, Ahlgren EO, Söderholm P (2017) Challenges in top-down and bottom-up soft-linking: lessons from linking a Swedish energy system model with a CGE model. *Energy* 141:803–817
- Krumm A, Süsser D, Blechinger P (2022) Modelling social aspects of the energy transition: what is the current representation of social factors in energy models? *Energy* 239:121706
- Labandeira X, Labeaga JM, López-Otero X (2017) A meta-analysis on the price elasticity of energy demand. *Energy Policy* 102:549–568
- Labriet M, Drouet L, Vielle M et al (2015) Assessment of the effectiveness of global climate policies using coupled bottom-up and top-down models. SSRN Electron J
- Loulou R, Labriet M (2008) ETSAP-TIAM: the TIMES integrated assessment model Part I: model structure. *Comput Manag Sci* 5:7–40
- Loulou R, Goldstein G, Kanudia A et al (2016) Documentation for the TIMES model, Part I. Energy Technology Systems Analysis Programme
- McCollum D, Wilson C, Pettifor H et al (2017) Improving the behavioral realism of global integrated assessment models: an application to consumers' vehicle choices. *Transp Res Part D Transp Environ* 55:322–342
- McCollum DL, Gambhir A, Rogelj J, Wilson C (2020) Energy modellers should explore extremes more systematically in scenarios. *Nat Energy* 5:104–107
- Nemet G, Greene J (2022) Innovation in low-energy demand and its implications for policy. *Oxford Open Energy* 1:1–16
- Papachristos G (2019) System dynamics modelling and simulation for sociotechnical transitions research. *Environ Innov Soc Transitions* 31:248–261
- Patankar N, Fell HG, Rodrigo de Queiroz A et al (2022) Improving the representation of energy efficiency in an energy system optimization model. *Appl Energy* 306:118083
- Patrizio P, Pratama YW, Dowell NM (2020) Socially equitable energy system transitions. *Joule* 4: 1700–1713
- Patterson JJ (2023) Backlash to climate policy. *Glob Environ Polit* 23:68–90
- Riahi K, van Vuuren DP, Kriegler E et al (2017) The Shared Socioeconomic Pathways and their energy, land use, and greenhouse gas emissions implications: an overview. *Glob Environ Chang* 42:153–168
- Rosenberg E, Espegren KA, Holden E et al (2015) CenSES Energy demand projections towards 2050—reference path. CenSES—Centre for Sustainable Energy Studies, Norwegian University of Science and Technology (NTNU), Trondheim
- Salvucci R, Tattini J, Gargiulo M et al (2018) Modelling transport modal shift in TIMES models through elasticities of substitution. *Appl Energy* 232:740–751
- Scheepers M, Palacios SG, Jegu E, De Oliveira LPN et al (2020) Towards a sustainable energy system for the Netherlands in 2050
- Stapleton L, Sorrell S, Schwanen T (2016) Estimating direct rebound effects for personal automotive travel in Great Britain. *Energy Econ* 54:313–325
- Stehfest E, van Vuuren D, Kram T et al (2014) Integrated Assessment of Global Environmental Change with IMAGE 3.0. Model description and policy applications. PBL Netherlands Environmental Assessment Agency, The Hague
- Stern PC, Dietz T, Nielsen KS et al (2022) Feasible climate mitigation. *Nat Clim Change* 13:12–14
- Süsser D, Ceglaz A, Gaschnig H et al (2021) Model-based policymaking or policy-based modelling? How energy models and energy policy interact. *Energy Res Soc Sci* 75:101984
- UN World Data Forum (2023) Global indicator framework for the Sustainable Development Goals and targets of the 2030 Agenda for Sustainable Development
- Vågerö O, Zeyringer M (2023) Can we optimise for justice? Reviewing the inclusion of energy justice in energy system optimisation models. *Energy Res Soc Sci* 95:102913

- van Vuuren DP, Stehfest E, Gernaat DEHJ et al (2017) Energy, land-use and greenhouse gas emissions trajectories under a green growth paradigm. *Glob Environ Chang* 42:237–250
- Wråke M, Karlsson K, Kofoed-Wiuff A et al (2021) Nordic clean energy scenarios; Solutions for Carbon Neutrality. Nordic Energy Research, Oslo
- Zell-Ziegler C, Thema J, Best B et al (2021) Enough? The role of sufficiency in European energy and climate plans. *Energy Policy* 157:112483

Open Access This chapter is licensed under the terms of the Creative Commons Attribution 4.0 International License (<http://creativecommons.org/licenses/by/4.0/>), which permits use, sharing, adaptation, distribution and reproduction in any medium or format, as long as you give appropriate credit to the original author(s) and the source, provide a link to the Creative Commons license and indicate if changes were made.

The images or other third party material in this chapter are included in the chapter's Creative Commons license, unless indicated otherwise in a credit line to the material. If material is not included in the chapter's Creative Commons license and your intended use is not permitted by statutory regulation or exceeds the permitted use, you will need to obtain permission directly from the copyright holder.



Implications of the Net Zero Transition Scenarios on SDG Indicators: Linking Global Energy System, CGE and Atmospheric Source-Receptor Models



Maksym Chepeliev, George Giannakidis, Amit Kanudia,
and Dominique van der Mensbrugge

Abstract This study contributes to a better understanding of synergies and trade-offs between climate mitigation and sustainable development goals, covering 17 indicators across various SDGs. Our assessment employs a multi-model framework, which includes a global computable general equilibrium model (ENVISAGE), an energy system model (KINESYS) and an atmospheric source-receptor model (TM5-FASST). This combination of modeling tools allows us to provide a detailed representation of the energy-related SDG indicators while accounting for their interactions with climate mitigation and socio-economic dimensions. We find that out of 17 analyzed SDG indicators, seven experience co-benefits from implementing mitigation efforts (including improved environmental footprints, energy efficiency and clean energy), six SDG indicators are subject to trade-offs (energy and food affordability, economic growth and labor participation), while the remaining four SDG indicators show mixed trends (distributional aspects and energy diversity). The identified trade-offs could be substantially reduced through specific policy solutions. We find that if the revenue collected from carbon pricing is recycled via reductions in factor taxes in selected low-carbon activities, as opposed to lump-sum payments to households, 11 out of 13 SDG dimensions analyzed in this regard would improve—reducing energy prices, increasing the share of renewable energy, improving distributional outcomes and decreasing welfare losses. In addition, we showcase the need for properly capturing interactions across various SDG dimensions by monetizing the co-benefits from improved air quality. We find that such co-benefits outweigh

M. Chepeliev (✉) · D. van der Mensbrugge
Purdue University, West Lafayette, IN, USA
e-mail: mchepeli@purdue.edu; vandermd@purdue.edu

G. Giannakidis
MRC Energy Consultants & Advisors Greece, Marousi, Attiki, Greece
e-mail: ggiannakidis.gg@gmail.com

A. Kanudia
KanORS, Noida, India
e-mail: amit@kanors.com

© The Author(s) 2024

M. Labriet et al. (eds.), *Aligning the Energy Transition with the Sustainable Development Goals*, Lecture Notes in Energy 101,
https://doi.org/10.1007/978-3-031-58897-6_3

mitigation costs by more than a factor of two, thus changing trade-offs earlier identified for the case of economic growth into synergies. A higher ratio of air quality co-benefits relative to mitigation costs observed for developing countries could also lead to reductions in between-country inequality.

Key Messages

- Linking global energy system, economic and air pollution models allows identifying important synergies and trade-offs across various SDG dimensions and across climate mitigation scenarios.
- Out of 17 analyzed SDG indicators, 7 experience co-benefits from implementing mitigation efforts, 6 indicators are subject to trade-offs, while the remaining 4 indicators show mixed trends.
- Recycling carbon revenue via reduced factor taxes, as opposed to lump-sum payments to households, could improve 11 out of 13 SDG dimensions analyzed in this regard.
- Monetized co-benefits from improved air quality outweigh mitigation costs by more than a factor of two, thus changing trade-offs for the case of economic growth into synergies.

1 Introduction

Mitigation of climate change is widely recognized as one of the key transformational challenges faced by humanity (Ripple et al. 2020). Acknowledging the need for more ambitious policies, in recent years many countries have increased the stringency of their mitigation pledges, in many cases, targeting to achieve net zero emissions in the next 30–40 years (Höhne et al. 2021). In the same year that over 190 countries around the world committed to implement ambitious efforts to abate emissions through the signing of the 2015 Paris Agreement on Climate Change (UNFCCC 2015), United Nations (UN) members also adopted the 2030 Agenda for Sustainable Development (UN 2015). In 2017, the global indicator framework for Sustainable Development Goals (SDGs) was developed and adopted at the 48th session of the UN Statistical Commission, which includes a set of 231 unique indicators spanning across the 17 SDGs and covering various social, economic and environmental dimensions (UN 2017).

Such a move was largely a reflection of the fact that various transformation pathways, including those that focus on climate mitigation, are characterized by a complex set of interlinkages and are inevitably associated with tradeoffs across various developmental aspects. For instance, while most studies find that climate mitigation policies could help improve air quality and thus reduce mortality from airborne diseases (SDG 3), research also suggests that stringent mitigation could have adverse implications on food security (SDG 2) (Fujimori et al. 2020; Fuso

Nerini et al. 2019). In this regard, the SDG framework sets the lower/upper boundaries (depending on the type of indicator) for a variety of socio-economic and environmental dimensions, ensuring that economic development is happening within a ‘safe operating space’ (Rockström et al. 2009).

Recognizing the complexity of the corresponding interlinkages, several recent studies have explored the implications of climate mitigation policies across various SDG dimensions, attempting to identify the potential tradeoffs that might arise in this regard. Fuso Nerini et al. (2019) analyze the body of this literature and explore the synergies and tradeoffs between climate action and the achievement of various SDGs. The study finds that combatting climate change can reinforce some of the indicators in all 17 SDGs, at the same time such policies are only unambiguously positive for 5 of the SDGs, calling for a wider and deeper multidisciplinary collaboration to better understand these complex interdependencies. Fujimori et al. (2020) provide a quantitative assessment of the impacts of climate mitigation action on selected SDG indicators in Asia. The authors use a set of models, including economic, biodiversity, water scarcity, land use, air transport and nutrition tools, and develop the marginal SDG emission reduction values (MSVs). The latter provides a quantification of the marginal impact of a unit reduction of CO₂ emissions on SDG indicators. Results suggest that indicators such as air pollution-related mortality (SDG3), the number of people under water stress (SDG6), the share of renewable energy (SDG7), unemployment (SDG8), food waste (SDG12) and forest area (SDG15) see improvements under the mitigation scenarios. At the same time, the population at risk of hunger (SDG2), secondary industry share (SDG9), and biodiversity (SDG15) show a trade-off relationship with climate mitigation. Liu et al. (2021) rely on the Representative Concentration Pathways–Shared Socio-economic Pathways (RCP-SSP) framework and a global computable general equilibrium (CGE) model to explore the interactions between climate mitigation policies and SDGs under varying socio-economic conditions. The authors find that in many cases changing socio-economic conditions play a more important role in achieving SDGs than mitigation policies. For instance, changing socio-economic conditions under the SSP1 scenario (Sustainability: Taking the Green Road) could always improve SDG indicators, either with or without implemented climate policies. Cohen et al. (2021) provide a detailed overview of linkages between climate mitigation and SDGs, identifying co-impacts (co-benefits and adverse effects) of specific climate policy interventions across SDGs. The authors illustrate such linkages by providing selected examples of policies listed in the countries’ Nationally Determined Contributions (NDCs), noting that the assessment of co-impacts is critical for supporting climate action, as well as maximizing the benefits of sustainable development.

While advancing the understanding of interactions between global climate mitigation and SDGs, the earlier literature does not explicitly address several important aspects in this area. First, while the earlier literature has pointed out the presence of trade-offs across various SDG dimensions within the climate mitigation pathways (e.g., Cohen et al. 2021; Jakob and Steckel 2016; Fujimori et al. 2020), previous studies have not explored the specific policy solutions in terms of addressing some of the identified tradeoffs. For instance, when carbon pricing is implemented within the

mitigation scenarios, alternative assumptions could be made regarding the recycling of the associated revenue flows. A choice of the specific revenue recycling strategy could have a major impact on the outcomes of the assessed mitigation policies (e.g., Muth 2023; Chen et al. 2020), including various SDG dimensions. Second, while looking into the implications of climate mitigation efforts on SDGs, previous studies have not explored the interactions across various SDG indicators. For instance, Fujimori et al. (2020) estimate that climate mitigation efforts might lead to a minor reduction in economic growth rates and substantial improvements in air quality. However, the authors do not investigate whether the reduced air pollution mortality might outweigh the economic costs of climate mitigation and result in net welfare improvements. The latter is an important policy aspect that has not been properly investigated in the context of climate mitigation-SDG interactions. Third, when assessing the interactions between climate mitigation and the SDGs, earlier studies include a rather stylized representation of the mitigation policies (e.g. Liu et al. 2021; Fujimori et al. 2020), without accounting for the country-specific climate targets or representing selected policy solutions announced by countries around the world, such as the Carbon Border Adjustment Mechanism (CBAM). The latter is a charge on the carbon emissions embodied in products exported from one country (with less stringent mitigation policies) to another country (with more stringent mitigation measures). The CBAM announced by the European Union will require importers of selected carbon-intensive goods to pay for carbon emissions embodied in imported commodities (EC 2024). Finally, since the SDGs cover a broad range of developmental aspects, selected previous studies adopt a multi-model assessment framework to properly investigate various dimensions of the SDGs within the context of the climate mitigation efforts (e.g., Liu et al. 2021; Fujimori et al. 2020). However, to the best of our knowledge, no previous studies have conducted a multi-model assessment of SDGs by linking global economic and energy-system models. The latter is of particular importance for the detailed representation of the energy-related SDG indicators and their interactions with climate mitigation and socio-economic dimensions.

In the current study, we attempt to address the aforementioned limitations and further contribute to a better understanding of trade-offs between climate mitigation action and the sustainable development goals. We achieve this by relying on two global modeling frameworks—the Environmental Impact and Sustainability Applied General Equilibrium (ENVISAGE) model (van der Mensbrugge 2024) and the multi-region inter-temporal partial equilibrium model of the global energy system KINESYS (Kanudia 2023). For the assessment of air pollution co-benefits, we also use the TM5-FASST global atmospheric source-receptor model (van Dingenen et al. 2018). Our study has several important features that allow us to advance the existing literature. First, by using a soft linking of the three distinct modeling frameworks (economic, energy system and atmospheric models), we are able to provide important insights into a wide range of SDG dimensions. While the energy system model is well-suited to assess the detailed impacts across SDG7 and SDG13, the global economy-wide model is more appropriate for assessing the socio-economic dimensions of the SDGs. The atmospheric source-receptor model, on the

other hand, is well-suited to assess the health co-benefits from improved air quality, which are then monetized and incorporated in the overall economic costs of climate mitigation. Second, unlike many earlier studies (e.g., Liu et al. 2021; Fujimori et al. 2020), we incorporate country-specific mitigation targets in a number of scenarios, in particular, NDCs till 2030, allowing for a better reflection of the differentiated mitigation efforts across countries. Third, we assess the implications of selected policy options across SDG indicators, such as implementation of the CBAM and alternative carbon revenue recycling schemes, which provide an important policy dimension to our analysis. Fourth, our analysis includes refined sectoral and geographical dimensions allowing to capture the implications of climate policies on SDGs across a spectrum of countries and economic agents reflecting an important dimension of heterogeneity in the decision-making process. Finally, our assessment covers a wide range of mitigation scenarios and timeframes characterizing a variety of future mitigation ambition, which might provide important insights for policy-makers, in particular, in the developing world, where climate mitigation should be well-aligned with the overall economic development goals.

The rest of this Chapter is organized as follows. Section 2 provides an overview of the methodological framework, including a description of the applied modeling tools, developed scenarios and estimated SDGs. Section 3 provides an overview of the key results. Finally, Sect. 4 concludes.

2 Methodology

2.1 *KINESYS Global Energy System Model*

Knowledge-based Investigation of Energy System Scenarios (KINESYS) is a multi-region inter-temporal partial equilibrium model of the global energy system (Kanudia 2023), which is developed using the TIMES model generator of IEA-ETSAP (Loulou and Labriet 2008). KINESYS integrates assumptions across fuel, technology, and policy landscapes to explore how the entire energy system responds to different incentives and constraints. It determines least-cost investment pathways and energy system operations to meet exogenously projected energy service demands—subject to various energy system and environmental constraints. It is a flexible and modular framework where energy commodity flows are represented in a fully customizable Reference Energy System from primary energy extraction through conversion and production to end use. Technologies are easily added, removed, or represented at different resolutions. Users specify the time periods, regional and sectoral coverage, and list of air pollutants. For the electric power sector, demand is modeled through seasonal and daily time slices. Different types of storage technologies can be modeled.

In terms of emissions coverage, the version of the KINESYS model used in this study only includes CO₂ emissions from fossil fuel combustion. On the technological side, the model represents several negative emission technologies, including

direct air capture, bioenergy with carbon capture and storage (BECCS) and hydrogen BECCS (H2 BECCS). The KINESYS model database is calibrated to the International Energy Agency (IEA) energy balances for 2019. The regional aggregation of the KINESYS model used in the current study is consistent with the regional aggregation of the ENVISAGE modeling framework discussed below. The KINESYS model is run till 2100 with carbon budgets consistent with estimates of restricting warming to 1.5 and 2 °C imposed over the 2070 or 2100 timeframe from the most recent 6th Assessment Report (AR6) of the Intergovernmental Panel on Climate Change (IPCC). Additional details regarding the KINESYS model are available in Kanudia (2023).

2.2 *ENVISAGE Computable General Equilibrium Model*

The Environmental Impact and Sustainability Applied General Equilibrium (ENVISAGE) model at its core is a recursive dynamic and global CGE model (van der Mensbrugge 2024). ENVISAGE is solved as a sequence of comparative static equilibria where the factors of production accumulate over time. The model follows a modular setup, where different modules of the framework can be turned on or off depending on the purpose of the simulations.

The core strength of the global CGE models, like ENVISAGE, is a consistent representation of inter-dependencies between sectors, agents, and markets within the economy. By capturing both the supply and demand sides, the model represents adjustments in quantities and prices reacting to a policy shock. For instance, if a carbon price is imposed in the model, this leads to increasing energy prices, reducing energy supply and demand, accompanied by structural shifts in the economy—declining share of energy-intensive sectors and expanding low-carbon activities (e.g., light manufacturing and services). Additional details regarding the ENVISAGE model can be found in van der Mensbrugge (2024).

The ENVISAGE model used in this study is calibrated to the Global Trade Analysis Project (GTAP) 10 Power Data Base with 2014 reference year, which distinguishes 141 regions and 76 sectors (Aguilar et al. 2019; Chepeliev 2020a). The latter includes 11 electricity generation technologies, as well as an electricity transmission and distribution activity. Negative emission technologies are not included in the version of the model used here. For the purposes of this study, we use an aggregation that includes 19 regions and 36 sectors. On the regional side, the model distinguishes the following countries/regions: the United States (USA), China (CHN), the Russian Federation (RUS), India (IND), Türkiye (TUR), Brazil (BRA), Indonesia (IDN), the Philippines (PHL), Egypt (EGY), Morocco (MAR), EU-27, Rest of East Asia and Pacific (XEA), Rest of South Asia (XSA), Rest of Europe and Central Asia (XEC), Rest of Middle East and North Africa (XMN), Sub-Saharan Africa (SSA), Rest of Latin America and Caribbean (XLC), High-income Asia (HYA), and Rest of high-income (XHY).

The model version used for the current assessment assumes full employment. The latter is a standard assumption used in a number of earlier studies (e.g., Chepeliev et al. 2021; Chepeliev and van der Mensbrugge 2020). For a discussion of alternative labor market specifications in ENVISAGE, an interested reader is referred to van der Mensbrugge (2024). Carbon revenues are recycled to households via direct transfers (a reduction in direct taxes), which is a default revenue recycling option used in most CGE models. An assessment of alternative carbon pricing revenue recycling options using the ENVISAGE model is provided in Chen et al. (2020), while a technical implementation is discussed in van der Mensbrugge (2024). The ENVISAGE model is run till 2050. CO₂ emissions reported in the model include both fossil fuels combustion emissions and emissions from industrial processes such as production of cement and fertilizer. The model is complemented by non-CO₂ greenhouse gases (GHGs) (Chepeliev 2020b) and air pollutant accounts (Chepeliev 2021). Both complementary GHG and air pollutant emissions are endogenously estimated by the model, however, the abatement options for these types of emissions are not explicitly represented in this version of the model.

2.3 TM5-FASST Atmospheric Source-Receptor Model

To facilitate the assessment of the health co-benefits from reduced air pollution levels we link changes in air pollutant emissions across countries and regions generated by the ENVISAGE model with the TM5-FASST global atmospheric source-receptor model (van Dingenen et al. 2018). The TM5-FASST tool calculates the ambient pollutant concentrations and a wide range of impacts on human health, crop production, and pollutant climate metrics (van Dingenen et al. 2018). Annual pollutant emissions, aggregated at the national or regional levels, serve as a key input to the model. Within the current application, the latter are sourced from the ENVISAGE model and fed into TM5-FASST.

We estimate pollutant-related premature mortality rates across regions, investigating PM_{2.5}-related diseases and respiratory ozone (O₃) exposure mortality. Based on the TM5-FASST methodology (van Dingenen et al. 2018), health-relevant exposure metrics considered in the present study are population-weighted annual mean PM_{2.5} at 35% relative humidity and seasonal daily maximum 8 h average ozone concentration metric (SDMA8h). Mortality associated with PM_{2.5} is calculated, using the integrated exposure-response model (IER) adopted in the Global Burden of Disease assessment (Stanaway et al. 2018), as the number of annual premature mortalities from seven categories: ischemic heart disease (IHD), chronic obstructive pulmonary disease (COPD), stroke, lung cancer (LC), lower respiratory airway infections (LRIs), diabetes mellitus type 2 (DMT2) and O₃ respiratory diseases. To monetize the health co-benefits of improved air quality we rely on the value of social life (VSL) approach outlined in Markandya et al. (2018). In brief, the method uses “unit value transfer approach”, which adjusts VSL estimates of the OECD countries to other countries based on the differences in GDP per capita and

projected growth rates. Values of the VSL for OECD countries used in this study vary from 1.8 million USD per capita to 4.5 million USD per capita measured for the 2005 reference year following Holland et al. (2014).

2.4 Model Linking

We use a soft-linking approach to couple the models within the current study. First, the KINESYS model is run to calibrate the baseline path and come up with a set of mitigation scenarios that are consistent with limiting global warming below 2 and 1.5 °C within the 2070 and 2100 timeframe. As a result, we obtain four mitigation scenarios with varying emission trajectories and carbon budgets over the 2019–2050 timeframe. These mitigation pathways are used as boundary conditions when implementing policy scenarios in the ENVISAGE modeling framework. Harmonization is implemented at the global level, as further discussed in the next sub-section.

Next, the ENVISAGE model is run to provide an assessment of the socio-economic impacts of various mitigation policies. This provides us with a set of economic indicators, including implications of the implemented measures for competitiveness, trade and restructuring of the global value chains.

Levels of air pollutants estimated by the ENVISAGE model both in the baseline and mitigation scenarios are further transferred as inputs to the TM5-FASST atmospheric source-receptor model to estimate changes in mortality across various diseases following the implementation of mitigation policies.

The KINESYS and ENVISAGE models use the same set of macroeconomic and demographic drivers for the baseline scenario. The KINESYS model provides ENVISAGE with the carbon budget for the baseline scenario and upper and lower bounds of the carbon budget across various mitigation scenarios (with different levels of climate ambition). In addition, the power generation mix within the baseline scenario estimated by ENVISAGE is broadly aligned with the baseline scenario generation mix provided by the KINESYS model. Overall, all models are soft-linked within the current assessment framework and the linkages are unidirectional, i.e., there are no feedback links and iterations between models.

2.5 Scenario Framework

For the implementation of the baseline scenario in ENVISAGE, we calibrate the model to pre-defined gross domestic product (GDP) and labor force trajectories. GDP trends are sourced from the International Monetary Fund's (IMF) World Economic Outlook (WEO) (IMF 2021) for the near-term projections through 2026, and the Shared Socioeconomic Pathways (SSP) database for the long-term trends to 2050. In particular, the baseline hones to the OECD-developed SSP2

scenario (IIASA 2016), which corresponds to the “middle of the road” pathway with intermediate socio-economic challenges for mitigation and adaptation.

To capture the expected energy and emission trends within the baseline scenario, we incorporate a set of energy-related assumptions. The latter include declining costs of renewable electricity generation, non-price related changes in preferences towards renewables, increases in electricity shares for final and intermediate consumers (electrification rates), improvements in energy efficiency, increasing share of services (servitization) and reductions in international transportation costs. The baseline scenario incorporates a reduction in transportation costs over time due to more efficient modes of transportation and improvements in the energy efficiency of the transportation sector over time. In the various climate mitigation scenarios, when the carbon prices on the combustion of fossil fuels is imposed, the cost of transportation increases relative to the baseline case.

In addition to the assumptions discussed above, we also implement carbon prices in selected countries and regions, including the EU, China and high-income countries. Carbon prices are imposed on a selected set of energy-intensive sectors that correspond to EU emission trading scheme (ETS) activities. The latter include chemicals, metals, non-metallic minerals, petroleum products, wood products and electricity generation.

We consider six scenarios in ENVISAGE that explore various aspects of climate mitigation policy. These scenarios cover different levels of climate mitigation ambition across regions, as well as potential configurations of the carbon border adjustment measures (Table 1). Unconditional (“NDC”) Paris Agreement targets are adapted from Kitous et al. (2016). These targets are further aggregated using baseline emissions as weights to match the regional aggregation. For selected countries and regions, NDC targets are further adjusted based on the Climate Action Tracker database (CAT 2024) and taking into account the baseline emission trends. In cases when countries have non-binding NDC commitments, i.e., baseline emission trends already reach the stated NDC target, we impose a 5% mitigation goal (in 2030 relative to baseline). As a result, based on our interpretation, all countries and regions need to implement additional mitigation efforts under the NDC scenario (compared to the baseline path).

In the KINESYS model, four policy scenarios are considered. They differ in terms of mitigation ambition and the timeframe over which the specified carbon budget is reached (Table 2). Since the KINESYS model includes negative mitigation technologies, cumulative emissions during the first half of the century, i.e., the 2020–2050 period, could exceed the allocated carbon budget as the constraint is imposed over the entire modeled period.

2.6 *SDG Indicators*

Both models provide an opportunity to estimate a wide range of SDG indicators. In the current analysis, we focus on the selected set of representative indicators that

Table 1 Climate policy scenarios in the ENVISAGE model

No.	Scenario	Description
1.	NDC	Includes a translation of unconditional NDCs into regional emission reduction requirements for 2030 relative to the baseline in 2030. Carbon pricing assumptions are applied post-2030. Carbon prices grow at 5% per year in all countries, except the EU, where a 3% growth rate is applied. A minimum of 30 USD per tCO ₂ carbon price is imposed starting from 2035. Only a few regions have carbon prices above 30 USD per tCO ₂ in 2035, including the EU-27, the Rest of high-income region, High-income Asia and Brazil. In the first two cases, carbon prices exceed 240 USD per tCO ₂ in 2050, while for High-income Asia and Brazil, the carbon price is around 110 USD per tCO ₂ in 2050.
2.	NDC-CBAM	Includes NDC scenario with CBAM implemented by the European Union. Between 2026 and 2030 it is assumed that the CBAM covers Scope 1 emissions from chemicals, metals and electricity generation sectors. Between 2031 and 2035 the CBAM is extended to Scope 2 emissions with the same commodity coverage. Starting from 2036 the CBAM is imposed on all emission scopes, while commodity coverage is expanded to all EU ETS sectors.
3.	2C	Regional-specific emission reduction targets for 2030 based on NDCs and a ramping up of mitigation ambitions post-2030 with harmonization of global carbon prices consistent with limiting global warming at 2 °C. By 2050 all countries face a carbon price of \$248 per tCO ₂ . A motivation for the choice of the global uniform carbon price is to minimize the global costs of achieving a given reduction in emissions. Under the global uniform carbon price, marginal abatement costs are equalized across emitters.
4.	2C-FTAX	“2C” scenario with carbon revenue recycling via a reduction in factor taxes in low-carbon activities, including services, light manufacturing and renewable energy.
5.	<2C	Region-specific emission reduction targets for 2030 based on NDCs and a ramping up of mitigation ambitions post-2030 with harmonization of global carbon prices consistent with limiting global warming at below 2 °C. A global carbon price is set at \$159 per tCO ₂ in 2035 and grows at around 6% per year to reach \$393 per tCO ₂ in 2050.
6.	<2C-EARLY	Includes an ambitious early climate mitigation action (pre-2030) with the setting up of a global carbon price, which achieves more stringent emission reductions compared to the “<2C” scenario. Global uniform carbon prices are implemented starting in 2024 at \$43 per tCO ₂ . They further grow at almost 7% per year to reach \$471 per tCO ₂ in 2050. The climate mitigation target in this scenario is consistent with limiting the increase in global temperature to 1.5 °C by 2100.

span across various SDG dimensions. Considering the particular strength of the KINESYS model in capturing various aspects of the energy transition, SDG7 (“Ensure access to affordable, reliable, sustainable and modern energy for all”) is more prominently featured in the analysis. Table 3 provides an overview of the estimated SDG indicators. A selection of the reported SDG indicators is based on a literature review (Fujimori et al. 2020; Liu et al. 2021) and the models’ capabilities.

Table 2 Climate policy scenarios in KINESYS

No.	Scenario	Budget period	Budget, Gt	Scenario description
1.	2C-2070	2020–2070	1310	2 °C-consistent scenario with carbon budget imposed over the 2020–2070 period
2.	2C-2100	2020–2100	1310	2 °C-consistent scenario with carbon budget imposed over the 2020–2100 period
3.	1.5C-2070	2020–2070	460	1.5 °C-consistent scenario with carbon budget imposed over the 2020–2070 period
4.	1.5C-2100	2020–2100	460	1.5 °C-consistent scenario with carbon budget imposed over the 2020–2100 period

3 Results and Discussion

3.1 Emission Pathways

Before proceeding with the discussion of the impacts of climate mitigation efforts on various SDGs, it is relevant to provide a brief overview of the level of mitigation ambition across applied modeling frameworks and scenarios (Fig. 1). Emission trajectories and carbon budgets reported in Fig. 1 include CO₂ emissions from fossil fuel combustion in the case of KINESYS and CO₂ emissions from fossil fuel combustion and industrial processes in the case of ENVISAGE. As can be seen from Fig. 1b, the carbon budget under the baseline scenario is harmonized across the two modeling frameworks. The range of mitigation scenarios represented by the two models is rather broad and ranges from around a 21% reduction in emissions in 2050 relative to the baseline in the case of KINESYS (2C, 2070) scenario to almost a 96% reduction in emissions under the KINESYS (1.5C-2070) case (Fig. 1a). ENVISAGE emission mitigation pathways and resulting carbon budgets are within the range of KINESYS mitigation scenarios. Carbon budgets of the two least-ambitious ENVISAGE-based scenarios (NDC and NDC-CBAM) are well-aligned with the carbon budget of the KINESYS (2C-2100) case, while the most-ambitious ENVISAGE scenario (<2C-Early) is situated between the two 1.5C-consistent pathways reported by the KINESYS model (Fig. 1b).

It should be noted that since the KINESYS model includes several negative emission technologies, the carbon budgets estimated over the 2019–2050 time horizon (Fig. 1b) could be larger than the overall carbon budget constraint imposed over the entire simulation period (Table 2). For instance, this is the case for the KINESYS (1.5C-2100) scenario, where the 2019–2050 carbon budget is 700 Gt, which is 240 Gt larger than the 2019–2100 carbon budget for the same scenario. In most cases, a substantial contribution of negative emission technologies represented in the KINESYS model starts to occur in the post-2050 period primarily generated by hydrogen BECCS. In particular, in the case of the KINESYS (1.5C-2100) scenario discussed above, the H₂ BECCS contribution starts to occur in 2050 at a level of around 2 Gt of CO₂e per year and reaches almost 7 Gt CO₂e in 2100. The

Table 3 An overview of the estimated SDG indicators

SDG	SDG aspect (specific SDG indicator)	Indicator	Units/calculation	Model representation
SDG2	Food security	Food consumption per capita	Food consumption per capita (mn USD)	ENVISAGE
SDG3	Air quality	SO ₂ emission	Tons per year	ENVISAGE
SDG3	Air quality	NO _x emissions	Tons per year	ENVISAGE
SDG3	Air quality	PM10 emissions	Tons per year	ENVISAGE
SDG3	Health	Air pollution mortality	Persons per year (<i>calculated for selected scenarios and years</i>)	ENVISAGE + TM5-FASST
SDG7	Energy security	Total primary energy supply (TPES) diversity	$-\sum_i Q_i \ln Q_i$, where Q_i is the share of each type of primary energy “ i ” in the (TPES) ^a	ENVISAGE, KINESYS
SDG7	Electricity affordability	Electricity prices	USD per kWh	KINESYS
SDG7	Energy affordability	Energy prices	USD per toe	ENVISAGE
SDG7	Energy affordability	Total system costs	Million USD (over the entire simulation horizon)	KINESYS
SDG7	Clean energy	Share of renewable energy in total final energy consumption	Percent	ENVISAGE, KINESYS
SDG7	Energy efficiency	Energy intensity of GDP	Mtoe (of primary energy) per mn USD of GDP	KINESYS
SDG8	Economic growth	Welfare	Aggregate welfare, mn USD	ENVISAGE
SDG9	Industrialization	Manufacturing value-added share	Percent (estimated using nominal prices)	ENVISAGE
SDG10	Equality	Wage skill premia	Ratio between the wages of skilled and unskilled workers	ENVISAGE
SDG10	Equality	Labor share of the aggregate value added	Percent (estimated using nominal prices)	ENVISAGE
SDG10	Between-country inequality	Ratio of the per capita GDP in high-income countries to the per capita GDP in developing countries	Percent (<i>calculated for global reporting</i>)	ENVISAGE
SDG17	Exports of developing countries	Developing and least-developed countries share in global exports	Percent (<i>calculated for global reporting</i>)	ENVISAGE

^a TPES diversity is measured using the Shannon-Weiner Index (Liu et al. 2021) also known as Shannon entropy. The value of the index increases with the number of energy sources and equality of their distribution

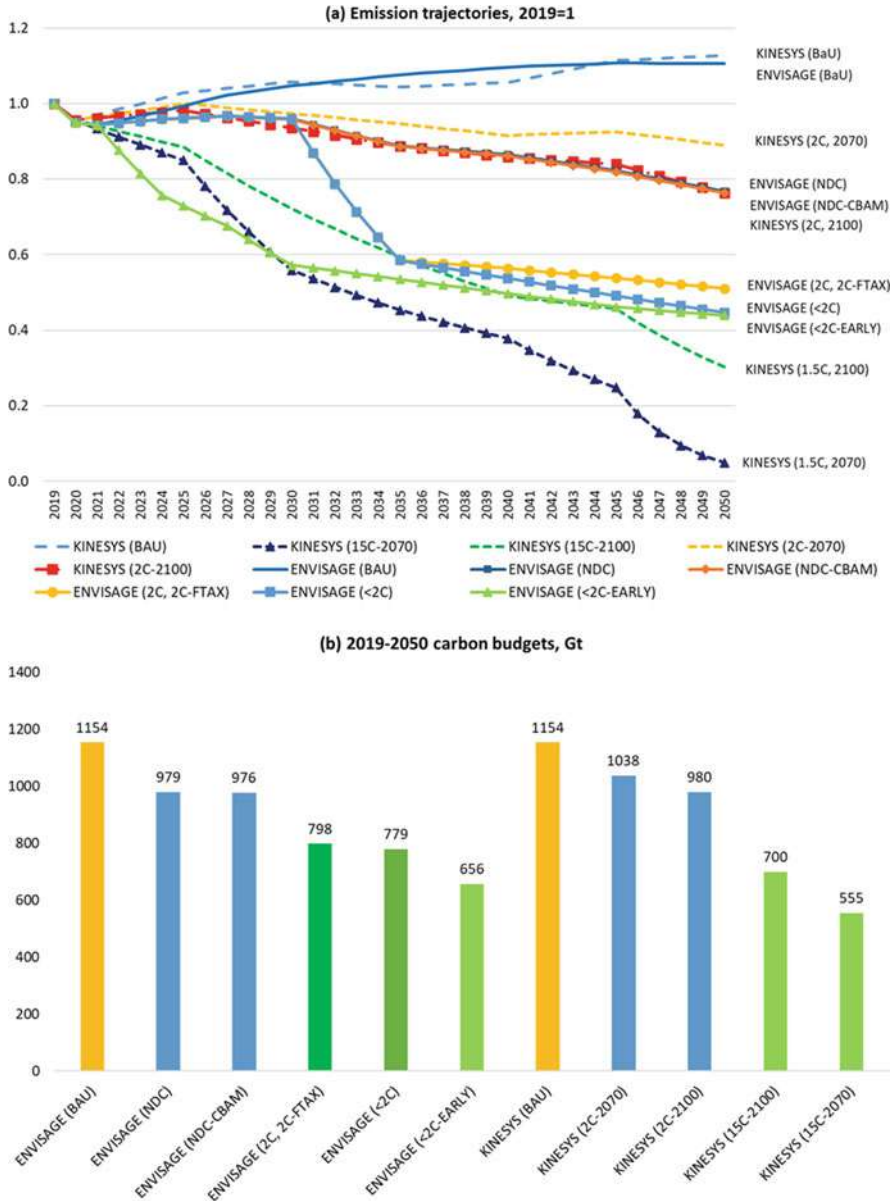

Fig. 1 Emission trajectories (a) and carbon budgets (b) across scenarios and models

contribution of electricity from BECCS in the same scenario is in a range of 0.2 Gt of CO₂e per year starting from 2045, while the contribution of DAC appears for selected years in a range of 0.7–1.3 Gt of CO₂e. In all 2 °C-consistent scenarios in

KINESYS, the contribution of the negative emission technologies starts to appear during the 2055–2070 period.

3.2 Impacts on SDGs at the Global Level Show Major Co-benefits But Also Highlight Several Trade-Offs

Consistent with the findings of earlier studies (e.g., Fujimori et al. 2020; Liu et al. 2021), our results identify important co-benefits but also potential trade-offs between climate mitigation policies and various dimensions of sustainable development. Regarding SDG2 (“End hunger, achieve food security and improved nutrition and promote sustainable agriculture”), we find that climate mitigation policies could have a moderate impact on reducing overall food demand (and affordability) between 0.4% and 1% across scenarios in 2050 when compared to the reference case (Fig. 2a). This is primarily happening through the channel of increasing prices of energy-intensive commodities resulting in overall lower consumers’ purchasing power. It should be noted, however, that in the current assessment, we consider only mitigation of fossil-fuel combustion CO₂ emissions, while the inclusion of a broader range of mitigation options, such as land-based mitigation and reduction of non-CO₂ GHGs within the food systems might have more substantial implications on food demand. It should be noted that in the ENVISAGE model CO₂ emissions from industrial processes as well as non-CO₂ GHGs are estimated by the model (emission levels are linked to the level of the corresponding economic activity), but in the version of the model used for this study, the abatement options for these types of emissions are not deployed (e.g., the change of feed practices in the livestock sector, carbon capture and storage in steel and cement making, etc.).

In terms of SDG3 (“Ensure healthy lives and promote well-being for all at all ages”), we find that climate mitigation policies could have major co-benefits by reducing air pollutant emissions, including SO₂ (Fig. 2b), NO_x (Fig. 2c) and PM10 (Fig. 2d). Corresponding emission reductions are around 40% for the case of PM10 under the most ambitious mitigation scenario in 2050 and reach over 75% in the case of SO₂ (Fig. 2d, b respectively). As will be further discussed in Sect. 3.4, it is important to properly account for such co-benefits and their implications for health and mortality as this allows for a better understanding of the interlinkages of impacts across various SDGs (in this case SDG3 and SDG8).

In the context of the impacts of the mitigation policies on SDG7 (“Ensure access to affordable, reliable, sustainable and modern energy for all”), we analyze six different indicators measuring various aspects of this important developmental area. The climate mitigation simulations results show a substantial increase in the share of renewable energy in the energy mix—between 5 and 50 percentage points by 2050 across scenarios (Fig. 3e)—as well as a reduction in the energy intensity of GDP through an adoption of more energy-efficient technologies (Fig. 3f). However, these transformations might put pressure on energy affordability. In particular, as

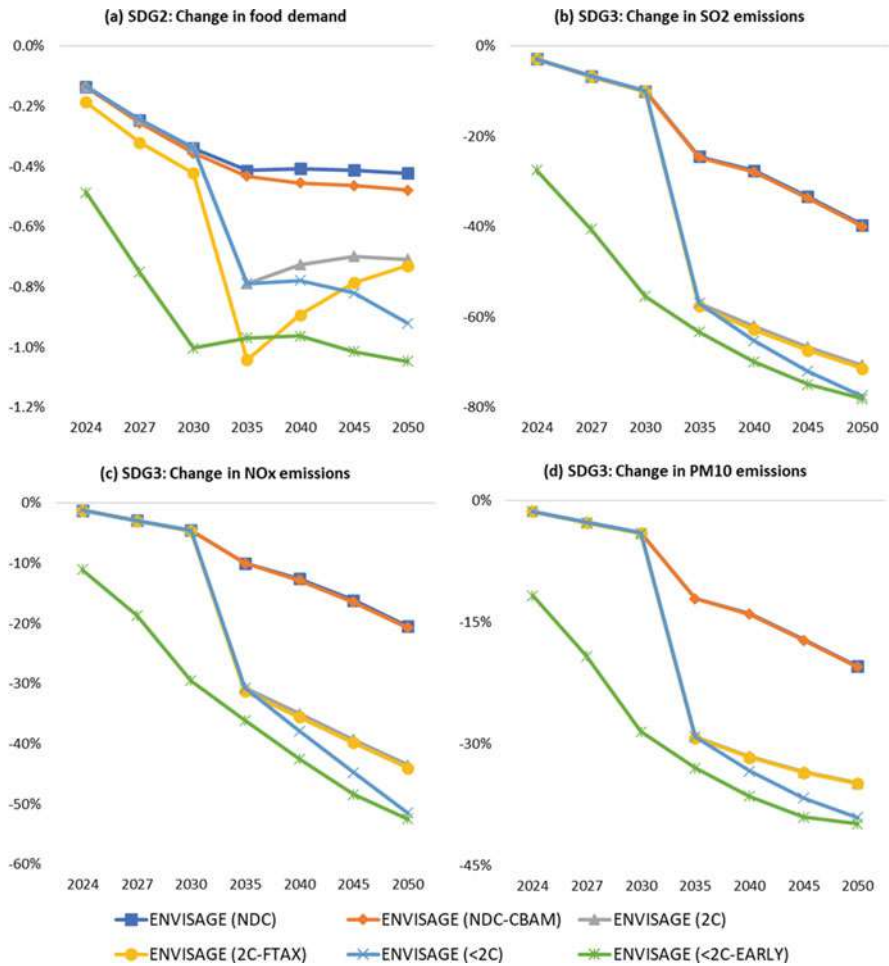

Fig. 2 Global impacts on SDG 2 and SDG 3 indicators relative to the baseline levels

suggested by the KINESYS model estimates, electricity prices could increase by over 80% under the most ambitious mitigation scenarios in 2030 compared to the baseline (Fig. 3b). And while in the longer term, the pressure on electricity and energy (Fig. 3c) prices declines, such substantial price hikes in the medium term might require targeted support measures by governments around the world aimed at protecting the most vulnerable consumers and ensuring energy affordability for all. When cumulated across the entire simulation horizon, overall energy system costs increase between 2% and 3% for the lower-ambition mitigation scenarios to 8–12% for the more stringent cases (Fig. 3d), indicating that if costs are properly distributed over time even the most ambitious mitigation efforts represent the economically-affordable policy solutions. Finally, in terms of the impacts of mitigation policies on

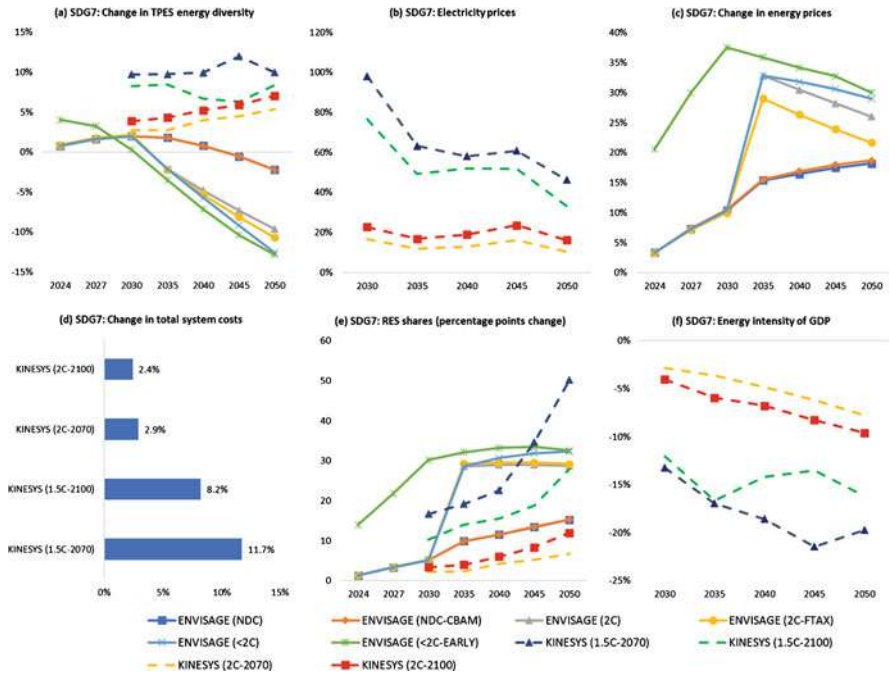

Fig. 3 Global impacts on SDG 7 indicators relative to the baseline levels

the energy mix (Fig. 3a), the models provide ambiguous implications. While in the KINESYS model, the energy mix diversity increases under the mitigation scenarios, in the case of the ENVISAGE model results, the baseline energy mix is already rather diversified (in ENVISAGE the share of renewable energy increases more rapidly in the baseline scenario compared to the KINESYS model) and thus the additional mitigation effort leads to an overall reduction in the energy mix diversity with an expanding renewable generation. In other words, in the ENVISAGE model within the mitigation scenarios energy mix becomes cleaner but less diverse—shares of fossil fuels decrease, while shares of renewables increase. At the same time, both models suggest that the energy import dependency decreases in the mitigation scenarios as countries substitute imported fossil fuels with domestically generated renewable energy.

SDG8 (“Promote sustained, inclusive and sustainable economic growth, full and productive employment and decent work for all”) reflects an important dimension of economic growth. Overall, we find that even the most ambitious climate mitigation scenario global welfare declines by only 1.1% relative to the baseline in 2050 (Fig. 4a). When translated to the annual growth rates, this corresponds to a reduction of around 0.03 percentage points per year. In addition, as is further discussed in Sect. 3.3 below, selected policy solutions, such as recycling carbon revenue through reduced factor taxes rather than direct lump-sum payments could further reduce

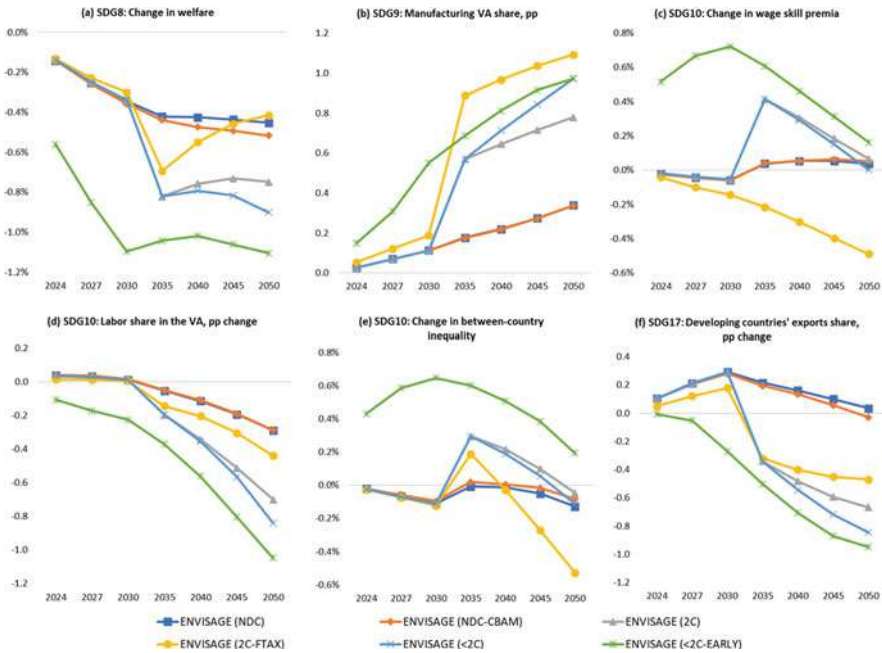

Fig. 4 Global impacts on SDG 8, 9, 10 and 17 indicators relative to the baseline levels. *Notes:* “VA” stands for value-added; “pp” stands for percentage points; “RES” stands for renewable energy sources. A detailed description of the scenarios is provided in Sect. 2

these costs making them close to zero, even without accounting for the various environmental co-benefits associated with ambitious mitigation efforts.

The results also suggest that ambitious climate mitigation efforts could increase the share of manufacturing in value-added, reflecting one of the dimensions of SDG9 (“Build resilient infrastructure, promote inclusive and sustainable industrialization and foster innovation”). As in the case of impacts on welfare, recycling carbon revenue through reduced factor taxes in selected sectors results in the most substantial increase in the share of manufacturing in value-added—by over 1 percentage point in 2050, thus contributing to the promotion of sustainable industrialization (Fig. 4b).

Inequality is another important aspect that we assess in this study, reflecting on several SDG10 (“Reduce inequality within and among countries”) dimensions. In particular, we find that unless specific policy measures, such as revenue recycling through factor taxes, are implemented within the decarbonization pathways, there is a risk of increasing the wage gap between skilled and unskilled workers (Fig. 4c), which might potentially result in regressive distributional impacts. Though overall the magnitude of the increasing wage skill premia is very moderate and the actual distributional impacts will most likely be driven by other more important factors (e.g., changing commodity prices and the spatial distribution of selected mitigation

co-benefits, etc.). Our results also suggest that there is a moderate reduction in the share of labor in value-added—by up to 1 percentage point under the most ambitious mitigation scenario in 2050 (Fig. 4d)—as the production process becomes more capital-intensive. Such a trend could be taken as an indication of the potential adverse implications of the low-carbon transition on the labor force in general and low-skilled workers, in particular, when combined with an increasing wage-skill premium. Finally, in terms of the implications for between-country inequality, we find that in the long run moderately negative impacts are observed only under the most-ambitious mitigation case, though even then the inequality increases by only 0.2% in 2050 when compared to the baseline (Fig. 4e). At the same time, when the carbon revenue is recycled through a reduction in factor taxes, this policy could result in a reduction in between-country inequality in the long run, as the latter declines by over 0.5% (Fig. 4e).

Finally, looking at a selected dimension of SDG17 (“Strengthen the means of implementation and revitalize the Global Partnership for Sustainable Development”), we find that the higher-ambition mitigation scenarios could result in the declining share of exports from developing countries in the global exports—by up to 1 percentage point in 2050 under the most ambitious mitigation scenario (Fig. 4f). Partly this result is driven by the assumption that in the long run under higher-ambition mitigation scenarios, carbon prices are equalized across countries, thus both developing and high-income economies will face the same level of carbon prices. In the NDC and NDC-CBAM scenarios, carbon prices are differentiated across countries and thus the developing countries, in general, face lower carbon prices than the high-income economies.

It should also be noted that in terms of the impacts of the CBAM, the results suggest that this mechanism has relatively moderate implications and only on the selected set of SDG indicators. In particular, we find that the CBAM could have moderate adverse implications on food demand, reducing it by around 0.05% in 2050 relative to the NDC scenario without CBAM (Fig. 2a). In addition, a minor reduction in welfare is observed under the CBAM scenario—by around 0.1% in 2050 (Fig. 2k). The CBAM also has a negative impact on the share of developing countries’ exports in global trade—reducing it by around 0.07 percentage points in 2050 compared to the NDC scenario (Fig. 2p). Overall, the impacts of the extended CBAM on SDGs are rather moderate even in the long term, while resulting in a 0.5% reduction in global CO₂ emissions in 2050.

3.3 Alternative Revenue Recycling Options Might Strengthen Positive Spillovers

One of the important features of our analysis includes an assessment of alternative carbon revenue recycling options on various SDG dimensions. In the previous sub-section, we have already briefly discussed some of the implications of the changes in the revenue recycling scheme on selected SDG indicators. In this

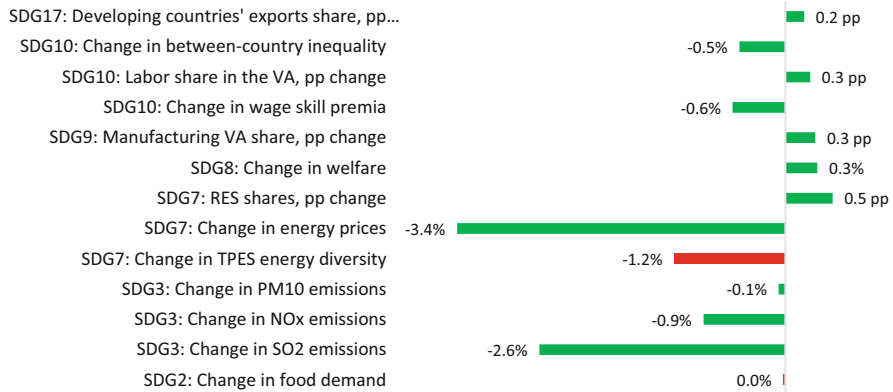

Fig. 5 Impact of the alternative carbon revenue recycling scheme on the SDG indicators in 2050 (“2C-FTAX” vs “2C” scenarios). *Notes:* Bars colored green indicate improvements over corresponding dimensions, while bars colored red indicate worsening of the corresponding indicators (Color figure online)

sub-section, we provide a more in-depth comparison of this policy aspect. In particular, we focus on the 2 °C-consistent mitigation scenario and explore how a change in the carbon revenue recycling approach—from lump-sum payments to households (a default assumption) to recycling revenue via reductions in factor taxes for low-carbon activities, including services, light manufacturing and renewable energy—could help to strengthen the spillover effects across the SDGs. It should be noted that the impacts of the alternative carbon revenue recycling options are analyzed only for indicators covered by the ENVISAGE model. The latter covers 13 out of the 17 indicators assessed in this study. The remaining four indicators are covered by the KINESYS model only and thus are not subject to the assessment within the alternative carbon revenue recycling scenarios.

As can be seen from Fig. 5, which compares the impact of the alternative carbon revenue recycling scheme across the SDG indicators, for 11 out of 13 considered SDG dimensions an improvement is observed when the carbon revenue is recycled via a reduction in factor taxes instead of lump-sum payments to households. A key mechanism behind such a positive effect is that the reduction in factor taxes in low-carbon sectors leads to an expansion in economic activity of these sectors, a reduction in the economy-wide carbon prices needed to achieve the targeted emission targets and overall lower mitigation costs. As a result, we see that average energy prices decline by 3.4%, the share of renewable energy sources increases by 0.5 percentage points, while overall welfare grows by 0.3%. Other SDG dimensions also improve, including inequality and environmental metrics. The only exception is a reduction in the TPES energy diversity associated with an increasing share of renewable energy sources compared to the “2C” scenario. At the same time, as in the case of other scenarios, this trend is also accompanied by an increasing self-sufficiency of the energy supply (reducing reliance on imported energy), which represents another important aspect of energy security.

3.4 It Is Important to Properly Capture the Interactions Across Various SDG Dimensions: A Case of Air Pollution-Related Mortality

While policy efforts required to put the global economy on a low-carbon transition pathway might be challenging to implement (Pahle et al. 2018; Keohane and Victor 2016), if society succeeds in this, the overall costs of such transition would be rather moderate. As discussed in Sect. 3.2, by 2050 the welfare costs even of the most ambitious mitigation scenario do not exceed 1.1% (compared to the no-mitigation case) (Fig. 4a). At the same time, such estimates do not take into account the co-benefits associated with other SDG dimensions, such as a reduction in air pollution associated with mitigation efforts (Fig. 2b–d). Earlier studies suggest that if accounted for, in many cases, such impact channels could lead to net welfare and GDP gains (e.g., Markandya et al. 2018; Vandyck et al. 2018). If such co-benefits are not properly accounted for, an assessment might suggest the presence of trade-offs across SDGs, while in reality there are positive spillover effects. To showcase this point, we link changes in air pollutant emissions across countries and regions generated by the ENVISAGE model with the TM5-FASST global atmospheric source-receptor model (van Dingenen et al. 2018). This model linkage allows us to associate changes in the emissions of each air pollutant with seven types of diseases, explicitly assessing the health co-benefits of the climate mitigation policies across countries and regions as discussed in more detail in Sect. 2.3. In what follows we focus our discussion on the 2 °C-consistent scenario and the 2050 reference year, however, the overall framework and logic are similarly applicable to other mitigation scenarios and timeframes.

Results suggest that under the “2 °C” scenario, a reduction in air pollution due to low carbon development can save almost 740,000 lives in 2050 when compared to the reference scenario. When compared across countries, both in absolute terms and per million of population, India benefits the most from the reductions in air pollution, as around half of all saved lives worldwide occur in this country. In relative terms, China, the Rest of South Asia, the United States, the Rest of East Asia, High-income Asia and Türkiye all have at least 70 lives saved per million. Across diseases, almost half of all premature mortality reductions are associated with chronic obstructive pulmonary disease, with lower respiratory infection being the second most impactful factor (Fig. 6).

When health co-benefits of improved air quality are monetized using the “unit value transfer approach”, as discussed in more detail in Sect. 2.3, the results suggest that the aggregate air pollution reduction health co-benefits outweigh mitigation costs by over a factor of 2 (Fig. 5). A larger ratio of co-benefits relative to mitigation costs is observed for developing countries compared to high-income economies since on average the latter have lower emission intensities and higher costs of emission reduction. In absolute terms, China and India show the largest mitigation co-benefits under the “2C” scenario—in a range of around 400 billion USD combined (Fig. 7). On average, low- and middle-income countries excluding China show

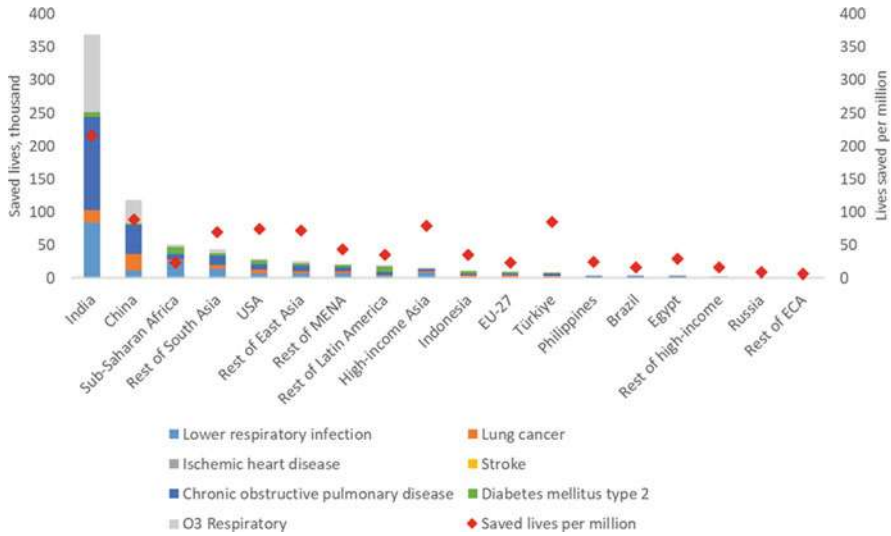

Fig. 6 Mortality reductions due to improved air quality across types of diseases under 2C scenario in 2050. *Notes:* Estimates are reported as changes relative to the reference scenario

a ratio of co-benefits to mitigation costs of almost five. There are, however, several developing countries/regions, where the corresponding co-benefits do not outweigh the welfare costs. Corresponding examples include the Philippines, Sub-Saharan Africa, Egypt, and the Rest of Eastern Europe and Central Asia. It should be noted, however, that the current set of results associated with the “2C” scenario assume a uniform global carbon price. Implementation of country-specific mitigation targets might result in a different distribution of economic costs and health co-benefits across countries.

Under the less ambitious “NDC” scenario, the ratio of air pollution co-benefits to mitigation costs is lower than under the “2C” case, and is around 1.5–2 for both groups of high-income and developing countries. This suggests that a higher level of mitigation ambition is more economically feasible (when compared to the less ambitious “NDC” scenario) once air pollution co-benefits are taken into consideration.

4 Conclusions

In this study, we contribute to a better understanding of the synergies and trade-offs between climate mitigation and sustainable development goals, covering a total of 17 SDG indicators representing SDG2, SDG3, SDG7, SDG8, SDG9, SDG10 and SDG17. Our assessment employs a multi-model framework, which includes a global computable general equilibrium model ENVISAGE, energy system model

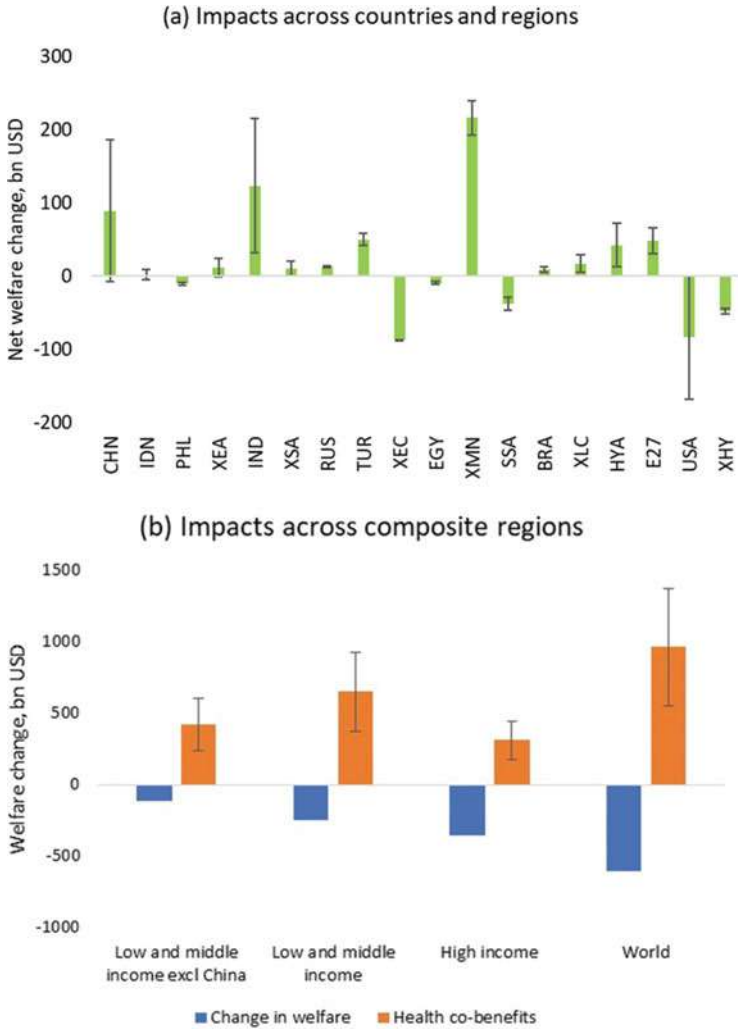

Fig. 7 Health co-benefits and mitigation costs under 2C scenario in 2050 (billion USD). *Notes:* Uncertainty bars correspond to lower and upper values of the VSL considered in the analysis. Panel (a) represents net welfare impacts across countries and regions modeled in the study. Panel (b) reports results for the composite regions decomposing welfare change and co-benefits parts

KINESYS and atmospheric source-receptor model TM5-FASST. Three broad conclusions could be derived from our analysis.

First, considering the multi-dimensional nature of the SDGs, climate mitigation policies, while resulting in major co-benefits, could also lead to additional risks across selected SDG aspects, when compared to the no mitigation scenario. We find

that out of 17 analyzed SDG indicators, seven experience co-benefits from implementing mitigation efforts. These include changes in selected air pollutant emissions, reduced mortality following air quality improvements, an increase in the share of renewable energy sources, improvements in energy efficiency and an increasing share of manufacturing in value added. At the same time, six SDG indicators are subject to trade-offs under the climate mitigation policies. These include reductions in food demand, increasing electricity and energy prices, rising overall energy system costs, reductions in welfare and a declining share of labor in value added. Finally, the remaining four SDG indicators show mixed trends across scenarios and/or time horizon. Such indicators include TPES energy diversity, the wage gap between skilled and unskilled workers, between-country inequality and the share of exports from developing countries in global exports.

Second, the identified trade-offs could be substantially reduced and, in some cases, fully avoided through the implementation of specific policy options. In particular, we find that if the revenue collected from carbon pricing is recycled via reductions in factor taxes in selected low-carbon activities, as opposed to lump-sum payments to households, outcomes for 11 out of 13 SDG dimensions would improve; a reduction in energy prices, increasing share of renewable energy, improving distributional outcomes and decreasing welfare losses.

Finally, our analysis stresses the importance of properly capturing interactions across various SDG dimensions, when accounting for co-benefits. We showcase this point by monetizing the co-benefits from improved air quality and reduced mortality putting these impacts in the context of estimated welfare costs. We find that these co-benefits outweigh mitigation costs by more than a factor of two, thus reversing the trade-off earlier identified for the case of economic growth into a synergy. What is even more important, our results suggest that a larger ratio of co-benefits relative to mitigation costs is observed for developing countries compared to high-income economies, as the former group (excluding China) shows a ratio of co-benefits to mitigation costs of almost five. When properly accounted for, this outcome could provide synergy for another important SDG dimension, by contributing to a reduction in between-country inequality. While these are just a few selected examples of how a proper accounting of interactions between SDGs could convert the initially estimated trade-offs into co-benefits, future research would benefit from better exploring this aspect.

While in the current study, we attempt to provide quantification of the potential implications of ambitious mitigation policies on various aspects of the SDGs, providing some broad insights, there are several important improvements and extensions that could further advance the analysis presented here. *First*, in terms of a more refined representation of the climate policy scenarios and the energy transition, one might consider a more comprehensive link between the energy system and CGE models with a better alignment of the technological parametrization and energy mixes across the two frameworks. In addition, health impacts from improved air quality estimated by the atmospheric source-receptor model could explicitly be incorporated as feedback to the CGE framework. *Second*, in the way mitigation policies are implemented. In the current study we use carbon pricing as a

single representative instrument, in particular, in the ENVISAGE model. However, in many specific country cases, governments are implementing a variety of different policies and measures, including subsidies to specific technologies and products, emission standards, phasing out of fossil fuels subsidies, etc. Implementing these country-specific policy instruments would help to provide a more realistic representation of the future impacts of mitigation policies on SDGs. *Third*, while our modeling framework provides rather detailed geographical and sectoral/technological coverage, in the current analysis we have been largely focusing on the global results (with a few exceptions). It is important to better explore the geographical and sectoral dimensions in the context of implications for various SDGs, however, we leave this aspect for future research. *Fourth*, while in the current analysis, we attempt to provide sufficient coverage of multiple SDGs, there is always a scope for further expanding the investigated SDG dimensions and their interactions, including aspects of income distribution, gender equality, climate resiliency and circularity, among others. *Finally*, considering the multi-model and global nature of our assessment, the results presented here are naturally subject to uncertainty. The latter comes both from the assumptions regarding the future evolution of the energy and socio-economic systems, as well as model parametrization (e.g., the value of substitution elasticities in the ENVISAGE model, technological assumptions in the KINESYS model, etc.). Exploring these uncertainties by conducting a comprehensive sensitivity analysis goes beyond the scope of the current assessment but would be an important extension of the current contribution.

References

- Aguiar A, Chepeliev M, Corong EL, McDougall R, van der Mensbrugge D (2019) The GTAP data base: version 10. *J Glob Econ Anal* 4(1):1–27. <https://doi.org/10.21642/JGEA.040101AF>
- Chen J, Chepeliev M, Garcia-Macia D, Iakova DM, Roaf J, Shabunina A, van der Mensbrugge D, Wingender P (2020) EU climate mitigation policy. *International Monetary Fund Departmental Papers* 2020(013). <https://doi.org/10.5089/9781513552569.087>
- Chepeliev M (2020a) GTAP-power data base: version 10. *J Glob Econ Anal* 5(2):110–137. <https://doi.org/10.21642/JGEA.050203AF>
- Chepeliev M (2020b) Development of the non-CO₂ GHG emissions database for the 617 GTAP 10A database. *GTAP Research Memorandum No. 32*. 618 https://www.gtap.agecon.purdue.edu/resources/res_display.asp?RecordID=5993
- Chepeliev M (2021) Developing an air pollutant emissions database for global economic analysis. *J Glob Econ Anal* 6(2):31–85. <https://doi.org/10.21642/JGEA.060202AF>
- Chepeliev M, van der Mensbrugge D (2020) Global fossil-fuel subsidy reform and Paris Agreement. *Energy Econ* 85:104598. <https://doi.org/10.1016/j.eneco.2019.104598>
- Chepeliev M, Osorio-Rodarte I, van der Mensbrugge D (2021) Distributional impacts of carbon pricing policies under the Paris Agreement: inter and intra-regional perspectives. *Energy Econ* 102:105530. <https://doi.org/10.1016/j.eneco.2021.105530>
- Climate Action Tracker (CAT) (2024). <https://climateactiontracker.org/>
- Cohen B, Cowie A, Babiker M, Leip A, Smith P (2021) Co-benefits and trade-offs of climate mitigation actions and Sustainable Development Goals. *Sustain Prod Consum* 26:805–813. <https://doi.org/10.1016/j.spc.2020.12.034>

- European Commission (EC) (2024) Carbon border adjustment mechanism. https://taxation-customs.ec.europa.eu/carbon-border-adjustment-mechanism_en#where-to-report
- Fujimori S et al (2020) Measuring the sustainable development implications of climate change mitigation. *Environ Res Lett* 15(8). <https://iopscience.iop.org/article/10.1088/1748-9326/ab9966>
- Fuso Nerini F et al (2019) Connecting climate action with other Sustainable Development Goals. *Nat Sustain* 2:674–680. <https://doi.org/10.1038/s41893-019-0334-y>
- Höhne N et al (2021) Wave of net zero emission targets opens window to meeting the Paris Agreement. *Nat Clim Change* 11:820–822. <https://doi.org/10.1038/s41558-021-01142-2>
- Holland M, Spadaro J, Misra A, Pearson B (2014) Costs of air pollution from European industrial facilities 2008–2012. European Environment Agency, Copenhagen
- International Institute for Applied Systems Analysis (IIASA) (2016) SSP database (Shared socio-economic pathways)—version 1.1. <https://tntcat.iiasa.ac.at/SspDb/dsd?Action=htmlpage&page=about>
- International Monetary Fund (IMF) (2021) World economic outlook, October 2021. <https://www.imf.org/en/Publications/WEO/Issues/2021/10/12/world-economic-outlook-october-2021>
- Jakob M, Steckel JC (2016) Implications of climate change mitigation for sustainable development. *Environ Res Lett* 11(10):104010. <https://doi.org/10.1088/1748-9326/11/10/104010>
- Kanudia A (2023) Knowledge-based Investigation of Energy System Scenarios (KINESYS). <https://kinesys.readthedocs.io/en/latest/>
- Keohane R, Victor D (2016) Cooperation and discord in global climate policy. *Nat Clim Change* 6: 570–575. <https://doi.org/10.1038/nclimate2937>
- Kitous A, Keramidis K, Vandyck T, Saveyn B (2016) Global energy and climate outlook. Road from Paris. EUR 27952 EN, <https://doi.org/10.2791/66247>
- Liu JY et al (2021) The importance of socioeconomic conditions in mitigating climate change impacts and achieving Sustainable Development Goals. *Environ Res Lett* 16(1):014010. <https://doi.org/10.1088/1748-9326/abcac4>
- Loulou R, Labriet M (2008) ETSAP-TIAM: the TIMES integrated assessment model part I: model structure. *CMS* 5:7–40. <https://doi.org/10.1007/s10287-007-0046-z>
- Markandya A et al (2018) Health co-benefits from air pollution and mitigation costs of the Paris Agreement: a modelling study. *Lancet Planet Health* 2(3):e126–e133. ISSN 2542-5196. [https://doi.org/10.1016/S2542-5196\(18\)30029-9](https://doi.org/10.1016/S2542-5196(18)30029-9)
- Muth D (2023) Pathways to stringent carbon pricing: configurations of political economy conditions and revenue recycling strategies. A comparison of thirty national level policies. *Ecol Econ* 214:107995. <https://doi.org/10.1016/j.ecolecon.2023.107995>
- Pahle M et al (2018) Sequencing to ratchet up climate policy stringency. *Nat Clim Change* 8:861–867. <https://doi.org/10.1038/s41558-018-0287-6>
- Ripple WJ et al (2020) World scientists’ warning of a climate emergency. *BioScience* 70:8–12
- Rockström J et al (2009) A safe operating space for humanity. *Nature* 461:472–475. <https://doi.org/10.1038/461472a>
- Stanaway JD et al (2018) Global, regional, and national comparative risk assessment of 84 behavioural, environmental and occupational, and metabolic risks or clusters of risks for 195 countries and territories, 1990–2017: a systematic analysis for the Global Burden of Disease Study 2017. *Lancet* 392:1923–1994. [https://doi.org/10.1016/S0140-6736\(18\)32225-6](https://doi.org/10.1016/S0140-6736(18)32225-6)
- United Nations (UN) (2015) Transforming our world: the 2030 Agenda for Sustainable Development, 21 October 2015, A/RES/70/1
- United Nations (UN) (2017) Global indicator framework for the Sustainable Development Goals and targets of the 2030 Agenda for Sustainable Development. <https://unstats.un.org/sdgs/indicators/indicators-list/>
- United Nations Framework Convention on Climate Change (UNFCCC) (2015) Adoption of the Paris Agreement. Report No. FCCC/CP/2015/L.9/Rev.1. <http://unfccc.int/resource/docs/2015/cop21/eng/l09r01.pdf>

- van der Mensbrugge D (2024) The environmental impact and sustainability applied general equilibrium (ENVISAGE) model. Version 10.4. Center for Global Trade Analysis, Purdue University. <https://mygeoHub.org/groups/gtap/envisage-docs>
- van Dingenen R et al (2018) TM5-FASST: a global atmospheric source–receptor model for rapid impact analysis of emission changes on air quality and short-lived climate pollutants. *Atmos Chem Phys* 18:16173–16211. <https://doi.org/10.5194/acp-18-16173-2018>
- Vandyck T et al (2018) Air quality co-benefits for human health and agriculture counterbalance costs to meet Paris Agreement pledges. *Nat Commun* 9:4939. <https://doi.org/10.1038/s41467-018-06885-9>

Open Access This chapter is licensed under the terms of the Creative Commons Attribution 4.0 International License (<http://creativecommons.org/licenses/by/4.0/>), which permits use, sharing, adaptation, distribution and reproduction in any medium or format, as long as you give appropriate credit to the original author(s) and the source, provide a link to the Creative Commons license and indicate if changes were made.

The images or other third party material in this chapter are included in the chapter's Creative Commons license, unless indicated otherwise in a credit line to the material. If material is not included in the chapter's Creative Commons license and your intended use is not permitted by statutory regulation or exceeds the permitted use, you will need to obtain permission directly from the copyright holder.



Accelerating the Performance of Large-Scale TIMES Models in the Modelling of Sustainable Development Goals



Evangelos Panos and Aymane Hassan

Abstract Energy system models become very complex when introducing Sustainable Development Goals (SDGs) in high spatial and temporal detail. This can challenge their solvability and may require aggregation or reformulation of the optimisation problem or even solver-based methods for accelerating the solution time of the models. We provide insights into two powerful solver-based methods using a European TIMES-based model to guide the modeller in applying these methods. The first method involves efficiently parametrising the Barrier interior point solver in a shared-memory system, e.g., a personal computer. We find that with a suitable set of Barrier solver options, the run time of our test model was reduced by 95%. The second solver-based method uses distributed computing systems to solve the model matrix in parallel and across several nodes. We find that by exploiting the new parallel interior point solver PIPS-IPM++, we can scale up the model size several times without increasing solution runtimes when solving across multiple nodes. By combining solver- methods with suitable model reformulations, the energy system modelling research community can accelerate the solution of large-scale models featuring the assessment of the complex interactions between several SDGs.

Key Messages

- Several SDGs, e.g., SDG1 on poverty, SDG6 on water, SDG7 on energy, SDG11 on cities, SDG13 on climate change, require complex and large-scale modelling with high temporal, spatial, sectoral and technical details.
- Tailored solver parametrisation reduces solution times of such complex energy system models in shared-memory computer systems.

E. Panos (✉)
Paul Scherrer Institute, Villigen PSI, Switzerland
e-mail: evangelos.panos@psi.ch

A. Hassan
Sweco Sweden AB, Stockholm, Sweden
e-mail: aymane.hassan@sweco.se

- Solving the model matrix in parallel and across multiple nodes decouples solution times and model complexity.
- All solver-based techniques require good model- and solver knowledge to deliver substantial reductions in solution times.

1 Introduction

Over the last 50 years, policy and research questions transformed energy systems models from “energy-flow accounting” frameworks, such as the Energy Optimisation Model (EFOM) (Van der Voort 1982), to sophisticated “energy-economy-climate” paradigms such as the ETSAP-TIAM (Loulou and Labriet 2008) integrated modelling assessment framework. This is also driven by two major international agreements in 2015: the climate change mitigation targets of the COP21 in Paris (UNFCCC 2015) and the adoption of the Sustainable Development Goals (SDG) Agenda (United Nations 2015). With the SDG Agenda, using models is even more important to explore intersecting systems, but this requires system thinking and multi and interdisciplinary approaches to assess trade-offs quantitatively and unveil challenges. To this end, Allen et al. (2016) compared 80 models for national development planning for the SDGs. They showed that while top-down macro-frameworks models are useful for economy-wide scenario analysis, bottom-up sectoral models support far more detailed option-level impact analysis of concrete interventions, technologies and investments. Ideally, a combination of top-down and bottom-up approaches, like ETSAP-TIAM, is needed. The European Commission (EC) uses modelling in all phases of its policy cycle and recognises models as strategic instruments to address complex topics. It is no surprise that to deal with this complexity, the EC Joint Research Centre (JRC) has more than 100 modelling tools for assessing the 17 SDGs (Barbero-Vignola et al. 2020).

Within the energy systems modelling community, the required complexity in representing technologies and sectors at high spatial, technical and temporal resolution has increased in recent years (Lopion et al. 2018; Cao et al. 2019) to assess the trade-offs in the SDG interactions and potential strategies, and to ensure policy coherence to reach the SDG targets (van Soest et al. 2019). For example, the interactions between SDG 7 (Clean and Affordable Energy) and SDG 13 (Climate Action) call for high temporal and spatial resolution to capture the variability and location of the renewable energy sources (Martínez-Gordón et al. 2021) and high technical and sectoral detail for the transformation towards a more decentralised system and the impact assessment of suitable SDG policies. The benefits of high temporal resolution in energy systems models are well shown within ETSAP and the broader energy systems and integrated assessment modelling community (Kannan et al. 2015; Collins et al. 2017). Similarly, the need for higher spatial resolution is also proven within the same research community; for example in Zeyringer et al. (2015), Aryanpur et al. (2021), Sferra et al. (2021). Considering all the 17 SDGs, it becomes clear that energy systems models need to support analysis at national and

subnational scales by maintaining global interlinkages and at different time scales (Allen et al. 2016).

The trade-off in model detail and computational resources (Sharma et al. 2019) led the energy systems modelling community to explore solution acceleration strategies by leveraging domain knowledge (Cao et al. 2019). Most of them aggregate the models to an acceptable level of detail for the required analyses or decompose the original problem into many smaller ones. Examples are temporal aggregation (Nahmmacher et al. 2016; Kotzur et al. 2018), spatial aggregation (Hodge et al. 2012; Fleischer 2020; Mertens et al. 2020) or the reduction in modelling detail of the system components (Kotzur et al. 2021); often with the application of sophisticated algorithms, such as deep learning (Köhnen et al. 2022), clustering (Novo et al. 2022), principal components analyses (Densing and Wan 2022), or stochastic programming (Seljom and Tomasgard 2015). Other common model-based approaches include myopic decision-making (Blesl 2016; Fuso Nerini et al. 2017), rolling horizon (Glomb et al. 2022) or Benders-like decomposition techniques (Cao et al. 2019). These approaches often change the original problem formulation; for example, myopic approaches alter the decision horizon from perfect to limited foresight and this has significant impacts on the decisions taken by the optimizer (Heuberger et al. 2018).

In contrast, “solver-based methods” can help overcome this drawback (Cao et al. 2019). We provide insights on two approaches: a) efficient solver parametrisation for shared-memory systems (e.g., personal computers); b) efficient exploitation of the block-diagonal structure of the matrix of energy systems models for parallel solving in distributed computing systems (clusters). We use the IBM ILOG CPLEX/Barrier interior point solver (IBM 2017) to demonstrate the first strategy—the insights discussed also apply to other implementations of the Barrier algorithm. The second strategy involves the new PIPS-IPM++ solver (Rehfeldt et al. 2019, 2022), which was developed within the BEAM-ME project (Borggrefe et al. 2017; Scholz et al. 2020). In this project, the goal was to design and test the PIPS-IPM++ solver in accelerating large-scale energy system models, among which was also the TIMES model used and described in this paper. While in BEAM-ME the potential of PIPS-IPM++ in speeding up the large-scale models was verified, the project also revealed several challenges to be addressed in the solver in order to be applicable to models with many sectoral and technology interdependencies. These challenges are also discussed in the current paper. PIPS-IPM++ development continues in the follow-up project UNSEEN (DLR 2023) in an attempt to improve the performance of solver when dealing with multi-carrier and multi-sectoral models.

These two solver-based methods, the Barrier solver parametrization and the application of the PIPS-IPM++ solver, are illustrated with EUSTEM (Pattupara and Kannan 2016), an energy systems model based on the open-source TIMES modelling framework of the IEA-ETSAP (Loulou et al. 2016). EUSTEM is written in GAMS (Rosenthal 2017), which already includes a link to the PIPS-IPM++ solver and supports distributed computing (Fiand 2018). We create instances of EUSTEM of different temporal and spatial resolutions and various matrix sizes suitable for assessing SDG-7 and SDG-13.

The chapter is organised as follows: Sect. 2 discusses the creation of EUSTEM instances and provides algorithmic insights of CPLEX/Barrier and PIPS-IPM++ relevant to accelerating the solution. Section 3 demonstrates a heuristic to find an optimal set of options for CPLEX/Barrier to reduce the model run times by using an EUSTEM instance as an example. Section 3 also presents the workflow for solving the model with PIPS-IPM++ in computer clusters. The chapter concludes in Sect. 4 with a discussion about the advantages of solver-based methods, potential drawbacks, and insights gained for improving the SDGs analysis.

2 Methodology

2.1 Overview of the EUSTEM Model

EUSTEM is a technology-rich bottom-up model that calculates the minimum cost configuration of Europe's electricity, hydrogen and heat systems. It combines a long-term horizon with high intra-annual resolution (timeslices). The original version of EUSTEM (Pattupara and Kannan 2016) includes 11 regions representing geographical aggregations of the European countries (Fig. 1a), with a model horizon from 2015 to 2050 that is divided into 8 periods: 2015, 2017, 2020, 2025, 2030, 2035, 2040 and 2050. The intra-annual resolution in each period is 288 timeslices, based on average days, corresponding to 4 seasons, 3 days per season (working day, Saturday and Sunday) and 24 h per day. EUSTEM includes a rich set of operating constraints of the power plants, described in Panos and Lehtilä (2016), representation of ancillary markets (Panos et al. 2019) and the electricity transmission grid following (Lehtilä and Giannakidis 2013). It includes resources, policy (e.g., bans or targets), and societal and behavioural constraints (e.g., rate of technology acceptance). A full model description is given in Pattupara (2016).

2.1.1 Generation of EUSTEM Instances with High Temporal and Spatial Resolution

EUSTEM is modified in this work to support 1–22 regions. The time horizon remains from 2015 to 2050, but the length of the periods can vary from 1 to 5 years. The timeslices in the new version range from 48 to 8076 with intermediate values 72, 144, 288, 672, 1344, 2016, and 4032. Their selection is based on representative days using the methodology developed by Poncelet and Duerinck (2017). These modifications allowed us to produce EUSTEM model instances of different matrix sizes, memory and solution time requirements.

Figure 1b shows the approach for flexibly creating EUSTEM instances. All required data is collected for 22 regions and 8760 timeslices, and each input parameter is specified from 2015 to 2050; this is the largest EUSTEM instance from which all other instances are derived. When going from finer to coarser

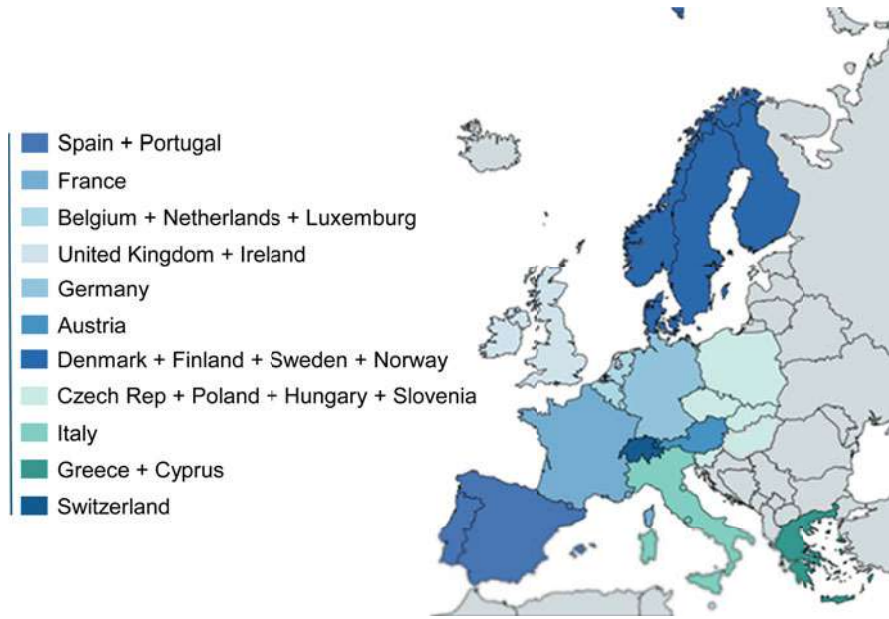

(a)

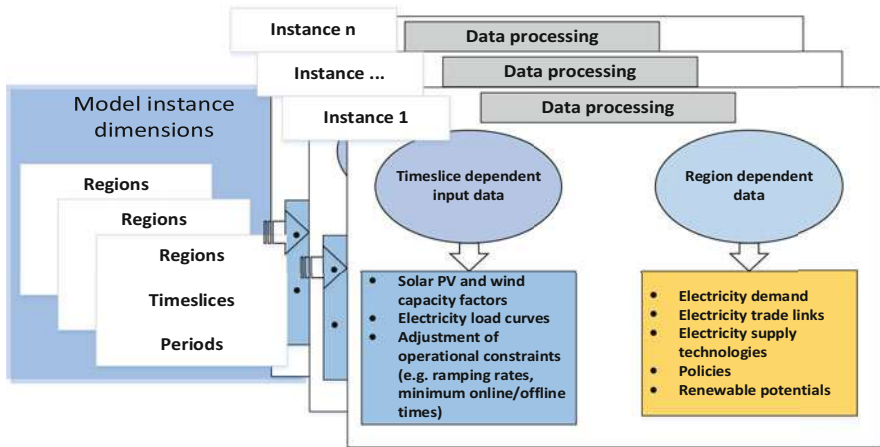

(b)

Fig. 1 (a) Spatial resolution of EUSTEM at 11 regions (b) EUSTEM database for instance generation

instances, model data is aggregated straightforwardly or via heuristics, e.g., weighted aggregation based on the 2015 statistics (IEA 2016). A “copper plate” approach is assumed for cross-regional trade matrices when zooming out the spatial

Table 1 Matrix sizes of some of the EUSTEM instances with different spatial and temporal resolution

Instance (XXX_YY_ZZ) XXX = timeslices YY = regions ZZ = periods	Variables (millions, before CPLEX Presolve)	Equations (millions, before CPLEX Presolve)	Non-Zeros (millions, before CPLEX Presolve)	Memory to generate the instance (GB, before CPLEX, Presolve)	% of equations and variables eliminated by CPLEX Presolve
48_1_8	0.0	0.0	0.2	0.0	19%
48_11_8	0.6	0.4	3.2	0.3	18%
48_22_8	1.2	0.9	6.0	0.7	19%
72_11_8	1.5	1.7	10.1	1.0	22%
72_22_8	4.1	3.1	20.1	2.1	22%
144_11_8	4.6	3.3	24.1	2.3	17%
144_22_8	8.2	6.0	42.6	4.2	20%
288_11_8	8.3	12.3	118.8	10.2	31%
288_22_8	15.5	22.6	218.3	18.9	31%
288_11_20	55.2	36.8	551.5	46.5	28%
672_11_8	19.4	28.6	446.4	38.9	29%
672_22_8	53.7	36.7	839.1	73.1	29%
1344_11_8	57.1	38.7	892.3	77.6	34%
2016_11_8	85.7	58.1	1340.6	116.7	29%
4032_11_8	171.3	116.1	2680.8	237.9	26%
8076_11_8	257.2	376.2	5360.1	359.2	28%

dimension. Where aggregation of the trade corridors is necessary, we treat them as parallel when adjusting their capacities and technical characteristics.

EUSTEM parameters depending on the intra-annual resolution, such as ramping constraints, minimum online and offline times of power plants, resource availabilities and demand load curves, are adjusted from the 8760 timeslices to coarser timeslices by accounting for the duration of the latter as required in Loulou et al. (2016) and Panos and Lehtilä (2016). The peak reserve margin is also adjusted across instances, as coarser instances need a higher margin than “finer” ones. The adjustment ensures the same maximum available capacity requirements for 2015 in all instances.

Table 1 presents a subset of the EUSTEM instances and their matrix sizes. The last column refers to the percentage of eliminated equations and variables by CPLEX \Presolve because of dependency, substitutions and aggregations. It is worth noting that the reduction percentage of the TIMES model matrices is smaller than for other frameworks, for example, in ELMOD, which also participated in BEAM-ME (Borggrefe et al. 2019). This is because TIMES runs a sophisticated reduction algorithm to substitute variables before GAMS passes the matrix to the solver.

2.2 Using the CPLEX/Barrier Interior Point Solver for Shared-Memory Systems

In this section, we discuss features of IBM ILOG CPLEX/Barrier interior point solver (IBM 2017) relevant for speeding up the solution process in a shared memory system; additional solution accelerating insights related to CPLEX/Barrier are discussed in Klotz and Newman (2013). The insights in this section also apply to other commercial and non-commercial implementations of the Barrier algorithm.

In our discussion, we assume a linear programming problem of m equations and n variables. Its standard primal formulation is $\min c^T x$ subject to $Ax = b$ with $x \geq 0$. The corresponding dual problem is $\max y^T b$ subject to $y^T A \leq c^T$ with $y \in \mathbb{R}$. A solution x^* and y^* is optimal for both problems if and only if it satisfies the feasibility of the primal and dual problems and the closure of the optimality gap $c^T x^* - b^T y^* = 0$.

2.2.1 Accelerating the Cholesky Factorisation of CPLEX/Barrier

CPLEX/Barrier maintains in each iteration k a Cholesky factorisation $(\widehat{AA}^T) = \widehat{LL}^T$ where $\widehat{A} = A \cdot \text{Diag}(x_k)$ with x_k the feasible solution in iteration k . The number of non-zero elements (i.e., the density) in \widehat{AA}^T influences the complexity of the Cholesky factorisation and the solver run time. Because \widehat{A} is derived by multiplying A with the diagonal matrix $\text{Diag}(x_k)$, the number of non-zeros in AA^T and \widehat{AA}^T is the same and depends on the structure of A . Even if A is sparse the AA^T can be dense. To reduce the density of $(AA^T) = LL^T$, and the number of floating-point operations to factor, the Barrier algorithm spends significant time to reorder A . Whether the primal or dual problem formulation results in low solution times depends on the non-zero structure of A as dense rows in primal (i.e., rows with many non-zero coefficients) become dense columns in dual and vice versa. A high number of dense columns reduces the effectiveness of the Cholesky factorisation. CPLEX/Barrier can handle a modest number of dense columns (Wright 1997), but undetected dense columns slow down the algorithm, while many dense columns can cause numerical instabilities (Klotz and Newman 2013).

Thus, reducing the complexity of the Cholesky factorisation is a priority in accelerating the solution time. Table 2 lists the key CPLEX/Barrier options that can be tested to achieve this and provides suitable explanations based on the above discussion.

2.2.2 Improving the Starting Point and Avoiding “Wasted” Iterations in Barrier

The performance of interior point methods also depends on their ability to closely follow the central path and avoid prematurely approaching the boundary of the

Table 2 Overview of solver options relevant to the complexity of the Cholesky factor

Option	Value	Meaning	Why this option is relevant for reducing the solution time
Predual	-1	Do not give the dual to optimiser	It is not straightforward if the dual problem performs better than the primal, as it depends on the non-zeros in A . Often forcing the primal (i.e. Predual = -1) improves the performance.
	0	Automatic	
	1	Give the dual to optimiser	
Barcolnz	0	CPLEX finds the number of non-zeros above which the column is considered as dense	Dense columns degrade the performance of the optimiser. They are treated with specific algorithms to mitigate their negative effect. If too many dense columns are detected, they create numerical instabilities; if too few, the performance is not improved much.
	>0	User-specified value indicating the number of non-zeros above which a column is considered as dense	
Barorder	0	Automatic	The reordering of the matrix A can reduce the fill-in in the Cholesky factor, i.e., the difference in the non-zeros between the Cholesky factor and the lower triangular matrix of AA^T . The AMD algorithm provides good quality in moderate time spent for the reordering, the AMF usually results in 5–10% smaller factors than AMD, while the ND produces significantly smaller factors but at higher time spent for performing the permutation of the rows of the A matrix.
	1	Approximate Minimum Degree (AMD)	
	2	Approximate Minimum Fill (AMF)	
	3	Nested Dissection (ND)	

feasible region (Gondzio 2012) that will slow down the algorithm by performing small steps to convergence. Maintaining the central path depends on the starting point and convergence criterion. However, in contrast to Simplex, there is no way to use a previous solution as a starting point in Barrier, and heuristics are applied to construct starting points that are: a) close to primal and dual feasibility; b) to be well-centered; and c) to be as close to optimality as possible (Mehrotra 1992; Skajaa et al. 2013; Gondzio 2016).

The convergence criteria for feasibility and optimality in interior point methods are based on relative measures and tolerances. In Barrier, the feasibility of the primal problem is assessed with respect to the variables' value in the solution: $\frac{\|Ax - b\|}{1 + \|x\|} \leq tol$, where tol is a tolerance. The optimality criterion is usually based on a normalised duality gap (Klotz and Newman 2013): $\frac{|c^T x - y^T b|}{(1 + |c^T x|)} \leq tol$. The above implies that: a) interior point methods cannot produce a basic solution; and b) violations of the constraints can occur as long as the feasibility tolerance is satisfied. To transform the

Table 3 Overview of options relevant to the iterations’ performance of the barrier algorithm

Option	Value	Meaning	Why this option is relevant for reducing the solution time
Baralg	0	Same as 1 for MIP, 3 otherwise	Usually, the standard barrier algorithm performs well in most cases. However, if the problem has numerical instabilities, choosing options 1 or 2 might improve the solution times. The baralg = 1 and baralg = 2 differ from each other in how they compute the starting point.
	1	Infeasibility-estimate start	
	2	Infeasibility-constant start	
	3	Standard barrier algorithm	
	>0	User-specified value indicating the number of non-zeros above which a column is considered as dense	
Barstartalg	1	Default primal, dual is zero	These are four heuristics for the starting point. Option 1 and 2 might work well when we pass the primal problem. When we pass the dual is worth checking options 2 and 4. Option 3 is usually slower than the others.
	2	Default primal, estimate dual	
	3	Primal average, dual is 0	
	4	Primal average, estimate dual	
Barepcomp	1E-8	Convergence and optimality tolerance: default 1E-8	Reducing the tolerance avoids wasted iterations, i.e., iterations in which the progress to convergence is very slow. Increasing the tolerance might improve the performance of the Crossover, but it risks wasted iterations or reporting the problem as infeasible.

interior-point solution to a basic one, the Crossover algorithm is invoked. However, Crossover does not benefit from parallel hardware, while its performance depends on the “quality” of the interior point solution, which in turn is based on the tolerances *tol*. A small tolerance can improve the performance of Crossover but increases the CPLEX/Barrier iterations; it also entail the risk that the problem is reported as infeasible by the algorithm. A small tolerance can cause the Barrier to be stuck in iterations with low progress towards optimality (see also the discussion on the “wasted iterations” in Sect. 3.1.4).

Therefore, improving the starting point of the Barrier algorithm and reducing the “wasted” iterations can help accelerate the solution times. Table 3 lists key options to achieve this.

2.2.3 Accelerating the Crossover Algorithm

The Crossover algorithm has two main phases involving Simplex. In the first phase, Crossover pushes all primal superbasic variables to their bounds. Superbasic is a non-basic variable that is neither at the lower nor at the upper bound. The dual

Table 4 Overview of options relevant to the iterations' performance of the Crossover algorithm

Option	Value	Meaning	Why this option is relevant for reducing the solution time
Ppriind (for primal) Dpriind (for dual)	-1	Reduce cost pricing	Option -1 is less compute-intensive and suitable for dense problems. Option 0 is the default. Option 1 might be useful for difficult problems taking many iterations. If Option 1 helps reduce solution times, option 2 can also be worth trying. Option 2 can be used for even more difficult problems than option 1 can tackle, but it is computationally expensive. Option 3 reduces the computationally intensive nature of option 2.
	0	Hybrid reduced cost and devex pricing	
	1	Devex pricing	
	2	Steepest edge pricing	
	3	Steepest edge pricing with slack initial norms	
	4	Full pricing	
	2	Default primal, estimate dual	
	3	Primal average, dual is 0	
Barcrossalg	0	Automatic	By default, CPLEX invokes primal and dual Crossover when multiple threads are available in a concurrent optimisation. Otherwise, the choice depends on the type of the problem being solved (primal or dual). Although the default option works well in most cases, forcing the primal (when solving the primal problem) or dual (when solving the dual problem) to Crossover might reduce the solution time.
	1	Primal Crossover	
	2	Dual Crossover	

superbasic variables are pushed to the bounds in the second phase. Crossover solves $Ax^* = Bx_B + Sx_s = b$, where x_B is the basis and x_s are the superbasic variables. When there is a superbasic variable x_j between its lower and upper bounds l_j and u_j respectively (i.e., $l_j \leq x_j \leq u_j$) Crossover either pushes $x_j \rightarrow (l_j \text{ or } u_j)$ (push-move) or moves x_j into the basis and pushes another basic variable $x_i \rightarrow (l_i \text{ or } u_i)$ (exchange-move). The choice of the variable to be moved is based on the pricing algorithm, affecting the performance. The options shown in Table 4 could accelerate the Crossover algorithm.

2.2.4 Using Parallel Mode in Barrier

CPLEX/Barrier can exploit multiple nodes in shared-memory systems during the Cholesky factorisation, to perform simultaneous linear algebra operations (Bisseling et al. 1993; Karypis et al. 1994). However, experience shows that the performance does not improve after a few nodes, or even deteriorates due to CPU-memory communication overhead (Panos 2022) (Fig. 2).

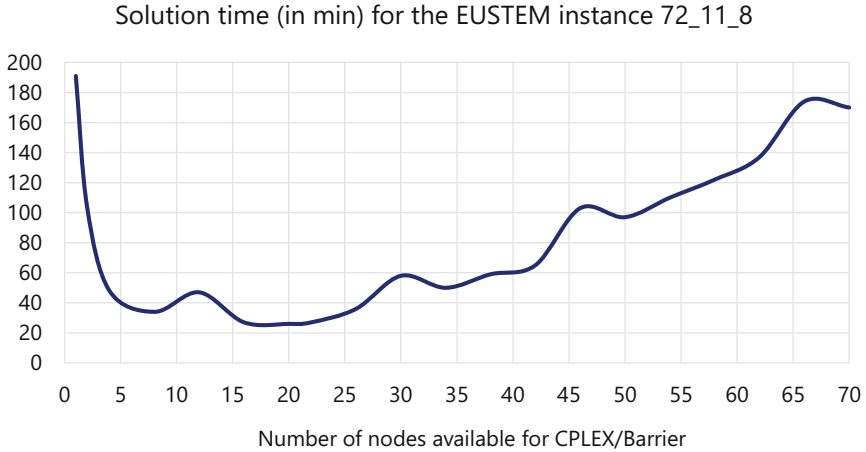

Hardware: HPE Apollo XL230K Gen10 blade with 2 Intel® Xeon® Gold 6152 Scalable Processors @ 2.10GHz (2 x 22 cores, 384GB RAM)
 Fluctuations in the solution time are due to the variable cluster workload where the tests were made
 The number of nodes available to CPLEX/Barrier is controlled using the "Threads" option of the algorithm

Fig. 2 Performance of CPLEX/Barrier over multiple nodes for one of the EUSTEM instances

2.3 Using the PIPS-IPM++ Parallel Interior Point Solver for Distributed-Memory Systems

PIPS-IPM++ (Rehfeldt et al. 2019, 2022) is a new interior point solver based on the linear programming parallel solver PIPS-IPM (Petra et al. 2014). It exploits the doubly bordered block diagonal structure (Wilkinson 1965) of the typical energy systems model matrices to solve them in distributed-memory systems (Breuer et al. 2018). Figure 3 shows a typical block-diagonal structure of a model matrix. This structure is revealed by permutating the matrix to group variables and equations into blocks assigned to different nodes for parallel solving. Still, some variables and equations span across several blocks. These are called linking variables and equations. For example, if the blocks correspond to the geographical regions of a model, the global carbon budget constraints are of a linking nature.

The PIPS-IPM++ parallel interior point solver uses a Shur Complement decomposition (Zhang 2005), which exploits the block structure of the model matrix to perform efficient inversions and factorisation operations on it. It is combined with a distributed preconditioning of the linear system (Wathen 2015), which transforms the system from $Ax = b$ to $P^{-1}Ax = P^{-1}b$, where P^{-1} is the "preconditioner"; a suitable approximation of A^{-1} to reduce the sensitivity of A to input data perturbations and roundoff errors during the solution process. PIPS-IPM++ also implements multiple-corrector schemes for the interior point algorithm, scaling methods and presolving techniques (Rehfeldt et al. 2022).

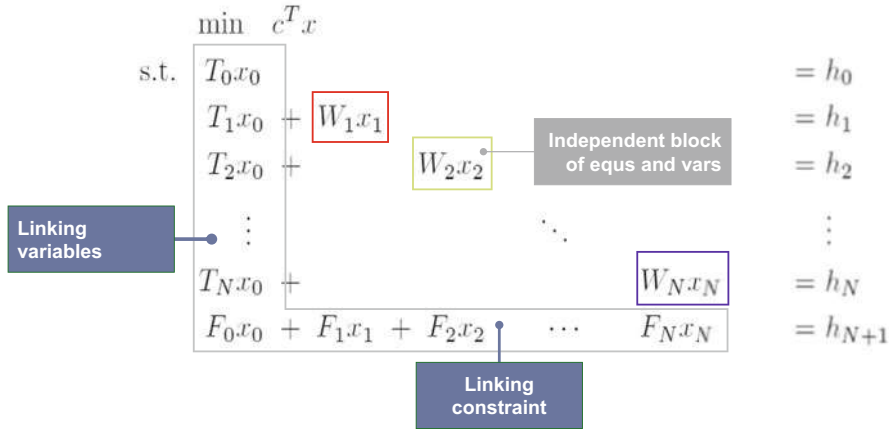

Fig. 3 Block structure of the model matrix, linking variables and constraints (Rehfeldt et al. 2022)

The performance of PIPS-IPM++ depends on the size of the Schur Complement, which is affected by the number of linking variables and constraints. The implementation of PIPS-IPM++ outperforms the interior point algorithms in shared-memory systems if there are more than 50 individual blocks in the model matrix to offset the message passing overhead between nodes and the number of linking variables and equations is up to 300,000.

2.3.1 Annotating Variables and Equations to Reveal the Block Structure of the Model Matrix

The procedure to manually group the variables and equations into blocks or characterise them as linking variables and constraints is called “annotation”. Figure 4a shows the “random” non-zero structure of the original model matrix A . Figure 4b, c show the outcome of the annotation, i.e., the model’s block structure (Fiand 2018). GAMS supports annotation through the `.stage` attribute of variables and equations. When annotating the model, PIPS-IPM++ requires the following (Fig. 4d):

- Linking variables are assigned to block 1 (i.e., `<variable_name>.stage = 1`). By default, all variables are assigned to block 1. The objective variable is a linking variable.
- All non-linking variables are assigned to blocks 2, ..., $k + 1$ (i.e., `<variable_name.stage = 2, ..., k + 1`) where k is the total number of blocks.
- Constraints that contain only linking variables belong to block 1 (i.e., `<equation_name>.stage = 1`). The objective function is a linking constraint.
- Constraints containing variables from 2 or more different blocks are linking constraints and belong to the block $k + 2$ (i.e., `<equation_name>.stage= k + 2`).

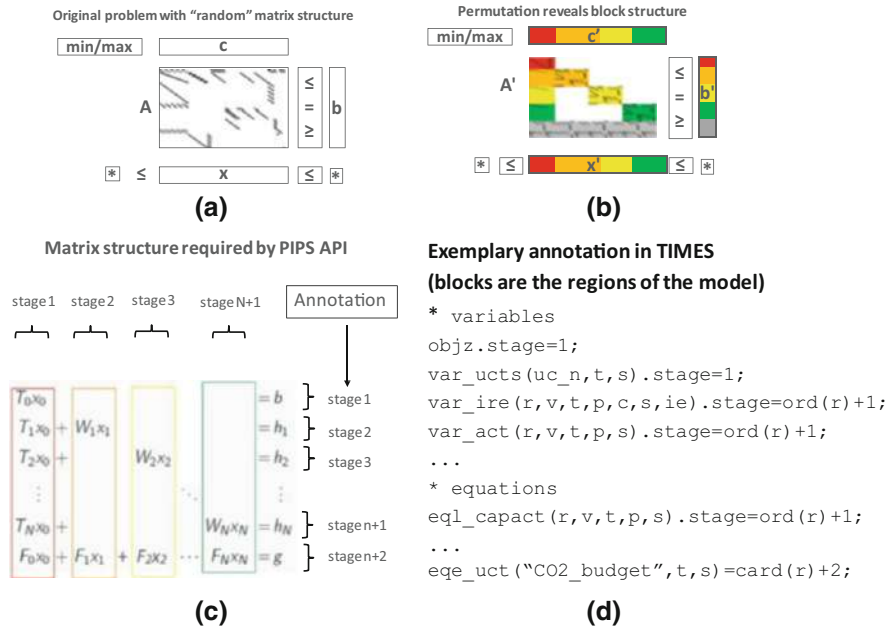

Fig. 4 (a) the non-zero structure of an original matrix of TIMES model; (b) the same matrix after annotating the model to group the equations and variables into individual blocks; the grey area denotes linking variables and constraints; (c) mapping of blocks to values for the .stage attribute of variables and equations in GAMS; (d) GAMS code example that identifies blocks based on regions. (The images in panels (a)–(c) are reproduced with permission from Fiand (2018))

- All other constraints that contain variables from only one of the blocks 2, . . . , $k + 1$ are assigned to these blocks (i.e., `<equation_name>.stage = 2, . . . , k + 1`).

Good practices for annotating the model for PIPS-IPM++ are extensively discussed in Scholz et al. (2020). The most important ones are summarised below:

- The blocks should be as many as possible, of equal sizes and as small as possible.
- Linking constraints are preferable to have variables from two consecutive blocks or at least to have variables that belong to non-very-distant blocks.
- The total number of linking variables and constraints should not exceed 300,000.

The modeller shall try different strategies to create blocks of equations and variables. Experience shows that efficient annotations create blocks across multiple dimensions, e.g., regions and periods or regions and timeslices. Finding the most efficient annotation that leads to many small blocks and a small number of linking variables and equations requires good model and domain knowledge.

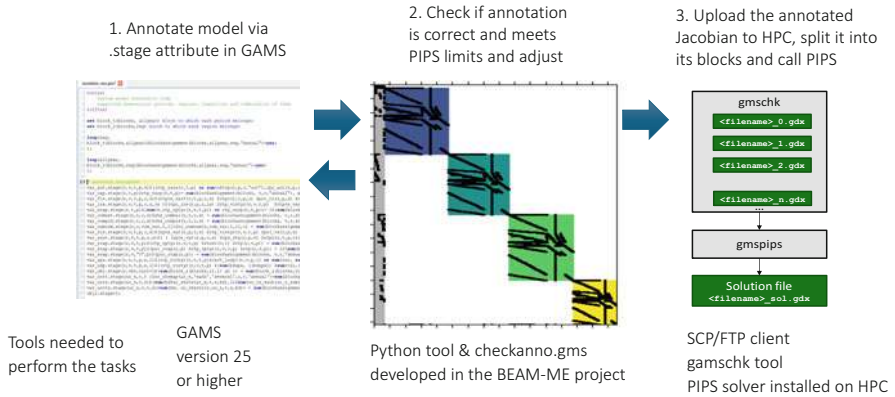

Fig. 5 The workflow for solving EUSTEM with PIPS-IPM++ on High-Performance computing cluster

2.3.2 How to Solve an Annotated Model with the PIPS-IPM++ Solver

Assuming that PIPS-IPM++ is installed on a computer cluster¹ and the annotation has been performed, a workflow for solving the model is shown in Fig. 5. The main steps are as follows (Fiand 2018; Scholz et al. 2020):

1. The annotated model should be solved with the CONVERT solver² to get the Jacobian.
2. The Jacobian can be checked using the checkanno.gms tool for correct annotation.³
3. The annotated Jacobian can be uploaded to the computer cluster, where it can be split into its blocks, linking variables and constraints using the GAMS utility *gmschk*.⁴
4. The PIPS-IPM++ solver can be invoked as described in its latest documentation.⁵
5. The solution can be collected as a .GDJ file and processed on the local computer.

¹For obtaining the solver, documentation and installation instructions: <https://github.com/NCKempke/PIPS-IPMpp>

²See https://www.gams.com/latest/docs/S_CONVERT.html

³The checkanno.gms can be obtained from the BEAM-ME repository: <https://gitlab.com/beam-me/simple-pips> The tool can check whether the number of linking variables and constraints meets the PIPS-IPM++ requirements

⁴The *gmschk* is supplied with the Linux GAMS distribution. To split the Jacobian into blocks it should be called as “*gmschk -t -X -g '%gams.sysdir%' %number_of_blocks% < jacobian_filename.gdx*” without the double quotes

⁵See <https://github.com/NCKempke/PIPS-IPMpp>

3 Results

In this section, we first demonstrate a heuristic to find a set of options for CPLEX/Barrier for accelerating the EUSTEM instance 72_11_8 in a shared memory system, e.g., a personal computer. Then, we demonstrate the parallel solving of a model matrix in computer clusters using instances 288_11_8 and 288_22_8, which are large enough to be solved with PIPS-IPM++. We conclude the section by discussing the analysis value-added by avoiding the model aggregation.

3.1 *How to Accelerate the CPLEX/Barrier in Shared-Memory Systems*

Each section below describes the heuristic steps to identify suitable options for the Barrier solver. It should be noted that the reduction achieved in each step depends on the non-zero structure of the model matrix and, hence, varies in the different models.

3.1.1 **Step 1: Examining if Passing the Primal Problem Performs Better Than Dual**

The ratio of the number of variables to constraints in instance 72_11_8 is such that the CPLEX Presolve heuristic passes the dual problem to Barrier by default. This resulted in solution times exceeding 9 h. However, by forcing **Predual** = **-1** and passing the primal problem, the obtained solution time dropped to 113 min, of which 30 min were for Barrier and 83 min were for Crossover. Additional tests showed that CPLEX/Barrier for TIMES-based models performs better when solving the primal instead of the dual.

3.1.2 **Step 2: Identifying the Number of Dense Columns to Minimise Cholesky Factorisation Complexity**

To determine the number of dense columns, the column density histogram of the model matrix⁶ can help find a threshold for the number of non-zero elements above which a column is characterised as dense. By default, CPLEX/Barrier detects 319 dense columns for the primal formulation of instance 72_11_8, but by looking at the column density histogram shown in Fig. 6a, the value of 150 non-zeros seems

⁶The column density histogram can be obtained by using the interactive CPLEX (see https://www.gams.com/latest/docs/S_CPLEX.html#CPLEXinteractive) and entering the command “display problem histogram c” (without quotes)—see also <https://www.ibm.com/docs/en/icos/22.1.1?topic=cplex-table-commands-interactive-optimizer>

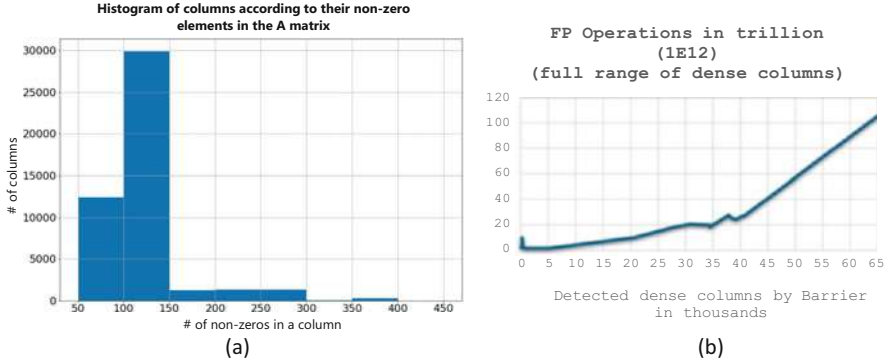

Fig. 6 (a) the column density histogram for instance 78_11_8; (b) the number of floating-point operations required for the Cholesky factorisation as a function of the number of dense columns for the instance 78_11_8

to be a more suitable threshold. Indeed, by setting **Barcolnz** = 150, the detected dense columns are 2906. This value also minimises the number of floating-point operations to factor (Fig. 6b) and reduces the solution time from 113 to 84 min; of which 29 min for Barrier and 55 for Crossover. The reduction of almost 20 min in the Crossover in this step compared to the time obtained in the previous step of the heuristic algorithm is also a result of Cholesky factorisation’s reduced complexity, which improved the interior point solution’s quality and resulted in fewer primal and dual pushes in the Crossover. If multiple peaks exist in a column density histogram, exploring different cut-off thresholds, especially those corresponding to the peaks, is necessary.

3.1.3 Step 3: Exploring Different Ordering Algorithms and Starting Point Heuristics for Barrier

The next step is mostly a trial-and-error procedure, examining different options for ordering the matrix A and finding a suitable starting point for the iterations. Based on the examined instances, **Barorder** = 0 or **Barorder** = 3 produces the best A matrix ordering results for TIMES-based models. Also, the EUSTEM instances (and other TIMES-based instances) performed better when setting **Baralg** = 3 than using other Baralg values. Since we pass the primal problem, opting for **Barstartalg** = 1 or **Barstartalg** = 2 to identify the starting point could help. In our test case 72_11_8, by setting **Barorder** = 0, **Baralg** = 3 and **Barstartalg** = 1, we reduced the solution time from 84 to 38 min, of which 23 are for Barrier and 15 for Crossover.

Itn	Primal Obj	Dual Obj	Prim Inf	Upper Inf	Dual Inf	Duality gap	Itn	Primal Obj	Dual Obj	Prim Inf	Upper Inf	Dual Inf	Duality gap
0	7.99E+11	-4.50E+10	8.19E+09	4.62E+08	1.39E+10	1.056385E+00	183	6.59E+09	6.59E+09	3.81E-02	4.55E-10	5.53E+00	4.552347E-08
1	7.24E+11	-1.06E+11	7.19E+09	4.06E+08	1.12E+10	1.145917E+00	184	6.59E+09	6.59E+09	3.81E-02	4.85E-10	5.87E+00	4.552347E-08
2	6.12E+11	-2.03E+11	5.34E+09	3.01E+08	8.69E+09	1.330828E+00	185	6.59E+09	6.59E+09	3.81E-02	5.13E-10	6.00E+00	4.552347E-08
...	186	6.59E+09	6.59E+09	3.81E-02	5.33E-10	6.15E+00	4.552347E-08
170	6.59E+09	6.59E+09	1.98E-02	1.94E-10	4.94E+00	2.124429E-07	187	6.59E+09	6.59E+09	3.82E-02	5.57E-10	6.54E+00	4.552347E-08
171	6.59E+09	6.59E+09	2.27E-02	2.24E-10	5.11E+00	2.124429E-07	188	6.59E+09	6.59E+09	3.82E-02	5.77E-10	6.42E+00	4.552347E-08
172	6.59E+09	6.59E+09	2.70E-02	2.26E-10	4.71E+00	1.517449E-07	189	6.59E+09	6.59E+09	3.82E-02	6.04E-10	6.79E+00	4.552347E-08
173	6.59E+09	6.59E+09	2.73E-02	2.80E-10	4.88E+00	1.517449E-07	190	6.59E+09	6.59E+09	3.84E-02	6.19E-10	6.99E+00	4.552347E-08
174	6.59E+09	6.59E+09	2.74E-02	3.18E-10	5.36E+00	1.517449E-07	191	6.59E+09	6.59E+09	3.84E-02	6.42E-10	7.11E+00	4.552347E-08
175	6.59E+09	6.59E+09	3.61E-02	1.97E-10	5.28E+00	6.069796E-08	192	6.59E+09	6.59E+09	3.84E-02	6.56E-10	7.57E+00	4.552347E-08
176	6.59E+09	6.59E+09	3.61E-02	2.55E-10	5.60E+00	6.069796E-08	193	6.59E+09	6.59E+09	3.87E-02	6.63E-10	7.52E+00	4.552347E-08
177	6.59E+09	6.59E+09	3.61E-02	3.02E-10	5.54E+00	6.069796E-08	194	6.59E+09	6.59E+09	3.87E-02	6.81E-10	7.83E+00	4.552347E-08
178	6.59E+09	6.59E+09	3.61E-02	3.47E-10	5.60E+00	6.069796E-08	195	6.59E+09	6.59E+09	3.90E-02	6.90E-10	7.97E+00	4.552347E-08
179	6.59E+09	6.59E+09	3.62E-02	3.75E-10	5.63E+00	6.069796E-08	196	6.59E+09	6.59E+09	3.90E-02	7.09E-10	7.80E+00	4.552347E-08
180	6.59E+09	6.59E+09	3.62E-02	3.98E-10	5.65E+00	6.069796E-08	197	6.59E+09	6.59E+09	3.90E-02	7.28E-10	7.75E+00	4.552347E-08
181	6.59E+09	6.59E+09	3.78E-02	3.98E-10	5.66E+00	6.069796E-08	198	6.59E+09	6.59E+09	3.92E-02	7.38E-10	7.68E+00	4.552347E-08
182	6.59E+09	6.59E+09	3.80E-02	4.23E-10	5.70E+00	4.552347E-08	199	6.59E+09	6.59E+09	3.92E-02	7.56E-10	7.87E+00	4.552347E-08
							200	6.59E+09	6.59E+09	3.92E-02	7.70E-10	8.46E+00	4.552347E-08
							201	6.59E+09	6.59E+09	3.92E-02	7.94E-10	8.52E+00	4.552347E-08
							*	6.59E+09	6.59E+09	3.81E-02	4.55E-10	5.53E+00	4.552347E-08

Fig. 7 The CPLEX/Barrier log and the calculated normalised duality gap, showing that wasted iterations occur after iteration 182

3.1.4 Step 4: Eliminating “Wasted” Iterations

The Barrier output log shown in Fig. 7 for the instance 72_11_8 reveals that after iteration 182, very little progress has been made in the objective function and the normalised duality gap (calculated separately in the figure). Hence, the iterations 183–201 are “wasted iterations”. To eliminate that, we need to change the optimality criterion tolerance, which, for the primal problem, is $\frac{|c^T x - y^T b|}{(1 + |c^T x|)} \leq 10^{-8}$. Given that in iterations 183–201 we have a duality gap of around $4.55 \cdot 10^{-8}$, we can increase the tolerance **Barepcomp** to $4.7 \cdot 10^{-8}$ and stop at iteration 182. This reduces the total solution time to 36 min, of which 16 is for Crossover and 20 for the Barrier iterations.

3.1.5 Step 5: Accelerating the Crossover Algorithm

To further reduce solution time for the instance 72_11_8, we can set **Barcrossover** = 1, since we pass the primal problem to Crossover (Table 3). This reduces Crossover time by 6 min, and the overall solution time is 30 min. Recalling also that the optimality tolerance affects the quality of the solution passed to Crossover, by slightly adjusting **Barepcomp** from $4.7 \cdot 10^{-8}$ to $4.6 \cdot 10^{-8}$, i.e., by accepting some wasted iterations, the starting point of Crossover is improved and the overall solution time drops to 28 min. Finally, changing the pricing algorithm to **Ppriind** = 3, the solution time is 26 min. It is worth noting that avoiding Crossover result in a solution time of 18 min, but in this case we do not have a basic solution – whether a basic solution is needed depends on the problem being solved (sometimes a near-optimal or a non-basic interior point optimal solution is sufficient) or the use of the basic solution e.g., as an advanced starting point.

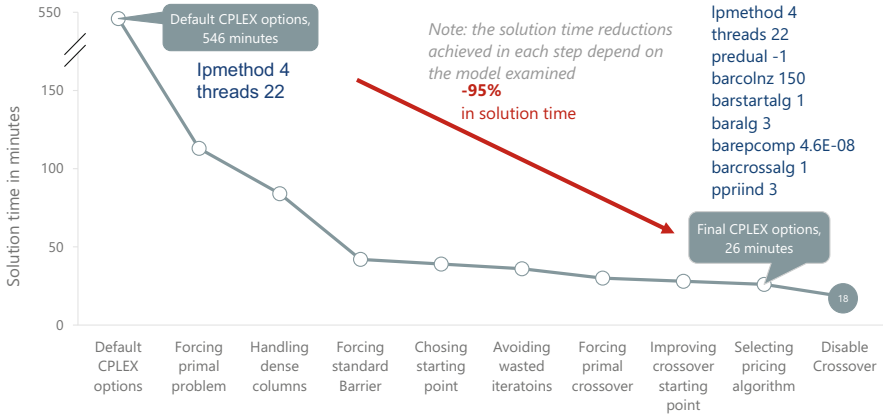

Fig. 8 Overview of the steps to accelerate CPLEX/Barrier in a shared-memory system for the instance 72_11_8 and the final set of CPLEX options found by applying the heuristic

Figure 8 presents an overview of the steps described in Sects. 3.1.1, 3.1.2, 3.1.3, 3.1.4 and 3.1.5 for the EUSTEM instance 72_11_8 in finding the optimal set of Barrier options to accelerate the instance.

3.2 Insights from Parallel Solving with PIPS-IPM++

In BEAM-ME, we found that PIPS-IPM++ cannot efficiently solve all EUSTEM instances due to many linking constraints resulting from the energy system interdependencies represented in the model. The instances 288_11_8 and 288_22_8 were suitable for PIPS-IMP++. They differ in the number of regions, 11 vs 22, and both have 288 timeslices with a time horizon from 2015 to 2050 divided into 8 periods.

3.2.1 Annotation Strategy for the Block Definitions

In TIMES models, the annotation strategy can be based on regions, periods, timeslices, sectors and technologies. Our tests showed that annotating with timeslices, sectors, or technologies might increase linking variables and constraints. Thus, the annotation strategy for instances 288_11_8 and 288_22_8 was based on creating blocks by combining periods and also minimising the “global” linking constraints, i.e. constraints having variables from more than 4 blocks or variables from blocks with a “distance” greater than 9, which deteriorate the PIPS-IPM++ performance. An additional effort was made to avoid having more than 2000 linking constraints per block, an additional limiting factor of PIPS-IPM++.

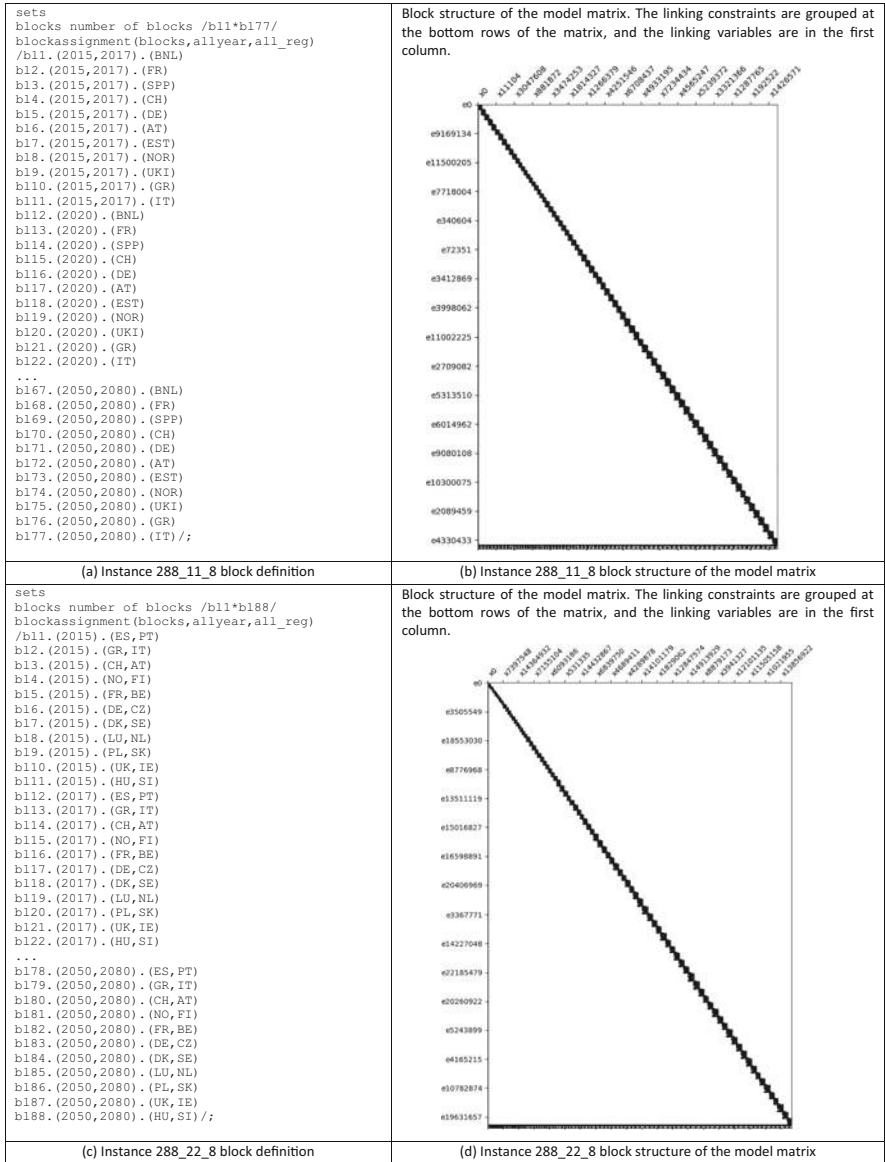

Fig. 9 Block definitions and the block structure of the model matrix after annotation

Figure 9 displays the block definitions for the two instances. Each variable and equation of TIMES is assigned, via its .stage attribute in GAMS, to a block or is considered to be of a linking nature. Instance 288_11_8 produced 97,360 linking constraints and 5251 linking variables, while instance 288_22_8 had 162,169

linking constraints and 16,783 linking variables. By examining the annotation based on periods and regions, we observe the following:

- Linking variables are the objective variable and variables holding intermediate calculations for the objective function, slack variables of user constraints that sum over regions or periods, capacity investment variables and retired capacity variables. The number of linking variables can be reduced if the intermediate variables of the objective function and the slacks of cross-regional or cross-period constraints are eliminated from the TIMES code.
- Linking constraints are cross-regional constraints and cross-period constraints. This implies that when creating the blocks during the annotation, special care should be given to avoid including in the same block regions or periods that are very distant from each other: for example, if two regions, A and B, share a trade link they should be included in the same block or close to each other blocks. Similarly, if region C has trade links with regions D, E, F, and G, it makes sense to include region C in a block which is of a distance less than 4 from the blocks where the regions D, E, F and G are included. By taking care that the distance of blocks responsible for linking constraints and variables is less than 4 would avoid having many global constraints.

3.2.2 PIPS-IPM++ Solution Times

Figure 10 compares the solution times of the two instances with CPLEX/Barrier and PIPS-IPM++. While the solution time in CPLEX/Barrier scales with the size of the instance, the solution time from PIPS-IPM++ remains almost constant. With PIPS-IPM++ models can be scaled up in size without significantly increasing the solution time. Small instances with less than 50 blocks do not benefit much from PIPS-IPM++.

Fig. 10 Solution times for the instances 288_11_8 and 288_22_8 with CPLEX/Barrier and PIPS-IPM++

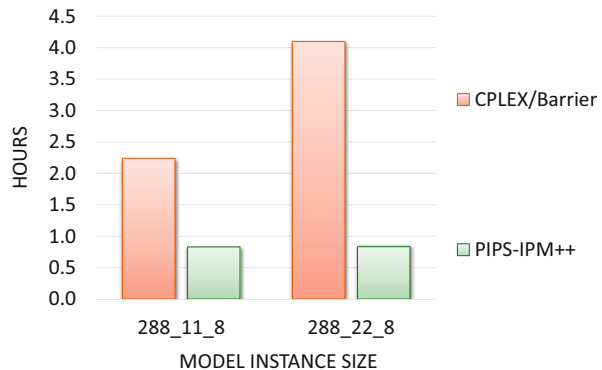

3.3 Insights from Different Spatial and Temporal Resolutions in Modelling SDG7 and SDG13

By being able to solve the EUSTEM instances of Table 1 at reasonable solution times, we demonstrate the need for complex energy systems models in SDG assessment and the insights gained from this additional complexity. We do not aim to repeat the literature on the topic, for example (Allen et al. 2016; van Soest et al. 2019; Barbero-Vignola et al. 2020; Aryanpur et al. 2021), but we focus on a concrete example of the value-added obtained in the analysis by having high spatial and temporal resolution in the modelling of SDG7 (Clean and Affordable Energy) within SDG13 (Climate Action) across three axes: new technology uptake, system flexibility needs and energy system costs. We assess a Baseline scenario for the EU continuing the energy and climate policies from 2015 to 2050 and a Decarbonisation scenario of reducing the EU-wide CO₂ emissions in 2050 by 95% from 2015. In the Decarbonisation scenario, and when applicable by the model's underlying spatial resolution, country-specific targets and policies are also imposed as of the UNFCCC pledges of 2015.

It should be noted that the EUSTEM instances of lower numbers of timeslices or regions are derived from the full model instance of 22 regions with 8760 timeslices. This design implies that these aggregated instances are good approximations of the most accurate version of the model since the latter is used as a benchmark to improve the accuracy of the former, e.g., by introducing in the coarser instances additional parameters and constraints or by adjusting some parameters (such as the reserve margin, see also Sect. 2.1.1). This ideal case, which mitigates the negative effects of model aggregation, is an option only if the most detailed version of the model is available and can be solved within a reasonable time. Therefore, the results below should be understood and interpreted in this context.

3.3.1 Different Regional Aggregations of “Europe” Yields Different Projections of Technology Uptake

We first test the hypothesis that the lack of regional internal structure and socio-economic, environmental and political contexts in the different geographies results in false signals to investors and decision-makers regarding technology uptake at coarser regionalities. We use the EUSTEM instances 288_1_8, 288_5_8, 288_11_8 and 288_22_8, which have 288 timeslices and 8 periods but different regional resolutions.

As shown in Fig. 11, and looking at the solar and wind power plant capacity, there is a higher deployment of intermittent renewables in the Baseline scenario at coarser spatial resolutions. This is a finding similar to other studies in literature (Aryanpur et al. 2021), which is attributable to the lower accuracy of renewable potentials, lack of transmission constraints, etc. However, looking at the Decarbonisation scenario at the right panel of the same figure, the instances with coarser spatial resolutions

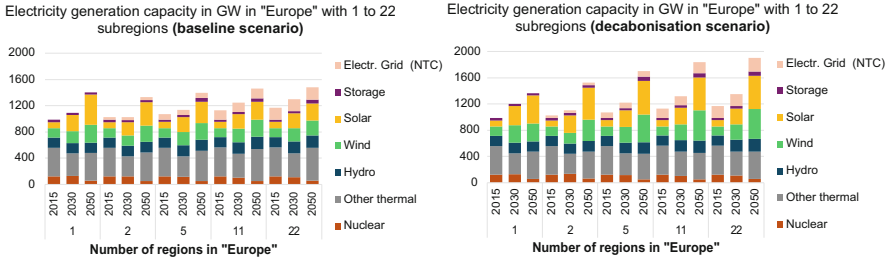

Fig. 11 Generation capacity in “Europe” with different spatial resolution varying from 1 to 22 regions, with 288 timeslices and 8 periods from 2015 to 2050 (instances, 288_1_8, 288_2_8, 288_5_8, 288_11_8 and 288_22_8)

resulted in lower deployment of wind and solar capacity than those with a finer spatial resolution. This is attributable to the lack of accurate representation of the local techno-economic conditions and policy context at coarser geographies, which is particularly relevant in the Decarbonisation scenario that does not only implement the EU-wide CO₂ emissions reduction targets but also national pledges and other energy and climate policies when the spatial resolution is finer.

The above suggests that the heterogeneity of unequal regions in terms of resources and socio-economic and sustainable policy context makes it difficult to find a direct relationship between spatial resolution and technology uptake, as this depends on a case-by-case basis. This example shows that heterogeneous regions must be modelled in great detail to avoid false signals to decision-makers for achieving the SDGs.

3.3.2 Different Timeslices Aggregations Yield Different Projections of Flexibility in the Energy System

Next, we test the hypothesis that aggregating the temporal intra-annual resolution smoothens the fluctuations of energy sources and demand and provides misleading signals regarding the additional measures policymakers need to support high integration levels of renewable energy in the system.

We use the EUSTEM instances, which have 11 regions and 8 periods from 2015 to 2050 but with different numbers of timeslices ranging from 48 to 166, and we focus on the storage capacity deployment in the Decarbonisation scenario.

In line with findings from literature, e.g., in Kannan et al. (2015), Fig. 12 shows that at coarser intra-annual resolutions, storage deployment is less due to the lower supply and demand variability. The underestimation of the flexibility needed in the energy system for integrating renewable energy, here in the form of electricity storage, is notable in Fig. 12. Even when the selection and aggregation of the timeslices are based on advanced approaches, these methods remain sensitive to

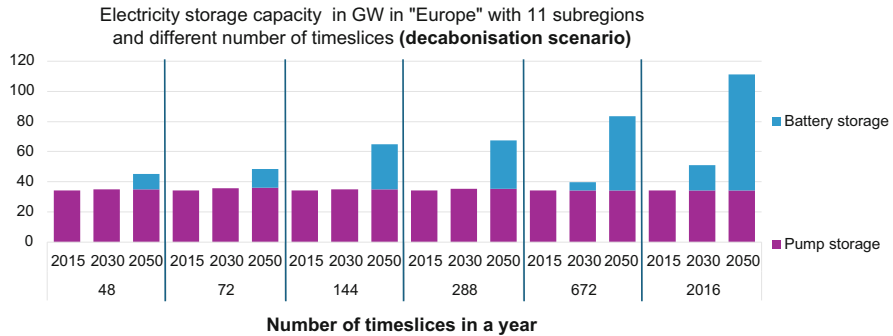

Fig. 12 Pump hydro and battery storage capacity in “Europe” in the Decarbonisation scenario with different intra-annual resolution varying from 48 to 2016 timeslices, with 11 regions and 8 periods from 2015 to 2050 (instances, 48_11_8, 72_11_8, 144_11_8, 288_11_8, 672_11_8 and 2016_11_8)

the number and types of curves (Poncelet and Duerinck 2017; Densing and Wan 2022).

The intra-annual resolution is crucial for SDG7, not only for integrating renewable energy but also when modelling electricity access. High temporal and spatial resolution are important for technology integration and moving from a centralised to a decentralised energy system. Understanding technology integration to deliver SDG7 and SDG13, as well as other SDGs, is important when designing policies to achieve these targets. For instance, based on the example shown in Fig. 12, it would provide misleading insights to decision-makers and stakeholders regarding the role of storage and the need for policies that could support storage systems next to renewable energy technologies.

3.3.3 Different Regional and Temporal Aggregations Yield Different Projections of Energy System Cost

Finally, we examine the impact of different spatial and temporal resolutions on the costs of the energy system and the intensity of the policies (e.g., subsidies or taxes) required to achieve SDG7 and SDG13 for “Europe”. Figure 13 presents the difference in the energy system cost between the Decarbonisation and the Baseline scenarios in instances of different spatial and temporal resolutions. We use as a metric the difference in the costs because this is an indication to decision-makers on what does it cost to meet the targets. This is important for stakeholders since could help develop measures to mitigate these costs for the vulnerable households to also contribute to SDG1 (no poverty).

The results indicate that coarser resolutions regarding timeslices do not always imply lower costs. For example, the instances with 72 timeslices show lower costs than those with 48 timeslices. This is attributable to the more accurate dispatching of

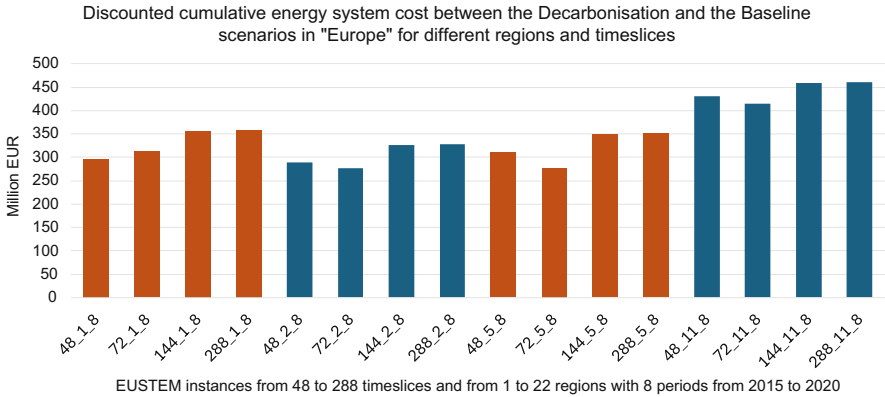

Fig. 13 Difference in the energy system costs between the Baseline and Decarbonisation scenario at different spatial and temporal resolutions; the colours in the chart are used to distinguish between instances of the same spatial resolution

the power plants when using a higher intra-annual resolution. Still, model system costs vary due to the different treatments for increasing spatial resolution. For example, the disaggregation of the transmission grids and renewable resources when increasing the spatial resolution could lead to higher costs. The clear trend in the obtained results is that higher spatial resolutions are associated with higher costs to achieve the renewable and climate change mitigation policy targets. This is because of the better accounting for the local conditions and constraints when performing the impact assessment of energy and climate policies. However, this result is valid only when the higher spatial resolution is modelled with accurate regional data. Otherwise, misleading outcomes might arise, especially when dealing with linear programming (LP) models. For instance, in LP models, even a slight cost difference between two regions might result in investing all new capacity in that region with the lowest cost. In this regard, additional constraints should be imposed, or reformulation of the objective function is needed to avoid “corner solutions” in the optimisation of a multi-regional model.

Besides the above quantitative insights on the increased accuracy in the solutions obtained with higher spatial and temporal resolutions, we should also note that some SDGs are correlated with subnational administrative divisions. For example, SDG6 on clean water and sanitation or SDG11 on sustainable cities and communities require modelling at prefecture or municipality levels by default. Other SDGs, such as SDG1 on poverty elimination, require high spatial resolution and segmentation of households in energy systems and economic models. While SDG9 on industrial infrastructures by design calls for energy system models with accurate representation of the local conditions at subnational levels for new infrastructure development and sector coupling. Therefore, besides accuracy, also the modelling of the SDG themselves calls for high resolution modelling across all the three five main dimensions of energy systems models: space, time, technology, sector and policy.

All the above are only a few examples of SDGs that require complex energy and economic models, which in turn need sophisticated methods to solve them in reasonable times.

4 Conclusions

This chapter introduces two solver-based methods for accelerating the solution of large-scale energy system models that assess the interactions of SDGs. The first method optimises the IBM ILOG CPLEX/Barrier solver for shared-memory systems, while the second method uses the PIPS-IPM++ solver for distributed systems like High-Performance Computing Clusters. We demonstrate the two methods with EUSTEM, a TIMES-based energy system model for Europe, which operates at various spatial and temporal resolutions.

We find that effective parameterisation of the CPLEX/Barrier solver can significantly reduce the solution time compared to using the default options, and this depends on the model matrix's non-zero structure and the Cholesky factorisation's complexity in each iteration of the algorithm. We also find that the solution times with the parallel solver PIPS-IPM++ do not scale with the model size, but this outcome depends on the annotation strategy to reveal the block structure of the model matrix to the solver, on the number of constraints and variables that spanning several blocks, and on the number of blocks of unequal sizes (the fewer, the better).

Solver-based methods can complement model-based techniques and detect model errors. However, applying these methods efficiently requires knowledge of the solver's algorithmic internals and the model's domain and structure. It's important to note that solver parametrisation and model annotation may need to be redone when new variables and equations are introduced. Therefore, solver-based methods may not be equally effective across different models or versions of the same model.

Applying suitable solver-based and model-based methods to reduce the solution times of large-scale energy systems models is important for SDG analysis. SDGs are vastly interlinked and connected to economic, fiscal, energy, environmental and societal variables. Moreover, some targets can negatively influence others, requiring policymakers to undertake arbitrage. Such complex interdependencies require high modelling detail to assess the implications of public policies on SDGs and uncertainty analyses. As energy is at the heart of the economic and social activities to which the SDGs refer, so they are the energy systems models. Without a high level of detail in the modelling, policy impacts might be overestimated, sectoral (and SDG) interdependencies may only be coarsely captured, and there is a misalignment between models with the SDG priorities and policy coherence.

Acknowledgements We thank our colleagues from the BEAM-ME project who provided insight and expertise that greatly assisted the research. We would especially like to thank Fred Fiand and Michael Bussiek from GAMS for their helpful hints and support with GAMS language features and CPLEX\Barrier options. We thank Thomas Breuer and Dmitry Khabi for their help with setting up

and using the computers at the Supercomputing Centers in Jülich (JSC) and Stuttgart (HLRS), respectively. Further, we also thank Daniel Rehfeldt from Zuse Institute Berlin (ZIB) for his tremendous support with the parametrization and operation of the PIPS-IPM++ solver, as well as for solving our instances. Finally, we would like to thank Prof. Dr. Russel McKenna and Dr. Tom Kober from the Paul Scherrer Institute (PSI) for their comments that greatly improved the manuscript.

Credit Author Statement **E. Panos:** Conceptualisation; Methodology; Software; Supervision; Writing—original draft; Writing—review and editing; Funding acquisition. **A. Hassan:** Methodology; Data curation; Software; Writing—original draft; Writing—review and editing.

References

- Allen C, Metternicht G, Wiedmann T (2016) National pathways to the Sustainable Development Goals (SDGs): a comparative review of scenario modelling tools. *Environ Sci Pol* 66:199–207. <https://doi.org/10.1016/j.envsci.2016.09.008>
- Aryanpur V, O’Gallachoir B, Dai H et al (2021) A review of spatial resolution and regionalisation in national-scale energy systems optimisation models. *Energy Strateg Rev* 37:100702. <https://doi.org/10.1016/j.esr.2021.100702>
- Barbero-Vignola G, Acs S, Borchardt S et al (2020) Modelling for Sustainable Development Goals (SDGs): overview of JRC models. Publications Office of the European Union, Luxembourg (Luxembourg)
- Bisseling RH, Doup TM, Loyens LDJC (1993) A parallel interior point algorithm for linear programming on a network of transputers. *Ann Oper Res* 43:49–86. <https://doi.org/10.1007/BF02024486>
- Blesl M (2016) Myopic TIMES and the PanEU model. In: ETSAP workshop. IEA - Energy Technology Systems Analysis Programme (ETSAP), London, p 18
- Borggreffe F, Fuchs B, Gleixner A et al (2017) Developing speed-up methods from applied mathematics and computer science for the optimization of energy systems models (BEAM-ME). http://www.beam-me-projekt.de/beam-me/EN/Project/project_node.html
- Borggreffe F, Cao K-K, Scholz Y et al (2019) BEAM-ME introducing the model experiment (MEXT). Aachen
- Breuer T, Bussieck M, Cao K-K et al (2018) Optimizing large-scale linear energy system problems with block diagonal structure by using parallel interior-point methods BT. In: Kliewer N, Ehmke JF, Borndörfer R (eds) Operations research proceedings 2017. Springer International Publishing, Cham, pp 641–647
- Cao K-K, von Krbek K, Wetzel M et al (2019) Classification and evaluation of concepts for improving the performance of applied energy system optimization models. *Energies* 12(24): 4656. <https://doi.org/10.3390/en12244656>
- Collins S, Deane JP, Poncelet K et al (2017) Integrating short term variations of the power system into integrated energy system models: a methodological review. *Renew Sust Energy Rev* 76:839–856. <https://doi.org/10.1016/j.rser.2017.03.090>
- Densing M, Wan Y (2022) Low-dimensional scenario generation method of solar and wind availability for representative days in energy modeling. *Appl Energy* 306:118075. <https://doi.org/10.1016/j.apenergy.2021.118075>
- DLR (2023) Research project UNSEEN. https://www.dlr.de/ve/en/desktopdefault.aspx/tabid-13585/23602_read-54062/
- Fiand F (2018) GAMS and high performance computing. 26
- Fleischer CE (2020) Minimising the effects of spatial scale reduction on power system models. *Energy Strateg Rev* 32:100563. <https://doi.org/10.1016/j.esr.2020.100563>

- Fuso Nerini F, Keppo I, Strachan N (2017) Myopic decision making in energy system decarbonisation pathways. A UK case study. *Energy Strateg Rev* 17:19–26. <https://doi.org/10.1016/j.esr.2017.06.001>
- Glomb L, Liers F, Rösel F (2022) A rolling-horizon approach for multi-period optimization. *Eur J Oper Res* 300:189–206. <https://doi.org/10.1016/j.ejor.2021.07.043>
- Gondzio J (2012) Interior point methods 25 years later. *Eur J Oper Res* 218:587–601. <https://doi.org/10.1016/j.ejor.2011.09.017>
- Gondzio J (2016) Crash start of interior point methods. *Eur J Oper Res* 255:308–314. <https://doi.org/10.1016/j.ejor.2016.05.030>
- Heuberger CF, Staffell I, Shah N, Mac Dowell N (2018) Impact of myopic decision-making and disruptive events in power systems planning. *Nat Energy* 3:634–640. <https://doi.org/10.1038/s41560-018-0159-3>
- Hodge B-M, Lew D, Milligan M et al (2012) Wind power forecasting error distributions—an international comparison. National Renewable Energy Laboratory (NREL)
- IBM (2017) IBM ILOG CPLEX optimization studio—CPLEX user’s manual
- IEA (2016) Extended world energy balances. <https://doi.org/10.1787/data-00513-en>
- Kannan R, Turton H, Panos E (2015) Methodological significance of temporal granularity in energy–economic models—insights from the MARKAL/TIMES framework
- Karypis G, Gupta A, Kumar V (1994) A parallel formulation of interior point algorithms. In: Supercomputing ‘94: proceedings of the 1994 ACM/IEEE conference on supercomputing, pp 204–213
- Klotz E, Newman AM (2013) Practical guidelines for solving difficult linear programs. *Surv Oper Res Manag Sci* 18:1–17. <https://doi.org/10.1016/j.sorms.2012.11.001>
- Köhnen CS, Priesmann J, Nolting L et al (2022) The potential of deep learning to reduce complexity in energy system modeling. *Int J Energy Res* 46:4550–4571. <https://doi.org/10.1002/er.7448>
- Kotzur L, Markewitz P, Robinius M, Stolten D (2018) Impact of different time series aggregation methods on optimal energy system design. *Renew Energy* 117:474–487. <https://doi.org/10.1016/j.renene.2017.10.017>
- Kotzur L, Nolting L, Hoffmann M et al (2021) A modeler’s guide to handle complexity in energy systems optimization. *Adv Appl Energy* 4:100063. <https://doi.org/10.1016/j.adapen.2021.100063>
- Lehtilä A, Giannakidis G (2013) TIMES grid modeling features. IEA - Energy Technology Systems Analysis Programme (ETSAP)
- Lopion P, Markewitz P, Robinius M, Stolten D (2018) A review of current challenges and trends in energy systems modeling. *Renew Sust Energ Rev* 96:156–166. <https://doi.org/10.1016/j.rser.2018.07.045>
- Loulou R, Labriet M (2008) ETSAP-TIAM: the TIMES integrated assessment model part I: model structure. *Comput Manag Sci* 5:7–40. <https://doi.org/10.1007/s10287-007-0046-z>
- Loulou R, Goldstein G, Kanudia A et al (2016) Documentation for the TIMES model. Energy Technology Systems Analysis Programme
- Martínez-Gordón R, Morales-España G, Sijm J, Faaij APC (2021) A review of the role of spatial resolution in energy systems modelling: lessons learned and applicability to the North Sea region. *Renew Sust Energ Rev* 141:110857. <https://doi.org/10.1016/j.rser.2021.110857>
- Mehrotra S (1992) On the implementation of a primal-dual interior point method. *SIAM J Optim* 2: 575–601. <https://doi.org/10.1137/0802028>
- Mertens T, Poncet K, Duerinck J, Delarue E (2020) Representing cross-border trade of electricity in long-term energy-system optimization models with a limited geographical scope. *Appl Energy* 261:114376. <https://doi.org/10.1016/j.apenergy.2019.114376>
- Nahmmacher P, Schmid E, Hirth L, Knopf B (2016) Carpe diem: a novel approach to select representative days for long-term power system modeling. *Energy* 112:430–442. <https://doi.org/10.1016/j.energy.2016.06.081>

- Novo R, Marocco P, Giorgi G et al (2022) Planning the decarbonisation of energy systems: the importance of applying time series clustering to long-term models. *Energy Convers Manag X* 15:100274. <https://doi.org/10.1016/j.ecmx.2022.100274>
- Panos E (2022) CPLEX\Barrier options for TIMES models. ETSAP Webinar, 11 March 2022, available online: <https://iea-etsap.org/webinar/CPLEX%20options%20for%20running%20TIMES%20models.pdf>
- Panos E, Lehtilä A (2016) Dispatching and unit commitment features in TIMES. International Energy Agency - Energy Technology Systems Analysis Programme (ETSAP)
- Panos E, Lehtilä A, Deane P, Sharma T (2019) Enhancing the flexibility in TIMES: introducing ancillary services markets. Villigen
- Pattupara RM (2016) Long term evolution of the Swiss electricity system under a European electricity market. ETH-Zürich A4 - Wokaun, Alexander A4 - Hungerbühler, Konrad
- Pattupara R, Kannan R (2016) Alternative low-carbon electricity pathways in Switzerland and it's neighbouring countries under a nuclear phase-out scenario. *Appl Energy* 172:152–168. <https://doi.org/10.1016/j.apenergy.2016.03.084>
- Petra CG, Schenk O, Anitescu M (2014) Real-time stochastic optimization of complex energy systems on high-performance computers. *Comput Sci Eng* 16:32–42. <https://doi.org/10.1109/MCSE.2014.53>
- Poncelet K, Duerinck J (2017) Timeslice tool. IEA-ETSAP Project Report. Available online: <https://iea-etsap.org/projects/Timeslicetool%20V1.zip>
- Rehfeldt D, Hobbie H, Schönheit D et al (2019) A massively parallel interior-point solver for linear energy system models with block structure. ZIB Report 19-41 (Revised October 2019) <https://optimization-online.org/wp-content/uploads/2019/08/7330.pdf>
- Rehfeldt D, Hobbie H, Schönheit D et al (2022) A massively parallel interior-point solver for LPs with generalized arrowhead structure, and applications to energy system models. *Eur J Oper Res* 296:60–71. <https://doi.org/10.1016/j.ejor.2021.06.063>
- Rosenthal ER (2017) GAMS—a user's guide. GAMS Development Corporation, Washington, DC
- Scholz Y, Fuchs B, Borggreve F et al (2020) Speeding up energy system models—a best practice guide. Stuttgart, Germany
- Seljom P, Tomasgard A (2015) Short-term uncertainty in long-term energy system models—a case study of wind power in Denmark. *Energy Econ* 49:157–167. <https://doi.org/10.1016/j.eneco.2015.02.004>
- Sferra F, van Ruijven B, Riahi K (2021) Downscaling IAMs results to the country level—a new algorithm. Laxenburg, Austria
- Sharma T, Glynn J, Panos E et al (2019) High performance computing for energy system optimization models: enhancing the energy policy tool kit. *Energy Policy* 128:66–74. <https://doi.org/10.1016/j.enpol.2018.12.055>
- Skajaa A, Andersen ED, Ye Y (2013) Warmstarting the homogeneous and self-dual interior point method for linear and conic quadratic problems. *Math Program Comput* 5:1–25. <https://doi.org/10.1007/s12532-012-0046-z>
- UNFCCC (2015) Adoption of the Paris Agreement. Proposal by the President
- United Nations (2015) Transforming our world: the 2030 Agenda for Sustainable Development. New York
- Van der Voort E (1982) The EFOM 12C energy supply model within the EC modelling system. *Omega* 10:507–523. [https://doi.org/10.1016/0305-0483\(82\)90007-X](https://doi.org/10.1016/0305-0483(82)90007-X)
- van Soest HL, van Vuuren DP, Hilaire J et al (2019) Analysing interactions among Sustainable Development Goals with Integrated Assessment Models. *Glob Transitions* 1:210–225. <https://doi.org/10.1016/j.glt.2019.10.004>
- Wathen AJ (2015) Preconditioning. *Acta Numer* 24:329–376. <https://doi.org/10.1017/S0962492915000021>
- Wilkinson JH (1965) The algebraic eigenvalue problem. Clarendon, Oxford
- Wright SJ (1997) Primal-dual interior-point methods. Society for Industrial and Applied Mathematics

- Zeyringer M, Daly H, Fais B et al (2015) Spatially and temporally explicit energy system modelling to support the transition to a low carbon. In: International symposium for next generation infrastructure conference (ISNGI 2014). International Institute of Applied Systems Analysis (IIASA), Vienna, pp 205–211
- Zhang F (ed) (2005) The Schur complement and its applications, 1st edn. Springer New York, New York

Open Access This chapter is licensed under the terms of the Creative Commons Attribution 4.0 International License (<http://creativecommons.org/licenses/by/4.0/>), which permits use, sharing, adaptation, distribution and reproduction in any medium or format, as long as you give appropriate credit to the original author(s) and the source, provide a link to the Creative Commons license and indicate if changes were made.

The images or other third party material in this chapter are included in the chapter's Creative Commons license, unless indicated otherwise in a credit line to the material. If material is not included in the chapter's Creative Commons license and your intended use is not permitted by statutory regulation or exceeds the permitted use, you will need to obtain permission directly from the copyright holder.



Enabling Coherence Between Energy Policies and SDGs Through Open Energy Models: The TEMOA-Italy Example



Matteo Nicoli, Maria Elena Alfano, Farzaneh Amir Kavei, Alessandro Balbo, Gianvito Colucci, Daniele Lerede, Daniele Mosso, and Laura Savoldi

Abstract This chapter highlights the significance of open-source energy system optimization models in enhancing the transparency and accessibility of energy system studies for policymakers. It provides a detailed example of the creation of a robust modeling framework. This includes guidance on selecting appropriate inputs, interpreting results, and connecting them to policy-relevant objectives such as the Sustainable Development Goals (SDGs), particularly SDGs 6 (water), 7 (energy), 8 (work and economic growth), 9 (industry), 13 (climate) and 15 (land). The focus is on the energy system optimization model TEMOA-Italy, a case study for Italy developed within the open-source framework TEMOA. The presented results explore the impact of possible future scenarios and energy policies on the power sector's sustainability, showing that low emissions scenarios perform better than a base scenario concerning environmental aspects, but worse in terms of land use and social aspects like the quality of labor. Import dependence is also affected by the renewables' penetration, due to the criticality of renewable technologies imports. The exclusion of carbon capture from the set of available new technologies improves geopolitical stability and reduces volume shortage risk.

Key Messages

- TEMOA-Italy, as an open-source and open-data model, allows the evaluation of the effectiveness of energy policies in addressing the system sustainability in a fully transparent and easy to replicate manner.

M. Nicoli (✉) · M. E. Alfano · A. Balbo · G. Colucci · D. Mosso · L. Savoldi
MAHTEP Group, Department of Energy "Galileo Ferraris", Politecnico di Torino, Turin, Italy
e-mail: matteo.nicoli@polito.it; marialena.alfano@polito.it; alessandro_balbo@polito.it;
gianvito.colucci@polito.it; daniele.mosso@polito.it; laura.savoldi@polito.it

F. Amir Kavei · D. Lerede
Department of Economics and Statistics "Cognetti de Martiis", Università degli Studi di Torino,
Turin, Italy
e-mail: farzaneh.amirkavei@unito.it; daniele.lerede@unito.it

© The Author(s) 2024

M. Labriet et al. (eds.), *Aligning the Energy Transition with the Sustainable Development Goals*, Lecture Notes in Energy 101,
https://doi.org/10.1007/978-3-031-58897-6_5

- Several sustainability indicators, concerning the environmental, security and social dimensions are investigated in the context of the SDGs.
- Low emissions scenarios significantly reduce most of the environmental impacts (SDGs 6 on water and 13 on climate), to the detriment of land use (SDG 15), import dependence, and quality of labor (SDG 8).
- Excluding the deployment of carbon capture technologies indirectly improves geopolitical stability by forcing a lower reliance on fossil fuels, creating a synergy with the decarbonization target.

1 Introduction and Motivation

Crafting sustainable energy policies requires a deep understanding of their environmental, social, technical, and economic impacts to ensure realistic and effective implementation (Perdigão 2023). Historically, energy policymaking has struggled with outdated tools, failing to adequately address emerging challenges such as integrating fluctuating renewable energy sources, adapting to rapid technological changes, and managing the socio-economic aspects of energy transitions. A key obstacle in this process is the information gap between the scientific community and policy-making entities. As noted by (Mohtar and Daher 2016), the “fragmentation between the scientific and policy communities” needs to be addressed. Furthermore, the tools and information used by stakeholders are often not easily accessible or transparent, creating barriers to informed decision-making. This context underscores the need for enhanced communication and transparent, accessible tools in energy policy formulation.

This chapter provides an example of using an open-source Energy System Optimization Model (ESOM) to assess the sustainability of the future system evolution according to several sustainability indicators, including specific Sustainable Development Goals (SDGs) like 6 (water), 7 (energy), 8 (work and economic growth), 9 (industry), 13 (climate), and 15 (land). The proposed model instance is based on Tools for Energy Modeling Optimization and Analysis (TEMOA), and it represents a case study for the Italian energy system. The analysis presented in this chapter focuses on the power sector, given its key role in decarbonization strategies in the next decades (Martins et al. 2022).

Section 2 presents the main features and data needed to develop the model, while Sect. 3 introduces the indicators used to evaluate the system’s sustainability. Results are discussed in Sect. 4 and Sect. 5 reports the main conclusions and perspectives.

2 Model Structure

The main techno-economic parameters used to describe a technology in the TEMOA formulation are shown in Fig. 1.

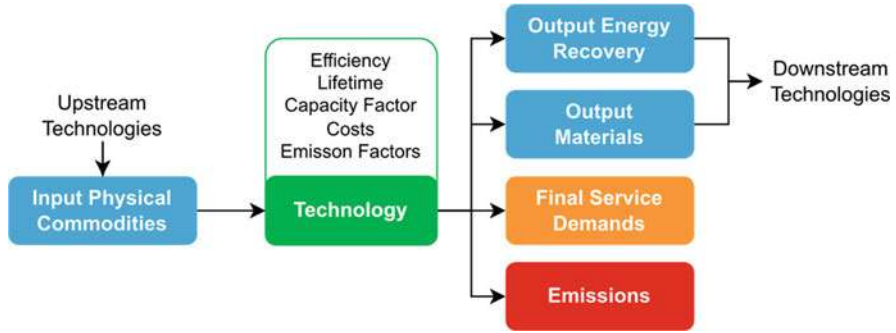

Fig. 1 The main techno-economic parameters associated with a TEMOA technology and connection with physical (energy and material), demand and emission commodities

TEMOA tackles a linear optimization problem comparable to standard TIMES models (Loulou et al. 2016). This problem involves minimizing the objective function, which represents the total cost of the energy system (denoted as C_{tot}). The total cost, calculated in Eq. 1, depends on the discount factor (DiscountFactor, representing the discounted value to the beginning of the time horizon of a unitary payment) and the cost values of individual technologies chosen in the optimal technology mix. Three key parameters in technology modeling play a crucial role in computing the objective function: investment cost (C_{invest} [M€/cap.]), fixed operation and maintenance (O&M) cost (C_{fixed} [M€/cap.]), and variable O&M cost ($C_{variable}$ [M€/cap.]). While investment cost and fixed O&M cost are linked to a technology’s installed capacity, variable O&M cost is tied to the total flow of output commodities. $LA_{r,t,v}$ is used to annualize a technology’s investment cost, determined by the process-specific loan length and discount rate.

$$\begin{aligned}
 C_{tot} &= C_{loans} + C_{fixed} + C_{variable} \\
 &= \sum_{r,t,v} (\text{CostInvest}_{r,t,v} \cdot LA_{r,t,v} \cdot \text{DiscountFactor} \cdot \text{Cap}_{r,t,v}) \\
 &\quad + \sum_{r,p,t,v} (\text{CostFixed}_{r,p,t,v} \cdot \text{DiscountFactor} \cdot \text{Cap}_{r,t,v}) \\
 &\quad + \sum_{r,p,t,v} \left(\text{CostVariable}_{r,p,t,v} \cdot \text{DiscountFactor} \cdot \sum_{s,d,i,o} FO_{r,p,s,d,i,t,v,o} \right)
 \end{aligned} \tag{1}$$

The TEMOA-Italy database is rooted in energy statistics provided by the International Energy Agency (IEA) for the year 2006 (the “base year” of the time horizon), as extensively described in Nicoli (2021) and Nicoli (2022). It explores future energy scenarios on a time scale up to 2050, subdivided into several time periods. The model is fully calibrated (i.e., it matches actual energy statistics) from the base year up to 2020. Each time period is split up into refined time slices considering four seasons (winter, spring, summer and fall) and four times of day (night, morning,

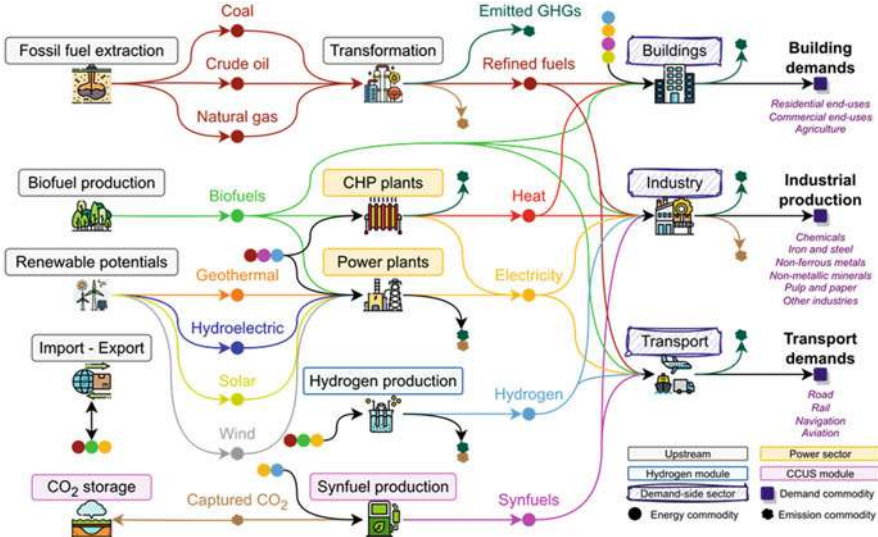

Fig. 2 Graphical representation of the TEMOA-Italy reference energy system (MAHTEP Group 2023). *Note:* The interconnection between the upstream, power sector, hydrogen module, CCUS module, and demand-side sectors is visualized through energy commodities and arrows which represent the direction of the energy flows

noon and afternoon) to capture the different behavior of, e.g., intermittent electricity generation technologies.

A schematic view of the TEMOA-Italy reference energy system is reported in Fig. 2. The upstream sector generates the fossil and renewable commodities required to feed the demand sectors on the right-hand side, after a series of transformation processes (central part of Fig. 2). The demand-side considers buildings (including residential and commercial buildings, and the agricultural sector), industry (in five energy-intensive subsectors characterized in full detail plus other energy-intensive industries) and (road and non-road) transportation.

The energy service demands to be satisfied, defined for the abovementioned demand sectors, are projected along the analyzed time horizon according to Eq. 2, wherefor two time steps t and $t-1$, $Demand_t$ and $Demand_{t-1}$ are the service demand levels, δ_t and δ_{t-1} are the driver values, and e_t is the elasticity of the driver to the demand associated with time step t . The demands need to be satisfied for every time step and are projected according to the methodology described in Oliva et al. (2021).

$$Demand_t = Demand_{t-1} \cdot \left[1 + \left(\frac{\delta_t}{\delta_{t-1}} - 1 \right) \cdot e_t \right] \quad (2)$$

The upstream sector belongs to the supply side of the RES and includes the primary production of energy commodities, their transformation into refined fuels, and the

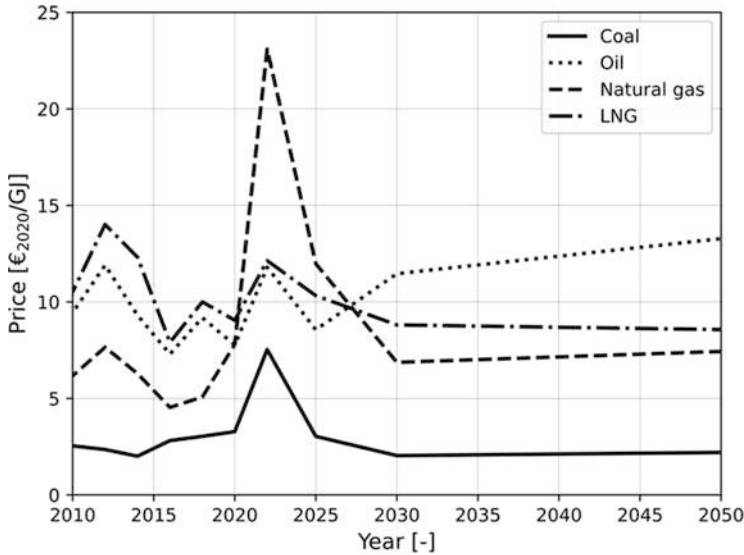

Fig. 3 Import prices of coal, oil, natural gas, and LNG modeled in release 3.0 of TEMOA-Italy (MAHTEP Group 2023)

eventual foreign trade in terms of import and export (Fig. 2). Concerning fossil fuels, coal, oil, and natural gas extraction are modelled, considering as maximum availability constraints the so-called proved, probable, and possible reserve data. Then, the production of refined fossil fuels is accounted for, including primary and secondary transformation processes. The primary production of biofuels encompasses solid biomass, bioethanol, biodiesel, and biogas, it also includes the upgrade of the latter into biomethane—more details are provided in Colucci et al. (2023). Besides, secondary production regards the gasification and liquefaction of natural gas. The availability of the other renewables, namely solar, wind, hydroelectric, biomass and geothermal, is defined through potentials that are constrained elaborating the values from Ruiz et al. (2019). The trade of refined fuels and electricity is modeled through fictitious import and export processes characterized by trade prices. The import prices for the main fossil fuels are shown in Fig. 3: the price spikes due to the recent energy crisis are accounted for. The complete set of data implemented in release 3.0 of the TEMOA-Italy upstream sector is available in MAHTEP Group (2023).

The structure of the main energy sectors constituting the model is described in Nicoli (2021) for buildings and agriculture, Lerede (2021) for industry, Lerede (2020) for transport, and Balbo (2023) and Colucci et al. (2023) for the hydrogen and CCUS modules.

2.1 Power Sector

Focusing on the power sector, Fig. 4 shows the main technology groups and their input/output commodities and highlights the connections with the other sectors of the model, namely, the hydrogen and CCUS modules and the demand sectors (including electricity and heat consumption options). Table 1 shows a summary of the main parameters used for the modeling of the existing technologies aggregated by plant category (power, CHP, and heat production plants) and input resource (more than one technology is associated with each resource). The capacities of existing technologies lead to a total gross capacity in 2006 equal to 91.80 GW (including heat plants), as from statistics by the Italian TSO (Terna).

The complete techno-economic characterization of new technologies included in the power sector is available in Mosso et al. (2024) and MAHTEP Group (2023). The time dependent parameters (e.g., renewables capacity factors) are modeled as presented in Nicoli (2024). While several technology groups are present in the sector, the main technology categories are electricity generation plants, CHP and micro-CHP plants (combined electricity and heat production), and heat generation plants (heat production). More specifically, the possible energy inputs for the power sector are fossil fuels, biofuels, renewables, and hydrogen. The techno-economic parameters of power plants with CCS and the hydrogen fuel cell are taken from the JRC-EU-TIMES Model (Simoes et al. 2013). The discount rates are from Laera (2024).

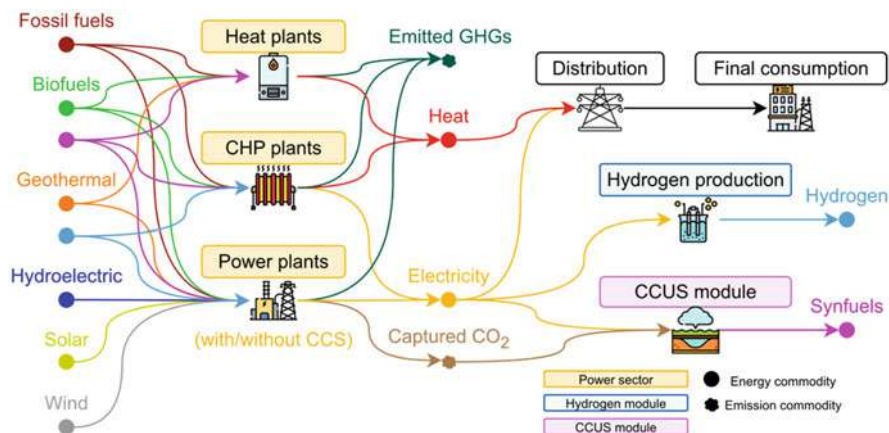

Fig. 4 The TEMOA-Italy (release 3.0) power sector (MAHTEP Group 2023)

Table 1 Calibration of the existing technologies in the TEMOA-Italy (release 3.0) power sector (MAHTEP Group 2023)

Category	Resource	Efficiency (%)	Existing capacity (GW)	End of life	Fixed O&M cost (M€ ₂₀₀₉ /GW)	Variable O&M cost (M€ ₂₀₀₉ /PJ)	Capacity factor (%)	Capacity credit (%)	CHPR	
Power plants	Coal	32	7.73	≈2030	31	0.46	≈40	100	–	
	Oil products	35	9.28	≈2030	32	0.47			–	
	Natural gas	46	28.03	≈2050	18	0.49			–	
	Biofuels	27	0.76	≈2030	13	0.36			–	
	Geothermal	10	0.79	≈2030	94	3.48			–	
	Hydroelectric	–	21.38	–	25	0.08		50 ~ 100	–	
	Solar	–	0.02	≈2025	31	13.89		20	–	
	Wind	–	2.12	≈2020	34			25	–	
	CHP plants	Coal	37	0.91	≈2030	221	0.83	≈60	100	27
		Oil products	35	3.23	≈2020	32	0.47			60
Natural gas		48	14.83	≈2050	29	0.61			81	
Biofuels		39	0.82	≈2050	221	0.83			125	
Heat plants	Natural gas	80	0.77	≈2035	–	–	50		–	
	Geothermal	80	1.13	≈2035	–	–			–	

2.2 Constraints

The main sources of data for the applied set of constraints are:

- TERNA Statistics (Terna), Eurostat Energy Balances (Eurostat 2023) and GSE Statistics (Gestore Servizi Energetici (GSE)) for the calibration of the historical period 2006–2020.
- Integrated National Energy and Climate Plan 2019 (Ministry of Economic Development et al. 2019), Long term Italian strategy for greenhouse gas emission reduction (Ministry of the Environment and Land and Sea Protection et al. 2021) and Fit for 55 (European Council 2021) with respect to stated future policies implemented in the model. This includes the phase-out of coal power plants no later than 2030.
- Elaboration from ENSPRESO Database (Ruiz et al. 2019), for renewable future potentials.

Concerning the minimum and maximum constraints applied to import and export technologies, they are equal to 95% and 105% of the historical data (Eurostat 2023) respectively for the 2006–2020 period, while are linearly projected from 2020 to 2050 assuming a minimum equal to 0 in 2050 and a maximum equal to 1 ~ 2 times the 2020 value. The complete set of constraints is available in MAHTEP Group (2023).

2.3 Emissions Accounting Methodology

The emission accounting methodology adopted for the model is dynamic. Indeed, it is capable of accounting for the avoided emissions from the low-carbon fraction in blends with fossil fuels, with a variable composition across the time horizon. That would not be possible by using the commodity-emission factors (CEFs) traditionally adopted to compute fuel combustion emissions which are based on a given static fuel composition. The dynamic method presented in Colucci et al. (2023) and Colucci et al. (2022) is currently applied to CO₂ emissions, while the combustion of low-carbon fuels (LCFs), namely hydrogen, biofuels, and syngas is not considered to affect the atmospheric CO₂ concentration. Hence, when they are mixed with fossil fuels (at the level of the fuel technologies (FTs)), the CO₂ emissions due to the consumption of the sectorial commodities produced by the FTs are lower than in the case of pure sectorial fuel: this is accounted for in the dynamic methodology by using negative process emission factors (PEFs) proportional to the LCF fractions. This logic is schematized in Fig. 5: these PEFs are applied to the FTs for the hydrogen and biofuel fractions, while for syngas they are used at the level of the production technologies. The net sectorial CO₂ is the sum of the CEF-CO₂, that is computed through the static CEFs applied to the sectorial fuel, and the PEF-CO₂ (FT), that is computed through the PEFs applied to the fuel technology while

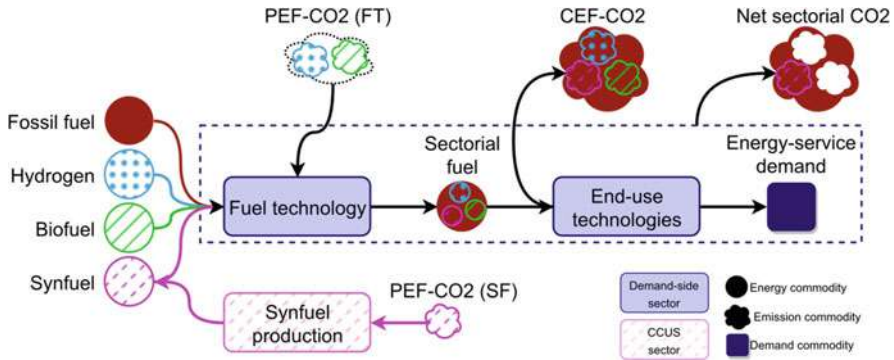

Fig. 5 Scheme of the dynamic emission accounting methodology applied to a generic demand-side sector (dashed box). *Note:* The bigger grey clouds represent the CO₂ emissions due to the consumption of the sectorial fuel, while the smaller ones are the CO₂ fractions associated to the low-carbon fuels (with filling pattern correspondence)

accounting for the hydrogen and biofuel fractions. The synfuel contribution is already compensated through a negative PEF at the level of its production, namely PEF-CO₂ (SF). The methodology is flexible, such that it can be extended to other greenhouse gases and is also applicable in the case of non-null emission contributions from the LCFs (e.g., possible global warming potential of biogenic CO₂). Moreover, it allows to adequately assess the decarbonization potential of using low-carbon fuels in current existing infrastructure. Indeed, under certain mixing shares, conventional technologies can be used without the need for retrofitting: this would contribute to achieving the short-to-medium energy transition targets, whilst also considering the SDG 7 of the United Nations aiming to ensure affordable and clean energy for all by 2030.

3 Sustainability Indicators

Enhancing coherence between energy policies and sustainable development is an intricate task, since the proper definition of sustainability is hardly agreed upon, when referring to the energy perspective (Muniz et al. 2020). In the energy domain, integrating various elements of the SDGs into energy system models is crucial (Niet et al. 2021). This integration enables the identification of policy trade-offs and the discovery of synergistic benefits between goals.

Despite the different sectorial, spatial and time horizons of energy models, the integration of sustainability-related aspects within ESOMs raises the question of how sustainability is accounted for and computed (Martín-Gamboa et al. 2017). Attempts have been performed for a direct integration of sustainability measures in the optimization strategy (endogenous integrations), or by conducting sustainability

assessments on the outcomes of the energy models (ex-post analysis) (Blanco et al. 2020). In the given context, a post-processing approach is developed because it can be easily applied to ESOMs, without necessitating modifications to the model structure.

A broad scientific consensus exists about the aspects that are required to be accounted for in ex-post sustainability assessments. Notably, an environmental dimension is acknowledged in relation to factors such as global warming, deforestation, and pollution of air, land, and water (Gayen et al. 2023). Additionally, an economic dimension is considered, including energy profitability and affordability. Moreover, attention is increasingly directed towards the capability of energy systems at providing reliable energy, with a focus on both short-term grid security and long-term geopolitical considerations (Brodny and Tutak 2023). Lastly, a noteworthy trend in recent studies is the emergence of social sustainability, denoting the impacts of energy on society. This dimension encompasses aspects such as acceptability and social impact (Marrero et al. 2021). The economic and the technical dimensions are endogenously considered by ESOMs during the optimization process.

With those premises, Table 2 provides an overview of the selected indicators to conduct the sustainability analysis presented in this chapter. Selected indicators directly align with electricity production (expressed in ESOM by plants activity). Some include an Impact over Activity format, by definition (e.g., environmental indicators). Others necessitated mathematical treatments, assumptions, and simplifications, detailed in (Mosso et al. 2024) alongside supporting data, ensuring transparency, and facilitating interpretation within the broader analysis.

In the next step, such indicators should be translated in policy relevant information (OECD 2008). In particular, the focus is on comparing the performance of different energy scenarios. In other words, it is necessary to establish a quantitative or a qualitative measure derived from a series of observed outcomes that can reveal relative positions (e.g., of a scenario) in a given area (e.g., sustainability) (Miola and Schiltz 2019).

Two primary approaches are usually proposed to develop the SDG metrics (Miola and Schiltz 2019): either creating various distinct pieces of information or condensing information into a single, integrated indicator (OECD 2008). This reflects a common challenge in measuring complex concepts like sustainable development, and a trade-off occurs between the comprehensiveness of a single indicator and the specificity and detail of multiple metrics (OECD 2008).

This study follows the first approach and focuses on multiple aspects analyzed separately. The temporal variation of the indicators of Table 2 within predefined scenarios is analyzed. The data source and the detailed data gathering procedure for the calculation of the indicators are based on Mosso et al. (2024).

Firstly, individual power sector technologies are characterized using the 12 impact/activity indicators presented in Table 2. However, since transitioning from technology-specific analysis to scenario-level insights is the goal of this analysis, a transformative step is necessary. To achieve this, a weighted average approach is adopted which takes activity share as a proxy to perform the average.

Table 2 Description of sustainability dimensions and indicators

Sustainability dimension	Sustainability indicator	Overview	Unit of measure
Environmental	Global warming potential (GWP)	Environmental impact is measured in a cradle-to-grave approach, considering the full life cycle of the plant, as specified in ISO 14040 (International Organization for Standardization (ISO) 2006) and United Nations Economic Commission for Europe (UNECE) (2021). They express the average impact for each unitary output of electricity.	$\left(\frac{\text{kgCO}_2\text{,EQ}}{\text{MWh}}\right)$
	Acidification Potential (AP)		$\left(\frac{\text{gSO}_2\text{,EQ}}{\text{MWh}}\right)$
	Eutrophication Potential (EP)		$\left(\frac{\text{gPO}_4\text{,EQ}}{\text{MWh}}\right)$
	Land use		$\left(\frac{\text{m}^2}{\text{MWh}}\right)$
	Water use		$\left(\frac{\text{m}^3}{\text{MWh}}\right)$
Security	Reliability	Reliability is represented by the capacity factor of the technologies (Nock and Baker 2019).	Capacity Factor (%)
	Import Dependence	The share of imported critical commodities (energy and materials) over total commodities needed for the technology operation is used, taken from Ministry of Environment and Energy Security (2023).	(%)
	Volume shortage risk	Volume Shortage Risk is represented by the percentage of supply not affected by the possible unavailability of the biggest energy or material supplier, using the “N-1” criteria (Carrión et al. 2021).	N – 1 Residual Supply (%)
	Political stability index	This indicator is based on the political stability index of countries supplying energy and materials, weighted on the import shares of the commodities (Mosso et al. 2024).	Political Stability Index (–)
Social	Human health damage	This indicator is expressed in Disability Adjusted Lifetime Years (DALY), estimating the number of years lost due to ill-health, disability, or early death, due to the technologies over their lifetime (Mosso et al. 2024).	$\left(\frac{\text{DALY}}{\text{MWh}}\right)$
	Fatalities	This indicator estimates the number of deaths due to power plants construction, material supply and operations (United Nations Economic Commission for Europe (UNECE) 2021).	$\left(\frac{\text{Deaths}}{\text{MWh}}\right)$
	Quality of labour	The Human Development Index (Mosso et al. 2024) is used as a proxy of the quality of labor.	Human Development Index (–)

Equation 3 summarizes the calculation, where each technology’s indicator value (units per MWh) is multiplied by the corresponding electricity production share within the scenario (%) and then summed across all technologies.

$$AI_{s,i} = \sum (AS_{t,s,i} \cdot TI_t) \quad (3)$$

While $AI_{s,i}$ represents the Average Indicator for scenario s in year i , $AS_{t,s,i}$ is the Activity Share of technology t in scenario s in the same year, and TI_t is the Technology Indicator for technology t . The sum is made over all technologies involved in the scenario.

This method ensures each technology's contribution to the scenario-level indicator profile reflects its relative importance in electricity generation. The outcome is an indicator profile for each scenario, resulting from the activity of all of the technologies composing the scenario. This methodology is valid even for indicators lacking units, such as the security ones, with the underlying assumption that their impact is proportional to the technology's activity.

4 Scenarios and Results

Summary results from TEMOA-Italy together with the selected scenarios are presented in the following.

4.1 Scenarios

Table 3 shows the main features of the selected scenarios implemented in TEMOA-Italy. The mentioned emission limit was developed by merging the “Fit for 55” (Erbach et al. 2022) for 2030 and the “Italian long-term strategy for greenhouse gases emission reduction” targets (Ministry of the Environment and Land and Sea Protection et al. 2021) for 2050. This results in emission limits of 194 Mt in 2030 and 29 Mt in 2050. Residual emissions are allowed in 2050 so as to be consistent with the absence of Agriculture, Forestry and Other Land Uses (AFOLU) options in the models, which are expected to contribute up to 45 Mt of CO_{2EQ} removal in 2050 (equal to the historical peak reached in 2015) (Ministry of the Environment and Land and Sea Protection et al. 2021).

The reason for also investigating the “No CCUS” scenario resides in its relatively low readiness levels (with respect to other technology sectors). Moreover, the fact that CCS technologies significantly contribute to emission reduction in the “Net0”

Table 3 Features of the selected scenarios

Scenario	CO ₂ emission limit	Hydrogen availability	CCUS availability
Base	No	Yes	Yes
Net0	Yes	Yes	Yes
No H ₂	Yes	No	Yes
No CCUS	Yes	Yes	No

scenario makes exploring the model's behavior in their absence interesting, as is also the case for the "No H₂" scenario, excluding hydrogen production and consumption technologies.

4.2 Energy and Emissions

Figure 6 presents the yearly final energy consumptions and emissions for the selected scenarios together with a result validation (referred to as "Cal. 2020" in the figure) against historical data for 2020 (referred to as "Hist. 2020" in the figure).

Concerning the comparison with historical data, no significant differences emerge neither for the final energy consumption by energy source (Fig. 6a), nor the total CO₂ emissions in 2020. Looking at the "Base" scenario, an 8% increase in the 2050 final energy consumption can be appreciated with respect to 2020, mainly driven by a growing oil products consumption (in the transport sector, mostly due to the increasing aviation demand). This is also reflected in the emissions breakdown (Fig. 6b) for "Base" in 2050, showing an increase in the emissions from the transport sector, partially compensated by efficiency improvements in the other sectors and higher penetration of renewables (as the power sector emissions reduction also suggests).

A non-negligible role in reducing emissions in the "Net0" scenario is also played by biofuels (mainly biomethane, blended with fossil natural gas) and hydrogen (mainly consumed by aviation technologies accounting for 8% of the final energy consumption, while the Italian Hydrogen Strategy aims for 20% (Ministry of Economic Development 2020) (Fig. 7). Synfuels seem not to be competitive in the studied scenario.

Concerning the three decarbonization scenarios, they are all characterized by complete power sector decarbonization and high electrification of end-uses (Fig. 7). The latter also allows a significant reduction of the total final energy consumption (despite the increasing final service demands) attributable to the higher efficiency of electric technologies compared to thermal options (e.g., in the transport sector).

While the "No H₂" and "No CCUS" scenarios are characterized by a higher degree of electrification and (consequently) a lower final energy consumption with respect to "Net0", the main difference occurs in the emission levels (Fig. 6b). Indeed, the lack of availability of hydrogen in "No H₂" implies higher emissions from the transport sector and requires a deeper decarbonization of industry to be consistent with the emission limit. The carbon capture moves from the upstream sector in the "Net0" scenario (hydrogen production with carbon capture) to direct air carbon capture in "No H₂". Eventually, the absence of capture options in the "No CCUS" requires the complete electrification of buildings (residential and commercial) through heat pumps, while the residual emissions are from agriculture, industry, and transport. More detailed results are discussed in Colucci et al. (2023) for the "Net0" scenario only.

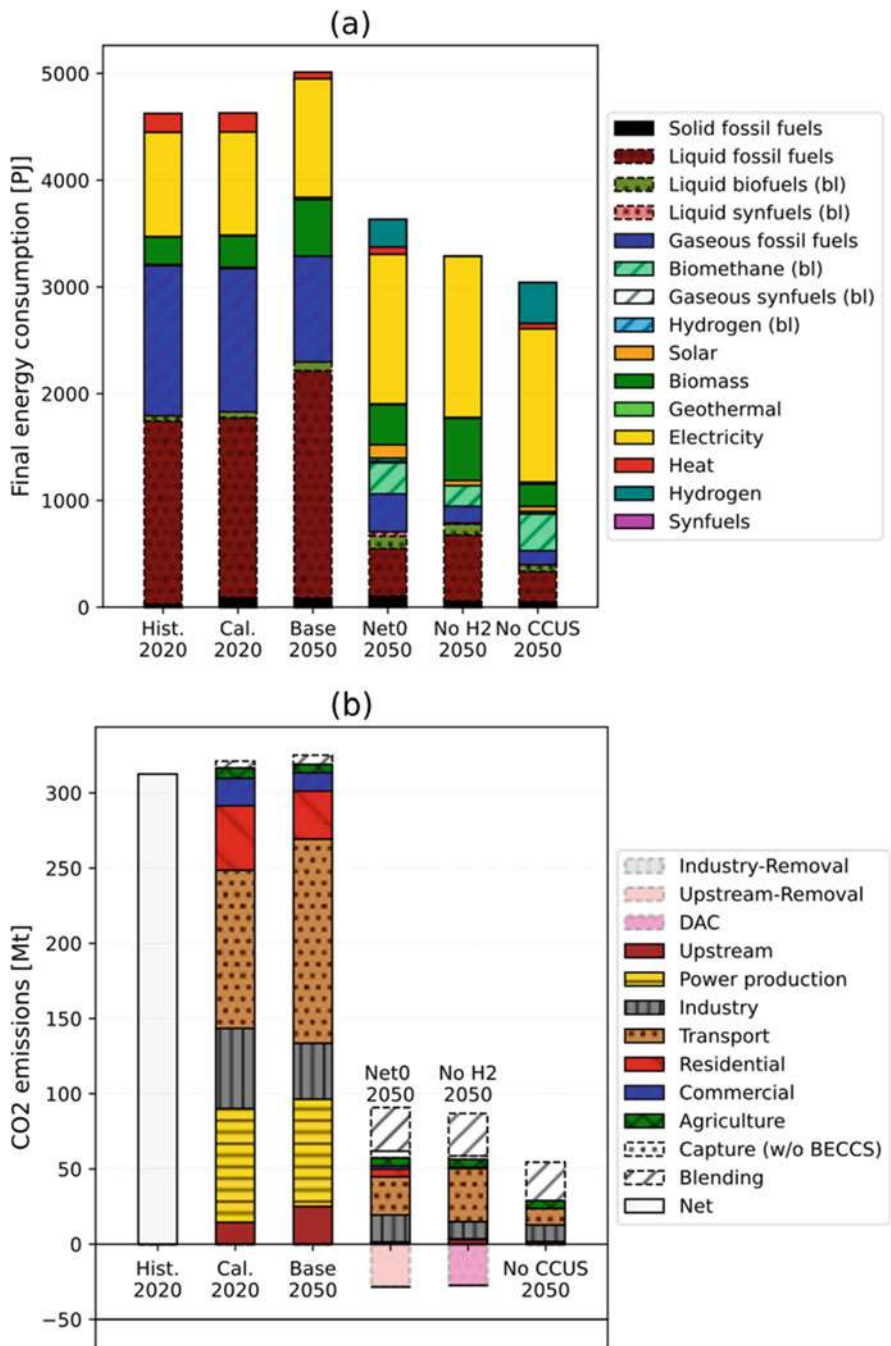

Fig. 6 TEMOA-Italy final energy consumption by energy commodity and scenario compared to 2020 historical data (a) and emission levels by energy sector and scenario compared to 2020 historical data (b)

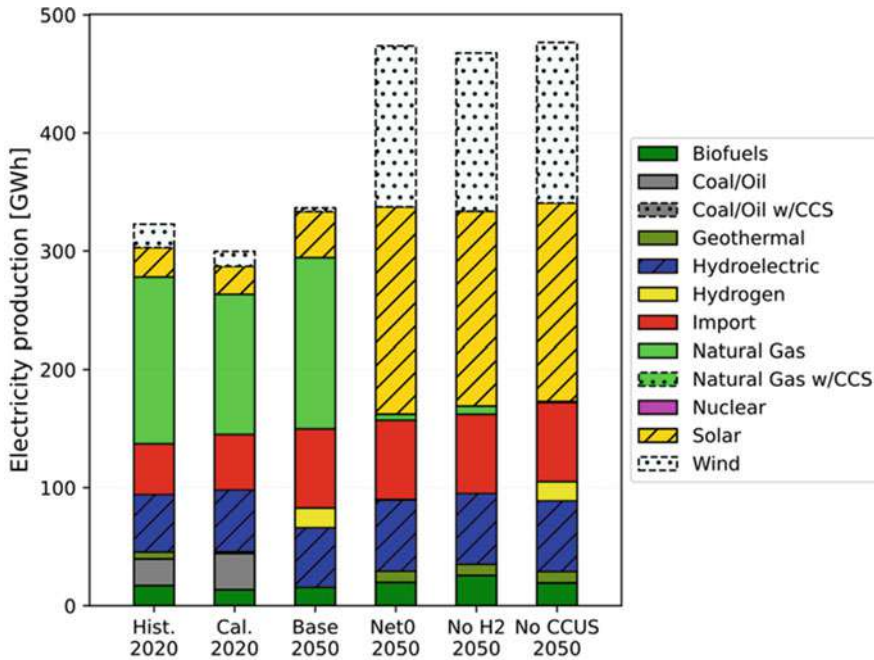

Fig. 7 TEMOA-Italy electricity production mix by energy commodity and scenario compared to 2020 historical data

4.3 Sustainability

The evaluation of the sustainability indicators for the applied energy scenarios is shown in Fig. 8. This evaluation reflects the indicators described in Table 2 applied to the scenarios of Table 3. Due to the similarity of profiles among the 12 indicators, “No H₂” and “No CCUS” have been incorporated into the “No H₂ – No CCUS” profile.

Considering the environmental indicators, they collectively demonstrate a downward trajectory, with the GWP and AP averaging 50–60% reduction in 2050 and Eutrophication Potential decreasing by approximately 40–50%. These declines happen for the “Net0” scenario, which aggressively targets emissions reductions, although the benefits come at the expense of a dramatic increase in Land Use. This indicates a significant environmental trade-off, where lower impacts with respect to global warming may lead to heightened land resource demands for renewable deployment. Finally, water use exhibits a significant reduction in Net0, driven by the reduced reliance on fossil fuel plants, characterized by a higher water footprint.

Security indicators within the energy sector present a nuanced landscape. Reliability and Volume Shortage Risk show negligible changes under the “Base” and “No CCUS” scenarios, indicating a “status quo” in these areas. However, under the

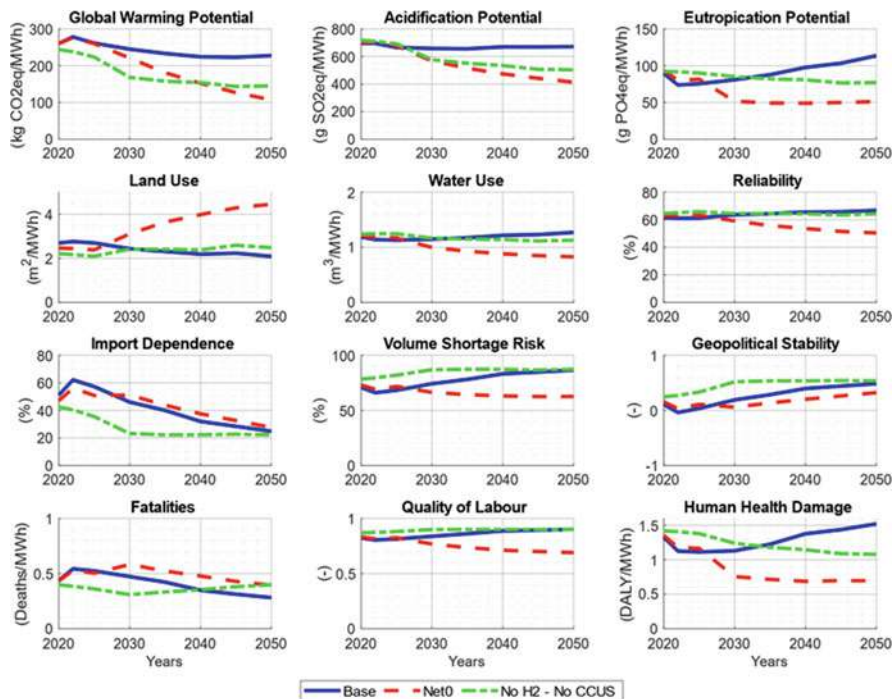

Fig. 8 Evaluation of the 12 sustainability indicators evolution from 2020 to 2050 according to the considered scenarios. *Note:* Solid blue for “Base”, dashed red for “Net0”, dashed green for “No H₂” and “No CCUS” (Color figure online)

“Net0” scenario, these indicators diverge, with Volume Shortage Risk registering a positive shift with a reduction potentially ranging from 10% to 15%, denoting a decrease in the risk of supply shortages. This trend is supported by the growing integration of photovoltaic and wind energy in the Net0 scenario, as these technologies offer superior commodity diversification compared to their counterparts. Conversely, Reliability experiences a negative variation, driven by the higher share of variable renewables, notably characterized by lower capacity factors. Import Dependence decreases almost 20% across all scenarios, due to the lower reliance on critical imports associated with new technologies deployment. Geopolitical Stability presents a general improvement, culminating in an increase to a value of 0.5, where the “Net0” scenario again shows a better performance, potentially reflecting the benefits of a diversified energy strategy relying on more trustable partners.

Human Health Damage, closely related to environmental quality, shows a significant decrease, particularly under scenarios that prioritize emissions reduction, emphasizing further the positive intersection of environmental policy and public health outcomes. Fatalities, even if they result in a minimal difference between scenarios by 2050, exhibit a peak in 2030 in Net0 while they are smaller in No

CCUS, with the latter appearing to be the safer option. This is driven by a lag in renewable installation by the CCUS. Indeed, especially for wind and hydro, fatalities are relatively higher compared to other model technologies.

Conversely, shifting to Net0 initially coincides with a decline in measured Quality of Labor (using the Human Development Index). This trend implies potential challenges in transitioning towards power systems heavily reliant on renewable energy, leading to a shift in the labor demand within countries marked by unfavorable labor conditions, particularly in critical supply chains for renewable materials.

Conclusively, the “Net0” scenario emerges as the most favorable in terms of mitigating environmental impacts, exhibiting marked improvements across the key environmental indicators such as GWP (by definition), Acidification Potential, Eutrophication Potential, and Water Use, which aligns with its intrinsic emphasis on stringent environmental policy and energy transition measures. However, the “Net0” scenario presents the highest Land Use compared to the other considered scenarios, due to the necessity to allocate land for renewables deployment. Simultaneously, socio-economic benefits are visible under this scenario, particularly with respect to diminishing Import Dependence and the Volume Shortage Risk, indicating a strategic reshaping of energy reliance patterns. However, the “No H₂” and “No CCUS” scenarios, by relying less on fossil fuels, unveils unique trends, particularly enhancing Geopolitical Stability.

5 Conclusions and Perspectives

5.1 Conclusions

The chapter illustrates how to properly evaluate the implications of energy scenarios as to the overall system sustainability and achievement of the SDGs, using the open-source and open-data TEMOA-Italy combined with a set of indicators reflecting environmental, security, and social dimensions of the transition. These findings underscore the complexity of energy transition pathways and highlight the importance of balancing environmental, social, and economic considerations in shaping sustainable energy futures.

The analysis illustrates the synergies between the net-zero emission target, the limitation of acidification and eutrophication risks and public health. However, this achievement comes with a notable increase in land use, indicating a trade-off between environmental benefits and land resource demands for renewable deployment.

Moreover, the net-zero scenario demonstrates promising strides in enhancing energy security and geopolitical stability and reducing supply shortage risks, although facing increased challenges in maintaining reliability. However, the transition to renewable-heavy systems poses initial challenges to labor quality and import dependence due to critical reliance on imports of renewable technologies.

If the net-zero emission scenario emerges as a frontrunner in addressing environmental concerns and reshaping energy reliance patterns, alternative scenarios like

“No H₂” and “No CCUS” offer unique advantages in terms of geopolitical stability and reduced volume shortage risk.

5.2 Perspectives

Several model improvements are on-going to contribute to better understanding crucial issues towards sustainable development of energy systems.

The link between energy and water resources is multifaceted. Water is an essential element in the energy value chain (Siddiqi and Anadon 2011) and, conversely, energy is indispensable for water withdrawal, treatment, and delivery to the end-users (Carter 2017). The study of water in ESOMs is not just about their reciprocal uses but extends to its central roles in realizing different SDGs directly (6, 7, and 13) and indirectly (2, 8, and 9). While a single resource modeling approach fails to capture the interconnection dynamics effectively, considering both water and energy resources enables the incorporation of additional inter and intra-sectoral factors, thus obtaining a more accurate present layout and future evolutions (Alfano 2022). For instance, integrated methodology can highlight the key role of the water supply sector in shaping both water system and the energy system demand side. By bridging the gap between energy and water modeling, integrated assessment paves the way to a substantial planning uplift for policymakers and researchers engaged in water and energy resource management, in the perspective of achieving the SDGs 6 and 7. As a future improvement, the integrated approach implemented in the TEMOA framework is also planned to be enriched by extending water-sector technologies and including water consuming energy-sector technologies.

Secondly, the transition from a fossil-based to a renewable-based energy system presents some challenges that traditional ESOMs are currently not able to address (Aryanpur et al. 2021). First, the location of suitable sites to place energy plants (considering the physical and atmospheric parameters determining its performance) may not coincide with the availability of electrical infrastructure. Then, the land use of a specific site may be constrained by many factors (e.g., administrative, technical, economic). In addition, optimal land allocation should consider all of the different multi-sectoral options for that specific site, ranging from agricultural to energy use (Ramos et al. 2022). Lastly, Variable Renewable Energy Sources (VRESs) are characterized by intensive land-use and variable production (Wang et al. 2020). In existing optimization models that minimize the total cost of the energy system, location-specific production profiles are often used to estimate VRES potential, but land-use and land cover aspects have been largely ignored (Wang et al. 2020). In the Italian context, these challenges are particularly relevant due to the significant landscape heritage and the economic relevance of the agricultural sector (ISTAT 2023), each imposing distinct constraints and tradeoffs in terms of land utilization. Consequently, to investigate how the integration of these aspects into ESOM could impact the proposed decarbonization pathways, the authors are in the process of developing a TEMOA-Italy land-specific model instance. Properly understanding

the interconnection between land use and the energy sector is of pivotal importance, especially in the context of the Water-Energy-Food Nexus (Liu et al. 2018) and realization of the SDG 15.

Eventually, the energy-material nexus is the latest extension of the TEMOA modeling framework: in particular, the problem is currently being addressed from an energy security perspective. Indeed, the spread of clean energy technologies can increase the energy independence of countries that presently have a high fossil fuel import reliance. However, the production of many so-called “clean” energy technologies (e.g., solar panels, wind turbines, battery electric vehicles) present high geographical concentration (mainly in China (IEA 2023)) along all the supply chain steps, from raw material extraction to component manufacturing and system assembly, thereby increasing the risk of possible supply bottlenecks (Carrara et al. 2023). Hence, the massive penetration of renewable energy stated by the worldwide energy policies could lead to new energy security issues, that must be strategically addressed (Hache 2018). Energy security, and in particular import dependence, is only one of the several aspects to consider when addressing the energy-material nexus. Indeed, future developments have already been identified regarding the environmental, social, and governance practices in the clean energy technology supply chain (Colucci et al. 2023), allowing for the transversal consideration of several SDGs such as the 7, 8, 9, and 12.

Data Availability The release 3.0 of the TEMOA-Italy database is available at <https://github.com/MAHTEP/TEMOA-Italy/releases/tag/3.0>, and the TEMOA version developed by MAHTEP Group is available at <https://github.com/MAHTEP/TEMOA>.

References

- Alfano ME (2022) Modeling the energy and the water systems in an open-access energy system optimization model: the Pantelleria case study. Politecnico di Torino
- Aryanpur V, O’Gallachoir B, Dai H, Chen W, Glynn J (2021) A review of spatial resolution and regionalisation in national-scale energy systems optimisation models. *Energy Strat Rev* 37: 100702. <https://doi.org/10.1016/J.ESR.2021.100702>
- Balbo A, Colucci G, Nicoli M, Savoldi L (2023) Exploring the role of hydrogen to achieve the Italian decarbonization targets using an open-source energy system optimization model. *Int J Energy Power Eng* 17:89–100
- Blanco H, Codina V, Laurent A, Nijs W, Maréchal F, Faaij A (2020) Life cycle assessment integration into energy system models: an application for Power-to-Methane in the EU. *Appl Energy* 259:114160. <https://doi.org/10.1016/J.APENERGY.2019.114160>
- Brodny J, Tutak M (2023) Assessing the energy security of European Union countries from two perspectives—a new integrated approach based on MCDM methods. *Appl Energy* 347:121443. <https://doi.org/10.1016/j.apenergy.2023.121443>
- Carrara S, Bobba S, Blagoeva D, Alves Dias P, Cavalli A, Georgitzikis K, Grohol M, Itul A, Kuzov T, Latunussa C, Lyons L, Malano G, Maury T, Prior Arce A, Somers J, Telsnig T, Veeh C, Wittmer D, Black C, Pennington D, Christou M (2023) Supply chain analysis and material demand forecast in strategic technologies and sectors in the EU—a foresight study. Publications Office of the European Union, Luxembourg. <https://doi.org/10.2760/386650>

- Carrión D, Palacios J, Espinel M, González JW (2021) Transmission expansion planning considering grid topology changes and N-1 contingencies criteria. *Lect Notes Electr Eng* 762:266–279. https://doi.org/10.1007/978-3-030-72208-1_20/COVER
- Carter NT (2017) Energy-water nexus: the water sector's energy use Claudia Copeland specialist in resources and environmental policy. Congressional Research Service
- Colucci G, Lerede D, Nicoli M, Savoldi L (2022) Dynamic accounting for end-use CO₂ emissions from low-carbon fuels in energy system optimization models. *Energy Proc* 29. <https://doi.org/10.46855/energy-proceedings-10294>
- Colucci G, Lerede D, Nicoli M, Savoldi L (2023) A dynamic accounting method for CO₂ emissions to assess the penetration of low-carbon fuels: application to the TEMOA-Italy energy system optimization model. *Appl Energy* 352:121951. <https://doi.org/10.1016/j.apenergy.2023.121951>
- Erbach G, Jensen L, Chahri S, Claros E (2022) Fit for 55—the EU's plan for a green transition. European Council
- European Council (2021) Fit for 55—the EU's plan for a green transition. <https://www.consilium.europa.eu/en/policies/green-deal/fit-for-55-the-eu-plan-for-a-green-transition/>
- Eurostat (2023) Energy balances—energy—Eurostat. European Commission. <https://ec.europa.eu/eurostat/web/energy/data/energy-balances>
- Gayen D, Chatterjee R, Roy S (2023) A review on environmental impacts of renewable energy for sustainable development. *Int J Environ Sci Technol*:1–26. <https://doi.org/10.1007/S13762-023-05380-Z/FIGURES/1>
- Gestore Servizi Energetici (GSE) Statistiche. <https://www.gse.it/dati-e-scenari/statistiche>
- Hache E (2018) Do renewable energies improve energy security in the long run? *Int Econ* 156:127–135. <https://doi.org/10.1016/J.INTECO.2018.01.005>
- International Energy Agency (IEA) (2023) Energy technology perspectives 2023
- International Organization for Standardization (ISO) 2006 ISO 14044:2006—environmental management—life cycle assessment—requirements and guidelines <https://www.iso.org/standard/38498.html>
- ISTAT (2023) Landscape and cultural heritage. Rome
- Laera S, Colucci G, Di Cosmo V, Lerede D, Nicoli M, Savoldi L (2024) Technology-specific hurdle rates for energy system optimization models. *Energy Proc*. <https://doi.org/10.46855/energy-proceedings-10911>
- Lerede D, Bustreo C, Gracceva F, Lechón Y, Savoldi L (2020) Analysis of the effects of electrification of the road transport sector on the possible penetration of nuclear fusion in the long-term European energy mix. *Energies* 13:3634. <https://doi.org/10.3390/EN13143634>
- Lerede D, Bustreo C, Gracceva F, Saccone M, Savoldi L (2021) Techno-economic and environmental characterization of industrial technologies for transparent bottom-up energy modeling. *Renew Sustain Energy Rev* 140:110742. <https://doi.org/10.1016/j.rser.2021.110742>
- Liu J, Hull V, Godfray HCJ, Tilman D, Gleick P, Hoff H, Pahl-Wostl C, Xu Z, Chung MG, Sun J, Li S (2018) Nexus approaches to global sustainable development. *Nat Sustain* 2018 1:9 1:466–476. <https://doi.org/10.1038/s41893-018-0135-8>
- Loulou R, Goldstein G, Kanudia A, Lettila A, Remme U (2016) Documentation for the TIMES model: part I
- MAHTEP Group (2023) MAHTEP/TEMOA-Italy—release 3.0. GitHub <https://github.com/MAHTEP/TEMOA-Italy/releases/tag/3.0>
- Marrero RJ, Andrés Hernández-Cabrera J, Fumero A, Hernández B (2021) Social acceptance of gas, wind, and solar energies in the Canary Islands. *Int J Environ Res Public Health* 18:9672. <https://doi.org/10.3390/ijerph18189672>
- Martín-Gamboa M, Iribarren D, García-Gusano D, Dufour J (2017) A review of life-cycle approaches coupled with data envelopment analysis within multi-criteria decision analysis for sustainability assessment of energy systems. *J Clean Prod* 150:164–174. <https://doi.org/10.1016/J.JCLEPRO.2017.03.017>
- Martins F, Moura P, de Almeida AT (2022) The role of electrification in the decarbonization of the energy sector in Portugal. *Energies* 15(5):1759. <https://doi.org/10.3390/EN15051759>

- Ministry of Economic Development (2020) National hydrogen strategy preliminary guidelines
- Ministry of Economic Development, Ministry of the Environment and Land and Sea Protection, Ministry of Infrastructure and Transport (2019) Integrated national energy and climate plan 2019
- Ministry of Environment and Energy Security (2023) Bollettino petrolifero—Statistiche energetiche e minerarie <https://dgsaie.mise.gov.it/bollettino-petroliifero>
- Ministry of the Environment and Land and Sea Protection, Ministry of Economic Development, Ministry of Infrastructure and Transport, Ministry of Agricultural F and FP (2021) Italian long-term strategy of greenhouse gases emissions reduction
- Miola A, Schiltz F (2019) Measuring sustainable development goals performance: how to monitor policy action in the 2030 agenda implementation? *Ecol Econ* 164:106373. <https://doi.org/10.1016/j.ecolecon.2019.106373>
- Mohtar RH, Daher B (2016) Sustainability in the water-energy-food nexus. *Water Int* 41:655–661. <https://doi.org/10.1080/02508060.2016.1149759>
- Mosso D, Colucci G, Lerede D, Nicoli M, Piscitelli MS, Savoldi L (2024) How much do carbon emission reduction strategies comply with a sustainable development of the power sector? *Energy Rep* 11:3064–3087
- Muniz RN, Stefenon SF, Buratto WG, Nied A, Meyer LH, Finardi EC, Kühl RM, de Sá JAS, da Rocha BRP (2020) Tools for measuring energy sustainability: a comparative review. *Energies* 13:2366. <https://doi.org/10.3390/EN13092366>
- Nicoli M (2021) A TIMES-like open-source model for the Italian energy system. Politecnico di Torino, Turin
- Nicoli M, Gracceva F, Lerede D, Savoldi L (2022) Can we rely on open-source energy system optimization models? The TEMOA-Italy case study. *Energies* 15:6505. <https://doi.org/10.3390/en15186505>
- Nicoli M, Faria VAD, de Queiroz AR, Savoldi L (2024) Modeling energy storage in long-term capacity expansion energy planning: an analysis of the Italian system. *J Energy Storage* (Under review for publication)
- Niet T, Fraser S, Arianpoo N, Kuling K, Wright A, Wright AS (2021) Embedding the United Nations sustainable development goals into systems analysis—expanding the food-energy-water nexus. *Energy Sustain Soc* 11:1. <https://doi.org/10.1186/s13705-020-00275-0>
- Nock D, Baker E (2019) Holistic multi-criteria decision analysis evaluation of sustainable electric generation portfolios: New England case study. *Appl Energy* 242:655–673. <https://doi.org/10.1016/j.apenergy.2019.03.019>
- OECD (2008) Handbook on constructing composite indicators: methodology and user guide. OECD, Paris
- Oliva A, Gracceva F, Lerede D, Nicoli M, Savoldi L (2021) Projection of post-pandemic Italian industrial production through vector AutoRegressive models. *Energies* 14:5458. <https://doi.org/10.3390/EN14175458>
- Perdigão RAP (2023) Complexity and sustainability: from system dynamics to coevolutionary spacetimes. In: Introduction to designing environments, pp 11–32. https://doi.org/10.1007/978-3-031-34378-0_2
- Ramos EP, Sridharan V, Alfstad T, Niet T, Shivakumar A, Howells MI, Rogner H, Gardumi F (2022) Climate, land, energy and water systems interactions—from key concepts to model implementation with OSeMOSYS. *Environ Sci Pol* 136:696–716. <https://doi.org/10.1016/J.ENVSCI.2022.07.007>
- Ruiz P, Nijs W, Tarvydas D, Sgobbi A, Zucker A, Pilli R, Jonsson R, Camia A, Thiel C, Hoyer-Klick C, Dalla Longa F, Kober T, Badger J, Volker P, Elbersen BS, Brosowski A, Thrän D (2019) ENSPRESO—an open, EU-28 wide, transparent and coherent database of wind, solar and biomass energy potentials. *Energ Strat Rev* 26:100379. <https://doi.org/10.1016/J.ESR.2019.100379>
- Siddiqi A, Anadon LD (2011) The water–energy nexus in Middle East and North Africa. *Energy Policy* 39:4529–4540. <https://doi.org/10.1016/J.ENPOL.2011.04.023>

- Simoes S, Nijs W, Ruiz P, Sgobbi A, Radu D, Bolat P, Thiel C, Peteves S (2013) The JRC-EU-TIMES model—assessing the long-term role of the SET plan energy technologies. European Commission—Joint Research Centre. <https://doi.org/10.2790/97799>
- Terna Electric System. Terna. <https://www.terna.it/en/electric-system>
- United Nations Economic Commission for Europe (UNECE) (2021) Carbon neutrality in the UNECE region: integrated life-cycle assessment of electricity sources
- Wang N, Verzijlbergh RA, Heijnen PW, Herder PM (2020) A spatially explicit planning approach for power systems with a high share of renewable energy sources. *Appl Energy* 260:114233. <https://doi.org/10.1016/J.APENERGY.2019.114233>

Open Access This chapter is licensed under the terms of the Creative Commons Attribution 4.0 International License (<http://creativecommons.org/licenses/by/4.0/>), which permits use, sharing, adaptation, distribution and reproduction in any medium or format, as long as you give appropriate credit to the original author(s) and the source, provide a link to the Creative Commons license and indicate if changes were made.

The images or other third party material in this chapter are included in the chapter's Creative Commons license, unless indicated otherwise in a credit line to the material. If material is not included in the chapter's Creative Commons license and your intended use is not permitted by statutory regulation or exceeds the permitted use, you will need to obtain permission directly from the copyright holder.



Part II
**Using Energy System Modelling to Support
the Transition to Renewable Energy**

Assessing the Impact of Climate Variability on Wind Energy Potential in Decarbonization Scenarios in Energy Systems Models



Bryn Stecher, Taiba Jafari, Lewis Wu, Olexandr Balyk, Áine Greene, and James Glynn

Abstract Anticipated changes in wind patterns and magnitudes due to climate change pose potential challenges to future wind energy potential. Using three shared socioeconomic pathways (SSP) across five global climate models, the impacts of climate variability on wind energy potential were assessed, utilizing the wind capacity factor as a comparable value. The evaluation includes all operating onshore and offshore wind farms globally over the remainder of the century. Adopting global statistical analysis methods and the TIMES United States model (TUSM), the influence of climate variability on wind energy is modeled, providing insights into how specific decarbonization scenarios impact the achievement of Sustainable Development Goals (SDGs), particularly SDG 7 (Affordable and Clean Energy) and SDG 11 (Sustainable Cities and Communities). Results reveal minimal variation in capacity factor values among the SSP scenarios, indicating that wind energy is likely to remain a robust power generation source, regardless of the chosen decarbonization scenario. These findings hold important implications for wind turbine design, deployment strategies, and regional energy planning and policy. The study underscores the need to consider climate variability in decarbonization strategies, emphasizing the role of wind energy in aligning with the objectives of SDG 7 and SDG 11.

Key Messages

- The global path to decarbonization will shape wind generation patterns and strength, affirming wind as a reliable and robust source of energy, with variations in global wind capacity factors being mostly negligible compared to historical values.

B. Stecher (✉) · T. Jafari · L. Wu · O. Balyk · Á. Greene · J. Glynn
Center on Global Energy Policy, SIPA, Columbia University, New York, NY, USA
e-mail: bs3157@columbia.edu; tj2528@columbia.edu; zw2783@columbia.edu;
o.balyk@columbia.edu; ag4679@columbia.edu; james.glynn@columbia.edu

© The Author(s) 2024

M. Labriet et al. (eds.), *Aligning the Energy Transition with the Sustainable Development Goals*, Lecture Notes in Energy 101,
https://doi.org/10.1007/978-3-031-58897-6_6

121

- Using TIMES, scenarios based on user-imposed economic and environmental constraints were analyzed, revealing increases in wind energy generation and new capacity installation in alignment with the goals of attaining SDGs 7, 11 and 13; onshore projects underscore sensitivity to climate impacts.
- Future annual wind energy potential (2015–2100), on average, is expected to remain relatively consistent with historical values (1981–2014).
- Policymakers should consider focusing on developing wind farms in high-potential regions, enhancing electricity infrastructure, and energy storage and mix diversification.

1 Introduction

Rapid global expansion of wind energy capacity is a core component of the future zero-carbon power system globally (IEA 2023; Intergovernmental Panel on Climate Change (IPCC) 2023). A remarkable surge in wind energy installed capacity, in response to climate change mitigation and improving energy security has occurred in the past two decades. However, there is minimal knowledge about how climate change may affect wind energy potential by the end of this century globally. Climate change will impact various climate variables such as surface wind speeds, wind patterns and intensity and thereby directly affect wind energy production in certain regions. In anticipation of additional new wind farm developments, planning wind turbine deployment in areas of projected high wind energy potential is beneficial.

Previous studies assessing the impact of climate variability on wind energy potential have concentrated on individual countries or specific geographic regions (Fournier et al. 2023; Miao et al. 2023; Soares et al. 2019; Tobin et al. 2016; Viviescas et al. 2019), specific decarbonization scenarios (Lobeto et al. 2021), did not include energy modeling (Jung and Schindler 2022; Pryor et al. 2020), and or a shorter timeline (Devis et al. 2018) which are often constrained by a limited spatial and temporal scope. This study overlooks the intricate spatial and temporal fluctuations in wind patterns and their consequential impact on wind energy. Additionally, previous studies have shown a decrease in wind energy in the Northern Hemisphere and the mid-latitudes, while an increase in the Southern Hemisphere and the tropics. This southward wind shift is linked to the consequences of polar amplification and enhanced land-sea thermal gradients (Karnauskas et al. 2018). Tropical processes and changes in subtropical static stability potentially also play a role in this southward shift in wind (Mbengue and Schneider 2013). However, some found that wind speeds decrease in the tropics (30°N – 30°S) but increase in the extratropics (30°–90° in both hemispheres) due to the intensification and poleward shift of the midlatitude storm tracks (Gastineau and Soden 2009). Additionally, wind speeds have decreased over the past several decades due to anthropogenic climate change, defined as ‘global stilling.’ Global stilling occurs since the arctic is warming at a faster rate compared to the tropics, which is causing a decrease in the temperature gradient between poles and equator, resulting in weaker atmospheric circulation patterns and wind speeds globally (Tian et al. 2019; Zeng et al. 2019).

This research investigates how climate variability and decarbonization scenarios could simultaneously affect the capacity factor of current operating wind farms globally. Decarbonization scenarios are future insights into how the world may respond to climate change mitigation and adaptation. By using historical data and five global circulation model simulations of daily wind from 2015 through 2100, a new analysis is presented on how changes in wind speeds from different SSPs affect wind energy production. As temperatures increase, the air becomes less dense, which reduces the speed of the wind and therefore the energy output of turbines. Additionally, under various SSPs, the weather conditions undergo diverse changes that impact wind patterns, influencing factors such as wind speed, direction, and overall atmospheric dynamics, thereby shaping the performance of wind energy systems. The results highlight areas where wind energy production is expected to fluctuate depending on the decarbonization scenario and global climate model. The findings can inform decision-making processes related to deploying wind turbines under various decarbonization scenarios within specific communities and regions and add to the larger conversation on the switch to more renewable energy sources in order to meet various infrastructural and climate goals.

An approach of maximizing wind energy production aligns with SDG 7: Affordable and Clean Energy, by examining the impact of climate variability and decarbonization scenarios on the capacity factor of wind farms globally. The capacity factor is a crucial metric for assessing wind energy operation and availability. The capacity factor of a wind turbine measures the actual power output of a wind turbine relative to its maximum power potential under ideal conditions and for a given wind speed is dependent on the International Electrotechnical Commission (IEC) classification of that turbine. Strategic development of wind farms in regions with projected high wind energy potential correlates to ensuring access to affordable, reliable and clean energy. Additionally, as climate change can lead to extreme weather events, including wind-related events, this research further aligns with SDG 11: Sustainable Cities and Communities, as it has implications for planning sustainable energy solutions in urban and rural communities. Improving the resilience of cities and human settlements by implementing informed planning and infrastructure development can help mitigate the impacts of climate-induced changes in wind patterns.

2 Methods

An in-depth statistical analysis of how wind farm capacity changes on a global scale over an 85-year period at a daily resolution was conducted. This novel approach, incorporating decarbonization scenarios and global climate models, aims to mitigate bias and enhance the robustness of the results for future projected scenario analysis. Subsequently, a TIMES United States energy system model (TUSM) was developed, and used to compare power sector scenarios with and without climate impacts and the corresponding projected effects on wind energy generation, electricity

supply and new capacity installation. Analyzing the TUSM results enabled discussion on the alignment of SDGs 7 and 11 to the energy transition. The overall objective was to compile a comprehensive outlook on the potential trajectories of wind speeds and their associated impacts on wind energy production, ultimately providing insights into the resilience and adaptability of wind farms in different decarbonization pathways.

2.1 Definition of the Decarbonization Scenarios

Three decarbonization scenarios, SSP 1-2.6, SSP 3-7.0, and SSP 5-8.5, run by five different global climate models, GFDL-ESM 4, IPSL-CM6A-LR, MPI-ESM 1-2-HR, MRI-ESM 2-0, and UKESM1-0-LL (Boucher et al. 2020; Dunne et al. 2020; Müller et al. 2018; Tang et al. 2019; Yukimoto et al. 2019) were used to assess the impact of climate variability on wind energy potential:

1. SSP 1-2.6: Represents a low-emission pathway, characterised by rapid and comprehensive decarbonization of the global economy. It involves a significant shift towards renewable energy sources, energy efficiency, and sustainable practices. Emissions are reduced substantially to limit global warming to well below 2 °C in line with the Paris Agreement;
2. SSP 3-7.0: Portrays a high-emission pathway, where emissions continue to rise due to limited efforts to reduce greenhouse gas (GHG) emissions. The global economy relies heavily on fossil fuels, and there is limited international cooperation to address climate change. Consequently, this scenario does not comply with the Paris Agreement and would lead to a projection of a 3.0 °C global mean temperature increase by 2084;
3. SSP 5-8.5: Emissions continue to increase at a high rate, primarily driven by a fossil fuel-dependent global economy. There is a lack of effective climate policies and little effort to mitigate GHG emissions. This scenario is highly incompatible with the Paris Agreement and would lead to a projection of a 3.0 °C global mean temperature increase by 2076.

The GFDL-ESM 4, IPSL-CM6A-LR, MPI-ESM 1-2-HR, MRI-ESM 2-0, and UKESM1-0-LL global climate models manifest distinctions in their portrayal of temperature changes, stemming from unique structural attributes and modeling methodologies. GFDL-ESM 4 stands out for its advanced representation of atmospheric, chemistry, carbon, and ecosystem dynamics utilizing the National Oceanic and Atmospheric Administration's (NOAA) coupled carbon-chemistry-climate model (Dunne et al. 2020). IPSL-CM6A-LR is recognized for its comprehensive and sensitive Earth system components and robust simulation of biogeochemical processes. However, IPSL-CM6A-LR has certain biases including the double Inter-tropical Convergence Zone, frequency of midlatitude wintertime blockings, and El Niño-Southern Oscillation dynamics (Boucher et al. 2020). MPI-ESM 1-2-HR

specifically examines oceanic and atmospheric conditions, including the El Niño-Southern Oscillation climate phenomena and the North Atlantic Oscillation. This yields a decreased bias of upper-level zonal wind and atmospheric jet stream position in the northern extratropics (Müller et al. 2018). MRI-ESM 2-0 distinguishes itself with its emphasis on cloud processes and improved representation of aerosols as it has 80 atmospheric layers (Yukimoto et al. 2019). UKESM1-0-LL, the first United Kingdom Earth System Model that uses climate model HadGEM3-GC31-LL as its base, is notable for its high climate sensitivity and complex ocean, land, atmospheric, and biochemical cycles that are unprecedented compared to other Earth system models (Sellar et al. 2019). The models range in latitude-longitude grid resolution from 1.0 to 2.0° with IPSL-CM6A-LR and UKESM 1-0-LL having the lower resolution. Among the models, GFDL-ESM 4, MPI-ESM1-2-HR, and MRI-ESM 2-0 exhibit similar projections of future temperature increases across SSP scenarios, with annual temperatures anticipated to range from 15 to 18 °C by the end of the century, where the annual average temperature in 2022 was 13.3 °C (National Weather Service n.d.). Contrarily, IPSL-CM6A-LR and UKESM1-0-LL project larger temperature increases as they account for larger climate sensitivities, spanning 15.5–21 °C. Notably, under these latter two global climate models, the temperature disparities between SSP 1-2.6 and the higher SSPs are more pronounced than in the other three models. Across all five global climate models, SSP 5-8.5 demonstrates the highest temperature increase over time, closely followed by SSP 3-7.0, and then SSP 1-2.6. These variations emphasize the significance of considering specific modeling characteristics when interpreting temperature change projections derived from these models in the context of climate research.

2.2 Data Pipeline Process

The global climate data was accessed through The Inter-Sectoral Impact Model Intercomparison Project (ISIMIP), which provided access to surface wind speed historical and future data under each decarbonization scenario and global climate model (Lange et al. 2023). For the location of the wind turbines, the Global Energy Monitors' (GEM) Wind Power Tracker data provided comprehensive information regarding the state of the geographical distribution of operational wind farms globally as of May 2023 ("Global Wind Power Tracker," 2023). Using the nearest neighbor search technique without any tolerance level, the surface wind speeds were extracted at each operating turbine location. The data pipeline developed for this study, as depicted in Fig. 1 is a significant innovative aspect of the research work.

To convert the wind speeds to an 80 m hub height level, as this is the typical height for onshore wind (Lee and Kang 2019), from a 10 m level, the empirical power law (Hueging et al. 2013; Miao et al. 2023) was used, where S_{80} is wind speed (m/s) at an 80 m hub height and S is the near-surface wind speed (m/s):

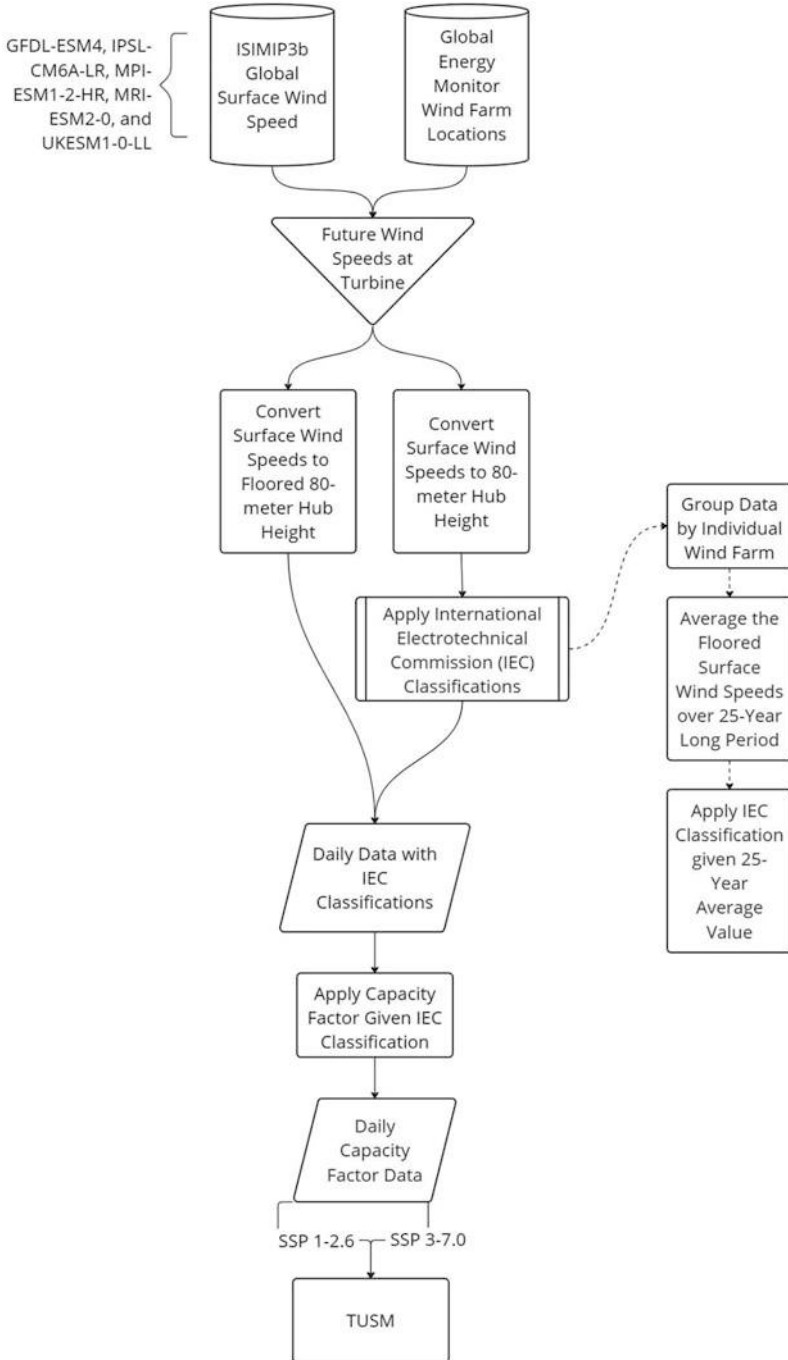

Fig. 1 Workflow used to generate capacity factors from surface wind speed data

$$S_{80} = S \cdot \left(\frac{80}{10}\right)^{0.143} \quad (1)$$

Having a 80 m hub height for all wind turbines, both onshore and offshore, is a broad assumption. However, this uniform assumption serves as a baseline to analyze changes in wind speeds at the most typical height. This approach promotes a reasonably tractable analysis within data limitations of the impact of decarbonization scenarios on wind energy at large, ensuring a fair assessment across different turbine types and locations.

An industry standard from the IEC was used to classify wind turbines based on their ability to withstand wind speeds and conditions and calculate the corresponding capacity factors. The IEC classification is determined based on the 80 m floored surface wind speed value of the individual turbine over its average lifespan, typically 25 years (Alsaleh and Sattler 2019). Within the scope of this study, three IEC classifications were used, ranging from Class I for turbines that can withstand the lowest wind speeds to Class III for turbines designed to withstand the highest ones. The wind profiles are based on normalized power curves for a 1 MW turbine for each of the three IEC classifications (Table 1).

2.3 Global Statistical Analysis

To examine the temporal evolution of wind capacity factors, this study involved a comparative assessment of future capacity factors with their historical counterparts. The investigation was initiated by calculating the average performance of individual wind turbines from 1981 to 2014 using ISIMIP's historical wind speed data. Subsequently, the daily and yearly differences between future and past wind speeds were quantified.

2.4 Overview of the TIMES United States (TUSM) Energy System Model Framework

This study builds on previous work using a TIMES United States model (TUSM) from Columbia University's Center on Global Energy Policy. While data is analyzed on a global scale, TUSM is used as an illustrative example of the comprehensive

Table 1 IEC classifications

25-year average surface wind speed 80 m floor value (m/s)	IEC classifications
<7.5	Class I
$7.5 \leq X \leq 8.5$	Class II
>8.5	Class III

modeling capabilities available for examining and optimizing energy systems. TUSM is a model that stems from the International Energy Agency's (IEA) Energy Technology Systems Analysis Program's (ETSAP) Integrated MARKAL-EFOM System (TIMES) (IEA-ETSAP 2024), a bottom-up energy system optimization model. TIMES uses linear programming to determine the least-cost optimal energy system configuration based on various technical and economic constraints set by the user on medium to long-term timescales. TUSM, which is under ongoing development, currently models the United States' power sector using open source datasets including National Renewable Energy Laboratory (NREL) Annual Technology Baseline, Energy Information Administration (EIA) Form 860 and demand forecasts, and United States Environmental Protection Agency's (EPA) National Electric Energy Data System (NEEDS). The model studies the power sector on an annual, seasonal, weekly, daily, and hourly level to best capture the dynamics of the power sector from 2020 to 2050. The results shown are those using 40 time slices which means that the data is averaged by season and weekday type for each of the lower 48 states each as an aggregated node, such as weekdays in Fall 2020 in New York. TUSM computes the least-cost configuration of energy technologies that meet energy demands while adhering to technical, economic, and policy limitations as specified within a scenario analysis. To illustrate the interconnectedness of energy and climate change, TUSM provides a technology-rich basis for representing the power sector dynamics incorporating decarbonization scenarios. TUSM has operational constraints, including commodity prices, and the role of storage. The model offers a way to analyze the effect of a changing wind capacity factor on electricity supply and new capacity installations. The capacity or growth constraint of new wind annually cannot grow more than 11% year-over-year for 2024 onwards for onshore wind and 2023 for offshore wind. The 11% is derived from the United States' average annual increase in wind capacity (Hoen et al. 2018). Additionally, the years 2024 and 2023 were chosen as the data up until those years was exogenously specified in terms of installed capacity. For the years before 2024 for onshore wind and 2023 for offshore wind, the capacity or growth constraint is defined by the Energy Information Agency data.

Four scenarios were developed as shown in Table 2. The BASE (Reference) scenarios and Net-Zero 2035 (NZE35) scenarios represent the pathways with and

Table 2 Scenario matrix

Scenario name	Decarbonization scenario used for climate impacts	Description
BASE (reference) with climate impacts	SSP 3-7.0	Wind capacity factor is changing from 2020 to 2100
BASE (reference) without climate impacts	–	Wind capacity factor locked at 2020 levels
NZE35 with climate impacts	SSP 1-2.6	Wind capacity factor is changing from 2020 to 2100
NZE35 without climate impacts	–	Wind capacity factor locked at 2020 levels

without wind related climate impacts and provide a benchmark of comparison for wind energy generation, electricity supply and new capacity installation. Climate impacts on solar photovoltaic operation or temperature impacts upon energy service demands are not included in the model at this stage. The capacity factors for the climate impact scenarios are derived from GFDL-ESM 4.

- **BASE scenario with Climate Impacts:** The Base scenario is the least cost optimal pathway that delivers energy service demands. This scenario includes the current macroeconomic outlook, but does not explicitly include any emissions or policy constraints. It further includes climate impacts upon wind energy capacity factors, aligns with the decarbonization scenario SSP 3-7.0 and the wind capacity factors are changing from 2020 to 2100.
- **BASE scenario without Climate Impacts:** The Base scenario in this instance is modeled without climate impacts considered upon wind capacity factors. As such, instead of having a capacity factor specified by SSP 3-7.0, the data is based on the actual state-level capacity factor from the year 2020.
- **NZE35 scenario with Climate Impacts:** The Net-Zero scenario is the least cost optimal pathway that delivers energy service demands based on net zero carbon dioxide emissions by 2035 in the power sector. It includes climate impacts, aligns with the decarbonization scenario SSP 1-2.6 and the wind capacity factors are changing from 2020 to 2100.
- **NZE35 scenario without Climate Impacts:** The Net-Zero scenario in this instance is modeled without climate impacts considered. As such, instead of having a capacity factor specified by SSP 1-2.6, the data is based on the actual state-level capacity factor from the year 2020.

3 Results

In this section, the results are compared across the decarbonization scenarios and the global climate models using both statistical analyses and energy system optimization scenario analysis in TUSM.

3.1 Global Statistical Analysis

The following are the results of analyzing onshore wind separated by region, followed by an analysis of offshore wind. The section for offshore wind includes all of the countries that have operating offshore wind as of May 2023.

3.1.1 Africa

Under SSP 3-7.0, there is a significant and widespread increase in wind capacity factors for the majority of African countries, indicating a substantial improvement in wind energy potential across the continent (Fig. 2). Additionally, South Africa and Cabo Verde show consistent increases in wind capacity factors over time, underscoring a positive trend in wind energy development in these nations. Contrarily, Tunisia and Western Sahara experience a decrease in wind capacity factors over time, indicating a decline in wind energy potential.

3.1.2 Oceania

Australia and New Caledonia experience a slight decrease in wind capacity factors, indicating a minor decline in wind energy potential in these regions. Alternatively, Fiji and New Zealand largely maintain stable wind capacity factors, with Fiji showing a slight increase, particularly during peaks associated with SSP 3-7.0 (Fig. 3).

3.1.3 Americas

A notable decrease in wind capacity factors is observed in the United States, Canada, Bonaire, Sint Eustatius and Saba, Aruba, Argentina, and Colombia, reflecting a decline in wind energy potential in these regions (Fig. 4). Nonetheless, there is an increase in wind capacity factors in Martinique, Brazil, and Bolivia, suggesting a positive trend in wind energy potential. Under SSP 3-7.0, a notable increase in wind capacity factors is recorded in Guadeloupe and Guatemala. Additionally, under both SSP 3-7.0 and SSP 5-8.5, Honduras, Costa Rica, and Nicaragua experience an increase in wind capacity factors, indicating a promising outlook for wind energy development.

3.1.4 Asia

There is an overall increase in wind capacity factors in Thailand, Turkey, and the Philippines, signifying a positive trend in wind energy potential. Conversely, a decrease in wind capacity factors is observed in China, Cyprus, Jordan, Kazakhstan, Mongolia, and Kuwait, indicating a reduction in wind energy potential in these regions. Other countries show relatively stable wind capacity factors, suggesting a more neutral trend. Notably, SSP 1-2.6 and SSP 5-8.5 exhibit the most extreme fluctuations, both positive and negative, in wind capacity factors compared to the baseline values from 1981 to 2014, underlining the significance of how these decarbonization scenarios are shaping wind energy prospects (Fig. 5).

Fig. 2 Change in capacity factor for individual onshore wind turbines by the year 2100, relative to their 1981–2014 average in Africa under the SSP 1-2.6, 3-7.0, and 5-8.5 scenarios (Color figure online)

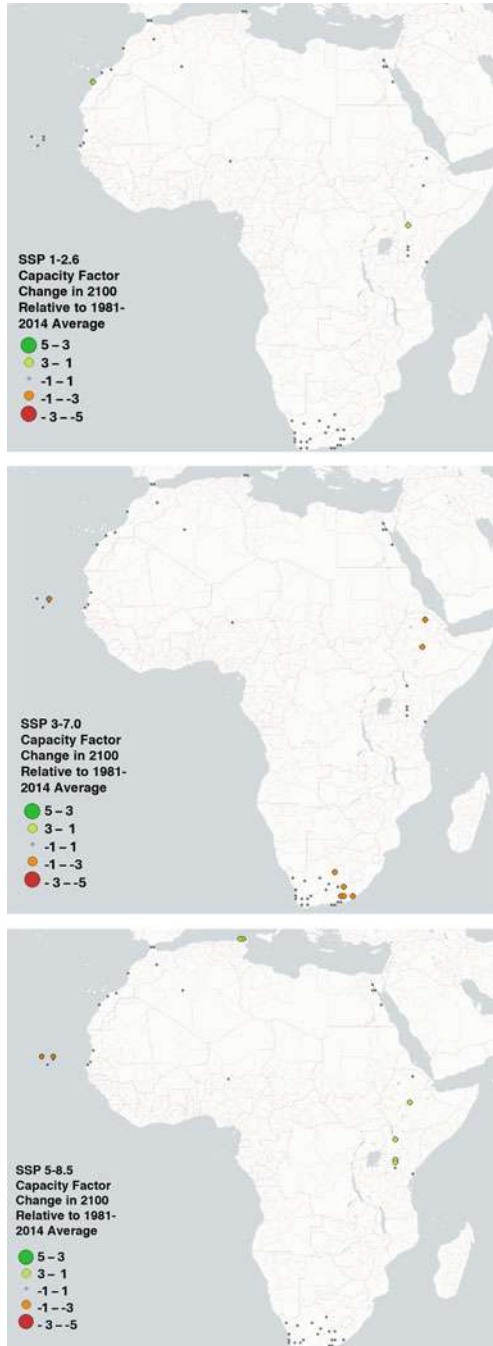

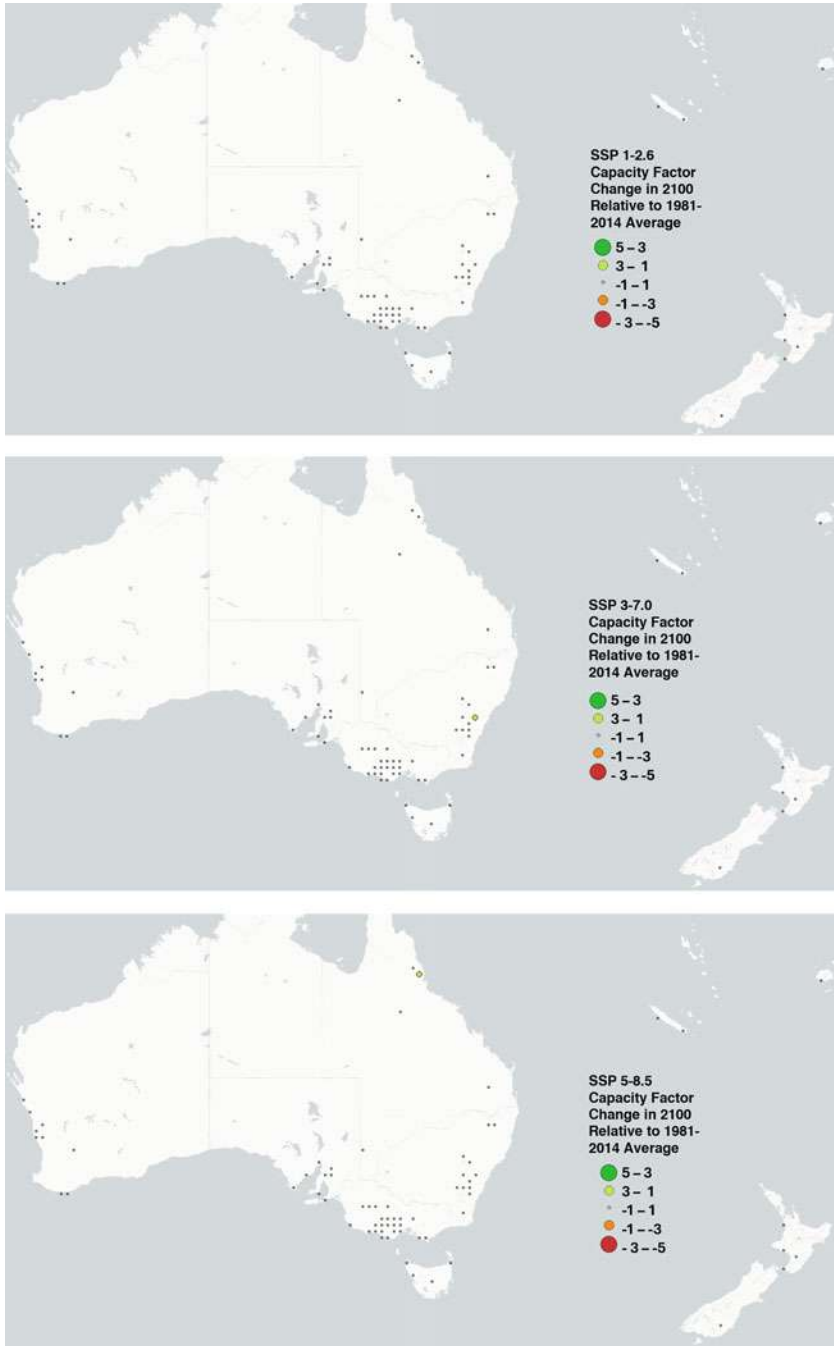
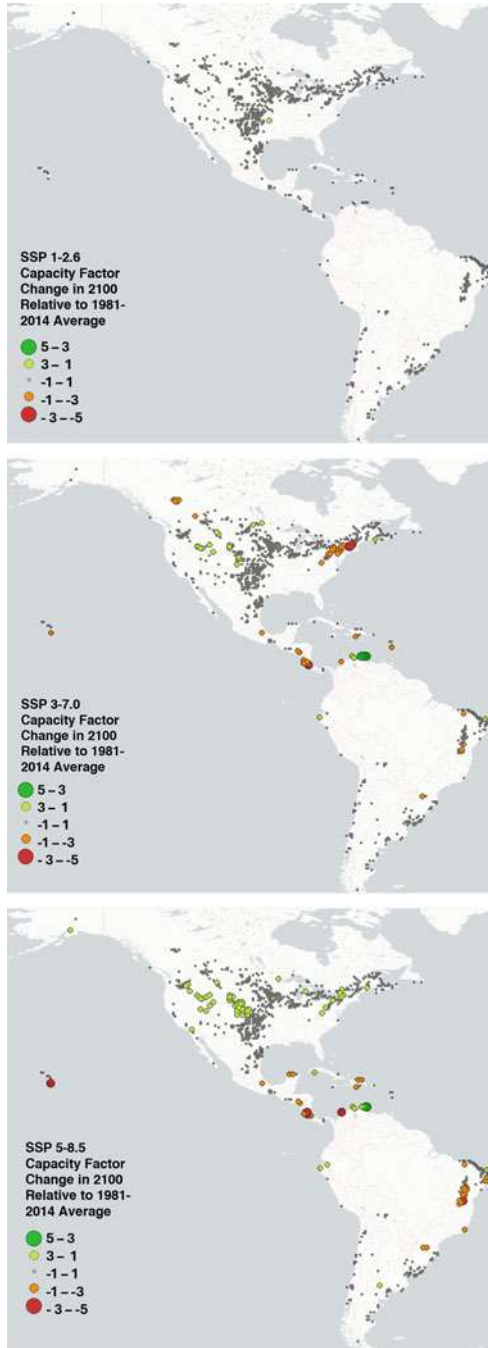

Fig. 3 Change in capacity factor for individual onshore wind turbines by the year 2100, relative to their 1981–2014 average in Oceania under the SSP 1-2.6, 3-7.0, and 5-8.5 scenarios (Color figure online)

Fig. 4 Change in capacity factor for individual onshore wind turbines by the year 2100, relative to their 1981–2014 average in American countries under the SSP 1-2.6, 3-7.0, and 5-8.5 scenarios (Color figure online)



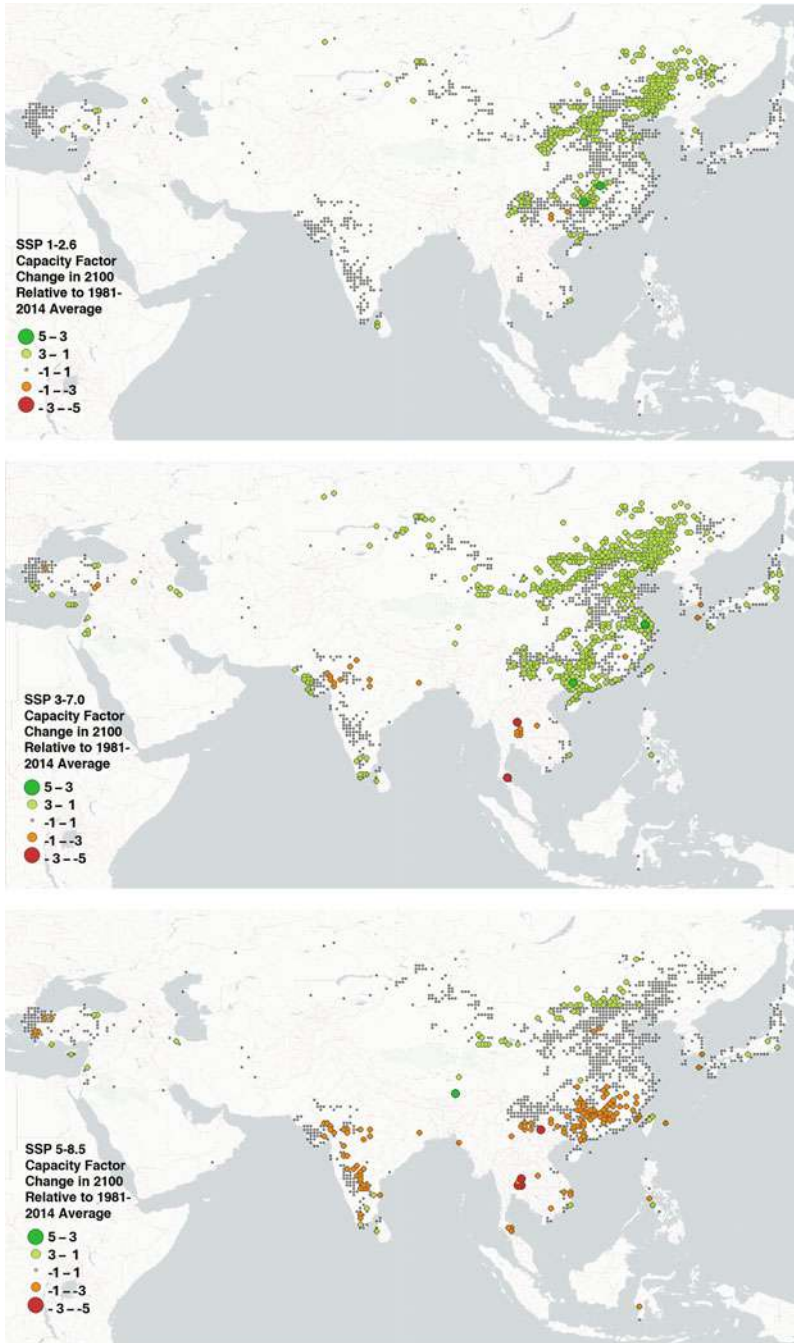

Fig. 5 Change in capacity factor for individual onshore wind turbines by the year 2100, relative to their 1981–2014 average in Asia under the SSP 1-2.6, 3-7.0, and 5-8.5 scenarios (Color figure online)

3.1.5 Europe

Consistently, every country experiences a decrease in capacity factor, with the notable exception of Finland, where capacity factors grew over the remainder of the century. There were notably larger decreases in capacity factors under SSP 3-7.0. Several countries, including Poland, Romania, Ukraine, Aland Islands, Ireland, Italy, Luxembourg, Lithuania, Kosovo, Netherlands, Belgium, and France, experience the largest decreases in Europe (Fig. 6).

3.1.6 Offshore

Over time, there is a notable increase in wind capacity factors in the United States, Belgium, and Finland, indicating a positive trajectory for wind energy potential offshore these countries (Fig. 7). In contrast, offshore wind in Japan is the only country that experiences a consistent decrease in wind capacity factors over time under all three decarbonization scenarios. Under SSP 3-7.0, both Mexico and Vietnam show a decrease in wind capacity factors, suggesting a decline in their wind energy prospects. China, on the other hand, experiences a decrease in wind capacity factors across different scenarios, except for SSP 5-8.5, where there is a slight positive trend, highlighting the variability in wind energy trends across different scenarios. SSP 3-7.0 and to a lesser extent SSP 1-2.6 are responsible for the majority of the peaks and troughs, except in the United States where SSP 5-8.5 is responsible for the most extreme outliers.

3.2 *Decarbonizing the Electricity Generation*

To analyze how wind generation changes under the scenarios outlined in 2.4 involved the utilization of TUSM. Over time, a discernible upward trend is observed in onshore wind generation, with scenario NZE35—No Climate Impacts standing out as the leader in terms of the highest generation additions followed by NZE35—With Climate Impacts. Contrarily, scenarios that do not align with the NZE35 goals depict a relatively constant level of generation, akin to the present-day. However, over time, the BASE scenarios generation gradually converges to approximately half of what is seen under NZE35 scenarios. This stagnant trend underscores the significant shift and scaling required in energy generation to meet net-zero targets under a least-cost optimal energy system configuration (Fig. 8). In summary, the temporal evolution in onshore wind generation emphasizes the pivotal role of scenarios aligned with NZE35, particularly without climate impacts, in driving substantial increases in generation.

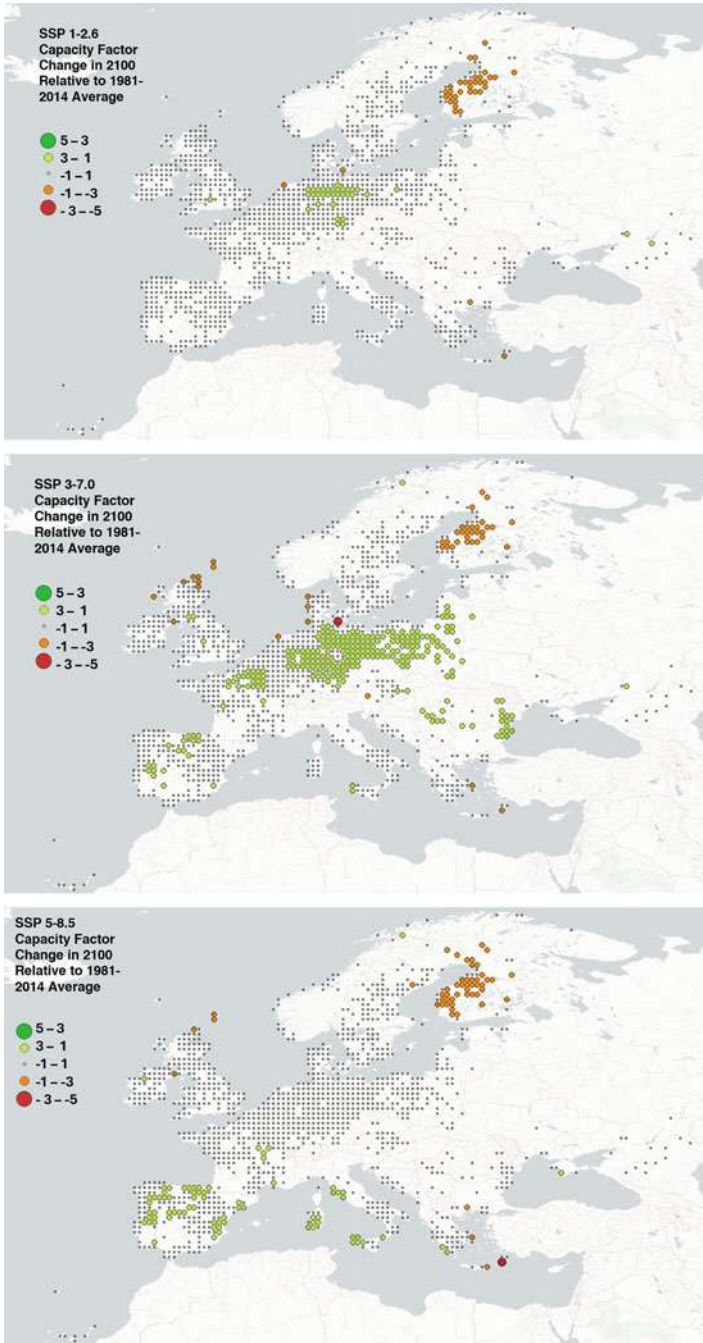

Fig. 6 Change in capacity factor for individual onshore wind turbines by the year 2100, relative to their 1981–2014 average in European countries under the SSP 1-2.6, 3-7.0, and 5-8.5 scenarios (Color figure online)

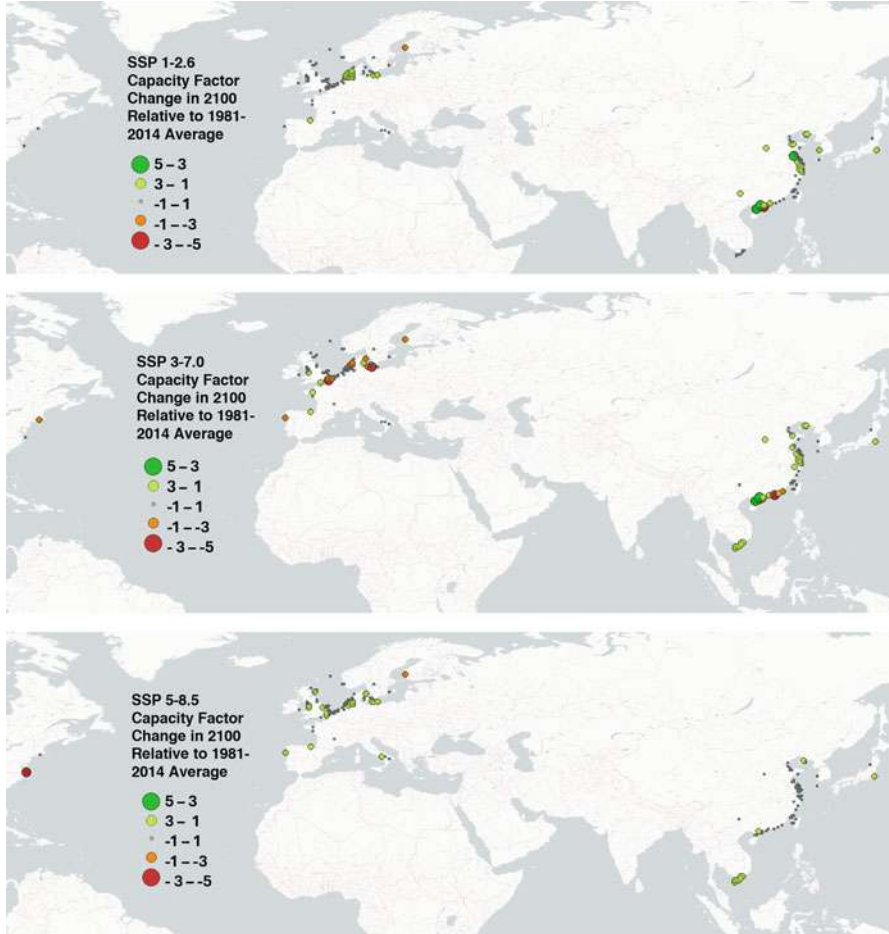

Fig. 7 Change in capacity factor for individual offshore wind turbines by the year 2100, relative to their 1981–2014 average under the SSP 1-2.6, 3-7.0, and 5-8.5 scenarios (Color figure online)

The minimal addition of new capacity offshore wind energy (Fig. 9) is attributed to the development of onshore wind and solar energy, given their status as the least-cost optimal solution, as delineated by TUSM. Unlike onshore wind energy, there is no difference in offshore wind generation by decarbonization scenario. However, there is a slight increase in the amount of offshore wind energy overtime.

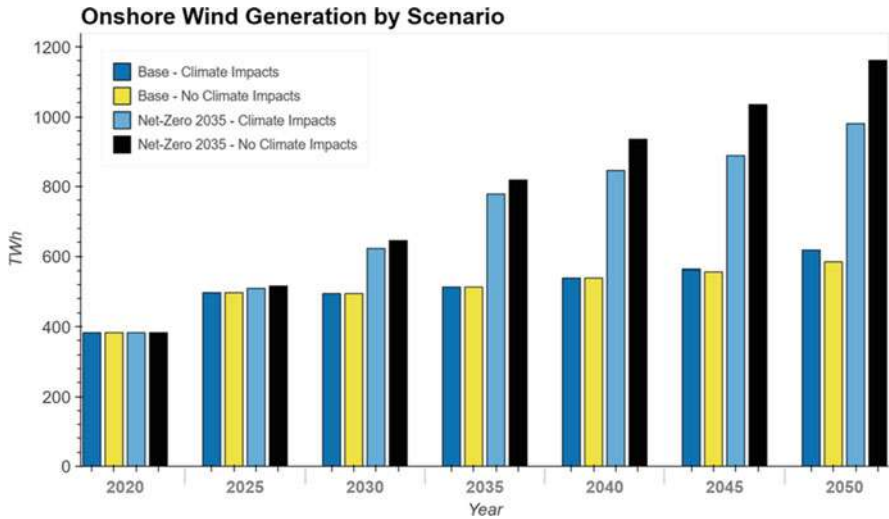

Fig. 8 Onshore wind generation (TWh) by decarbonization scenario in the United States 2020–2050

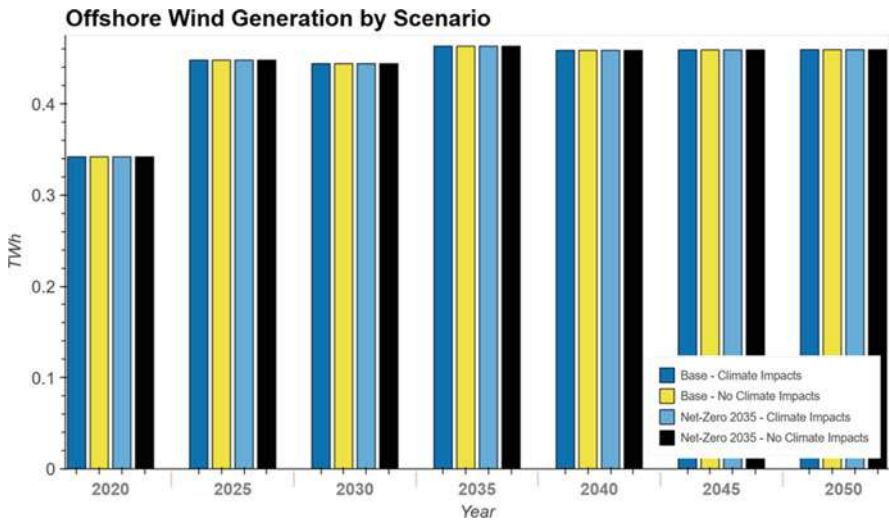

Fig. 9 Offshore wind generation (TWh) by decarbonization scenario in the United States 2020–2050

3.3 Decarbonizing New Capacity Installation

The capacity factor influences the new capacity installation of wind energy. In any given region, final energy demands fluctuate, particularly under net-zero scenarios where the energy mix is altered to favor renewable energy, based on the least cost optimal solution. Regions with higher capacity factors can meet energy demands more efficiently, necessitating fewer new capacity installations. Conversely, regions with lower capacity factors require more new capacity installations to fulfill the final energy demand. This underscores the role of capacity factors in shaping the deployment dynamics of wind energy infrastructure under various decarbonization scenarios.

NZE35 scenarios emerge as having the highest new capacity installation increases, whereas the BASE scenarios appear to lack any significant new capacity installation. Specifically, the NZE35—No Climate Impacts scenario exhibits the most substantial new capacity installation increases in the United States (Fig. 10). Consequently, TUSM depicts investment in wind energy to achieve net-zero goals by 2035, irrespective of climate impacts as the least cost optimal solution in this case. The installed capacity in the Base—Climate Impacts surpasses that of the Base—No Climate Impacts scenario, primarily attributed to variations in data inputs. The discrepancy arises from the fact that one set of inputs leads to a higher new installed capacity than the other. This divergence in trends is discernible due to the distinctive nature of the input sources. The NZE35 scenarios derive their inputs from SSP 1-2.6, while the Base scenarios are from SSP 3-7.0.

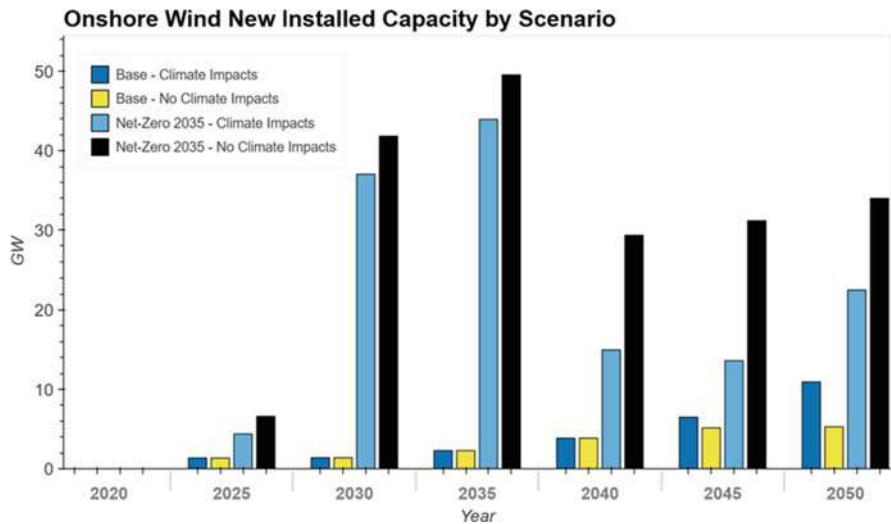

Fig. 10 Onshore wind new installed capacity (GW) by decarbonization scenario in the United States 2020–2050

4 Conclusion

An innovative data pipeline methodology was developed to examine wind speeds at the sites of all operational onshore and offshore wind farms globally, utilizing five distinct global climate models and three decarbonization scenarios, SSP 1-2.6, 3-7.0 and 5-8.5.

From the results of the global statistical analysis, over time, there were notable increases in capacity factors observed in various regions, including the United States offshore, offshore and onshore Finland, offshore Norway, Thailand, Vietnam, Martinique, Honduras, Costa Rica, Dominican Republic, and Bolivia. These regions experienced growth in their capacity factors, reflecting improved efficiency or expanded capabilities in renewable energy generation potential. Conversely, some areas may witness decreases in their capacity factors. These regions include Aruba, Cyprus, Bonaire, Sint Eustatius, and Saba, Curacao, Mongolia, Spain offshore, Vietnam offshore, Macao offshore, Japan offshore, Portugal offshore, Kosovo, Lithuania, Luxembourg, Ireland, Bulgaria, Belgium, Poland, Portugal, Romania, Russia, and Serbia. In developing countries, such as Thailand, Vietnam, Honduras, Costa Rica, Dominican Republic, and Bolivia, a substantial shift in capacity factor has a direct influence on the accessibility and reliability of wind energy in these countries. In turn, this has implications for the attainment of SDG 7 as these countries may experience new changes in wind generation.

Utilizing TUSM, it was found that net-zero scenarios have the highest capacity increases. Additionally, scenarios run with no climate impacts considered have a larger positive impact on generation of wind energy. Climate impacts from SSP1-2.6 on the NZE35 scenario have relatively positive impacts on future capacity factors, whereas the climate impacts from SSP3-7 on the base scenario have relatively negative impacts on future capacity factors. As such, there will be more wind generation and new installation capacity, specifically onshore wind, under net-zero scenarios and particularly those coupled without climate change impacts.

The results indicate that variations in wind capacity factors were mostly negligible among the examined scenarios. This implies that despite the potential influence of various social, economic, and climatic factors within the decarbonization scenarios, future wind energy potential (2015–2100), on average, is expected to remain relatively consistent with historical values (1981–2014). When comparing the different decarbonization scenarios, all three scenarios were found to be mostly similar and primarily followed suit of the changes in surface wind speeds. There is a pronounced impact of regional aggregation on capacity factor changes. While specific locations exhibit larger volatility, observing capacity factors at the national level reflects a more stable trend, emphasizing the importance of considering regional nuances in renewable energy planning and policymaking.

In terms of data limitations and potential shortcomings, it is noteworthy that the wind speed data utilized in this study was on a daily basis, thus lacking the granularity to capture hourly nuances in wind speed variations. This is a key consideration given the variable intermittent nature of wind energy over the course

of 24 hours. Although the available data was sufficient for this study within the context of integration into TUSM, future studies may consider analyzing the capacity factors in a global TIMES energy system optimization model. Assessing and interpreting the impact of capacity factors on a global scale would significantly enhance the findings. Expanding the geographical scope of generation and new installed capacity would lead to a better understanding of energy trade and mix in regions where decarbonization scenarios may impact wind capacity factors differently.

Conclusively, the world's path to decarbonization will determine the extent of changes in wind generation patterns, such as where wind will gain or lose speed and thereby generation potential. The present energy system is for several reasons not sustainable, with a need to transition to a more sustainable energy system. These changes have a direct impact on the fulfilment of SDG 7 and SDG 11 in particular. The findings overall suggest that wind energy is a robust and reliable source of renewable energy that can contribute significantly to achieving SDG 7 and 11. However, it's imperative to recognize that the projections indicating decreases pose a challenge, while those indicating increases present an advantage in the pursuit of achieving the SDG 7 target for affordable and clean energy. This can be achieved through strategic development of new wind farms in regions with projected high wind energy potential. The locations expected to increase their wind energy capacity factors compared to historical values are further poised to have an additional advantage in achieving SDG 11. The reduction in carbon emissions, improved air quality, and enhanced energy security that come with increased wind capacity factors holds the potential to transform environments into cleaner, more sustainable spaces. Furthermore, wind energy improves energy resilience, which is crucial for SDG 11's commitment to constructing sustainable and resilient communities. Alongside these environmental and energy-related benefits, wind energy development stimulates economic growth and job creation, promoting inclusive and economically prosperous urban communities, a key component of SDG 11.

Finally, the potential shifts in transmission demands as a result of new wind energy capacity installations will likely require governments to reevaluate their electricity grid transmission infrastructure. They may need to invest in upgrading or expanding transmission networks to ensure efficient energy distribution in areas with changing wind behavior. In particular, proactive transmission planning lowers offshore wind costs, accelerates deployment timelines and decreases environmental impacts. Essentially, informed planning and infrastructure development can help mitigate the impacts of climate induced changes in wind patterns. Additionally, the amount of wind energy being generated in some areas will be different depending on the decarbonization scenario, ultimately affecting a reliable energy supply. As a result, some policies that could be implemented as a result of this research include strategic development of new wind farm locations and electricity infrastructure in regions with projected high wind energy potential, incorporating energy storage solutions and/or diversifying the energy mix.

References

- Alsaleh A, Sattler M (2019) Comprehensive life cycle assessment of large wind turbines in the US. *Clean Techn Environ Policy* 21:887–903. <https://doi.org/10.1007/s10098-019-01678-0>
- Boucher O, Servonnat J, Albright AL et al (2020) Presentation and evaluation of the IPSL-CM6A-LR climate model. *J Adv Model Earth Syst* 12:e2019MS002010. <https://doi.org/10.1029/2019MS002010>
- Devis A, Van Lipzig NPM, Demuzere M (2018) Should future wind speed changes be taken into account in wind farm development? *Environ Res Lett* 13:064012. <https://doi.org/10.1088/1748-9326/aabff7>
- Dunne JP, Horowitz LW, Adcroft AJ et al (2020) The GFDL Earth System Model Version 4.1 (GFDL-ESM 4.1): overall coupled model description and simulation characteristics. *J Adv Model Earth Syst* 12:e2019MS002015. <https://doi.org/10.1029/2019MS002015>
- Espinoza-Morriberón D, Echevin V, Colas F et al (2017) Impacts of El Niño events on the Peruvian upwelling system productivity. *J Geophys Res Oceans* 122:5423–5444. <https://doi.org/10.1002/2016JC012439>
- Fournier A, Martínez A, Iglesias G (2023) Impacts of climate change on wind energy potential in Australasia and South-East Asia following the shared socioeconomic pathways. *Sci Total Environ* 882:163347. <https://doi.org/10.1016/j.scitotenv.2023.163347>
- Gastineau G, Soden BJ (2009) Model projected changes of extreme wind events in response to global warming. *Geophys Res Lett* 36:L10810. <https://doi.org/10.1029/2009GL037500>
- Global Energy Monitor (2023) Global Wind Power Tracker, May 2023 release. <https://globalenergymonitor.org/projects/global-wind-power-tracker/download-data/>
- Hoehn B, Diffendorfer JE, Rand J et al (2018) United States wind turbine database. <https://doi.org/10.5066/F7TX3DN0>
- Hueging H, Haas R, Born K et al (2013) Regional changes in wind energy potential over Europe using regional climate model ensemble projections. *J Appl Meteorol Climatol* 52:903–917. <https://doi.org/10.1175/JAMC-D-12-086.1>
- IEA (2023) Credible pathways to 1.5°C. IEA, Paris. <https://www.iea.org/reports/credible-pathways-to-150c>. Licence: CC BY 4.0
- IEA-ETSAP (2024) TIMES model generator. <https://doi.org/10.5281/ZENODO.10527819>
- Intergovernmental Panel on Climate Change (IPCC) (ed) (2023) Energy systems. In: *Climate change 2022—mitigation of climate change*. Cambridge University Press, Cambridge, pp 613–746. <https://doi.org/10.1017/9781009157926.008>
- Jung C, Schindler D (2022) Development of onshore wind turbine fleet counteracts climate change-induced reduction in global capacity factor. *Nat Energy* 7:608–619. <https://doi.org/10.1038/s41560-022-01056-z>
- Karnauskas KB, Lundquist JK, Zhang L (2018) Southward shift of the global wind energy resource under high carbon dioxide emissions. *Nat Geosci* 11:38–43. <https://doi.org/10.1038/s41561-017-0029-9>
- Lange S, Quesada-Chacón D, Büchner M (2023) Secondary ISIMIP3b bias-adjusted atmospheric climate input data. <https://doi.org/10.48364/ISIMIP.581124.2>
- Lee K, Kang K (2019) Determining the optimized hub height of wind turbine using the wind resource map of South Korea. *Energies* 12:2949. <https://doi.org/10.3390/en12152949>
- Lobeto H, Menendez M, Losada IJ (2021) Future behavior of wind wave extremes due to climate change. *Sci Rep* 11:7869. <https://doi.org/10.1038/s41598-021-86524-4>
- Mbengue C, Schneider T (2013) Storm track shifts under climate change: what can be learned from large-scale dry dynamics. *J Clim* 26:9923–9930. <https://doi.org/10.1175/JCLI-D-13-00404.1>
- Miao H, Xu H, Huang G et al (2023) Evaluation and future projections of wind energy resources over the Northern Hemisphere in CMIP5 and CMIP6 models. *Renew Energy* 211:809–821. <https://doi.org/10.1016/j.renene.2023.05.007>

- Müller WA, Jungclaus JH, Mauritsen T et al (2018) A higher-resolution version of the Max Planck Institute Earth System Model (MPI-ESM 1.2-HR). *J Adv Model Earth Syst* 10:1383–1413. <https://doi.org/10.1029/2017MS001217>
- National Weather Service (n.d.) Average annual temperature by year. <https://www.weather.gov/media/slc/ClimateBook/Annual%20Average%20Temperature%20By%20Year.pdf>
- Pryor SC, Barthelmie RJ, Bukovsky MS et al (2020) Climate change impacts on wind power generation. *Nat Rev Earth Environ* 1:627–643. <https://doi.org/10.1038/s43017-020-0101-7>
- Sellar AA, Jones CG, Mulcahy JP et al (2019) UKESM1: description and evaluation of the U.K. Earth System Model. *J Adv Model Earth Syst* 11:4513–4558. <https://doi.org/10.1029/2019MS001739>
- Soares PMM, Lima DCA, Semedo A et al (2019) Climate change impact on northwestern African offshore wind energy resources. *Environ Res Lett* 14:124065. <https://doi.org/10.1088/1748-9326/ab5731>
- Tang Y, Rumbold S, Ellis R, Kelley D, Mulcahy J, Sellar A, Walton J, Jones C (2019) MOHC UKESM1.0-LL model output prepared for CMIP6 CMIP historical. Version YYYYMMDD[1]. Earth System Grid Federation. <https://doi.org/10.22033/ESGF/CMIP6.6113>
- Tian Q, Huang G, Hu K, Niyogi D (2019) Observed and global climate model based changes in wind power potential over the Northern Hemisphere during 1979–2016. *Energy* 167:1224–1235. <https://doi.org/10.1016/j.energy.2018.11.027>
- Tobin I, Jerez S, Vautard R et al (2016) Climate change impacts on the power generation potential of a European mid-century wind farms scenario. *Environ Res Lett* 11:034013. <https://doi.org/10.1088/1748-9326/11/3/034013>
- Viviescas C, Lima L, Diuana FA et al (2019) Contribution of variable renewable energy to increase energy security in Latin America: complementarity and climate change impacts on wind and solar resources. *Renew Sust Energ Rev* 113:109232. <https://doi.org/10.1016/j.rser.2019.06.039>
- Yukimoto S, Kawai H, Koshiro T et al (2019) The Meteorological Research Institute Earth System Model version 2.0, MRI-ESM 2.0: description and basic evaluation of the physical component. *Meteorol J* 2(97):931–965. <https://doi.org/10.2151/jmsj.2019-051>
- Zeng Z, Ziegler AD, Searchinger T et al (2019) A reversal in global terrestrial stilling and its implications for wind energy production. *Nat Clim Chang* 9:979–985. <https://doi.org/10.1038/s41558-019-0622-6>

Open Access This chapter is licensed under the terms of the Creative Commons Attribution 4.0 International License (<http://creativecommons.org/licenses/by/4.0/>), which permits use, sharing, adaptation, distribution and reproduction in any medium or format, as long as you give appropriate credit to the original author(s) and the source, provide a link to the Creative Commons license and indicate if changes were made.

The images or other third party material in this chapter are included in the chapter's Creative Commons license, unless indicated otherwise in a credit line to the material. If material is not included in the chapter's Creative Commons license and your intended use is not permitted by statutory regulation or exceeds the permitted use, you will need to obtain permission directly from the copyright holder.



Clean and Affordable Norwegian Offshore Wind to Facilitate the Low-Carbon Transition



Kristina Haaskjold and Pernille Seljom

Abstract Norwegian offshore wind power can be a significant electricity supply contributor to facilitate the Norwegian and European green transition. The Norwegian government aim to grant concessions of 30 GW offshore wind within 2040, however, the realisation of this target depends on numerous uncertainties, related to e.g., future development in technology, national energy demand, the European power market, as well as social acceptance of energy production and grid expansion. This chapter analyses the role and cost-competitiveness of offshore wind to facilitate the low-carbon transition towards 2050. The energy system model, IFE-TIMES-Norway, is used to quantify the techno-economic capacity and distribution of offshore wind towards 2050, along with its impact on the overall energy system. Our results demonstrate that the ambitions of the Norwegian government can be economically viable without the necessity of subsidies, however, the outcome depends on the future development of the European power market. Moreover, the correlation of the Norwegian offshore wind resources is relatively weak between the northern and southern regions, as well as with Northern European countries. Less simultaneity enables an overall smoother production across Europe, which can enhance energy security. Further, results show that Norwegian offshore wind can play a central role in the decarbonization of end-use sectors by enabling greater hydrogen production from electrolysis.

Key Messages

- The Norwegian target of 30 GW offshore wind by 2040 is economically viable under certain market conditions.
- Norwegian offshore wind enhances the security of electricity supply in Norway and Europe (SDG 7).
- Offshore wind facilitates green hydrogen production and lower greenhouse gas emissions (SDG 13) and could contribute to new industry development (SDG 9).

K. Haaskjold (✉) · P. Seljom
Institute for Energy Technology (IFE), Kjeller, Norway
e-mail: kristina.haaskjold@ife.no; pernille.seljom@ife.no

- Energy system models capture how offshore wind enables emission cuts in end-use.

1 Introduction

Norwegian offshore wind power can support the achievement of both Norwegian and European climate targets by providing new green electricity supply, as well as contributing to the political ambition to transform the Norwegian petroleum-based economy to be a value-creating and cost-competitive low-emission economy (Energi 21 2022). Consequently, offshore wind in Norway can contribute to the United Nations (UN) Sustainability Goals on “Affordable and Clean Energy” (SDG 7), “Climate action” (SDG 13) and on “Industries, Innovation and Infrastructure” (SDG 9). The role of offshore wind power in the transition of the Norwegian energy system is however highly uncertain. It depends inter alia on the future development of technology, the onshore Norwegian energy demand, the European power market, and the impact of climate change on renewable production. Further, a national market for offshore wind power is considered a prerequisite for the Norwegian industry to succeed in the international market (Afewerki et al. 2019). This chapter analyses under what conditions Norwegian offshore wind power is cost-competitive and can contribute to reaching the sustainability goals.

1.1 Motivation

Norway has a climate policy goal of reaching a low emission society in 2050 (Miljødirektoratet 2023). The largest sources of greenhouse gas emissions are the transport sector at 34%, with 16.4 million CO₂-equivalent, followed by the oil and gas production at 25%, with 12.2 million CO₂-equivalent in 2022 (Environment Norway 2022). As opposed to many other countries, there are negligible emissions from Norwegian electricity generation, which is primarily based on hydro- and onshore wind power. Consequently, offshore wind power will not directly contribute to lowering the emissions in the electricity sector but can facilitate the electrification of end-use sectors and the establishment of new green industries. For example, offshore wind can contribute to lowering emissions from oil and gas production in Norway, by replacing offshore gas turbines with electricity from offshore wind (Voldsund et al. 2023).

This study uses the long-term energy system model IFE-TIMES-Norway (Haaskjold et al. 2023), to analyse the role of offshore wind power in the decarbonisation of the Norwegian energy system. The cost-competitiveness of offshore wind power in 20 identified areas (Norwegian Water Resources and Energy Directorate 2023b) is analysed, taking into consideration the future uncertainty of demand and technology development. The future Norwegian energy demand is

highly uncertain (Malka et al. 2023), where the electricity demand depends both on future activity and the degree of electrification in end-use sectors. However, the Norwegian Transmission System Operator (TSO), Statnett, expect a negative electricity balance from 2027 due to a projected increase in electricity consumption, without a corresponding increase in power production (Statnett 2022). One action that can reduce Norway's dependency on electricity imports is the ambition of the Norwegian government to grant concessions of 30 GW offshore wind by 2040 (Regjeringen 2022b). As a response, the Norwegian Water and Energy Directorate (NVE) (Norwegian Water Resources and Energy Directorate 2023b) identified 20 areas on the Norwegian continental shelf that have the potential to accommodate the 30 GW offshore wind power. However, as offshore wind power, particularly floating installations, is a technology that is under development, there are high uncertainties regarding the future costs and technology development (Shields et al. 2022).

The Norwegian government further stated that a significant share of the electricity from the 30 GW offshore wind power needs to be exported to other countries as it is too large for the Norwegian grid to accommodate (Regjeringen 2022a). At the same time, the Member States of the offshore grid corridor Northern Seas Offshore Grid (NSOG) have recently increased their targets for offshore renewable energy generation, with 60 GW by 2030 and up to 218 GW by 2050 (European Commission 2023). In this regard, it is important to understand the correlation between offshore wind power production in Norway and Northern Europe. A strong correlation makes it more profitable to use Norwegian offshore wind power to meet national electricity demand, store for future use, or produce other energy, such as hydrogen, rather than being exported or curtailed. On the other hand, a weaker correlation fosters higher offshore wind exports, reinforcing the energy security of northern European countries. Understanding the correlation between offshore wind areas within Norway is also important as it influences the need for other electricity generation and transmission to ensure the security of electricity supply.

The role of offshore wind power is also influenced by public acceptance, political preferences and legal and regulatory frameworks. (Linnerud et al. 2022), through a nationwide choice experiment with over 1612 individuals, examined how the general public's preferences for wind energy developments in Norway are affected by a shift from onshore to nearshore or offshore locations. The study concludes that respondents prefer offshore and nearshore locations to onshore ones. The social acceptance of new domestic transmission can also affect the offshore wind expansion, as transmission capacity expansion can be needed to match the offshore wind resources with Norwegian demand in various locations. According to a survey presented in (Aas et al. 2014), local acceptance of high voltage power lines in Norway was below the mid-point average. To proactively address the risk of public opposition of offshore wind, akin to the challenges faced by onshore wind (Korsnes et al. 2023), NVE has recently proposed several amendments to the administrative process for offshore wind, in particular to the Offshore Energy Act (Andersson et al. 2023). The amendments relate to the knowledge base and clarifications needed for the opening and allocation of areas for energy production at sea, the distribution of

responsibility and tasks, and the content and structure of the concession process of energy production with associated grid infrastructure. The main goal of the proposal is to ensure (1) sufficient decision-making foundation, (2) efficient management processes that actively involve and consider public interest, and (3) increased predictability for project owners, which all aim to avert significant impediments to project progression. NVE also highlights the importance of harmonizing grid connection process with the licencing process for offshore wind.

1.2 Energy Modelling Literature

Numerous recent analyses have used power market models to address the cost-efficient integration of offshore wind power from a North Sea and Northern European perspective. For example, (Durakovic et al. 2023) use EMPIRE (Backe et al. 2022), a capacity expansion model of the European power market, to analyse how large-scale deployment of green hydrogen production affects the investments in transmission and generation in the North Sea area towards 2060. The analysis includes investment options in two of the 20 identified regions for offshore wind in Norway (Norwegian Water Resources and Energy Directorate 2023b). The chapter concludes that a high demand for green hydrogen will increase investments in offshore wind power, and that the North Sea will have a significant share of the total European electrolyser capacity, due to the favourable wind conditions. The authors suggest that further work should look more closely at national and regional analysis, to better incorporate national energy policies and strategies.

Another example is (Jåstad and Bolkesjø 2023) that uses the BALMOREL model (Wiese et al. 2018) to analyse the market value and economic potential of offshore wind developments for various grid connection strategies using the Norwegian continental shelf as a case. The analysis covers the Northern European power and heat market and includes offshore regions that are connected to four of the five spot price regions in Norway. By using Monte Carlo simulations, covering uncertainty in economic and political developments, 0–8.1 GW installed capacity can be economically attractive in Norway without any subsidy, when assuming a radial connection. Another result is that the market value is highest for offshore wind power when a plant has a hybrid grid connection to several markets compared to a radial connection to only one market. (Koivisto et al. 2020) also used the BALMOREL model to analyse the development of the electricity sector towards 2050 for the North Sea region with a focus on offshore wind power. Similarly to (Durakovic et al. 2023), the authors conclude that an increased electricity consumption, through sector coupling, is a more important driver for increasing offshore wind power installations.

(Reulein et al. 2023) uses the European energy system model, GENeSYS-MOD (Löffler et al. 2017), to address the influence of the introduction of 30 GW offshore wind in one of the 20 identified Norwegian offshore wind areas. The chapter concludes that the introduction of offshore wind capacity results in less capacity expansion of onshore wind and solar power. Note that in (Reulein et al. 2023),

30 GW offshore wind is a model assumption, whereas in our chapter we endogenize investments in offshore wind power and analyse under what conditions investments in Norwegian offshore wind is a techno-economic solution.

Compared to the described literature above, our analysis has a Norwegian perspective, providing a high detail level of the Norwegian energy system that includes interactions within the framework of sector coupling. In addition, we have identified three novelty contributions of our study.

- First, according to our knowledge, this is the first study that examines all the 20 identified offshore wind areas on the Norwegian continental shelf to analyse the cost-competitiveness of offshore wind. Thus, in contrast to the literature described above, we include a more detailed spatial representation of e.g., wind conditions, grid connections and onshore energy system integration. Moreover, this chapter quantifies the correlation of offshore wind resources between the 20 Norwegian regions and other Northern European countries.
- Second, we analyse the effect of offshore wind on Norwegian end-use sectors and emissions. By using a holistic energy system model that endogenies sector coupling and electricity demand, we quantify how offshore wind can contribute to electrifying and lowering emissions in end-use sectors. Although (Reulein et al. 2023) also used an energy system model, the results presented only focused on the electricity sector.
- Third, we analyse under what conditions Norwegian offshore wind power is cost-competitive, considering relevant uncertain parameters. In addition to the uncertainty on acceptance of onshore wind power technology development that is also included in (Jåstad and Bolkesjø 2023), we also include uncertainty on technology development of offshore wind, expansion of new transmission capacity and national demand under various development pathways of the European electricity market.

1.3 Research Questions

The overall objective of the chapter is to analyse the role of offshore wind power in the transition of the Norwegian energy system. In the conducted analysis, we address the following research questions:

- How is wind production from the 20 identified Norwegian offshore areas correlated, and how does this production align with offshore wind in the Northern European region?
- How does the cost-optimal investments in Norwegian offshore wind power depend on the development of future national demand, technology learning and subsidies, and on the European power market?
- How does Norwegian offshore wind power contribute to the Sustainable Development Goals (SDGs) on energy and climate, economy, and industry?

The outline of this chapter is as follows: Section 2 is devoted to the applied methodology, including a description of the TIMES model and model assumptions. Section 3 presents the corresponding results, whereas the conclusions are given in Sect. 4.

2 Methodology

First, this section presents the model structure and assumptions of the IFE-TIMES-Norway energy system model, including a detailed description of modelling of offshore wind. Second, we describe the analysed case studies and sensitivities and how they are quantified.

2.1 Energy System Model

The TIMES modelling framework is developed within ETSAP (the Energy Technology Systems Analysis Program), an implementing agreement of the International Energy Agency (IEA) during several decades (IEA-ETSAP 2023). TIMES is a bottom-up framework that provides a detailed techno-economic description of resources, energy carriers, conversion technologies and energy demand. TIMES models minimise the total discounted cost of the energy system to meet the demand for energy services for the analysed model horizon.

IFE-TIMES-Norway (Haaskjold et al. 2023) is a technology-rich model of the Norwegian energy system and is split into five regions corresponding to the current electricity spot price regions, NO1 to NO5. The model provides operational and investment decisions from the starting year, 2018, towards 2050, with model periods for every fifth year from 2020 to 2050. To capture operational variations in energy generation and end use, each model period is divided into 96 sub-annual time slices, where four seasons (winter, spring, summer, and fall) are represented by one day of 24 hours in each season. The model has a detailed description of end-use of energy, and the demand for energy services is represented by numerous end-use categories within industry, buildings, and transport. Each energy service demand category can be met by existing and new technologies using different energy carriers such as electricity, biofuel, hydrogen, and fossil fuels. Other input data include fuel prices, electricity prices in countries with interconnections to Norway, renewable resources, and technology characteristics such as costs, efficiencies, and availabilities.

Existing transmission capacity, both domestically and to European countries, is modelled exogenously and based on current capacity and ongoing capacity expansion. Moreover, the model allows for new investment capacity, both on existing and new connections. First year of investment is fixed to 2030 due to the long planning and construction process of building new transmission lines. The Norwegian electricity prices in the five spot regions are endogenous, as they are the dual values of

the electricity balance equation. The electricity prices in countries with interconnections to Norway, including Denmark, Sweden, United Kingdom, Finland, Netherlands, and Germany, are a model input. Furthermore, these electricity trade prices are assumed to be independent of the traded quantities with Norway.

2.2 *Modelling of Offshore Wind*

The offshore wind modelling is based on the 20 identified offshore wind areas of NVE, that is illustrated in Fig. 1. The colour coding reflects the variations in wind conditions, in which green colour indicates the highest capacity factors (52–56%) and red indicates the lowest (46–47%). The power production potential for each area is provided by NVE as an hourly capacity factor for the period from 1951 to 2022 (Norwegian Water Resources and Energy Directorate 2023a). To adjust to the sub-annual temporal resolution of the model, we generate one normalized production profile for each offshore wind region consistent of four representative days (one for each season). The four days are chosen based on random selection of a subset of days, falling within a 50% span in standard deviation from the daily mean across all days within the period (1951 to 2022). The same days are used for all offshore wind regions to ensure consistency in production. The resulting profiles are shown in Fig. 4. These profiles are further scaled to hourly capacity factors by adopting the average capacity factor provided by NVE (Norwegian Water Resources and Energy Directorate 2023a), given in Table 1. Maximum expansion potential for each offshore wind area is assumed to be 2 GW by 2050 (40 GW in total). By 2030, 3 GW capacity is available for investments, corresponding to the two opened areas (Utsira Nord, located in Vestavind F, and Sørilige Nordsjø II, located in Sørvest F).

We assume that the areas that are located closest to Europe in the Southern North Sea, Sørvest A-E and Sønnavind A, can export electricity to Europe. For these connections, export to the United Kingdom (UK), Western Denmark, Germany and the Netherlands are included. These connections are hybrid, meaning that the cables can be used also for electricity trade between countries whenever offshore wind production does not exceed the cable capacity. Noteworthy, the invested capacity to European countries are limited by the invested capacity to Norway, meaning that radial connections to Norway need to be realized before investments in cables to Europe are made. This is reasoned by the Norwegian government's decision to only grant radial connections in the first development phase (Regjeringen 2022c). For the remaining offshore areas, the model can only invest in a unilateral connection to the adjacent spot region in Norway, as presented in Table 1. The investment costs for export cables are calculated based on the estimated kilometer distance to the various connection points.

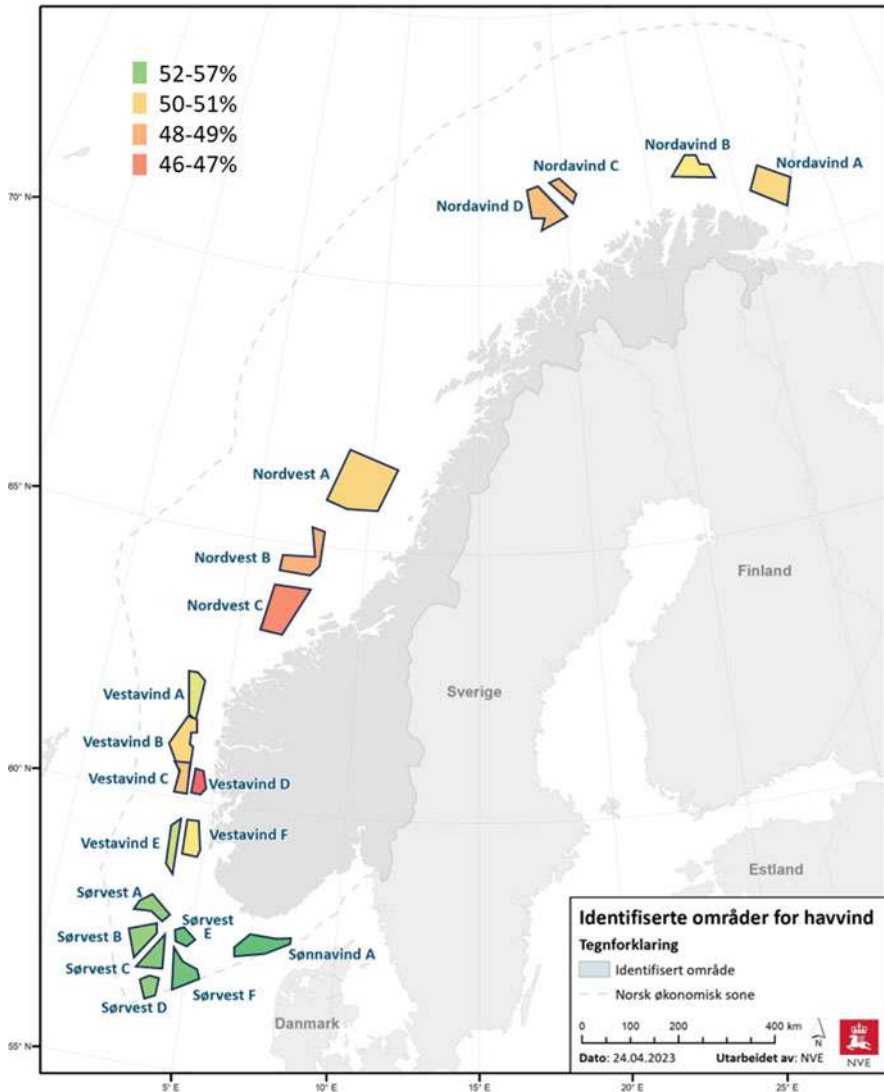

Fig. 1 Map of the 20 identified new areas for offshore wind development in Norway (Norwegian Water Resources and Energy Directorate 2023d). *Note:* Added color-coding to represent average wind conditions (Color figure online)

2.3 Case Studies and Sensitivity Analysis

To develop a robust analysis, different case studies and sensitivities have been examined to identify the parameters that have the largest influence on the investment

in offshore wind power in Norway. All case studies assume a low-carbon society by 2050, with CO₂ price assumptions of 200 €/tCO₂ in 2030 and 438 €/tCO₂ in 2050, assuming a currency rate of 10 NOK/€. Three main parameters are chosen for the case studies:

- Investment cost of offshore wind:** For this study, a high (denoted “High”) and a low (denoted “Low”) cost case is used based on data provided by NVE (Norwegian Water Resources and Energy Directorate 2023c). The data differ depending on the foundation type and whether the connection to shore is alternating current (AC) or direct current (DC). Information for each area can be found in Table 1, with costs summarized in Table 2. Technology learning towards 2050 is assumed to be 15% (International Renewable Energy Agency (IRENA) 2019). In the

Table 1 Capacity factor, type of foundation and grid connection point for each offshore wind area (Norwegian Water Resources and Energy Directorate 2023b)

Offshore Area	Capacity factor (%)	Foundation	Grid connection point
Nordavind A	49.6	Floating	NO4
Nordavind B	50.2	Floating	NO4
Nordavind C	48.8	Floating	NO4
Nordavind D	48.8	Floating	NO4
Nordvest A	49.5	Floating	NO4
Nordvest B	48.3	Floating	NO3
Nordvest C	47.0	Floating	NO3
Vestavind A	51.3	Floating	NO3
Vestavind B	49.6	Floating	NO3
Vestavind C	48.9	Floating	NO5
Vestavind D	45.8	Floating	NO5
Vestavind E	52.3	Floating	NO2
Vestavind F	50.1	Floating	NO2
Sørvest A	54.5	Bottom-fixed	NO2, DK1, DE, NL, UK
Sørvest B	54.3	Bottom-fixed	NO2, DK1, DE, NL, UK
Sørvest C	55.1	Bottom-fixed	NO2, DK1, DE, NL, UK
Sørvest D	54.5	Bottom-fixed	NO2, DK1, DE, NL, UK
Sørvest E	56.1	Bottom-fixed	NO2, DK1, DE, NL, UK
Sørvest F	55.9	Bottom-fixed	NO2, DK1, DE, NL, UK
Sønnavind A	56.5	Floating	NO2, DK1, DE, NL, UK

Table 2 High and low investment cost projections used for the case studies (€/GW) (Norwegian Water Resources and Energy Directorate 2023c)

Type + connection	Low price projection		High price projection	
	2030	2050	2030	2050
Floating DC	3037	2581	4181	3554
Floating AC	3034	2579	4178	3551
Bottom-fixed DC	2140	1819	2756	2343

following, high technology learning refers to low investment costs, while low technology learning refers to high investment costs.

2. **Energy demand for industry and transport:** Two projections for future development in industry and transport demand is assumed based on (Aamodt Espegren et al. 2023). The high projection assumes an increase in industry demand of 69%, road transport demand of 37% and other transport demand of 14%. The low projection assumes a 1% increase in industry demand, while individual transport demand decreases by 10%.
3. **Electricity price in Europe:** Four price sets for European countries have been applied: (1) Reference prices based on linking with the European power market model EMPIRE (Haaskjold and Pedrero 2023), (2) high price set, with average price and volatility adjusted by 2, (3) low price set with average price and volatility adjusted by 0.8, (4) halved price set with average price and volatility adjusted by 0.5. The change in variability is computed by applying a square power transformation at each hour, resulting in lower lows and higher peak values.¹ The price profiles for a winter and a summer day in Sweden in 2050 for each price set are illustrated in Figs. 2 and 3.

The combination of parameters used in the case studies are presented in Table 3. In total, 10 cases have been analysed.

If not specified, investments in new land-based wind power and transmission capacity are a modelling option. To account for uncertainties related to social acceptance of such large infrastructure, a sensitivity analysis is also performed for each case combination in which no new land-based wind or domestic transmission cables can be built.

Fig. 2 Four price projections for electricity price development on a winter day in Sweden in 2050

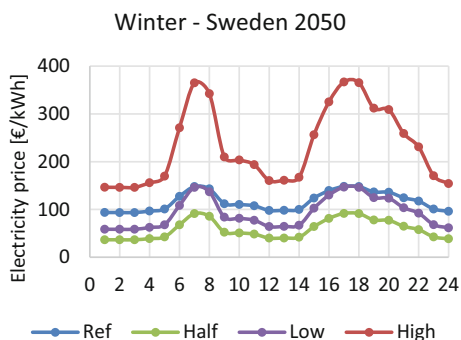

¹The squared values for each hour were normalized by the mean value of the transformed time series. These normalized profiles were then scaled by multiplying the mean value of the original price profile and a scaling factor corresponding to the desired increase/decrease in average electricity prices.

Fig. 3 Four price projections for electricity price development on a summer day in Sweden in 2050

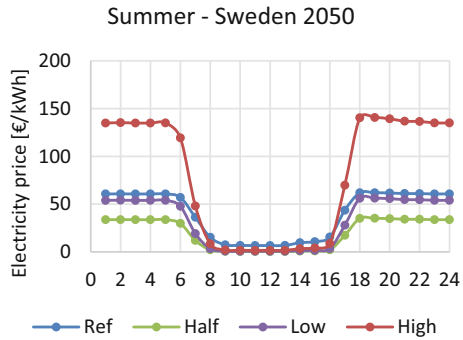

Table 3 Combination of parameters for the case analysis

Name	Investment cost	Energy demand	Electricity price Europe
HH-Ref	High	High	Ref
LH-Ref	Low	High	Ref
HH-High	High	High	High
LH-High	Low	High	High
HH-Low	High	High	Low
LH-Low	Low	High	Low
HH-Half	High	High	Half
LH-Half	Low	High	Half
HL-Low	High	Low	Low
HL-High	High	Low	High

3 Results

First, this section presents the results of the Norwegian offshore wind resources used as input to the model, along with the correlation between offshore wind resources in Norway and neighbouring European countries. Second, the main results from the sensitivity analysis will be presented with focus on offshore wind investments and its impact on the Norwegian energy system.

3.1 Norwegian Offshore Wind Resources

As illustrated in Fig. 1, the average annual capacity factors for Norwegian offshore wind areas range between 46% and 57%. The areas located furthest south in Norway have the greatest wind conditions, with average annual capacity factors of 54–57%. Besides Sønnavind A, the areas in the south are also the ones mainly suitable for bottom-fixed foundation, entailing a significantly lower cost of investment. In addition to differences in annual production potential, the wind conditions across regions can also vary largely within a day and within seasons, as shown in Fig. 4.

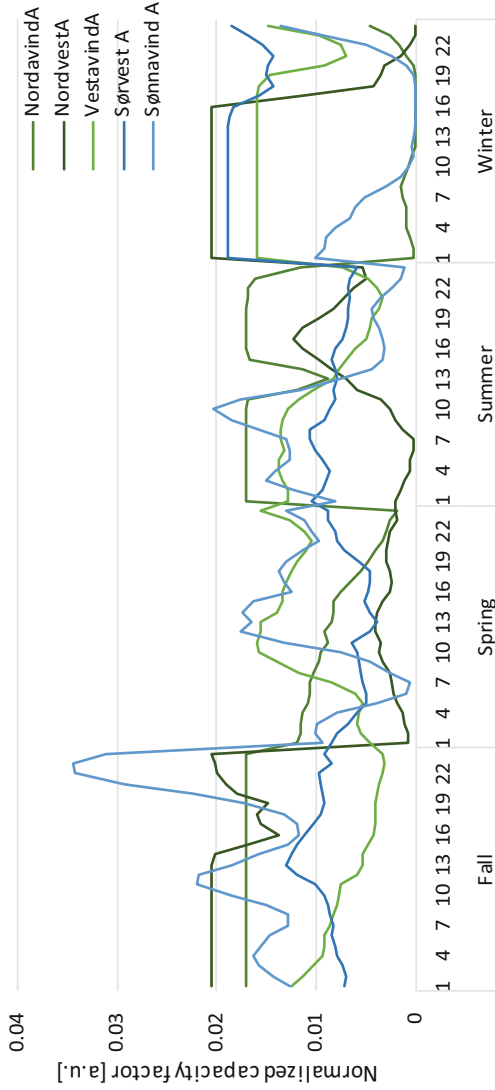

Fig. 4 Normalized capacity factors for five of the offshore wind areas, representing the hourly differences along the Norwegian coastline

While “Sørvest A”, “Vestvind A” and “Nordvest A” obtain maximum capacity factors during the winter, “Nordavind A” and “Sønnavind A” have almost no production in this period. This indicates that there is a smoothing effect among the areas that provide a more stable overall production.

Figure 5 illustrates the correlation between offshore wind areas in Norway and Northern Europe based on hourly resolution of wind data from 1951 to 2022. The results demonstrate that there is a low correlation in wind speeds between the various offshore areas in Norway. The correlation is below 0.5 for all instances, and in 7 out of 10 cases, the correlation is below 0.2. The highest correlation can be found between Sørvest A and Sønnavind A (0.5), which are located closer compared to the other areas.

Moreover, Fig. 5 also shows a weak correlation in offshore wind conditions between Norway and Europe. This applies especially for those located on the western and Northern part of Norway, in which correlation is below 0.25 for all instances. For Sørvest A and Sønnavind A, the correlation is slightly stronger, but still significantly lower compared to the correlation between the European countries. For example, correlation between Sønnavind A and Germany is 0.45, while that between Denmark and Germany is 0.81.

In further results, the offshore wind areas will be grouped according to their location, referred to as Nordavind (incl. A-D), Nordvest (incl. A-C), Vestvind (incl. A-F), Sørvest (incl. A-E) and Sønnavind (incl. A).

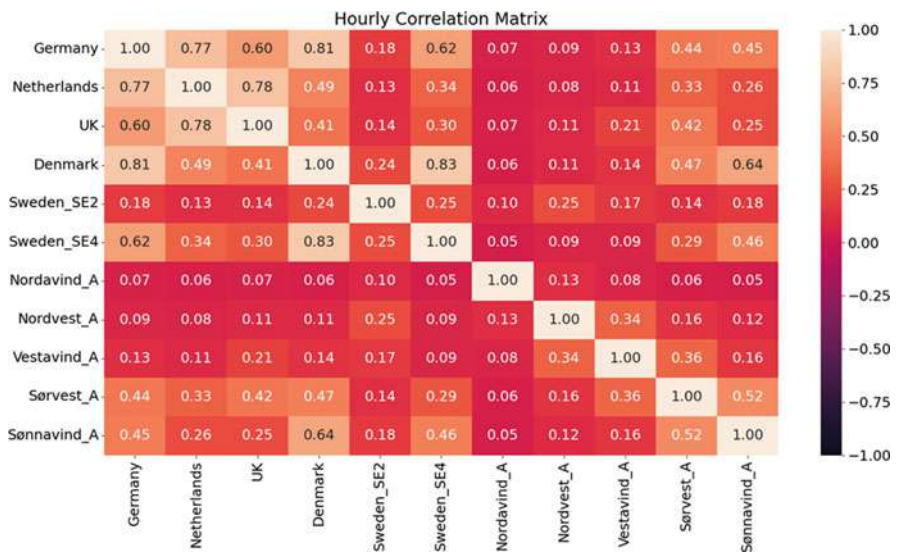

Fig. 5 Statistical correlation matrix with hourly time resolution for offshore wind areas in Norway and Northern European countries

3.2 Offshore Wind Investments

The results demonstrate that investments in offshore wind is highly dependent on the development of European electricity prices. Figure 6 shows the invested capacity for each offshore wind area for each of the ten case studies. With high electricity prices, the offshore wind capacity in 2040 ranges from 23 to 33 GW, whereas for the low price cases the capacity ranges from 12 to 28 GW. The case with highest capacity at 33 GW, has a production of 168 TWh, and occurs when the investment cost of offshore wind is low, and the national electricity demand is high.

The results indicate that the future technology learning and investment cost of offshore wind has a great impact on the invested capacity in 2040. Further, the impact of investment costs is more significant in the cases featuring lower electricity price levels in Europe. As shown in Fig. 6, compared to the low technology learning cases (HH-Ref and HH-Low), a higher technology learning gives additional 18 GW capacity in the reference price case (LH-Ref) and 16 GW capacity in the low price case (LH-Low). The significance of technology learning is further highlighted by the case with high investment costs and very low prices in Europe (HH-Half), in which no investments are made in offshore wind power.

Among the Norwegian offshore areas, the ones located in southern and western Norway are the most cost-competitive for offshore wind. These areas have the best wind conditions and are also located close to onshore regions with high demand and connections to the European power market. In the cases with low energy demand, investments are mainly concentrated in these areas, whereas investments are more

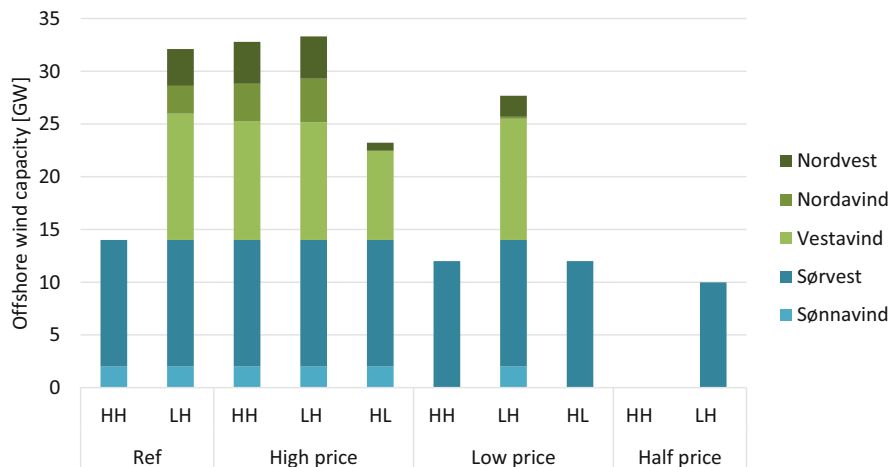

Fig. 6 Investments in offshore wind across all sensitivity cases and regions by 2040 (GW). *Notes:* *HH* High investment cost and High demand, *LH* Low investment cost and High demand, *HL* High investment cost and Low demand

widely distributed across areas in cases with high energy demand. Consequently, the future electricity demand in Norway influences the offshore wind deployment.

3.3 Electricity Production and Use

Among the electricity generation technologies, offshore wind investments have the largest impact on investments in building applied PV (BAPV) and hydropower. This is illustrated in Fig. 7 that shows electricity generation by technology from new investments by 2050, comparing cases with high and low investment cost of offshore wind across different European price levels. Note that utility PV is not included as an investment option. The impact on hydropower is largest in high price cases (LH-High), with an 8% reduction in production compared to the high investment cost case (HH-High). Moreover, the flexible hydropower shifts production from winter to summer months to accommodate offshore wind production. The impact on PV investments is reduced the most in the low-price case (LH-Low), with a 40% reduction compared to the high investment cost case (HH-Low). This can be explained by the correlation between PV production and periods of low electricity prices in Europe. With zero prices during mid-day hours (as illustrated in Fig. 3), the market value of offshore wind becomes relatively higher compared to that of PV. Finally, since onshore wind is a highly cost-optimal solution in Norway, the production is identical for all cases, and is thus independent of the offshore wind investments.

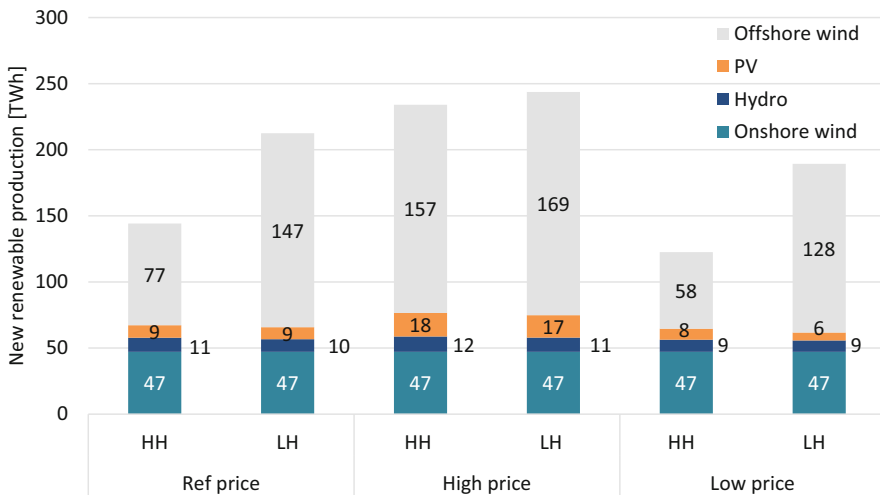

Fig. 7 New renewable production by energy source for 2050. Notes: HH High investment cost and High demand, LH Low investment cost and High demand

The electricity generation mix influences the long-term marginal cost of electricity in Norway. The results indicate that higher technology learning for offshore wind power, which lowers the investment costs and increases offshore wind investments, lowers the average electricity price in Norway. The cases with low investment costs have 5–8% lower average Norwegian electricity prices in 2050 compared to the cases with higher investment costs. Further, the impact on electricity prices varies between the Norwegian spot price regions. With low European prices, the price impact is highest in the spot price regions of Oslo and Bergen, NO1 and NO5, decreasing with 6–8%, whereas with high European prices, the electricity price is reduced most in the spot price regions of Trondheim and Tromsø, NO3 and NO4, with a 28% reduction.

For end-use, offshore wind primarily affects the use of electricity for hydrogen production. Figure 8 illustrates the electricity use per sector in 2050, comparing cases with high and low investment cost of offshore wind. The impact is largest in high price cases, where lower investment cost of offshore wind (LH-High) results in a 40% increase in hydrogen production compared to the high investment cost case (HH-High). With low electricity prices, the total electricity use is the same independent on investment cost of offshore wind. For the other sectors- building, district heat, industry and transport- offshore wind investments have negligible impact on electricity use.

The increased hydrogen production, resulting from offshore wind power, decreases the Norwegian CO₂ emissions. Lower investment costs of offshore wind result in a 3% decrease in emissions compared to higher investment costs in the high price case. In the latter, the hydrogen production from electrolysis is mainly substituted by blue hydrogen (92%), however the overall production level is still reduced. The reduction can be found in mainly sea transport. Higher investment

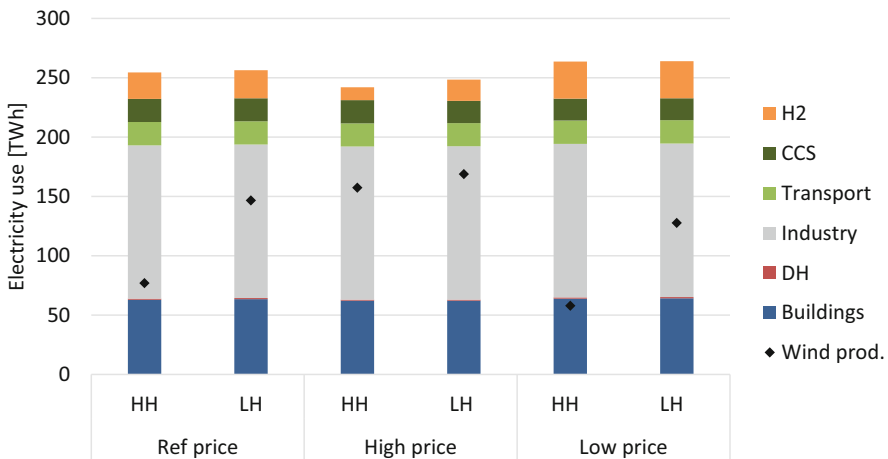

Fig. 8 Electricity use per sector for 2050. Notes: HH High investment cost and High demand, LH Low investment cost and High demand

costs result in a 7% reduction in use of hydrogen and ammonia, which is substituted by Marine gas oil (MGO).

3.4 Electricity Trade

Large scale deployment of offshore wind increases the net electricity export from Norway, as illustrated in Fig. 9. However, the net electricity trade is highly dependent on both the electricity price development in Europe and the costs associated with offshore wind investments. For both cases featuring high electricity prices, Norway is a net exporter in 2050, with a 10% increase in electricity exports under the conditions of low offshore wind investment costs (LH-High). The impact is substantially greater under low European price levels, where higher technology learning of offshore wind results in a shift from net import volumes of 14 TWh (HH-Low) to net export volumes of 48 TWh (LH-Low). In this case, Norway becomes a net exporter also from an onshore perspective, thereby increasing national security of electricity supply. The volumes directly exported from offshore regions to Europe ranges from 30 TWh (HH-Low) to 56 TWh (LH-High). Consequently, the total net export volumes from onshore and offshore Norway can potentially reach 104 TWh (LH-High). Noteworthy, this study assumes political support for hybrid connections for all offshore wind areas in the southern North Sea, hence allowing electricity to be transmitted between European countries in hours of lower offshore wind production. As emphasized by (Jåstad and Bolkesjø 2023), this assumption increases the profitability of offshore wind investments.

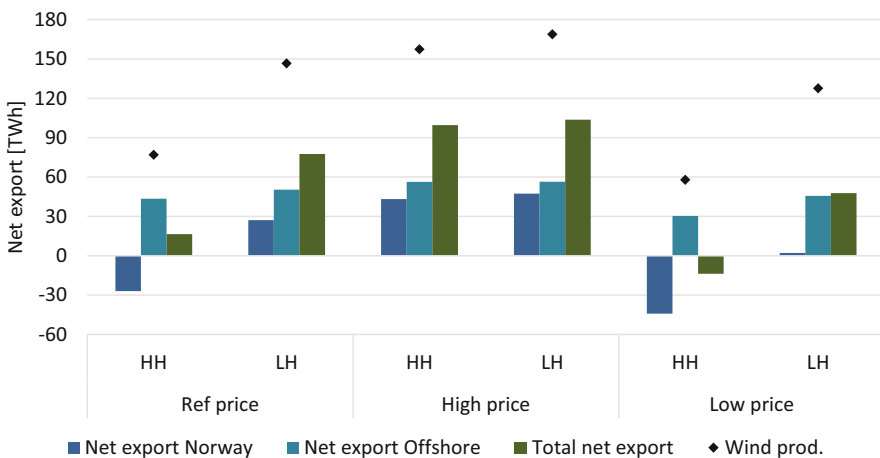

Fig. 9 Net export of electricity from onshore and offshore Norway in 2050. Notes: *HH* High investment cost and High demand, *LH* Low investment cost and High demand

3.5 Sensitivity on Acceptance for Onshore Wind and Transmission Cables

The results demonstrate that acceptance of new domestic transmission cables and onshore wind affects the investments in offshore wind capacity, but mainly in the northern offshore regions. Figure 10 shows the difference in invested capacity when no new investments in transmission cables (HH-T and LH-T) and onshore wind (HH-O and LH-O) are allowed, compared to the cases with no limitations (HH and LH). The impact of limiting expansion of domestic transmission cables is negligible, with reductions of 130–640 MW. On the other hand, limiting onshore wind investments has a greater impact, with 2.6–5.3 GW increased capacity in offshore wind in all cases except HH-O-Low. In this case, the high investment cost and low European prices makes additional offshore wind investments unprofitable, and Norway relies on imports instead. In cases where offshore wind investments increase, it does not completely offset the initial investments in onshore wind, falling short of about 5–8 GW. In the high price cases (HH-O-High and LH-O-High), the maximum expansion potential assumed for offshore wind is reached at 40 GW. In low price cases (HH-O-Low and LH-O-Low), there is still additional investment potential to be utilized. The total decrease in energy production due to limitations on onshore wind range from 7 TWh (LH-O-Low) to 32 TWh (HH-O-Low). Consequently, Norway becomes increasingly more reliant on Europe in such a restrictive situation.

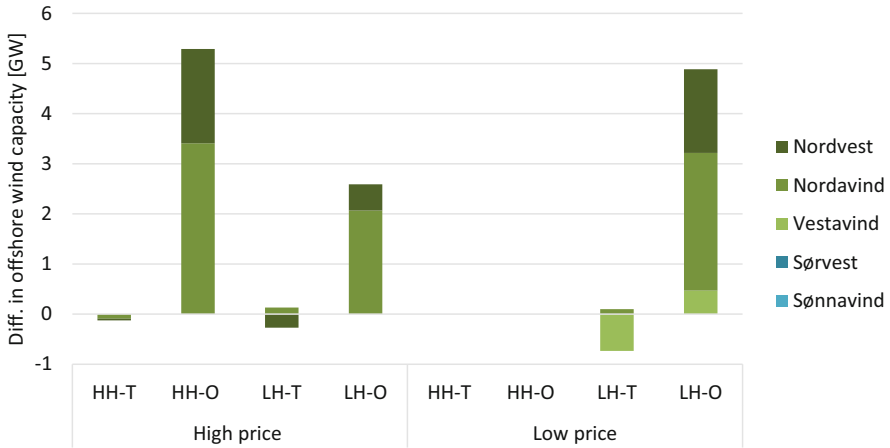

Fig. 10 Difference in offshore wind capacity when limiting investments in new transmission cables (T) and onshore wind deployment (O), compared to HH and LH case. *Notes:* HH High investment costs, High demand, LH Low investment costs, High demand, T No new domestic Transmission, O No new Onshore wind

4 Conclusion

This study analyses the role of offshore wind power in the decarbonisation of the energy system towards 2050. First, we have quantified the correlation of electricity production between the 20 identified Norwegian offshore wind areas and areas in Northern Europe. Second, we have used a long-term energy system model to analyse techno-economic investments in Norwegian offshore wind given different uncertain parameters, including European electricity prices, technology learning rates and national energy demand. Third, we have analysed how offshore wind power production influences the Norwegian energy system, including the impact on investments in other electricity generation technologies, the electricity use and emissions and the electricity trade. Finally, we have investigated how acceptance for expansion of domestic transmission cables and onshore wind power in Norway influences the techno-economic investments in offshore wind power.

To summarise the results, we answer the research questions of our chapter below.

Research question 1 How is wind production from the 20 identified Norwegian offshore areas correlated, and how does this production align with offshore wind in the Northern European region?

The annual average wind capacity factors for the 20 areas range from 46% to 57%, with the most favourable wind conditions in areas located furthest south in Norway. On an hourly basis, the wind production varies largely across the coast, with a weak correlation below 0.2 between the north and the south. Additionally, offshore wind in Norway is weakly correlated with offshore wind production in Northern Europe. Consequently, a large share of offshore wind power distributed along the Norwegian coast and across Northern Europe can reduce the risk of energy shortages through a smoothing effect, thereby enhancing resilience while promoting a low-carbon development of the energy system.

Research question 2 How does the cost-optimal investments in Norwegian offshore wind power depend on the development of future national demand, technology learning and subsidies, and on the European power market?

The future technology learning in offshore wind technology and the price development of the European power market has a large impact on cost-optimal investments in offshore wind in Norway. The results show that in a future European market characterized by medium to high electricity prices, the ambitions of the Norwegian government of 30 GW capacity by 2040 become economically viable without the necessity of subsidies. With lower European prices, techno-economic investments are lowered to 0–12 GW unless subsidies or sufficient technology improvements are realized. The largest investments are made in the southern and western parts of Norway, where energy demand is the largest and the distance to Europe is closest. Moreover, lower national energy demand generally decreases investments in offshore wind with a higher concentration of capacity in the south. Limitations on onshore wind expansion have the opposite effect, increasing offshore

investments in most cases. Finally, expansion of domestic transmission capacity has a negligible impact on investments in offshore wind.

Research question 3 How does Norwegian offshore wind power contribute to the Sustainable development goals (SDGs) on energy and climate, economy, and industry?

Norwegian offshore wind can contribute to reducing both Norwegian and European climate emissions (SDG 13) by providing green electricity (SDG 7). This study shows that offshore wind investments increase Norwegian green hydrogen production from electrolysis, enabling emission reductions in Norway due to the substitution of blue hydrogen and MGO. Moreover, results indicate that the flexible Norwegian hydropower is a facilitator for increased offshore investments, providing an advantage that many other European energy systems are lacking. Offshore wind can also be beneficial in ensuring a diverse energy mix, in which the complementarity between offshore wind and PV enables mitigation of the cannibalization effect of PV occurring during mid-day hours. As shown by the results, offshore wind can lower the average electricity price in Norway by 6–8%, and even more on a regional basis, and hence contribute to affordable electricity for both individuals and businesses.

Norwegian offshore wind can further facilitate the green transition in Europe (SDGs 7&13), however, the supply of electricity depends largely on European electricity prices and technology development. Low investment costs play an important role in altering net-import situations that could occur in futures characterized by low electricity prices. In general, results show that offshore wind can help to ensure the security of electricity supply in Norway while simultaneously providing electricity to Europe in hours of high production. Noteworthy, this study is limited to the optimization of the Norwegian energy system, and we are therefore not able to quantify the impact on emission reductions as a result of Norwegian offshore wind export to Europe. Nevertheless, the analysis finds a weak correlation to Europe, indicating that offshore wind power from Norway could reduce dependency on fossil fuels when wind conditions are limited in Northern Europe. Further work will aim to quantify the impact and support of European climate targets by integrating European and national energy system models.

Norwegian offshore wind can also enable the electrification of industry and new industry development (SDG 9). In this study, two levels of future activity level have been analysed. Results indicate that even in cases with high national demand, large volumes of electricity export could be realized. Consequently, offshore wind investments could enable even larger economic growth than assumed in this study. Further, Norwegian offshore wind can contribute to transform the Norwegian petroleum-based economy to be a value-creating and cost-competitive low-emission economy. To quantify the effect on the economy, it is an option to link energy system models to general equilibrium models.

There are several other **further research needs** related to providing robust insights on the role of offshore wind in the energy transition. This includes analysing the robustness of the investment strategy given a high temporal resolution, different

climate years, climate change effects, and forecast errors. Different regulatory frameworks governing offshore wind will also impact the deployment. To evaluate how Norwegian offshore wind can contribute to a fair green transition, the implications of the recently proposed Norwegian amendments to the regulatory processes of the Offshore energy act should be analysed.

Acknowledgements The authors are grateful to the Research Council of Norway for funding this work as part of the projects “FME NTRANS”, grant number: 296205, and “NCS 2030”, grant number: 331644. In addition, the authors wish to acknowledge the Norwegian Water and Resource Directorate (NVE) for providing detailed cost data on current and future offshore wind and transmission cable investments.

References

- Aamodt Espegren K, Haaskjold K, Rosenberg E, Damman S, Mäkitie T, Dahl Andersen A, Moe Skjølsvold T, Piscicella P (2023) NTRANS socio-technical pathways and scenario analysis. <https://doi.org/10.13140/RG.2.2.16978.32965>
- Aas Ø, Devine-Wright P, Tangeland T, Batel S, Ruud A (2014) Public beliefs about high-voltage powerlines in Norway, Sweden and the United Kingdom: a comparative survey. *Energy Res Soc Sci* 2:30–37
- Afewerki S, Aspelund A, Bjørgum Ø, Hanson J, Karlsen A, Kenzhegaliyeva A, Normann HE, Steen M, Sæther EA (2019) Conditions for growth in the Norwegian offshore wind industry. Centre for Sustainable Energy Studies (CenSES). Oslo
- Andersson I, Andresen AM, Haugen T, Holth MT, Mindeberg SK, Nettum NG, Ramtvedt AN, Schei AM, Ødegård A (2023) Innspill til forvaltningsregime for havvind— anbefaling om ny prosess for utvikling av havvind og strømnnett til havs. Norwegian Water Resources and Energy Directorate. https://publikasjoner.nve.no/rapport/2023/rapport2023_29.pdf
- Backe S, Skar C, del Granado PC, Turgut O, Tomasgard A (2022) EMPIRE: an open-source model based on multi-horizon programming for energy transition analyses. *SoftwareX* 17:100877
- Durakovic G, del Granado PC, Tomasgard A (2023) Powering Europe with North Sea offshore wind: the impact of hydrogen investments on grid infrastructure and power prices. *Energy* 263:125654
- Energi 21 (2022) Strategy 2022 national strategy for research development and commercialisation of new climate-friendly technology. <https://www.energi21.no/siteassets/energi21-strategy-2022-en-lr-2.pdf>
- Environment Norway (2022) Norwegian greenhouse gas emissions. <https://www.environment.no/topics/climate/norwegian-green-house-gas-emissions/>
- European Commission (2023) Non-binding agreement on goals for offshore renewable generation in 2050 with intermediate steps in 2040 and 2030 for priority offshore grid corridor Northern Seas offshore grids (NSOG) pursuant to Article 14(1) of the TEN-E Regulation (EU) 2022/869. https://energy.ec.europa.eu/system/files/2023-01/NSOG_non-binding_offshore_goals_final.pdf
- Haaskjold K, Pedrero RA (2023) Long-term optimization of the Norwegian energy system under the influence of the European power market. In: 19th international conference on the European energy market, Lappeenranta
- Haaskjold K, Rosenberg E, Seljom PMS (2023) Documentation of IFE-TIMES-Norway v3. <https://ife.brage.unit.no/ife-xmlui/bitstream/handle/11250/3058964/Documentation+of+IFE-TIMES-Norway+v3+%28ID+57346%29+%28003%29.pdf?sequence=2>

- IEA-ETSAP (2023) IEA-ETSAP optimization modeling documentation. <https://iea-etsap.org/index.php/documentation>
- International Renewable Energy Agency (IRENA) (2019) Future of wind: deployment, investment, technology, grid integration and socio-economic aspects. International Renewable Energy Agency, Abu Dhabi
- Jåstad EO, Bolkesjø TF (2023) Offshore wind power market values in the North Sea—a probabilistic approach. *Energy* 267:126594
- Koivisto M, Gea-Bermúdez J, Kanelas P, Das K, Sørensen P (2020) North Sea region energy system towards 2050: integrated offshore grid and sector coupling drive offshore wind power installations. *Wind Energ Sci* 5:1705–1712
- Korsnes M, Loewen B, Dale RF, Steen M, Skjølvold TM (2023) Paradoxes of Norway’s energy transition: controversies and justice. *Clim Pol* 23:1132–1150
- Linnerud K, Dugstad A, Rygg BJ (2022) Do people prefer offshore to onshore wind energy? The role of ownership and intended use. *Renew Sust Energy Rev* 168:112732
- Löffler K, Hainsch K, Burandt T, Oei P-Y, Kemfert C, Hirschhausen CV (2017) Designing a model for the global energy system—GENeSYS-MOD: an application of the open-source energy modeling system (OSeMOSYS). *Energies* 10:1468
- Malka L, Bidaj F, Kuriqi A, Jaku A, Roçi R, Gebremedhin A (2023) Energy system analysis with a focus on future energy demand projections: the case of Norway. *Energy* 272:121707
- Miljødirektoratet (2023) Norge har lovfestet et mål om å bli et lavutslippssamfunn i 2050. <https://miljostatus.miljodirektoratet.no/miljomal/klima/miljomal-5.4>
- Norwegian Water Resources and Energy Directorate (2023a) Beregning av kraftproduksjon for de identifiserte områdene. <https://veiledere.nve.no/havvind/identifisering-av-utredningsomrader-for-havvind/metode-og-vurderinger/beregning-av-kraftproduksjon/>
- Norwegian Water Resources and Energy Directorate (2023b) Identifisering av utredningsområder for havvind. <https://veiledere.nve.no/havvind/identifisering-av-utredningsomrader-for-havvind/>
- Norwegian Water Resources and Energy Directorate (2023c) Kostnader for kraftproduksjon. <https://www.nve.no/energi/analyser-og-statistikk/kostnader-for-kraftproduksjon/>
- Norwegian Water Resources and Energy Directorate (2023d) Nye områder for havvind. <https://veiledere.nve.no/havvind/identifisering-av-utredningsomrader-for-havvind/nye-omrader-for-havvind/>
- Regjeringen (2022a) Ambitious offshore wind initiative. <https://www.regjeringen.no/en/aktuelt/ambitious-offshore-wind-power-initiative/id2912297/>
- Regjeringen (2022b) Havvind. <https://www.regjeringen.no/no/tema/naringsliv/gront-industri/loft/havvind/id2920295/>
- Regjeringen (2022c) Major initiative to promote offshore wind power. <https://www.regjeringen.no/en/aktuelt/major-initiative-to-promote-offshore-wind-power/id2900436/>
- Reulein D, Tiwari S, Hestvik B, Kvannli A, Pinel D, Andresen CA, Farahmand H (2023) Large-scale offshore wind development and decarbonization pathways of the Norwegian energy system. In: 2023 19th international conference on the European energy market (EEM), Lappeenranta, pp 1–5
- Shields M, Beiter P, Nunemaker J (2022) A systematic framework for projecting the future cost of offshore wind energy. National Renewable Energy Laboratory, Golden
- Statnett (2022) Increased consumption results in a negative Norwegian energy balance from 2027. <https://www.statnett.no/en/about-statnett/news-and-press-releases/news-archive-2022/increased-consumption-results-in-a-negative-norwegian-energy-balance-from-2027/>
- Voldsund M, Reyes-Lúa A, Fu C, Ditaranto M, Nekså P, Mazzetti MJ, Brekke O, Bindingsbø AU, Grainger D, Pettersen J (2023) Low carbon power generation for offshore oil and gas production. *Energy Convers Manage*: X 17:100347
- Wiese F, Bramstoft R, Koduvere H, Pizarro Alonso A, Balyk O, Kirkerud JG, Grytli Tveten Å, Folsland Bolkesjø T, Münster M, Ravn H (2018) Balmorel open source energy system model. *Energy Strat Rev* 20:26–34

Open Access This chapter is licensed under the terms of the Creative Commons Attribution 4.0 International License (<http://creativecommons.org/licenses/by/4.0/>), which permits use, sharing, adaptation, distribution and reproduction in any medium or format, as long as you give appropriate credit to the original author(s) and the source, provide a link to the Creative Commons license and indicate if changes were made.

The images or other third party material in this chapter are included in the chapter's Creative Commons license, unless indicated otherwise in a credit line to the material. If material is not included in the chapter's Creative Commons license and your intended use is not permitted by statutory regulation or exceeds the permitted use, you will need to obtain permission directly from the copyright holder.



Will the Nordics Become an Export Hub for Electro Fuels and Electricity?



Kenneth Karlsson, Andrea Marin Radoszynski, Marie Münster, Lissy Langer, Ioannis Kountouris, Johannes Felipe Giehl, Jenny Westerberg, Sidsel A. Nissen, Alexander Daabech, Mathias Bache, Lars Hedemann, Julia Kirch Kirkegaard, and Julia Hansson

Abstract The Nordics have a huge renewable energy potential, mainly in the form of onshore and offshore wind as well as biomass potentials and can deliver some of the lowest electricity prices in Europe. They could export large amounts of electricity and hydrogen, supplying mainland Europe and abroad. But where and when should wind, PV and green fuel production capacity be built, and what kind of infrastructure is needed? Within the Nordics—who can/will become a net exporter of electricity and green fuels?

K. Karlsson (✉) · A. M. Radoszynski
Energy Modelling Lab, Copenhagen, Denmark
e-mail: kenneth.karlsson@energymodellinglab.com; Andrea@energymodellinglab.com

M. Münster · L. Langer · I. Kountouris
DTU Management, Kgs. Lyngby, Denmark
e-mail: maem@dtu.dk; lilang@dtu.dk; iokoun@dtu.dk

J. F. Giehl
Copenhagen Business School, Copenhagen, Denmark
e-mail: jfg.eco@cbs.dk

J. Westerberg
Profu, Stockholm, Sweden
e-mail: jenny.westerberg@profu.se

S. A. Nissen · A. Daabech · M. Bache · L. Hedemann
Brinckmann, Århus, Denmark
e-mail: san@brinckmanngroup.com; ada@brinckmanngroup.com;
mba@brinckmanngroup.com; lhe@brinckmanngroup.com

J. K. Kirkegaard
DTU Wind, Roskilde, Denmark
e-mail: jukk@dtu.dk

J. Hansson
IVL Swedish Environmental Research Institute, Chalmers University of Technology, Göteborg, Sweden
e-mail: Julia.hansson@ivl.se

To avoid sub-optimal solutions, some overall analysis and planning may be needed to secure societal benefits and reduce the overall cost. By comparing plans and visions for the build-out of electrolyser capacity, electricity and gas infrastructure, and wind and solar projects, we discuss consistency (or lack thereof) in the project pipelines. Furthermore, the future role of the Nordics is discussed by comparing scenario analysis from different modelling teams to identify robust conclusions and critical uncertainties.

The impact goes beyond SDG 13 (Climate action) and supports e.g., SDG 8 (Decent work and economic growth) by implementing a more sustainable economic system and also offers the opportunity to provide affordable and clean energy (SDG 7).

Key Messages

- The Nordics are in a position to become a major exporter of hydrogen and electricity—this conclusion is robust under the analysed situations.
- Methodology significantly influences hydrogen demand modelling conclusions. Back-casting tends to overestimate in the short and medium term, while demand-side optimization may underestimate.
- The implementation of hydrogen and electro fuels has direct positive impacts on several sustainable development goals (SDGs 7 on energy, 9 on industry, 11 on cities, and 13 on climate) but also indirect positive effects (on SDGs 8 on work and economic growth, and 12 on efficient use of resources).
- Renewable energy projects in the Nordic countries face local resistance, potentially causing delays in Power-to-X (PtX) development. Public concerns, including safety issues and the fair distribution of costs and benefits, are anticipated.

1 Introduction

The Nordics have a huge renewable energy potential, mainly in the form of hydropower, onshore and offshore wind, and can deliver some of the lowest electricity prices in Europe (Sovacool 2017). They could export large amounts of electricity, hydrogen, and green fuels, supplying Europe and abroad (Ikäheimo et al. 2018). However, studies show that aspects like the regional availability and diversity of renewable energy sources (Gea-Bermúdez et al. 2023; Ikäheimo et al. 2018; Karlsson and Meibom 2008) or infrastructure for imports and exports (Pedersen et al. 2022) influence the feasibility and demand for hydrogen and green fuels. With the expected limited global supply of sustainable biomass (Haberl et al. 2010), e-fuels based on hydrogen derived from electrolysis may play an important role (Mortensen et al. 2020), particularly for the chemical industry, and heavy long-haul transport such as aviation and shipping. But where and when should wind, PV, and electrolyser capacity be built, and what kind of infrastructure is needed? Can the Nordics compete with countries in the South that have abundant solar potentials?

Within the Nordics—who can/will become a net exporter of electricity and green fuels? Here, green fuels are defined as fuels based on carbon neutral electricity or sustainable biomass.

In a race to decarbonize and fulfil the net zero target, EU members adopted national Power-to-X strategies and targets as green hydrogen was seen as the renewable energy carrier that could decarbonize hard-to-abate industries. As of writing this, nineteen EU countries have adopted a national hydrogen strategy, one has implemented a roadmap, and Italy has produced preliminary guidelines. Among the Nordic countries, Denmark is the most ambitious, targeting between 4 and 6 GW of electrolyser capacity by 2030 according to Danish Ministry of Climate, Energy and Utilities (Klima-, Energi- og Forsyningsministeriet 2021) The Danish Energy Agency (DEA) has also set up a “Power-to-X taskforce” to ensure alignment with related resource and consumption sectors and to nurture the development of a market. Sweden follows Denmark in terms of ambitions, targeting 5 GW according to the Swedish Energy Agency (Energimyndigheten 2022), while Norway does not specify a target in its national strategy. Germany, in turn, boasts a 10 GW electrolyser capacity target, also reflecting the country’s larger size according to the Federal Government of Germany (Bundesregierung 2023). The plans and ambitions on the role of green hydrogen and e-fuels presented in the early 2020s were reignited by the decision to end dependency on Russian natural gas in early 2022. For countries to achieve these ambitious targets, however, two overall prerequisites must be met (1) enough renewable electricity, and (2) a willingness-to-change.

To avoid sub-optimal solutions, some overall analysis and planning may be needed to secure societal benefits and reduce the overall cost. The future role of the Nordics is discussed by comparing scenario analysis from different modelling teams to identify robust conclusions and critical uncertainties.

Combating climate change through renewable energies provides extensive, sustainable economic potential. Climate protection measures offer the potential to improve global development prospects and contribute to the Sustainable Development Goals of the United Nations.

The impact goes beyond SDG 13 “Climate action” and supports e.g., SDG 8 “Decent work and economic growth” by implementing a more sustainable economic system. It also offers the opportunity to provide “affordable and clean energy” (SDG 7).

2 Who Will Be the Future Net Exporter of Power and Green Fuels?

2.1 Hydrogen in the Context of the Nordics

The Nordics offer great potential for the integration of hydrogen into the overall energy system. The European Union sees hydrogen as a key element of its strategy to

reduce greenhouse gas emissions, and the Nordics are often identified as role models for the energy transition. Their high potential of renewable energy sources offers the opportunity to become a major player in the European “hydrogen economy” and export green fuels to Central European countries (Ikäheimo et al. 2018).

However, the development of a hydrogen economy depends on several factors, such as economic feasibility, future demand and supply, and the idea of becoming a hydrogen export region is subject to uncertainties. The availability of renewable energy sources for hydrogen and green fuel production is an important factor for the success of the energy transition. Different expansion pathways result in huge differences regarding the capacity of electrolysis. The status quo shows different regional conditions but high potential in Norway, Finland, Sweden, and Denmark (Pedersen et al. 2022) Gea-Bermúdez et al. (2023) show a range of 6–357 GW of offshore electrolysis capacity by countries in the North Sea and Baltic region. Gea-Bermúdez et al. (2023), Ikäheimo et al. (2018), and Karlsson and Meibom (2008) state that wind (onshore and offshore) and hydropower are the most relevant renewable energy sources on a Nordic scale to produce hydrogen and green fuels.

The national conditions reveal differences within the Nordics. Child and Breyer (2016) analyse the decarbonization of the Finnish energy system. Onshore wind energy and PV will be the main contributors, and Finland is the only country in the Nordics with a share of nuclear power in the long term. Bramstoft and Skytte (2017) focus on the decarbonization of the Swedish energy sector and Lund et al. (2022) of the Danish energy sector. Both countries offer good onshore wind conditions with relevant contributions of biomass. In the long term, a limited offshore wind contribution is possible while the nuclear capacity in Sweden decreases. Norway has a different starting position as the power sector is already renewable due to abundant hydropower capacity (Pedersen et al. 2022) and an expansion of offshore wind and PV (Haaskjold and Pedrero 2023).

The investigations by Lund et al. (2022), Karlsson and Meibom (2008) and Bramstoft and Skytte (2017) highlight the opportunity to use the biomass potential in the production of synthetic fuels. Biomass offers either the chance to process hydrogen by adding biomass-based CO₂ or directly in biofuel production. Drysdale et al. (2019) and Lester et al. (2020) show uncertainty about the future contribution of biomass and discuss the competition with hydrogen for renewable fuel production.

Pedersen et al. (2022) discuss infrastructure as a prerequisite for exports or imports of energy. The realisation of the potential to export renewable energy is uncertain. The existing interconnections between the Nordics and Europe limit the chance to import or export hydrogen and require further investments. The Swedish infrastructure lacks a country-wide gas transmission grid. The gas grid in the south-west is linked to Denmark and is seen as the starting point for further development. Norway, as a major source of European natural gas supply, already has an interconnected energy infrastructure that generates opportunities for future hydrogen exports. Together with Denmark, the country offers potential storage capacities for hydrogen in the form of salt caverns. The Danish natural gas grid has existing connections to central Europe and can function as a link for the Nordics to supply

European demand (Pedersen et al. 2022). In this context, the Danish grid operator Energinet participates in the current discussions on a hydrogen backbone (Creos et al. 2021).

2.2 Example 1: Analysis with DTU Balmorel Europe

The Balmorel model is a technology rich, large-scale energy system model, which has been applied in many parts of the world (Wiese et al. 2018). The model is driven by exogenous inputs on demands in different sectors for electricity, heat, and fuels, including hydrogen and other alternative fuels. For some sectors, the hydrogen demands are given directly, for others the demands are determined endogenously based on competition with other energy carriers, and associated technologies and infrastructures, e.g., for the generation of peak electricity. For the analysis presented below, a least-cost optimization has been applied for the entire EU with investments allowed in electricity and hydrogen transmission grids and storages, as well as generation units. Technology costs on investment and operation are mainly from the technology catalogues provided by the Danish Energy Agency (DEA 2021). Fuel costs, as well as a uniform CO₂ tax is based on the World Energy Outlook's Net Zero Energy scenario (IEA 2023).

2.2.1 EU Hydrogen Infrastructure in 2050

Kountouris et al. (2023) investigate the development of EU hydrogen infrastructure in a pan-European case study from 2030 to 2050. They analyse three main scenarios: (1) *Blue*, which allows for hydrogen production using steam methane reforming from abated and unabated natural gas as well as via electrolysis and imports of green hydrogen; (2) *Green*, which only allows hydrogen production from electrolyzers and imports; and (3) *-Imports*, which also only allows hydrogen production from electrolyzers but prohibits hydrogen imports from outside EU. The first two scenarios consider imports from Tunisia & Algeria, Morocco, and Ukraine. In this section, we consider *grey* hydrogen as hydrogen produced using steam methane reforming (SMR) from unabated natural gas, *blue* hydrogen as produced using SMR from abated natural gas using CCS, and *green* hydrogen produced by electrolyzers using electricity from the grid. Since we focus on the long-term developments in 2050, for simplicity, we do not consider the additional restrictions on electricity sourcing introduced by the Delegated Act on RFNBOs (EC 2023). In addition, the study examines how different cost assumptions for electrolyzers and natural gas prices affect the balance between blue versus green hydrogen production. In the following, we extract the most important results for the hydrogen infrastructure in the Nordics. Iceland was not part of the study.

2.2.2 Hydrogen Demand Assumptions

The Balmorel model used in Kountouris et al. (2023) assumes a certain amount of hydrogen as model input. This demand needs to be fulfilled and drives the model's investments in a mixture of new hydrogen grids, repurposed natural gas grids, and electricity transmission. Therefore, it is important to carefully evaluate which and to what amount hydrogen demands are included.

They consider an EU hydrogen demand of about 10 Mt. (332 TWh) in 2030 and 53 Mt. (1767 TWh) in 2050. The exogenous demand input is based on the Hydrogen Backbone report (2021) and includes applications for ammonia synthesis, liquid fuels and high-value chemicals, high-temperature industrial process heat, and iron ore reduction using hydrogen directly (but not for residential heating). The Nordics are assumed to have a relatively low hydrogen demand compared to other Central and Western European countries with more industry.

Figure 1 shows the input of exogenous hydrogen demands in the left column, which are an assumption based on other reports and an input to the model, and in the right column, the endogenous hydrogen demand, which is additional demand derived within the Balmorel model. The endogenous hydrogen demand can be used for synthetic fuels for buses and trains and for peak power. Thus, for the Nordics in 2050, the model assumes a total demand of 3.3 Mt. (110 TWh) of hydrogen.

2.2.3 EU Self-Sufficiency

In the context of the recent political discussion about the heavy dependence on Russian natural gas (especially in Germany), Kountouris et al. (2023) investigate the

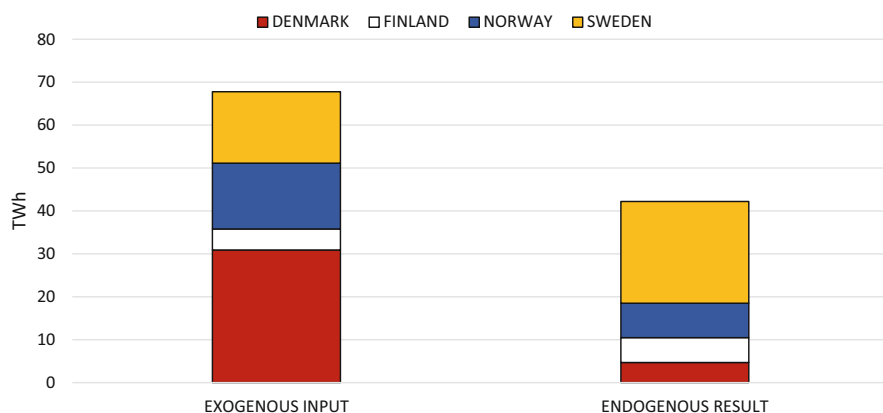

Fig. 1 Hydrogen demand in the Nordics in 2050. *Note:* The left column is based on exogenous input values and the right column results from the model. The values are identical for all three scenarios

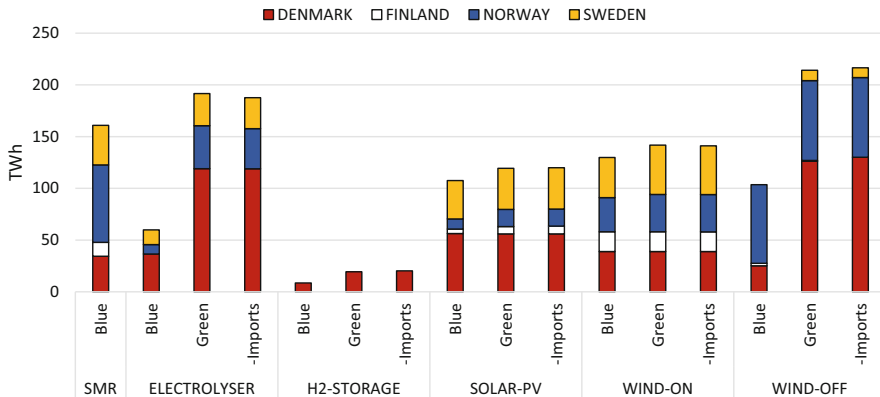

Fig. 2 Selected generation in the Nordics in 2050. *Note:* Scenario blue allows for hydrogen production using steam methane reforming (SMR) from abated natural gas, green only allows production using electrolysers, and -Imports disallows imports from outside EU (Color figure online)

impact of a self-sufficient EU without reliance on hydrogen imports from outside EU. They find that prohibiting hydrogen imports seems to have only marginal effects on the infrastructure of the Nordics (Fig. 2), whereas the main effects are seen in the South of Europe. For example, Italy that used to become a hydrogen corridor for imports from Northern Africa to Germany, significantly expands its hydrogen production capacity if imports are prohibited. Since the *Green* and *-Imports* scenario results are relatively similar, in the following, we illustrate only the *Blue* and *Green* scenarios.

2.2.4 Blue Hydrogen Production

The impact of blue versus green hydrogen production is still relevant in the context of the recurring debate on the role of carbon capture and sequestration (CCS) considering the importance for the Nordics, especially in Norway, and the large amount of 1.400 Mt/year of captured CO₂ that the European Commission considers in their modelling exercises using their JRC-EU-TIMES model (Blanco et al. 2018). We hence explore this, even though the European Commission with their Delegated Act (EC 2023) has for now settled on the use of renewable electricity and electrolysers to produce renewable hydrogen.

2.2.5 Generation and Storage Capacities

When hydrogen production is allowed by using steam methane reforming (SMR), the dynamics in the Nordics change significantly. Due to a carbon tax in the model

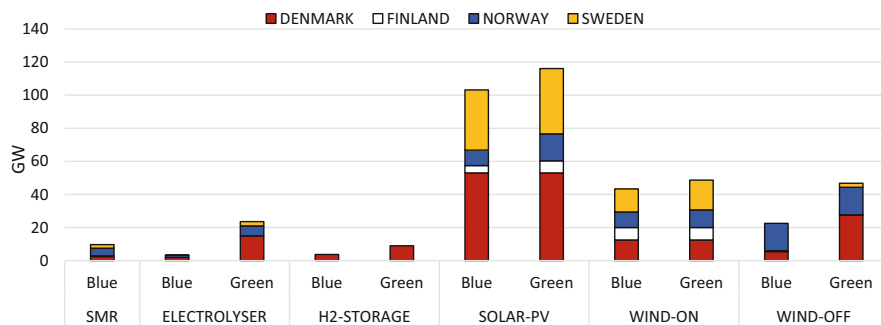

Fig. 3 Selected capacities in the Nordics in 2050. *Note:* Scenario blue allows for hydrogen production using steam methane reforming (SMR) from abated natural gas, and green only allows production using electrolyzers (Color figure online)

(about 190 €/t CO₂ in 2050), only abated natural gas using CCS technologies is used in the Nordics. Kountouris et al. (2023) assumes a natural gas price of 10.87 €/MWh in 2050 based on the \$3.8/MBtu of the Net Zero emissions scenario of the World Energy Outlook 2022 (IEA 2022).

Figure 3 shows that with small SMR capacities, especially in Norway, substantial amounts of blue hydrogen replace what would have been green hydrogen using electrolyzers (Fig. 2). In addition, this also substantially reduces the need for renewable energy and hydrogen storage (Fig. 3). Most importantly, it shifts the centre of hydrogen production within the Nordics from Denmark to Norway, strengthening the role of natural gas producers in the energy transition. Due to the lower capacity factors of solar PV compared to wind (see generation in Fig. 3) and the assumptions of limited onshore wind potentials based on public acceptance, the strongest impact is on (relatively expensive) offshore wind investments, which decrease significantly, especially in Denmark and Sweden (Fig. 3).

2.2.6 Transmission Infrastructure

Figure 4 shows that the *Blue* scenario also affects the transmission infrastructure, namely electricity transmission lines (EL) and hydrogen pipeline infrastructure (H2). The *Blue* scenario decreases the overall need for hydrogen infrastructure in the Nordics from 45 to 32 GW. On the other hand, the need for electricity transmission lines remains approximately the same in both scenarios, at 68 GW.

2.2.7 Electricity and Hydrogen Exports

The Nordics mainly provide hydrogen to central Europe by exporting to Germany (DEU) and the Netherlands (NLD) via Denmark (DNK) or Norway (NOR). Figure 6

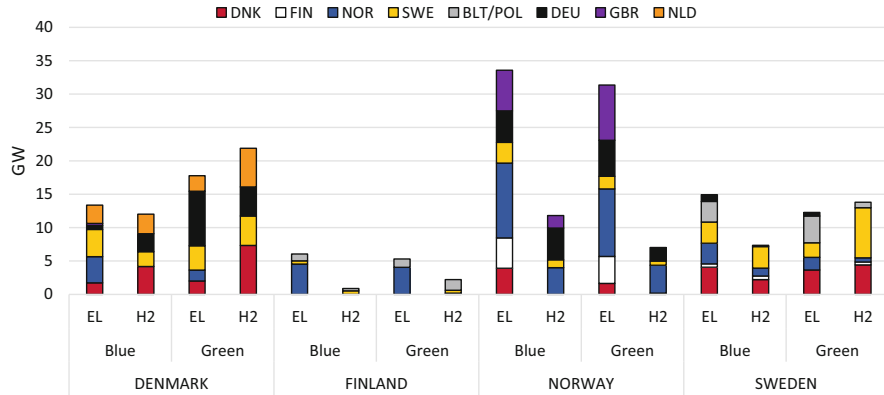

Fig. 4 Selected electricity (EL) and hydrogen (H2) transmission infrastructure in the Nordics in 2050. *Note:* Scenario blue allows for hydrogen production using steam methane reforming (SMR) from abated natural gas, and green only allows production using electrolysers. *DNK* Denmark, *FIN* Finland, *NOR* Norway, *SWE* Sweden, *BLT/POL* Baltic countries + Poland, *DEU* Germany, *GBR* Great Britain, *NLD* Netherlands (Color figure online)

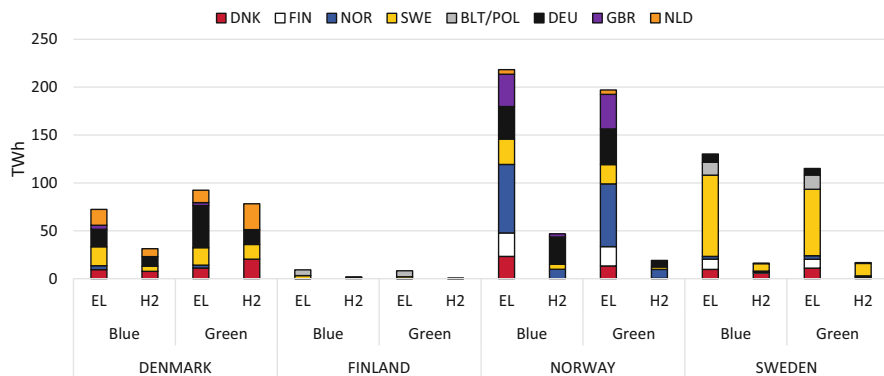

Fig. 5 Electricity and hydrogen exports from and within the Nordics in 2050. *Note:* Scenario blue allows for hydrogen production using steam methane reforming (SMR) from abated natural gas, and green only allows production using electrolysers. *DNK* Denmark, *FIN* Finland, *NOR* Norway, *SWE* Sweden, *BLT/POL* Baltic countries + Poland, *DEU* Germany, *GBR* Great Britain, *NLD* Netherlands (Color figure online)

also shows considerable trade flows within the Nordics and within the Nordic countries considering the trade between the different bidding zones of each country. In the *Blue* scenario, Norway becomes the main exporter to Germany and significantly increases its hydrogen exports (Fig. 5). At the same time, in the *Blue* scenario, Denmark reduces its exports to Germany, the Netherlands, and Sweden. Overall, however, the hydrogen exports from the Nordics stay approximately the same, around 71 TWh in 2050.

On the other hand, the electricity exports from the Nordics are considerably higher than the hydrogen exports, with around 265 TWh in all scenarios (Fig. 5). The *Blue* scenario also affects electricity exports as more electricity is exported from Norway and Sweden. The dynamics of the *Green* scenario are driven by the additional offshore wind generation (Fig. 3) which is mainly added in Denmark and to some extent in Sweden.

2.3 Example 2: Analysis with EML TIMES-NEU Model

The TIMES Northern Europe (TIMES-NEU) is based on the open source ON-TIMES (<https://github.com/NordicEnergyResearch/NCES2020>). The number of green fuels and production technologies have been expanded, heavy industry is more detailed, with more green options and trade connections to surrounding countries (Fig. 6).

TIMES-NEU Characteristics

- Partial equilibrium least cost system optimising and investment model.
- Main driver to the model is official economic projections on sector level and projections of population.
- 56 time slices a year, representing different seasons, day/night, and critical load situation—solved in 5-year steps until 2050.
- In Norway, Denmark, Sweden, Germany, and Poland all sectors included—internal trade with eight most important energy carriers among these core countries.
- With the surrounding countries (light blue) power trade between connected regions are modelled with price profiles to main model countries.
- UK, Belgium, and Netherlands—also trade with the eight energy carriers based on price profiles and potentials.
- Main model countries (darkest blue in the map) can also trade more than 40 energy carriers (fossil fuels, bio- and electro fuels, biomass, and electricity) with the global market represented with projected global market fuel prices (Fig. 7).

Important assumptions are as follows:

- National climate targets are assumed respected in the five main countries.
- Existing and projected CO₂- and energy taxes are included for the five main countries.
- Exogenous electrolyser capacity introduced according to “realistic” plans.
- Stop for import of green fuels and biomass to the main model area from 2040 (excluded from this is ammonia and hydrogen) to reflect impact from possible future EU regulation, e.g., extended EU Carbon Border Adjustment Mechanism (CBAM).

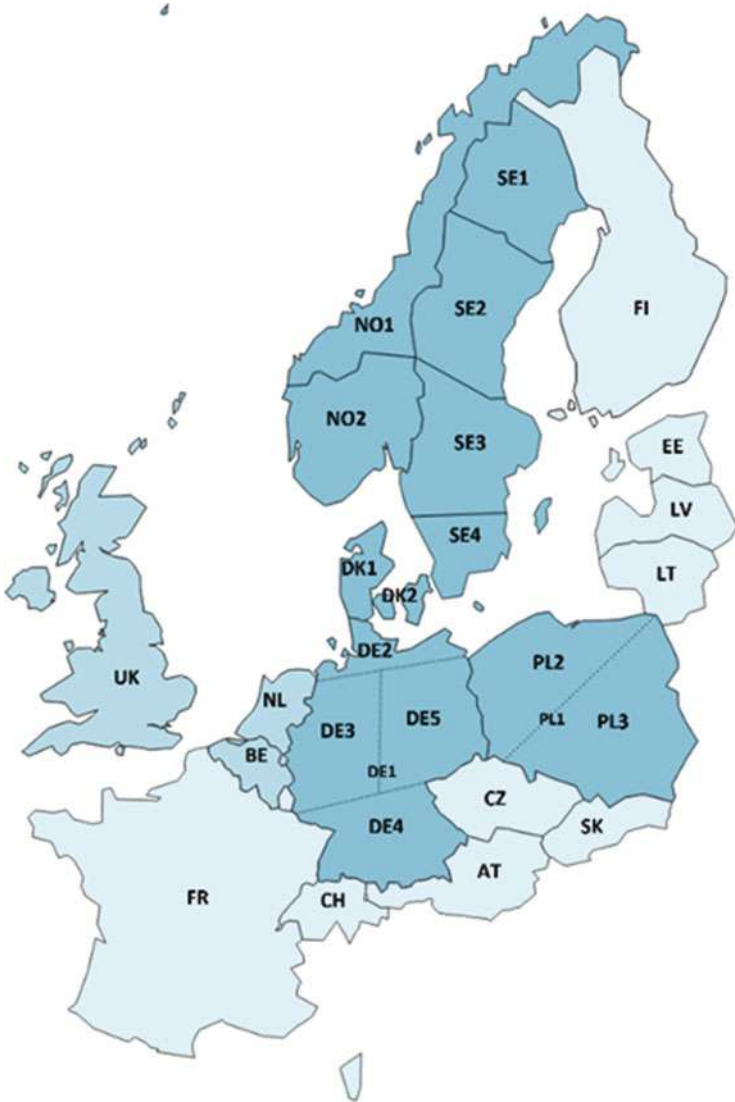

Fig. 6 Geographical area and model regions of TIMES-NEU

- Reduction over time in available biomass for energy. Biomass resource in the main model countries is reduced by around 20% in 2030 and 40% in 2050.
- External/exogenous green hydrogen demand projections for UK, Belgium, and Netherlands
- For non-energy purpose (mainly chemical industry) fossil fuels are assumed to be faced out linearly from 2030 to 2050.

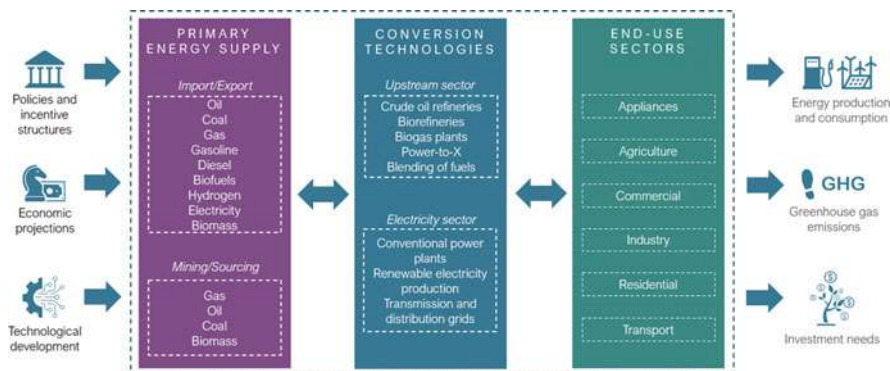

Fig. 7 Illustrative structure of the TIMES-NEU. The model includes primary supply of fuels, upstream sector, power and heat sector, and detailed modelling of all end-use sectors

2.3.1 Future Demand for Green Fuels

The demand for green fuels found in TIMES-NEU is a result of the competition between the different fuels, technological options in each sector and a global market with competing prices on all energy carriers. In the full modelling period, the five main countries can trade eight energy carriers (electricity, e-methanol, b-methanol, e-ethanol, b-ethanol, ammonia, wood chips, and wood pellets), among each other, only limited by transmission capacity (pipes, power lines etc.) With the UK, Belgium, and Netherlands the main countries can also trade the eight energy carriers and with the rest of the surrounding countries electricity can be traded between countries with shared borders. All +40 energy carriers can be traded with global market, restricted by the implemented trade constraints.

In Fig. 8 it is very clear when the import constraint on biomass and biofuels kicks in (2040), this means biofuels are replaced by e-fuels. The demand for green hydrogen as a fuel is only manifested at the end of the scenario period when the steel industry is converting.

The demand for green hydrogen in the UK, Belgium and Netherlands are based on an external analysis of their own possibility for producing fuels and their expected demand (Brinckmann 2023). The model then sees a potential export option to these countries based on their net demand and a related price. In particular, Belgium and Netherlands have a large chemical industry with a growing demand for green fuels in the future and there are big international harbours in the Netherlands which are imagined becoming fuelling hubs for international shipping.

Figures 9 and 10 shows which countries are producing the hydrogen used and traded among the countries in the model (and to the global market). The role Denmark potentially can play in this market is huge because of the wind resources in the North Sea and the central position with short distances to large consumers. So, this analysis shows that Denmark could deliver almost 50% of the needed hydrogen

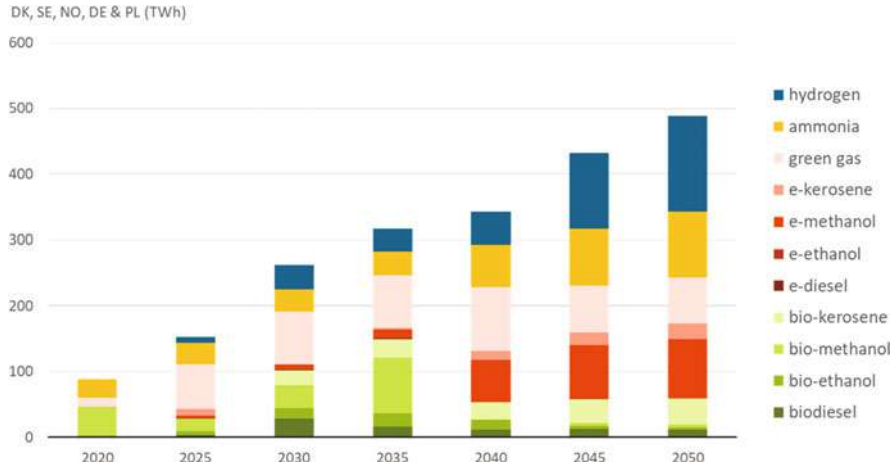

Fig. 8 Modelled demand for green fuels (bio and electro) in the fully modelled countries (Denmark, Sweden, Norway, Germany, Poland)—not including UK, Netherlands, and Belgium

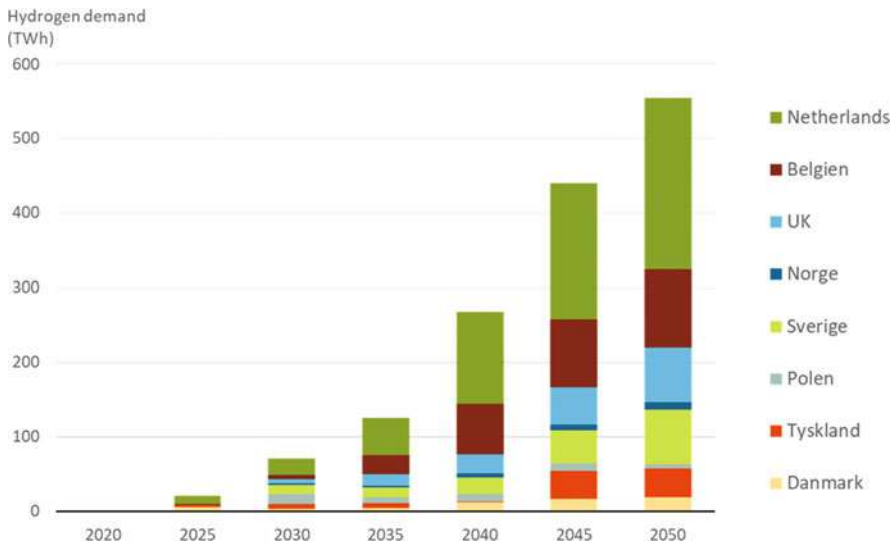

Fig. 9 Expected direct hydrogen demand in the larger model area. *Note:* This includes direct use in industry. The demand is endogenous decided by the model in Denmark, Norway, Sweden, Germany, and Poland while it is exogenous added to the model for Netherlands, Belgium, and UK

in the model area. Any mismatch between demand and production in the model area is balanced out by trade on the global market.

Surprisingly, to many, the model shows Germany as net exporter of green hydrogen until 2040 (Fig. 11) mainly due to already planned German electrolyser

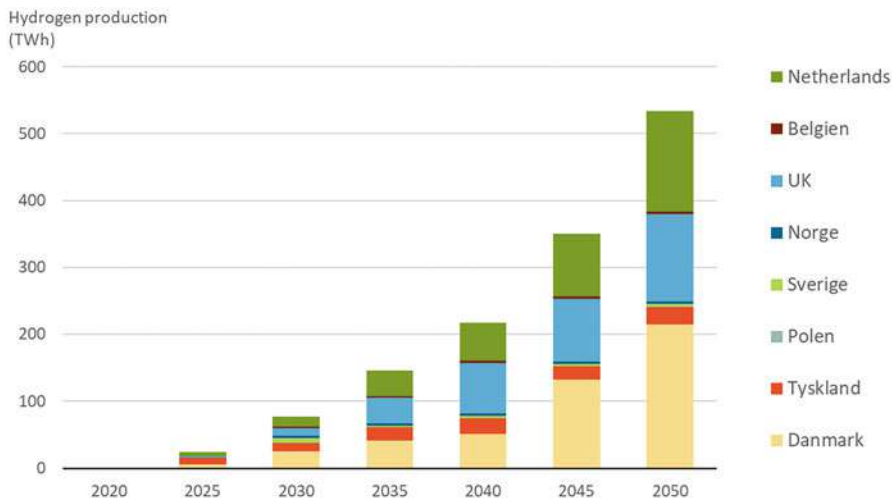

Fig. 10 Expected hydrogen production in the larger model area. *Note:* The production is endogenously decided by the model in Denmark, Norway, Sweden, Germany, and Poland while it is exogenously added to the model for the Netherlands, Belgium, and the UK



Fig. 11 Germany's trade with green hydrogen

capacity and it is only when the steel industry switches from coal to green hydrogen and electricity in 2045 that their own production cannot keep up. This means a total replacement of the old steel plants with new HYBRIT plant types.

The Danish export of green hydrogen flows in two directions (Fig. 12). South, as expected beforehand, not in the beginning to Germany but to Belgium. Another flow is to Sweden which has a growing demand for green hydrogen for their chemical industry and for the green transition of their steel industry. Sweden cannot produce

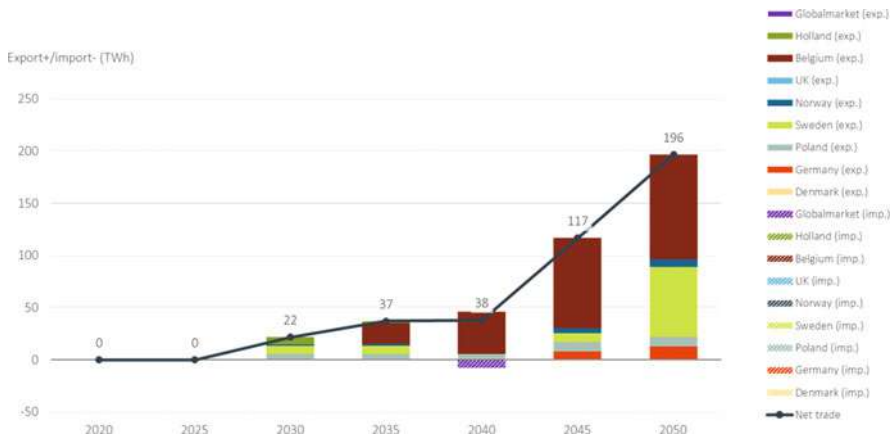

Fig. 12 Danish trade with green hydrogen

hydrogen as cheap as Denmark can in the North Sea and the model finds it cheaper to establish a hydrogen pipeline from Denmark to Sweden. The Swedish hydro power resources are limited, and Swedish offshore wind parks will have less FLH than wind parks in the Danish part of the North Sea, hence the production price of hydrogen is higher in Sweden.

These modelling results perfectly illustrate the uncertainty in the future market for green fuels. In this case the driver for Danish green hydrogen exports is an exogenous demand projection for UK, Belgium, and Netherlands not dynamically considering the competition from electrification and other fuels to green hydrogen in these countries. Another driver for hydrogen demand is the production of ammonia for the shipping and chemical industries and in the presented scenario the model imports all fossil and green ammonia from the global market hence no local production. The prices the model sees for production (including transport and handling) of ammonia in the Middle East, Northern Africa and Australia are cheaper than production in the model area. If this balance was switched and green ammonia was being locally produced, then the demand for hydrogen in the model area would almost double.

2.3.2 Development of Infrastructure

Taking a closer look at the infrastructure development needed to fulfil the energy demands, we should pay special attention to the energy islands. The TIMES-NEU model has the option to invest in three **energy islands** for Denmark in the North Sea, plus utilizing the nearshore resources of the island Bornholm. According to the agreement from the Danish Parliament from June 2020, the first phase of the North Sea islands will have a minimum capacity of 3 GW of offshore wind power, with potential for expansion to 10 GW offshore wind. The strategic environment

assessment also includes a second phase in which a total of at least 10 GW of offshore wind power is established (phase one and two), but with the possibility of establishing a total of up to 40 GW (phase one and two) within the same area if the power per km² is increased.

The ambitious goal of building these energy islands is still under political discussion and will determine the position of Denmark as a hub for green hydrogen in Northern Europe.

The Nordic power sector will have to face a major transformation to accommodate the high electricity demand needed to produce green fuels in the future. The resulting power capacity of the Nordics more than doubles, from around 90 GW to 232 GW in 2020, as a result of the electrification of key industrial sectors and the increase in the use of green fuels in Europe.

These capacities will also be highly dependent on the position that the Nordics would take in the global market of green fuels. A key question to understand the needed expansion of the power system is: would the Nordics become self-sufficient to fulfil their energy needs or would they become net exporters of green fuels to central Europe?

The modelling results of TIMES-NEU shows that the high wind potential of the North Sea is utilized to produce hydrogen, mostly at the energy islands, and export it to central Europe. The offshore wind installed capacity in Denmark by 2050 reaches 10 GW mainland and 44 GW in the energy islands, summing to a total of 54 GW, almost reaching the renewable potential set in the model to 57 GW. The same case applies for Norway, that almost utilizes their full renewable potential of 9 GW, setting up 8.6 GW of wind offshore by 2050. Due to the less competitive wind resources in Sweden, the model only installs 10 GW of the potential 20 GW, and imports the hydrogen directly from Denmark, Norway, or the global market, as shown in Fig. 13.

Figure 13 shows the evolution of the offshore wind capacity and Fig. 14 the electrolyser installed capacity in the TIMES-NEU modelled regions. These results show that it is more profitable to build the electrolysers directly in the energy islands, where the wind potential is high, and then build pipelines to transport the hydrogen to the main consumption hubs. This result is highly dependent on the cost assumptions of building pipelines versus building power lines and setting up the electrolysers in the mainland.

Another key result is the first-mover effect. The country that makes the first move in installing enough electrolyser capacity will determine the market share it can take in the first years. The results from TIMES-NEU show that the buildout of the energy islands with the electrolysers, makes Denmark a first mover, taking a high share of the global market, competing with Germany until the German industry demands its own domestic production.

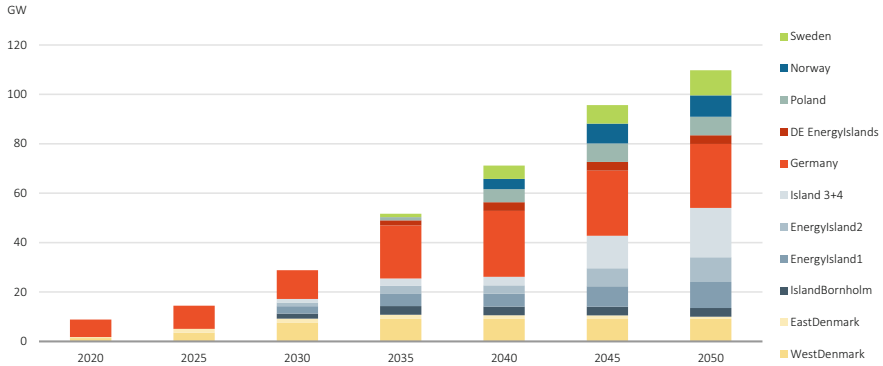

Fig. 13 Offshore wind capacity per country and energy islands. *Note:* “IslandBornholm”, “EnergyIsland1,2” and “Island 3+4” are Danish islands, “DE EnergyIslands” are German islands

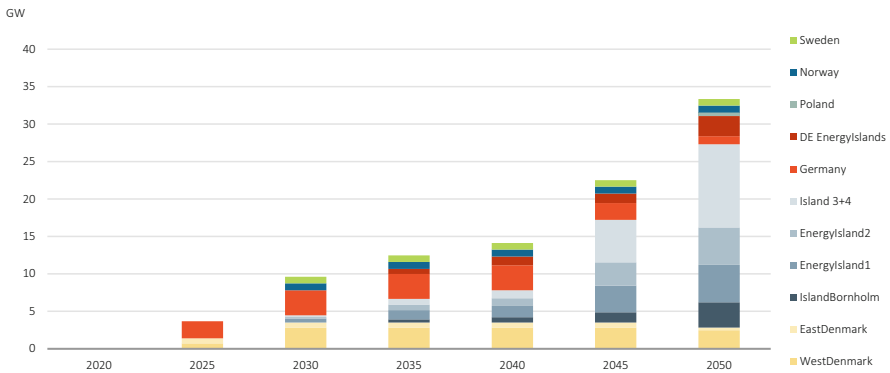

Fig. 14 Electrolyser capacity per country and energy islands. *Note:* “IslandBornholm”, “EnergyIsland1,2” and “Island 3+4” are Danish islands, “DE EnergyIslands” are German islands

2.4 Take Aways from the Two Modelling Examples

Conclusions are clearly affected by the chosen methodology; are you back-casting demand for hydrogen from a fully decarbonised future or are you modelling the competition between energy carriers moving towards the same future? Back-casting tends to over-estimate the demand for hydrogen in short and mid-term (Balmorel case), while optimisation of the demand side tends to do the opposite, because it is not capturing early investments in plants (TIMES case).

The model area and boundary conditions are also important factors; what kind of trade options to the outside world has been established in the modelling framework?

Balmorel covers the power production and transmission system in all of Europe and potential production and export of green hydrogen from Northern Africa. This

makes the Balmorel model suitable for analysing the competition in production of green hydrogen between different geographical areas and hence where to build hydrogen pipelines and where to expand renewable power capacity and transmission lines. The TIMES model has a detailed modelling of all end-use sectors and is therefore strong in analysing which sectors are going to use green hydrogen (and other green fuels), for what and from when. Obviously, combining the two models in one consistent analysis would improve the results and strengthen conclusions. This has not been possible to do for this chapter but there is an ongoing Danish research project wherein it will be realised.

3 How Is the Green Fuel Revolution in the Nordics Affecting SDGs?

The green fuel revolution has obvious advantages from a climate point of view by contributing to replacing fossil fuels. But what impacts, positive and negative, can the development of renewable electro fuels have on other sustainability goals and targets in a system perspective? To answer this question the United Nations Sustainable Development Goals (SDGs) framework has been used. There are 17 SDGs, and each SDG has several targets (in total 169 targets) The SDG Impact Assessment Tool (GMV and Chalmers 2023) has been used to screen the most relevant sustainability aspects affected by electro fuel production and their replacement of fossil fuels. The results are shown in Table 1. Biomass based fuels are not included in the assessment.

The most obvious direct **positive impact** of electro fuels is the potential reduction of greenhouse gas emissions through the replacement of fossil fuels (SDG 7 and 13). Although the production of electro fuels comes with upstream emissions, these can be low compared to the fossil fuels they replace. As an example, Hansson et al. (2023) calculated greenhouse gas performance of several renewable transport fuels, including electro fuels. The results show emission factors of 0–20 g CO_{2e}/MJ compared to 94 g CO_{2e}/MJ for their fossil counterparts. The emission factors of fossil fuels are based on the reference given by the EU Renewable Energy Directive. The emission factor of electro fuels varies depending on for example, the type of electro fuel, and assumed emission factor for electricity. The estimates above assume that the electro fuels meet the criteria set out in the EU delegated acts on methodology for renewable fuels of non-biological origin (RFNBOs), which means a very low electricity emission factor. To assure a climate benefit of electro fuels, the electricity must have very low climate impact. Other direct positive impacts include upgrading the industry to increased sustainability (SDG 9), transition of the transport sector and reduced environmental impact of cities (SDG 11). Indirect positive impacts include job creation in the Nordic countries (SDG 8) and potentially more efficient use of natural resources (SDG 12).

Table 1 Summary of relevant SDGs for electro-fuel production

SDG	Overall impact	Motive	Link to energy system model results
1. No poverty	Indirect negative	Risk that industrial countries exploit resources in developing countries	Development in total system cost of the energy system and its share of GDP
6. Clean water and sanitation	Direct negative	Electro fuels will require large amounts of clean water (for hydrogen production through electrolysis of water)	Amount of electro fuels produced and used
7. Affordable and clean energy for all	Direct positive	Mainly positive impacts. Renewable fuels replace fossil fuels. At the same time a lot of electricity is required which may lead to direct and indirect negative environmental impacts as well as competition of energy for other purposes	Projection of green fuel and electricity prices
8. Decent work and economic growth	Indirect positive	The production of renewable fuels will create new and potentially more jobs in the Nordics (although there is extensive refinery industry currently, the production of green fuels may cover a larger part of the global fuel demand and thus lead to more jobs)	Amount of installed energy related capacities in the period
9. Industry, innovation, and infrastructure	Direct positive	The purpose of the green fuel revolution is to upgrade industry to increased sustainability	New synergies between energy sector, industries, and other end-users
11. Sustainable cities and communities	Direct positive	Renewable fuels support the transition of the transport sector to increased sustainability and reduce the environmental impacts of cities. Conflicting targets may be potentially increased energy prices	Speed of transition in the different economic sectors
12. Responsible consumption and production	Indirect positive	Primarily assumed positive impact on efficient use of natural resources due to reduced demand for fossil resources. There may also be negative effects on specific targets	Projected future use of biomass and other resources for energy and fuel production
13. Climate action	Direct positive	Renewable fuels will replace fossil fuels and thus contribute to reduced climate impact (provided that the electricity required has low climate impact)	Development in GHG emissions from the energy sector
14. Life below water	Indirect negative	Probably low impact. The water demand for electrolysis might affect this SDG, although more relevant for SDG 6	Water consumption for energy plants

Note: There may be both positive and negative impacts on a specific SDG. The table shows the impact that was considered most important in the screening process

The production of electro fuels requires large amounts of clean water, which has a direct **negative impact** on SDG 6. In areas with scarce water resources there may be solutions such as desalination of sea water or cleaning of wastewater. Other negative impacts are mostly indirect and related to risks that industrial countries exploit resources (e.g. critical materials) in developing countries (SDG 1), negative environmental impacts due to increased electricity demand (SDG 7), competition of energy for other purposes (SDG 7) and potentially increased energy prices when electricity demand increases (SDG 11).

4 Key Challenges and Social Concerns

For the Power-to-X visions to become reality, a willingness-to-change is needed. The key challenges can be summarized into (1) the need for bridging a price gap and (2) a deviating focus, from energy-transition into decarbonization, with consequences for the build-out and social acceptability of PtX.

4.1 *Price Gap: A Battle of Colours*

With the normalization of natural gas prices, blue hydrogen is currently (2023) more than 50% cheaper than green hydrogen (Bhashyam 2023) While green hydrogen is expected to outcompete grey hydrogen by 2030 due to taxation on emissions, blue hydrogen will be more difficult to out-battle as the impact of carbon taxation is small. Green hydrogen is expected to become cost-competitive with blue hydrogen given various impact factors, like technology maturity, build-out of renewable energy, the EU methane regulation EU ETS, and tax regimes, at least within the EU.

The future of green hydrogen consumption in the EU has been determined by the Renewable Energy Directive III, where the hydrogen consumption in the industry must fulfil a minimum requirement of 60% renewable hydrogen by 2035. When looking at other continents, the picture looks different. In the US, blue and green hydrogen seem to be considered as renewable hydrogen and subsidies target both technologies (upon decision of the Treasury department by the end of 2023) Looking to Asia, specifically China, where natural gas is scarce, green hydrogen is expected to be the most cost-effective. Chinese technology could also become one of the key drivers for technology advancement within electrolyzers (IEA 2023).

4.2 *Delays and Challenges*

The combination of an un-bridged price gap and the intensified focus on decarbonization has resulted in general delays for announced PtX Projects. Figure 15

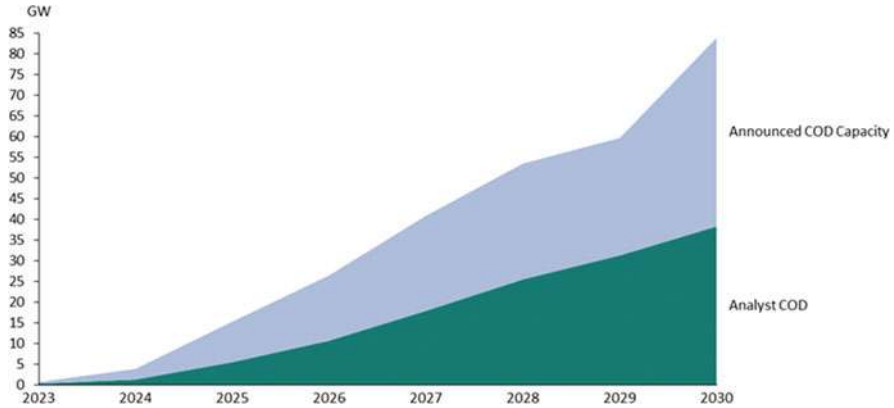

Fig. 15 Commercial Operation Date (COD) based on the announced project pipeline of developers compared to the expected pipeline PtX capacity of analyst when incorporating offtake markets, country of development and development consortium (Brinckmann 2023)

outlines forecasted delays in the realization of European PtX projects in comparison to announced realization date, considering key parameters for commercial assessment of project feasibility (Brinckmann 2023).

Another reasoning for project delays can be found in the missing offtake commitment from the industry. Although the offtake potential has been thoroughly investigated, and national plans and strategies for PtX have been initiated (e.g., the Danish PtX Strategy 2021), there is still a lack of commitment from targeted off takers, e.g., in the steel industry. While the political ambitions and targets in the EU are getting more and more clear, the political landscape in other parts of the world is more uncertain, e.g., in the US with the upcoming presidential election.

Finally, local opposition adds a further layer of complexity and uncertainty. Local community concerns over PtX are still under-researched, but likely to emerge with the prospect of accelerated PtX upscaling. Renewable energy facilities already face considerable local resistance in the Nordic countries (European Commission et al. 2022; Energy Monitor 2022; MX Underwriting Europe et al. 2022; Kirkegaard et al. 2020). This can delay the build-out of PtX. Further, PtX facilities are likely to produce public concerns over their siting: For instance, PtX facilities are so far classified as industrial facilities in Denmark, and therefore to be placed in industrial zones. Since the Danish PtX Strategy encourages renewable energy and PtX facilities to be co-located to make best use of the electricity network, this has potential to create local community concerns in urban areas (Klima-, Energi- og Forsyningsministeriet 2021). At the same time, the potential of PtX facilities to turn rural areas into industry-like areas, if sited there, is foreseen to produce local concerns due to a disrupted ‘sense of place’. Eventually, public concerns are also likely to emerge around safety (e.g., explosion risks), the distribution of costs and benefits (e.g., compensation schemes). Meanwhile, there is potential to also create local value, e.g., through job-creation, compensation for loss of value of property,

and funds to develop local communities. There is therefore an urgent need to strengthen public engagement and participation of local communities in the plans for PtX, to foster **social acceptance**.

4.3 Renewable Electricity: It Needs to Happen Sooner Rather than Later

A large amount of renewable electricity is needed to produce green hydrogen in the targeted amounts. Additional renewable energy installations are not an option but a prerequisite for realizing the PtX targets. The Danish Energy Agency has, for instance, projected the consumption of electricity in 2050 will be five times as much as it is today. This is almost entirely due to PtX and this electricity needs to come from renewable sources (DEA 2023). While additional capacities are needed, it is also beneficial for countries to add capacity to existing electricity-generating assets. With an estimated timeline of 3–4 years for a 1 GW electrolyser facility to go from financial investment decision (FID) to commercial operation, additional renewable electricity is needed sooner rather than later.

4.4 Willingness-to-Change: The Carrot and the Stick

Although PtX technology is not a new invention, it has failed to achieve a commercial breakthrough. Much of this is due to the fact that it is an expensive way to produce hydrogen and its derivatives compared to current production methods, which are predominantly based on natural gas. For the vast potential to be realized, it requires political will through regulation, funding, and technological maturity. Here the tendency in the EU is to use the stick rather than the carrot, which is reflected in the regulations governing the area, as outlined below:

4.4.1 Political Willingness

In recent years, the EU has worked hard to create an environment encouraging investment in sustainable solutions (the ‘carrot’) After years of waiting for a definition of renewable hydrogen, it finally arrived in June 2023 (Commission 2023), including rules for electricity generating assets, geographical location, and time correlation between electricity sourcing and hydrogen production. While this publication has been welcomed, the primary EU legislation on renewable energy in the industrial and transport sectors is still pending, and the final transposition of EU legislation into national law will not be completed until the summer of 2025. The

lack of certainty in the legislation creates poor conditions for investment, which is one of the reasons why only a few projects are taking a final investment decision.

4.4.2 Funding

Funding for green hydrogen-based products has slowly started to pick up. The EU invests in PtX production through the European Hydrogen Bank and the Innovation Fund (CINEA 2023) programs. At a national level, Germany is leading the way in funding projects with several initiatives, to support hydrogen production and stimulate the off-take sector, e.g., the CCfD mechanism and H2Global (BMWK 2023). Denmark has been focusing on supporting the production side (but not the demand side), e.g., through the Danish tender for Power-to-X capacity. The winners have a period of four years to develop and install their PtX equipment and to start the production of green hydrogen. The total amount of support available was 170 Mio. EUR (Energistyrelsen 2023). While European countries have made it clear that they are keen on PtX, the process has a long timeline with uncertainties regarding budget and scale, and a vast funding gap, which remains to be filled. The current funding budget for PtX in Europe is ~EUR 22 billion, which, according to the industry, is far from the funding required to meet the targets.

4.4.3 Technology Maturity

The offtake market has expressed interest and a positive attitude towards hydrogen-based products since the products will be required to meet the sustainability requirements placed on all industries by the Renewable Energy Directive III, ReFuelEU Aviation, and FuelEU Maritime. However, PtX is an expensive production method, which requires some industries to invest in new technology and equipment to adapt to hydrogen. This leads to a possible lock-in scenario for off-takers when investing in equipment. Many industry players are waiting for others to take the first step and lead the way.

5 Conclusion

This chapter has been diving into the uncertainties of predicting the future demand for green hydrogen and other green fuels and what role the Nordic countries could play as their supplier. The role of hydrogen depends on the competition with other options for delivering energy services. In many cases hydrogen comes in as the last option because it is energy inefficient and so far, much more expensive than the close competitors: Electrification, biofuels, and blue hydrogen.

5.1 Export Potential from the Nordics

The Nordics offer great conditions to become an export region for hydrogen and green fuels. However, the region faces challenges regarding the ramp up of the hydrogen economy.

In all scenarios the Nordics become a net-exporter of hydrogen and electricity. If blue hydrogen is accepted then Norway will be the main producer, while if there is no market for blue hydrogen, then Denmark is in a leading position to become the main producer of green hydrogen. However, it is uncertain how this export market will split between Germany, Belgium, and Netherlands. The Nordic countries' export options seem not to be sensitive to import of hydrogen from northern Africa or southern Europe as these will rather out compete electrolyzers in south and central Europe.

5.2 Need for Ramping Up Wind, PV, Electrolysers, and Infrastructure

A key aspect is the expansion of renewable capacities. The focus will be on offshore wind and PV as the expansion of onshore wind is restricted, e.g., due to public acceptance. The whole North Sea and Baltic region offers the potential of 3–357 GW of electrolysis, but this requires an expansion of offshore wind and PV production with a factor 20 compared to today.

5.3 Political Decisions and Regulation

The success of green e-fuel production in the Nordics depends on future policies for import of biomass and biofuels to the EU and the ETS securing a phase out of fossil fuels in all sectors. The end-use sectors need an early price signal to invest in green fuel-based processes.

Some key policies that can drive the demand for e-fuels:

- Will the countries ratify and respect EU's Fit for 55 package and their national climate targets?
- What level will the CO₂ price reach and how fast?
- Will governments or the EU create subsidy schemes for green fuels?
- How big will the market be for PPAs and other offtake agreements in the coming years?
- Will there be any restriction on imports of biomass and biofuels to the EU?

5.4 Sustainable Development Goals

The implementation of hydrogen and electro fuels has direct positive impacts on several sustainable development goals (SDGs 7, 9, 11 and 13) but also indirect positive effects (on SDGs 8 and 12) There are however also potential negative impacts that need to be addressed (mainly linked to water demand for hydrogen production i.e., SDG 6 and linked to electricity production, i.e., SDGs 1, 7, 11).

5.5 Social Concerns

Renewable energy projects in the Nordic countries are facing local resistance, potentially causing delays in PtX development. Public concerns regarding safety issues and the fair distribution of costs and benefits, are anticipated. Despite challenges, PtX initiatives offer opportunities for local value creation, such as job opportunities and community development funds. Urgent action is needed to strengthen public engagement, ensuring the inclusion of local communities in PtX plans to foster social acceptance.

References

- Bhashyam A (2023) 2023 hydrogen levelized cost update: green beats gray. BloombergNEF. <https://about.bnef.com/blog/2023-hydrogen-levelized-cost-update-green-beats-gray/>
- Blanco H, Nijs W, Ruf J, Faaij A (2018) Potential for hydrogen and power-to-liquid in a low-carbon EU energy system using cost optimization. *Appl Energy* 232:617–639. <https://doi.org/10.1016/j.apenergy.2018.09.216>
- Bramstoft R, Skytte K (2017) Decarbonizing Sweden’s energy and transportation system by 2050. *Int J Sustain Energy Plan Manag* 14:3–20. <https://doi.org/10.5278/IJSEPM.2017.14.2>
- Brinckmann (2023) Proprietary database on announced PtX projects in Europe. Brinckmann, Aarhus. <https://brinckmanngroup.com/>
- Bundesregierung (2023) Fortschreibung der Nationalen Wasserstoffstrategie. NWS 2023. Bundesministerium für Wirtschaft und Klimaschutz (BMWK) As of July 2023, Berlin
- Child M, Breyer C (2016) Vision and initial feasibility analysis of a recarbonised Finnish energy system for 2050. *Renew Sust Energ Rev* 66:517–536. <https://doi.org/10.1016/j.rser.2016.07.001>
- Creos, DESFA, Elering, Enagás, Energinet, Eustream, FGSZ, Fluxys Belgium, Gas Connect, Austria, Gasgrid Finland, Gasunie, Gaz-System, Gas Networks Ireland, GRTgaz, National Grid, NET4GAS, Nordion Energi, OGE, ONTRAS, Plinovodi, Snam, TAG, Teréga (2021) Analysing future demand, supply, and transport of hydrogen, European hydrogen backbone. Gas for Climate, Guidehouse, Germany
- Danish Government (2021) The Governments strategy on Power-to-X. https://ens.dk/sites/ens.dk/files/ptx/strategy_ptx.pdf
- DEA (2021) Technology data for renewable fuels. Energistyrelsen. Danish Energy Agency. <https://ens.dk/en/our-services/projections-and-models/technology-data/technology-data-renewable-fuels>

- DEA (2023) Analyseforudsætninger til Energinet, J nr. 2023–2106. Danish Energy Agency. [Microsoft Word - AF23 - Sammenfatningsnotat.docx \(ens.dk\)](#)
- Drysdale D, Mathiesen BV, Paardekooper S (2019) Transitioning to a 100% renewable energy system in Denmark by 2050: assessing the impact from expanding the building stock at the same time. *Energ Effic* 12:37–55. <https://doi.org/10.1007/s12053-018-9649-1>
- Energimyndigheten (2022) Förslag till Sveriges nationella strategi för vätgas, elektrobränslen och ammoniak. Eskilstuna, Sweden. ISBN 978-91-7993-004-8
- Energy Monitor (2022) How to overcome local opposition to wind projects, 18 May 2022. Accessed 6 Nov 2023. <https://www.energymonitor.ai/corporate-strategy/how-developers-can-overcome-local-opposition-to-onshore-wind-projects/>
- European Commission (2023) Delegated regulation on a Union methodology for the production of renewable fuels of non-biological origin (RFNBOs). <https://eur-lex.europa.eu/legal-content/EN/TXT/?uri=CELEX:32023R1184>
- European Commission, Directorate-General for Energy, Tallat-Kelpšaitė J, Brückmann R, Banasiak J et al (2022) Technical support for RES policy development and implementation—Simplification of permission and administrative procedures for RES installations (RES simplify). Interim report. Publications Office of the European Union. <https://data.europa.eu/doi/10.2833/239077>
- Gea-Bermúdez J, Bramstoft R, Koivisto M, Kitzing L, Ramos A (2023) Going offshore or not: where to generate hydrogen in future integrated energy systems? *Energy Policy* 174:113382. <https://doi.org/10.1016/j.enpol.2022.113382>
- GMV and Chalmers (2023) SDG impact assessment tool. Gothenburg Centre for Sustainable Development and Chalmers Institute of Technology. <https://sdgimpactassessmenttool.org>. Downloaded November 2023
- Haaskjold K, Pedrero RA (2023) Long-term optimization of the Norwegian energy system under the influence of the European power market. In: 2023 19th international conference on the European energy market (EEM) presented at the 2023 19th international conference on the European energy market (EEM). IEEE, Lappeenranta, pp 1–6. <https://doi.org/10.1109/EEM58374.2023.10161972>
- Haberl H, Beringer T, Bhattacharya SC, Erb K-H, Hoogwijk M (2010) The global technical potential of bio-energy in 2050 considering sustainability constraints. *Curr Opin Environ Sustain* 2:394–403. <https://doi.org/10.1016/j.cosust.2010.10.007>
- Hansson J, Nojpanya P, Ahlström P, Furusjö E, Lundgren J, Gustavsson Binder T (2023) Costs for reducing GHG emissions from road and air transport with biofuels and electrofuels. IVL report C770, June 2023
- IEA (2022) World energy outlook 2022. International Energy Agency, Paris, France
- IEA (2023) World energy outlook 2023. International Energy Agency, Paris, France
- Ikäheimo J, Kiviluoma J, Weiss R, Holttinen H (2018) Power-to-ammonia in future North European 100% renewable power and heat system. *Int J Hydrog Energy* 43:17295–17308. <https://doi.org/10.1016/j.ijhydene.2018.06.121>
- Karlsson K, Meibom P (2008) Optimal investment paths for future renewable based energy systems—using the optimisation model Balmorel. *Int J Hydrog Energy* 33:1777–1787. <https://doi.org/10.1016/j.ijhydene.2008.01.031>
- Kirkegaard JK, Cronin T, Nyborg S, Karnøe P (2020) Paradigm shift in Danish wind power—the (un)sustainable transformation of a sector. *J Environ Policy Plan* 23(1):97–113. <https://doi.org/10.1080/1523908X.2020.1799769>
- Klima-, Energi- og Forsyningsministeriet (2021) Regeringens Strategi for PtX. <https://kefm.dk/Media/637751860733099677/Regeringens%20strategi%20for%20Power-to-X.pdf>
- Kountouris I, Bramstoft R, Madsen T, Gea Bermúdez J, Münster M, Keles D (2023) A unified European hydrogen infrastructure planning to support the rapid scale-up of hydrogen production. <https://doi.org/10.21203/rs.3.rs-3185467/v1>
- Lester MS, Bramstoft R, Münster M (2020) Analysis on electrofuels in future energy systems: a 2050 case study. *Energy* 199:117408. <https://doi.org/10.1016/j.energy.2020.117408>

- Lund H, Thellufsen JZ, Sorknæs P, Mathiesen BV, Chang M, Madsen PT, Kany MS, Skov IR (2022) Smart energy Denmark. A consistent and detailed strategy for a fully decarbonized society. *Renew Sust Energy Rev* 168:112777. <https://doi.org/10.1016/j.rser.2022.112777>
- Mortensen AW, Mathiesen BV, Hansen AB, Pedersen SL, Grandal RD, Wenzel H (2020) The role of electrification and hydrogen in breaking the biomass bottleneck of the renewable energy system—a study on the Danish energy system. *Appl Energy* 275:115331. <https://doi.org/10.1016/j.apenergy.2020.115331>
- MX Underwriting Europe, Wind Europe, Fieldfisher, LEIRA (2022) Report “barriers to wind”, Vienna, Austria
- Pedersen JL, Pade L-L, Søyland S, Håkansson NC, Grue J, Christensen JD, Diab M, Georgiev I, Krogh A, Ivarsson Á, Meinert Cardel O, Schøn T, Jákupsstovu S, Ritonummi T, Partanen T, Þorvaldsson JAH, Fuglerud M, Hallonsten P (2022) Hydrogen, electrofuels, CCU and CCS in a Nordic context. Nordic Energy Research, Oslo
- Sovacool B (2017) Contestation, contingency, and justice in the Nordic low-carbon energy transition. *Energy Policy* 102:569–582. <https://doi.org/10.1016/j.enpol.2016.12.045>
- Wiese F, Bramstoft R, Koduvere H, Pizarro Alonso A, Balyk O, Kirkerud JG, Tveten ÅG, Bolkesjø TF, Münster M, Ravn H (2018) Balmorel open-source energy system model. *Energ Strat Rev* 20:26–34. <https://doi.org/10.1016/j.esr.2018.01.003>

Open Access This chapter is licensed under the terms of the Creative Commons Attribution 4.0 International License (<http://creativecommons.org/licenses/by/4.0/>), which permits use, sharing, adaptation, distribution and reproduction in any medium or format, as long as you give appropriate credit to the original author(s) and the source, provide a link to the Creative Commons license and indicate if changes were made.

The images or other third party material in this chapter are included in the chapter’s Creative Commons license, unless indicated otherwise in a credit line to the material. If material is not included in the chapter’s Creative Commons license and your intended use is not permitted by statutory regulation or exceeds the permitted use, you will need to obtain permission directly from the copyright holder.



Transition Pathways for a Low-Carbon Norway: Bridging Socio-technical and Energy System Analyses



Miguel Chang, Kari Espegren, Kristina Haaskjold, Eva Rosenberg, Sigrid Damman, Tuukka Mäkitie, Paolo Pisciella, Allan Dahl Andersen, and Tomas Moe Skjølvold

Abstract This study presents an interdisciplinary approach to analyze different transition pathways towards the sustainable development of a low-carbon society, focusing on Norway as a case. The study bridges a socio-technical perspective on sustainability transitions with techno-economic energy systems and regional-economic modelling analyses. Incorporating a socio-technical perspective in the scenario design allows us to envision pathways considering causal processes of technological and socio-institutional change, and potential transition bottlenecks.

M. Chang · K. Espegren (✉) · K. Haaskjold · E. Rosenberg
Institute for Energy Technology (IFE), Kjeller, Norway
e-mail: Miguel.Chang@ife.no; Kari.Espegren@ife.no; kristina.haaskjold@ife.no;
Eva.Rosenberg@ife.no

S. Damman
Department of Technology Management, SINTEF Digital, Trondheim, Norway
e-mail: Sigrid.Damman@sintef.no

T. Mäkitie
Department of Technology Management, SINTEF Digital, Trondheim, Norway
TIK Centre for Innovation, Technology and Culture, University of Oslo, Oslo, Norway
e-mail: Tuukka.Makitie@sintef.no

P. Pisciella
Department of Industrial Economics and Technology Management, NTNU – Norwegian
University of Science and Technology, Trondheim, Norway
e-mail: Paolo.Pisciella@ntnu.no

A. D. Andersen
TIK Centre for Innovation, Technology and Culture, University of Oslo, Oslo, Norway
Department of Food and Resource Economics, University of Copenhagen,
Copenhagen, Denmark
e-mail: Allanda@tik.uio.no

T. M. Skjølvold
Department of Interdisciplinary Studies of Culture, NTNU, Trondheim, Norway
e-mail: Tomas.Skjolvold@ntnu.no

© The Author(s) 2024

M. Labriet et al. (eds.), *Aligning the Energy Transition with the Sustainable Development Goals*, Lecture Notes in Energy 101,
https://doi.org/10.1007/978-3-031-58897-6_9

The resulting scenarios are used in the techno-economic energy system analysis to show cost-optimal energy system configurations, including varying levels of new renewable capacity needed, new conversion technologies, and fuel substitutions across all sectors leading to different decarbonization pathways for the Norwegian energy system by 2050. The regional-economy analysis addresses the impacts of these pathways on general economic growth and labor. The results show that higher levels of decarbonization are possible for Norway; however, potential bottlenecks can slow down the transition, while trade-offs in economic growth and development must be balanced out with decarbonization ambitions.

Key Messages

- Linking socio-technical perspectives with energy systems & economic modelling analyses helps providing a holistic framework to assess the feasibility of the energy transition.
- Transition bottlenecks—such as the maturity of technology options, feasibility of novel innovations and infrastructure, and policy developments—are identified across four envisioned scenarios for Norway.
- Cost-optimal energy system designs show varying levels of decarbonization potential.
- Trade-offs between SDG targets, namely economic growth and decarbonization, emerge when considering the degree of socio-technical change under different transition pathways of the energy system.

1 Introduction

The decarbonization of the energy system is expected to play a major role in achieving global climate action targets and contributing to the development of a more sustainable society (IPCC 2022). As part of the global Sustainable Development Goals (SDGs), nations worldwide have committed to providing access to affordable and clean energy (SDG 7) as well as promoting sustainable economic growth (SDG 8), industrialization and innovation (SDG 9), ensuring responsible consumption and production patterns (SDG 12) and undertaking climate action (SDG 13) (UN 2023). Reaching these goals by mid-century will require a rapid and comprehensive net-zero transition which likely involves adopting novel technologies and infrastructures, innovations and reorientation in companies, building new low-carbon value chains, and deep changes in behavior and culture (Andersen et al. 2023a).

Intrinsically, understanding how this transition will take place also requires increased knowledge of how technical developments in national energy systems are affected by the underlying societal, institutional, and organizational structures and policies. Exploring these aspects can therefore provide new insight into the different challenges occurring as the transition unfolds and outlooks of potential

pathways for a low-carbon society. Therefore, quantifying the impacts of these elements along the transition can enhance quantitative analyses of the energy system, facilitate planning, and provide better and practical decision support that would not necessarily be considered solely under a techno-economic perspective (Bolwig et al. 2019).

The process of planning the transition towards a sustainable energy system relies on mathematical models to quantify the impacts of different energy transition pathways while capturing the complex interactions within the energy system (Prina et al. 2020; Chang et al. 2021). These modelling tools often have a techno-economic perspective that captures the technical details and flows from supply technologies to end-use sectors.

However, recent studies emphasize the need to better integrate the social dimension in energy system modelling approaches (Trutnevyte et al. 2019; Krumm et al. 2022; Süsser et al. 2022). In turn, this can improve the relevance of modelled transition pathways and more adequately capture the social dynamics that drive or constrain the required changes in the energy system. Indeed, including a socio-technical perspective can also provide a more realistic understanding of the transition with practical implications of technological innovation, and societal and institutional change as society moves towards a sustainable future (Köhler et al. 2019). The integration of quantitative modelling and socio-technical studies, as argued by Turnheim et al. (2015), can thus provide a richer and more robust analytical approach to inform and provide guidance to decision-making.

Previous studies have investigated linking socio-technical transition research and energy system modelling. For instance, Li et al. (2015) highlight the need for more integrative approaches as socio-technical factors are often not captured in quantitative modelling. A systematic review by Hirt et al. (2020) outlines that only a small fraction of studies (~12%) considered the whole energy system, while sectoral models are more frequently aligned with socio-technical transition models.

Other recent studies also follow integrative approaches while looking more coarsely at the whole energy system rather than integrating bottom-up technological details. For example, these studies align socio-technical transition insights with integrated assessment models (IAMs) for European analyses (van Sluisveld et al. 2020), or propose socio-technical scenarios to IAMs for analyzing the energy transition in the UK (Freeman and Pye 2022).

However, as suggested by Geels et al. (2016), IAM's are not always sufficiently suited to provide national and local insight, due to their large global coverage and simplified representation of the energy system. Tailored knowledge accommodating sectoral detail and insight on the economy is needed, along with a necessary understanding of transition dynamics in order to support climate action and to address knowledge needs of policymakers at the national level. Some recent work partly addresses this, bridging energy system modelling and transition studies at the European level but without capturing the broader impacts on the economy (Hainsch et al. 2022). Although studies linking energy system and economic models can be found in the literature (Chang et al. 2023), e.g. linking bottom-up ESMs and CGE models of Norway (Helgesen et al. 2018), these do not purposefully align with

socio-technical transition theories (Markard et al. 2012) in their study designs. On the other hand, other studies which align quantitative modelling with socio-technical research do not take a holistic view of the entire energy system, but rather explore the transition in specific sectors, such as the power (Rogge et al. 2020) or heating sectors (Nilsson et al. 2020).

The present study addresses these gaps, providing an approach that bridges socio-technical research and bottom-up analysis of the energy system including all end-use sectors and the economy, taking Norway as a case. This approach allows for a recursive dialogue between models and qualitative storylines, to fine-tune and provide complementary insight from both quantitative and qualitative methods. In turn, the different scenarios provide potential outlooks of sustainable energy system transitions, while capturing different drivers for change and bottlenecks along the transition pathways and their impact on economic development in line with sustainable development goals.

This chapter presents an applied interdisciplinary study, taking Norway's energy system as a case. We combine a socio-technical transition perspective with scenario design applied to techno-economic energy systems and regional economic analyses. Socio-technical transition research is used to envisage contrasting transition pathways for Norway's energy system as well as to evaluate the socio-technical feasibility of transition pathways in terms of governance (Turnheim and Nykvist 2019). The resulting pathways are quantified and incorporated as scenarios into both a long-term energy system model (ESM) in the IFE-TIMES-Norway model (Haaskjold et al. 2023), and in the computable general equilibrium (CGE) model REMES-Norway (Werner et al. 2017). Respectively, the analyses in these models provide a bottom-up representation of the energy system and a representation of the wider effects of the different energy transition pathways on economic development.

The remaining of this chapter presents the following: Section 2 describes the overarching approach and the methods used. Section 3 presents the envisaged transition pathways, providing both a qualitative and quantitative description of the different scenarios. Section 4 presents the results of the analysis, followed by a discussion on these and other general implications in Sect. 5. Finally, Sect. 6 presents the conclusions of the study.

2 Approach and Methods

This section presents the key methods used in the scenario design and quantitative analyses with energy systems and economic models. The analyses were developed as part of the work in the Norwegian Centre for Energy Transition Strategies (FME NTRANS n.d.) and consist of a 10-step approach bridging socio-technical research with techno-economic analyses. The basis of this 10-step approach and the analyses are presented in further detail by Espegren et al. (2023).

2.1 *Envisioning Socio-technical Transition Pathways*

The scenario development was based on identifying pathways for the Norwegian energy system with contrasting degrees of disruption to the existing socio-technical regime and its central institutions. As suggested by Andersen et al. (2023b), the depth of system change can be distinguished in two dimensions: socio-institutional and technological. Thus, the scenarios considered combinations of minor and major system changes across these dimensions resulting in four pathways:

- Incremental Innovation (INC) pathway: minor system change in both dimensions
- Technological Substitution (TECH) pathway: major technological change and minor socio-institutional change
- Social Change (SOC) pathway: major socio-institutional change and minor technological change
- Radical Transformation (RAD) pathway: major change in both dimensions

Each of the proposed pathways is thus associated with a different type of system change. These pathways manifest in different ways. Minor technological change is linked to decarbonization mainly through core technologies that are largely compatible with the existing value chains, including biofuels, electrification, and energy-efficiency, while major technological change features novel technologies such as hydrogen, ammonia and carbon capture and storage (CCS), requiring novel value chains. Meanwhile, the socio-institutional dimension considers, e.g., the degree of change in population's values and lifestyles. The kind of system change in this pathway is also linked, for example, to changes in the actor networks in energy systems, and the kind and depth of institutional change (regulations, norms, and cognitions). Moreover, transformative pressures at a wider societal level are embedded in these pathways—for example, long-term trends related to demographics, projected demand for energy services, climate change, and societal preferences. The four pathways are elaborated in Sect. 3.

Based on the visions and qualitative descriptions of the four different pathways, key quantifiable factors were mapped to be used as base assumptions in the modelling analyses. The quantification of the scenarios covered factors such as projected energy demand developments per sector, supply and end-use technology data, limitations on energy production and transmission, resource availability, CO₂ costs and targets, and energy prices. Further refinement of these pathways included recursive inputs from the modelling analyses and project partners.

2.2 *Energy-Economy Modelling*

To assess the impacts of the different transition pathway scenarios considered, the IFE-TIMES-Norway (Haaskjold et al. 2023) and REMES-Norway (Werner et al. 2017) models were used. The IFE-TIMES-Norway provides a long-term cost

optimal bottom-up representation of the energy system designs for Norway, providing investment decisions to meet energy demands in all use sectors. Meanwhile, REMES-Norway is a CGE model capable of detecting the impacts of changes in the energy sector in the overall economy.

2.2.1 Energy System Analysis with IFE-TIMES-Norway

IFE-TIMES-Norway is a technology-rich bottom-up model of the Norwegian energy system (Haaskjold et al. 2023), based on the TIMES modelling framework (Loulou et al. 2016). The model represents Norway's energy system as five regions corresponding to the current electricity market areas and includes the different end-use sectors and their corresponding demands for energy services. The model provides operational and investment decisions starting from the year 2018 to 2050 in five-year periods from 2020 to 2050. To capture operational variations in energy generation and end use, each model period is divided into 96 sub-annual time slices (24 hours for a representative day in each of the four seasons).

IFE-TIMES-Norway minimizes the total discounted system costs of the energy system, including investments in supply and demand technologies, storages and transmission capacity, operation and maintenance costs, and costs of net electricity imports. The main model inputs include fuel prices, electricity prices from countries with transmission capacity connected to Norway, renewable resources, and technology characteristics such as costs, efficiencies, potentials, and technology learning curves using the Norwegian kroner (NOK) as monetary unit (exchange rate of 1 NOK = 0.1 EUR). As outputs, the model provides the optimal mix of supply capacity, and use of energy carriers and end-use technologies to meet energy service demands.

A sensitivity analysis was included in the study to address uncertainty in key input assumptions associated with the quantification of the pathways and scenarios. These uncertainties also characterize to an extent potential transition bottlenecks.

For example, uncertainty in future technology costs can have an apparent impact in modelling results, while simultaneously portraying challenges in technology deployment and consequent technology learning rates along the transition. Intrinsically, these considerations align with transition bottlenecks, further explained in Sect. 3.2, related to the maturity of options and the fit of innovations in the socio-technical system and its infrastructure. Likewise, analyzing the sensitivity of biofuel import prices or CO₂ price assumptions addresses the parametric uncertainty of these inputs while also portraying the potential effect of transformative pressures at a societal level regarding global resource availability and institutional preferences related to adopting policy measures. As such, these assumptions expand the perspectives of the societal and political feasibility of decarbonization options, illustrating how biofuel availability and CO₂ pricing act as potential transition bottlenecks. In the energy system analysis conducted with IFE-TIMES-Norway, the sensitivity analysis included the following parameters:

- Biofuel price increases in SOC and INC, which rely most heavily on biofuel replacements.
- Higher investment costs in later years, representing slower technology learning, in the TECH and RAD scenarios which have higher learning rates and adoption of new technologies.
- High CO₂ prices development (based on values from Regjeringen 2022a) across all four scenarios.

2.2.2 Regional Economic Analysis with REMES-Norway

The CGE model REMES-Norway (Werner et al. 2017) has been used to assess the macro-economic impacts of the various transition pathways. The REMES-Norway model provides a multi-regional multi-sectoral representation of the economy, spanning from the year 2018 to 2050. REMES-Norway is used to analyze the possible responses of the economy to policy measures or technology innovations.

In the current study, eight main factors characterizing the development of the economy were used as basis for capturing the impacts of the four scenarios considered. These factors included: population, productivity, technology, energy intensity, resource deployment, resource export, shift to a circular economy, and transportation development (Espegren et al. 2023). The model results provide a view of projected trends such as GDP development, labor change and value added across key sectors of the economy, and price and demand indices for energy commodities. The energy use by technologies has been often defined as “external”. This means that the projections of the energy mix in the economy towards 2050 are included in REMES-Norway as input data. This data is obtained by the output of the IFE-TIMES-Norway model in energy units (GWh/year). Nevertheless, the dataset used in the REMES-Norway model is measured in Million Euro per year. This means that a harmonization process is needed to make the data as compatible as possible. From the resulting outputs, no additional data feedback is provided back to the IFE-TIMES-Norway energy system model.

3 Socio-technical Scenarios Definition, Quantifications and Bottlenecks

This section presents a brief overview of the four transition pathways considered in the scenario analysis. These scenarios portray pathways with contrasting degrees of socio-institutional and technical change, as illustrated in Fig. 1. In the following sections, further description of the different scenarios is provided as well as an overview of key parameters quantified for each scenario. Further detail of these scenarios and quantification of input assumptions is provided in the project report for NTRANS (Espegren et al. 2023).

Minor <-----> Major Technological Change	Technological Substitution Pathway <ul style="list-style-type: none"> • Main technologies substituted • Competence destroying innovation • Existing institutional logic • Reorientation in capabilities • Incumbents are challenged 	Radical Transformation Pathway <ul style="list-style-type: none"> • Main technologies substituted • Competence destroying innovation • New institutional logic • Reorientation in capabilities and mindsets • Incumbents are severely challenged
	Incremental Innovation Pathway <ul style="list-style-type: none"> • Main technologies reinforced • Competence enhancing innovation • Existing institutional logic • Reorientation in routines • Incumbents not challenged 	Social Change Pathway <ul style="list-style-type: none"> • Main technologies reinforced • Competence enhancing innovation • New institutional logic • Reorientation in mindsets • Incumbents very challenged

Minor <-----> Architectural / Socio-institutional Change -----> Major

Fig. 1 Type of change and challenges at the system level in relation to the four scenarios. *Note:* Adapted from Espegren et al. (2023) and Andersen et al. (2023b)

3.1 Scenario Storylines

3.1.1 Incremental Innovation Pathway (INC)

The INC pathway depicts a scenario with gradual system change following the current technological and socio-institutional patterns. This pathway is not associated with major leaps in the developments of prospective technologies and could be seen as a continuation of current climate and energy policies, with steady population growth as per current projections, and societal focus on economic growth.

Resources used for energy production include global oil and gas (O&G), renewable energy, and biomass. There is an increasing energy demand, but also increased energy efficiency. Transport demand increases, with a focus on electrification and biofuels. The decarbonization of industry will largely depend on energy efficiency measures and electrification, with existing incumbents in the energy and industry sectors maintaining a central role.

Despite increasing awareness, incentives for environmental behavior remain weak, and people largely stick to their current lifestyles in terms of consumption, travel, and energy use. There are potential controversies and conflicts related to land use, sustainability concerns, capital and technology participation, and distributional and recognitional justice.

3.1.2 Technological Substitution Pathway (TECH)

The TECH pathway is characterized by a sudden pressure for change at the broader societal level, leading to development and deployment of new core technologies, but

less change in lifestyles. Moreover, population growth increases and the demands for energy and transport increase. Despite global O&G being used as feedstock for blue hydrogen production, renewable energy sources like floating offshore wind and biofuel production grow further. Alternative technologies and energy carriers like hydrogen, ammonia, batteries, and carbon capture and storage (CCS) become more available, opening routes for regionalization of existing industries.

Norway has niches in hydrogen, electrification, CCS, and hydrogen maritime technologies, providing an opportunity for the country to lead in these areas. However, potential social tensions, related to e.g., land use, sustainability contestation, and technology acceptance, may arise also in this scenario. Participation may also depend on capital and technology, raising issues of distributional and recognition justice.

3.1.3 Social Change Pathway (SOC)

The SOC pathway is associated with global conflict and unstable energy markets at the broader societal level and involves institutional changes reorienting from primarily economic growth towards sustainable well-being. There is a decrease in population growth due to less immigration. Due to social innovation and adoption of circular economy technologies and practices, more localized production networks and symbiotic innovations like automation become prevalent, reducing the demand for energy and global transport.

Core technologies are not replaced by new solutions to a large extent, hence emission reduction technologies such as energy efficiency, biofuels, battery-electric cars and vessels are implemented widely. Power generation experiences limited growth, and renewable energy and community-based solutions will be important. Existing incumbents in the industry face sharply increased CO₂ taxes and stronger disruptive policy measures than in INC and TECH.

The increased deployment of smart ICT-based solutions will be associated with energy use and lead to growth in e.g., data centers. However, Norwegian O&G production is expected to slow down and be shut down completely by 2034 due to climate concerns.

Potential Norwegian niches include smart transport solutions and digitalization. Circular bioeconomy innovation is also associated with green growth in some regions. The SOC pathway is characterized by increased environmental consciousness, leading to major changes in lifestyles, including less consumerism, less private ownership, more sharing and public services in transport, and a stronger focus on welfare and self-sufficiency.

3.1.4 Radical Transformation Pathway (RAD)

The RAD pathway is characterized by external shocks that trigger cascading disruption on multiple dimensions, involving major system change in both

technological and social dimensions. The economy shifts its focus to sustainable development and well-being, with global collaboration expected to decrease and regionalization becoming more prominent. System reconfiguring innovations, such as circular economy, integrated and flexible power systems, and local production, are highlighted.

Like the TECH pathway, the RAD pathway sees a strong increase in maturity and availability of alternative technologies and carriers, such as floating offshore wind, hydrogen, ammonia, batteries, and CCS. This opens routes for regionalization of existing industry, including electrification, hydrogen, and CCS use. Advanced bioenergy/biofuel production based on Norwegian resources are also in place.

The primary energy supply will mainly consist of renewable energy, and O&G production is phased out by 2050. The demand for energy and food stabilizes due to more sustainable lifestyles and increased focus on self-sustenance and circularity. There will be reduced demand for transport due to local production and less travel, as well as changing land use and densification in cities. The road sector sees less transport, more shared electric vehicles, and increased use of public transport, bikes, and walking. Potential Norwegian niches in the Radical Transformation Pathway include renewable hydrogen, Industry 5.0, CCS, and smart & digital solutions.

3.2 *Transition Bottlenecks*

A central idea in combining techno-economic modelling with socio-technical analysis for assessing feasibility of scenarios is to identify ‘transition bottlenecks’, which are tensions between scenarios developed by models and current developments analyzed with a sociotechnical transition perspective (Geels et al. 2020; Wachsmuth et al. 2023). This analytical exercise provides a broader socio-technical check on the scenarios and allows to provide additional insights on the conditions for specific transition scenarios, and thus their feasibility. Turnheim and Nyqvist (2019) suggests four dimensions where the theoretical potentials revealed by modelling may collide with the dynamics of real-world systems.

First, *maturity of options* points to whether an innovation in question is developed-enough at a given time to be able to perform the role suggested by a modelled scenario. Different decarbonization technologies have different degrees of maturity (e.g., the maturity of LNG vs. relative immaturity of ammonia as alternative fuels in shipping). However, the pace of development of yet immature solutions is not pre-determined but rather dependent on the unfolding systemic processes, such as various actors’ continued efforts to explore cost-quality improvements, market formation, and availability of resources for further development of innovations (Hekkert et al. 2007).

Second, novel innovations must *fit with* the other *socio-technical systems and infrastructure* (for example, power grids, transport infrastructure such as roads and ports, etc.). Actors may have to either design innovations to fit with the existing

systems and infrastructure, or the existing systems and infrastructure have to be fitted to innovations (Smith and Raven 2012; Bach et al. 2021), or more realistically, find a middle-ground between the two extremes. Such substantial change processes in large technical systems can be significant hurdles for innovation and time-demanding to carry out.

Third, innovations outlined by scenarios require *societal acceptability* to be adopted and to contribute to social sustainability. Acceptance may hinge on, e.g., the desirability of the modelled scenarios for the population, the perceived legitimacy of the actors pursuing the implementation of the scenarios, and the actual implementation of the scenarios (Turnheim and Nykvist 2019).

Fourth, fulfillment of scenarios may hinge on their *political feasibility*. This is related to, e.g., whether the kind of change in scenarios matches with the interests of powerful actors in politics, industry and civil society, and their vested interests (Normann 2015; Turnheim and Nykvist 2019).

3.3 Quantification of Socio-technical Transition Pathways

Based on the storylines provided in Sect. 3.1, key factors across each of the scenarios were mapped and parametrized as input assumptions in the energy system modelling analysis. The quantifications included technology specifications, limitations on energy production and transmission, energy demand developments per sector, availability of renewable fuels and end-use technologies, and varying investment costs corresponding to high or low technology learning rates.

An overview of the differences between the key assumptions in each scenario is provided in Fig. 2. For example, as mentioned in Sect. 3.1, lower technology learning is expected in INC and SOC and is portrayed with a lower bar, while high values are assigned to TECH and RAD since these pathways assume higher technology learning rates. These differences are further shown in the radar chart in Fig. 2 for other key input parameters, portraying the relative scale of the assumed values. In the case of hydrogen export, this is only seen under the TECH scenario which assumes that hydrogen export volumes are allowed, while the zero value in the other three scenarios denotes that no hydrogen exports are allowed. Further detail regarding the quantified values is provided in the NTRANS report (Espegren et al. 2023).

4 Results

This section describes the modelling results from the energy system and regional economic analysis applied to the scenarios priorly described in Sect. 3.

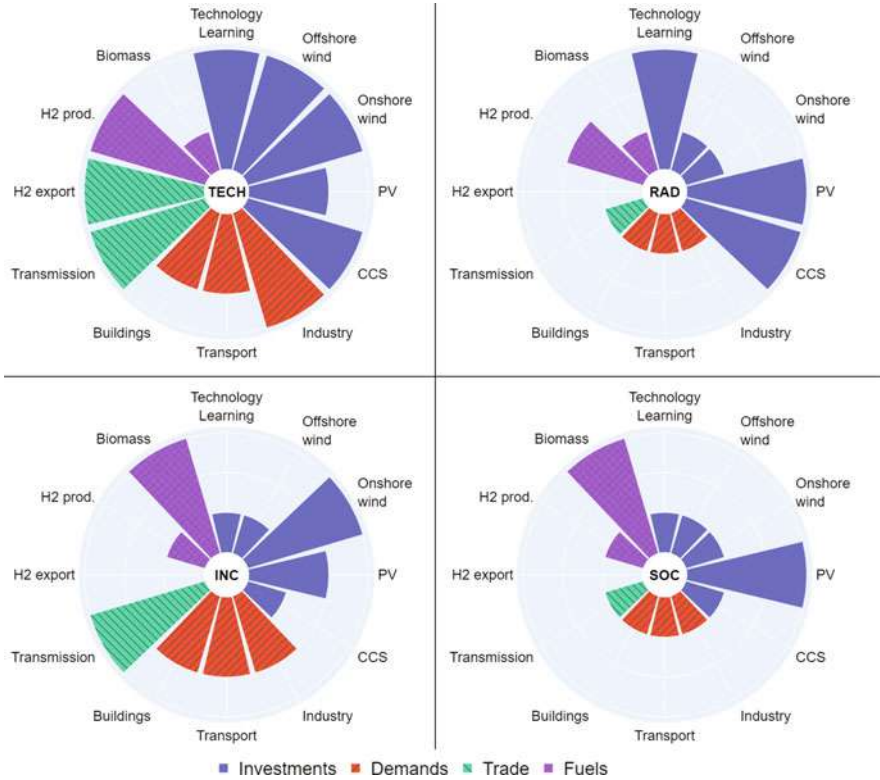

Fig. 2 Overview of differences between IFE-TIMES-Norway scenario assumptions. *Note:* The radar charts portray the varying levels relative to each of the key input assumptions in the scenario (i.e., low levels covering the innermost concentric axis, and high levels reaching the outermost concentric axis, and null values not displayed). The colors denote the inputs’ category. Based on the 2050 quantifications from NTRANS (Espregren et al. 2023) (Color figure online)

4.1 Techno-Economic Analysis

4.1.1 Power Generation and Trade

The power generation mix in Norway for each of the modelled scenarios is presented in Fig. 3. In the scenarios where energy service demands are projected to increase (i.e., INC and TECH), there’s a corresponding increase in total power generation. In these two scenarios, the onshore wind potentials (about 48 TWh) are fully utilized by 2050. Moreover, the increase in demand also drives up investments for other VRES, especially in the TECH scenario where electricity from offshore wind production covers the largest shares of the total power supply by 2050 (approximately 43%).

The generation mix sees increasing shares from offshore wind in both scenarios even though the two scenarios are characterized by contrasting technology learning

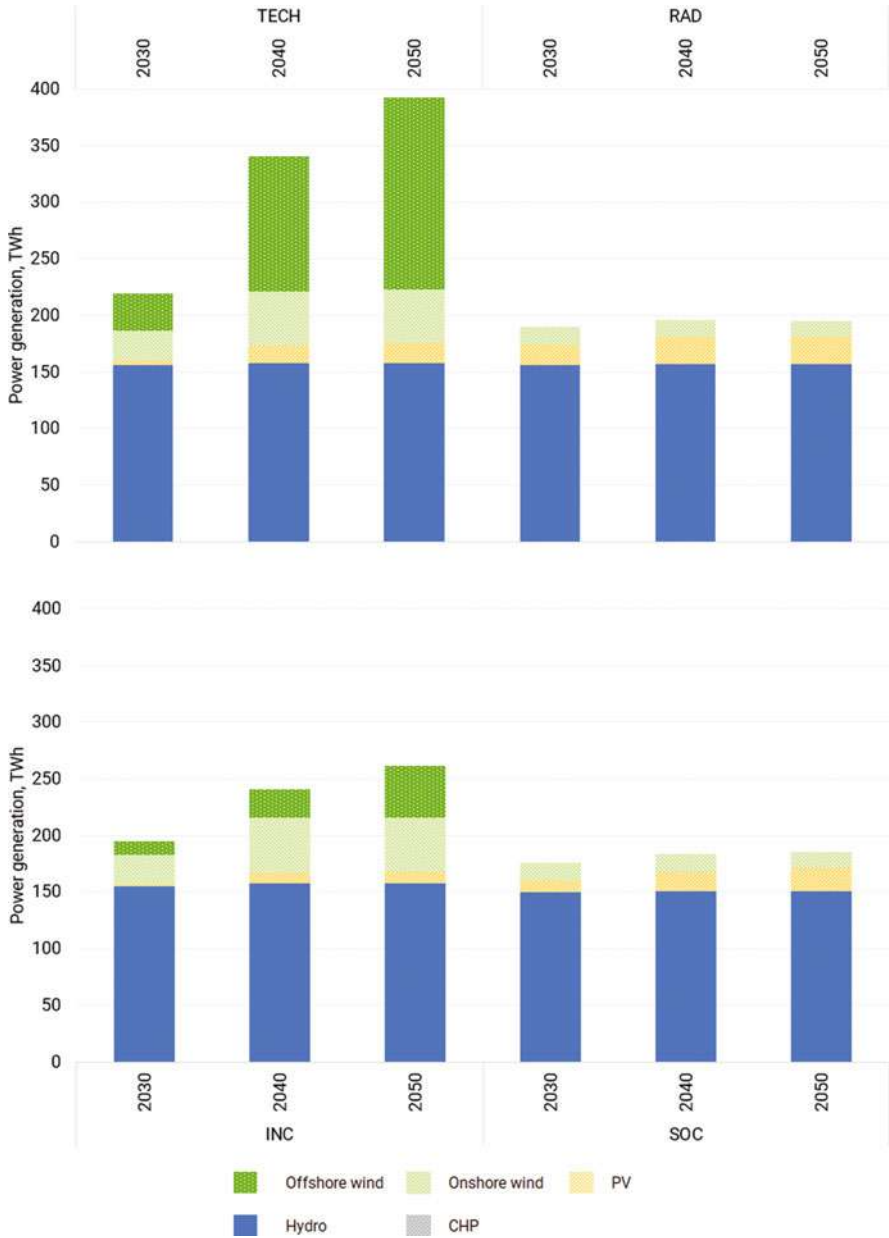

Fig. 3 Power generation (TWh/year) by technology for the four scenarios

rates to capture potential bottlenecks in technological development, with correspondingly higher investment cost assumptions in the INC scenario and lower costs in TECH. Due to common assumptions related to limited hydropower potential, the production volumes remain relatively constant across all four scenarios.

In contrast, the scenarios with low energy service demand—SOC and RAD—only see modest increases in the additional power generation required. In these scenarios, new production is expected mainly from PV applied in buildings covering about 11% of the supply mix by 2050, and only reinvestments in existing wind capacity. Offshore wind production does not play a significant role in the supply mix of either of these two scenarios, even in the case of the RAD scenario where high technology learning rates are assumed.

4.1.2 Transport Fuels

The energy consumption by carrier for the transport sector is presented in Fig. 4, showing the results for the four scenarios and two different CO₂ price assumptions. For all scenarios, a large share of the fuel consumption in 2030 consists of fossil fuels across different transport segments. In both the INC and SOC scenarios, fossil fuels are replaced mainly with biofuels by 2050, since no limitations in biofuel imports are considered in these two scenarios. The remainder of the transport sectors is decarbonized by electrifying the existing vehicle fleet. In TECH and RAD, electrification plays a larger role in replacing fossil fuel consumption with battery electric vehicles utilized when possible due to the high efficiency and technology learning. Meanwhile bioenergy is consumed as an intermediate replacement, showing less consumption by 2050 due to higher prices on biofuel imports. Emerging fuels like ammonia (NH₃) and hydrogen (H₂) also contribute to the sector's decarbonization, with increased uptake by 2050.

As seen in Fig. 4, imposing higher CO₂ prices accelerates the decarbonization of the sector. In the INC and SOC scenarios, this translates into earlier decarbonization achievable by 2040. Similarly, in the TECH and RAD scenarios, a faster uptake of carriers replacing fossil fuels is also projected, although a full decarbonization of the transport sector is not seen until 2050. Notably for both TECH and RAD, the high CO₂ prices enable a fully decarbonized transport sector, as opposed to the reference CO₂ price assumptions.

Given the dependency of biofuels in the INC and SOC, reaching a full decarbonization of the sector can be contingent to bioenergy availability and import prices as potential transition bottlenecks. As presented in Fig. 5, an increase of biofuel import prices comparable to the levels considered in the TECH and RAD scenario (i.e., an increase of 5 times relative to the reference value) limits the extent of the decarbonization even when considering the case of high CO₂ prices. Under a high biofuel price case, bioenergy replacements fall short while electrification and the use of hydrogen compensate as alternative fuel replacements.

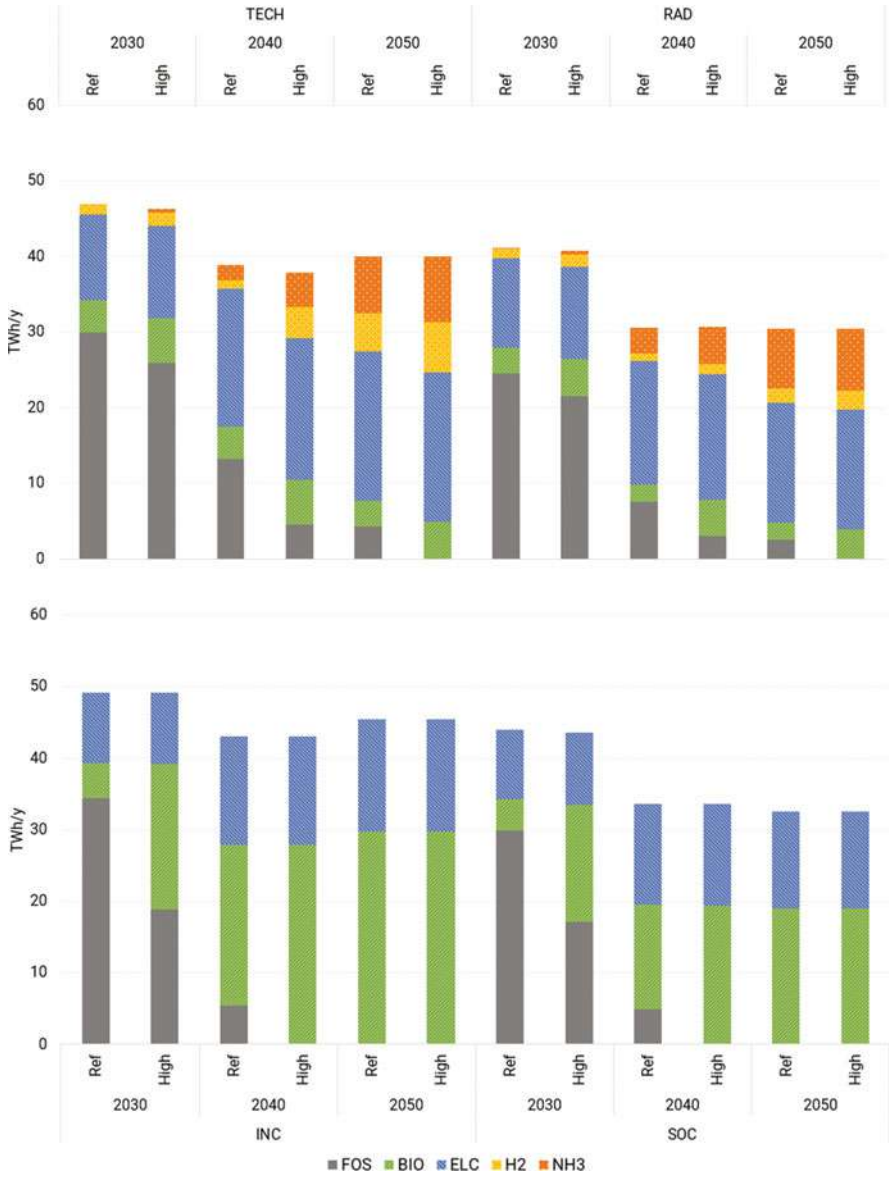

Fig. 4 Energy use in transport for the four scenarios considering different CO₂ prices (Reference-Ref- and a High CO₂ price). *Note:* It presents the values for fossil fuel (FOS), bioenergy (BIO), electricity (ELC), hydrogen (H₂) and ammonia consumption (NH₃)

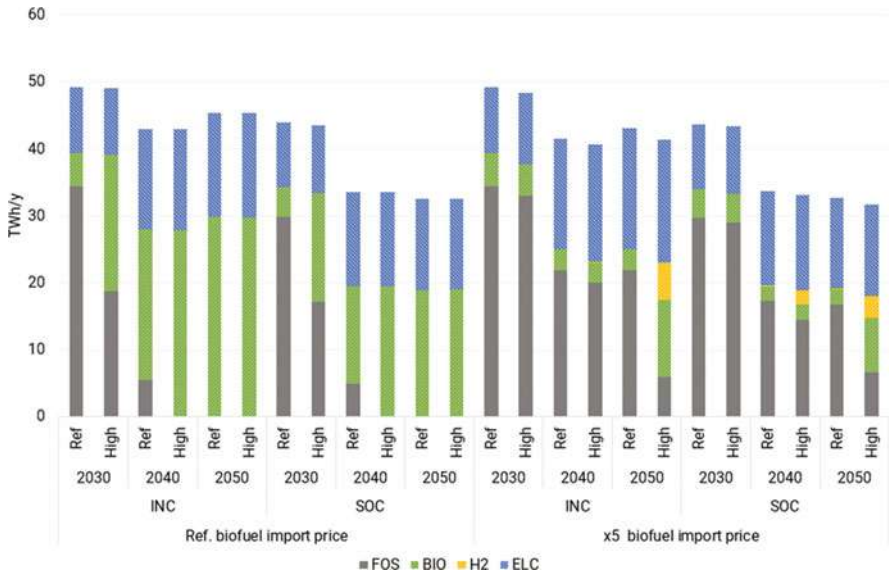

Fig. 5 Energy use in transport, considering different CO₂ prices (Ref. & High), and biofuel import prices

4.1.3 Hydrogen Supply

In the INC and SOC scenarios, hydrogen supplies about 5 TWh/year to cover demands in the industry sector with little change from 2030 to 2050. In contrast, the TECH and RAD scenarios see higher levels of hydrogen consumption—progressively increasing towards 2050—to cover end-use demands in industry and transport.

The TECH and RAD scenarios consider as base assumptions high levels of technology learning, which consequently contribute to a higher uptake of hydrogen utilization relative to the other scenarios due to lower investment costs in new capacity. However, bottlenecks in upscaling capacities and technological maturity might limit the uptake of hydrogen and new renewable capacity and are critical for these two scenarios. Therefore, lower technology learning (TL) rates—translating in higher investment costs—were considered as part of the sensitivity analysis. In Fig. 6, the results for the TECH and RAD scenarios are further explored.

Figure 6 shows how lower technology learning rates across the TECH and RAD scenario impact the production of both green and blue hydrogen, leading to lower overall hydrogen production levels. In 2050, this represents a reduction of about 34% and 9% for the TECH and RAD scenarios, respectively.

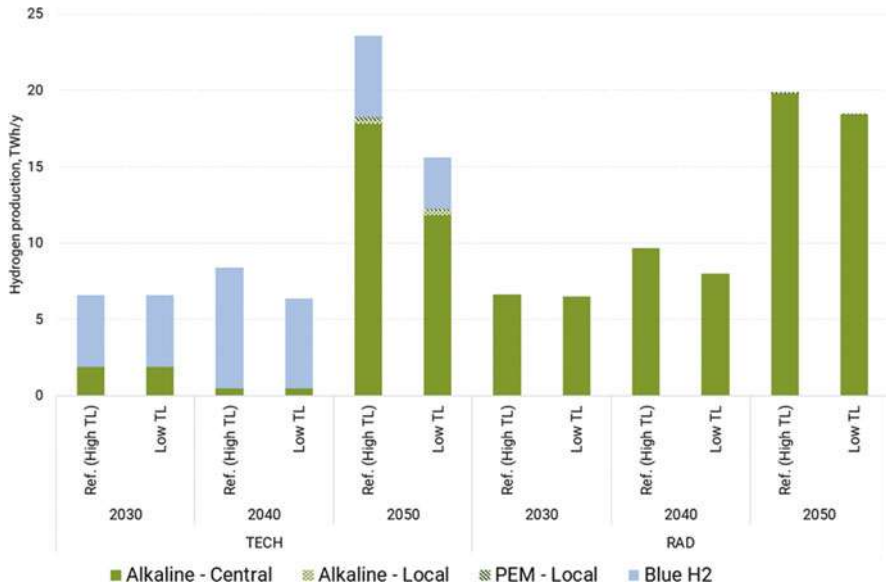

Fig. 6 Hydrogen supply by production technology from both central and local plants. *Note:* It includes alkaline and proton exchange membrane (PEM) electrolysis, and blue hydrogen from autothermal reforming (excluding Blue H₂ produced for export)

4.1.4 CO₂ Emissions

By 2050, all four scenarios present significant CO₂ emission reductions compared to 2018 (42.76 Mton/y), spanning a range of around 87–96% considering the respective reference assumptions for each scenario and CO₂ price assumption. As seen in Fig. 7, the industry sector has the highest emission contributions in 2050 for all scenarios, while only some emissions remain from district heating plants. For the TECH and RAD scenarios, which include larger CCS options and diverse green fuel replacements, the emissions from industry are decreased further than in the INC and SOC scenarios with less potential for industrial CCS or hydrogen.

The transport sector is fully decarbonized in the INC and SOC scenarios, due to unlimited use of bioenergy products at a moderate cost. Given the higher bioenergy costs in the TECH and RAD, the reference CO₂ cost applied in the scenarios is not sufficient to make it profitable to import bioenergy or achieve full replacement of fossil fuels with other technologies. Hence, emissions remain in the sea and air transport segments. However, when considering higher CO₂ prices, the decarbonization is accelerated across all scenarios. In the TECH and RAD scenario, additional levels of decarbonization are also unlocked leading to lower emissions in industry and driving further fuel replacements in sea and air transport towards a full decarbonization of the sector.

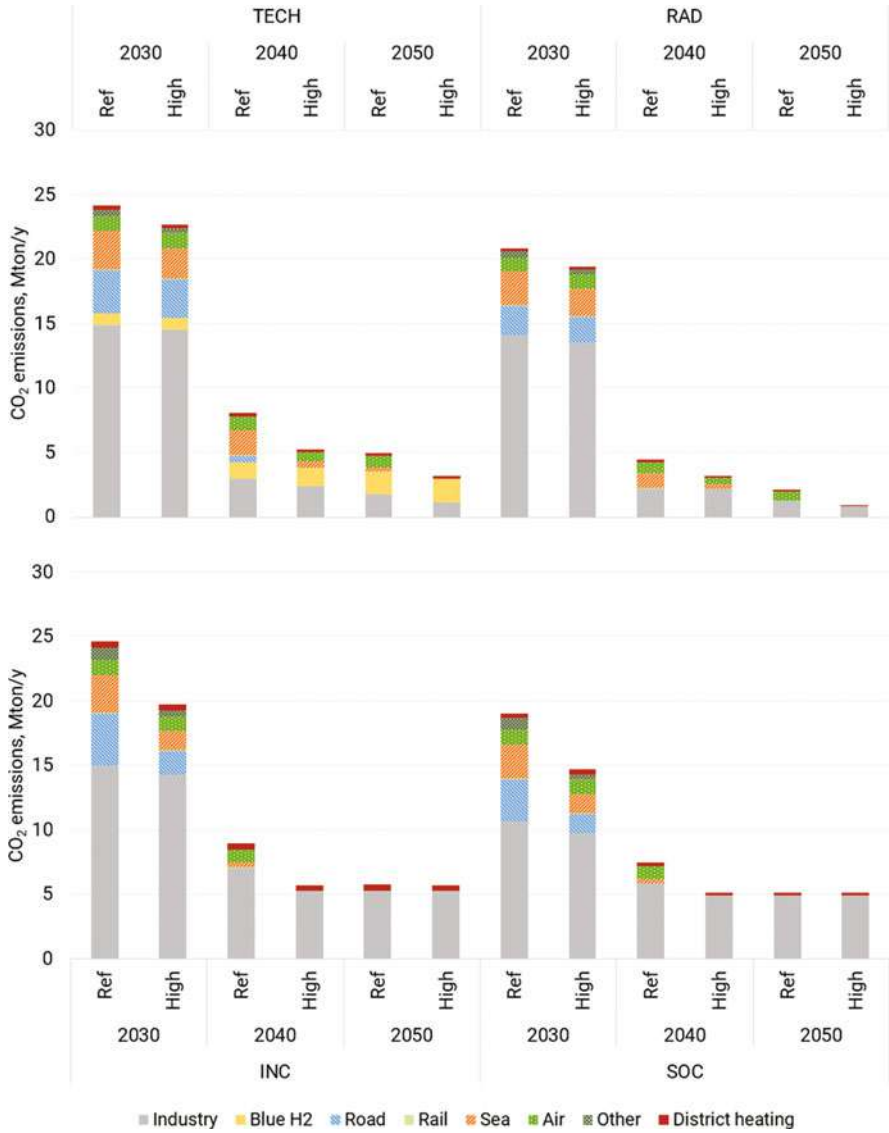

Fig. 7 CO₂ emissions by end-use for each scenario, considering different CO₂ price assumptions (Ref., & High CO₂ prices)

4.2 Regional Economic Analysis

The typical economic growth pattern of the NTRANS low carbon scenarios, as compared to a reference scenario, considers an initial decline in GDP growth due to

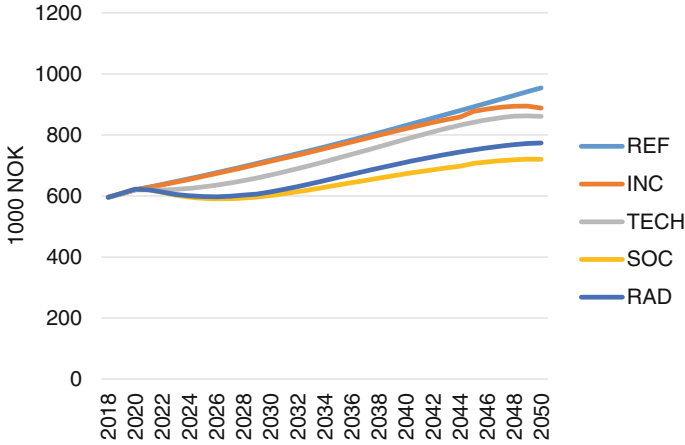

Fig. 8 Development of GDP per capita under the reference scenario and the alternative scenarios

the decline in value added for the O&G sectors, followed by a gradual improvement of the growth achieved due to the greater availability of capital, leading to large investments in industry and services. This is showcased in Fig. 8, as GDP per capita for all scenarios. The INC scenario mostly aligns to the reference scenario including continuous O&G extraction, presenting only marginally smaller differences. Economic growth decreases towards 2050 due to stricter decarbonization requirements and higher costs for sectors to reduce emissions.

The TECH scenario has a more pronounced decrease in O&G exports, with oil extraction decreasing by around 90% domestically and gas usage increasing in chemicals and blue hydrogen production. This faster phase-out leads to a greater decrease in GDP in the short run. However, due to improvements in industrial productivity, widespread adoption of hydrogen and the implementation of carbon capture and storage (CCS) in industry, the scenario aligns closer with the INC scenario.

In contrast, the SOC and RAD scenarios have a different economic focus based on societal change, and thus lower GDP levels compared to the Reference scenario. These two scenarios' weaker growth is primarily the result of lower labor productivity and a strong phase-out of O&G. Productivity loss under the RAD scenario is slightly mildened by the increase in industrial productivity and the use of CCS in industry.

The two largest contributors to the GDP are the industry and services segments (shown in Fig. 9). For industry, the construction sector represents its main value driver, performing particularly weakly under the SOC scenario. Growth in the construction sector slows due to reduced labor productivity, higher labor costs, and stagnant demand from a non-growing population leading to increased production costs and lower demand. Despite expensive labor and lower demand growth, the construction sector's reliance on less costly energy and materials allows it to expand,

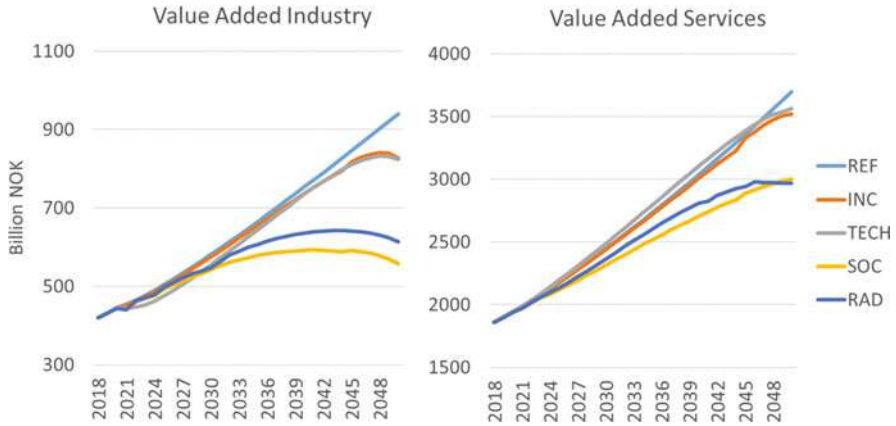

Fig. 9 Value added for the industry and service segments under the reference scenario and the alternative scenarios

albeit less than in the Reference scenario. Other industrial sectors, with a significant portion of costs tied to energy, face more substantial impacts due to decarbonization costs and rising wages on top of inherently declining demand. Notably, under SOC and RAD scenarios, the shift towards a circular economy model further reduces consumption. As a result, industrial value-added peaks around 2040, falling thereafter. Meanwhile, the INC and TECH scenarios, present a trend closer to the reference with a more moderate decline towards 2050.

The service segment’s reaction to the changes in the SOC and RAD scenarios is less severe than that of industry. Within services sectors, the lower general economic growth decreases the speed of capital formation and investments in some sectors, like administrative services, by 2050. Lower economic activity under SOC and RAD leads to reduced labor demand compared to INC and TECH.

Under these scenarios, sectors capable of substituting labor for capital take advantage of lower wages to increase workforce and reduce capital dependence. Increased household consumption of services, driven by interest in a circular economy, softens the demand decrease due to the stagnating population and the general lack of focus on growth, allowing these sectors to maintain higher prices, albeit demand remains below the Reference scenario levels. In contrast, the TECH and INC scenarios, see an increased service production and labor demand.

In the majority of the sectors, the demand for labor under each scenario is anticipated to be lower than under the reference scenario (Fig. 10). When it comes to industries that make up the largest portion of employment and contribute significantly to overall growth, like industry or services, the TECH scenario manages to maintain an employment level that is comparable to the one in the Reference scenario.

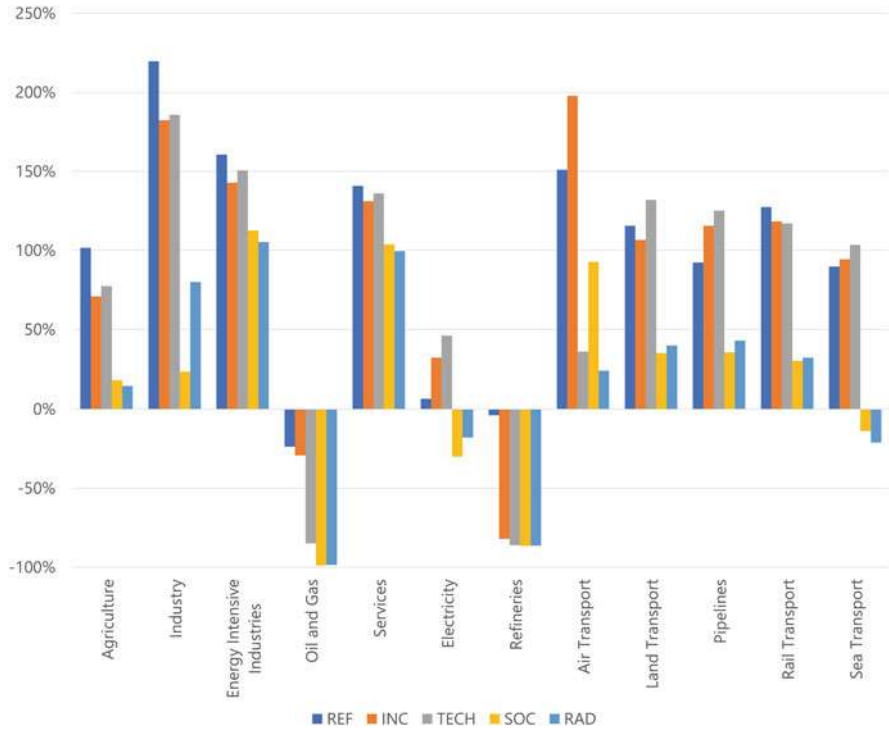

Fig. 10 Labor demand change compared to 2018 under the different scenarios

5 Discussion

The developments across the four scenarios facilitate different degrees of decarbonization towards 2050 in direct alignment with developing a clean energy system (SDG 7) and undertaking climate action (SDG 13). The scenarios, also portray the buildup of new infrastructure and emerging technical innovations (in line with SDG 9). As embodied by the RAD scenario, a combination of both major technological and socio-institutional change is required to enable the highest degrees of decarbonization and meet national targets (Regjeringen 2022b), i.e., 55% emission reductions by 2030 relative to 1990 levels (which are reported at around 51.5 million tons of CO₂). Enabling more ambitious reductions, as explored in the results, could require setting higher CO₂ prices, or other measures, to be well within said targets.

As mentioned, these reductions will also be conditioned by changes in behavior and lifestyle (aligned to responsible consumption, i.e., SDG 12), and emphasis on self-sustenance, circularity and local production and consumption (SDG 9). Intrinsically, the degree of change in those dimensions will yield different levels of

economic growth and labor (SDG 8), as observed in the results of the economic analysis. Thus, the tradeoffs between prioritizing specific targets and development goals must be considered and put into perspective as part of the scenario analysis, which can then provide insight for distinct policy and societal preferences.

The scenarios may be slowed down by transition bottlenecks related to the crucial feasibility dimensions identified in Sect. 3.3: (1) the maturity of options, (2) system integration and infrastructure requirements, (3) societal acceptability, and (4) political feasibility (Turnheim and Nykvist 2019). The large-scale development of onshore and especially offshore wind in the TECH scenario is likely to meet challenges in terms of societal acceptance, related to “not in my backyard” (NIMBY) attitudes, competition with other marine activities such as fishing, shipping, leisure, and/or military activities. Although the need for a green transition may result in prioritization of windfarms, a legal solution for these tensions has not yet been found. Moreover, there may be potential conflicts with indigenous rights and the increasing focus on biodiversity and conservation in sustainable development policies. Distribution to shore and on land, as well as infrastructure for export, may also be associated with controversies.

Another issue in TECH, and to some extent in RAD scenario, is that some of the core solutions, such as hydrogen or floating offshore wind, are immature and the pace of their development is uncertain, due to yet underdeveloped industrial structures, technological knowledge, and institutions, e.g., in terms of regulations and cultural perceptions. This calls for adding time, cost and uncertainty while assessing the development and deployment of said technologies. This was captured in the techno-economic analysis, e.g., for hydrogen, by adapting the corresponding assumptions which yielded lower production volumes of blue and green hydrogen. Naturally, this has broader implications regarding potential exports and the need for diversifying the fuel supply with other alternatives like biofuels, electrification, or small shares of fossil fuels which themselves can be subject to additional constraints.

Likewise, the emergence of multiple, partly synergetic and partly competing solutions, creates uncertainty among actors, who fear lock-in to first generation technologies and in some cases postpone investment decisions in anticipation of stronger policy or market signals. In turn, uncertainty regarding supply and demand balance is associated with so-called chicken-or-the-egg dilemmas. Moreover, the development of necessary renewable energy infrastructure to power the production of alternative fuels may be considered as a transition bottleneck. Even though huge power grid investments are planned towards 2030 and measures to reduce the lead time have been proposed, it may take several years to get the capacity needed to electrify, set up, or expand alternative fuel production in a specific location. These factors may slow down transitions considerably. Similarly, Norway and Europe’s reliance on import of critical raw materials required for the development and upscaling of new technologies should be considered and addressed, with a view to the current geo-political context.

A crucial bottleneck, especially for SOC, but also for the RAD scenario, is the lack of political will to shut down oil and gas in Norway. Contrary to the recommendation from a government-appointed climate committee (Klimautvalget 2023)

the present government will not provide a closing strategy for the petroleum sector, but rather facilitate continued investments (Dagavisen 2023). Another critical factor (also relevant for the INC scenario) is the geo-spatial distribution and overall availability of biomass for energy. While multiple national initiatives to produce sustainable biofuels may reduce Norway's current biofuel imports, the costs are high; and, in a global long-term perspective, the demand for sustainable biomass is likely to exceed the supply (Kircher 2022). As explored in the techno-economic analysis, even higher costs, and limited availability of biofuels in INC and SOC, would imply relying on other alternatives such as electrification, hydrogen, but also hindering decarbonization efforts by extending fossil fuel use.

Meanwhile, both the SOC and RAD scenarios are dependent on significant demand reductions, linked to circularity, localization, and underlying lifestyle changes towards sufficiency. These may be politically difficult to foster actively unless strong grassroots movements and changes in public opinion form.

Despite shifts in technologies and changes in demand trends, all four scenarios show sustained levels of GDP and value-added growth as per the regional-economic analysis. However, higher levels of economic growth under certain scenarios, are not always aligned to higher degrees of decarbonization as illustrated by the RAD and SOC scenarios with contrasting metrics in these two dimensions. This highlights the need for developing transition pathways, that balance both ambitious decarbonization strategies and policy with economic growth for society.

While the scenario storylines include elements and quantifications specific to the Norwegian energy transition, the embedded considerations related to the degree of change and general challenges at the system level can be applied and contextualized to other areas. Meanwhile, analogous national modelling analyses can also be found in the ever-growing field of energy planning. Thus, the overall approach and methodology taken in the present study—linking socio-technical transition research in the scenario design with modelling analyses—could be replicated and adopted in other countries or regions.

6 Conclusion

This study presents an interdisciplinary approach to holistically analyze potential pathways for Norway's energy transition. The analyses link socio-technical transition research and modelling of the Norwegian energy system and the economy. These complementary perspectives provide valuable insight by capturing key considerations affecting the feasibility of the scenarios, and identifying critical issues that could slow down the transition towards a low-carbon future. Furthermore, the scenarios also illustrate that to reach ambitious levels of decarbonization across all sectors, a high degree of change will be needed in society and technological development, which will be accompanied by varying degrees of economic growth.

The energy system analysis shows that in the scenarios with minor socio-institutional change, where higher energy demands and electricity trade is expected,

new additional renewable capacity will be needed for power generation despite potential bottlenecks affecting technology costs. However, the uptake of other new emerging technologies and fuel replacements (e.g., hydrogen, ammonia) across key sectors will be more likely when considering the scenarios with major technological change. On the other hand, minor technological change leads to decreasing but continued use of fossils and higher reliance on electrification and fuel replacements with biofuels. The role of these technologies and carriers will, however, be susceptible to the degree of technological maturity, resource availability, and policies in place.

Finally, the regional economic analysis shows that across all four scenarios—despite a slowdown compared to the reference case—economic growth can be expected. The growth in GDP and labor demand is closer to the reference in the cases with minor socio-institutional change, and lower in the scenarios with major change in this dimension. This illustrates a key tradeoff in the transition pathways, where higher degrees of decarbonization with sustainable energy sources can be realized, while balancing economic growth and societal development.

Acknowledgements This work received funding from FME NTRANS, grant number 296205, supported by the Research Council of Norway.

References

- Andersen AD, Geels FW et al (2023a) Faster, broader, and deeper! Suggested directions for research on net-zero transitions. *Oxford Open Energy* 2:oiad007. <https://doi.org/10.1093/ooenergy/oiad007>
- Andersen AD, Markard J et al (2023b) Architectural change in accelerating transitions: actor preferences, system architectures, and flexibility technologies in the German energy transition. *Energy Res Soc Sci* 97:102945. <https://doi.org/10.1016/j.erss.2023.102945>
- Bach H et al (2021) Blending new and old in sustainability transitions: technological alignment between fossil fuels and biofuels in Norwegian coastal shipping. *Energy Res Soc Sci* 74: 101957. <https://doi.org/10.1016/j.erss.2021.101957>
- Bolwig S et al (2019) Review of modelling energy transitions pathways with application to energy system flexibility. *Renew Sust Energy Rev* 101:440–452. <https://doi.org/10.1016/j.rser.2018.11.019>
- Chang M et al (2021) Trends in tools and approaches for modelling the energy transition. *Appl Energy* 290:116731. <https://doi.org/10.1016/j.apenergy.2021.116731>
- Chang M et al (2023) Perspectives on purpose-driven coupling of energy system models. *Energy* 265:126335. <https://doi.org/10.1016/j.energy.2022.126335>
- Dagavisen (2023) Støre avviser plan om utfasing av olje i Norge, 11 May. <https://www.dagsavisen.no/rogaland/savis/nyheter/2023/11/05/store-avviser-plan-om-utfasing-av-olje-i-norge/>. Accessed 11 Jul 2023
- Espregren KA et al (2023) NTRANS Socio-technical pathways and scenario analysis FME NTRANS (n.d.) NTRANS – Norwegian Centre for Energy Transition Strategies. <https://www.ntnu.edu/ntrans/ntrans>. Accessed 18 Sept 2023
- Freeman R, Pye S (2022) Socio-technical modelling of UK energy transition under three global SSPs, with implications for IAM scenarios. *Environ Res Lett* 17(12). <https://doi.org/10.1088/1748-9326/aca54f>

- Geels FW, Berkhout F, Van Vuuren DP (2016) Bridging analytical approaches for low-carbon transitions. *Nat Clim Chang* 6(6):576–583. <https://doi.org/10.1038/nclimate2980>
- Geels FW, McMeekin A, Pfluger B (2020) Socio-technical scenarios as a methodological tool to explore social and political feasibility in low-carbon transitions: bridging computer models and the multi-level perspective in UK electricity generation (2010–2050). *Technol Forecast Soc Chang* 151:119258. <https://doi.org/10.1016/j.techfore.2018.04.001>
- Haaskjold K, Rosenberg E, Seljom P (2023) Documentation of IFE-TIMES-Norway v3. IFE/E;2022/013. <https://hdl.handle.net/11250/3058964>
- Hainsch K et al (2022) Energy transition scenarios: what policies, societal attitudes, and technology developments will realize the EU Green Deal? *Energy* 239:122067. <https://doi.org/10.1016/j.energy.2021.122067>
- Hekkert MP et al (2007) Functions of innovation systems: a new approach for analysing technological change. *Technol Forecast Soc Chang* 74(4):413–432. <https://doi.org/10.1016/j.techfore.2006.03.002>
- Helgesen PI et al (2018) Using a hybrid hard-linked model to analyze reduced climate gas emissions from transport. *Energy* 156:196–212. <https://doi.org/10.1016/j.energy.2018.05.005>
- Hirt LF et al (2020) A review of linking models and socio-technical transitions theories for energy and climate solutions. *Environ Innov Soc Trans* 35(March):162–179. <https://doi.org/10.1016/j.eist.2020.03.002>
- IPCC (2022) Climate change 2022 – mitigation of climate change – summary for policymakers – working group III contribution to the sixth assessment report of the intergovernmental panel on climate change. www.ipcc.ch
- Kircher M (2022) Economic trends in the transition into a circular bioeconomy. *J Risk Fin Manag* 15(2):44. <https://doi.org/10.3390/jrfm15020044>
- Klimautvalget (2023) Omstilling til lavutslipp – Veivalg for klimapolitikken mot 2050
- Köhler J et al (2019) An agenda for sustainability transitions research: state of the art and future directions. *Environ Innov Soc Trans* 31:1–32. <https://doi.org/10.1016/j.eist.2019.01.004>
- Krumm A, Süsler D, Blechinger P (2022) Modelling social aspects of the energy transition: what is the current representation of social factors in energy models? *Energy* 239:121706. <https://doi.org/10.1016/j.energy.2021.121706>
- Li FGN, Trutnevte E, Strachan N (2015) A review of socio-technical energy transition (STET) models. *Technol Forecast Soc Chang* 100:290–305. <https://doi.org/10.1016/j.techfore.2015.07.017>
- Loulou R et al (2016) Documentation for the TIMES model. IEA-ETSAP. https://iea-etsap.org/docs/Documentation_for_the_TIMES_Model-Part-I_July-2016.pdf
- Markard J, Raven R, Truffer B (2012) Sustainability transitions: an emerging field of research and its prospects. *Res Policy* 41(6):955–967. <https://doi.org/10.1016/j.respol.2012.02.013>
- Nilsson M et al (2020) A bridging framework for studying transition pathways—from systems models to local action in the Swedish heating domain. *Technol Forecast Soc Chang* 151:119260. <https://doi.org/10.1016/j.techfore.2018.04.003>
- Normann HE (2015) The role of politics in sustainable transitions: the rise and decline of offshore wind in Norway. *Environ Innov Soc Trans* 15:180–193. <https://doi.org/10.1016/j.eist.2014.11.002>
- Prina MG et al (2020) Classification and challenges of bottom-up energy system models – a review. *Renew Sust Energ Rev* 129:109917. <https://doi.org/10.1016/j.rser.2020.109917>
- Regjeringen (2022a) Karbonprisbaner for bruk i samfunnsøkonomiske analyser. <https://www.regjeringen.no/no/tema/okonomi-og-budsjett/statlig-okonomistyring/karbonprisbaner-for-bruk-i-samfunnsokonomiske-analyser/id2878113/>. Accessed 21 Sept 2023
- Regjeringen (2022b) Norway's climate action plan for 2021–2030. Norwegian Ministry of Climate and Environment. <https://www.regjeringen.no/contentassets/a78ecf5ad2344fa5ae4a394412ef8975/en-gb/pdfs/stm202020210013000engpdfs.pdf>

- Rogge KS, Pfluger B, Geels FW (2020) Transformative policy mixes in socio-technical scenarios: the case of the low-carbon transition of the German electricity system (2010–2050). *Technol Forecast Soc Chang* 151:119259. <https://doi.org/10.1016/j.techfore.2018.04.002>
- Smith A, Raven R (2012) What is protective space? Reconsidering niches in transitions to sustainability. *Res Policy* 41(6):1025–1036. <https://doi.org/10.1016/j.respol.2011.12.012>
- Süsser D et al (2022) Why energy models should integrate social and environmental factors: assessing user needs, omission impacts, and real-word accuracy in the European Union. *Energy Res Soc Sci* 92:102775. <https://doi.org/10.1016/j.erss.2022.102775>
- Trutnevyte E et al (2019) Societal transformations in models for energy and climate policy: the ambitious next step. *One Earth* 1(4):423–433. <https://doi.org/10.1016/j.oneear.2019.12.002>
- Turnheim B, Nykvist B (2019) Opening up the feasibility of sustainability transitions pathways (STPs): representations, potentials, and conditions. *Res Policy* 48(3):775–788. <https://doi.org/10.1016/j.respol.2018.12.002>
- Turnheim B et al (2015) Evaluating sustainability transitions pathways: bridging analytical approaches to address governance challenges. *Glob Environ Chang* 35:239–253. <https://doi.org/10.1016/j.gloenvcha.2015.08.010>
- UN (2023) The sustainable development goals report. United Nations (UN). <https://unstats.un.org/sdgs/report/2023/>
- van Sluisveld MAE et al (2020) Aligning integrated assessment modelling with socio-technical transition insights: an application to low-carbon energy scenario analysis in Europe. *Technol Forecast Soc Chang* 151:119177. <https://doi.org/10.1016/j.techfore.2017.10.024>
- Wachsmuth J et al (2023) Co-creating socio-technical scenarios for net-zero emission pathways: comparison of five national case studies. *Renew Sustain Energy Trans* 4:100064. <https://doi.org/10.1016/j.rset.2023.100064>
- Werner A et al (2017) REMES – a regional equilibrium model for Norway with focus on the energy system. <http://hdl.handle.net/11250/2434516>

Open Access This chapter is licensed under the terms of the Creative Commons Attribution 4.0 International License (<http://creativecommons.org/licenses/by/4.0/>), which permits use, sharing, adaptation, distribution and reproduction in any medium or format, as long as you give appropriate credit to the original author(s) and the source, provide a link to the Creative Commons license and indicate if changes were made.

The images or other third party material in this chapter are included in the chapter's Creative Commons license, unless indicated otherwise in a credit line to the material. If material is not included in the chapter's Creative Commons license and your intended use is not permitted by statutory regulation or exceeds the permitted use, you will need to obtain permission directly from the copyright holder.



Part III
Informing Energy Security with Energy
System Models

Modelling of Demands of Selected Minerals and Metals in Clean Energy Transition with 1.5–2.0 °C Mitigation Targets



Tiina Koljonen, Antti Lehtilä, Kirsikka Kiviranta, Kati Koponen,
and Lassi Similä

Abstract Tackling climate change and the transition to a low-carbon energy system will especially increase the demand for certain minerals and metals, such as cobalt, copper, lithium and rare-earth elements. This raises questions about possible constraints to a clean energy system transition. Environmental and social concerns have also been raised about mining for these minerals in the Global South region. This chapter explores the future demand for selected minerals and metals in long-term scenarios for the global energy system until 2100. The climate policy pathways follow UNFCCC Nationally Determined Contributions (NDCs), extrapolated until 2100, and immediate action towards limiting warming to 1.5–2 °C. The scenarios have been modelled with the TIMES-VTT Integrated Assessment Model, which includes data on metal demands for renewable energy technologies, carbon capture and storage (CCS) power plant technologies (both fossil and bioenergy with CCS), nuclear power, battery technologies, electrolyzers, and electric vehicles. Our results suggest that to ensure affordable and clean energy access for all (SDG7) along with climate action (SDG13) the demand for mining activities in the Global South will increase rapidly, which raises concerns about inequalities between countries (SDG10). We need socially inclusive solutions and public-private partnerships to make sure that everyone benefits throughout the value chains. Human rights, safe working conditions, and the protection of the local environment in the Global South must be constantly audited to ensure a sustainable transition to clean energy systems.

Key Messages

- In the clean energy transition, cobalt and dysprosium may be among the most critical metals in terms of resource sufficiency. Global cumulative consumption

T. Koljonen (✉) · A. Lehtilä · K. Koponen · L. Similä
VTT Technical Research Centre of Finland Ltd., Espoo, Finland
e-mail: tiina.koljonen@vtt.fi; antti.lehtila@vtt.fi; kati.koponen@vtt.fi; lassi.simila@vtt.fi

K. Kiviranta
VTT Technical Research Centre of Finland Ltd., Oulu, Finland
e-mail: kirsikka.kiviranta@vtt.fi

© The Author(s) 2024

M. Labriet et al. (eds.), *Aligning the Energy Transition with the Sustainable Development Goals*, Lecture Notes in Energy 101,
https://doi.org/10.1007/978-3-031-58897-6_10

225

of cobalt overshoots its identified resources by 2100 without substantive recycling and substitution.

- Integrated Assessment Modelling can help assess the demands of the most critical minerals and metals in the clean energy transition and evaluate direct risks in climate action, affordable clean energy, and reduced inequalities in the Global South region, where the largest resources exist.
- The novelty of this study is its long-term perspective (2100) and the consideration of mineral and metal demands for a wide technology portfolio, including negative emissions technologies.
- Rapid expansion of battery metal demands calls for immediate actions to address human rights issues in global mineral supply chains (SDG10).

1 Introduction

Global material extraction, including biomass, fossil fuels, metal ores and minerals, has been deeply coupled with the growth of global gross domestic product (GDP). Between 1970 and 2017, per capita GDP more than doubled and material use grew by around two-thirds (UNEP 2019). The OECD (2019) has estimated that global primary materials use may almost double from 89 gigatonnes (Gt) in 2017 to 167 Gt in 2060. Non-metallic minerals represent the largest share, but metal use is projected to grow even more rapidly. Many recent studies (Watari et al. 2019; The World Bank 2017, 2020; Carrara et al. 2020; IEA 2021a, 2023b; Gielen 2021) have shown that the transition towards global climate change mitigation targets increases the demand for different minerals and metals because of the replacement of old infrastructures and the increased metal intensities of clean energy technologies. According to IEA (2021a), since 2010 the average amount of metallic minerals needed for a new unit of power generation capacity has increased by 50% as the share of renewables has risen. Claderon et al. (2024) highlighted the lack of analysis on the ability to meet these demand estimates. However, in most of the climate change mitigation scenarios the supply and demand of these materials are typically neglected, including the most recent assessment report of the Intergovernmental Panel on Climate Change (IPCC 2022).

Environmental, social, and supply risk concerns have been raised about mining and processing of minerals and metals in the Global South needed for the clean energy transition. For example, above 70% of the global cobalt is mined in the Democratic Republic of Congo (DRC), where severe human rights and environmental challenges in mining operations have been reported (IEA 2023a; UNCATD 2020). IEA (2023a) has also reported concerns due to China's increasing role in supply. For example, China produces 70% and processes 90% of rare earth metals. For cobalt, China is the major processor with over 75% of refined cobalt output in 2022.

In this chapter, the impacts on the global demand and supply of minerals and metals critical to climate change mitigation are studied using the global TIMES-VTT

Integrated Assessment Model (IAM). The analysis is based on our earlier studies on global mitigation scenarios (Lehtilä and Koljonen 2018; Koljonen and Lehtilä 2012). In this study, we have updated the TIMES-VTT database with the most recent literature and data on mineral and metal intensities of clean energy technologies. The raw materials of interest are selected based on literature and our earlier studies (Grandell et al. 2016). Many of the earlier studies on mineral and metal demands have primarily focused on electrification of the energy system with renewable energy technologies (Gielen 2021; IEA 2021a, 2023a). The added value of this study is its effort to explore the impacts brought by negative emissions technologies and practises (NETPs) as a novel element for the assessments to reach the 1.5–2.0 °C mitigation target. As an outcome, new assessments on metal demands compared with critical mineral resources by 2100 are modelled with a wider technology portfolio under study. The results for climate action (SDG13) and affordable clean energy (SDG7) are highlighted against the concerns on inequalities (SDG10), clean water (SDG7), and responsible consumption and production (SDG12).

2 Overview of Input Data Formulation on Minerals and Metals and Modelling Approach

2.1 Data Formulation for Demands of Selected Minerals and Metals

The following technologies have been selected for the critical raw materials evaluation: wind power, solar photovoltaics, concentrating solar power, geothermal, hydropower, solid and gaseous fossil fuel- and biomass based combustion with and without carbon capture and storage (CCS), biofuels, nuclear power, electric vehicle batteries and motors, and electrolyzers. For bioenergy with carbon capture and storage (BECCS) we have used the metal demand data for fossil energy with CCS due to limited information on metal demands of BECCS. In the scenario modelling, direct air capture of carbon dioxide and storage (DACCS), biochar produced by pyrogenic carbon capture and storage (PyCCS), reforestation/afforestation, soil carbon sequestration, enhanced weathering, and ocean liming are included in the modelling, but without specific metal demand assessments. However, their application can indirectly impact the metal demands, e.g., through reduced demand for other mitigation measures or increased energy inputs. The mineral and metal intensity data is typically expressed by the amount of minerals and metals needed to build a gigawatt of capacity, in tonnes per gigawatt (t/GW). The metal intensity data used in this study is based on mineral and metal intensity estimates collected from several publicly available studies. In addition to the metal demand of the assessed technologies, the shares of potential sub-technologies, metal intensity improvements and plant lifetimes have been taken into account in the scenario modelling. Table 1 describes the summary of the selected technologies in our analysis and the reference sources for their mineral and/or metal intensities.

Table 1 Covered technologies in scenario analysis and reference sources for their mineral and/or metal intensities

Technology	References
Wind power	Carrara et al. (2020), IEA (2021a)
Solar photovoltaics (PV)	Carrara et al. (2020), IEA (2021a)
Concentrated solar power (CSP)	Watari et al. (2019)
Geothermal	Moss et al. (2011)
Hydropower	Ashby (2013)
Biomass-based combustion and biofuels	Ashby (2013), Moss et al. (2011)
Solid and gaseous fossil fuel combustion	Ashby (2013), Moss et al. (2013)
Nuclear power	Moss et al. (2011)
Bioenergy with carbon capture and storage (BECCS)	Moss et al. (2011) data on fossil-based combustion with CCS
EV batteries	Assumptions based on Volkswagen (2021)
EV motors	Assumptions based on IEA (2021a) and Månberger and Stenqvist (2018)
Electrolysers	IEA (2021a)

Besides using virgin natural resources for minerals, we can also use recycled materials after their expected lifetime. In the scenario assessments we have made rough estimates for the recycling rates of the selected metals in the selected technologies, which will reduce the demand for virgin natural resources. However, there is very little information on future potentials for recycling and therefore these estimates include large uncertainties. Besides recycling, other metals can substitute for some metals in certain applications but this information is even more lacking and therefore not considered. However, innovation and improvements of existing technologies, such as batteries, are considered, and the technology data includes estimates for metal intensity development in the future, which naturally also includes large uncertainties.

2.2 *TIMES-VTT Model Description*

The TIMES-VTT model is a global multi-region model based on the ETSAP TIMES modelling framework. The model itself is a derivative of the global ETSAP TIAM model (TIMES Integrated Assessment Model, see Loulou 2008; Loulou and Labriet 2008). The methodology can be characterized as bottom-up, technology rich partial equilibrium modelling, and the model is usually run in perfect foresight mode. The model covers all sectors but focuses on energy and emissions, with all Kyoto gases included (e.g., carbon dioxide, methane, nitrous oxide, fluorinated gases). The regional composition includes 19 regions with the most detail for Europe but

covering all countries of the world, some of which are thus quite large aggregates (e.g. Africa, Central and South America).

The model is driven by a set of demands for energy services in all sectors: agriculture, residential, commercial, industry and transport. The construction of the exogenous demands for energy services may be done by using the results from general equilibrium models, which can provide a set of coherent drivers for each region and for the world as a whole, such as population, households, GDP, and sectoral outputs (e.g. output of manufacturing industry by main branch, output of public and commercial services, output of agriculture, forestry and fishery). The decoupling factors between the drivers and the demands for useful energy services account for phenomena such as saturation and suppressed markets and are in part empirically based. Most of these final demands have economic growth as their key driver. However, the demands for all other commodities (e.g. electricity, heat, various fuel commodities, emission allowances, carbon dioxide geological storage services) in the system are endogenously determined by the model according to their supply-demand equilibrium, which must always satisfy various resource and sustainability constraints.

For supporting global integrated assessment modelling of climate change mitigation, the TIMES framework also incorporates an integrated climate module with a three-reservoir carbon cycle for carbon dioxide (CO_2) concentrations and single-box decay models for atmospheric methane (CH_4) and nitrous oxide (N_2O) concentrations, and the corresponding functions for radiative forcing. The forcing functions for CO_2 , CH_4 and N_2O follow the non-linear formulations presented in the IPCC Fifth Assessment Report (Myhre et al. 2013) but are linearized around user-defined points. If necessary, using an iterative approach the accuracy of the linearization can be improved to an arbitrary level. Additional forcing induced by other natural and anthropogenic causes is considered by means of exogenous projections. The changes in the global mean temperature are simulated for two layers, surface, and deep ocean (Loulou et al. 2016). When modelled, the emissions of fluorinated gases (HFCs, PFCs and SF_6) can also be accounted for in the climate model by converting them into equivalent CO_2 emissions. Although the carbon cycle and the concentrations of CH_4 and N_2O are represented by quite simple models, the radiative forcing from anthropogenic greenhouse gas (GHG) emissions is reasonably well approximated by the TIMES climate module and is calibrated to reproduce historical levels.

The model has been previously used to study global, regional and national mitigation pathways to reach 1.5–2 °C mitigation targets and for impact assessments of national, Nordic, and EU level climate and energy policies. TIMES-VTT model has been the core tool in formulating and analysing the impacts of Finland's climate and energy strategies and policies, including climate neutrality target by 2035 (Lehtilä et al. 2021; Koljonen et al. 2021). A detailed description of the TIMES methodology can be found in the documentation (Loulou et al. 2016). Below, the modelling of metal demands is briefly described in three scenarios to reach 1.5–2.0 °C mitigation target by 2100, with two alternative storylines for 1.5 °C mitigation scenarios.

2.3 *Description of Scenario Formulation with 1.5–2.0 °C Mitigation Target*

For the modelling experiment, we selected eight metals to be included in the TIMES-VTT model for assessing the impact of clean energy transition on the demand for the primary extraction of these metals and resource sufficiency. The selection of metals was based on recent literature (e.g. IEA 2021a; Gielen 2021; IEA 2023a) and on our earlier studies (Grandell et al. 2016), which show the potential risks in the supply of these metals compared with their rapidly increasing demands. For each of these metals, we identified all the main energy technologies where the metals are needed and estimated the consumption in terms of unit of installed capacity. After the technical lifetime of each of these technologies, the materials are assumed to be released for scrapping, and can be recycled into new products within an assumed average delay of 5 years from scrapping to a building new installation. The model thereby produces the annual flows representing the amounts of metals stored in the new installations, and the annual recycling flows after the end of their product lifetimes (EoL). Even though the supply of minerals and their processing to these eight metals is not explicitly modelled, the resources per extraction (R/E) numbers shown in Table 2 indicate the potential constraints of these metal supplies. The recycling rates are based on assumed present rates and are expected to increase over time. The approximation of EoL recycling is described in Kiviranta et al. (2022).

The scenarios modelled are long-term scenarios for the global energy system until 2100. For the scenario formulation, we have used the key characteristics of mitigation pathways reported in the IPCC AR6 WG3 (2022). The pathways follow the Nationally Determined Contributions (NDC) until 2030 and immediate action towards limiting warming to 1.5–2 °C. Immediate action refers to the adoption of climate policies before 2025, while in the NDC scenario, deep mitigation efforts are seen after 2030. In the scenarios, GHG trajectories are modelled both at the global level and for each TIMES-VTT region as follows:

- **NDC** (Reference scenario): The global and European GHG emissions reduction trajectory is taken from the EN_INDCi2030_1400f scenario results of the REMIND-MAGPIE 2.1–4.2 model in the IIASA database (IIASA 2022). This scenario describes the impact of NDCs and long-term strategies (LTS) on the annual GHG emission trajectories, on the global scale and by region, which lead to a temperature increase of about 2 °C by 2100.
- **1.5C-Tec** (“Advanced technology and global markets”): This storyline focuses on optimistic technology development and their market-based implementation. The global temperature change is limited to 1.5 °C by 2100, but the minimum regional GHG emissions reduction trajectories are as in the NDC scenario, such that in each model year the net regional GHG emission reductions must be larger than or equal to those in the NDC scenario. Interim overshoot is allowed. World population growth is stably slowing down, reaching about 9.8 billion by 2100. Economic growth drivers are modelled according to SSP2 storyline from IPCC AR6 report (IPCC 2022).

Table 2 Summary characteristics of the metals selected for consideration and assumed net EoL (end of lifetime) recycling rates (net of losses)

Metal ^a	Unit ^b	Reserves	Identified resources	Largest Reserves	Current extraction	R/E Years	Current demand ^c	EoL recycling, net		
								2020 (%)	2050 (%)	2100 (%)
Silver	kt	550	750	Peru, AUS, POL	25	30	33	52	63	80
Cobalt	Mt	8.3	25	DRC, AUS, Indonesia	0.19	132	0.20	35	52	80
Copper	Mt	890	2100	Chile, AUS, Peru	21	100	30	45	62	80
Dysprosium	kt	..	1600	China, Vietnam, Russia	2	800	2	7	18	50
Lithium	Mt	26	98	Chile, AUS, Arg.	0.13	750	0.13	6	15	43
Manganese	Mt	1700	17,000	S-Africa, Brazil, AUS	20	850	21	23	41	75
Neodymium	kt	..	29,000	China, Vietnam, Russia	30	960	33	8	20	50
Nickel	Mt	100	300	Indonesia, AUS, Brazil	3	100	4	62	71	85

^aMain data source for reserves, resources and demands: USGS (2022), Liu et al. (2023)

^bApplies to all the columns except R/E (Resources per extraction). R/E indicates the number of years the resources can cover the consumption based on the resources and the current consumption numbers of the commodity

^cCurrent demand includes total global consumption for all the end use sectors

- **1.5C-Env** (“Nature conservation and biodiversity”): This storyline focuses on global environmental sustainability and lifestyle changes not to overshoot planetary boundaries. The global temperature change is limited to 1.5 °C by 2100, but the minimum regional GHG emissions reduction trajectories are as in the NDC scenario, such that in each model year the net regional GHG emission reductions must be larger than or equal to those in the NDC scenario. Interim overshoot is allowed. World population growth is stably slowing down until 2100, and economic growth drivers are modelled according to SSP4 storyline from IPCC AR6 report (IPCC 2022), assuming a slowdown of global economic growth, reflecting enhanced environmental awareness and circular economy. Methane emission reductions due to assumed dietary changes are also taken into consideration in the modelled agricultural GHG emissions.

3 Key Results of Mineral and Metal Demands in the Clean Energy Transition

3.1 Scenario Results for Energy Systems and Greenhouse Gas Mitigation

The global primary energy supply (TPES) has been increasing steadily throughout the 2000s, with an increase of over 40% between 2000 and 2019 (IEA 2021c). Such high growth obviously cannot continue, but many studies have been projecting the total primary energy consumption may be roughly doubling from the present levels by 2100, although the range of different projections is quite large (e.g., IIASA 2022). While electrification and the expanding use of renewable electricity generation tend to reduce growth in primary energy (IRENA 2022; Murphy et al. 2020), the transition to a post-fossil economy may also increase energy losses in some parts of the energy system, notably in storage systems, hydrogen and power-to-X conversion systems to produce synthetic fuels and other products, and due to the application of CCS, biochar or DACCS for climate change mitigation. All these various effects are reflected in our modelling results. Figure 1 illustrates the development of global primary energy supply.

In our scenario experiment, the growth in total energy supply remains quite moderate until 2050 (about 10% from 2020), but the growth becomes higher in the latter half of the century, with TPES reaching about 970 EJ in 2100 in the NDC case (Fig. 1). Some additional growth in the 1.5C-Tec scenario is consistent with the efficiency losses due to certain negative emission technologies (NETs), like DACCS and ocean liming. However, to some extent we may be underestimating the potential technology advances beyond 2050 (technology parameters are often estimated only up to 2050), as well as future changes in consumption patterns and driver elasticities for some energy service demands. Lower assumptions for economic growth in the 1.5C-Env scenarios are reflected in slower growth in global total primary energy

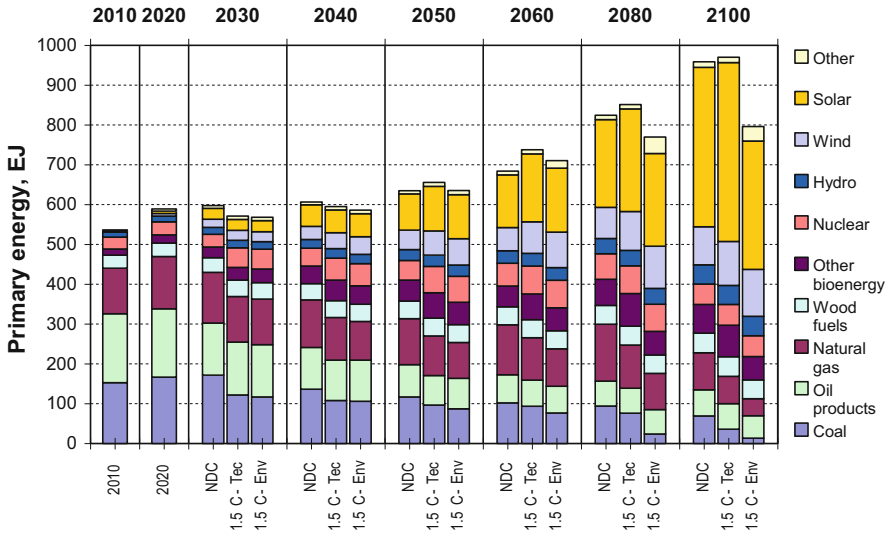

Fig. 1 Development of global total primary energy supply (TPES) in the scenario variants, including non-energy uses

supplies, reaching a considerably lower level of 800 EJ in 2100, corresponding to a 36% increase from 2020.

Among the most important energy sources, solar energy becomes the dominant source for primary energy in the latter half of the century in all scenarios. On a global scale, solar would leave wind behind already before 2040, even though wind power also continues to expand significantly. Larger scale deployment of offshore wind power could also be possible but would require heavy investments into infrastructure. One major uncertainty related to future energy sources is the sustainable potential of bioenergy supply in the longer term, having a direct link to the prospects for BECCS deployment. Like in IAM models in general, in the TIMES-VTT model the use of limited resources is exogenously constrained to sustainable potentials estimated from the literature. In 2020, the global primary production of primary biomass for energy (excluding the biomass fraction of municipal waste) was about 60 EJ/a, of which about 35 EJ/a wood fuels, about 15 EJ/a agricultural residues and 7–10 EJ/a energy crops. In the 1.5 °C mitigation scenarios, by 2050 the global primary solid biomass use for energy increases to about 97–98 EJ/a in the 1.5C-Tec scenario and to about 86 EJ/a in the 1.5C-Env scenario. According to IPCC (2022) the range of recent estimates for the technical bioenergy potential by 2050, when constrained by food security and environmental considerations, is 5–50 EJ/a for residues and 50–250 EJ/a for dedicated biomass production system respectively. In the IEA (2021b) scenarios, sustainable bioenergy potentials have been constrained to 100 EJ/a. However, it is recognised that thus avoiding the risk of negative impacts on biodiversity, freshwater systems, and food prices and availability there is a high degree of uncertainty over the future sustainable bioenergy potentials.

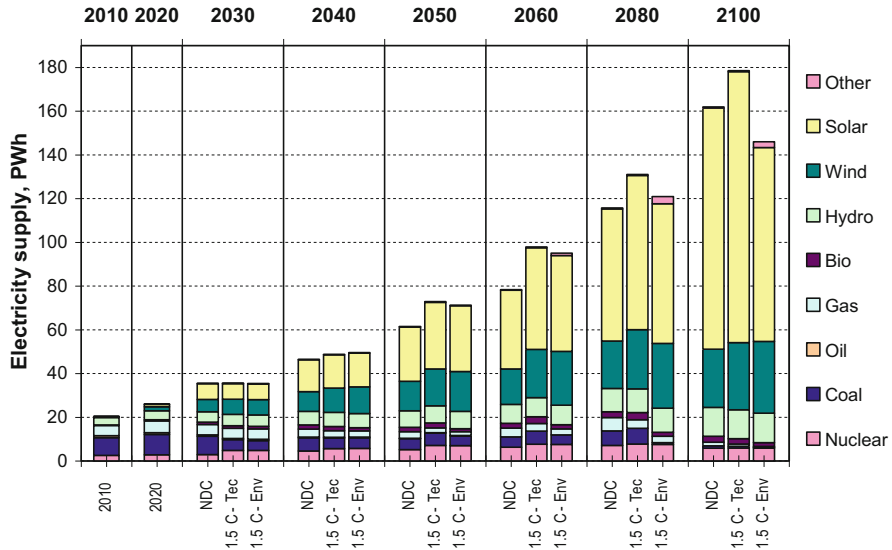

Fig. 2 Development of global total net electricity supply in the scenario variants, excluding power plants own consumption

The electrification of the global energy systems, as well as the expanding hydrogen economy, electro-fuels and decarbonized industrial systems, all increase electricity consumption, which may approach 180 PWh by 2100 according to the scenario results of the 1.5C-Tec scenario (Fig. 2). On the other hand, in the 1.5C-Env scenario with lower economic growth assumptions, electricity consumption stabilizes at a lower level of 140 PWh by 2100. The cost reductions of solar PV systems that have already taken place, and the projected further technical developments, can make solar power highly competitive on a large scale within the next few decades. Despite the additional flexibility required due to the variable nature of solar generation, the model results suggest that by 2100 60–70% of global electricity generation would be solar-based, with the highest contribution being reached in the technology-optimistic 1.5C-Tec scenario.

As expected, fossil fuel-based electricity generation is phased out almost completely by 2100, with natural gas-fired power remaining on a somewhat notable level until 2080. Bioenergy-based generation will not gain significant overall market share but will nonetheless be important in some regions and globally with respect to the negative emissions achieved through BECCS power plants. In absolute terms, nuclear power also increases notably in the scenarios but loses some share of total global generation in all the scenarios. Despite its high capital costs, nuclear power has the benefit of providing stability in the power grids under high variable power integration.

Until 2050, the global electricity supply is well in line with that in the IEA NetZero by 2050 scenario (IEA 2021b, 2023b). The total supply is about 60 PWh in

2050 and 80 PWh in 2060 in the NDC case, and around 70 PWh in 2050 and 95–98 PWh in 2060 in the 1.5 °C scenario variants. Beyond 2050, the growth in the supply may appear large, but is well explained by high electrification being the key factor behind the growth, which can also be understood by observing the moderate growth in the primary energy consumption shown in Fig. 1. High scale of electrification is enabled by the use of several types of energy storages in the model, such as batteries, power-to-X technologies, hydropower, and pumped-storage hydropower. The additional electricity consumption of DACCS plants becomes very significant beyond 2050 in the 1.5C scenarios highly reliant on this technology. At their peak deployment around 2070, the DACCS plants consume about 11% of global electricity in the 1.5C-Env case, and about 5% in the 1.5C-Tec case. The electricity supply figures are quite well in line with the IEA NZE scenario (IEA 2021b, 2023b), where the total supply was 71–77 PWh in 2050, as well as with the JRC GECO projections, where the gross supply reached 90 PWh by 2060 in their NDC case, and 99 PWh in their 1.5 °C scenario (Keramidas et al. 2022).

In the NDC scenario, the total CO₂ emissions approach zero only in 2100, and the total GHG emissions remain above 10 Gt CO₂ eq./a until 2100 (Fig. 3). The 1.5 °C mitigation scenarios follow considerably steeper decreasing emission paths, reaching the temperature target of 1.5 °C in 2100 after intermediate overshooting. Even though the global net CO₂ emissions (including LULUCF) fall to zero around 2050, the temperature has risen to 1.6 °C by that time and would keep rising unless substantial amounts of additional negative emissions are produced during the latter half of the century to fully reaching the climate target of a maximum of 1.5 °C by 2100.

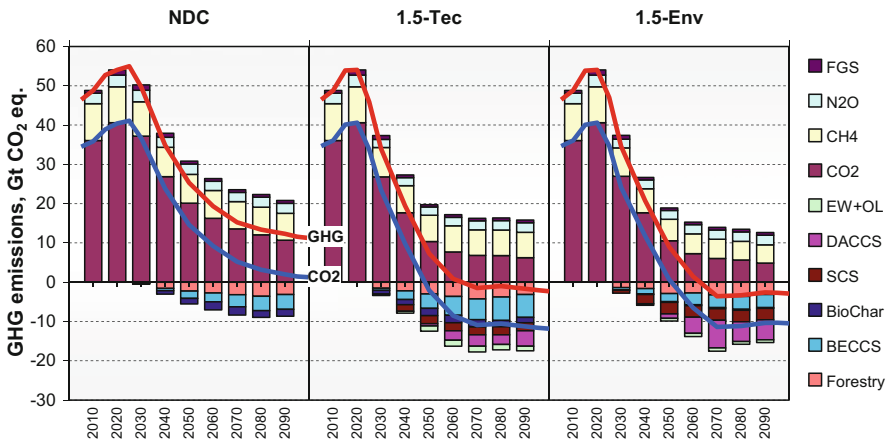

Fig. 3 Development of greenhouse gas emissions (Kyoto gases) in the scenario variants. *Note:* The red and blue lines represent the total net emissions of GHGs and CO₂, respectively, and the vertical bars show the gross emissions (positive) and removals (*BECCS* bioenergy with CCS, *DACCS* direct air carbon capture and storage, *SCS* soil carbon sequestration, *EW + OL* enhanced weathering and ocean liming) (Color figure online)

The results indicate that fossil energy technologies with carbon capture (FECCS, including capture of related process emissions) would be employed on a large scale within the power generation sector, energy-intensive process industry, and other energy transformation sector. While in the power sector, the role of fossil-fuel based power plants would soon be decreasing, CCS would gain additional importance in the upstream fuel transformation sector, most notably in hydrogen production. Additional policies could, of course, be introduced to accelerate the transition to renewable energy, for example electrolyzers in hydrogen production, to reduce reliance on CO₂ capture and storage.

3.2 Overview of the Demands of Selected Metals for Selected Technologies

The total cumulative net demand for the metals included in the energy systems modelling is presented in the NDC, 1.5C-Tec, and 1.5C-Env scenarios, which is compared with identified resources (Table 3). The cumulative values represent only the modelled demands related to clean energy transition, and not all uses other than for energy sector, like in electronics or medical technologies. The cumulative uses have been compared with the identified resources reported by the US Geological Survey (USGS 2022). According to the results, out of the selected metals considered, the most critical in terms of sufficiency are cobalt and dysprosium. Above 90% of the cumulative use of these metals in the energy sectors are used in cars, which reflects the urgency for radical changes in our mobility and transport. Also 85–90% of cumulative use of Manganese (Mn) and Nickel (Ni) in energy sector is used for cars and the rest is used for wind power and power plants with CCS. The projected cumulative primary cobalt use would be 27–28 Mt., exceeding the identified resources without substantive recycling and substitution. For dysprosium, the projected primary metal requirements correspond to 80% of the identified resources,

Table 3 Summary of the modelled cumulative net demand for primary production of metals

Metal	Unit	Identified Resources	Modelled cumulative primary metal use by 2100					
			NDC	%	1.5C-Tec	%	1.5C-Env	%
Ag	kt	750	130	17	150	20	120	16
Co	kt	25,000	18,600	74	29,740	119	29,910	120
Cu	Mt	2100	640	30	720	34	650	31
Dy	kt	1500	930	58	1290	81	1310	82
Li	kt	89,000	27,200	28	40,660	41	40,950	42
Mn	Mt	17,000	100	1	130	1	130	1
Nd	kt	11,200	6400	22	6910	24	7020	24
Ni	Mt	300	60	20	90	30	90	30

Note: Percentage indicates the cumulative use of metal in energy technologies compared with its identified resources

and for neodymium they correspond to almost 60%. Moreover, even though the modelled cumulative consumption of copper remains below 40% of the identified resources, one should point out that copper has significant other uses that were left out of the estimation, including electricity transmission networks that have been projected to create significant additional demand for copper (IEA 2021a).

The cumulative use of silver corresponds to 20% of the identified resources but it is notable that above 90% of the energy sector's use is for solar power installations. Overall, the results indicate the pivotal impact of the electrification of transportation on the demand for selected metals for consideration. Apart from silver, electric and hybrid vehicles would appear to contribute to 60–96% of the modelled demands for all other selected metals in clean energy technology applications. For silver, solar energy systems would however remain the most important technology cluster based on the assumed trends in the technology mix, where currently crystalline silicon cells are dominating the solar PV market (Fraunhofer 2022). The analysis for each selected metal is given below.

3.3 Sufficiency of Cobalt, Copper, Dysprosium, Lithium, Neodymium, Silver, and Nickel in Climate Change Mitigation

Cobalt (Co) has significant uses in lithium-ion and other types of batteries, the manufacture of magnetic, wear-resistant, and high-strength alloys, for electroplating, and in chemical industries as catalysts and as drying agents for paints and inks. Primary cobalt is obtained mainly as a by-product from the mining of nickel, silver, lead, copper and iron. According to USGS (2023), the current annual global mine production of cobalt is about 190,000 tonnes and the identified resources are 25 Mt. According to the World Economic Forum (2020), 15–30% of cobalt production in DRC comes from artisanal and small-scale mines, which represents the second largest cobalt mining sector globally after large-scale industrial mining in DRC. Most of the cobalt minerals are refined and used in China with about 80% of its consumption used by the battery industry. The modelled cumulative primary cobalt consumption due to energy technologies already exceeds identified resources. Above 95% of that use would be attributable to batteries, primarily in electric vehicles but to some extent also in stationary battery systems. Some sources estimate a significant reduction in the cobalt requirements of new battery chemistry options by 2050. Gregoir and Acker (2022) also claim that historical trends in reserve and resource development support the conclusion that there will be enough minerals and metals available for global needs. Since 2012, global resources of cobalt have doubled and reserves nearly doubled. On the other hand, the consumption of metals in other than light duty cars may also be underestimated in our modelling experiment.

Currently, the main uses of lithium (Li) are batteries (over 70%), ceramics and glass (about 14%) and various other industrial applications (about 12%) (USGS 2022). Total annual extraction amounts to about 130 kt/a, and the global identified resources are about 98 Mt. (USGS 2023), showing a 9 Mt. increase compared with the previous year (Table 3). With these estimates, the reserves per extraction (R/E) ratio would be 750 years, which appears quite high. The largest producer of lithium is Australia followed by Chile and China. However, in the scenarios presented, the modelled cumulative primary metal use alone would increase to above 40% of the identified resources. Like with cobalt, above 95% of lithium is used in batteries in cars by 2100. Nonetheless, assuming that the demands excluded from the modelling would not increase significantly, the resource sufficiency may be considered adequate, bearing in mind that there are large other unaccounted resources of lithium e.g. in seawater. Since 2012, both the reserves and resources have increased thousands of folds indicating also that Li resources might not appear to be so critical (Gregoir and Acker 2022).

Copper (Cu) is also used for various applications within all sectors of the economy. The current annual total copper demand is about 30 Mt., annual extraction is about 21 Mt. and the identified terrestrial resources amount to 2100 Mt., translating into a R/E ratio of 100 years. The production of copper is rather diversified between countries and regions. However, in 2022 the largest mine producers were Chile, Peru, China and DRC putting more pressure to Global South countries' natural environment. About 26% of copper is currently consumed by building construction, about 17% into infrastructure (including electricity transmission), about 13% into transportation vehicles, and the remaining 44% into various industrial and consumer equipment (IWCC 2023). The current end-of-life recycling rate of copper is about 45% (IEA 2021b). In the modelling experiment, the modelled cumulative net primary copper consumption (after recycling) was 640 Mt. in the NDC (2 °C) scenario and 650–720 Mt. in the 1.5C-Tec and 1.5C-Env scenarios. Above 50% of the modelled copper in the energy sector use are attributable to road vehicles and nearby 40% to solar power systems, of which a large part would be genuinely additional consumption. Moreover, one should note that the expanding power generation with large amounts of distributed generation would require remarkable additional investments also into transmission networks requiring most likely much more copper than currently. The IEA (2021a) has estimated that the annual copper consumption for transmission networks would increase to 10 Mt. by 2040. By extrapolating this projection to 2100, one may estimate the cumulative consumption at around 1400 Mt. during 2020–2100, which would cause significant additional demand of primary copper even with high recycling rates. Based on these results, the sufficiency of primary copper resources may indeed become critical during the current century, and substantial efforts to further improve the recycling rates would appear justified.

Dysprosium (Dy) and Neodymium (Ny) are rare earth minerals (REEs) and mainly used for permanent magnets, which are used especially in wind power plants and electric motors (e.g. road vehicles). Neodymium is also used to smaller extent in metallurgical, ceramics and other industries, which should bear in mind also when

considering resource sufficiency. In 2022, about 70% of REEs were produced in China, which also has the largest identified resources. The current annual demand for dysprosium is about 2000 metric tonnes, and the identified resources have been estimated at 1600 kt, which translates into a reasonably high R/E ratio of about 800 years. However, the demand dysprosium is projected to increase quite rapidly, and the results suggest that by 2100 the cumulative primary metal use in the applications modelled might account for over 80% of the identified resources. The total demand for neodymium is currently about 30 kt/a, and the identified resources have recently been estimated at 29,000 kt (Liu et al. 2023), giving a R/E ratio of nearly 1000 years. The modelling suggests that even with the rapidly increasing demand in electric motor and wind power applications, the modelled cumulative primary metal use of neodymium would amount only to about 25% of the identified resources by 2100, provided that beyond 2050 the average EoL recycling rate can be increased to 50%. It should be noted that also for the REEs considered most of the cumulative consumption is attributable to road vehicles, while for the permanent magnets of wind power plants the cumulative use is only 5–10% of the total use in the energy sector.

Until recently, the recycling rates of most REEs have been very low. According to a UNEP report (2011), the end-of-life recycling rate of dysprosium was estimated to be 1% or below. The low rates are mainly due to the low content of the metal in the recycled products, which may make the recycling process costly. In the modelling experiment, the results on primary metal requirements were obtained assuming steadily increasing recycling rates reaching 50% in 2100, the same level as for neodymium (Table 3). Therefore, the results clearly indicate that dysprosium may be among the most critical metals in terms of resource sufficiency and the need for enhanced recycling.

Silver (Ag) is a precious metal used for jewellery, silverware, coins and bars. Industrial applications are, however, increasingly significant, particularly electrical and electronic industries (TSI 2023). Among energy technologies, solar power systems have gained a notable role in the total consumption of silver. According to the USGS (2022), the annual mine production is about 25 kt. The production of silver is rather diversified between countries and regions, while the largest silver producers are Peru, Australia, China. The current global silver reserves are about 550 kt, which would mean exhaustion of the global reserves in 22 years assuming just the current level of mining. The total resources are larger, but according to an ultimately recoverable resources (URR) analysis (Sverdrup et al. 2014), the remaining recoverable silver resources were estimated at only about one million tonnes. That would translate into the exhaustion of the global silver resources within the current century, with peak primary production estimated to occur already by 2040. The modelling results indicate that transition to carbon neutrality would create about 200 kt of additional demand by 2100, where above 90% comes from PV systems. Here, one should note that the specific silver consumption of PV systems is projected to reduce significantly by 2050, and these reducing metal requirements have been considered in the modelling. Bearing in mind that most of the current silver demand is not related to energy technologies, and that main part of the demand

can be assumed reasonably stable, the additional demand would inevitably cause accelerated exhaustion of the remaining silver resources and additional pressure on maximizing the recycling rates.

Nickel (Ni) is used in significant amounts in stainless steel and other alloys to make them stronger and withstand extreme temperatures and corrosion. Moreover, it has considerable uses in plating and battery chemistry applications. The total identified resources of nickel are estimated at about 300 Mt. giving a low R/E ratio of 130 years. Between 2021 and 2022 global nickel mine production increased by 20% to 3.3 Mt. reflecting the increasing demand. Indonesia is the largest producer of nickel with Chinese joint venture companies. However, nickel recycling can still be enhanced from the current levels. According to Gregoir and Acker (2022) the projected growth of European pure nickel secondary supply would result in a decline of primary demand post 2040 and reduce the expected 2020–2050 primary demand.

The results given in Table 3 show that the differences in cumulative uses of metals under study are rather small between the two 1.5 °C mitigation scenarios. On the other hand, in the NDC scenario the cumulative use of cobalt, dysprosium, and lithium is considerably lower than in the 1.5 °C mitigation variants. The summary of cumulative metal uses in the 1.5C-Tec scenario (Fig. 4) shows that 35% of cobalt resources are used by 2050 indicating the urgency for action regarding its use in cars. Moreover, we conducted a sensitivity analysis for the 1.5C-Tec scenario where we removed DACCS from the technology options for climate change mitigation while at the same time limiting the deployment of BECCS to the scale in the original results of the scenario. According to the results, the cumulative metal requirements increased for all the metals under study by 3–60% by 2100 when the DACCS

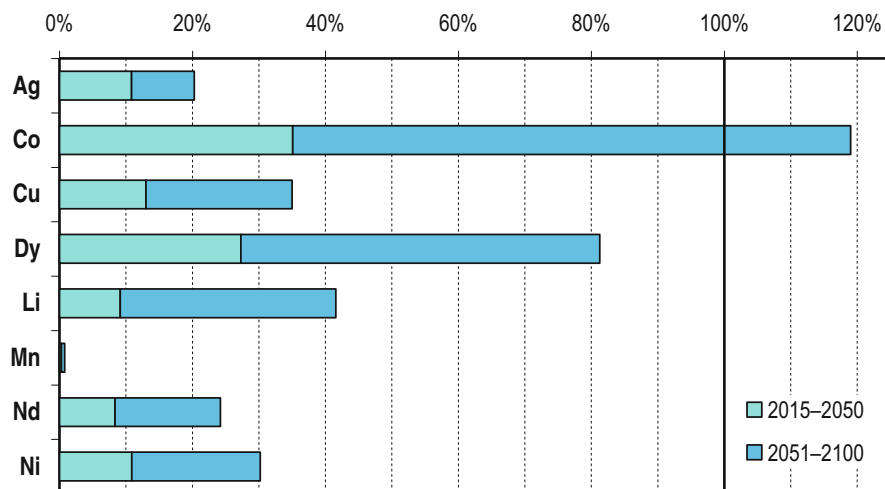

Fig. 4 Estimated cumulative primary requirements of selected minerals due to clean energy technologies in the 1.5C-Tec scenario within 2105–2100, in proportion to identified total global resources

options were not available. The increases were the largest in the cobalt and lithium uses, mainly due to the increased needs for stationary electricity storage systems, but also the added consumption of dysprosium, neodymium and nickel were significant, between 7% and 18%. However, a thorough and credible sustainability analysis would require more comprehensive data both on the direct and indirect material use, and land use impacts. As an example, indirect metal use of DACCS must be considered due to its high energy consumption but closing out DACCS from technology portfolios can increase the total cumulative metal use considerably. Claderon et al. (2024) also highlighted that there are lacking analysis on the ability to meet these demand estimates.

4 Linking SDGs with the Clean Energy Transition

Clean energy transition with the phase-out of fossil fuels is undoubtedly needed to mitigate climate change to a safe level (SDG13) and to ensure affordable and clean energy access for all (SDG7). Electrification of the energy system is a key climate measure, which would rapidly increase the investments in such clean energy technologies, which metal intensities are much higher than for conventional technologies using fossil fuels. Minerals needed for clean energy transition are largely mined in the Global South region and processed to metals in China, where the mining industry has been associated with human rights violations, environmental contamination, and biodiversity losses (IEA 2023a; Gregoir and Acker 2022; World Economic Forum 2020).

It is evident that transition calls for sustainable consumption and production (SDG12) patterns with resource decoupling and impact decoupling from economic growth. Compared with fossil fuel production, critical and other minerals production is much more concentrated geographically. China has a dominant position not only for production of REEs but also for processing of cobalt and lithium (IEA 2023a). Major production and identified reserves are located especially in the Global South, like in DRC and Chile, which raises concerns about the potential impacts on inequalities (SDG10) especially due to artisanal and small-scale mining. Large-scale industrial mining can also cause severe environmental problems. In addition to potential environmental and biodiversity risks, mining industries use large amounts of water, which can worsen the access to clean water (SDG6). The amount of water withdrawal should especially be considered at locations where there are concerns on water availability. As an example, production of one tonne of lithium can require approximately 1.9 million litres of water and in Chile's Salar de Atacama, where lithium and other mining activities consumed 65 per cent of the region's water. That is having a big impact on indigenous communities that have lived in the Andean region of Chile, Bolivia and Argentina and local farmers (UNCTAD 2020). Consumption of water is also high for REE and cobalt mining (Gregoir and Acker 2022). It is thus important that socially inclusive solutions are suited to local needs in mineral production (SDG12).

There are many ways to tackle the critical sustainability challenges on climate action, affordable and clean energy for all, and reduced inequalities. As shown in our modelling experiment, the impacts of increased energy and material efficiencies, recycling, and metal substitution can be assessed with Integrated Assessment Modelling but there are still lacking data and knowledge especially on potentials for recycling and substitution. Our storyline 1.5C-Env included an assumption of slightly lower GDP growth compared with the other two. However, due to stricter constraints for bioenergy and BECCS implementation, the demands of some metals even increased, which reveals the complexity of the system level assessments. However, without radical changes in our behaviour towards more responsible consumption (SDG12) there is a risk of overshooting planetary boundaries and increased inequalities. We can argue that there is an urgent need for in-depth analysis and modelling on energy sufficiency and how this will impact on demand projections for minerals and metals.

5 Conclusion

Energy system modelling is a useful tool for assessing not only energy but also material demands for a clean energy transition. In our modelling experiment, TIMES-VTT IAM was used to analyse the demands of selected minerals and metals, which are considered critical to reach 1.5–2 °C mitigation targets. Our modelling results indicate that the raw material availability adds an extra layer of constraints and uncertainties to the clean energy transition, which has been recognized by several earlier studies. In this scenario modelling exercise, the analysis for demands of minerals and metals was expanded with the impacts brought by negative emissions technologies and practices (NETPs) as a novel element for the assessments to reach 1.5–2.0 °C mitigation target. Unfortunately, we couldn't find any data for metal demands of NETPs except for fossil CCS, which was used for modelling of metal demands of BECCS. Based on our modelling results, metal demands for BECCS seem to be very low. However, it should be noted that large investments in DACCS will increase renewable electricity demand with high metal intensities indicating that also indirect metal use should be considered.

Based on our analysis, the most critical metals are cobalt and dysprosium, which were mostly used for batteries. As the direct demands of minerals and metals for NETPs seems to be very low, the constraints in battery metals supplies may increase the demand for NETPs. Critical metals are also used outside energy sector putting more pressure on security of supply of these metals. However, there is a lack of analysis on the ability to meet these demand estimates. We need a better understanding of recycling and substitution of critical metals, analysis of future critical mineral and metal demands outside of the energy sector, and a realistic analysis of new mine development. In our modelling exercise, even with optimistic assumptions on recycling, global demands of minerals and metals are increasing so rapidly that

without extensive opening of new mines there are increasing resource and supply security risks.

The Global North is putting more emphasis on their own mining and metal industries to decrease the supply risks of critical metals. Due to rapid growth in metal demands, we can expect that supply of critical minerals and metals for clean energy transition are still largely mined and processed in the Global South. Constant auditing and increased transparency are thus needed to monitor human rights, safe working conditions and protection of the local environment in Global South. The processed metals are shipped from Global South to Global North, which is responsible for major demand growth of these metals. In addition to responsible production of metals, we need also put more emphasis on responsible consumption. Based on our results, sustainable transformation of the transport sector with moderate growth will have a pivotal role. On the other hand, mining operations have the potential to bring economic benefits to the communities and governments where the operations take place. Thus, we need socially inclusive solutions and public-private partnerships to make sure that everyone benefits throughout the value chains.

Acknowledgement The authors want to acknowledge funding from EU H2020 project NEGEM (869192), and from VTT Technical Research Centre of Finland Ltd.

References

- Ashby MF (2013) Metals for low-carbon power. *Mater Environ* 2:349–413. <https://doi.org/10.1016/b978-0-12-385971-6.00012-9>
- Calderon JL et al (2024) Critical mineral demand estimates for low-carbon technologies: what do they tell us and how can they evolve? *Renew Sustain Energy Rev* 189:113938. <https://doi.org/10.1016/j.rser.2023.113938>
- Carrara S et al (2020) Raw materials demand for wind and solar PV technologies in the transition towards a decarbonised energy system. EUR 30095 EN, Publication Office of the European Union, Luxembourg <https://data.europa.eu/doi/10.2760/160859>
- Fraunhofer (2022) Photovoltaics report. Fraunhofer Institute for Solar Energy Systems. <https://www.ise.fraunhofer.de/content/dam/ise/de/documents/publications/studies/Photovoltaics-Report.pdf>
- Gielen D (2021) Critical minerals for the energy transition. International Renewable Energy Agency, Abu Dhabi. isbn: 978-92-9260-366-3 <https://www.irena.org/Technical-Papers/Critical-Materials-For-The-Energy-Transition>
- Grandell L et al (2016) Role of critical metals in the future markets of clean energy technologies. *Renew Energy* 95:53–62. <https://doi.org/10.1016/j.renene.2016.03.102>
- Gregoir L, Acker vK (2022) Metals for clean energy: pathways to solving Europe's raw materials challenge. KU Leuven, Belgium. <https://eurometaux.eu/media/rqocjybv/metals-for-clean-energy-final.pdf>
- IEA (2021a) The role of critical minerals in clean energy transitions. International Energy Agency, Paris. <https://www.iea.org/reports/the-role-of-critical-minerals-in-clean-energy-transitions>
- IEA (2021b) Net zero by 2050. A roadmap for the global energy sector. International Energy Agency, Paris
- IEA (2021c) World energy balances. <https://www.iea.org/data-and-statistics/data-product/world-energy-balances>

- IEA (2023a) Critical minerals market review 2023. International Energy Agency, Paris. <https://www.iea.org/reports/critical-minerals-market-review-2023>
- IEA (2023b) Net zero roadmap. A global pathway to keep the 1.5 °C goal in reach. 2023 Update. International Energy Agency, Paris
- IIASA (2022) AR6 scenario explorer and database hosted by IIASA. <https://data.ene.iiasa.ac.at/ar6/>
- IPCC (2022) In: Shukla PR, Skea J, Slade R, Al Khourdajie A, van Diemen R, McCollum D, Pathak M, Some S, Vyas P, Fradera R, Belkacemi M, Hasija A, Lisboa G, Luz S, Malley J (eds) Climate change 2022: mitigation of climate change. Contribution of Working Group III to the Sixth Assessment Report of the Intergovernmental Panel on Climate Change. Cambridge University Press, Cambridge/New York. <https://doi.org/10.1017/9781009157926>.
- IRENA (2022) Smart electrification with renewables: driving the transformation of Energy Services. isbn 978-92-9260-367-0. IRENA_Smart-Electrification_Renewables_2022.pdf
- IWCC (2023) IWCC statistics and data series. International Wrought Copper Council. <https://www.coppercouncil.org/iwcc-statistics-and-data>
- Keramidas K et al (2022) Global energy and climate outlook 2022: energy trade in a decarbonised world. EUR 31355 EN, Publications Office of the European Union, Luxembourg. isbn 978-92-76-60,498-3. <https://doi.org/10.2760/863694>.
- Kiviranta K et al (2022) Report on assessment of impacts on key non-renewable resource chains: case study on global demand, supply and trade-offs for selected metals and minerals in global mitigation pathways. Deliverable D3.9. <https://www.negemproject.eu/>
- Koljonen T, Lehtilä A (2012) The impact of residential, commercial, and transport energy demand uncertainties in Asia on climate change mitigation. Special issue in Energy Economics 34(3): S410–S420. <https://www.sciencedirect.com/science/article/pii/S0140988312001053>
- Koljonen T et al (2021) Carbon neutral Finland 2035—measures and impacts of the climate and energy policies. Prime Minister’s Office, Helsinki. isbn 978-952-383-257-2 (In Finnish, English summary)
- Lehtilä A, Koljonen T (2018) Pathways to post-fossil economy in a well below 2°C world. In: Giannakidis G, Karlsson K, Labriet M, Gallachóir B (eds) Limiting global warming to well below 2 °C: energy system modelling and policy development. Lecture Notes in Energy vol 64. Springer, Cham. https://doi.org/10.1007/978-3-319-74424-7_3
- Lehtilä A et al (2021) Development of the energy system and greenhouse gas emissions. Carbon neutral Finland 2035—impact assessments of climate and energy policies and measures. Prime Minister’s Office, Helsinki. isbn 978-952-383-318-0 (In Finnish, English summary)
- Liu S-L et al (2023) Global rare earth elements projects: new developments and supply chains. Ore Geol Rev 157:105428. <https://doi.org/10.1016/j.oregeorev.2023.105428>
- Loulou R (2008) ETSAP-TIAM: the TIMES integrated assessment model. Part II: mathematical formulation. Comput Manag Sci 5(1–2):41–66
- Loulou R, Labriet M (2008) ETSAP-TIAM: the TIMES integrated assessment model. Part I: model structure. Comput Manag Sci 5(1–2):7–40
- Loulou R et al (2016) Documentation for the TIMES model. Energy Technology Systems Analysis Programme (ETSAP). IEA-ETSAP | Optimization Modeling Documentation
- Månberger A, Stenqvist B (2018) Global metal flows in the renewable energy transition: exploring the effects of substitutes, technological mix and development. Energy Policy 119:226–241. <https://www.sciencedirect.com/science/article/pii/S0301421518302726>
- Moss et al (2011) Critical metals in strategic energy technologies: assessing rare metals as supply-chain bottlenecks in low-carbon energy technologies. European Commission Joint Research Centre (JRC). Publication Office of the European Union, Luxembourg. <https://data.europa.eu/doi/10.2790/35716>
- Moss et al (2013) Critical metals in the path towards the decarbonisation of the EU energy sector: assessing rare metals as supply-chain bottlenecks in low-carbon energy technologies. European Commission Joint Research Centre (JRC). Publication Office of the European Union, Luxembourg. <https://data.europa.eu/doi/10.2790/46338>

- Murphy C et al (2020) High electrification futures: impacts to the U.S. bulk power system. *Electr J* 33:106878. <https://doi.org/10.1016/j.tej.2020.106878>
- Myhre G et al (2013) Anthropogenic and natural radiative forcing—supplementary material. In: *Climate change 2013: the physical science basis. Contribution of working group I to the fifth assessment report of the intergovernmental panel on climate change*. https://www.ipcc.ch/site/assets/uploads/2018/07/WGI_AR5.Chap_8_SM.pdf
- OECD (2019) *Global material resources outlook to 2060: economic drivers and environmental consequences*. OECD Publishing, Paris. <https://doi.org/10.1787/9789264307452-en>
- Sverdrup H et al (2014) Investigating the sustainability of the global silver supply, reserves, stocks in society and market price using different approaches. *Resour Conserv Recycl* 83(2014): 121–140
- TSI (2023) *World Silver Survey 2023*. The Silver Institute. <https://www.silverinstitute.org/wp-content/uploads/2023/04/World-Silver-Survey-2023.pdf>
- UNCTAD (2020) *Commodities at a glance. Special issue on strategic battery raw materials*. United Nations conference on trade and development, Geneva. https://unctad.org/system/files/official-document/ditccom2019d5_en.pdf
- UNEP (2011) *Recycling rates of metals. A status report*. International Resource Panel. United Nations Environment Programme
- UNEP (2019) *Global resources outlook 2019*. United Nations Environment Programme, Paris. <https://wedocs.unep.org/20.500.11822/27517>
- USGS (2022) *Mineral commodity summaries*. U.S. Geological Survey, Virginia. <https://doi.org/10.3133/mcs2022>
- USGS (2023) *Mineral commodity summaries*. U.S. Geological Survey, Virginia. <https://pubs.usgs.gov/periodicals/mcs2023/mcs2023.pdf>
- Volkswagen (2021) Watch Volkswagen start electric car battery recycling in Salzgitter. <https://insideevs.com/news/483097/volkswagen-start-battery-recycling-salzgitter/>
- Watari T et al (2019) Total material requirement for the global energy transition to 2050: a focus on transport and electricity. *Resour Conserv Recycl* 148:91–103. <https://doi.org/10.1016/j.resconrec.2019.05.015>
- World Bank (2017) Arrobas D et al. The growing role of minerals and metals for a low carbon future. World Bank Group, Washington DC. <https://documents1.worldbank.org/curated/en/207371500386458722/pdf/117581-WP-P159838-PUBLIC-ClimateSmartMiningJuly.pdf>
- World Bank (2020) Hund K et al. Minerals for climate action: the mineral intensity of the clean energy transition. World Bank Group, Washington DC. <https://pubdocs.worldbank.org/en/961711588875536384/Minerals-for-Climate-Action-The-Mineral-Intensity-of-the-Clean-Energy-Transition.pdf>
- World Economic Forum (2020) Making mining safe and fair: artisanal cobalt extraction in the Democratic Republic of the Congo. White Paper September 2020. World Economic Forum, Geneva. https://www3.weforum.org/docs/WEF_Making_Mining_Safe_2020.pdf

Open Access This chapter is licensed under the terms of the Creative Commons Attribution 4.0 International License (<http://creativecommons.org/licenses/by/4.0/>), which permits use, sharing, adaptation, distribution and reproduction in any medium or format, as long as you give appropriate credit to the original author(s) and the source, provide a link to the Creative Commons license and indicate if changes were made.

The images or other third party material in this chapter are included in the chapter's Creative Commons license, unless indicated otherwise in a credit line to the material. If material is not included in the chapter's Creative Commons license and your intended use is not permitted by statutory regulation or exceeds the permitted use, you will need to obtain permission directly from the copyright holder.



Emission Free Energy Carriers and the Impact of Trade to Achieve the 1.5 °C Target: A Global Perspective of Hydrogen and Ammonia



Felix Lippkau, Ganesh Deepak Rupakula, and Markus Blesl

Abstract To achieve the global 1.5 °C target and realize a climate-neutral energy system, decarbonizing all sectors of final energy consumption is crucial. Green hydrogen and green ammonia emerge as pivotal in decarbonizing, particularly in the industrial sector by 2100, given their potential as emission-free energy carriers. These can be efficiently produced in regions abundant in renewable resources, with lower production costs and then exported to high-demand areas. This study explores the most cost-effective global trade routes for supplying these energy carriers, considering future electricity production, the role of renewables by 2100, global emissions, final energy consumption, and the subsequent production and logistics of hydrogen and ammonia. We introduce four scenarios: Business-as-Usual (BAU), a 1.5 °C scenario (1_5D) aligning with specific CO₂ budgets, and two variants of the 1_5D scenario (SoS1 and SoS2) with varying restrictions on imports and domestic production. Employing the TIMES Integrated Assessment Model (TIAM), our findings suggest a future energy landscape dominated by the electricity sector, with solar PV contributing over 50% of green electricity by 2100. Hydrogen demand could reach 13,500 TWh compared to 155,000 TWh global energy demand. Without import constraints, Middle East Asia, due to its renewable resource richness and strategic location, could fulfill the global demand for green hydrogen and ammonia.

Key Messages

- Without climate policies, no trades in low-carbon fuels are observed.
- Middle East Asia has the lowest green hydrogen costs with abundant potential and could be the main exporter if no trade restriction policies are applied.
- Considering cost efficiency, Europe is import dependent and could import hydrogen and ammonia from Africa and Middle East Asia.

F. Lippkau (✉) · G. D. Rupakula · M. Blesl
Institute of Energy Economics and Rational Energy Use, Stuttgart, Germany
e-mail: felix.lippkau@ier.uni-stuttgart.de; ganesh-deepak.rupakula@ier.uni-stuttgart.de;
markus.blesl@ier.uni-stuttgart.de

© The Author(s) 2024

M. Labriet et al. (eds.), *Aligning the Energy Transition with the Sustainable Development Goals*, Lecture Notes in Energy 101,
https://doi.org/10.1007/978-3-031-58897-6_11

247

- Net zero emission target is possible by 2050 in the scenarios considering strong climate policies and negative emissions starting from 2040.

1 Introduction

The global trade in high-carbon fuels has been established for years. According to (BP 2022) the daily trade in crude oil in 2022 was reported to be 66.95 million barrels. This is a 25% increase compared to 2010 when it was 53.51 million barrels (BP 2011). Converting this volume to energy, the daily trade equates to 109 TWh in 2021 which has a carbon content of 28.9 Mt. if used energetically or 10.5 Gt considering the entire year. In 2015, the Paris Agreement was announced which aims to limit global warming to well below 2 °C (United Nations 2016). According to Rogelj et al. (2018), this means a net global carbon budget of approximately 420 Gt in order to satisfy the 1.5 °C goal with the highest chance of success. Against this backdrop, in 2022, global CO₂ emissions were reported by GlobalCarbonAtlas (2023) as 36 Gt, which means 8.5% of the net carbon budget remains. Based on the high quantity of carbon fuels that additionally include natural gas and coal, new low-emission fuels must be established in order to achieve the 1.5 °C target. There has already been research that investigated options for the energy system transition that are in line with the 1.5 °C target. Staffell et al. (2019) described options for transitioning various sectors from fossil fuels to low-carbon alternatives like hydrogen. Germany was deeply covered by recent studies that investigated the whole energy system transition considering all relevant sectors to decarbonize (BCG 2021; Deutsche Energie-Agentur GmbH 2021; Luderer et al. 2021; Öko-Institut e.V. et al. 2021). Green hydrogen and ammonia, both carbon-free, are promising fuels for a wide range of applications requiring replacement (IRENA 2022).

The aim of this research is to investigate the global export/import allocation of hydrogen and ammonia, considering climate policies. It aligns with the global CO₂ budget set for achieving the 1.5 °C target, with additional consideration of trade restrictions. This research also aims to provide an overview of the future exchange of the emission free energy carriers until 2100 considering different driving factors for each country such as GDP, population, industry, and renewable energy capacities. In addition, the work also attempts to contribute to the Sustainability Development Goals, SDG 7: “Affordability and Clean Energy” and SDG-13: “Climate Action”. It aims to find out the final energy consumption and electricity mix of renewable and non-renewable energy needed to achieve the 1.5 °C for reaching SDG-13. It also explores the production and trade of the clean energy carriers- green hydrogen and ammonia in every world region to contribute to SDG-7.

The investigation is an extension of our work (Lippkau et al. 2023) where ammonia as a low-carbon fuel is also considered here in addition to only hydrogen and synfuels exchange for the global energy system in the previous paper.

2 Research to Date

Most of the previous studies chose specific export and import countries for the techno-economic analysis of the trade routes. Export countries are the places where renewable sources, like sun hours and wind, are abundant to produce green hydrogen and its derivatives and simultaneously have lower production costs. These include Morocco, Tunisia, Algeria, Chile, Argentina, Australia, and Denmark. Import countries have a high demand for hydrogen but have less renewable sources and/or have high costs for their own production; for instance, Germany. van der Zwaan et al. (2021) have analyzed the export of hydrogen from North African countries to Europe and found that hydrogen will be the predominant clean energy carrier imported to Europe and is expected to progressively rise. Brändle et al. (2020) provided a more generalized report on hydrogen production routes for 94 countries on 6 continents. Their important finding was that green hydrogen from renewable-powered electrolyzers will be cost-competitive starting in 2030. Another finding was that hydrogen transport via pipelines will be cost-effective only until 2000 km distance; for longer distances, transport via ship will be economical. They concluded that Germany could produce green hydrogen at a lesser price on-site compared to green hydrogen imported from the MENA region to Germany.

Hampf et al. (2023) investigated nine different trade routes: both ships and pipelines for the transport of green energy carriers like hydrogen, methane and ammonia to Germany. The export countries selected were Spain, Denmark, Morocco, Argentina, Australia, Saudi Arabia, and Egypt. The main findings are that for pipeline export, green hydrogen from Denmark has the lowest levelized cost- 75 €/MWh (2.5 €/kgH₂) along with 83 €/MWh from Egypt and Spain. On the other hand, for ship export, Argentina offers the lowest levelized cost- 95 €/MWh to Germany. It performs the best compared to Egypt, Morocco, and the other EU countries as well. The authors concluded that importing green hydrogen directly to Germany is more economical than importing its derivatives and converting them back to hydrogen. In similar research, Teichmann et al. (2012) explored green hydrogen transport options via LOHC (Liquid Organic Hydrogen Carrier), LH₂ (liquid H₂) and High-voltage Direct Current (HVDC) from North Africa to Europe. They also reported that hydrogen production via HVDC import is the most economical option followed by LOHC and LH₂ import is the most expensive in terms of production and transport. Steam-Methane Reforming (SMR) is the only economical option for on-site hydrogen production. Johnston et al. (2022) developed an open-source model for shipping costs of hydrogen and derivatives- LNG, methanol and ammonia from Australia, Chile, USA, Algeria and South Africa to Germany (Rotterdam port), Japan(Tokyo port) and China (Shanghai port). They found out that Ammonia is the cost-effective hydrogen carrier with levelized costs ranging from 0.56 to 0.82 \$/kgH₂ and liquid hydrogen is the most expensive chemical for shipping with costs in the range of 2.09–2.19 \$/kgH₂. Additionally, they concluded that the ship's capital and fuel costs play a major role in evaluating the levelized costs. Galimova et al. (2023) also performed a study for the regions Chile, Morocco,

Germany and Finland and provided a similar conclusion. They have also found that hydrogen transport by pipeline is economical up to 2400 km and sea shipping is preferable for long distances with transportation costs constituting 29–63% of total import costs. However, additional results state that imported green hydrogen from Chile and Morocco is more expensive than local production in Germany and Finland.

Egerer et al. (2023) researched Ammonia export extensively from Australia to Germany. They have focused on the entire value chain from renewable energy generation, green hydrogen production, ammonia from hydrogen, export, and cracking hydrogen back from ammonia at the final destination. The final levelized cost of hydrogen was estimated at 159.18 €/MWh with 59.4 €/MWh for green hydrogen production in Australia and 109.39 €/MWh for green ammonia production and transport to German harbor. The major cost component in this case is electricity price (81%). In other research, Sagel et al. (2022) focused on Power-to-Ammonia-to-Power (P2A2P) technology for two islands: Curaçao and Viti Levu for year-round green electricity supply. They have explored two options for green ammonia: own production with wind energy and import from Brazil, Australia, Chile, Trinidad and Tobago. They also concluded that the import of green ammonia is cheaper than on-site production with levelized cost of electricity (LCOE) = 0.11–0.37 \$/kWh due to the high investment costs required for island operation of the P2A2P system.

Most of the studies selected a few specific countries as export and one to three countries as import locations. Table 1 provides a summary of the literature findings and the regions covered for the trade. Few studies emphasized green hydrogen while other studies focused on green ammonia costs. Focus was mainly placed on Germany as an import country due to high industrial demand and low renewable resources. Moreover, these studies assume hydrogen and other low-carbon fuels to be available as import with no further description of import/export structure and the quantity that is available by the export region.

To the author's knowledge, no study exists that covers all the regions of the world for the production and trade of both green hydrogen and ammonia. This work aims to investigate the production and the export potential of the two energy carriers for all world regions under different scenarios until 2100. The regions, the countries under these regions and the scenario definition will be defined in detail in the next section.

3 Optimization Model and Approach

This investigation employs the TIMES Integrated Assessment Model (TIAM) (Mousavi 2019; Loulou 2008). TIAM is a global energy system model that maps 16 regions (Fig. 1) for a time horizon of 2015–2100. Regions are either referred to as countries (e.g. USA, Germany etc.) or aggregated regions (e.g. Africa, Middle East Asia etc.). For each of the regions all final energy sectors- industry, households, commercial, transport and agriculture are mapped as shown in Fig. 2. The objective of the model is to minimize the overall system cost (Net present value: NPV) for all

Table 1 Overview of green hydrogen and green ammonia costs from literature

Reference	Continents covered				Green hydrogen costs (LCOH)	Green ammonia costs (LCOA)
	Africa	Asia	North America ^a	South America		
Hamp et al. (2023)	✓	✓		✓	2.5 €/kg from Denmark to Germany	–
Johnston et al. (2022)		✓			2.09 \$/kgH ₂ from Rotterdam to Australia	0.56 \$/kgH ₂ from Rotterdam to Australia
Teichmann et al. (2012)	✓				2.03 \$/kgH ₂ LOHC from Iceland to Germany	–
Galimova et al. (2023)	✓			✓	1.5 €/kg from Morocco to Germany and 1.7 €/kg from Chile to Finland in 2050	–
Egerer et al. (2023)					–	109.39 €/MWh from Australia to Germany
Sagel et al. (2022)				✓	–	0.12 \$/kWh for Curacao 1.1 \$/kWh for Viti Levu

^aNorth America was not mentioned in the corresponding studies

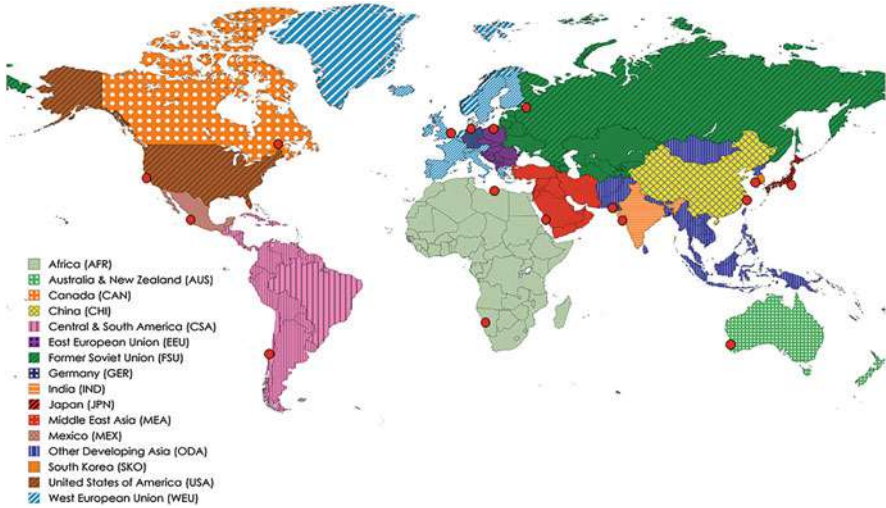

Fig. 1 TIAM regions and selected harbors (red dots)

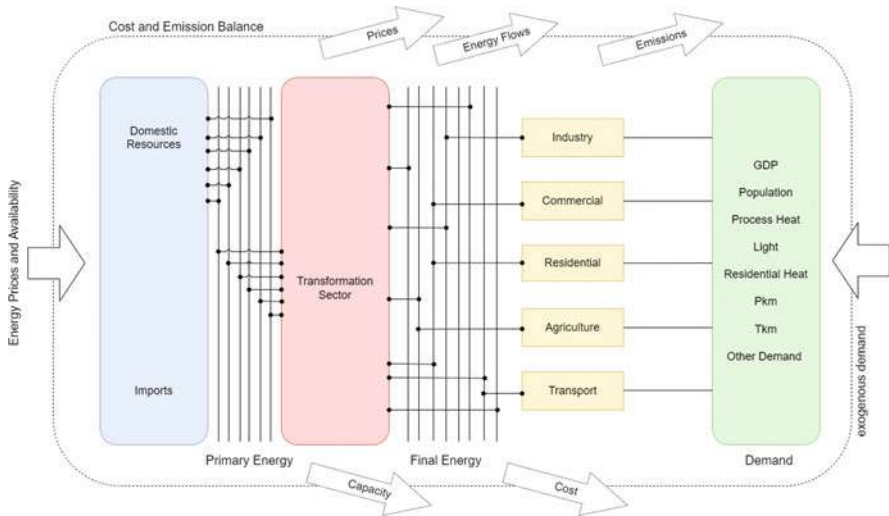

Fig. 2 Reference energy system for the TIAM model

years and regions (Eq. 1). Therefore, the NPV is calculated by using the sum over all regions r and all years y in the time horizon multiplying the annual cost (ANcost) with the discount rate $d_{r,y}$ based on the year of consideration ($refy-y$).

$$NPV = \sum_{r=1}^R \sum_{y \in \text{years}} (1 + d_{r,y})^{\text{refy} - y} * ANcost(r, y) \quad (1)$$

The model considers a microeconomic technology competition. Therefore, perfect foresight is used, meaning that all current and future costs, technologies, and demand projections are known at the beginning of 2015 as the base year.

In detail the model maps the supply of primary energy to final energy with the transformation sector in between (Fig. 2). The model is based on the IEA energy balance (IEA 2023) and calibrated to the base year of 2015. The demand is set exogenously by using drivers as the gross domestic product (GDP) or the population.

The cost for technologies is split by capital expenses (CapEx) and operational expenses (OpEx), while the OpEx is further divided into fixed OpEx (cost per year) and variable OpEx (cost per energy unit used). Apart from using national resources, the model also has the option to import resources (Fig. 2). Therefore, trades between TIAM regions are mapped in the TIAM model.

Within the model, hydrogen can be used as input for final energy sectors such as industry (process heat, non-energy demand), households and commercial (room heat), transport (shipping, aviation, and road transport) as well as for agriculture (machines). The demand for hydrogen is endogenously modeled, as it is set by the processes of the industry, commercial, residential, agriculture and transport sector to satisfy the demand for energy services and materials. In comparison the ammonia demand is set both endogenously and exogenously. This means that there is a fixed demand mainly caused by fertilizer production in all regions (USGS 2023). Besides this the ammonia demand as fuel is modeled endogenously within the model.

Both hydrogen and ammonia can be traded in the TIAM model. For hydrogen, LH₂ is used while ammonia can be stored under high pressure. After transport, hydrogen can be used via regasification and ammonia can either be used for satisfying the demand for ammonia itself or for back cracking to satisfy the demand for hydrogen. Overall, hydrogen and ammonia are in direct competition for transport. The CapEx and OpEx for regasification of hydrogen and back cracking of ammonia can be found in Table 2.

To map the hydrogen and ammonia trades, harbors have been selected based on size to ensure to handle the trade (Fig. 1 and Table 3). Each region has one representative harbor except Africa having two harbors, because of the size of the region and therefore investment decisions would be distorted by only using one

Table 2 Technologies for after trade

	Regasification LH ₂	Back cracking ammonia
CapEx [M€]	165	1062
Capacity Unit	KW	t/a
Lifetime [a]	20	25
OpEx [% of CapEx]	2.5	4.3
Source	(IRENA 2022)	(Ishimoto et al. 2020)

Table 3 Harbor selection for the TIAM model

Region	Port Name	Latitude	Longitude
AFR	Port of Walvis Bay	-22.94438616	14.48237595
SKO	Port of Busan	35.10370188	129.0414886
CSA	Port of Buenos Aires	-34.56909495	-58.38273273
AUS	Fremantle Ports	-32.0529628	115.7408536
CAN	Port of Quebec	46.82265707	-71.20249041
CHI	Port of Shanghai	30.63068515	122.0847303
GER	Port of Hamburg	53.5410807	9.986766343
WEU	Port of Birmingham	53.63207459	-1.85406508
IND	Mundra Port	22.74104731	69.7157146
JPN	Port of Keihin	35.42669641	139.6843441
AFR	Port of Benghazi	32.110470309	20.0423606
MEX	Puerto De Manzanillo	19.7070599	-71.7447426
ODA	Port of Karachi	24.83708206	66.98086793
EEU	Port of Gdynia	54.5360318	18.53554754
FSU	Port of Saint Petersburg	59.88860049	30.18117919
MEA	Port of Jeddah	21.49503622	39.1551345
USA	Port of Los Angeles	33.72839414	-118.2402335

Table 4 Techno-economic data for hydrogen and ammonia transport technologies

	LH ₂	Ammonia
CapEx [M\$/ship]	412	85
Capacity [t]	11,000	53,000
Lifetime [a]	30	30
OpEx [% of CapEx]	4	4
Speed [km/h]	30	30
Max operation days [-]	330	330
Fuel Use [MJ/km]	1487	2500
Boil-off rate [%/day]	1.3	0
Source	(IEA 2020)	(IEA 2020)

harbor. Moreover, the distance has influence on the cost of transport as well. The techno-economic data for the hydrogen and ammonia transport are shown in Table 4.

The hydrogen costs are calculated by cost potential curves (Table 5) that are stated in Franzmann et al. (2023). A high spatial and temporal resolution GIS model was used to capture the area-specific conditions to further calculate the LCOH based on local energy system models using CapEx and OpEx based on Table 6. A deeper insight into the hydrogen and ammonia modeling based on the cost potential curves is given based on a reference energy system (Fig. 3).

The full methodical approach of this investigation is shown in Fig. 4. Each of the 16 TIAM regions has the production route of hydrogen via electrolyzers and other hydrogen production technologies (SMR etc.) included. Hydrogen can either be used for local demand or liquefaction to receive LH₂ for trade. Hydrogen is also the

Table 5 Cost potential curve for hydrogen supply (2050–2100)

		Step 1	Step 2	Step 3	Step 4	Step 5	Step 6	Step 7	Step 8
AFR	H ₂ Export [PWh]	7.67	14.00	24.14	47.58	44.07	22.65	7.97	20.05
	Cost [EUR/MWh]	28.6	29.5	30.3	31.3	32.8	35.6	38.1	41.7
AUS	H ₂ Export [PWh]	130.9	36.66	42.63	43.44	28.12	100.6	26.38	24.43
	Cost [EUR/MWh]	31.2	35.6	36.6	36.4	32.9	36.4	43.7	43.9
CAN	H ₂ Export [PWh]	13.23	5.68	8.36	4.67	4.57	4.49	4.84	31.07
	Cost [EUR/MWh]	39	47.5	44.9	60.9	58.2	55.6	64.2	87.4
CHI	H ₂ Export [PWh]	26.40	9.57	11.57	12.82	11.68	8.81	12.75	60.86
	Cost [EUR/MWh]	46.5	53.8	50.3	45.7	43.4	42.9	44.8	32.1
CSA	H ₂ Export [PWh]	24.34	29.99	24.28	44.60	13.27	7.12	4.99	4.99
	Cost [EUR/MWh]	30.1	32.7	34.3	36.1	41.1	47.8	55.7	55.7
GER	H ₂ Export [PWh]	0.17	0.10	0.09	0.06	0.05	0.02	0.02	0.02
	Cost [EUR/MWh]	27.7	30.4	31	33.9	36.1	44	45.1	45.1
EEU	H ₂ Export [PWh]	0.59	0.18	0.10	0.09	0.05	0.03	0.03	0.07
	Cost [EUR/MWh]	31.1	30.6	28.6	40.8	47.2	38.4	42.4	37.4
FSU	H ₂ Export [PWh]	28.88	0.46	0.14	0.10	9.32	7.71	1.61	55.61
	Cost [EUR/MWh]	38.9	47.5	30.4	37.6	40.3	50.1	49.6	83.1
IND	H ₂ Export [PWh]	12.62	4.73	2.13	0.46	0.46	0.46	0.46	0.46
	Cost [EUR/MWh]	31.6	37.8	45	52.7	52.7	52.7	52.7	52.7
JPN	H ₂ Export [PWh]	0.28	0.09	0.02	0.02	0.02	0.02	0.02	0.19
	Cost [EUR/MWh]	32.2	29.3	35.1	35.1	35.1	41.7	48.8	79.2
SKO	H ₂ Export [PWh]	0.07	0.01	0.01	0.01	0.01	0.01	0.00	0.04
	Cost [EUR/MWh]	30.3	24.3	26.3	32.3	32.3	34.2	44	79.5
MEA	H ₂ Export [PWh]	15.10	22.95	22.73	32.22	24.89	24.94	24.83	28.10
	Cost [EUR/MWh]	24.2	26.4	29.7	30.6	32.4	33.4	34.2	35.5
MEX	H ₂ Export [PWh]	13.03	8.56	6.33	6.61	7.58	3.84	3.84	3.84
	Cost [EUR/MWh]	37.8	42.8	43.2	42.6	46.4	40.9	40.9	40.9
ODA	H ₂ Export [PWh]	6.94	12.89	2.12	0.50	0.50	0.50	0.50	0.50
	Cost [EUR/MWh]	30.1	30.6	31.3	41.4	41.4	41.4	41.4	41.4
USA	H ₂ Export [PWh]	35.74	23.75	28.58	11.36	17.71	3.74	3.74	3.74
	Cost [EUR/MWh]	38.5	42.2	43.6	40	48.5	56.8	56.8	56.8
WEU	H ₂ Export [PWh]	0.75	0.59	0.46	0.32	0.59	0.43	0.30	0.39
	Cost [EUR/MWh]	23.7	26.4	33.8	40.4	59.7	66.5	63.8	84.9

Table 6 Techno-economic data for electricity sector and hydrogen production

Technology	CapEx [EUR/kW]				OpEx [% CapEx/ a]	Efficiency [%]	Lifetime [a]	Source
	2020	2030	2040	2050				
Onshore Wind	1257	1137	987	923	3	100	25	Pietzcker et al. (2021)
Solar PV	703	395	340	326	1	100	25	
Biomass	2037	1954	1892	1826	3.5	100	25	Ausfelder et al. (2022), IEA (2018)
Hydro Power	–	–	–	2718	2	100	100	Ausfelder et al. (2022), IEA (2021)
Offshore-Wind	–	–	–	1496	3	100	25	IEA (2021)
PEM	900	700	575	450	1.5	64, 69, 72, 74	19	International Energy Agency (2020)
Turbine	220	220	220	220	2	100	20	–
Compressor	1100	1100	1100	1100	2	87	20	Schmidt et al. (2017), Nel ASA (2020)
Desalination	43	43	43	43	2	–	20	A-ETSAP and IRENA (2012), FICHTNER (2011)
DAC	800	350	270	220	3.7	–	25	Schemme (2020)

starting point for ammonia which can be produced using the Haber-Bosch (HB) process. Same as for hydrogen, ammonia can either be shipped or used locally to satisfy the demand. This methodology approach is applied to each of the 16 TIAM regions in the same manner. The 16 TIAM regions are connected for trade using the specific route distance for the selected harbors (Table 3) and transport technologies (Table 4).

4 Scenario Analysis

4.1 Scenario Definition

For this investigation, four different scenarios are considered to have a variety of possible future events mapped to the model (Table 7). Firstly, the business as usual

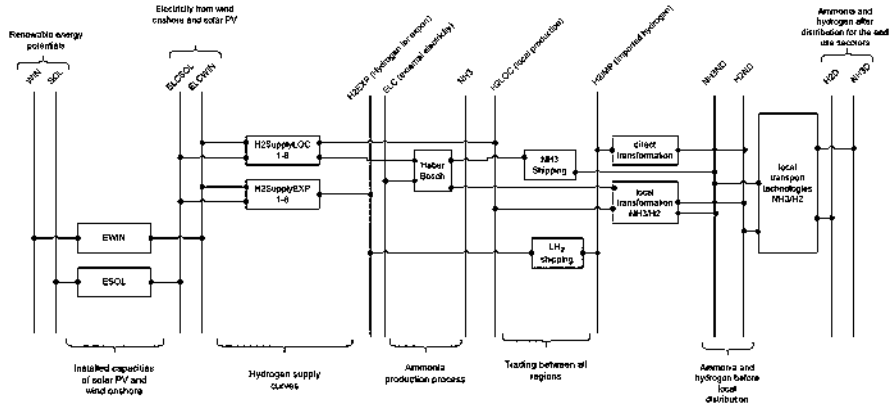

Fig. 3 Reference energy system for hydrogen and ammonia production and trade

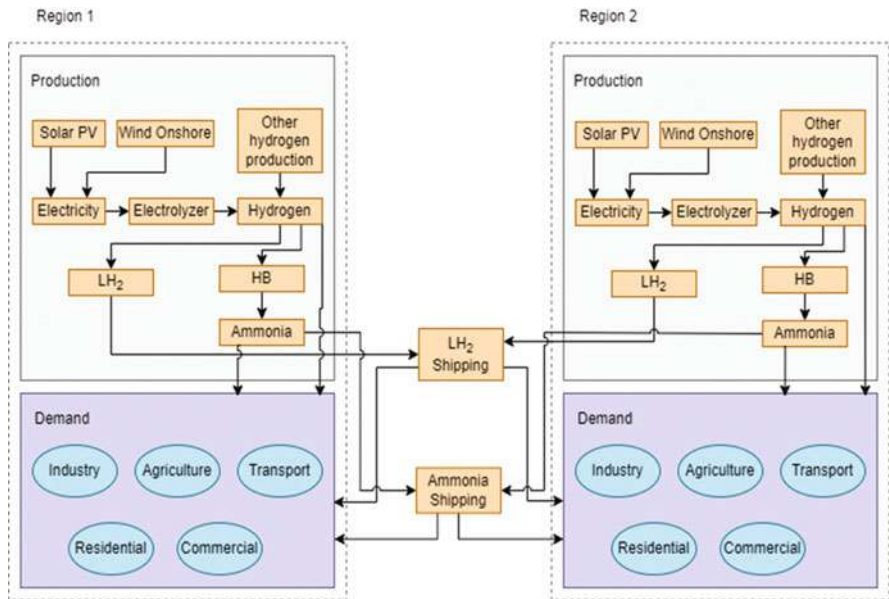

Fig. 4 Methodology approach in the global energy system model TIAM

(BAU) scenario is used as a reference case which does not include any climate policy as a carbon price or a carbon budget. The other three scenarios used in this investigation make use of a carbon budget of 420 Gt that limits global warming to preferably 1.5 °C (Rogelj et al. 2018). The second scenario, 1_5D does not include any further restrictions except the carbon budget according to Rogelj et al. 2018. It provides evidence on possible hydrogen and ammonia allocations without

Table 7 Scenario description

No.	Scenario name	Description
1	BAU	No climate policy
2	1_5D	1.5 °C conform scenario based on a given CO ₂ budget of 420 Gt for 2015–2100 (Rogelj et al. 2018)
3	SoS1	Based on 1_5D scenario. At least 50% of the demand must be satisfied by domestic production. No limitations of trading partners
4	SoS2	Based on 1_5D scenario. Demand can be satisfied by a 100% import, but with at least 5 different trading partners. No trading partner can supply more than 20% of the total hydrogen and ammonia demand

consideration of trade restrictions. To reduce the risk of supply failures, two trade restriction scenarios are considered. The third scenario, SoS1 permits a maximum of 50% of the ammonia and hydrogen demand being satisfied by imports. Therefore at least 50% need to be produced locally. As half of the demand could be satisfied by only one exporter, the fourth scenario imposes further restrictions. In order to have a variety of possible exporters, the SoS2 scenario only permits 20% of the total ammonia and hydrogen demand to be satisfied by one exporter. If there is no local production, at least five exporters are needed to fully supply the ammonia and hydrogen. All of these scenarios provide an overview of different allocation structures for global hydrogen and ammonia supply to achieve the 1.5 °C target. In all four scenarios, the trade of synfuels and bioenergetic fuels is not limited to any restraints. Furthermore, all four scenarios consider cost optimization with the same pool of technologies for investment decisions.

4.2 Scenario Results

4.2.1 Electricity Production

The rise of the global population and increasing wealth lead to higher energy service demands which simultaneously leads to a higher production of electricity globally (Fig. 5). Starting in 2015, the global electricity was approximately 21,000 TWh and mainly uses energy carriers such as coal, gas, nuclear as well as hydro energy. Solar photovoltaics (Solar PV) and wind energy only play a minor role with 194 TWh and 123 TWh.

Electricity was used in the final energy demand, mainly for industry, residential and commercial, with roughly 21,000 TWh (Fig. 6). Coal, gas, and oil take the main shares. Oil is mainly used in transport as well as residential and commercial heating. Gas takes a major share in the industry for process heat and residential and commercial heating. Coal is mainly used in the industry sector. To be aligned with the climate targets, electricity becomes more important in order to decarbonize the

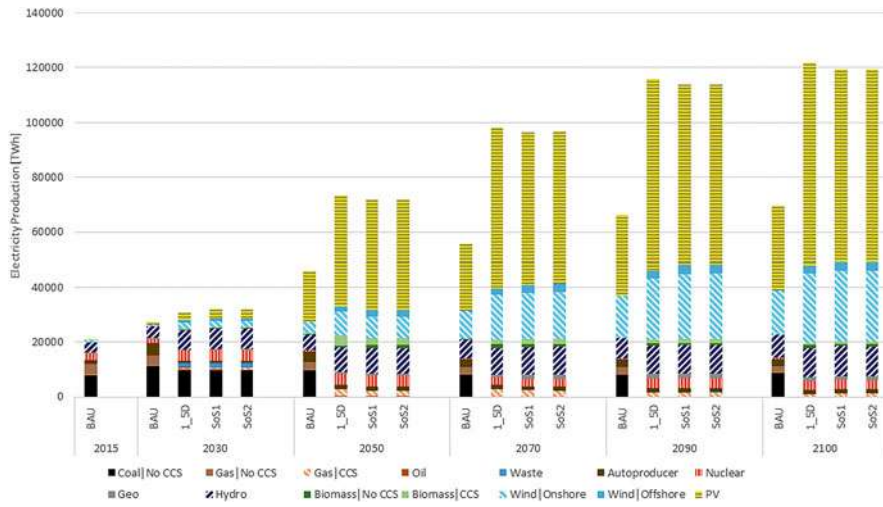

Fig. 5 Global electricity production

global energy system as all of the fossil fuels need to be replaced, but hydrogen is also an option for possible fuel switches.

According to the optimization results, the electricity production grows to approximately 22,800 TWh for BAU scenario and 30,000 TWh for 1_5D, SoS1 and SoS2 scenarios. There is an 83% increase in electricity production for BAU in 2050 and the scenarios with climate policy (1_5D, SoS1 and SoS2) show an increase of almost 130%. While there is still a share of fossil fuels in the electricity mix in 2030, mainly caused by the existing capacities as of 2015, it clearly shows a tremendous switch in 2050 (Fig. 5). Nuclear energy grows as a possible non-carbon source to approximately 2900 TWh in 2050, while it is fading out in the BAU scenario. Besides this effect, there is a clear trend in growing solar PV and wind energy which contributes to more than half of the electricity production for all scenarios and even 70% for all three climate policy scenarios.

The electricity demand is growing up to almost 120,000 TWh in 2100 where over 80% of the electricity is produced using solar PV and wind energy in the three scenarios.

Using the carbon budget approach (1_5D, SoS1 & SoS2), the global fade out of unabated coal for electricity production is shown in 2030 (Fig. 5). Without climate policy, the electricity production of coal rises to 8500 TWh which means a 12.4% share of the total electricity production.

Starting in 2050, biomass with carbon capture and storage (BECCS) is stated in the optimization solution with up to 3600 TWh for scenario 1_5D, and 2500 TWh for scenarios SoS1 and SoS2 in electricity production. Furthermore, biomass without carbon capture and storage (CCS) is used with an additional 600 TWh in 2050 for

scenario 1_5D and 1150 TWh for scenarios SoS1 and SoS2. The peak of BECCS is observed in 2050. In 2100, SoS2 has the highest production with approximately 1040 TWh.

While there is still up to 1200 TWh of electricity out of unabated gas according to the solution of the optimization results in 2050, it fades out in 2060. Throughout the TIAM model’s time horizon, the electricity sector sees no usage of hydrogen. As solar PV and wind onshore are volatile in production, gas CCS plants are built up to satisfy the peak demand. Starting 2040, approximately 2400 TWh in scenarios 1_5D, SoS1 and SoS2 are produced, peaking in 2070 with 2800 TWh in 1_5D, and 2400 TWh in SoS1 as well as 2350 TWh in SoS2.

Overall, the electricity demand rises to 120,000 TWh in 2100 for the 1_5D scenario followed by approximately 118,000 TWh for SoS1 and SoS2. The BAU scenario however peaks at 67,000 TWh which means a 55% share of the electricity production compared to 1_5D.

4.2.2 Final Energy Consumption

The effects of the high electricity demand can be explained by the final energy consumption of the different fuels used (Fig. 6). In order to achieve net zero greenhouse gas emissions, fossil energy carriers, such as coal, oil and gas must be replaced. According to the optimization results of the TIAM model, this is not achieved without climate policies as the BAU scenario indicates (Fig. 6). Roughly, 66,000 TWh are still fossil fuels which lead, in combination with electricity

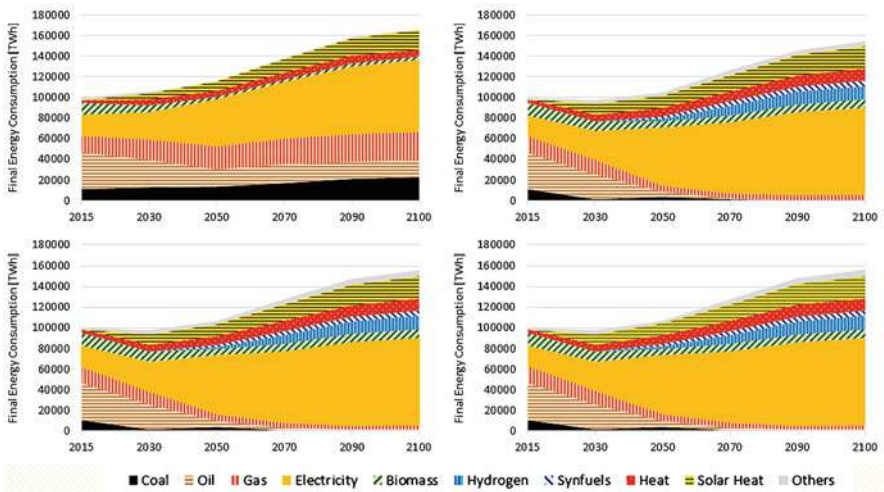

Fig. 6 Final energy consumption. BAU top left, 1_5D top right, SoS1 bottom left, SoS2 bottom right

production, to total net CO₂ emissions of 28.32 Gt in 2100 (Fig. 7). Even without climate policies, electricity use grows up to almost 70,000 TWh, as the technology using it becomes more cost-efficient over time. This means a growth of almost 250% in comparison to 2015, while the final energy demand is rising by roughly 70% in comparison to 2015. Using climate policy, fossil fuels start fading out, due to the diminishing carbon budget. Nevertheless, there is still unabated gas in the final energy consumption in 2100 (1_5D, SoS1 and SoS2), as process heat does not completely switch to low carbon fuels- hydrogen and synfuels. The results indicate that using BECCS for negative emissions (Fig. 7) is more cost-efficient in comparison to biofuels for process heat in the final energy consumption. Hydrogen is mostly used in the industry and transport sector. For industry, hydrogen is used in the iron and steel sector as well as for chemicals. Considering the transport sector, aviation and international shipping start to switch to hydrogen in order to achieve climate targets. Overall, hydrogen has a final consumption of approximately 13,000 TWh in all scenarios with climate action (1_5D, SoS1 and SoS2), while synfuels are reported at roughly 5000 TWh. Therefore, synfuels and hydrogen account for 11% of the final energy consumption in 2100 for the scenarios with climate policy (1_5D, SoS1 and SoS2).

Considering the 1_5D, SoS1 and SoS2 scenarios, the difference in the final energy consumption is small. On a global scale, this means that the energy allocation works no matter of trading partners for hydrogen and ammonia (Fig. 6).

4.2.3 Global CO₂ Emissions

Besides the transformation in the final energy demand, the transformation for the global emissions is also well aligned (Figs. 6 and 7). As global electricity production is leading towards renewable energies, the emissions in case of climate policies are declining. In 2050; net zero is possible by using 6.8 Gt of negative emissions with BECCS. BECCS is also used in the following years with a smaller absolute value of approximately 3.5 Gt of CO₂. Considering the BAU case, the emissions remain at the same level. In 2050, there are 25 Gt of CO₂ emissions, even with high shares of Solar PV and wind energy in electricity production and a rising share of electricity in the final energy demand. In 2100 the emissions are roughly 28 Gt which is approximately the same amount compared to 2015. This means, that the efficiency improvements result in a higher share of using electricity in the final energy demand, but with rising demand, this leads to an overall stagnation in emission reduction for the BAU scenario considering no climate action. In comparison, the climate policies applied to the 1_5D, SoS1 and SoS2 scenarios show a fast decline in global emissions and the use of BECCS and CCS to efficiently use the remaining carbon budget.

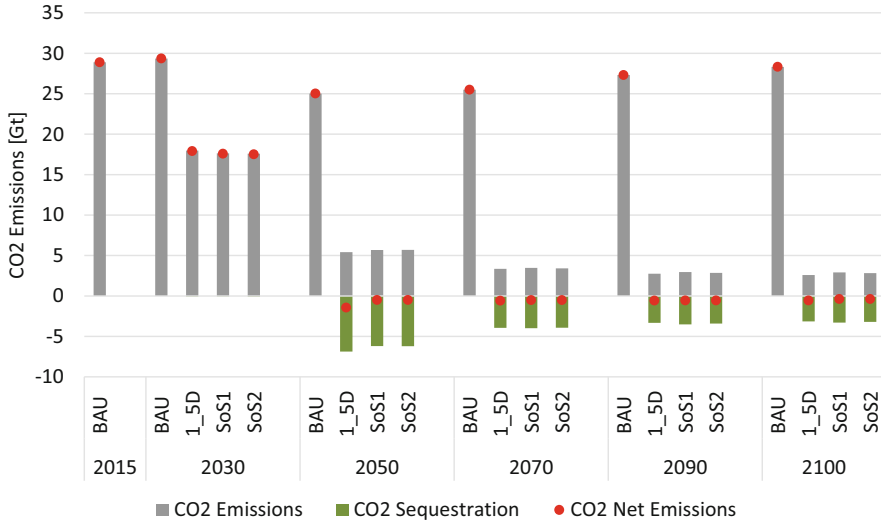

Fig. 7 Global CO₂ emission balance

4.2.4 Production and Export of Hydrogen and Ammonia

Considering the fade out of high fossil fuels- coal, oil and gas (Fig. 6), the hydrogen (as a part of the compensation) must be available in the regions. In the case of no climate policy (BAU), there is no export of hydrogen (Fig. 8). This behavior changes in the climate policy scenarios (1_5D, SoS1 and SoS2). In the 1_5D scenario Middle East Asia shows clearly as the main exporter of hydrogen. There are two reasons. At first, the levelized cost of hydrogen (LCOH) is the lowest due to high sun hours and secondly, the route distance to dependent regions such as Europe, is close that makes it cost attractive for trade. Therefore 1636 TWh of hydrogen are exported in 2100, mainly to Europe. In comparison to the SoS1 scenario, where only 50% of the demand can be satisfied by trade, the amount of hydrogen for trade is higher. The reason for this is caused by the reduction in ammonia trade (Fig. 10). Therefore, Middle East Asia is exporting to almost all neighboring regions.

This behavior is changing by applying the SoS2 scenario where the demand can be completely satisfied by at least five exporters or local production. Africa, Central and South America, the USA and Australia show up as possible export regions. Germany does not start to produce local hydrogen and uses the import strategy by trading with the five mentioned regions.

The differences in hydrogen production are mostly in line with the export behavior. For the 1_5D and SoS1 scenarios, Middle East Asia is not only the largest exporter, it also has the highest production in hydrogen with 5406 TWh (1_5D) and 5730 TWh (SoS1) (Fig. 9). Applying trade restrictions in the SoS1 scenario, there is

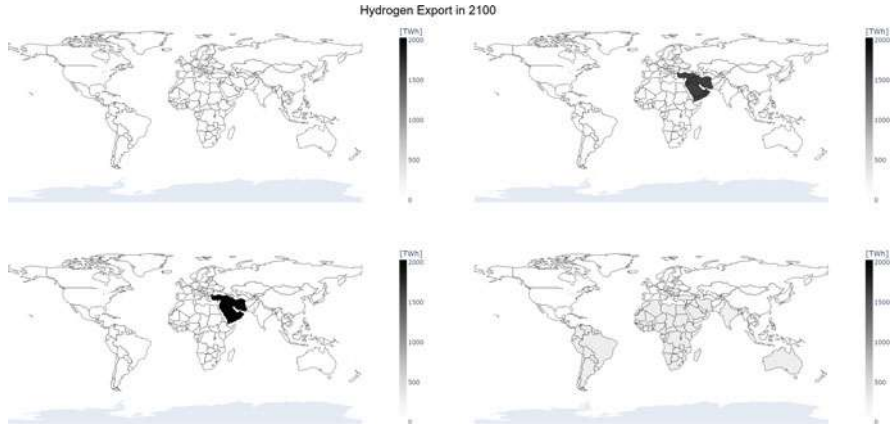

Fig. 8 Global hydrogen export in 2100 (BAU top left; 1_5D top right; SoS1 bottom left, SoS2 bottom right)

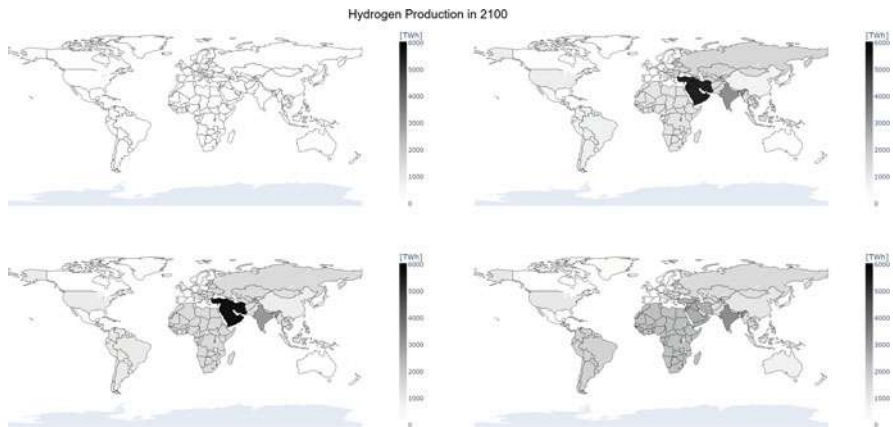

Fig. 9 Global hydrogen production in 2100 (BAU top left; 1_5D top right; SoS1 bottom left, SoS2 bottom right)

a shift visible as India remains a self-producer with an amount of 3210 TWh of hydrogen.

Furthermore, it clearly shows that Europe and Canada do not start hydrogen production in any scenario. In the case of trade restrictions, especially for SoS2, Central and South America, as well as Australia become more cost attractive for hydrogen production.

In the absence of climate policies, the production of fossil-free hydrogen is nonexistent, as depicted by the BAU scenario (Fig. 9).

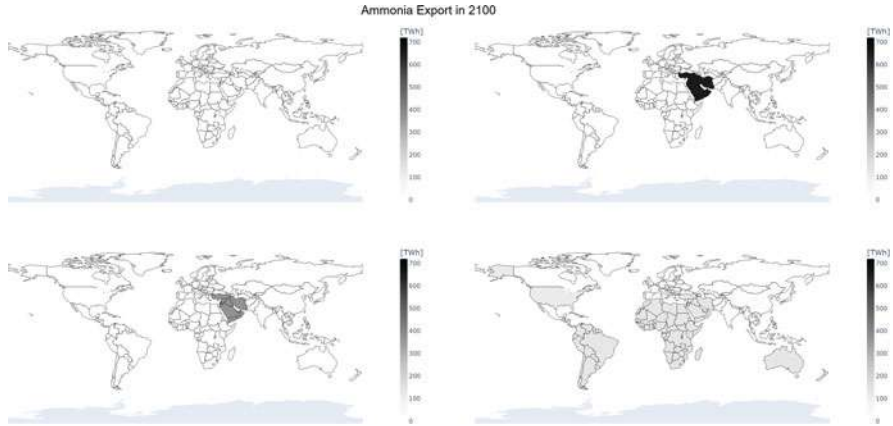

Fig. 10 Global ammonia export in 2100 (BAU top left; 1_5D top right; SoS1 bottom left, SoS2 bottom right)

Besides the hydrogen export, the ammonia export could also play a major role towards net zero. It also shows that there is no export of ammonia in case missing of climate action (BAU) (Fig. 10). Furthermore, there is also no production of fossil-free ammonia, as the SMR option is cheaper without CO₂ prices.

In comparison to the hydrogen exports, the ammonia export shows a different behavior. Lower cost of shipping results in a higher use of export for ammonia which is shown for the 1_5D scenario where no trade restrictions are applied. This is the opposite behavior compared to the 1_5D scenario for the hydrogen export (Fig. 8).

Middle East Asia is also the leading exporter which is the same pattern as shown in the hydrogen export (Fig. 8). This is explained by the LCOH which makes the most cost of the ammonia production. Therefore, ammonia is cheaper if hydrogen is cheaper.

By applying trade restrictions, the amount of exported ammonia is decreasing. In the SoS2 scenario, Middle East Asia and Africa are the least cost exporters. Central and South America, the USA and Australia are also an option if trade restrictions are considered. China also has export options according to the results if five exporters are permitted to compete with local production.

The production of ammonia shows clear trends that are already visible in the export structure. The ammonia demand is fully produced locally in case of no climate policy (BAU) (Fig. 11). In contrast, the overall demand for ammonia is satisfied by Middle East Asia if there are no trade restrictions applied (1_5D). In the 1_5D scenario, it is evident from the production patterns that Middle East Asia is the exclusive producer of ammonia (Fig. 11).

In the case of trade restrictions, the production structure is changing as 50% of the demand must be satisfied by local production. Therefore, almost half of the overall demand is still satisfied by Middle East Asia (Fig. 11). This pattern only starts to change if another level of security is applied by considering the SoS2 scenario. In

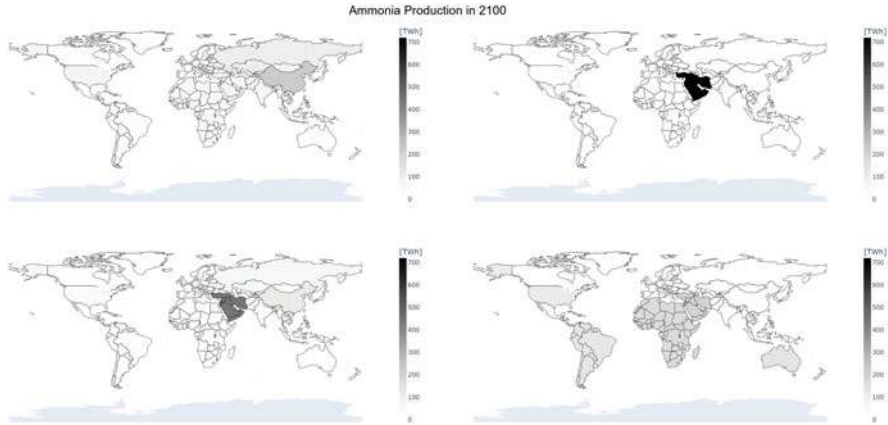

Fig. 11 Global ammonia production in 2100 (BAU top left; 1_5D top right; SoS1 bottom left, SoS2 bottom right)

this case Africa, Central and South America, the USA, Australia, and China start to expand their production to start ammonia trades.

5 Discussion

In the process of achieving Net zero by 2050 and addressing SDG goal 13- Climate action, electricity will have the major share of final energy consumption and PV will play the key role in producing more than 50% of the electricity as shown in the scenarios 1_5D, SoS1 and SoS2. Moreover, the production and trade of clean energy carriers, green hydrogen and ammonia, also play an important role in achieving the Net Zero target. Four different scenarios are introduced here for this energy system analysis. The scenarios SoS1 and SoS2 are specially designed to contribute to SDG Goal 7—Affordable and Clean Energy. These scenarios aim to ensure that all countries can affordably produce and import clean energy carriers. For both green hydrogen and green ammonia, the Middle East Asia region has the highest share of production and export in the scenarios 1_5D and SoS1. By imposing a maximum of 20% export per country constraint and avoiding monopoly, the scenario SoS2 shows other potential regions for export. These primarily include Africa, Central and South America, USA, Australia, and India. Europe is found to be the region with the least production and export of energy carriers in achieving the Net Zero goal. This shows that Europe will be heavily dependent on imports of green hydrogen and ammonia. These results are in line with the findings of the literature research where most of them considered Germany or Europe, in general, as the import region with export from regions in Middle East Asia, Central and South America and Australia. China,

while having significant production potential for both green hydrogen and ammonia, exhibits limited export potential due to large domestic industries and high self-consumption.

This study utilizes the global TIAM model to assess future energy flows through a least-cost optimization framework, which introduces some limitations to the investigation due to the following assumptions:

- Every region (except Africa) has 1 export/import port. The global trade of hydrogen and ammonia is highly sensitive to the shipping route distance. This might cause allocation errors, as there are shorter routes available. This investigation only considers the major ports of current maritime transport as they can be used for hydrogen and ammonia trades in the future.
- Pipeline transport for hydrogen and ammonia is a promising option but not considered in this investigation as the aim of this investigation is on trade restrictions. Pipelines are characterized higher in CapEx but once built the additional cost are lower in comparison, but this only works if pipelines are the main option for transport which is not in line with our investigation.
- In this investigation the cost potential curves derived by Franzmann et al. (2023) are used as this is one of the most recent studies on hydrogen cost on a global scale and also in line with the TIAM regions. This study primarily focuses on solar PV and onshore wind for hydrogen production. Wind offshore is not considered, which could be preferable for certain regions.
- This investigation does not consider subsidies or tax credit programs such as the Inflation Reduction Act (IRA) in the USA (Senate of the United States 2022) or other national programs. Instead, a full least-cost approach is used for this assessment in order to investigate the global allocation structure based on the possible LCOH.
- The demand for end-use commodities (e.g. steel, cement etc.) is not modeled using elasticities. Therefore, higher costs do not result in reduced demand, a phenomenon that could emerge in reality.

6 Conclusion and Outlook

In this research, an initial investigation was done on final energy consumption and electricity supply globally for each final energy sector until 2100 by selecting four possible scenarios aligned with climate policies. It is shown that electricity demand has the major share of energy consumption in 2100 for all the scenarios. Even without climate policies, solar PV and wind energy contribute to over 50% of the global electricity production. In the other scenarios with climate policies, solar PV and wind energy contribute to over 70% of the global electricity production. Hydrogen and synfuels account for 11% of the final energy consumption considering the climate policies. Hydrogen plays a major role in decarbonizing the global energy system and the demand is strongly increasing over time. Based on these results, CO₂

emissions are evaluated for each scenario until 2100. It shows that net zero is possible in 2050 among different scenarios that consider climate policies. In contrast to this, the total net CO₂ emissions without climate policy (BAU scenario) remain at a level of approximately 28 Gt. A further analysis was performed on the trade of emission-free energy carriers such as green hydrogen and ammonia among various regions globally until 2100. In the scenario without climate policies applied (BAU), it is shown that there is no trade of hydrogen and ammonia. Depending on the level of trade restrictions, the export structure is changing, if climate policies are taken into consideration. Without restrictions on trading, it clearly shows that Middle East Asia becomes the leading producer and exporter of these low-carbon fuels. By considering trade restrictions (Scenario SoS2), exports from Africa, Central and South America as well as Australia, for both hydrogen and ammonia are potentially possible.

In this trade analysis, Europe is shown as import dependent. Even with the highest level of trade restrictions applied, imports are cheaper than local production in ammonia and hydrogen. Other regions, such as India and Other Developing Asia become self-sufficient along all scenarios.

Another finding from our research was that the ammonia exports are used directly for the ammonia demand associated with each TIAM region. Therefore, ammonia is not used to satisfy the hydrogen demand by using back cracking technologies. Instead, LH₂ transport is preferred in comparison to ammonia transport if hydrogen is demanded.

The overall structure of the global low-carbon fuel trade shows similarities to common high-carbon fuel trades today. This could lead to a switch in fuels with the remaining export regions as they could maintain their business model in the future and export cheaper low-carbon fuels in comparison to other regions.

This investigation has shown that the Net Zero target is feasible in different scenarios considering climate policies and trade restrictions. If the export structure is changing (due to trade restrictions) this leads to higher overall system costs as other exporters are considered with more distance in shipping route and higher LCOH in production. However, there is no significant change in fuel use as shown in the final energy consumption. In the future, a reduction in the demand for hydrogen and ammonia is also possible as a result of material efficiency measures or a circular economy in all the sectors. This leads to lower net exports and simultaneously, positive effects on global emissions.

References

- A-ETSAP and IRENA (2012) Water desalination using renewable energy. Technology brief (IEA-ETSAP and IRENA technology brief). <https://www.irena.org/-/media/Files/IRENA/Agency/Publication/2012/IRENA-ETSAP-Tech-Brief-I12-Water-Desalination.pdf>. Accessed 30 Jan 2023
- Ausfelder F, Du Tran D, Cadavid Isaza A, La Rua C, de Gawlick J, Hamacher T et al (2022) 4. Roadmap des Kopernikus-Projektes P2X Phase II—OPTIONEN FÜR EIN NACHHALTIGES

- ENERGIE- SYSTEM MIT POWER-TO-X- TECHNOLOGIEN. Transformation—Anwendungen—Potenziale. Unter Mitarbeit von DECHEMA
- BCG (2021) Klimapfade 2.0. Ein Wirtschaftsprogramm für Klima und Zukunft. <https://web-assets.bcg.com/f2/de/1fd134914bfaa34c51e07718709b/klimapfade2-gesamtstudie-vorabversion-de.pdf>. Accessed 02 Mar 2023
- BP (2011) Statistical review of world energy June 2011. BP Statistical Review. <http://large.stanford.edu/courses/2011/ph240/goldenstein1/docs/bp2011.pdf>
- BP (2022) Statistical review of world energy 2022. BP Statistical Review. <https://www.bp.com/content/dam/bp/business-sites/en/global/corporate/pdfs/energyeconomics/statistical-review/bp-stats-review-2022-full-report.pdf>
- Brändle G, Schönfisch M, Schulte S (2020) Estimating long-term global supply costs for low-carbon hydrogen. https://www.ewi.uni-koeln.de/cms/wp-content/uploads/2021/03/EWI_WP_20-04_Estimating_long-term_global_supply_costs_for_low-carbon_Schoenfisch_Braendle_Schulte-1.pdf. Accessed 02 Mar 2023
- Deutsche Energie-Agentur GmbH (2021) Dena-Leitstudie Aufbruch Klimaneutralität. https://www.dena.de/fileadmin/dena/Publikationen/PDFs/2021/Abschlussbericht_dena-Leitstudie_Aufbruch_Klimaneutralitaet.pdf. Accessed 02 Mar 2023
- Egerer J, Grimm V, Niazmand K, Runge P (2023) The economics of global green ammonia trade—“Shipping Australian wind and sunshine to Germany”. *Appl Energy* 334(3):120662. <https://doi.org/10.1016/j.apenergy.2023.120662>
- FICHTNER (2011) MENA regional water outlook. Part II desalination using renewable energy. Final report. Unter Mitarbeit von Dr. Fulya Verdier. Hg. v. FICHTNER. Stuttgart. https://www.dlr.de/tt/Portaldata/41/Resources/dokumente/institut/system/projects/MENA_REGIONAL_WATER_OUTLOOK.pdf. Accessed 30 Jan 2023
- Franzmann D, Heinrichs H, Lippkau F, Addanki T, Winkler C, Buchenberg P et al (2023) Green hydrogen cost-potentials for global trade. *Int J Hydrog Energy* 45(11):6793. <https://doi.org/10.1016/j.ijhydene.2023.05.012>
- Galimova T, Fasihi M, Bogdanov D, Breyer C (2023) Impact of international transportation chains on cost of green e-hydrogen: global cost of hydrogen and consequences for Germany and Finland. *Appl Energy* 347:121369. <https://doi.org/10.1016/j.apenergy.2023.121369>
- GlobalCarbonAtlas (2023) <http://www.globalcarbonatlas.org/en/CO2-emissions>. Accessed 22 Jan 2023
- Hampf J, Düren M, Brown T (2023) Import options for chemical energy carriers from renewable sources to Germany. *PLOS One* 18(2):e0262340. <https://doi.org/10.1371/journal.pone.0281380>
- IEA (2018) World energy outlook 2018. Hg. v. International Energy Agency (IEA), Paris. <https://www.iea.org/reports/world-energy-outlook-2018>. Accessed 30 Jan 2023
- IEA (2020) G20 Hydrogen report: assumptions. <https://iea.blob.core.windows.net/assets/a02a0c80-77b2-462e-a9d5-1099e0e572ce/IEA-The-Future-of-Hydrogen-Assumptions-Annex.pdf>. Accessed 02 Mar 2023
- IEA (2021) World energy outlook 2021. Hg. v. International Energy Agency (IEA), Paris. <https://www.iea.org/reports/world-energy-outlook-2018>. Accessed 30 Jan 2023
- IEA (2023) World energy statistics and balances. https://www.oecd-ilibrary.org/energy/data/iea-world-energy-statistics-and-balances/extended-world-energy-balances_data-00513-en. Accessed 01 Dec 2023
- International Energy Agency (2020) IEA G20 hydrogen report. https://iea.blob.core.windows.net/assets/29b027e5-fefc-47df-aed0-456b1bb38844/IEA-The-Future-of-Hydrogen-Assumptions-Annex_CORR.pdf. Accessed 01 Dec 2022
- IRENA (2022) Global hydrogen trade to meet the 1.5°C climate goal. Part II: technology review of hydrogen carriers. <https://www.irena.org/publications/2022/Apr/Global-hydrogen-trade-Part-II>. Accessed 02 Mar 2023
- Ishimoto Y, Voldsund M, Nekså P, Roussanaly S, Berstad D, Gardarsdottir SO (2020) Large-scale production and transport of hydrogen from Norway to Europe and Japan: value chain analysis and comparison of liquid hydrogen and ammonia as energy carriers. *Int J Hydrog Energy* 45(58):32865–32883. <https://doi.org/10.1016/j.ijhydene.2020.09.017>

- Johnston C, Ali Khan MH, Amal R, Daiyan R, MacGill I (2022) Shipping the sunshine: an open-source model for costing renewable hydrogen transport from Australia. *Int J Hydrog Energy* 47(47):20362–20377. <https://doi.org/10.1016/j.ijhydene.2022.04.156>
- Lippkau F, Franzmann D, Addanki T, Buchenberg P, Heinrichs H, Kuhn P et al (2023) Global hydrogen and synfuel exchanges in an emission-free energy system. *Energies* 16(7):3277. <https://doi.org/10.3390/en16073277>
- Loulou R (2008) ETSAP-TIAM: the TIMES integrated assessment model. Part II: mathematical formulation. *Comput Manag Sci* 5:41–66. <https://link.springer.com/article/10.1007/s10287-007-0045-0>. Accessed 13 Feb 2024
- Luderer G, Kost C, Dominika (2021) Deutschland auf dem Weg zur Klimaneutralität 2045 – Szenarien und Pfade im Modellvergleich. https://ariadneprojekt.de/media/2021/11/Ariadne_Szenarienreport_Oktober2021_Kapitel1_Gesamtperspektive.pdf. Accessed 02 Mar 2023
- Mousavi B (2019) Analysis of the relative roles of supply-side and demand-side measures in tackling global climate change. Application of a hybrid energy system model 2018. https://elib.uni-stuttgart.de/bitstream/11682/10625/1/20190903_Babak%20Mousavi-PDF%20of%20dissertation-final.pdf. Accessed 30 Jan 2023
- Nel ASA (2020) M series containerized: proton PEM hydrogen generation systems. Model MC250. Hg. v. Nel ASA. <https://nelhydrogen.com/wp-content/uploads/2022/06/M-Series-Containerized-Spec-Sheet-Rev-E.pdf>. Accessed 30 Jan 2023
- Öko-Institut e.V., Wuppertal Institut, prognos (2021) Klimaneutrales Deutschland 2045. https://static.agora-energiewende.de/fileadmin/Projekte/2021/2021_04_KNDE45/A-EW_209_KNDE2045_Zusammenfassung_DE_WEB.pdf. Accessed 02 Mar 2023
- Pietzcker RC, Osorio S, Rodrigues R (2021) Tightening EU ETS targets in line with the European Green Deal: impacts on the decarbonization of the EU power sector. *Appl Energy* 293:116914. <https://doi.org/10.1016/j.apenergy.2021.116914>
- Rogelj J, Shindell D, Jiang K, Fifita S, Forster P, Ginzburg V, Handa C, Kheshgi H, Kobayashi S, Kriegler E, Mundaca L, Séférian R, Vilariño MV (2018) Mitigation pathways compatible with 1.5°C in the context of sustainable development. In: *Global Warming of 1.5°C. An IPCC special report on the impacts of global warming of 1.5°C above pre-industrial levels and related global greenhouse gas emission pathways, in the context of strengthening the global response to the threat of climate change, sustainable development, and efforts to eradicate poverty*. https://www.ipcc.ch/site/assets/uploads/sites/2/2019/02/SR15_Chapter2_Low_Res.pdf
- Sagel VN, Rouwenhorst KHR, Faria JA (2022) Renewable electricity generation in small Island developing states: the effect of importing ammonia. *Energies* 15(9):3374. <https://doi.org/10.3390/en15093374>
- Schemme S (2020) Techno-ökonomische Bewertung von Verfahren zur Herstellung von Kraftstoffen aus H₂ und CO₂: Forschungszentrum Jülich GmbH Zentralbibliothek, Verlag (Schriften des Forschungszentrums Jülich, 511). <https://publications.rwth-aachen.de/record/803938/files/803938.pdf>. Zuletzt geprüft am 30 Jan 2023
- Schmidt O, Gambhir A, Staffell I, Hawkes A, Nelson J, Few S (2017) Future cost and performance of water electrolysis: an expert elicitation study. *Int J Hydrog Energy* 42(52):30470–30492. <https://doi.org/10.1016/j.ijhydene.2017.10.045>
- Senate of the United States (2022) Inflation Reduction Act. https://www.democrats.senate.gov/imo/media/doc/inflation_reduction_act_of_2022.pdf. Accessed 25 Jan 2023
- Staffell I, Scamman D et al (2019) The role of hydrogen and fuel cells in the global energy system. *Energy Environ Sci* 12(2):463–491. <https://doi.org/10.1039/C8EE01157E>
- Teichmann D, Arlt W, Wasserscheid P (2012) Liquid organic hydrogen carriers as an efficient vector for the transport and storage of renewable energy. *Int J Hydrog Energy* 37(23):18118–18132. <https://doi.org/10.1016/j.ijhydene.2012.08.066>
- United Nations (2016) Framework convention on climate change (COP21) Paris agreement. <https://unfccc.int/process-and-meetings/the-paris-agreement/the-paris-agreement>. Accessed 22 Jan 2023
- USGS (2023) Mineral commodity summaries 2023
- van der Zwaan B, Lamboo S, Dalla Longa F (2021) Timmermans’ dream: an electricity and hydrogen partnership between Europe and North Africa. *Energy Policy* 159:112613. <https://doi.org/10.1016/j.enpol.2021.112613>

Open Access This chapter is licensed under the terms of the Creative Commons Attribution 4.0 International License (<http://creativecommons.org/licenses/by/4.0/>), which permits use, sharing, adaptation, distribution and reproduction in any medium or format, as long as you give appropriate credit to the original author(s) and the source, provide a link to the Creative Commons license and indicate if changes were made.

The images or other third party material in this chapter are included in the chapter's Creative Commons license, unless indicated otherwise in a credit line to the material. If material is not included in the chapter's Creative Commons license and your intended use is not permitted by statutory regulation or exceeds the permitted use, you will need to obtain permission directly from the copyright holder.



Net-Zero Transition in Ukraine: Implications for Sustainable Development Goal 7



**Maksym Chepeliev, Oleksandr Diachuk, Roman Podolets, Andrii Semeniuk,
and Galyna Trypolska**

Abstract In this study, we use a TIMES-Ukraine energy system-wide model to explore net-zero transition in Ukraine. The assessment considers the potential implications of the ongoing war in the country and analyzes how the achievement of ambitious mitigation goals could impact the indicators related to the Sustainable Development Goal on energy, SDG7 (Ensure access to affordable, reliable, sustainable and modern energy). Results suggest that the net-zero transition would help improve several SDG7 indicators, including increased share of renewables in total final energy consumption, and increased energy affordability in the long run. However, in the medium run, increasing energy prices and rising investment needs might challenge the net-zero transition in the country. Overall cumulative investment needs increase by around 23% over the analyzed time horizon with the major portion being concentrated within the 2030–2045 timeframe. Major efforts need to be made to ensure the availability of a wide range of options for clean and green energy financing in Ukraine, including a reduction of the bond yield rates, creation of the specialized funds to support the ‘green’ transition, as well as the creation of a more competitive domestic environment through increasing mitigation ambition. If successfully implemented, these will allow Ukraine to rebuild the domestic energy system in a more technologically advanced and climate-friendly way, at the same time further supporting the country’s sustainable development agenda.

M. Chepeliev (✉)
Purdue University, West Lafayette, IN, USA
e-mail: mchepeli@purdue.edu

O. Diachuk · R. Podolets · A. Semeniuk · G. Trypolska
Institute for Economics and Forecasting, Kyiv, Ukraine
e-mail: oadyachuk@ukr.net; r.podolets@gmx.de; semeniuk.and.i@gmail.com;
g.trypolska@gmail.com

© The Author(s) 2024

M. Labriet et al. (eds.), *Aligning the Energy Transition with the Sustainable Development Goals*, Lecture Notes in Energy 101,
https://doi.org/10.1007/978-3-031-58897-6_12

271

Key Messages

- Net-zero transition would help improve several SDG7 dimensions in Ukraine— increase electricity supply and share of renewables, but it would have a very limited effect on the energy intensity and energy dependency of the economy.
- Energy affordability would improve in the long run, but growing electricity and heat prices could challenge the ambitious climate mitigation efforts in the medium run.
- Increased international financing, a more competitive domestic environment, and higher carbon prices are required to close the major financing gap for achieving the net-zero transition.
- The assessment captures economic and demographic aspects of the Russian-Ukrainian war and provides additional support for the ‘green’ and sustainable recovery of Ukraine.

1 Introduction

Since the adoption of the Paris Agreement on climate change in December 2015 (UNFCCC 2015), many countries have further increased the level of their climate ambition. While in their original contributions, only several countries, such as Costa Rica, Bhutan and Sweden, announced net-zero greenhouse gas (GHG) emission pledges (Höhne et al. 2021), as of 2023, a total of 79 countries, including Ukraine, have communicated net zero goals in either policy documents (52 countries) or laws (27 countries) (Energy & Climate Intelligence Unit 2023). Achieving such ambitious mitigation targets require a departure from the historically observed developmental trajectory, implying drastic transformations for the energy system (Azevedo et al. 2021; Rogelj et al. 2015), changes in behavioral patterns, such as dietary shifts toward less meat-oriented food systems (Clark et al. 2020; Theurl et al. 2020), as well as major infrastructural upgrades in many cases requiring an early retirement of the existing fossil fuel and energy-intensive capital assets (Tong et al. 2019).

An important aspect of climate mitigation policies is their interaction with various dimensions of the sustainable development agenda. This includes a better understanding of synergies and tradeoffs between emission reductions and access to affordable, reliable, sustainable and modern energy (Sustainable Development Goal 7) (e.g. Fujimori et al. 2020; Von Stechow et al. 2016; Fuso Nerini et al. 2019).

In the case of Ukraine, there have been no earlier studies that explicitly analyzed the synergies and tradeoffs between stringent climate mitigation action and SDG7. However, several studies have provided an assessment of the selected aspects of the energy system functioning under ambitious mitigation pathways and varying technological options. Chepeliev et al. (2021) explored two ambitious climate mitigation scenarios achieving 68% and 83% in GHG emissions reduction in 2050 relative to the 2010 level and focused on the role of bioenergy in Ukraine. Authors find that under the most ambitious mitigation scenario, the share of modern renewable energy sources (excluding nuclear) substantially increases over time reaching over 38% of

the total primary energy supply in 2050, with over half of this being supplied by biofuels. Achievement of the ambitious mitigation goals (83% reduction in GHG emissions in 2050 relative to the 2010 level) increases overall energy system costs by 1.8% relative to the reference scenario with no targeted mitigation efforts. Constraining the bioenergy supply at the reference scenario level could more than double the mitigation costs compared with the unconstrained case. In the context of SDG7, these results provide a quantification of potential tradeoffs between access to clean and renewable energy sources, and energy affordability.

Child et al. (2017) analyze the role of storage technologies in the process of Ukraine's transition to a 100% renewable energy system by 2050. Authors find that the adoption of low-cost renewable energy generation might reduce the levelized cost of electricity over time compared to the current level, thus making it more affordable to the intermediate and final users. At the same time, the authors note several barriers that might prevent a country from succeeding in such a transition, including modernization of the existing energy infrastructure, improvements in energy efficiency, as well as stability of the investment environment and of the legislation system.

Finally, Chepeliev et al. (2023b) take into account the impacts of the war in Ukraine in terms of changes in the future energy supply and demand and explore the role of nuclear power generation under an ambitious climate scenario. Overall, the authors find that the war in Ukraine could reduce the long-term energy demand and emissions under the reference scenario compared to the pre-war forecasts, which could provide additional incentives for implementing stringent mitigation efforts. Results suggest that the achievement of a net-zero emission target in 2050 is associated with a 13% increase in the total system costs compared to the reference (no-mitigation) case with a larger amount of investments needed during the 2030–2035 period. Such transition, however, is associated with a substantial increase in the share of carbon-free energy sources, as by 2050 the primary supply of both coal and gas declines by 98% compared to the 2020 level.

In summary, existing literature provides useful insights into challenges and opportunities for implementing ambitious mitigation efforts in the country with some preliminary findings about the post-war recovery of the country's economy and energy system. However, a detailed assessment of the interactions between net-zero transition in Ukraine and the achievement of SDG7 has not been provided in the earlier studies. In addition, the context of the war in Ukraine provides an important aspect for designing future mitigation policies and assessing their impact on the affordability, reliability and sustainability of the energy supply in the country. In the current study, we aim to comprehensively address these important aspects.

The rest of the chapter is organized as follows. Section 2 provides an overview of the state of the progress on achieving the SDG7 targets in Ukraine. Section 3 discusses the methodological framework that is employed in this study, including the TIMES-Ukraine energy system-wide model and the developed scenarios. Section 4 provides an overview of the key results across the analyzed scenarios. Section 5 complements the scenario assessment part with a discussion of financing options that could enable the implementation of ambitious climate mitigation policies in Ukraine. Finally, Sect. 6 concludes.

2 SDG7: State of the Progress in Ukraine

Achievement of the SDGs in Ukraine has been supported by the Presidential decree from 2019 (President of Ukraine 2019), taking into account Ukraine's national development strategy outlined in the 2017 National Baseline Report "Sustainable Development Goals: Ukraine" (Ministry of Economic Development and Trade of Ukraine 2017). The latter introduces a system of 86 targets with the corresponding quantitative indicators and monitoring mechanisms. Governmental Regulations updated at the end of 2020 (CMU 2020) made the Sustainable Development Goals an integral part of Ukraine's policy planning.

Table 1 provides a summary of the historically observed values of the SDG7 indicators in Ukraine as reported by the UN (2023). In terms of the population's access to electricity (SDG 7.1.1) and reliance on clean fuels and technology (SDG 7.1.2), prior to the war Ukraine achieved sufficient progress. However, recent and ongoing attacks on the country's power plants might have impacted these metrics. The share of renewable energy has increased by over 6 times between 2000 and 2020 reaching 8.7% of total final energy consumption, however, it was still far below the EU average share of 21.8%, as well as substantially lower than that of all Eastern European EU member states (UNECE 2023a). Substantial progress over the past two decades has been also achieved in terms of reductions in energy intensity of GDP, which has declined by over two times over this period and reached 7.0 MJ/USD2017 (in purchasing power parity—PPP). Though as in the case of the renewable energy share, Ukraine is also lagging behind its Eastern EU neighbors, having an energy intensity of GDP two times higher than Poland and almost three times higher than Romania (UNECE 2023b), with much more substantial progress needed in the future. Finally, in terms of attracting international financial flows to support net-zero transition in the country, while the situation has somewhat improved since 2015, substantial progress is needed, as major financing barriers still remain, as discussed in more detail in Sect. 5. During the 2000–2021 period, Ukraine

Table 1 Stocktaking of historical SDG7 indicators for Ukraine

SDG indicator/year	2000	2005	2010	2015	2020	2021
7.1.1 Proportion of population with access to electricity, %	99.1	99.9	100	100	100	100
7.1.2 Proportion of population with primary reliance on clean fuels and technology, %	91	93	94	>95	>95	>95
7.2.1 Renewable energy share in the total final energy consumption, %	1.3	1.3	2.9	4.2	8.7	NA
7.3.1 Energy intensity, megajoules per USD of GDP in USD 2017 PPP	15.2	11.1	9.9	8.1	7.0	NA
7.a.1 International financial flows in support of clean energy research and development and renewable energy production, millions of EUR 2020	0	115.6	1.1	10.1	35.9	235.6

Source: Based on UN (2023)

attracted a total of around 1.9 billion EUR of international financial flows, which is less than 2% of the country’s 2020 GDP.

The Sustainable Development Report 2023 (Sachs et al. 2023) assesses the overall Ukraine’s SDG Index Rank as 38 out of 166 countries scoring 76.5 points out of 100 with a spillover score of 96.7 out of 100 indicating that Ukraine causes more positive and fewer negative spillover effects on neighboring countries. At the same time, the report also indicates that regarding the progress on the SDG7 in Ukraine “significant challenges remain” and that the country’s “score (has been) moderately improving, insufficient to attain (the) goal” (Sachs et al. 2023).

National stocktaking of the SDG indicators outlines a somewhat different set of the SDG7 dimensions compared to those reported in Table 1 above, reflecting country-specific goals set by the Ukrainian government (SSSU 2021; Ministry of Economic Development and Trade of Ukraine 2017) (Fig. 1). Additional indicators include dimensions of import dependency and energy security, such as the

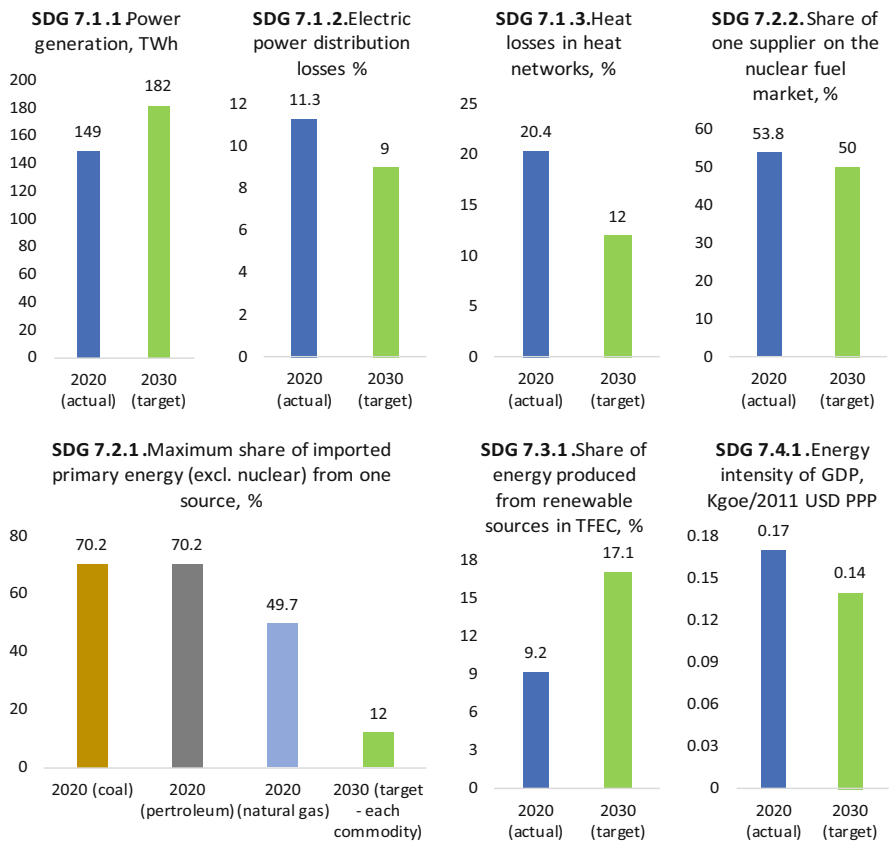

Fig. 1 Historical and targeted SDG7 indicators for Ukraine. (Source: Based on SSSU (2021) and Ministry of Economic Development and Trade of Ukraine (2017))

maximum share of imported energy from one source (for various fuels)—SDGs 7.2.1 and 7.2.2; electric power and heat networks losses (SDGs 7.1.1 and 7.1.2); and overall power generation volumes (SDG 7.1.1), though the latter might be adjusted based on the changes in the future electricity demand (Fig. 1). Overall, while the country is on track to achieve 2030 goals for the two SDG7 indicators out of the seven reported below—GDP energy intensity (SDG 7.4.1) and the maximum share of one supplier on the nuclear fuel market (SDG 7.2.2) due to the partnership with Westinghouse Electric, achievement of the remaining SDG7 indicators remains a challenging task complicated by the ongoing war, as well as a number of institutional and market barriers, as further discussed in Sects. 5 and 6. In this context, it is important to understand what role the net-zero transition in Ukraine could play in helping to achieve sustainable development goals and what synergies and tradeoffs that may arise in this regard.

3 Methodology

3.1 *TIMES-Ukraine Energy System Model*

To explore the net-zero transition in Ukraine, we use the TIMES-Ukraine energy system-wide model (Chepeliev et al. 2023a; EBRD 2020; Diachuk et al. 2017). This is a linear programming optimization model of energy flows. The energy system of Ukraine is represented in the TIMES-Ukraine model as a single region and consists of seven sectors: the energy supply sector (production, imports, exports, international bunkers, stock changes, and the production of secondary energy resources—petroleum products, briquettes, etc.); electricity and heat production; industry; transport; residential users (household); trade and services; and agriculture (including fishing). The energy system in the model covers the IPCC sectors “Energy” and “Industrial processes and product use” till 2060.

The model has one region which represents the entire Ukraine with 96 annual time slices. The latter is obtained by the combination of the following dimensions: 4 seasonal (winter, spring, summer, autumn) and 24 daily levels (hours). TIMES-Ukraine takes into account international trade in energy, including electricity imports/exports from/to the European Network of Transmission System Operators for Electricity (ENTSO-E). Assumptions regarding net transfer capacities between Ukraine and the EU are implemented based on the conservative case scenario by Ukrenergo (REKK et al. 2024). Figure 2 provides an overview of the energy system representation in the TIMES-Ukraine model.

TIMES-Ukraine model provides a granular coverage of the Ukrainian energy system, representing 2050 processes and 823 commodities. A detailed overview of the underlying technological and cost assumptions of the TIMES-Ukraine model used in this study is available in Chepeliev et al. (2023b). Several updates have been introduced in terms of technological parametrization in the current study. First, the availability factor for new large nuclear power plants (NPPs) is set at 88% and for

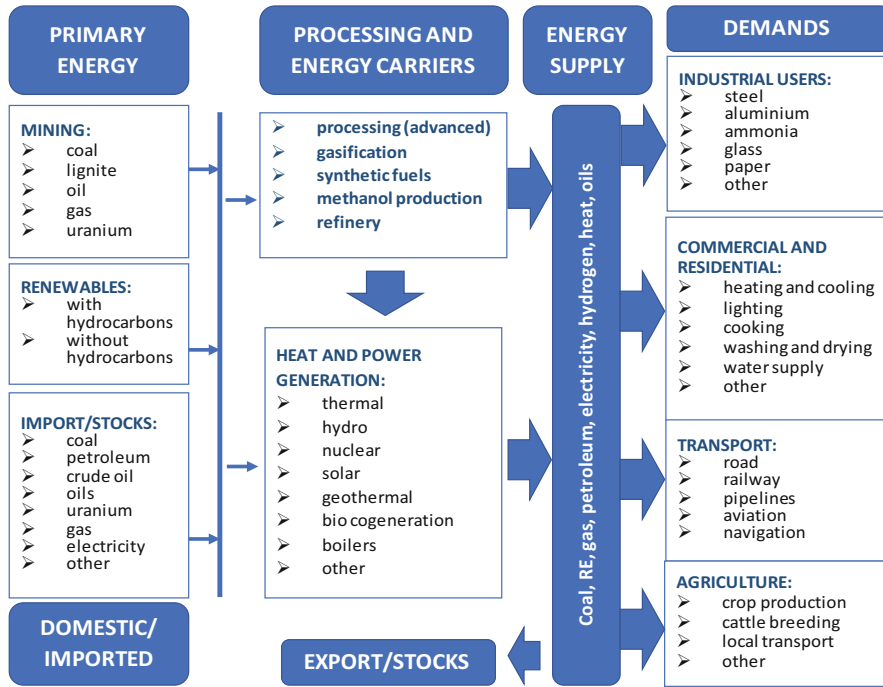

Fig. 2 Schematic representation of the energy system in the TIMES-Ukraine model. *Notes:* The figure provides a schematic representation of the energy system in the TIMES-Ukraine model. An actual representation of the energy system within the modeling framework is much more detailed and includes over 2000 technologies. For a more detailed description of the TIMES-Ukraine model, an interested reader is referred to Chepeliev et al. (2023b), EBRD (2020), and Diachuk et al. (2017). “RE” stands for renewable energy. (Source: Reproduced with permission from Chepeliev et al. (2021))

small modular reactors at 90%. Second, availability factor for onshore wind is set at 32%, while offshore wind has been introduced to the model—with capital expenditures (CAPEX) ranging between 2120 and 1640 EUR/kWe across years, declining over time, and availability factor of 42%. Third, an updated parametrization of storage capacities has been introduced to the model with lifetime across storage types ranging between 20 and 30 years, and CAPEX ranging between 1042 EUR/kWe in 2020 and 255 EUR/kWe in 2050. Finally, the model has an updated representation of hydrogen technologies, including three types of electrolyzer (alkaline, proton-exchange membrane and solid oxide electrolyzer cell).

An overall approach to the energy policy assessment within the TIMES-Ukraine modeling framework, which is applied in the current study, includes several steps. *First*, data on the underlying drivers of the future energy supply and demand are collected. These include macroeconomic and sectoral value-added forecasts, demographic forecasts, energy price forecasts, etc. *Second*, a reference scenario is

developed, based on the assumptions of future energy demand, macroeconomic and demographic forecasts, technological assumptions, price forecasts, etc. *Third*, policy (e.g. net-zero transition) scenario is designed by imposing additional constraints or targets for energy system development. For each scenario (reference and policy scenarios) the model estimates the least-cost trajectory of the system, i.e. energy supply and demand by sector and fuel type, energy prices, the optimal technology mix, etc. Based on such data, the cost of the selected policy pathways, most efficient technologies, as well as required energy system transformations can be identified and analyzed. TIMES-Ukraine provides an intertemporal optimization based on perfect foresight. The next section provides a discussion of the reference and policy scenarios.

3.2 Scenario Framework

The reference scenario (REF) is developed to achieve the targeted energy demand in a least-cost way, where the specific technological solutions are chosen from the list of available options to minimize the total energy system costs over the analyzed time horizon. The specification of energy demand is driven by exogenously estimated drivers provided to the model, including GDP forecast, value-added across sectors, industrial output forecasts, as well as demographic changes. Our reference scenario assumes that the GDP grows by 3.5% in 2024 and 6.8% in 2025 following the forecast by the National Bank of Ukraine (NBU 2023). It is assumed that Ukraine's territorial integrity will be restored starting from 2026 and that during the 2026–2030 period, the GDP will be growing at 5% per year. The growth rate is assumed to decline over time, reaching 2–3% during the 2031–2060 period.

No major structural transformations are assumed within the reference scenario as the share of services moderately increases over time. Supporting the country's economic recovery major capital generation activity—the construction industry more than doubles its share in the country's value-added over the analyzed period. It is assumed that the agricultural sector sustains its important role in the national economy, while the share of manufacturing activities moderately declines over time.

The demographic forecast takes into account the projected movements of refugees. As of May 2022, 6.4 million refugees fled Ukraine (UNHCR 2022), although 79% of them intend to return (Razumkov Center 2022). For the post-2022 period, the population growth rate follows the medium scenario from PIDSS (2022). It should be noted that the current assessment does not take into account the impacts of the energy infrastructure damage caused by the war, which could influence energy policy decisions in the short term. The data on the energy infrastructure and power plants' damage is classified and not publicly available.

To explore the impacts of the ambitious mitigation efforts in Ukraine, we develop a GHG emissions reduction scenario consistent with reaching Net-Zero Emissions (NZE) in IPCC “Energy” and “Industrial processes and product use” sectors in 2050 and preservation of net-zero emissions through the end of the simulation horizon.

Emissions in agricultural and forestry sectors are not explicitly represented in the model (except those from fuel combustion or energy use). Thus, to achieve economywide net-zero emissions additional mitigation efforts would be needed in these sectors. The developed net-zero GHG emissions scenario is consistent with Ukraine’s fair contribution of limiting global warming well below 2 °C (Fig. 3) based on the equity principles applied within the Climate Action Tracker (CAT 2020). The choice of an alternative equity approach might result in a different stringency of the mitigation targets for Ukraine, although as shown in Chepeliev et al. (2021), an approach used in this study results in a more ambitious mitigation target for Ukraine than the average over five IPCC equity categories discussed in Robiou du Pont et al. (2017). It should be noted, however, that neither of the equity approaches reported above take into account the implications of the war and can be considered feasible in the long run, i.e. assuming that Ukraine’s territorial integrity is restored and the economy has recovered from the impacts of the war.

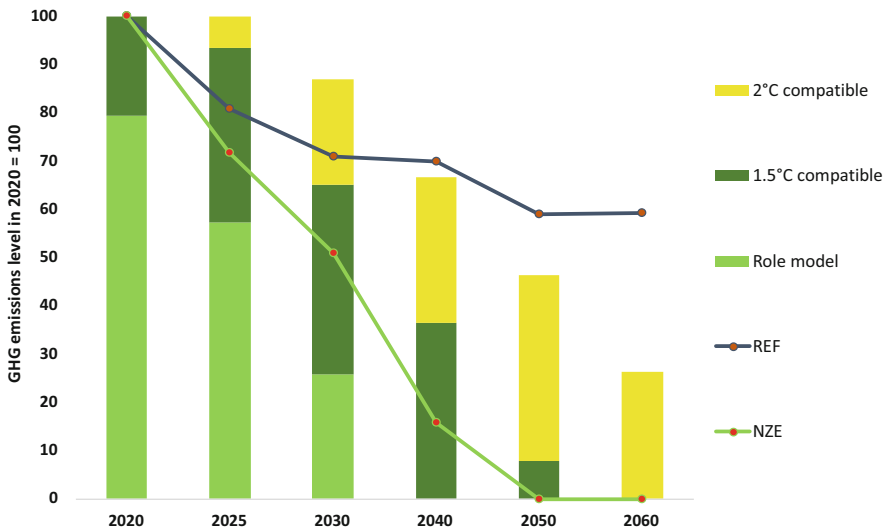

Fig. 3 GHG emission trajectories across scenarios and Ukraine’s fair contribution to mitigating global warming. *Notes:* Quantification of the mitigation targets for Ukraine are based on the CAT (2020) estimates that include the impact of COVID-19 but do not include the impacts of the war. The emission level in 2020 is indexed to 100. Considering that CAT (2020) reports emissions for 2030 and 2050 years, 2040 levels were estimated using linear approximation between 2030 and 2050; emissions for 2060 have been constructed using linear approximation of emission changes between 2040 and 2050. “Role model” corresponds to the case of mitigation that is more ambitious than limiting global warming to 1.5 °C. (Source: Developed by authors based on CAT (2020) and TIMES-Ukraine model)

4 Results

4.1 Implications for the Energy System

Achievement of ambitious mitigation targets within the NZE scenario sees major transformations of the national energy system. While in the reference scenario fossil fuels constitute a substantial share of the final energy consumption (FEC) even in the long-run—around 34% in 2050 (Fig. 4a), net-zero emissions scenario sees almost complete elimination of the fossil fuels in FEC post-2045 (Fig. 4b). Such transition is also accompanied by a substantial increase in electrification rates, as the latter grows from 37% of FEC under the REF scenario in 2050 to almost 61% in the NZE scenario (Fig. 4a, b). As further discussed below, electricity generation mix under the NZE scenario is also becoming cleaner. Increasing electrification rates and penetration of more advanced technologies, such as hybrid and electric vehicles, heat pumps, etc., combined with energy efficiency improvements, lead to an overall reduction in FEC within the NZE scenario, as it declines by around 15% compared to the REF scenario in 2050 (Fig. 4a, b). Such energy efficiency improvement channel reduces the pressure on the household energy bills within the ambitious climate mitigation scenario.

Despite substantial reduction in the share of fossil fuels in final energy consumption, such use is not completely eliminated under the NZE scenario even in the long-run. In particular, this is the case for industrial processes, such as production of cement, fertilizers and lime (with total emissions of around 16–18 MtCO₂eq. post-2045), as well as supply sector (with emissions around 3–7 MtCO₂eq. post-2045). To compensate for these emissions, in order to achieve net-zero target, selected negative emission technologies are adopted by the model. Between 2 and 5 MtCO₂eq. of GHGs across years are captured by the carbon capture and storage (CCS) and direct air capture (DAC) technologies in industry. The remaining negative emissions—between 10 and 22 MtCO₂eq. of GHGs depending on the year—are contributed by electricity and heat generation sector, in particular bioenergy with CCS (BECCS). Combined heat and power (CHP) gas plants with

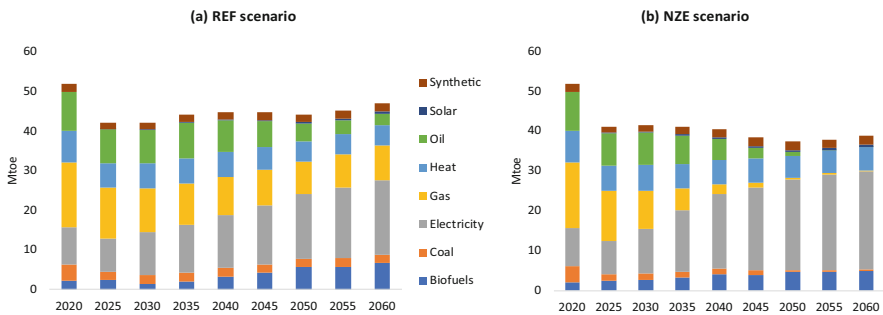

Fig. 4 Final energy consumption by fuels under the reference (a) and net-zero emissions (b) scenarios, Million tonnes of oil equivalent (Mtoe)

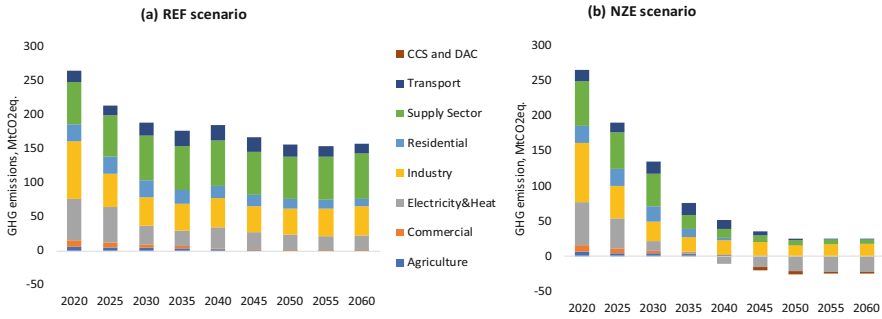

Fig. 5 GHG emissions across key sectors under the reference (a) and net-zero emissions (b) scenarios, Million tonnes of CO₂ equivalent (MtCO₂eq)

CCS are being deployed by the model starting from 2030–2035 and contribute around 19% of all heat generation in 2060. Decarbonization of hydrogen also plays an important role in the NZE scenario. While in the REF scenario all hydrogen is produced from natural gas, within net-zero transition by 2045 natural gas-based hydrogen is fully substituted by biomass-originated (56% of total production) and alkaline electrolytic hydrogen (44% of overall production). Post-2050 the share of electrolytic hydrogen increases to 75%. Around half of the produced hydrogen (52–53%) is used in the fertilizers’ production process, over one-third in the biomethane production, with the remaining allocated to biokerosene, industrial processes and buildings (Fig. 5).

While no explicit carbon pricing has been implemented within the NZE scenario discussed here, an estimate of the shadow price of CO₂ generated by the model can be used as a proxy for the level of overall mitigation efforts (carbon prices) needed to achieve the state targets. Results suggest that the shadow price of CO₂ stays in a range of 30–60 EUR per tCO₂eq. until 2030 and then increases over 230 EUR per tCO₂eq. starting from 2035 reaching the peak of around 450 EUR per tCO₂eq. in 2050 (Fig. 6). For comparison, the European Investment Bank assumes the shadow price of carbon to be 250 EUR per tCO₂eq. in 2030 and 800 EUR per tCO₂eq. in 2050 (EIB 2020). However, it should be noted that such estimates represent the cost of all mitigation measures, including energy efficiency regulations, emission standards, etc. In reality, a combination of carbon pricing and other policies is usually used, therefore the costs are distributed between these various instruments, which would result in a lower level of actually applied carbon prices compared to the full shadow price of CO₂.

4.2 Power Generation

The results suggest that the *power generation* (SDG 7.1.1, Table 1), substantially increases throughout the modeling horizon both under the reference and net zero

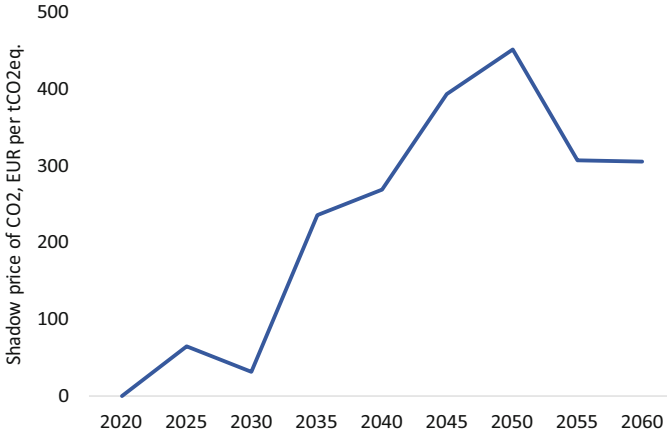

Fig. 6 Shadow price of CO₂ under net-zero emissions scenario, EUR per tonne of CO₂ equivalent (EUR per tCO₂eq)

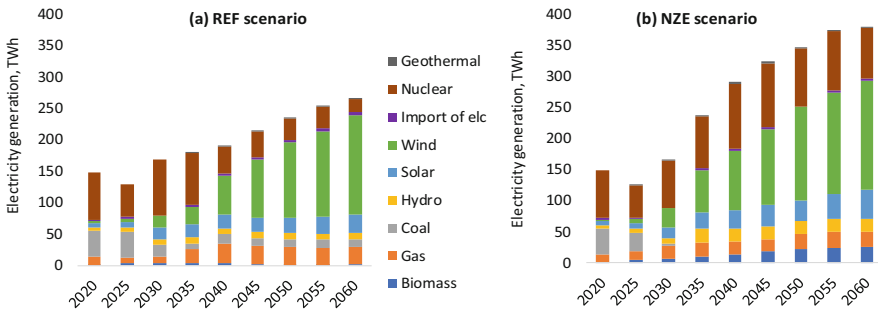

Fig. 7 Electricity generation in the reference (a) and net-zero emissions (b) scenarios (TWh)

scenarios (Fig. 2). In the latter case, as the economy sees higher electrification rates with increasing penetration of electric vehicles, heating and cooking appliances, by 2040 the electricity generation is over 50% higher under the NZE scenario compared to the REF case (Fig. 7). In terms of generation mix, both in the REF and NZE scenarios, wind power is by far the main contributor (Fig. 7). In the REF scenario wind power generation reaching its maximum potential being cost-competitive with other generation sources, including fossil-based. In the NZE scenario, wind power generation expands primarily due to the off-shore wind generation (not active in the REF scenario), which by the end of the modeled period constitutes around 20% of the total wind power generation. Compared to some earlier studies of the climate mitigation policies in Ukraine that relied on the TIMES-Ukraine modeling framework (e.g. Chepeliev et al. 2021; Chepeliev et al. 2023a, b), a higher share of wind

power generation in the reference scenario estimated here could be explained by improved sophistication of the power sector representation, including dispatching constraints and storage for renewable energy. Overall, these refinements have benefited wind power generation compared to other renewable generation sources, including solar power. Volumes of nuclear power generation decline over time in the REF scenario as the existing large NPPs are being decommissioned. At the same time, within the mitigation scenario, new large NPPs and small modular reactors (contribute around 23% of all nuclear power generation in 2060) are being constructed post-2035, replacing fossil-based power generation and in response to growing electricity demand. The share of nuclear power in generation mix substantially declines over time in the NZE scenario—from around 51% in 2020 to 21% in 2060. The share of solar power generation, on the other hand, more than triples between 2020 and 2060 with key increases coming from the solar roof panels.

In terms of SDG targets, the targeted value for 2030 of 182 TWh (Fig. 1) is not being reached as in the medium-term overall electricity demand is still being substantially impacted by the war and the overall reduction in economic activity and the electricity generation volumes are in a range on 167–169 TWh across the two scenarios. This implies the need for potential revision of the SDG targets in Ukraine taking into account the impacts of the war and future recovery efforts. In terms of the electricity generation mix, the NZE scenario sees substantially higher shares of nuclear power and biomass, as well as moderate (in relative terms) expansion in hydro, solar and wind generation. Wind power generation sees a major expansion in the reference scenario, even without the implementation of ambitious mitigation efforts, as this source of energy becomes more competitive with declining levelized cost of electricity (LCOE) over time. Coal-based power generation is completely eliminated in the NZE scenario starting from 2035.

4.3 Energy Affordability

To assess the *energy affordability* aspect, we estimate the marginal price for electricity and district heating in the residential sector. As discussed in Sect. 2, in Ukraine 100% of the population have access to electricity and >95% of the population have primary reliance on clean fuels and technology, therefore these two aspects of access to energy are not a concern in the country. Economic affordability of energy is a more important aspect in the context of net-zero transition and therefore is the focus of our assessment. In cases of both electricity and heat prices, an overall tendency is that the price in the NZE scenario is higher compared to the REF scenario during the first half of the simulated period, i.e. until 2035–2040, and becomes lower toward the end of the analyzed period. This temporal distribution of price impacts is driven by the fact that higher upfront investments in the generation capacities are required during the first half of the period, as further discussed in Sect. 5, while resulting fuel savings reduce electricity and heat prices over time thus benefiting consumers in the long run. Higher demand for electricity within the NZE

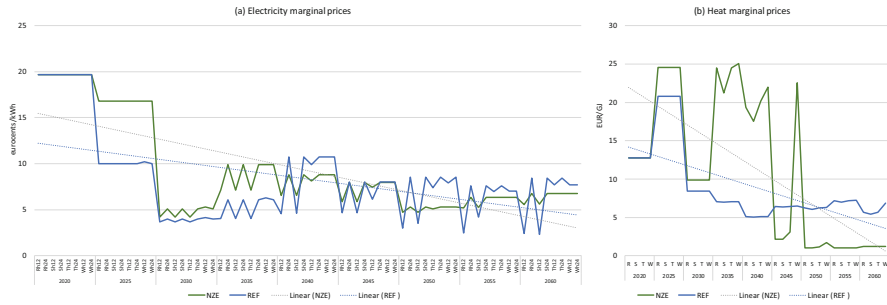

Fig. 8 Electricity (a) and heat (b) marginal prices in the residential sector. *Notes:* “R”, “S”, “T” and “W” labels correspond to spring, summer, fall and winter seasons respectively (case of heat prices reporting). Electricity prices reporting additional distinguishes two representative periods of the day—midday (“h12” label) and midnight (“h24” label). Linear trends for each of the scenarios are reported for illustrative purposes to show the overall trend in prices over time

scenario combined with emission constraints also leads to an expansion in selected (relatively more expensive) technologies, which are either absent or present in the very limited volumes in the reference scenario. Examples of such technologies include offshore wind, BECCS and new large NPPs. On average electricity prices in the NZE scenario are around 25% higher compared to the REF scenario at the beginning of the period and then lower post-2045 (Fig. 8a).

Heat prices show an even more substantial relative gap across scenarios—with prices under NZE substantially higher than under the REF case, especially during the 2030–2045 period when natural gas is being phased out and substituted by bioenergy sources and air-sourced heat pumps. At the same time, combined heat and power gas plants are used in combination with CCS, which adds additional generation costs (compared to the conventional CHP without CCS used in the REF scenario). In the post-2045 timeframe, however, heat prices under the NZE scenario are substantially lower than under the REF pathway (Fig. 8b).

Before the war, around 22% of households in Ukraine could not afford to keep their homes adequately warm, while 19% were struggling to pay their utility bills (Goncharuk et al. 2021). COVID pandemic has put further pressure on energy poverty in Ukraine (Goncharuk et al. 2021). Observed tradeoffs between net-zero transition and energy price increases in the medium run could put additional pressure on the energy poverty situation in Ukraine.

4.4 Import Dependency and Energy Intensity

To assess the *Energy security and import dependency* aspect we estimate a share of energy imports in Total Primary Energy Supply (TPES) (Fig. 6a). It should be noted that imports of nuclear fuel are accounted in the mining category following

conventional energy balance definitions. Results suggest that under both REF and NZE scenarios import dependency substantially declines by 2025—from around 31% to under 15% (Fig. 9a). Such a change is driven by the reduction in both coal and gas imports following lower demand due to the war. Due to the large number of refugees (approximately 8 million in 2022) and significant destruction of industry and buildings, the domestic energy demand fell by around one-third in 2022 compared to 2021. At the same time, even during the post-war recovery period (2026 and onward) overall energy demand stays well below pre-war levels (by around 10–20 Mtoe lower than 2020 levels) and thus imports of fossil fuels do not reappear. An expansion in domestic renewable energy generation (primarily bioenergy and wind) takes place, taking into account the substantial potential of the renewable energy sources in Ukraine, as well as the need to retire many of the older fossil-based power plants, reducing the need for imported fossil fuels. Overall, in the long-run, no major differences in import dependency are observed across scenarios as imports of fossil fuels decrease substantially in both cases.

To assess the progress on SDG 7.4.1 we further estimate the energy intensity of GDP across scenarios (Fig. 9b). Results suggest that under the REF scenario, the energy intensity of GDP declines by around 14% between 2020 and 2030, which is not sufficient to achieve the SDG 7.4.1 target of 18% decline in the corresponding indicator. NZE scenario, however, results in a 24% reduction in the GDP energy intensity between 2020 and 2030, thus fulfilling the SDG target and suggesting substantial synergies in this regard. In the long run, both scenarios show very similar reduction in the energy intensity as the latter declines by around 63% in the REF scenario (in 2060 w.r.t. 2020) and by over 67% under the NZE pathway (Fig. 9b). It should be noted that a major reduction of the energy intensity under the REF scenario reflects a substantial energy efficiency potential of the Ukrainian economy, suggesting that even without major additional mitigation efforts, it is cost-efficient to rely on a new and more efficient energy technologies rather than maintain the older (existing) ones.

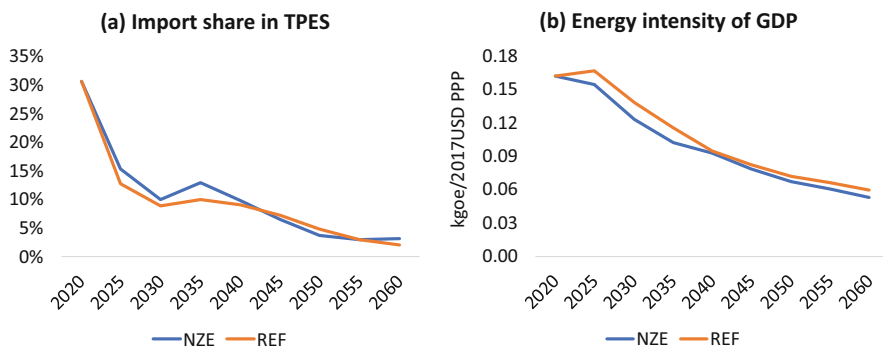

Fig. 9 Import share in TPES (a) and energy intensity of GDP (b) across scenarios

4.5 Clean Energy

The share of energy produced from renewable sources in total final energy consumption (TFEC) (SDG 7.3.1.) moderately increases under the REF scenario reaching 16% in 2030 however it is not sufficient to achieve the target of 17.1% (Fig. 10c). NZE scenario shows major synergies between emission reductions and growing share of renewable energy in TFEC over-achieving the 2030 target by around 10 percentage points (Fig. 10c). Renewable energy sources share in power generation converges in both scenarios in the long run reaching over 77% in 2060 (Fig. 10a), indicating that the power sector possesses a great economic feasibility for decarbonization, even in the absence of climate policies. Within the NZE scenario, coal power plants are fully replaced by renewable energy sources and nuclear power generation, while a small share of electricity generation from natural gas (primarily equipped with CCS) is still observed in 2060 under the net-zero transition (Fig. 7b). It should be noted, however, that while the shares of renewable energy in electricity generation in 2060 are very similar in the REF and NZE scenario, the share of carbon-free electricity is substantially higher in the latter case due to an expansion in the nuclear power generation (not considered renewable). In the case of the heat generation sector, the REF scenario shows a substantially lower share of renewable sources by the end of the period (50% in 2060) when compared to the NZE case (92% in 2060) (Fig. 10b).

5 Investment Needs and Financing Options for the Net-Zero Transition

To further evaluate the economic feasibility of the analyzed net-zero emissions pathway in Ukraine we assess overall investment needs across years and technologies (Fig. 11). Overall, the NZE scenario requires 23% more cumulative investments

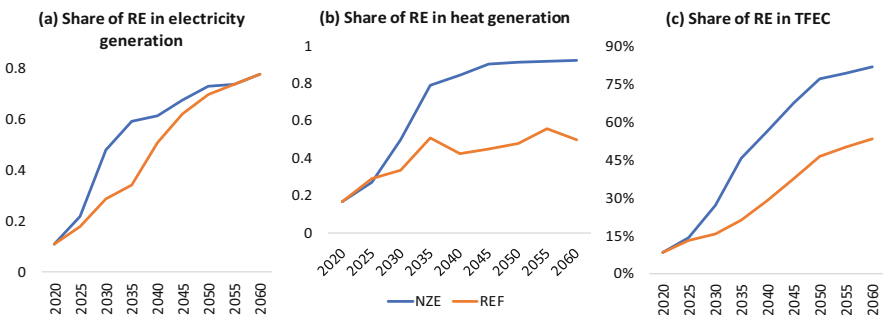

Fig. 10 Share of renewable energy (RE) in electricity generation (a), heat generation (b) and TFEC (c)

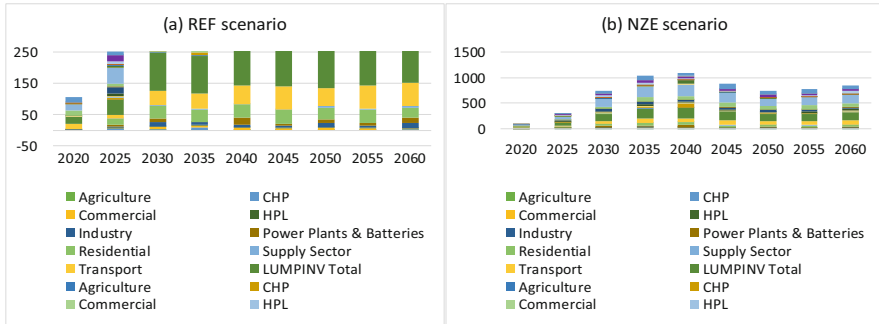

Fig. 11 Total investments by years and sectors under the reference (a) and net-zero emissions (b) scenarios (billion EUR). *Notes:* “CHP” stands for combined heat and power plants

over the analyzed time horizon, however, the temporal distribution of investments suggests that major additional funds will be needed during the 2030–2045 period (Fig. 11b). In 2035 a large share of additional investments are associated with the transportation sector, power plants and energy storage, while in 2040 an increase in investments is primarily driven by the construction of new nuclear reactors. Nuclear power plants in Ukraine produce electricity and heat, which is true both for existing and newly-constructed power plants represented in the model and therefore are classified under the CHP technology in Fig. 11b. During the 2035 period, only additional investments are in the range of 80 billion EUR, when compared to around 2 billion EUR of the cumulative foreign investments in the clean energy technologies attracted by Ukraine over the 2000–2020 period (UN 2023), implementation of the ambitious mitigation efforts might present a major policy challenge.

To address these, Ukraine needs to continue the development of a financial system capable of resisting domestic and external risks, as well as tailoring energy policies making clean energy viable and financially attractive. Recovery challenges and related investment needs further complicate the situation. Based on the assessment from March 2023 (before the destruction of the Kakhovka dam), the cost of reconstruction of Ukraine was assessed at around EUR 390 billion (WB 2023).

Over the past decade, the majority of the climate finance in Ukraine was directed to mitigation rather than adaptation measures. In 2021, total international climate finance flow in Ukraine was around EUR 953 million. Before the war, the environment for foreign direct investments (FDI) was rather unfavorable as the latter reached only 4% of GDP (OECD 2021). During the 2009–2020 period, Ukraine managed to attract more than EUR 9 billion in renewable energy, EUR 4.9 billion was invested in electricity generation, EUR 530 million in heat generation, and EUR 340 million in domestic solar PV (SAEE 2020). When these numbers are compared to the estimated investment needs within the NZE scenario—around EUR 106 billion over 2025–2040 period for the cases of CHP, power plants and batteries—this showcases the risk of a major financing gap in implementing net-zero transition in Ukraine.

In terms of post-war clean energy technology development, Ukraine has prioritized 11 pillars, requiring at least EUR 114 billion by 2032 (National Recovery Council 2022). These funding needs are broadly consistent with the estimates of additional investments by 2035 within the NZE scenario discussed here—around EUR 118 billion.

In pre-war times lending through international financial institutions was the most popular financing option for clean energy projects. It is important to restore this option after the end of war provided the availability of limited equity guarantees through war-risk insurance. Other measures to mobilize private finance could include establishing donor guarantees and the introduction of war insurance. The situation is complicated by the fact that Ukraine had and continues to have a very high cost of capital. During the war, the borrowed capital is difficult to obtain even at rates above 25%, which is a major prohibitive factor for the development of low-carbon technologies (Lin and Bai 2023). Therefore, in the post-war period, efforts should focus on lowering the interest rates, both with the help of international donors and domestic financial institutions.

In the EU, there is a new mechanism to finance clean energy projects within the EU Green Deal framework, when the EU member states can finance renewable energy sources (RES) projects in other countries ensuring technological spillovers, as specified in the Directive (EU) 2018/2001. Energy production must be more cost-effective than in the EU. This mechanism could benefit Ukraine, as developers may potentially bring their own finance, ensuring job creation and infrastructural development in Ukraine. The funding within such a scheme is distributed through a tender mechanism or a grant. The grant will cover either investment (installation of capacity) or actual energy generation.

Given the focus of the EU policies on decarbonization and the corresponding obligations of Ukraine, the post-war recovery should include a substantial share of investments directed toward clean energy technologies, consistent with the concept of “build back better”. The Ukraine Energy Support Fund, organized by the Energy Community, currently covers the needs of energy companies to purchase fuel, technological inputs and other necessities. After the war, this program could be repurposed toward targeted low-carbon development support. The “RebuildUkraine” Facility was suggested by the EU as a mixture of grants and loans, embedded in the EU budget.

The State Decarbonization and Energy Transformation Fund which will finance clean energy projects, was established in Ukraine in 2023 and is expected to start operation in 2024 (VRU 2023). The source of the Fund’s revenue is the CO₂ tax, which as of 2023 was UAH 30/t (EUR 0.72/t) of CO₂. The 2024 State Budget anticipates that UAH 759.2 million (EUR 18.19 million) would be allocated from this Fund for the decarbonization measures. As suggested by the estimates of the shadow carbon prices within the NZE scenario (Fig. 6), ambitious climate mitigation efforts in Ukraine might require substantial increase in the level of carbon pricing in the upcoming years, which could provide additional source of ‘green’ finance. However, as indicated by earlier studies, it is important to design a comprehensive set of the carbon revenue recycling measures—aimed at both supporting low-carbon

transition, as well as providing compensations to the most-vulnerable households (Muth 2023).

As of 2023, Ukraine has primary and secondary legislation in place for issuing green bonds. They can be issued by state/government agencies, as well as by individual companies. Green bonds could provide access to the Green Climate Fund (GCF), which, inter alia, finances clean energy technologies. In 2021, EBRD subscribed to around EUR 63 million of the Ukrainian Green and Sustainability-Linked Eurobond (SLB) issued out of Ukraine and listed by TSO Ukrengo. The funds were to be directed to the SO “Guaranteed Buyer” so that the latter could pay to the producers of “green” electricity. In addition, according to the COP27 Resolution, countries may sell their emissions reduction units (UNFCCC 2022). Ukraine might also potentially use this mechanism to ensure a ‘green’ post-war recovery.

6 Conclusions

In this study, we use the TIMES-Ukraine energy system-wide model to explore net-zero emissions scenario in Ukraine. The assessment considers the potential implications of the ongoing war, capturing both economic and demographic aspects of the Russian-Ukrainian war, and analyzes how the achievement of ambitious mitigation goals could impact a broad range of the developmental energy-related indicators within the Sustainable Development Goals (SDG) framework with a particular focus on SDG7 (Ensure access to affordable, reliable, sustainable and modern energy).

Overall, while we find that the implementation of net-zero emissions scenario in Ukraine has major synergies with several SDG dimensions, the availability of both domestic and international finances to support such transition might be a concern, especially considering the lack of progress in this area prior to the war. In this regard, major efforts need to be made to ensure the availability of a wide range of options for clean energy financing in Ukraine, including a reduction of the bond yield rates, creation of the specialized funds to support net-zero transition, lending through the international financial institutions, exploring the financing opportunities within the EU Green Deal framework aimed at supporting technological spillovers in the non-EU member states, as well creation of a more competitive domestic environment through ramping mitigation ambition, in particular, by increasing carbon prices. If successfully implemented, these will allow Ukraine to rebuild the domestic energy system in a more technologically advanced and environmental-friendly way, while supporting the country’s sustainable development agenda.

At the same time, it is important to consider the broader socio-economic context when analyzing the net-zero emissions scenarios in Ukraine. While the modeling framework used in this study provides a detailed representation of the energy sector and can be used to inform the decision-making representing various technological assumptions, it does not explicitly capture the interaction of the energy sector with the rest of the economy. At the same time, impacts on domestic producers and

consumers, changes in the country's competitiveness on international markets, impacts of considered policies on employment, wages and income distribution are all important aspects of the net-zero transition. Assessing such aspects requires the application of economy-wide modeling frameworks, such as computable general equilibrium or integrated assessment models, which could be used in combination with the energy system models (e.g. Chepeliev et al. 2024).

For instance, while reducing a dependency on imported fossil fuels, net-zero transition could lead to other forms of import dependency—technological (imported technologies) or financial (foreign borrowings). When evaluating energy transition scenarios, it is important to consider whether the associated fuel and technological supply chains could be developed domestically or would they be primarily of import origin. Creating and supporting supply chains with a high share of domestic inputs (equipment and parts, energy services, etc.) would be vital both from the economic, as well as energy security points of view. Assessing such tradeoffs would be an important extension of the analysis presented here.

Finally, it should be noted that while based on the plausible set of assumptions, an analysis presented here is of an exploratory nature. Many uncertainties underlie the future of the Ukrainian energy sector, including the cost of capital, global energy prices, costs and availability of technologies, as well as economic recovery pathways. A comprehensive analysis of these uncertainties, while beyond the scope of this paper, would provide important input to the future decision-making process.

References

- Azevedo I, Bataille C, Bistline J, Clarke L, Davis S (2021) Net-zero emissions energy systems: what we know and do not know. *Energy Clim Change* 2:100049. ISSN 2666-2787. <https://doi.org/10.1016/j.egycc.2021.100049>
- Cabinet of Ministers of Ukraine (CMU) (2020) Decree of the Cabinet of Ministers of Ukraine dated December 16, 2020 No. 1285 “On amendments to the Cabinet of Ministers of Ukraine Regulation and the cancellation of decrees of the Cabinet of Ministers of Ukraine dated February 26, 2020 No. 168 and of May 13, 2020 No. 363”. <https://zakon.rada.gov.ua/laws/show/1285-2020-п#n11>
- Chepeliev M, Diachuk O, Podolets R, Trypolska G (2021) The role of bioenergy in Ukraine's climate mitigation policy by 2050. *Renew Sust Energ Rev* 152:111714. <https://doi.org/10.1016/j.rser.2021.111714>
- Chepeliev M, Diachuk O, Podolets R, Semeniuk A (2023a) Can Ukraine go ‘green’ on the post-war recovery path? *Joule* 7:606–611. <https://doi.org/10.1016/j.joule.2023.02.007>
- Chepeliev M, Diachuk O, Podolets R, Semeniuk A (2023b) What is the future of nuclear power in Ukraine? The role of war, techno-economic drivers, and safety considerations. *Energy Policy* 178:113612. <https://doi.org/10.1016/j.enpol.2023.113612>
- Chepeliev M, Giannakidis G, Kanudia A, van der Mensbrugge D (2024) Implications of the net zero transition scenarios on SDG indicators: linking global energy system and CGE models. In: Espegren K, Giannakidis G, Labriet M, Ó Gallachóir B (eds) *Aligning the energy transition with the sustainable development goals: key insights from energy system modelling*. Springer Nature

- Child V, Breyer C, Bogdanov D, Fell H-J (2017) The role of storage technologies for the transition to a 100% renewable energy system in Ukraine. *Energy Proc* 135(2017):410–423. <https://doi.org/10.1016/j.egypro.2017.09.513>
- Clark MA, Domingo NGG, Colgan K et al (2020) Global food system emissions could preclude achieving the 1.5° and 2 °C climate change targets. *Science* 370:705–708
- Climate Action Tracker (CAT) (2020) Ukraine. <https://climateactiontracker.org/countries/ukraine/>
- Diachuk O, Chepeliev M, Podolets R, Trypolska G, Venger V, Saprykina T, Yukhymets R (2017) Ukraine's transition to the renewable energy by 2050. Edited by Oharenko Y and Allieva O. Heinrich Boll Foundation in Ukraine, Kyiv. <https://ua.boell.org/en/2017/11/07/transition-ukraine-renewable-energy-2050>
- Energy & Climate Intelligence Unit (2023) Net zero scorecard. Net Zero Tracker. <https://eciu.net/netzerotracker>
- European Bank for Reconstruction and Development (EBRD) (2020) Support to the government of Ukraine on updating its nationally determined contribution (NDC). Modelling report 3. https://menr.gov.ua/files/images/news_2020/15052020/1UKRAINE%20NDC2_MODELLING_REPORT_3_FINAL.pdf
- European Investment Bank (EIB) (2020) EIB Group Climate Bank Roadmap 2021–2025. November 2020. https://www.eib.org/attachments/thematic/eib_group_climate_bank_roadmap_en.pdf
- Fujimori S, Hasegawa T, Takahashi K, Dai H, Liu JY, Ohashi H, Xie Y, Zhang Y, Matsui T, Hijioka Y (2020) Measuring the sustainable development implications of climate change mitigation. *Environmental Research Letters*. 15(8):085004.
- Fuso Nerini F et al (2019) Connecting climate action with other Sustainable Development Goals. *Nat Sustain* 2:674–680. <https://doi.org/10.1038/s41893-019-0334-y>
- Goncharuk AG, Hromovenko K, Pahlevanzade A, Hrinchenko Y (2021) Energy poverty leap during the pandemic: the case of Ukraine. *Polityka Energetyczna-Energy Policy J* 24:5–18
- Höhne N et al (2021) Wave of net zero emission targets opens window to meeting the Paris Agreement. *Nat Clim Change* 11:820–822. <https://doi.org/10.1038/s41558-021-01142-2>
- Lin B, Bai R (2023) Nexus between green finance development and green technological innovation: a potential way to achieve the renewable energy transition. *Renew Energy* 218:119295. <https://doi.org/10.1016/j.renene.2023.119295>
- Ministry of Economic Development and Trade of Ukraine (2017) Sustainable development goals: Ukraine. 2017 National baseline report. https://www.undp.org/sites/g/files/zskgke326/files/migration/ua/SDGs_NationalReportEN_Web.pdf
- Muth D (2023) Pathways to stringent carbon pricing: Configurations of political economy conditions and revenue recycling strategies. A comparison of thirty national level policies. *Ecol Econ* 214:107995. <https://doi.org/10.1016/j.ecolecon.2023.107995>
- National Bank of Ukraine (NBU) (2023) Inflation report, July 2023. <https://bank.gov.ua/en/news/all/inflyatsiya-i-dali-spoivilnyuvatimetsya-a-ekonomika-vidnovlyuvatimetsya%2D%2Dinflyatsiyiny-zvit-nbu>
- National Recovery Council (2022) Ukraine's National Recovery Plan. July 2022 https://uploads-ssl.webflow.com/621f88db25bf24758792dd8/62c166751fcf41105380a733_NRC%20Ukraine%27s%20Recovery%20Plan%20blueprint_ENG.pdf
- Organisation for Economic Co-operation and Development (OECD) (2021) Sustainable infrastructure for low-carbon development in the EU eastern partnership: hotspot analysis and needs assessment, green finance and investment. OECD Publishing, Paris. <https://doi.org/10.1787/c1b2b68d-en>
- President of Ukraine (2019) Decree of the President of Ukraine No. 722/2019 on the Sustainable Development Goals of Ukraine till 2030. <https://www.president.gov.ua/documents/7222019-29825> (In Ukrainian)
- Ptoukha Institute for Demography and Social Studies (PIDSS) of the National Academy of Sciences of Ukraine (2022) National Population Projections. https://idss.org.ua/forecasts/nation_pop_proj_en

- Razumkov Center (2022) Ukrainian Refugees: attitudes and estimates (March 2022). <https://razumkov.org.ua/napiamky/sotsiologichni-doslidzhennia/ukrainski-bizhentsi-nastroi-taotsinky> (in Ukrainian)
- REKK, DIXI Group, Institute for Economics and Forecasting, RAP, Austrian Institute of Technology (2024) Long-term decarbonisation pathways for Ukraine's power sector. <https://dixigroup.org/wp-content/uploads/2024/03/report-full1.pdf>
- Robiou du Pont Y, Jeffery ML, Gütschow J, Rogelj J, Christoff P, Meinshausen M (2017) Equitable mitigation to achieve the Paris Agreement goals. *Nature Clim Change* 7:38–43. <https://doi.org/10.1038/nclimate3186>
- Rogelj J et al (2015) Energy system transformations for limiting end-of-century warming to below 1.5 °C. *Nat Clim Change* 5:519–527. <https://doi.org/10.1038/nclimate2572>
- Sachs JD, Lafortune G, Fuller G, Drumm E (2023) Implementing the SDG Stimulus. Sustainable Development Report 2023. SDSN/Dublin University Press, Paris/Dublin. <https://doi.org/10.25546/102924>
- State Agency for Energy Efficiency and Energy Saving (SAEE) (2020) Policy in realm of renewable energy sources of Ukraine
- State Statistics Service of Ukraine (SSSU) (2021) Sustainable Development Goals: Ukraine 2021. Monitoring Report. https://www.ukrstat.gov.ua/csr_prezent/2020/ukr/st_rozv/publ/SDGs%20Ukraine%202021%20Monitoring%20Report%20engl.pdf
- Theurl MC et al (2020) Food systems in a zero-deforestation world: Dietary change is more important than intensification for climate targets in 2050. *Sci Total Environ* 735:139353. ISSN 0048-9697. <https://doi.org/10.1016/j.scitotenv.2020.139353>
- Tong D et al (2019) Committed emissions from existing energy infrastructure jeopardize 1.5 °C climate target. *Nature* 572:373–377. <https://doi.org/10.1038/s41586-019-1364-3>
- United Nations (UN) (2023) SDG Indicators Database. SDG Country Profile. Ukraine. <https://unstats.un.org/sdgs/dataportal/countryprofiles/UKR#goal-7>
- United Nations Economic Commission for Europe (UNECE) (2023a) Renewable energy share in the total final energy consumption, %. <https://w3.unece.org/SDG/en/Indicator?id=23>
- United Nations Economic Commission for Europe (UNECE) (2023b) Energy intensity level of primary energy, MJ/constant 2011 PPP GDP. <https://w3.unece.org/SDG/en/Indicator?id=24>
- United Nations Framework Convention on Climate Change (UNFCCC) (2015) Adoption of the Paris Agreement. Report No. FCCC/CP/2015/L.9/Rev.1. <http://unfccc.int/resource/docs/2015/cop21/eng/109r01.pdf>
- United Nations Framework Convention on Climate Change (UNFCCC) (2022) Guidance on cooperative approaches referred to in Article 6, paragraph 2, of the Paris Agreement and in decision 2/CMA.3. https://unfccc.int/sites/default/files/resource/cma2022_L15_adv_1.pdf
- United Nations Refugee Agency (UNHCR) (2022) Ukraine refugee situation. https://data.unhcr.org/en/situations/ukraine#_ga=2.223184536.2086419720.1652814313-1458650132.1652814313
- Verkhovna Rada of Ukraine (VRU) (2023) Law of Ukraine dated April 11, 2023 No. 3035-IX “On Amendments to the Budget Code of Ukraine”. <https://zakon.rada.gov.ua/laws/show/3035-IX#Text>
- von Stechow C, Minx JC, Riahi K, Jewell J, McCollum DL, Callaghan MW, Bertram C, Luderer G, Baiocchi G (2016) 2° C and SDGs: united they stand, divided they fall?. *Environmental Research Letters* 11(3):034022.
- World Bank (WB) (2023) Ukraine Rapid Damage and Needs Assessment. February 2022—February 2023 (English). World Bank Group, Washington, DC. <https://documents1.worldbank.org/curated/en/099184503212328877/pdf/P1801740d1177f03c0ab180057556615497.pdf>

Open Access This chapter is licensed under the terms of the Creative Commons Attribution 4.0 International License (<http://creativecommons.org/licenses/by/4.0/>), which permits use, sharing, adaptation, distribution and reproduction in any medium or format, as long as you give appropriate credit to the original author(s) and the source, provide a link to the Creative Commons license and indicate if changes were made.

The images or other third party material in this chapter are included in the chapter's Creative Commons license, unless indicated otherwise in a credit line to the material. If material is not included in the chapter's Creative Commons license and your intended use is not permitted by statutory regulation or exceeds the permitted use, you will need to obtain permission directly from the copyright holder.



Align Algeria's Energy Diversification Strategies with Energy and Climate Sustainable Development Goals



Naïma Chabouni, Charlène Barnet, Edi Assoumou, Nadia Maïzi, and Sandrine Selosse

Abstract Algeria belongs to a set of nations with a model of socio-economic development that has created a high dependence on hydrocarbon exports, leaving them vulnerable to fluctuations in international market prices. Additionally, its economy has a structural imbalance, marked by weaknesses in agricultural and non-hydrocarbon-oriented secondary sectors. To overcome the pitfalls of hydrocarbon-centered development, we develop three alternative energy pathways designed for Algeria to explore the contributions to SDG 7 (energy) and SDG 13 (climate). These scenarios analyze Algeria's future power system pathways and focus on the country's national energy policies related to integrating renewable energy and developing hydrogen production. The TIMES-DZA model was used to assess technological configurations of the power and hydrogen sectors by 2070 and demonstrate these strategies' impact on CO₂ emission reduction, aligning with sustainable development goals, specifically SDG 7 and SDG 13. The results emphasize the critical role of renewable energy and hydrogen in achieving decarbonization in the power sector, advocating for a more inclusive approach that incorporates low-carbon technologies to help Algeria reach a resilient and low-carbon energy future.

Key Messages

- The reference scenario, excluding climate policies, describes the deepening of Algeria's reliance on hydrocarbon resources which poses an environmental challenge and conflicts with the principles of SDGs 7 (energy) and 13 (climate).

N. Chabouni (✉) · C. Barnet · E. Assoumou · N. Maïzi · S. Selosse
Centre for Applied Mathematics, MINES Paris, PSL Research University, Sophia Antipolis, France
e-mail: naima.chabouni@minesparis.psl.eu; charlene.barnet@minesparis.psl.eu;
edi.assoumou@minesparis.psl.eu; nadia.maizi@minesparis.psl.eu;
sandrine.selosse@minesparis.psl.eu

© The Author(s) 2024

M. Labriet et al. (eds.), *Aligning the Energy Transition with the Sustainable Development Goals*, Lecture Notes in Energy 101,
https://doi.org/10.1007/978-3-031-58897-6_13

295

- Enforcing Algeria's policy targets on renewable and hydrogen leads to a more diversified energy supply, aligning with SDG 7, but without reducing sufficiently the greenhouse gas emissions, thus not fully aligning with SDG 13.
- The addition of a climate target to the current policy targets raises concerns about the feasibility of achieving CO₂ emissions reduction and meeting the gas domestic demand and export requirements.
- The development of a TIMES-DZA model helped shape Algeria's future climate policies.

1 Introduction

Algeria, historically rich in hydrocarbons, has relied heavily on these abundant and low-cost resources for development, leading to significant carbon emissions and environmental issues. With growing climate awareness, there is increased attention on transitioning to sustainable energy sources.

The Sustainable Development Goals (SDGs) framework established by the United Nations (UN) appears to be particularly relevant for guiding the development paths of emerging countries while addressing their multiple socioeconomic and environmental challenges. However, integrating SDGs into public policy, particularly long-term energy planning, is challenging due to the interlinkages and conflicts between various SDGs and inherent uncertainties.

In this chapter, we explore the contributions to SDG 7 and SDG 13 offered by three alternative energy pathways designed for Algeria using TIMES-DZA, a bottom-up energy systems optimization model widely employed for informing public policy decisions related to energy planning. We discuss Algeria's energy challenges, strategic targets for the diversification of its energy sector, and the potential contribution of bottom-up prospective modeling to evaluate energy trajectories in alignment with SDGs. The methodology of TIMES-DZA and the conceived scenario are introduced, followed by analysis of key results.

2 The Algerian Energy System: Many Challenges Ahead

2.1 *The Advent of the Rentier State*

Before 1958, Algeria's economy was agrarian, but the establishment of its national oil company Sonatrach in 1963 marked a shift to oil and gas production, leading to OPEC membership in 1969 (Mekideche 2009).

Industrialization efforts in hydrocarbons transformation, chemicals and steel began, alongside nationalization of the oil industry in 1971. Planning programs in 1970 and 1974 aimed to boost development but faced challenges due to the overreliance on oil leading to economic setbacks in non-oil sectors (Andreff and

Hayab 1978; Addi 1995; Gasmi and Laourari 2017; UNECA 2017; Ouchene and Moroncini 2018). The mid-1980s oil shock, marked by oil prices plummeting from \$USD 30/barrel in 1982 to \$USD 12/barrel in 1988, worsened Algeria's economic situation. This period saw the budget deficit reaching 13.7% in 1987, highlighting the country's vulnerability to hydrocarbons.

The 1990s, known as the "black decade", witnessed political, socio-cultural, and economic turmoil. Algeria turned to international financial institutions for assistance, implementing International Monetary Fund structural adjustment programs in 1994–95. This neoliberal policy led to a deregulation and privatization movement in the energy sector, aiming to foster competition, attract investments, and improve efficiency. While stabilizing the economy, these measures failed to bring about substantial restructuring (Auty 2003). By the end of the decade, Algeria remained heavily reliant on hydrocarbons, with 30% of GDP, 60% of government revenues, and 95% of exports still attributed to the hydrocarbons sector (Oliva 2000).

In the 2000s, Algeria continued liberalization, ending the state monopoly on hydrocarbons in 2001 (Akacem 2004). Despite a surge in oil prices benefiting the state budget, economic diversification remained elusive. From 2000 to 2014, over 65% of the budget and 97% of exports were still tied to hydrocarbons, mainly used for sustaining subsidies (Safir 2019).

Algeria's economy reflects the characteristics of a rentier state, with rent primarily originating from external sources like oil sales (Beblawi 1987; Machín Álvarez 2010; Fuinhas and Marques 2013). Despite wealth from oil booms, socio-economic indicators remain unsatisfactory, lagging behind the Middle East and North Africa (MENA) average in terms of GDP per capita and electricity generation per capita (World Bank 2022; EIA 2023). In 2021, Algeria's GDP per capita (PPP) was \$1228, compared with \$17,282 for the MENA zone, the lowest country being Yemen with \$3437 per capita and the highest Qatar with \$102,018 per capita (World Bank 2022). In 2022, Algeria's electricity generation per capita was 1770 kWh versus 3464 kWh for the MENA region (EIA 2023). This suggests Algeria has not successfully navigated the pitfalls associated with rentier dynamics.

2.2 *Oil and Gas: A Blessing or a Curse?*

In 2022, Algeria was among the top 15 oil producers and the top 10 gas producers globally. It is the fifth-largest exporter of natural gas via pipelines and the sixth-largest exporter of liquified natural gas, making it Africa's largest gas exporter (BP 2022). Additionally, it is the fourth biggest African oil exporter after Nigeria, Libya, and Angola. However, the heavy reliance on oil and gas presents challenges, with the hydrocarbon sector contributing significantly to GDP (19%), exports (93%), and budget revenues (38%) from 2016 to 2021, highlighting a lack of economic diversification (World Bank 2022). In comparison, manufacturing contributed only 5.45% to the GDP in 2016 (Gasmi and Laourari 2017).

Algeria's over-reliance on oil and gas exposes it to market price fluctuations, causing uncertainty in fiscal revenues (World Bank 2022). For instance, the sharp decline in oil prices from US\$115 per barrel in June 2014 to less than US\$50 in January 2015 led to a fiscal deficit surge from 1.4% to 15.7% of GDP by 2016 (World Bank 2015, 2016, 2018). This financial strain, coupled with escalating inflation and weakening currency, contributed to the *Hirak* national protest movement in 2019 and the resignation of President Abdelaziz Bouteflika. On the other hand, periods of high oil prices, such as those following the COVID-19 crisis, can alleviate pressure on public finances and enable positive social measures like controlling the price of essential commodities and supporting employment (Serrano 2022). These examples highlight how the stability and level of hydrocarbon revenue influence social peace in rentier states like Algeria, where reliance on oil and gas for budget stability can be both a blessing and a curse depending on global economic conditions.

In addition to market price volatility, the Algerian government grapples with challenges affecting future oil and gas exports and associated revenues. Over the past decade, outputs have declined due to technical challenges, inadequate infrastructure, and insufficient investment in recovery technologies. Furthermore, bureaucratic procedures delay project development (Aissaoui 2016; Ouki 2019; BP 2022). Increasing domestic demand, particularly for gas, driven by population growth and subsidies, further strains hydrocarbon export prospects. In 2021, 67% of Algeria's primary energy consumption came from natural gas and 32% from oil, with about 98% of electricity produced from natural gas (BP 2022). Domestic gas consumption surged by 70% from 2008 to 2018 (Ouki 2019), with projections indicating a potential 17–77% increase by 2032, compared to the 2021 consumption level of 48.61 Bcm (CREG 2023). Consequently, gas exports decreased from a peak of 64 Bcm in 2005 to 55 Bcm in 2021 due to diminishing supply and rising domestic consumption.

The environmental impact of hydrocarbon-driven development has become a growing concern in Algeria since the late 1990s (Ouchene and Moroncini 2018). As the fourth largest emitter of greenhouse gases (GHGs) in Africa, Algeria's total emissions reached 284 million tons (Mt) in 2022, a two-fold increase since 1990 (Allali et al. 2015; Crippa et al. 2023). As a Mediterranean country, Algeria faces frontline impacts of climate change, including water scarcity, desertification and drought. In 2022, fuel exploitation contributed nearly 35% of Algeria's total emissions, with power and heat generation accounting for 15% (Crippa et al. 2023). This underscores the country's overreliance on hydrocarbons, particularly gas for electricity production, responsible for half of its emissions.

The structural fragility resulting from excessive dependence on hydrocarbons, coupled with uncertainties about future production and export levels, compels the Algerian government to seek income diversification. Challenges posed by global warming and the imperative of energy transition add to the uncertainty surrounding the future of hydrocarbons worldwide. Despite several attempts to diversify the economy, success has been limited. However, the ongoing transformation of global energy systems presents a new opportunity for Algeria to succeed in diversifying its economy, particularly the energy sector.

2.3 *Getting Away from the Rentier Economy Model: Diversification and SDGs*

Algeria faces numerous socio-economic and energy-related challenges, notably the need to transition from relying on abundant hydrocarbon resources for low energy prices to reserving these resources for exports to maintain revenues, given the current limited diversification of exports. Moreover, the widening gap between energy supply and consumption threatens energy security in the medium term. Diversification has long been advocated as one of the solutions to these issues. Economic diversification, as defined by the World Bank Group, involves transitioning to a more varied domestic production and trade structure to boost productivity, create job, and achieve sustained, poverty-reducing growth (OECD/WTO 2019). Energy plays a pivotal role in these processes, contributing significantly to manufacturing, job creation, transportation, and poverty reduction. Therefore, ensuring reliable and affordable energy supply is imperative for economic in developing nations (International Crisis Group 2018; Akrofi 2021).

For hydrocarbon-exporting nations like Algeria, the challenges of economic diversification, energy transition and energy security are deeply intertwined. The Algerian government's Economic Recovery Plan, introduced in 2021 post-COVID-19, identifies the energy sector as a strategic driver of economic development. Traditional energies are seen as a fundamental for constructing a sustainable Algeria, while renewable energy (RE) is envisioned to ensure the country's energy security through a more balanced energy mix capable of meeting long-term domestic demand without depleting exportable hydrocarbon resources. The plan envisions a "*low-carbon, rational and efficient in its energy consumption*" Algeria of the future, with hydrogen highlighted as part of the energy transition package. This focus on hydrogen, emerging since 2019, has garnered increasing interest over the years, as evidenced by recent announcements. The plan also underscores the importance of developing promising industrial sectors including mechanical engineering, electronics, appliance production, and pharmaceuticals (Services du Premier Ministre 2021). With 80% of Algeria's industrial energy mix relying on subsidized natural gas supply (Ouki 2019), the need to diversify the energy mix with REs becomes evident, playing a crucial role in shaping the country's economic future. Given these considerations, this chapter will explore potential energy diversification pathways and their associated CO₂ emissions.

On the international stage, the objectives of energy diversification and transition are reflected in the frameworks of the Nationally Determined Contributions (NDCs) and the SDGs. The 2030 Agenda for Sustainable Development, devised by the UN, places the 17 SDGs at its core, providing a comprehensive framework to improve the quality of life for all individuals while addressing environmental challenges. Of particular relevance to our subject are SDG 7, which aims to ensure access for all to reliable, sustainable, modern, and affordable energy services, and SDG 13, which focuses on combating climate change and its repercussions.

In a 2019 progress report, the Algerian Committee responsible for monitoring the implementation of the SDGs identified the significant increase in domestic energy consumption and the resulting pressure on gas resources which should be allocated for exports, as a challenge to be tackled within the framework of SDG 7. The report highlights the development of RE and the promotion of energy efficiency as key responses to these challenges (targets 7.2 and 7.3 respectively). Regarding SDG 13, the Committee underscores Algeria's vulnerability to climate change, particularly in relation to water stress. As for this goal, a crucial lever related to the energy sector is the commitment stated in Algeria's 2015 NDC to reduce GHG emissions by 7–22% by 2030, contingent on the level of support provided by international actors (Interministerial Committee for the follow-up of the SDGs 2019).

The most straightforward indicator to assess the achievement of target 7.2 is the rate of electricity generation from RE sources or the installed renewable capacities. In 2015, Algeria set an ambitious goal to have 17,475 MW of RE capacities installed by 2035, accounting for 27% of the electricity mix. However, as of 2022, the share of RE in primary energy consumption remains low, at only 0.26%, with renewable capacities barely reaching 599 MW (BP 2022; IRENA 2023a). Regarding SDG 13 and within the scope of the energy sector, key mechanisms to be activated include reducing flaring and GHG emissions and establishing of a reporting system for emissions. Algeria has made progress in reducing the flaring rate, which decreased from 78.6% in 1970 to 8% in 2016. However, despite this improvement, Algeria's GHG emissions have continued to increase, rising from 260 Mt CO₂eq/yr in 2015 to 284 Mt CO₂eq/yr in 2022 (Crippa et al. 2023). Substantial and rapid reduction of GHG emissions will not be achieved without a deep transformation of the power and fuel exploitation industries. These sectors are indeed contributing significantly to Algeria's GHG emissions, as detailed in the previous section.

Combining long-term energy security, the maintenance of a fiscally sustainable level of energy products export and SDGs is complex and necessitates considering numerous parameters and anticipating developments, given the extended lead times required for introducing new renewable capacities or initiating new production fields. Long term, bottom-up, prospective modeling tools, has proven to be relevant for studying SDG 7 and SDG 13 (Barbero Vignola et al. 2020). In this chapter, we use such a modeling tool to examine the sustainable development and diversification of the Algerian energy sector. The objective is twofold. First, to measure, by the year 2070, the impact of integrating RE and hydrogen development targets on the future energy system and to assess whether these technological configurations can alleviate pressure on oil and gas resources for domestic demand while enhancing the fulfillment of SDG 7. Second, to examine the impact of associating these strategies with a CO₂ emission reduction constraint that aligns with SDG 13. Before presenting the model TIAM-DZA, we will delve further into Algeria's ambition regarding its energy transition, with a special focus on hydrogen which has been on the spotlight over the past few years, and for which Algeria harbors great ambition.

3 Algeria's Ambitions Regarding Its Future Energy Sector

3.1 *Renewable Energies Development*

Although the share of RE in Algeria's energy mix is currently marginal, the government implemented policies and support mechanisms, such as the feed-in tariffs, to stimulate the growth of RE. In 2020, Algeria established a new ministry for energy transition and RE, releasing an ambitious roadmap. The "National Program for the Development of Renewable Energies" targets a 30% RE share in the energy supply by 2035. The ministry, focusing mainly on solar projects, aims to install 1000 MW of solar electricity in small power plants across eleven sites in the first phase. The long-term goal is to achieve 15,000 MW by 2035.

3.2 *Hydrogen Development in Algeria*

The concept of transporting solar energy from North Africa to Europe has been under consideration for more than two decades. Initially, the DESERTEC project aimed to transmit solar electricity from the MENA region to Europe through high-voltage direct current transmission (Trieb and Müller-Steinhagen 2007). However, this ambitious project has faced partial abandonment, due to challenges in developing electricity infrastructures between the two continents. Instead, a growing interest in the alternative approach of converting solar energy into hydrogen for export has emerged (Cherigui et al. 2009). As part of its REPowerEU plan, the European Union (EU) aims to use 20 Mt of renewable hydrogen¹ annually by 2030, with half of this amount expected to be imported (EC 2022). North African countries, given their extensive solar potential and geographical proximity to Europe, are considered prime candidates to meet this demand. Algeria, in particular, is connected to Europe through three natural gas pipelines—the Enrico Mattei (TransMed), the Maghreb-Europe Gas (MEG), and the Medgaz pipeline—that can potentially be retrofitted to transport hydrogen at a manageable cost. The SouthH2 Corridor, a 3300 km long hydrogen pipeline linking North Africa, Italy, Austria, and Germany, primarily entails repurposing existing gas pipelines and is anticipated to be operational by 2030. This ambitious project holds promise and could provide Algeria with a strategic advantage in the competition to meet the growing European demand for H₂.

Keen to capitalize on its gas resources as a first step and then diversify beyond hydrocarbons by exploiting its renewable potential, the Algerian government fixed

¹ According to the European Commission guidelines, hydrogen must be produced from RE sources and achieve at least 70% reduction in GHG emissions to be considered as renewable. Two other criteria—the additionality requirement and the criteria on temporal and geographical correlation—must be completed for hydrogen to be renewable. When renewable hydrogen comes from RE other than biomass, then it falls under the category of Renewable Fuels of Non-Biological Origins (RFNBOs), otherwise it is considered as a biomass fuel.

the target to produce and export to the EU, 30–40 TWh of gaseous and liquid hydrogen (which is equivalent to around 1 Mt of hydrogen) by 2040. The goal will be achieved through a mix of blue hydrogen—produced from natural gas through the Steam Reforming process associated with a Carbon Capture Use and Storage (CCUS) facility—and green hydrogen, generated by electrolysis using the country’s abundant solar resources or wind when relevant. To support this export strategy, Algeria has launched a national program structured in three phases to develop and produce hydrogen, starting from now and extending beyond 2040 (Aouissi and Haggmark 2023). Algeria also aspires to replace grey hydrogen, presently used in local industries, with green hydrogen, thereby contributing to the decarbonization of the national industrial sector. As for CCUS, no official target or guidelines have been released by the government so far. Nevertheless, Algeria is known to hold some underground CO₂ sequestration potential (Aktouf and Bentellis 2016).

4 Long-Term Bottom-Up Energy Systems Modeling in Support of Evaluating Algeria’s Energy Ambitions Alignment with SDGs

4.1 Energy Modeling in Algeria

Algeria currently lacks extensive long-term, bottom-up prospective models for comprehensive energy systems analysis. A partial equilibrium simulation modeling framework known as EnerNEO has been applied to Algeria, primarily for commercial purposes at present (Hadjer et al. 2023). Additionally, Umaru formulated an energy strategy aligned with Algeria’s SDGs based on a MESSAGE model (Umaru 2021). Neither of these models incorporates the production and export of hydrogen as a means of promoting economic diversification. Prospective analysis exploring possible energy future for Algeria and related challenges exists, but they are not model-based (Supersberger and Führer 2011; Saiah and Stambouli 2017; Zahraoui et al. 2021). To the best of our knowledge, the MESSAGE model developed by Umaru and the TIMAS—DZA model developed by Chabouni (2022), are the only academic prospective bottom-up optimization models applied to Algeria that exist so far (Chabouni 2022).

4.2 TIMES-DZA

TIMES (The Integrated MARKAL-EFOM System) is a bottom-up model generator for energy systems analysis (Loulou et al. 2016). Developed by Chabouni (2022) at the Centre for Applied Mathematics of Mines Paris PSL in France, the TIMES-DZA model focuses on Algeria. The model is part of the TIMES family, which consists of

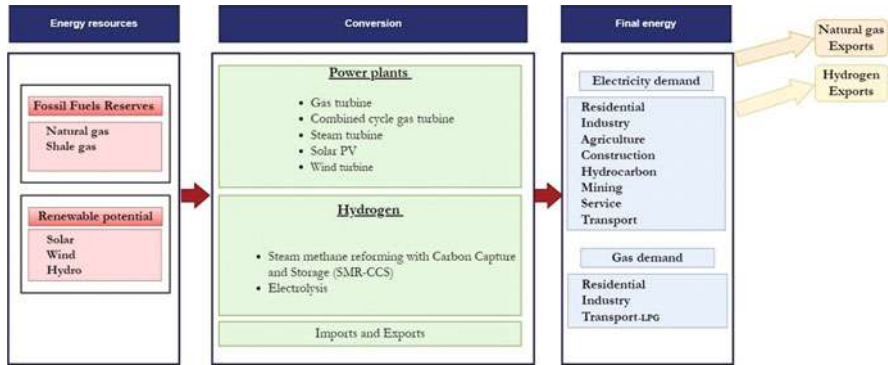

Fig. 1 Simplified RES assumed in the TIMES-DZA model

cost optimization partial equilibrium models. These models are designed to explore and optimize interactions within energy systems, including energy consumption, technologies, trade, system costs, and the marginal costs of environmental policies (Loulou et al. 2016; Wright et al. 2016).

Figure 1 displays the simplified Reference energy system (RES) that describes the structure and energy flows within TIMES-DZA. This system comprises three major parts. The supply side incorporates energy sources such as natural gas, shale gas and renewable resource potential but not petroleum products which are not used today for power production in the Northern interconnected grid (RIN) region. TIMES-DZA covers only RIN, the biggest grid in Algeria that comprises more than 80% of the country's population. The conversion part includes fuels production and conversion technologies, such as H₂ production and various types of power plants. It also encompasses transmission and distribution infrastructures. The demand section covers power and gas demand across different sectors, as well as the quantities of natural gas and H₂ exported. Energy-related CO₂ emissions are also tracked within the model.

The underlying model data for this base year is calibrated to the 2016 energy balances of the Ministry of Energy in Algeria and other international reports (IRENA 2015; Bertelsmann Stiftung 2018; Enerdata 2020; BP 2022). The model is run in 5-year increments up to 2070. The TIMES-DZA model accounts for an 8% discount rate, the average rate set by the CREG (CREG 2016).

4.3 *TIMES-DZA Model Assumptions*

4.3.1 Demand Projection

The application of TIMES-DZA presented in this chapter focuses on the optimization of the hydrogen and gas supply, and uses exogenously fixed demands for power and gas, defined as follows.

Energy demand models analyze the energy-economy relationship, incorporating factors like population, GDP, and socio-economic changes to estimate demand (Saiah and Stambouli 2017). On a side exercise, we developed an econometric model employing Ordinary Least Squares (OLS) technique to link these variables, enabling us to project future electricity and gas demand. We developed a long-run scenario based on likely future growth rates of relevant economic and demographic drivers.

Regression models were separately built for the electricity and gas sectors, incorporating past consumption patterns and relevant explanatory indicators. We developed a “Trend scenario” for electricity and gas demand spanning 2018–2070 (Table 1 and Fig. 2). The demand scenarios in the economic sectors simulates consistent GDP and added value growth in each sector, reflecting Algeria’s GDP trends from 2018 to 2020 at 1.3%. These scenarios do not consider significant reforms that could reshape the economy in the future.

As for the residential sector, population growth is considered a driving factor, which shows a moderate to downward trend, aligning with the UN’s low scenario projected for 2100, as updated in 2019 (UN 2019). Over the last five years, the Algerian population has increased by 2.1%, reaching 41.4 million in 2017. UN projections suggest a relatively steady progression, averaging around 2%, gradually declining to a negative rate of -0.2% by 2070.

As part of its National Energy Efficiency Program (2016–2030), Algeria adopted rationalization measures for energy-intensive sectors like residential, industry, and transport. In the transport sector, the plan aims to promote clean fuels while ensuring an attractive quality/price ratio for customers. One of the initial steps involves annually converting 145,000 vehicles (diesel and gasoline) to liquefied petroleum gas (LPG) since 2019 (Siouani 2023). In this chapter, we consider this additional LPG demand from the transport sector by constructing a low scenario from 2016 to 2070. Using a simple regression model, we estimate the evolution of the car fleet based on GDP per capita scenarios. From this, we derive the car ownership factor, which is projected to increase from 0.15 in 2016 to 0.317 by 2070 in Algeria. We then employ extrapolation to develop three scenarios for the number of vehicles converted to LPG by 2070, aligning with Algerian government policies. Algeria aims to convert approximately one million vehicles to LPG by 2023, reaching a 30% share of converted vehicles by 2030. We calculate the number of converted vehicles by 2030 by applying the 30% share to our fleet scenario and projecting the annual growth rate from 2019 to 2030. For the subsequent years up to 2070, we maintain the same annual number of converted vehicles as in 2030.

4.3.2 Export Projection

Given the key role of hydrocarbons in the country’s fiscal and commercial structure, our TIMES-DZA model maintains a steady natural gas export level of 50.5 Bcm throughout the entire study period until 2070 (Table 2 and Fig. 3), reflecting the average export value observed from 1990 to 2019. This decision aims to ensure

Table 1 Electricity and gas demand projections by sector in the “trend scenario”

Sector	Electricity demand scenario by sector (PJ)*							Total	
	Agriculture	Construction	Hydrocarbons	Industry	Mining	Services	Transport		Residential
2016	1.2	1.2	12.3	55.2	1.2	14.6	2.7	110	198
2050	1.4	2.6	2.9	4.2	31.4	22.1	284	465	814
2070	1.8	3.7	4.1	5.7	40.7	30	500	597	1183
Natural gas demand scenario by end-use sector (PJ)*									
Sector	Residential sector	Industrial Consumers	Transport (LPG)	Total					
2016	330	439	2.5	770					
2050	1660	1420	120	3198					
2070	2425	2550	205	5190					

* It is noteworthy, this scenario is built on a series of the assumptions of the previous mentioned drivers

Fig. 2 End-use demands and substitution options for industry sector

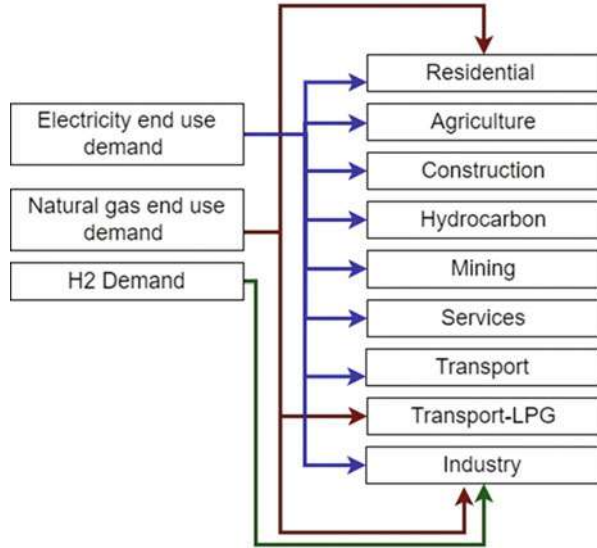

Table 2 Natural gas and hydrogen exports assumptions (in PJ)

	2016	2035	2040	2050	2070
Natural gas exports	1819	1819	1819	1819	1819
H ₂ exports	0	0	144	144	144

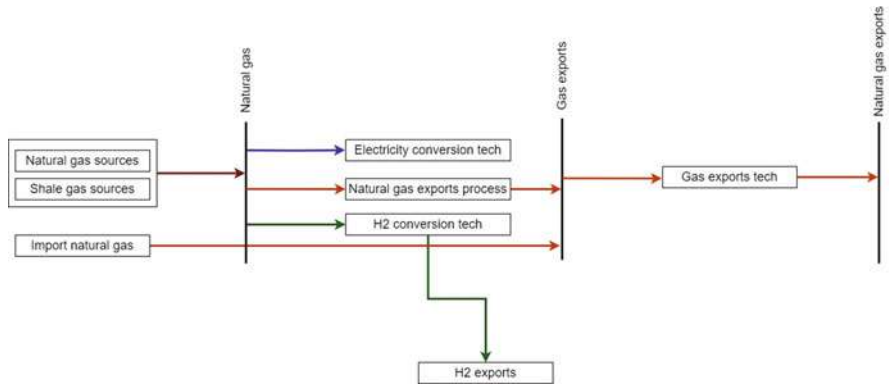

Fig. 3 Visualization of natural gas and H2 exports in TIMES-DZA model

economic stability by securing a reliable income stream and allocating export revenues to finance investments in energy transition and low-carbon technologies progressively over time. In domestic gas resources are too low to satisfy both domestic demand and exports, the model is able to import gas.

This study assumes that natural gas will continue to play a role in specific application where alternative low-carbon technologies face implementation challenges, such as industrial processes, heating, or backup power generation, despite the ongoing energy transition in Europe focused on decarbonation. Additionally, Algeria's natural gas exports to Europe could be utilized in hydrogen production, utilizing methods like natural gas with CCUS, among other potential applications.

Our model incorporates the target of annually exporting 40 TWh of gaseous and liquid H₂ to the European market, maintained throughout the year 2070 (Table 2), and aligning with the government's stated objectives.

4.3.3 Shale Gas Development

To address the depletion of Algeria's natural gas reserves and ensure sustained supply for exports and future demands, the government is contemplating the development of shale gas resources, aligned with Sonatrach's strategic plan (SH2030). The aim is to achieve an unconventional gas production level of 20 Bcm by 2030.

Incorporating shale gas development into our TIMES-DZA model, we have formulated assumptions regarding its future trajectories. A maximum additional capacity level for shale gas has been fixed for the entire period (2030–2070).

Due to limitation in expertise and infrastructure, Algeria faces constraints in shale gas extraction. Aligning with the SH2030 target, we derived a scenario projecting additional shale gas capacity based on the country's natural gas production growth rate (2011–2021), set at 2.4% in the latest BP Statistical Review of World Energy (BP 2022). By extrapolation, shale gas capacity could reach around 48 Bcm (1797 PJ) by 2070 (Table 3).

In our modeling approach, we have assumed a moderate shale gas extraction cost of 5€/GJ, in line with relevant literature (Orthofer et al. 2019).

4.3.4 Future Technological Options

This chapter explores the prospects of shale gas development by investigating the future applications of Combined Cycles Gas Turbine (CCGT) for electricity generation while excluding CCGT with carbon capture and storage (CCS).

Algeria's strategic location offers ideal conditions for RE development, with abundant solar PV potential exceeding 27,000 TWh and wind energy potential surpassing 32,000 TWh (IRENA 2023b). Hence, TIMES-DZA includes solar PV and onshore wind as future investment options.

Table 3 Evolution of additional shale gas capacity from 2030 to 2070

Horizon	2030	2035	2040	2050	2060	2070
Shale gas additional capacities (PJ)	747	840	945	1185	1470	1797

For hydrogen production, two options are considered: electrolyzers for green hydrogen and steam methane reforming with CCS (SMRCCS) for blue hydrogen (IRENA 2023c). However, the model limits the maximum capacities of these technologies to 5 GW/year, equivalent to approximately 34 electrolyzing facilities of 150 MW/year.

4.3.5 Electricity Generation Technologies in TIMES-DZA

To construct TIMES-DZA, we compiled data from various sources to establish a comprehensive database on Algeria's power and gas systems. Extensive review of national international reports was conducted for this purpose (BP 2022; MEM 2022; IRENA 2023a; EIA 2023).

Tables 4 and 5 report the techno-economic characteristics of Algeria's electricity generation technologies required for this study (IRENA-ESTAP 2013; Cannone et al. 2021; IEA-ETSAP 2024).

The study accounts for decreasing costs of renewable technologies, particularly solar and wind energy. Additionally, it assumes consistent fixed costs for emerging hydrogen technologies, acknowledging their current status as relatively immature technologies (Table 6).

Table 4 Current and future power capacity by technology

Power plants		2019 Stock (GW)	Committed	Planned (GW)	Possibility of future investment
Thermal plants	Steam turbine	2.4	/	/	No
	Gas turbine	11.3	/	/	Yes
	Combined cycles	4.3	8.2	/	Yes
	Mobile gas turbine	1.3	/	/	No
	Diesel generators	0.4	/	/	Yes
Nuclear	Nuclear reactor	16	/	2.4	Yes
Renewable energies					
Hydro	Hydropower	0.227	/	/	No
Solar	PV solar	0.219	1 (2023)	13.5 (2030)	Yes
	CSP	2	/	2	Yes
Wind	On-shore	0.01	/	5	Yes
	Off-shore	/	/	/	No
Bioenergy	Biomass	1	/	/	No
Hydrogen	SMRCCS	/	/	40 TWh	Yes
	Electrolysis	/	/		Yes

Table 5 Techno-economic parameters of electricity generation technologies

		Capital cost (€/kW in 2020)	Fixed cost (€/kW in 2020)	Operational life (year)	Efficiency	Average capacity factor
Thermal plants	Combined cycles	1200	35	30	0.48	0.85
Nuclear	Nuclear reactor	6137	184	50	0.33	0.85
Solar	PV	1378	17.9	24	1.0	0.35
	CSP	4058	40.6	30	1.0	0.45
Wind	On-shore	1489	59.6	25	1.0	0.21
Hydrogen	Electrolyzer	1866	93.3	20	1.0	–
	SMRCCS	265	13.2	20	0.9	–

Table 6 Renewable and hydrogen technologies costs assumptions

EUR/kW	INVCOST~2030	INVCOST~2040	INVCOST~2050	INVCOST~2070
Wind	967	830	830	830
Solar	869	802	727	727
SMRCCS	265	265	265	265
Electrolyzer	1867	1867	1867	1867

4.4 Scenario Definition

This chapter aims to evaluate the impact of current policies on RE integration, and hydrogen development on the future energy system. It also seeks to assess technological configurations by 2070 and the impact of associating these strategies with a CO₂ emission reduction constraint aligned with SDG 13.

Three long-term scenarios are proposed and analyzed using the TIMES-DZA model, as described below and in Table 7.

The reference scenario “All fossil fuels (BAU)” explores conventional and unconventional resources while following Sonatrach's 2035 strategy. It assumes no climate policies or pledged actions but allows for investments in RE sources. The goal is to assess the impact of an unrestricted fossil fuel trajectory on Algeria's power system by 2070.

The Renewable + Hydrogen scenario “ReN + H₂” incorporates exploration of conventional and non-conventional resources, focusing on RE development (solar PV and wind power) and hydrogen production (blue and green hydrogen). It evaluates the feasibility of achieving Algeria's REs and hydrogen production targets and their role in shaping a more balanced energy mix, aligning with SDG 7 principles. Moreover, it provides insights for policymakers on crafting comprehensive and effective strategies for a sustainable energy future.

The Renewable + Hydrogen + CO₂ bound scenario “ReN + H₂ + CO₂ bound”. Building upon the BAU scenario, this scenario aims to achieve gradual

Table 7 Scenarios assumptions summary

	All fossil fuels (BAU)	ReN + H ₂	ReN + H ₂ + CO ₂ _bound
Electricity and gas demand	Trend scenario	Trend scenario	Trend scenario
Fossil-fuel based generation	Allowed	Allowed	Allowed
Development of solar and wind	Allowed	Allowed	Allowed
Limit on RE potential use	No	No	No
Natural gas Export target (PJ/year)	1819 (fixed for all periods)	1819 (fixed for all periods)	1819 (fixed for all periods)
Shale gas development limit	Yes	Yes	Yes
H ₂ export targets (PJ/year)	No	144 (same for all periods beginning 2040)	144 (same for all periods beginning 2040)
Upper bound constraint for H ₂ production technologies (GW/year)	No	5	5
Lower bound on RE share in total generation (in %)	No	30% (starting 2035)	30% (starting 2035)
CO ₂ reduction target	No	No	Gradual CO ₂ emissions reduction (−25% by 2035, −35% by 2050 and −50% by 2070, compared to BAU)

CO₂ emissions reduction, reaching 50% reduction by 2070 compared to the projected level under the BAU scenario. It maintains the parameters of the “ReN + H₂” scenario and assesses the impact of ambitious climate action on Algeria’s 2070 power system configurations, aligning with SDG 13.

4.5 Results

4.5.1 All Fossil Fuels Scenario

Figure 4 depicts the primary energy supply in the BAU scenario from 2016 to 2070. By 2070, the total energy supply reaches 11.7 EJ, marking a 2.5-fold increase compared to 2016, primarily driven by population growth. This study does not consider energy efficiency measures such as energy-efficient lighting or smart building technologies. The findings suggest a shift in energy supply dynamics over time, with declining natural gas reserves leading to increased reliance on

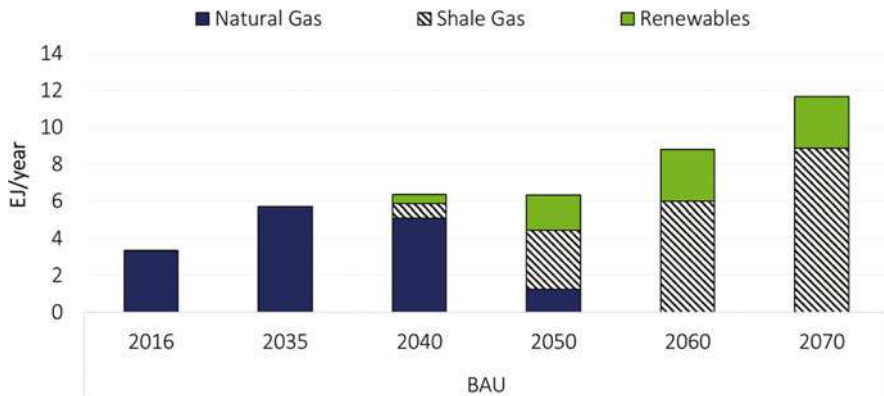

Fig. 4 Primary energy supply under the BAU scenario

shale gas and a growing contribution from renewables, especially after 2050. Fossil fuels maintain a significant role, highlighting Algeria's dependence on hydrocarbons. Meanwhile, the share of renewables (solar+ wind) rises, reaching 24% of the total energy supply by 2070 (from 4% in 2040).

Figure 5 illustrates that in the BAU scenario, fossil-fuel-based power plants (Combined cycles without CCS) dominate power generation, exceeding 70% until 2040 and maintaining significant presence through 2070. This dominance is closely tied to the development of shale gas, serving domestic demand and fueling international gas exports. By 2050, renewables will surpass fossil fuels, constituting 60% of the power mix by the end of the projection period. This significantly elevates the share of renewables in total power generation from 0.4% (297 GWh) in 2016 to 57% (166 TWh) in 2050 and 56% (240 TWh) in 2070, reflecting a more decarbonized trajectory. However, the outcomes of the BAU scenario slightly deviate from Algeria's National Renewables policy, which targets 30% renewable power generation by 2035. Instead, our results show integration of renewables from 2040 at 25%. Several factors contribute to this delay, including over-reliance on natural gas that hinders the transition. Additionally, substantial investments in renewable projects are required, although the renewable sector may not be technologically mature or economically competitive enough compared to the gas industry by 2035.

The contributions of wind and solar PV are balanced until 2050, after which solar PV emerges as the primary contributor through 2070. Projected installed capacity for solar PV and wind power in 2070 are 92.1 GW and 42.1 GW, respectively. These findings closely align with those reported by IRENA in the "Planned scenario", indicating that natural gas remains the dominant contributor to electricity generation in North Africa in 2040. Specifically, Algeria's power generation mix for 2040 comprises 74% natural gas, 15% solar PV, and 11% wind power.

Figure 6 illustrates the final gas usage in the BAU scenario from 2016 to 2070. In the long term, domestic natural gas will meet demand across residential, industrial, and LPG-transport sectors. By 2070, these sectors collectively account for 63% of

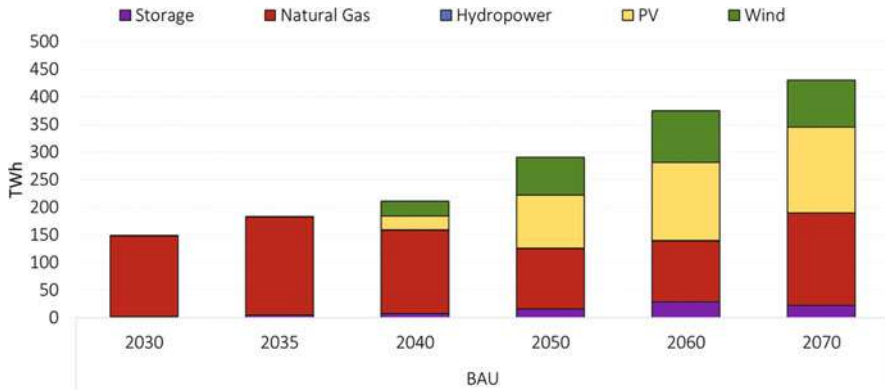

Fig. 5 Power generation by sources under the BAU scenario

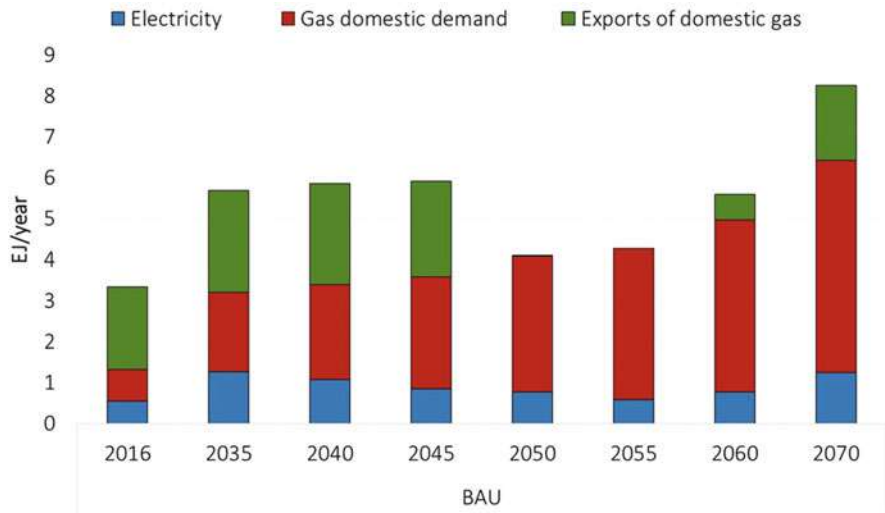

Fig. 6 Final natural gas usage in the BAU scenario

the total gas consumption. There is a drop and recovery in export levels between 2050 and 2060, driven by the shift from domestic natural gas to domestic shale gas and the depletion of domestic natural gas resources (Fig. 3). Imports of gas are then needed to satisfy the required exports when domestic resources are not sufficient. Due to the high cost of importing natural gas, the model opts to halt exports until domestic reserves recover, resuming exporting by 2060. This fluctuation might have economic, social, and geopolitical repercussions, requiring Algeria’s resilience in adapting to changing market conditions. Exports of domestic gas are expected to rebound, approaching the 2016 levels (2 EJ) by 2070 (1.8 EJ).

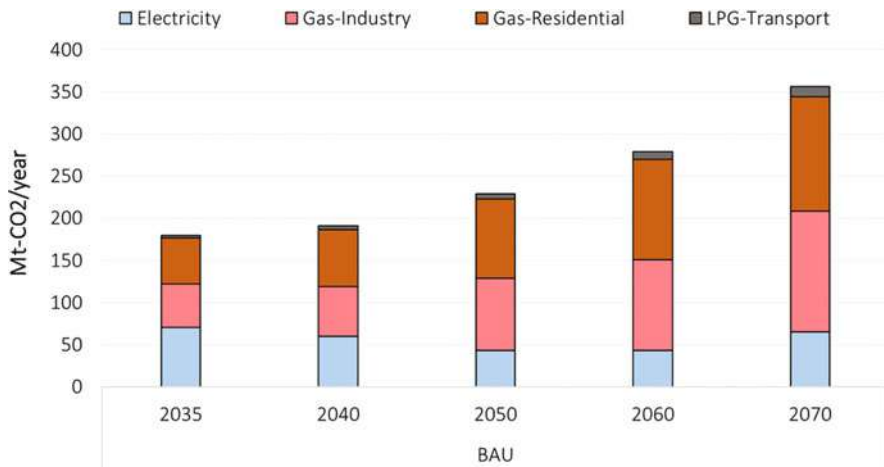

Fig. 7 CO₂ emissions related to gas use by the power and end-use sectors in the BAU scenario

In Fig. 7, CO₂ emissions from sectors consuming only natural gas and/or electricity experience a significant increase from 2016 levels, reaching 420 Mt of CO₂ by 2070. The breakdown of emissions reveals a nearly equal contribution from both the industrial and residential gas sectors to the overall increase of CO₂ emissions in Algeria. Their respective shares have increased from 18% and 24% in 2016 to 32% and 34% by 2070. In contrast, the power sector continues to emit CO₂; however, its share has halved by 2050, attributed to the increased utilization of renewables for electricity generation. By the end of the studied period, this sector contributes 18% to the total CO₂ emissions.

4.5.2 Comparison of BAU and ReN + H₂ Scenarios

The ReN + H₂ scenario shares the same assumptions as the BAU concerning shale gas development while aligning with Algeria's current renewable targets and enabling hydrogen production. This new feature does not decrease CO₂ emissions from power and gas sector except for the year 2035, due to renewable energy development. This is attributed to the utilization of SMRCCS for hydrogen production. It's worth mentioning that electrolyzers were not used in this scenario due to their high cost. Consequently, the overall trends in CO₂ emissions by sector in the ReN + H₂ scenario closely mirror those of the reference case (Fig. 8).

The results in terms of electricity generation are presented in Fig. 9. The difference between both scenarios comes from the assumption of enforcing a minimum 30% share of renewables by 2035, as stipulated in Algeria's energy policy. The outcomes reveal that this specified share would exclusively derive from solar PV sources, contributing approximately 51.7 TWh to the overall power generation.

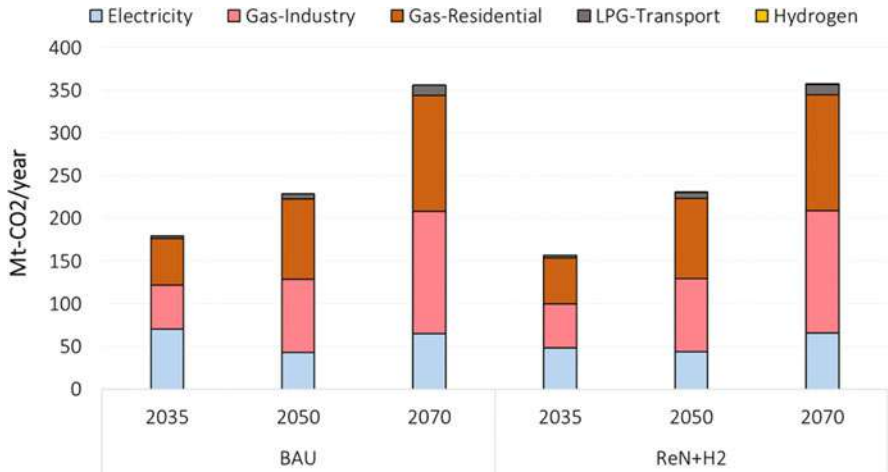

Fig. 8 CO₂ emissions related to gas uses by the power and end-use sectors under the BAU and ReN + H₂ scenarios

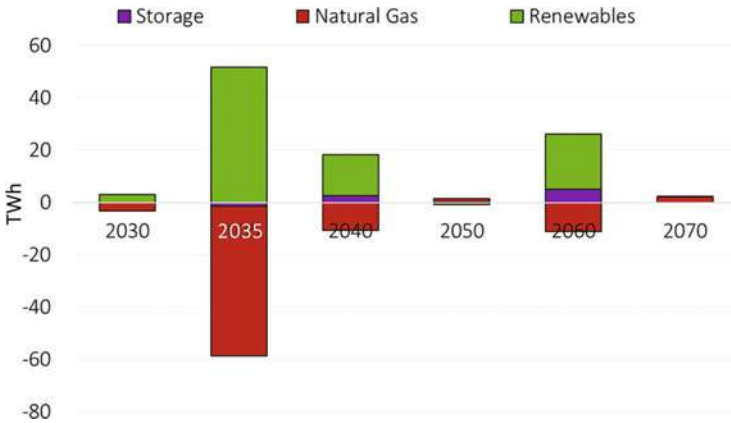

Fig. 9 Differences in power generation by sources between BAU and ReN + H₂ scenarios

Overall, the ReN + H₂ scenario entails a reduced deployment of fossil fuel generation.

4.5.3 Decarbonization Pathway: ReN + H₂ + CO₂_Bound Scenario

The analysis of the decarbonization scenario for Algeria’s energy system has unveiled an expected shortfall in gas and hydrogen supply by 2070. These shortages pose challenges in meeting final energy requirements, as depicted in Fig. 10.

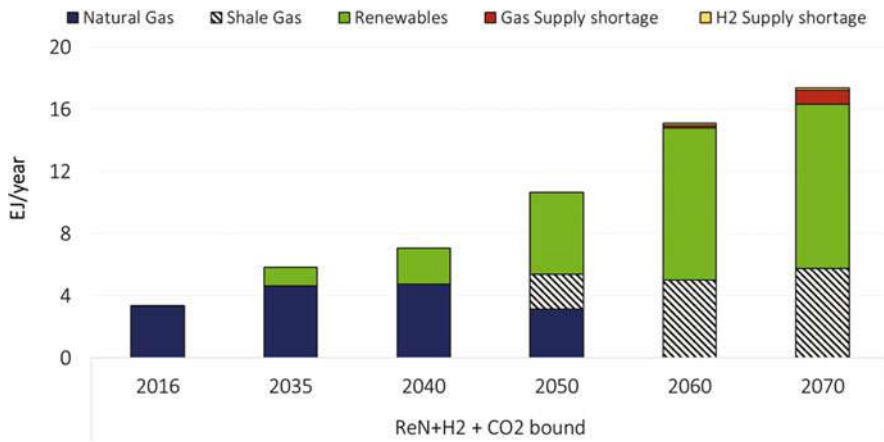

Fig. 10 Primary energy supply under the ReN + H₂ + CO₂_bound scenario

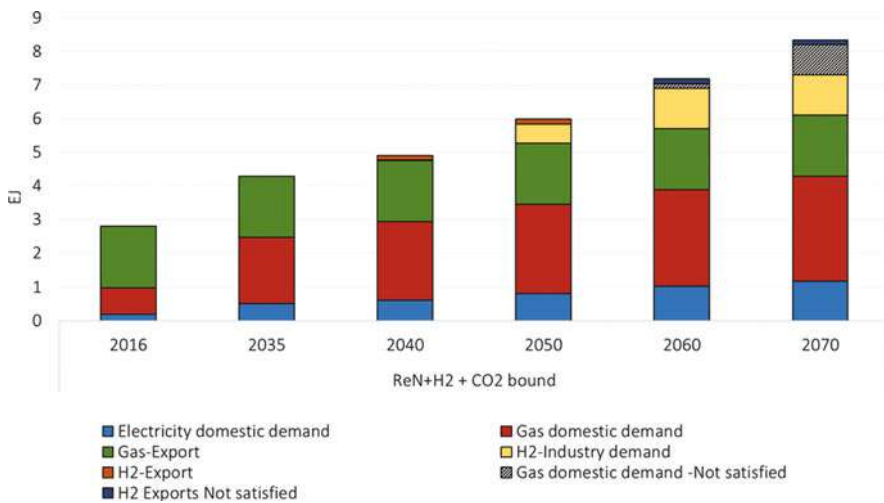

Fig. 11 Final energy demand under the ReN + H₂ + CO₂_bound scenario

Bounding CO₂ emissions highlighted some limitations, revealing that by 2070, approximately 25 Bcm of residential gas demand remained unsatisfied, and hydrogen exports were halted by 2060 (Fig. 11).

These supply deficiencies could potentially lead to various challenges for Algeria, encompassing economic repercussions, power outages, and social unrest. Nevertheless, as part of efforts to mitigate CO₂ emissions and align with SDG 13 aimed at combating climate change, our model proposes a strategy to replace a share of the gas industry demand with hydrogen starting from 2050. This initiative results in a significant surge in hydrogen production, utilizing both SMRCCS and electrolysis at

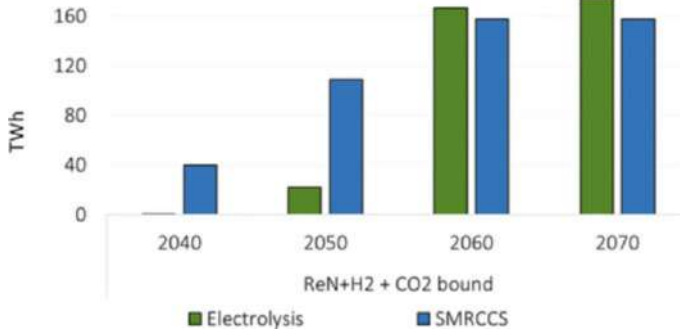

Fig. 12 Hydrogen production under the ReN + H₂+ CO₂_bound scenario

full capacity (5GW/year/technology). By 2070, the production levels reach 175 TWh and 158 TWh, respectively, as illustrated in Fig. 12.

Due to the imposed CO₂ emissions constraint, the proportion of renewables in Algeria's power generation is projected to experience substantial growth, surpassing the targeted share outlined in the policy by 2035 in the decarbonization scenario compared to the ReN + H₂ scenario. The key factor driving this divergence is the substantial increase in the installed capacity of renewable power.

By 2040, electricity generation from renewable power is projected to nearly triple in the decarbonization scenario, reaching 200 TWh, in contrast to the ReN + H₂ scenario's 68 TWh, primarily attributed to green hydrogen generation. According to IRENA's report (IRENA 2023b), Algeria possesses significant (theoretical) renewable energy potential, with solar resources estimated at 27,904 TWh/year and wind resources at 30,155 TWh/year. By 2070, power generation is 100% renewable, with 700 TWh from solar PV and 120 TWh from wind. This suggests that the achieved generation represents only a fraction of the theoretical potential.

Despite a seemingly modest goal to reduce CO₂ emissions in this exercise, the findings (Fig. 12) highlight that Algeria will encounter various challenges, including substantial upfront economic investments, technical hurdles in grid integration, financial constraints, and the need for clear policies to ensure a smooth transition. Furthermore, incorporating substantial amounts of renewables poses an additional challenge related to the intermittent nature of solar and wind power. Effectively harnessing these resources hinges on the implementation of a robust storage system. The outcomes of our scenarios underscore this imperative, revealing a notable surge in storage capacity. By 2070, the storage infrastructure is projected to expand significantly, reaching more than 220 TWh.

Figure 13 presents the CO₂ emissions associated with Algeria's power and gas sectors under the decarbonization scenario. The results reveal a continuous upward trajectory in total CO₂ emissions until the year 2070, notably driven by emissions emanating from the gas sector. In contrast, CO₂ emissions related to the power sector are projected to decline considerably to reach zero emissions by 2050, coinciding with 100% of electricity generation from renewables. These findings underscore the

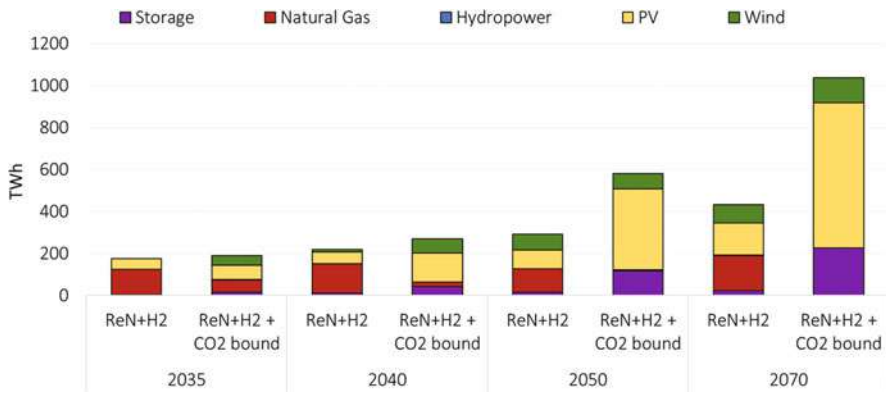

Fig. 13 Power generation by sources under ReN + H₂ and ReN + H₂ + CO₂_bound cases

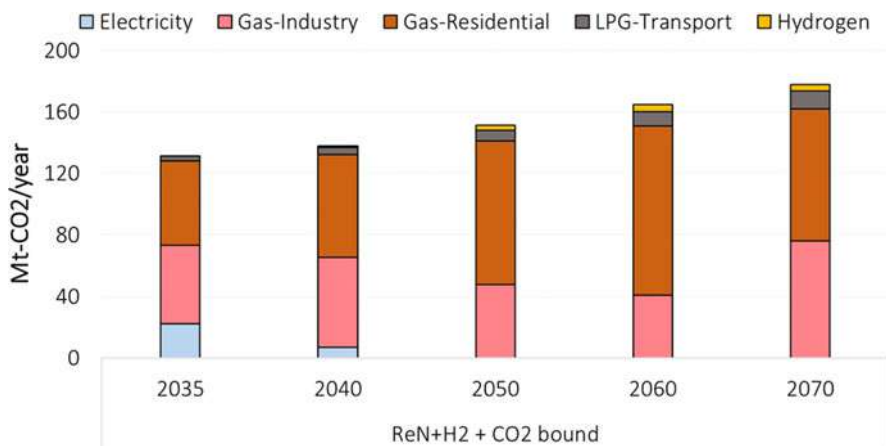

Fig. 14 CO₂ emissions related to gas uses by the power and end-use sectors under ReN + H₂ with CO₂_bound scenario

imperative for Algeria to intensify its efforts in addressing emissions from other gas consuming sectors, particularly the residential and industrial sectors. Achieving alignment with the SDG targets necessitates a dedicated commitment to addressing emissions in these sectors (Fig. 14).

5 Discussion and Concluding Remarks

This study used the TIMES-DZA model to investigate Algeria’s future energy system. The results reveal that in the absence of actions taken to fight climate change (BAU scenario), Algeria’s reliance on hydrocarbon resources is projected to

intensify, leading to a structural imbalance within its economy and potentially triggering a recession stemming from the decline in natural gas resource exports. This scenario poses threats to both energy security and the environment, conflicting with the core principles of SDG 7 and 13.

To address the impact of rent dependency, the study introduces the Algerian government's renewables energy and hydrogen exports targets in 2035 and 2040 respectively (ReN + H₂ scenario). This strategic shift allows for a significantly more diversified power supply, aligning with SDG 7. Notably, the share of RE in electricity increases from 2% in 2035 in the BAU scenario to 30% in 2035 in the ReN + H₂ scenario, indicating a more sustainable energy mix based on modern low-carbon sources. However, the study finds that setting a renewable penetration target alone may not be sufficient to effectively reduce GHG emissions in the long run, thereby falling short of alignment with SDG 13.

Our findings suggest that achieving significant CO₂ emissions reduction by 2070 in Algeria necessitates a substantial and extensive development of RE. Decarbonizing the Algerian energy sector involves the installation of an additional 54 GW of solar and wind capacity by 2070, compared to the ReN + H₂ scenario. It's noteworthy that for the year 2022, less than 0.6 GW of renewable energies were reported, underscoring the substantial scale-up required to achieve the ambitious decarbonization goals. This indicates that the current targets set by Algeria for RE development may be insufficient to make a substantial impact on lowering the country's GHG emissions, a key aspect of SDG 13. Furthermore, the study highlights a potential challenge to the decarbonization of Algeria's domestic energy system posed by the country's hydrogen strategy. The production of green hydrogen requires additional renewable capacity. Therefore, achieving this export strategy would demand a rapid acceleration in the rate of installing new renewable capacity, raising questions about the feasibility of implementing this strategy while decarbonizing the domestic energy system.

Bottom-up models like TIMES-DZA play a crucial role in offering policy makers detailed insights into energy system trajectories aligned with specific targets, such as GHG emissions reductions. They provide valuable information that serves as a foundation for making informed decisions regarding technology choices and long-term investments in the energy sector, which is pivotal in the global effort to combat climate change. While bottom-up, technology-rich, optimization models excel in providing detailed energy pathways and informing technology and investment decisions, it's acknowledged that they may not inherently provide insights into the broader economic repercussions of these energy pathways. Nevertheless, the TIMES-DZA model, by contributing valuable insights aligned with current policy objectives, can play a significant role in fostering a sustainable and resilient energy future for Algeria.

This study applied TIMES modeling approach to optimize the power and hydrogen production of Algeria. The use of exogenous fixed demands by end-uses constitutes a limitation. Further analyses with endogenous substitution between fuel uses may provide additional insights to the achievement of SDG 7 and 13. Further improvements of TIMES-DZA could also encompass a greater proportion of

low-carbon energy sources. Another alternative technology that could be added is fossil fuels with CCS, a crucial tool to decarbonize the energy system. Finally, these results tend to advocate for more solar power than wind. Algeria has abundant resources for both renewable energy sources and future analyses could better investigate this trade-off.

References

- Addi L (1995) Algeria's new oil strategy. In: *Oil in the new world order*. University Press of Florida, Florida, pp 89–102
- Aissaoui A (2016) Algerian gas: troubling trends, troubled policies. The Oxford Institute for Energy Studies. OIES PAPER: NG 108.
- Akacem K (2004) Economic reforms in Algeria: an overview and assessment. *J North Afr Stud* 9(2):115–125
- Akrofi MM (2021) An analysis of energy diversification and transition trends in Africa. *Int J Energy Water Res* 5:1–12
- Aktouf A, Bentellis A (2016) CO₂-storage assessment and effective capacity in Algeria. *SpringerPlus* 5(1):1038
- Allali M, Tamali M, Rahli M (2015) The impact of CO₂ emission on output in Algeria. *Energy Procedia* 74:234–242
- Andreff W, Hayab A (1978) Les priorités industrielles de la planification algérienne sont-elles vraiment «industrialisantes»? *Revue Tiers Monde* 19(76):867–892
- Aouissi A, Haggmark B (2023) Développement de l'hydrogène: l'Algérie peut devenir un acteur régional majeur. In: *Algérie Presse Service*
- Auty RM (2003) Third time lucky for Algeria? Integrating an industrializing oil-rich country into the global economy. *Resour Policy* 29(1):37–47
- Barbero Vignola G, Acs S, Borchardt S, Sala S, Giuntoli J, Smits P, Marelli L (2020) Modelling for sustainable development goals (SDGs): overview of JRC models. Publications Office of the European Union, Luxembourg
- Beblawi H (1987) The rentier state in the Arab world. *Arab Stud Q* 9(4):383–398
- Bertelsmann Stiftung (2018) BTI 2018 country report—Algeria. Bertelsmann Stiftung, Gütersloh
- BP (2022) *bp Statistical Review of World Energy 2022*. 71st edition. Retrieved from: <https://www.bp.com/content/dam/bp/business-sites/en/global/corporate/pdfs/energy-economics/statistical-review/bp-stats-review-2022-full-report.pdf>
- Cannone C, Allington L, Pappis I, Barron KC, Usher W, Pye S, Brown E, Howells M, Walker MZ, Ahsan A, Charbonnier F, Halloran C, Hirmer S, Taliotis C, Sundin C, Sridha V, Ramos E, Brinkerink M, Deane P, Gritsevskiy A, Moura G, Rouget A, Wogan D, Barcelona E, Rogner H (2021) Selected 'Starter Kit' energy system modelling data for Algeria (#CCG). 04 May 2021, PREPRINT (Version 2) available at Research Square. <https://doi.org/10.21203/rs.3.rs-478421/v2>
- Chabouni N (2022) Long-term energy prospective modeling: development and application of the TIMES-DZA model to Algeria's power and gas system for the horizon 2070. *Economie et statistique Appliquée, ENSSEA (Thesis)*, Algeria
- Cherigui A-N, Mahmah B, Harouadi F, Belhamei M, Chader S, M'Rouai A, Etievant C (2009) Solar hydrogen energy: the European–Maghreb connection. A new way of excellence for a sustainable energy development. *Int J Hydrog Energy* 34(11):4934–4940
- CREG (2016) Programme indicatif d'approvisionnement du marché national en gaz sur la période 2016–2025—CREG. Electricity and Gas Regulatory Commission (Algeria). Retrieved from: <https://creg.dz/programmes-indicatifs/>

- CREG (2023) Programme indicatif d’approvisionnement du marché national en gaz sur la période 2023–2032—CREG. Electricity and Gas Regulatory Commission (Algeria). Retrieved from: <https://creg.dz/programmes-indicatifs/>
- Crippa M, Guizzardi D, Schaaf E, Monforti-Ferrario F, Quadrelli R, Risquez Martin A, Rossi S, Vignati E, Muntean M, Brandao De Melo J, Oom D, Pagani F, Banja M, Taghavi-Moharamli P, Köykkä J, Grassi G, Branco A, San-Miguel J (2023) GHG emissions of all world countries: 2023. Joint Research Centre (European Commission), EUR (Luxembourg. Online). Publications Office of the European Union
- EC (2022) REPowerEU plan. European Commission, Brussels
- EIA (2023) International data on electricity. Retrieved from: <https://www.eia.gov/electricity/data.php>
- Enerdata (2020) – Energy Report – Algeria – Copyright © Enerdata. Pages 1–42
- Fuinhas JA, Marques AC (2013) Rentierism, energy and economic growth: the case of Algeria and Egypt (1965–2010). *Energy Policy* 62:1165–1171
- Gasmi F, Laourari I (2017) Has Algeria suffered from the Dutch disease? Evidence from 1960–2016 data. *Rev Econ Polit* 127(6):1029–1058
- Hadjer H, Chaouche S, Michoud B, Ghersi F (2023) Macroeconomic challenges of energy transitions: the case of Algeria. In: Presented during the 26th annual conference on global economic analysis, Bordeaux
- IEA-ETSAP (2024) E-TechDS—Energy Technology Data Source. Retrieved from: <https://iea-etsap.org/index.php/energy-technology-data>
- Interministerial Committee for the follow-up of the SDGs (2019) Algérie—Rapport National Volontaire 2019: Progression de la mise en oeuvre des ODD. Interministerial Committee for the follow-up of the SDGs, Algeria
- International Crisis Group (2018) Breaking Algeria’s Economic Paralysis. Middle East and North Africa Report N°192
- IRENA (2015) Africa 2030: Roadmap for a Renewable Energy Future. IRENA, Abu Dhabi. www.irena.org/remap
- IRENA (2023a) Renewable energy statistics 2023. International Renewable Energy Agency, Abu Dhabi
- IRENA (2023b) Planning and prospects for renewable power: North Africa—data appendix. International Renewable Energy Agency, Abu Dhabi
- IRENA (2023c) Planning and prospects for renewable power: North Africa. International Renewable Energy Agency, Abu Dhabi
- IRENA-ESTAP (2013) Technology briefs: concentrating solar power. International Renewable Energy Agency, Abu Dhabi
- Loulou R, Lehtilä A, Kanudia A, Remme U, Goldstein G (2016) Documentation for the TIMES model PART II: reference manual. Energy Technology Systems Analysis Programme (July), pp 1–78
- Machín Álvarez A (2010) Rentierism in the Algerian economy based on oil and natural gas. *Energy Policy* 38(10):6338–6348
- Mekideche M (2009) Le secteur des hydrocarbures en Algérie. Piège structurel ou opportunité encore ouverte pour une croissance durable? *Confluences. Méditerranée* 71(4):153–166
- MEM (2022) Bilan énergétique national 2021. République Algérienne Démocratique et Populaire, Ministère de l’Energie et des Mines (MEM). Retrieved from: <https://www.energy.gov.dz/?article=bilan-energetique-national-du-secteur>
- OECD/WTO (2019) Economic diversification: lessons from practice, in *Aid for Trade at a Glance 2019: Economic Diversification and Empowerment*, OECD Publishing, Paris. Chapter 5. pp 135–160
- Oliva M-A (2000) Estimation of trade protection in Middle East and North African countries. IMF working paper. International Monetary Fund. Paper No. 2000/027
- Orthofer CL, Huppmann D, Krey V (2019) South Africa after Paris-fracking its way to the NDCs? *Front Energy Res* 7:1–15

- Ouchene B, Moroncini A (2018) De l'économie socialiste à l'économie de marché: l'Algérie face à ses problèmes écologiques. *VertigO—la revue électronique en sciences de l'environnement*
- Ouki M (2019) Algerian gas in transition: domestic transformation and changing gas export potential. Oxford Institute for Energy Studies, Oxford
- Safir N (2019) Algeria in the 2000s: a rentier system in crisis. In: *The politics of Algeria*. Routledge, London/New York
- Saiah SBD, Stambouli AB (2017) Prospective analysis for a long-term optimal energy mix planning in Algeria: towards high electricity generation security in 2062. *Renew Sust Energy Rev* 73 (Jan):26–43
- Serrano F (2022) Higher oil prices are giving Algeria's regime breathing room. Middle East Institute. Retrieved from: <https://www.mei.edu/publications/higher-oil-prices-are-giving-algerias-regime-breathing-room>
- Services du Premier Ministre (2021) Plan d'action du gouvernement pour la mise en oeuvre du programme du Président de la République. République Algérienne Démocratique et Populaire
- Siouani A (2023) The evolution of the conversion of cars into liquefied petroleum gas fuel (GPLC) in Algeria until 2025. *Revue Des Sciences Administratives Et Financières (ASJP)* 07(01): 688–698
- Supersberger N, Führer L (2011) Integration of renewable energies and nuclear power into North African energy systems: an analysis of energy import and export effects. *Energy Policy* 39(8): 4458–4465
- Trieb F, Müller-Steinhagen H (2007) Europe–Middle East–North Africa cooperation for sustainable electricity and water. *Sustain Sci* 2(2):205–219
- Umaru EK (2021) Planning a Long Term Energy System Using the International Atomic Energy Agency Modeling Tool MESSAGE (Model for Energy Supply Strategy Alternatives and Their General Environmental Impacts) Case study: Algeria. Vol. 5. Pages: 24–39
- UN (2019) Department of Economic and Social Affairs, Population Division (2019). *World Population Prospects 2019, Volume I: Comprehensive Tables (ST/ESA/SER.A/426)*
- UNECA (2017) Diversifying Algeria's exports challenges and prospects relating to the African market. United Nations. Economic Commission for Africa. Sub regional office for North Africa, Addis Ababa
- World Bank (2015) MENA quarterly economic brief, January 2015: plunging oil prices. Retrieved from: <https://www.worldbank.org/en/region/mena/publication/mena-quarterly-economic-brief-january-2015-plunging-oil-prices>
- World Bank (2016) How is Algeria reacting to low oil prices?. Retrieved from: <https://www.worldbank.org/en/country/algeria/publication/economic-brief-july-2016>
- World Bank (2018) Commodity prices to rise more than expected in 2018. Retrieved from: <https://www.worldbank.org/en/news/press-release/2018/04/24/commodity-prices-to-rise-more-than-expected-in-2018-world-bank>
- World Bank (2022) Algeria | Data. In: *The World Bank Data*. Retrieved from: <https://data.worldbank.org/country/algeria>
- Wright E, Kanudia A, Loulou R, Goldstein G (2016) Documentation for the TIMES model—Part V: VEDA Back-End. Energy Technology Systems Analysis Programme (ETSAP) (October), pp 1–72
- Zahraoui Y, Basir Khan MR, AlHamrouni I, Mekhilef S, Ahmed M (2021) Current status, scenario, and prospective of renewable energy in Algeria: a review. *Energies* 14(9):2354

Open Access This chapter is licensed under the terms of the Creative Commons Attribution 4.0 International License (<http://creativecommons.org/licenses/by/4.0/>), which permits use, sharing, adaptation, distribution and reproduction in any medium or format, as long as you give appropriate credit to the original author(s) and the source, provide a link to the Creative Commons license and indicate if changes were made.

The images or other third party material in this chapter are included in the chapter's Creative Commons license, unless indicated otherwise in a credit line to the material. If material is not included in the chapter's Creative Commons license and your intended use is not permitted by statutory regulation or exceeds the permitted use, you will need to obtain permission directly from the copyright holder.



Part IV
Engaging with Policy-Makers on Energy
System Models

Integrating Sustainable Development Goals to Assess Energy Transition Scenarios in Municipalities of Northern Sweden



Parvathy Sobha and Anna Krook-Riekkola

Abstract Local governments face significant challenges in implementing the United Nations Sustainable Development Goals (SDGs). To address these challenges, the study adopts a model-based system analysis approach for integrating sustainable development principles into the local energy transition, examining (i) what to include and vary across scenarios, (ii) what to extract from the model results, and (iii) what to discuss with the local governments. An energy system optimisation model, based on the TIMES modelling framework, is employed to represent the municipal energy system of Gällivare in northern Sweden and its potential transition pathways. The study also provides a comparative data-driven assessment to examine whether the energy transition pathways converge or diverge from the SDGs. In addition, a set of sustainability indicators has been identified/developed and are implemented in the model to assess sustainability across different pathways. The challenge inherent in such quantitative comparisons, particularly those of a complex nature such as sustainability, lies in selecting appropriate indicators for municipalities that align with the model's framework. The analysis shows both convergent and divergent pathways. For instance, electrification in the identified transition pathways reduces fossil fuel use (converges towards SDG13 on climate), but electrification also introduces complexities with increased material usage for electric vehicles (diverges from SDG12 on responsible consumption and production).

Key Messages

- Application of the TIMES-based energy system optimisation model to systematically explore how local energy systems can meet future societal needs sustainably.
- Development of an inventory on integrating each SDG while assessing energy transition scenarios in the municipalities of northern Sweden.

P. Sobha (✉) · A. Krook-Riekkola
Luleå University of Technology, Luleå, Sweden
e-mail: parvathy.sobha@ltu.se; anna.krook-riekkola@ltu.se

- Introduction of a heatmap including indicator values in different future energy pathways as an effective tool for evaluating and communicating the sustainability of such pathways.
- Assistance in highlighting synergies between SDG7 (on energy), SDG11 (on cities), and SDG13 (on climate) while featuring trade-offs between SDG7 (on energy affordability), SDG12 (on responsible consumption and production), and SDG13 (on climate).

1 Introduction

Northern Sweden is undergoing an accelerated green transition in response to market demand and the urgent need for sustainable societies (Arctic Center of Energy 2023). *Green transition* refers to the shift from an economy heavily reliant on fossil fuels and other environmentally harmful practices to one that is characterised by sustainable and environmentally friendly practices. The latter include energy transitions and the development of new industrial establishments. Municipalities in northern Sweden are at the centre of emerging mega-projects aimed at positioning the country at the forefront of green industries (Nordic Cooperation 2023). Construction and planning are in full swing in northern Sweden as they prepare for the associated energy transition and its concomitant industries. The projected workforce for these emerging industries is estimated to reach 20,000 employees, along with an additional 30,000 workers for associated services. This cumulative effect is expected to increase the region's population by approximately 100,000, leading to a 20% growth in the region's population (Smart City Sweden 2023).

In 2015, the United Nations (UN) introduced the Sustainable Development Goals (SDGs) to stimulate action over the next 15 years in areas of critical importance according to its "shared blueprint for peace and prosperity for people and the planet, now and into the future" (UN 2015a, b). Energy is considered the cornerstone of sustainable development (ESCAP 2023); hence, it can also interfere with other sustainability goals (UN 2002). Local authorities play a crucial role in the green transition, being responsible for developing and maintaining economic, social and environmental infrastructure as well as appropriate planning and policymaking. Therefore, their active involvement is essential for accelerating sustainable development at local level (UNCED 1992; Graute 2016). Combining new green industries with existing energy systems creates social and environmental sustainability challenges for local government, particularly considering the complexity of such systems and the interconnectedness of the SDGs (Fuso Nerini et al. 2019). In northern Sweden, for instance, electrification plays a major role in the green energy transition: the location of new green industries is driven by cheap electricity prices (Node Pole 2022), access to renewable energy, reliable power grids, abundant land, and a stable political system (Garbis et al. 2023).

Several studies have explored SDG implementation in cities, addressing sustainable green transition frameworks, governance conditions and policies for achieving

sustainability. Cases in point include Kutty et al. (2020), who developed a conceptual model that captures multifaceted interactions of policy, technology, and societal factors to guide the green transition to smart sustainable cities. Viale Pereira and Schuch de Azambuja (2022) developed a research-based road map and practical guidelines for building smart sustainable city initiatives. Giuliadori et al. (2023) examined the trade-offs among the economic, social and environmental dimensions of sustainability in cities, proposing smart governance as a crucial factor in smart sustainable cities. Liu et al. (2023) used open-source big data analysis to assess SDG progress in cities, highlighting the utility of big data in tracking SDG performance. However, the literature reveals a gap in addressing local green transitions. This research gap underscores the need for new methods that are driven by societal needs. Such methods could dictate the outcomes and objectives of the local energy system, for example, while shaping the direction and priorities of the local green energy transition.

Numerous other studies highlight the necessity of a holistic perspective to understand the complex and interconnected nature of sustainability and the SDGs (Cuello Nieto 1997; Barrett and Grizzle 1998; Nilsson et al. 2016; Stafford-Smith et al. 2017). The current study aligns with this idea by adopting an applied system analysis approach to gain a holistic perspective, while identifying the challenges local governments face in implementing relevant SDGs at local level. The current study uses an energy systems optimisation model (ESOM) based on The Integrated MARKAL-EFOM System (TIMES) model generator (Loulou et al. 2016). The ESOM considers a range of factors, including energy resource potentials, demand patterns, and economic and environmental issues, which are employed to systematically represent the given municipality's current energy system and its potential to change. To assess the sustainability of different energy transition scenarios, the study introduces a set of sustainability indicators to quantitatively compare sustainability across those scenarios.

The remainder of this paper is organised as follows: Sect. 2 offers an overview of the local context, while Sect. 3 describes methods applied. Section 4 explores SDGs relevant for local energy transition and proposes a set of sustainability indicators. In Sect. 5, the ESOM and scenarios defined are introduced. Section 6 discusses the model results, after which Sect. 7 concludes the paper.

2 Local Context: The Case of the Municipalities in Northern Sweden

The municipalities of northern Sweden are at the forefront of a global green transition being driven by the area's wealth of natural resources. These include energy, ore, forests and water, in addition to surplus clean electricity and a power grid with ample capacity. The municipalities of Gällivare and Kiruna are home to some of the largest iron mines in Europe (operated by state-owned mining company

LKAB). Iron pellets are transported to Narvik or Luleå (municipalities in northern Norway and Sweden, respectively), where they are either shipped out or refined further. A green industry will now refine the pellets locally at a plant using the new Hydrogen Breakthrough Ironmaking Technology (HYBRIT). The method entails employing green hydrogen produced from renewable electricity as a primary energy source, thus replacing blast furnaces both in Sweden and Norway. Another fossil-fuel-free steel production plant (H2 Green Steel) is being established in the Municipality of Boden. Furthermore, the Luleå Municipality is home to both traditional industries, such as steel production (global steel company SSAB, which uses blast furnaces) and manufacturing (global truck and bus manufacturers Scania), and modern ventures such as the Facebook Luleå Data Center (*Facebook's* first outside the USA). Other new green industries being established in Luleå include phosphorus and rare earth refinement (by LKAB) and green ammonia and fertiliser production (by Fertiberia). In addition, the Skellefteå Municipality is home to a copper smelting plant (Boliden Rönnskär, a world leader in recycling electronics) and a new gigafactory producing electric vehicle (EV) batteries, amongst others (Northvolt).

The green transition represented by these industries entails a significant increase in electricity supply and the installation of new power lines. Among several municipal energy companies that have taken the lead in this regard is Skellefteå Kraft, the fifth largest electricity producer in Sweden with an almost 100% renewable energy portfolio, and Luleå Energi. Luleå Energi is introducing innovative methods to identify and avoid users overstating their capacity needs. The green transition also demands that new infrastructure such as housing and roads be developed. In addition, more professionals for essential public services such as healthcare, education, police, social services and public transportation need to be recruited.

This study focuses on the Gällivare municipality, which has two hydropower plants and a wind power plant supplying and exporting electricity. A biomass-based combined heat and power (CHP) plant is the primary district heating source. Industrial electricity demand constitutes most consumption, followed by the transportation and residential sectors. Gällivare has also been chosen as the location for establishing HYBRIT, due to the municipality's proximity to iron ore mines locally as well as in Kiruna. Furthermore, expansion of these mines has brought significant changes to Gällivare and Kiruna, including moving, constructing and demolishing houses and other buildings, which has resulted in a high share of fly-in-fly-out work culture. These factors are expected to significantly impact Gällivare's energy system by way of increasing the demand for energy-intensive services and goods. Finally, Gällivare is also home to a significant Sami population and their cultural heritage. Their presence is integral to the municipality's diverse socio-economic and political landscape. Thus, the municipality is taking strong efforts to ensure Gällivare is socially sustainable too.

3 The Methodological Framework: From Modelling to Policy Implications

An applied system analysis approach can enhance the understanding of energy transition and support decision-makers as they navigate through it (Krook-Riekkola 2015). The approach employed here, namely the system analysis approach using ESOM, can be described as a four-step process, as depicted in Fig. 1. Step 1 entails simplifying and conceptualising the ‘real system’ (current system as well as potential future systems) into a model. This step includes making assumptions about the future and deciding what to vary between scenarios. In Step 2, all assumptions are organised into a mathematical model and the corresponding algorithms are solved. Step 3 involves interpreting the model results and drawing conclusions about the energy future for which to aim—preferably by working together with governments, citizens and other stakeholders. Finally, Step 4 identifies the actions and policies that are needed today to ensure the development of a sustainable energy system in the future.

The evolution of the energy system depends on dynamic factors, including energy service demands, external trends, and local actions. Consequently, the trajectory of the local energy system is influenced by the needs of municipal citizens and companies, national and international activities, and actions taken by local governments. The ESOM approach offers a holistic and comprehensive means of identifying and assessing the potential energy transition pathways of the local energy system in focus.

In this study, the aim was to support a local municipal body (in our case Gällivare) in its transition to a sustainable energy system in compliance with relevant SDGs. Such an energy system is not an isolated entity: it is highly integrated with meeting other sustainability targets. Thus, the sustainability targets being aimed for will influence the choice of energy to be considered to achieve them. Similarly, the kind of energy system to be developed will determine what sustainability targets can be achieved. Understanding these connections is essential, as SDG7 (on energy) on

Fig. 1 System analysis approach using energy system modelling (Krook-Riekkola 2015)

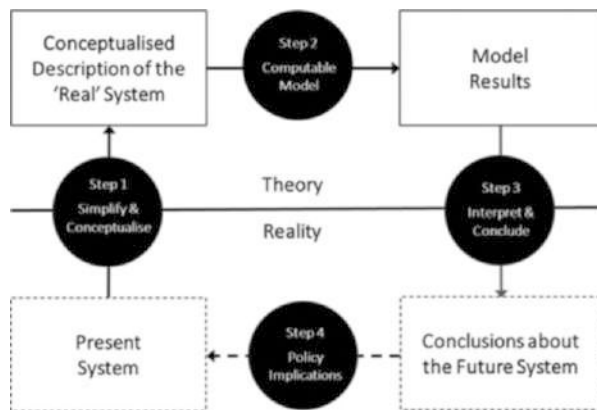

the energy system is influenced by other SDGs and, in turn, defines the conditions for achieving them. It is, therefore, imperative to understand and consider the impacts of each SDG when one assesses Gällivare's energy transition—and an ESOM is perfectly suited for such an assessment.

The studied transition is also driven by our societal needs, which dictate the outcomes of the energy system and determine the direction of its green transition. To effectively assess these connections, the following steps are proposed, grounded in a system analysis approach:

- Identify SDG targets and indicators relevant for the energy transition of northern municipalities;
- Apply an ESOM to develop energy transition pathways;
- Evaluate the sustainability of each pathway using identified indicators.

3.1 Identify SDG Targets and Indicators Relevant for the Energy Transition of Northern Municipalities

SDGs and their associated political declaration emphasise the importance of national interpretations, wherein each country is expected to establish its own goals, targets, and priorities for implementing SDGs based on their specific national conditions and capacities (Weitz et al. 2015). However, it is important to recognise that not all of these national interpretations may directly apply to every local government; hence, a process of localisation is necessary to tailor SDGs to fit the local realities of each specific region or municipality (Croese et al. 2021). Some Swedish municipalities' official websites explicitly mention their prioritised SDGs, while others detail sustainability measures such as recycling and waste management. However, references to SDGs differ across such websites, and a few do not mention SDGs at all. Additionally, local-level information may not always be available. Hence, to ensure a unified and coherent approach, the study begins by identifying Sweden's nationally relevant SDG targets and assessing their relevance to the municipalities in focus and to energy transition per se, before identifying their existing—or defining their new—corresponding indicators.

3.2 Apply an ESOM to Develop Energy Transition Pathways

An ESOM is employed to represent potential future options for the energy system in focus. Different scenarios are defined in the ESOM, while energy transition pathways for the municipality concerned are obtained from the model run of these scenarios. Each pathway illustrates how the energy system in question could evolve to meet future energy service demands while operating within the constraints of defined measures, targets, and prevailing trends. Scenarios are defined by varying

key parameters and/or targets over which the municipality has control, such as climate targets, air pollution reduction objectives, or the strategic integration of renewable energy sources. In this study, various scenarios were defined based on discussions with the Gällivare municipality.

3.3 Evaluate the Sustainability of Each Pathway Using Identified Indicators

Finally, model results are analysed and interpreted with respect to the sustainability of each defined scenario. A defined set of indicators is then used to make a quantitative comparison across scenarios to evaluate the sustainability of each pathway. The data visualisation method known as *heatmap* is used to illustrate how each scenario performs. The heatmap accomplishes this by representing the magnitude of the indicators' quantitative values as a colour showing the level of sustainability, allowing for a comparative assessment of such variation across different scenarios.

4 Identify SDG Targets and Indicators Relevant to an Energy Transition by Northern Municipalities

The SDG targets and indicators relevant to an energy transition by Sweden's northern municipalities (NMs) were identified by progressing through three phases (Table 1). The table also shows the outcome of each phase of identification.

Phase 1 Start by considering globally recognised SDGs and their corresponding targets (UN 2015a). At this initial stage, details regarding indicators were not considered. Subsequently, all SDGs and their corresponding targets relevant to Sweden were identified, utilising sources such as the Organisation for Economic Co-operation and Development Library (OECD 2022a), which provided insights

Table 1 Identified number of SDGs, targets and indicators of relevance for different scopes

Phase of identification	Nature of relevance of SDG	SDGs identified	Targets identified	Indicators identified
Phase 1	Global relevance (defined by UN)	17	169	231
	Relevant to Sweden	17	74	109
Phase 2	Relevant to energy transition in Sweden	17	70	104
	Relevant to energy transition in NMs	15	39	57
Phase 3	Suitable for inclusion in ESOM scenario analysis (values in brackets indicates ones included in model + ones discussed with NMs)	11 (6 + 5)	19 (9 + 10)	6 (6 + 0)

into Sweden's progress towards achieving these SDG targets, and Statistics Sweden (2023a), which offered data on indicators included in the national reports. In instances where data was lacking, published literature on Sweden's performance in respect of its sustainable practices was used (e.g. Anselmi et al. 2023; Weitz et al. 2015). Once the sources had been considered, data from the OECD Library was prioritised as data from Statistics Sweden lacked comprehensive information on certain targets and did not provide a clear status of target attainment.

Phase 2 In this phase, each target identified in Phase 1 was examined to identify its connection, if any, to the energy transition. Published literature exploring interlinkages between SDGs and energy was employed for this. For example, the analysis primarily draws on the work of Fuso Nerini et al. (2018), who mapped synergies and trade-offs between energy and SDGs. To augment the credibility of findings, additional scholarly works were also consulted. These included McCollum et al. (2018), who examined interlinkages between SDGs and energy; Aboul-Atta and Rashed (2021), who analysed the relationship between sustainable development indicators and renewable energy consumption; and Gjorgievski et al. (2022), who quantified synergies and trade-offs between national climate actions and SDGs. SDGs that were relevant to the energy system of the municipalities in focus were then identified, taking the local context into account.

Phase 3 This phase aimed to understand the UN indicators defined for the chosen SDG targets, and tried to match or identify corresponding indicators within the energy system model. In certain instances, UN indicators aligned with model parameters, enabling direct assessments. In cases where the UN indicators did not match the model parameters, new indicators were defined. In some other cases, due to model scope and/or a lack of contextual data, it was not possible to define suitable indicators. In these instances, model results were used in combination with discussion topics to gain insights. This was carried out outside the model (Step 3 in Fig. 1) and involved discussions with municipality representatives to identify key measures that were vital for the identified sustainable energy transition (Step 4 in Fig. 1). Such measures included investments in infrastructure and/or measures that altered energy prices and investment costs to favour critical technologies or actions.

Table 2 presents an inventory on how to integrate each SDG when assessing energy transition scenarios in municipalities of northern Sweden. The following SDGs were excluded from the inventory because their association with energy in the case study was limited:

- SDG3 (on good health): Air pollution is estimated to cause 6700 premature deaths in Sweden yearly, along with chronic respiratory diseases (IVL 2022). Air pollution is directly linked to energy conversion and use (IEA 2016). But this is integrated into SDG11 (on cities).
- SDG4 (on education): In Sweden, the proportion of people achieving higher education is higher in metropolitan municipalities compared to smaller municipalities like GÅL (OECD 2022b; Statistics Sweden 2023b). Sweden has universal electricity access (World Bank 2021), making energy access concerns irrelevant to this study, despite its impact on educational attainment.

Table 2 Mapping the relevance of SDG targets and indicators for assessing the energy transition in focus

SDG	National and regional/local relevance of SDG targets (T) for Sweden, with a focus on its northern municipalities (NMs) and Gällivare (GÅL)	When to address relevant target(s) in model-based analysis*	Defined result indicators for measuring SDG progress and/or topics to discuss with GÅL
SDG1 (no poverty)	<p>T1.3 Social protection system: This is generally comprehensive in Sweden (Statistics Sweden 2019: 25)</p> <p>T1.4 Equal rights to economic resources and access to basic services: These can be ensured by implementing social tariffs on energy services or measures to prevent disconnection from electricity and heating services (Dobbins et al. 2016), which are already in place in Sweden. Even though the target is considered achieved or is on track (OECD 2022a), access to capital for energy transition influencing purchase of EVs and energy efficiency improvements in houses is relevant</p>	T1.4: While interpreting and discussing the results (Step 3)	T1.4 Discussion topic: To enhance a just energy transition, where citizens are not left behind, discuss the results with a view to addressing the impacts of high energy prices on low-income groups at risk, who are left with inefficient housing/vehicles due to their limited investment capacity for measures with high upfront costs (e.g. retrofitting of houses, EVs). Such measures are cost-efficient from a system perspective but require access to capital
SDG2 (zero hunger)	<p><i>Agriculture in northern Sweden is practised for fewer days a year owing to its relatively colder climate in relation to the rest of the country (Jordbruksverket 2023)</i></p> <p>T2.3 Small-scale food producers and livelihood of indigenous people: NMs have indigenous Sami populations practising traditional reindeer herding. Their pastures are being affected by</p>	T2.3 & T2.4: When defining scenarios (Step 1) and/or while discussing the results (Step 3)	T2.3 & T2.4 Discussion topic: Discuss the results with respect to potential competition between energy and reindeer husbandry and/or local food production. Support the discussion with the model results (such as installed capacity of wind power, solar parks and thermal power plants) as well as insights from increased electricity use/demand

(continued)

Table 2 (continued)

SDG	National and regional/local relevance of SDG targets (T) for Sweden, with a focus on its northern municipalities (NMs) and Gällivare (GÄL)	When to address relevant target(s) in model-based analysis*	Defined result indicators for measuring SDG progress and/or topics to discuss with GÄL
	<p>climate change (Johnsen et al. 2023) and by alternative land use that includes wind farms and mining activities (Österlin and Raitio 2020). Tsegaye et al. (2017) demonstrate that, through careful planning, reindeer husbandry and wind energy development can coexist with minimal effects on reindeer spatial use. Thus, there is no competition between energy and reindeer husbandry per se, but the risk of such conflict emerging needs consideration</p> <p>T2.4 Ensure sustainable food production systems: IRENA (2015) highlights the target's water–food–energy nexus by integrating the provision of electricity from carbon-neutral sources</p>		<p>which could potentially lead to the construction of new power grids</p>
SDG5 (gender equality)	<p>All targets: In Sweden, notable gender differences exist in choices of transportation (public transport, cars, biking, etc.), with women often selecting more sustainable options. Including gender perspectives are therefore also important for evaluating effective measures in the sector (Swedish Public Transport 2022:26)</p>	<p>All targets: While considering which scenarios to apply (Step 1) and while discussing the results (Step 3)</p>	<p>All targets –discussion topic: Discuss and understand the features of public transportation in sparsely populated areas (such as deploying smaller busses and on demand) and then define scenarios including mode shift to public transport. Discuss regarding the ancillary benefits for SDG5 in respect of having good public transportation</p>

(continued)

Table 2 (continued)

SDG	National and regional/local relevance of SDG targets (T) for Sweden, with a focus on its northern municipalities (NMs) and Gällivare (GÄL)	When to address relevant target(s) in model-based analysis*	Defined result indicators for measuring SDG progress and/or topics to discuss with GÄL
			while evaluating the cost of having public transportation
SDG7 (affordable and clean energy)	<p>T7.1 Access to affordable, reliable and modern energy services: In Sweden, this has usually been taken for granted. However, price hikes over the past few years in Sweden and the EU have made it a topic again</p> <p>T7.2 Substantially increased share of renewable energy: This currently already comprises 75% of final energy consumption in Sweden and 70–80% in NMs (Swedish Energy Agency 2022)</p> <p>T7.3 Energy efficiency: This is generally high in Sweden (IEA 2024) but can still be improved to ease the energy transition</p>	T7.1–3: While extracting the model results (Step 2)	<p>T7.1–3 Discussion topic: Discuss the following result indicators and their implications:</p> <p>T7.1.1 Result indicator: Marginal cost of electricity and district heating</p> <p>T7.2.1 Result indicator</p> <p>T7.2.1: Renewable energy share in total final energy consumption</p> <p>17.3.1** Result indicator: Distance to the EU target for primary energy and final energy consumption</p>
SDG8 (decent work and economic growth)	<p>T8.1 Sustain per capita economic growth: New green industries are being established, which are securing economic growth</p> <p>T8.2 Raise economic productivity: Even though industrial innovation and diversification are of concern for GÄL as its economy is based on a few large industries, this target is considered less significant for the energy transition and it therefore excluded from the study</p>	<p>T8.1: While discussing the results (Step 3)</p> <p>T8.4: While extracting the model results (Step 2)</p>	<p>T8.1 Discussion topic: The impacts of new green establishments on future energy needs</p> <p>T8.4 Result indicator: The material footprint associated with energy transition (see SDG12 on responsible production and consumption)</p>

(continued)

Table 2 (continued)

SDG	National and regional/local relevance of SDG targets (T) for Sweden, with a focus on its northern municipalities (NMs) and Gällivare (GÄL)	When to address relevant target(s) in model-based analysis*	Defined result indicators for measuring SDG progress and/or topics to discuss with GÄL
	<p>T8.3 Promote development-oriented policies: Government Offices of Sweden (2021) state that this target has been achieved</p> <p>T8.4 Global resource efficiency: The material footprint of new industrial establishments is important to consider as many of them rely on resource extraction, yet less significant for the energy transition as this target pertains to the material life cycle and not to energy use perse</p>		
SDG9 (industry, innovation and infrastructure)	<p>All targets: These are highly relevant for NMs considering their current industrial transition and as they welcome entrepreneurs and support new businesses. New establishments lead to increased and diversified energy demands, driven by both infrastructural needs and the influx of people</p>	<p>All targets: While estimating the demand projections (Step 1)</p>	<p>All targets—discussion topic: Discuss the various scenarios with new establishments in NMs, assessing their implications for energy demand, incoming residents, and lifestyle influences (impacting the future need for household electricity, heating and transportation)</p>
SDG10 (reduced inequalities)	<p><i>With the influx of immigrants coming to work with green establishments, their integration and resettlement as well as the management of their cultural diversity are important to consider (Koopmans 2010). Additionally, it is vital to incorporate diverse stakeholder perspectives to ensure that the green</i></p>	<p>T10.2, T10.3 & T10.7: While estimating the demand projections and defining scenarios (Step 1)</p>	<p>T10.2, T10.3 & T10.7 Discussion topic: Introduce the three specified targets to NMs to consider (i) how societal needs evolve (heating houses, transportation, etc.) and (ii) the opportunities for energy communities</p>

(continued)

Table 2 (continued)

SDG	National and regional/local relevance of SDG targets (T) for Sweden, with a focus on its northern municipalities (NMs) and Gällivare (GÄL)	When to address relevant target(s) in model-based analysis*	Defined result indicators for measuring SDG progress and/or topics to discuss with GÄL
	<p><i>transition accommodates the needs and concerns of all individuals and communities. This also includes the energy transition</i></p> <p>T10.2 Social, economic and political inclusion: Relevant to NMs</p> <p>T10.3 Equal opportunity and reduce inequalities of outcome: Relevant to NMs</p> <p>T10.7 Facilitate orderly, safe, regular and responsible migration and mobility of people: Relevant to NMs</p>		
SDG11 (sustainable cities and communities)	<p>T11.1 Adequate, safe and affordable housing and basic services: The population of northern Sweden and the resultant demand for housing are increasing rapidly (Norran 2023). The construction of cheaper, temporary houses with low-energy building standards is therefore being discussed. However, these constructions will result in significantly higher energy demands during the long and cold winters—making it more challenging to meet T11.1, without low energy costs</p> <p>T11.3 Enhance inclusive and sustainable urbanisation and capacity: This could be interpreted as</p>	<p>T11.1: While extracting (Step 2) and discussing the results (Step 3)</p> <p>T11.3: While communicating the results and making them understandable to citizens (Step 3)</p> <p>T11.6: (see SDG3 on good health)</p>	<p>T11.1 Discussion topic: Discuss scenarios results with different building codes to assess the impact of houses with different energy performance (energy efficiency).</p> <p>T11.1 Result indicator: Marginal cost of space heating, electricity and district heating, other end use services</p> <p>T11.3 Discussion topic: Broadening the accessibility of the analysis to a wider audience</p>

(continued)

Table 2 (continued)

SDG	National and regional/local relevance of SDG targets (T) for Sweden, with a focus on its northern municipalities (NMs) and Gällivare (GÄL)	When to address relevant target(s) in model-based analysis*	Defined result indicators for measuring SDG progress and/or topics to discuss with GÄL
	emphasising the importance of an inclusive energy transition, i.e. involving citizens in deciding which path to take. To achieve this inclusive approach, it is critical that citizens are informed about the consequences of the different pathways T11.6 Air quality: (see SDG3 on good health)		
SDG12 (responsible consumption and production)	All targets: Although these are difficult to measure quantitatively due to the cross-cutting nature of available resources and their extraction, production, and consumption (Chan et al. 2018), the International Energy Agency highlights the importance of evaluating the material footprint within energy transitions	T12.2: While defining Technology parameters by including material footprint (Step 1) and analysing the result (Step 2)	T12.2 Result indicator: At present, material footprint in terms of critical material requirement per vehicle is used. This does not impact the optimisation but can be extracted as a result indicator
SDG13 (climate action)	T13.2 Integrate climate change measures into national policies, strategies and planning: Sweden has a net zero GHG emissions goal for 2045	T13.2: While defining scenarios (Step 1) and extracting results (Step 2)	T13.2 Discussion topic: Key measures to achieve the assessed climate targets and which alternative climate targets to analyse. T13.2 Result indicators: Annual GHG emissions in total and per sector
SDG15 (life on land)	T15.1 Ecosystems: This topic is important but not easy to measure T15.2 Sustainable management of forests: Forestry in Sweden is	T15.2: While defining scenarios (Step 1) and/or while discussing results (Step 3)	T15.1 & T15.2 Discussion topic: Discuss the potential of forestry residues to be defined in scenarios (such as lower outtake)

(continued)

Table 2 (continued)

SDG	National and regional/local relevance of SDG targets (T) for Sweden, with a focus on its northern municipalities (NMs) and Gällivare (GÄL)	When to address relevant target(s) in model-based analysis*	Defined result indicators for measuring SDG progress and/or topics to discuss with GÄL
	mainly for material use (timber, pulp and paper), while the forestry residues and by-products (from these industries) are used for energy purposes. Biomass accounts for around 30% of total energy supply (Swedish Energy Agency 2022). The outtake of forestry residues can impact biodiversity		T15.1 & T15.2 Discussion topic: Discuss regarding the biomass usage (such as whether its high or low)

*This either refers to the four-step system analysis approach described in Sect. 3 herein or indicates target of non-relevance

**The UN defines energy intensity as an indicator for T7.3, but both energy efficiency and intensity calculations come with flaws (US Department of Energy 2024). Since Sweden is an EU member, the study adopts the energy efficiency indicator defined by the European Commission (2024)

- SDG6 (on water): Energy use is currently not foreseen to compete with fresh water and thus is excluded from the study.
- SDG14 (on life below water): National indicators for Sweden show scope for improvement, while not related to energy use. SDG14 is also not relevant to landlocked regions like Gällivare.
- SDG16 (on peace, justice and strong institutions) and SDG17 (on partnerships) are important but beyond the scope of local energy transition.

5 Apply an ESOM to Develop Energy Transition Pathways

This section briefly introduces the ESOM and its application in scenario analysis, incorporating the chosen SDG indicators to develop energy transition pathways for NMs.

5.1 *Background to the Model*

This case study employs the TIMES-City-GAL model, an ESOM tailored to suit Gällivare's energy system based on TIMES-City. TIMES-City—developed within the Surecity (Sustainable and Resource Efficient Cities) project, hosts a modelling structure to support cities in achieving their sustainability targets (Pardo-García et al. 2019). The model includes two energy supply sectors (*ELC&DH* and supply) and six demand sectors (residential, commercial, municipal, transportation and industry) (Krook-Riekkola et al. 2018). *ELC&DH* sector includes existing and potential district heating and electricity production units. In the Supply sector, the potential import and export of electricity and other energy commodities are defined. Today, Gällivare is a major exporter of electricity (hydro, wind and a CHP plant connected to the district heating grid)—which may change with new green establishments. The model is given the opportunity to exchange electricity with the national power grid.

The model optimises net system cost to meet the given demand using available resources, technologies, and the given constraints. The time frame over which the model operates spans from 2018 to 2050, with each year being divided into 12 time-slices. Demand is seen as useful energy or as a useful energy service, e.g. persons-kilometre travelled in cars, or space heating in residential houses with A (best) to G (worst) energy efficiency gradings. Emission factors are defined either as tailpipe or upstream. *Tailpipe* emissions are those from energy use within the municipality; they are defined across the system from energy conversion and distribution to end use. *Upstream* emissions, on the other hand, are those derived from extracting, converting, and distributing energy outside the municipality. Tailpipe emissions are defined for three greenhouse gases (GHG), namely carbon dioxide, methane and nitrous oxide, in addition to five different air pollutants: nitrogen oxides, particulate matter (PM_{2.5}, PM₁₀), sulphur dioxide and volatile organic compounds. Upstream emissions are only defined for the GHGs.

When indicators were integrated into the model, some aligned directly with the model parameters, such as air pollutant emissions (SDG11 on cities) and share of renewables (SDG7 on energy). For indicators without direct model counterparts, new indicators were defined, such as energy efficiency (SDG7 on energy). In certain cases, additional analysis of model outputs was carried out due to the lack of model parameters. For example, the new investments were used to assess the material footprint for SDG12 (on responsible production and consumption). The model yielded investment figures for various vehicle types, including EVs and internal combustion engines. By applying an estimate of critical materials per vehicle, the net material footprint was obtained; this outcome enabled scenario comparisons even without precise figures.

5.2 Defining the Scenarios

Eight scenarios were defined to analyse the energy system transition as outlined in Table 3. The scenarios were developed by varying parameters (fuel prices) and three targets (Table 3). In these scenarios, high fuel prices were assumed to be 30% more elevated in comparison with low fuel prices for all fuels (gasoline, biofuels, etc.). The target for renewables in the Renewables Scenario was defined as the share of renewable energy in final energy consumption within the municipality in focus. Climate (all GHGs) and air pollutant (PM2.5, PM10) targets only included emissions related to energy use within the municipal border. For targets which were set to be achieved by 2045, it was assumed that progress to date would continue in the years to follow. In the case presented, factors such as population, energy technology choices, technology stock, and energy demand remained consistent across all scenarios, ensuring a standardised basis for comparison.

6 Evaluate the Sustainability of Each Pathway Using Identified Indicators

The sustainability of each of the eight pathways was assessed using the chosen result indicators. Table 4 shows the indicator values in different scenarios for the year 2050. The data in Table 4 was normalised for use in the heatmap in Fig. 2. Normalised values were identified based on the minimum and maximum values of indicators in different scenarios.

Table 3 Scenarios defined to analyse the energy transition

Scenario description (scenario name in brackets)	Fuel prices	Share of renewables in final energy consumption	Climate target (all GHGs)	Air pollutant target (PM2.5 and PM10)
No-target, low prices (NT-LP)	Low	No target	No target	No target
No-target, high prices (NT-HP)	High			
Renewables-scenario, low prices (RS-LP)	Low	100% by 2050	No target	No target
Renewables scenario, high prices (RS-HP)	High			
Climate scenario, low prices (CS-LP)	Low	No target	Net zero by 2045	No target
Climate scenario, high prices (CS-HP)	High			
Sustainability scenario, low prices (SS-LP)	Low	100% by 2050	Net zero by 2045	65% reduction by 2045
Sustainability scenario, high prices (SS-HP)	High			

Table 4 Indicator values and their corresponding units of measurement in eight different scenarios

Indicator	Unit	Type of scenario							
		NT-LP	NT-HP	RS-LP	RS-HP	CS-LP	CS-HP	SS-LP	SS-HP
Fossil energy share in total final energy consumption	Percentage	20	20	7	7	0	0	0	0
Fossil energy share in electricity supply	Percentage	0	0	0	0	0	0	0	0
Fossil energy share in transport sector (final energy consumption)	Percentage	98	98	31	31	0	0	0	0
Distance to energy efficiency target in transport sector	TJ*	65	65	9	9	–	–	–	–
Marginal cost—electricity	€'000/TJ	~0	~0	~0	~0	~0	~0	~0	~0
Marginal cost—travel (by car)	€'000/TJ	75.0	75.0	77.6	77.6	77.8	77.8	78.5	78.8
Material footprint—transport sector	t	17	17	17	17	19	19	19	19
Air pollutant emissions (PM2.5 + PM10)	kt	0.25	0.25	0.38	0.38	0.02	0.01	0.02	0.01
GHG emissions (all GHGs)	kt	33.7	33.7	11.1	11.1	0	0	0	0

*Negative values represent consumption below target

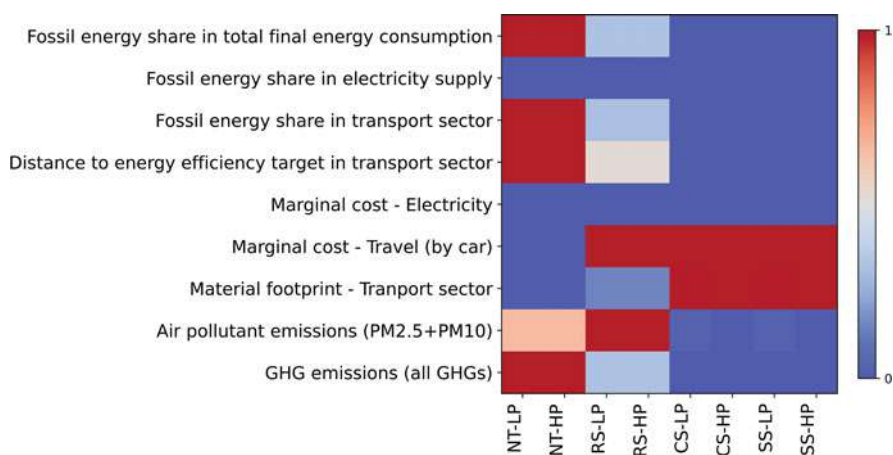

Fig. 2 Heatmap representing normalised values of SDG indicators (on the Y axis) across different scenarios (on the X axis) defined in the ESOM. *Note:* Shades of red indicate relatively less sustainability, while shades of blue denote relatively higher sustainability (Color figure online)

In all scenarios, regardless of fuel price fluctuations, the share of fossil energy in electricity supply remained constant. This result is explained by the fossil-free status of northern Sweden's electricity production. No-target Scenarios (NTs) uses cheap fossil fuels leading to low marginal cost of travel (by car) and increases air pollutant and GHG emissions. The indicator, distance to energy efficiency target identified for the transport sector, follows a similar pattern to that of fossil share, which implies lower energy savings (i.e. a greater distance to the target) with a higher fossil-fuel share. In the Renewables Scenarios (RSs), there is a clear shift towards renewable energy sources in pursuit of SDG7, which results in a reduced share of fossil-fuel energy and lower levels of GHG emissions. However, air pollutant emissions are significant, due to the choice of biofuels. The marginal cost of travel by car is high in NTs, owing to the increased biofuel cost.

Climate Scenarios (CSs) and Sustainability Scenarios (SSs) show similar trends across indicators. The CSs defined by climate action result in a reduction of air pollutants and an increased share of renewables—without explicit targets. Thus, the fulfilment of SDG13 (on climate) has reinforced the attainment of SDG7 (on energy) and SDG11 (on cities), showing synergies between the SDGs. Nonetheless, the material footprint (which does not account for reusing or recycling) in the transport sector increases notably in CSs and SSs, primarily due to a greater share of EV use. This shift toward EVs contributes to reduced emissions and an improvement in energy efficiency. The indicator, distance to energy efficiency in the transport sector shows higher energy savings with lower fossil share. However, the marginal cost of travel by car is also increased due to the upfront EVs cost as well as increased biofuels prices. Here, even though shifting to EVs reinforces goals regarding air pollution in, for example, SDG11 (on cities), SDG13 (on climate), and SDG7 (on energy efficiency), it slows down goals like SDG7 (on affordable energy) and SDG12 (on responsible production and consumption). These instances show the trade-offs and synergies between climate targets and SDGs and underscore the complexity and multifaceted nature of the studied energy transition and sustainability.

7 Conclusion

The study has illustrated the role of applying a model-based system analysis approach for integrating sustainable development principles into local energy transition. A data-driven comparative assessment was also done to examine whether the energy transition pathways converged or diverged from the SDGs. Insights derived from the analysis aligned closely with the study's aim of assessing sustainability across different energy transition pathways. A critical learning point was the identification and definition of sustainability indicators tailored to gauge progress across various energy transition pathways. When such indicators and pathways were illustrated in a heatmap, they offered valuable information that could be used in planning because the map allows stakeholders to easily identify and compare the

impacts of different energy scenarios. Furthermore, employing the system analysis approach enables the assessment of certain aspects of targets and indicators which are outside the model's scope. Cases in point are discussing the impact of high energy prices on low-income groups, or the potential competition of reindeer husbandry with other land uses. Overall, the entire analysis facilitates informed decision-making by highlighting key areas where interventions are needed and helps to strategise for a more sustainable energy future in alignment with both local and broader sustainable development perspectives.

The chosen indicators facilitated a detailed quantitative assessment, which allowed the discernment of not only the achievements, but also the challenges inherent in aligning with the UN SDGs. The study findings also specifically draw attention to the complex interplay between the pursuit of sustainability and the mechanisms of energy transition. The study further reveals that having 'tunnel vision' in respect of energy transition can lead to undesired impacts on the energy system. For instance, while the increased use of renewable energy supports urban sustainability (SDG11 on cities) and climate change mitigation (SDG13 on climate), it also raises concerns about energy affordability (SDG7 on energy) and material consumption (SDG12 on responsible production and consumption). These interdependencies which are evident from the heatmap underline the inherent trade-offs that must be managed.

The study highlights that achieving sustainable goals as well as a successful energy transition requires a holistic and integrated perspective. While the study focused on Gällivare, the method on how to identify and define (i) what to include and vary across scenarios, (ii) what to extract from the model results—and which result indicators to focus on, and (iii) what to discuss with the local government can be applied to other municipalities. Other local governments can adapt developed approach to their own contexts, energy profiles and specific challenges or goals to assess and guide their targets, measures and practices. In addition, the heatmap proves to be an effective tool for presenting and comparing result indicators. Notably, certain indicators and factors that were not prioritised for Gällivare due to regional specificity might hold relevance for areas elsewhere (e.g. water requirements for electricity generation and biofuel crop production with respect to SDG6 on water).

The TIMES-City modelling framework used in the study falls short by not including social issues during the assessment of SDG targets and energy transition capacities. The scope of the model could be broadened to encompass environmental factors such as land and water use within and outside the geographical scope, where required (SDG6 on water, SDG14 on life below water, and SDG15 on life on land), and to include material flows to look more closely at SDG8 (on economic growth) and SDG12 (on responsible production and consumption). The model, which currently focuses on energy flows within a defined geographical boundary, could also be expanded or merged with other models and methods. Models/Methods that enables a deeper analysis of social issues related to SDG1 (on poverty), SDG2 (on hunger), SDG5 (on gender equality), SDG8 (on economic growth), SDG9 (on industry and innovation) and SDG10 (on reduced inequalities).

Acknowledgements The authors wish to express their gratitude for the financial support received from the Swedish Energy Agency [grant number 46240-1] and the Formas Research Council [grant number 2019-01550].

References

- Aboul-Atta TA-L, Rashed RH (2021) Analyzing the relationship between sustainable development indicators and renewable energy consumption. *J Eng Appl Sci* 68(1) <https://doi.org/10.1186/s44147-021-00041-9>
- Anselmi D, D'Adamo I, Gastaldi M, Lombardi GV (2023) A comparison of economic, environmental and social performance of European countries: a sustainable development goal index. *Environ Dev Sustain*. <https://doi.org/10.1007/s10668-023-03496-3>
- Arctic Center of Energy (2023) Green Transition North accelerates the green transition through local collaboration. <https://arcticcenterofenergy.se/en/news-articles/green-transition-north/>. Accessed 18 Feb 2024
- Barrett CB, Grizzle RE (1998) A holistic approach to sustainability based on pluralistic stewardship. In: *Environmental ethics*, vol 21, Spring 1999. SSRN.: <https://ssrn.com/abstract=141232>
- Chan S, Weitz N, Persson Å, Trimmer C (2018) SDG12: responsible consumption and production. A review of research needs. Technical annex to the Formas report *Forskning för Agenda 2030: Översikt av forskningsbehov och vägar framåt*. Stockholm Environment Institute, Stockholm
- Croese S, Oloko M, Simon D, Valencia SC (2021) Bringing the global to the local: the challenges of multi-level governance for global policy implementation in Africa. *Int J Urban Sustainable Dev* 13(3):435–447. <https://doi.org/10.1080/19463138.2021.1958335>
- Cuello Nieto C (1997) Toward a holistic approach to the ideal of sustainability. *Soc Philos Technol Q Electron J* 2(2):79–83. <https://doi.org/10.5840/techne19972227>
- Dobbins A, Nerini FF, Pye S (2016) Measures to protect vulnerable consumers in the energy sector: an assessment of disconnection safeguards, social tariffs and financial transfers. <https://doi.org/10.13140/RG.2.2.22261.99041>
- Economic and Social Commission for Asia and the Pacific (ESCAP) (2023) *Energy*. <https://www.unescap.org/our-work/energy>. Accessed 18 Feb 2024
- European Commission (2024) *Energy efficiency targets*. https://energy.ec.europa.eu/topics/energy-efficiency/energy-efficiency-targets-directive-and-rules/energy-efficiency-targets_en. Accessed 18 Feb 2024
- Fuso Nerini F, Tomei J, To LS, Bisaga I, Parikh P, Black M, Borrión A, Spataru C, Castán Broto V, Anandarajah G, Milligan B, Mulugetta Y (2018) Mapping synergies and trade-offs between energy and the sustainable development goals. *Nat Energy* 3(1):10–15. <https://doi.org/10.1038/s41560-017-0036-5>
- Fuso Nerini F, Sovacool B, Hughes N, Cozzi L, Cosgrave E, Howells M, Tavoni M, Tomei J, Zerriffi H, Milligan B (2019) Connecting climate action with other sustainable development goals. *Nat Sustainability* 2(8):674–680. <https://doi.org/10.1038/s41893-019-0334-y>
- Garbis Z, McCarthy E, Orttung RW, Poelzer G, Shaiman M, Tafate J (2023) Governing the green economy in the Arctic. *Clim Chang* 176(4):33. <https://doi.org/10.1007/s10584-023-03506-3>
- Giuliodori A, Berrone P, Ricart JE (2023) Where smart meets sustainability: the role of smart governance in achieving the sustainable development goals in cities. *BRQ Bus Res Q* 26(1): 27–44. <https://doi.org/10.1177/23409444221091281>
- Gjorgievski VZ, Mihajloska E, Abazi A, Markovska N (2022) Sustainable Development Goals–Climate Action Nexus: quantification of synergies and trade-offs. *Clean Techn Environ Policy* 24(1):303–313. <https://doi.org/10.1007/s10098-021-02124-w>
- Government Offices of Sweden (2021) *Report on the implementation of the 2030 Agenda for Sustainable Development*. <https://www.government.se/reports/2021/06/voluntary-national-review-2021%2D%2Dsweden/>. Accessed 19 Feb 2024

- Graute U (2016) Local authorities acting globally for sustainable development. *Reg Stud* 50(11): 1931–1942. <https://doi.org/10.1080/00343404.2016.1161740>
- International Energy Agency (IEA) (2016) Energy and air pollution. <https://www.iea.org/reports/energy-and-air-pollution>. Accessed 18 Feb 2024
- International Energy Agency (IEA) (2024) Sweden: efficiency and demand. <https://www.iea.org/countries/sweden/efficiency-demand>. Accessed 14 Feb 2024
- International Renewable Energy Agency (IRENA) (2015) Renewable energy in the water, energy and food nexus. <https://www.irena.org/publications/2015/Jan/Renewable-Energy-in-the-Water-Energy%2D%2DFood-Nexus>. Accessed 18 Feb 2024
- IVL Swedish Environmental Research Institute (2022) Air pollution is estimated to cause 6,700 premature deaths in Sweden each year. <https://www.ivl.se/english/ivl/press/press-releases/2022-12-02-air-pollution-is-estimated-to-cause-6700-premature-deaths-in-sweden-each-year.html>. Accessed 18 Feb 2024
- Johnsen KI, Eira IMG, Mathiesen SD, Oskal A (2023) ‘Leaving no one behind’—sustainable development of Sámi reindeer husbandry in Norway. In: Mathiesen SD, Eira IMG, Turi EI, Oskal A, Pogodaev M, Tonkopeeva M (eds) *Reindeer husbandry: adaptation to the changing Arctic*, Springer polar sciences, vol 1. Springer, Cham. https://doi.org/10.1007/978-3-031-17625-8_3
- Jordbruksverket (2023) Arable land use by municipality, crop and year. https://statistik.sjv.se/PXWeb/pXweb/sv/Jordbruksverkets%20statistikdatabas/Jordbruksverkets%20statistikdatabas__Arealer__1%20Riket%20%c3%a4n%20kommun/JO0104B2.px/table/tableViewLayout1/?rxid=5adf4929-f548-4f27-9bc9-78e127837625. Accessed 14 Jul 2023
- Koopmans R (2010) Trade-offs between equality and difference: immigrant integration, multiculturalism and the welfare state in cross-national perspective. *J Ethn Migr Stud* 36(1):1–26. <https://doi.org/10.1080/13691830903250881>
- Krook-Riekkola A (2015) National energy system modelling for supporting energy and climate policy decision-making: the case of Sweden. PhD thesis, Chalmers University of Technology, Göteborg. <https://www.diva-portal.org/smash/get/diva2:990599/FULLTEXT01.pdf>. Accessed 18 Feb 2024
- Krook-Riekkola A, Unluturk B, Forsberg J, Simoes S, Dias L, Pardo Garcia N (2018) *SureCity Deliverable 3.1—outline of the City-level modelling framework*. Luleå University of Technology, Luleå
- Kutty AA, Abdella GM, Kucukvar M, Onat NC, Bulu M (2020) A system thinking approach for harmonizing smart and sustainable city initiatives with United Nations Sustainable Development Goals. *Sustain Dev* 28(5):1347–1365. <https://doi.org/10.1002/sd.2088>
- Liu Y, Huang B, Guo H, Liu J (2023) A big data approach to assess progress towards Sustainable Development Goals for cities of varying sizes. *Commun Earth Environ* 4(1):1–10. <https://doi.org/10.1038/s43247-023-00730-8>
- Loulou R, Goldstein G, Kanudia A, Lettila A, Remme U (2016) Documentation for the TIMES model: part I; International Energy Agency—Energy Technology Systems Analysis Programme. <https://iea-etsap.org/index.php/documentation>. Accessed 24 Mar 2019
- McCollum DL, Echeverri LG, Busch S, Pachauri S, Parkinson S, Rogelj J, Krey V, Minx JC, Nilsson M, Stevance A-S, Riahi K (2018) Connecting the sustainable development goals by their energy inter-linkages. *Environ Res Lett* 13(3):033006. <https://doi.org/10.1088/1748-9326/aaafe3>
- Nilsson M, Griggs D, Visbeck M (2016) Policy: map the interactions between sustainable development goals. *Nature* 534(7607):320–322. <https://doi.org/10.1038/534320a>
- Node Pole (2022) Swedish national DSO eyes \$1 billion investment in northern Sweden’s electricity grid. <https://www.nodepole.com/news-and-insights/swedish-national-dso-eyes-1-billion-investment-in-northern-swedens-electricity-grid>. Accessed 19 Feb 2024
- Nordic Cooperation (2023) Guide: work in northern Sweden. <https://www.norden.org/en/info-norden/guide-work-northern-sweden>. Accessed 19 Feb 2024

- Norran (2023) Northern Sweden's growth stunted by housing shortage. <https://norran.se/english/opinion/artikel/northern-swedens-growth-stunted-by-housing-shortage/lw3zgykj>. Accessed 12 Jul 2023
- Organisation for Economic Co-operation and Development (OECD) (2022a) The short and winding road to 2030: measuring distance to the SDG targets. OECD, Paris
- Organisation for Economic Co-operation and Development (OECD) (2022b) Education at a glance 2022: OECD indicators. OECD, Paris
- Österlin C, Raitio K (2020) Fragmented landscapes and planscapes—the double pressure of increasing natural resource exploitation on indigenous Sámi lands in northern Sweden. *Resources* 9(9):104. <https://doi.org/10.3390/resources9090104>
- Pardo-García N, Simoes SG, Dias L, Sandgren A, Suna D, Krook-Riekkola A (2019) Sustainable and resource efficient cities platform—SureCity holistic simulation and optimization for smart cities. *J Clean Prod* 215:701–711. <https://doi.org/10.1016/j.jclepro.2019.01.070>
- Smart City Sweden (2023) The green industrial revolution happens in northern Sweden. <https://smartcitysweden.com/the-green-industrial-revolution-happens-in-northern-sweden/>. Accessed 19 Feb 2024
- Stafford-Smith M, Griggs D, Gaffney O, Ullah F, Reyers B, Kanie N, Stigson B, Shrivastava P, Leach M, O'Connell D (2017) Integration: the key to implementing the Sustainable Development Goals. *Sustain Sci* 12(6):911–919. <https://doi.org/10.1007/s11625-016-0383-3>
- Statistics Sweden (2019) Implementation of the 2030 Agenda in Sweden—statistical review 2019. <https://www.scb.se/hitta-statistik/statistik-efter-amne/miljo/miljoekonomi-och-hallbar-utveckling/indikatorer-for-hallbar-utveckling/pong/publikationer/implementation-of-the-2030-agenda-in-sweden%2D%2D-statistical-review-2019/>. Accessed 19 Feb 2024
- Statistics Sweden (2023a) Agenda 2030. <https://www.scb.se/hitta-statistik/temaomraden/agenda-2030/>. Accessed 19 Feb 2024
- Statistics Sweden (2023b) Educational attainment of the population. <https://www.scb.se/en/finding-statistics/statistics-by-subject-area/education-and-research/education-of-the-population/educational-attainment-of-the-population/>. Accessed 19 Feb 2024
- Swedish Energy Agency (2022) An overview of energy in Sweden 2022 now available. <https://www.energimyndigheten.se/en/news/2022/an-overview-of-energy-in-sweden-2022-now-available/>. Accessed 19 Feb 2024
- Swedish Public Transport (2022) Kollektivtrafikbarometern. <https://www.svenskkollektivtrafik.se/verktyg-och-system/kollektivtrafikbarometern/>. Accessed 19 Feb 2024
- Tsegaye D, Colman JE, Eftestøl S, Flydal K, Røthe G, Rapp K (2017) Reindeer spatial use before, during and after construction of a wind farm. *Appl Anim Behav Sci* 195:103–111. <https://doi.org/10.1016/j.applanim.2017.05.023>
- United Nations (UN) (2002) Water, energy, health, agriculture and biodiversity: synthesis of the framework paper of the Working Group on WEHAB. <https://digitallibrary.un.org/record/472693?ln=en>. Accessed 19 Feb 2024
- United Nations (UN) (2015a) The 17 goals. <https://sdgs.un.org/goals>. Accessed 17 Feb 2024
- United Nations (UN) (2015b) Transforming our world: the 2030 Agenda for Sustainable Development. <https://sdgs.un.org/2030agenda>. Accessed 19 Feb 2024
- United Nations Conference on Environment and Development (UNCED) (1992) Agenda 21. <https://sustainabledevelopment.un.org/outcomedocuments/agenda21>. Accessed 19 Feb 2024
- US Department of Energy (2024) Energy efficiency vs energy intensity: strategic analysis. <https://www.energy.gov/eere/analysis/energy-efficiency-vs-energy-intensity>. Accessed 19 Feb 2024
- Viale Pereira G, Schuch de Azambuja L (2022) Smart sustainable city roadmap as a tool for addressing sustainability challenges and building governance capacity. *Sustain For* 14:239. <https://doi.org/10.3390/su14010239>
- Weitz N, Persson Å, Nilsson M, Tenggren S (2015) Sustainable Development Goals for Sweden: insights on setting a national agenda. SEI working paper no. 2015-10. <https://www.sei.org/publications/sustainable-development-goals-for-sweden-insights-on-setting-a-national-agenda/>. Accessed 19 Feb 2024
- World Bank (2021) World Bank open data. <https://data.worldbank.org>. Accessed 19 Feb 2024

Open Access This chapter is licensed under the terms of the Creative Commons Attribution 4.0 International License (<http://creativecommons.org/licenses/by/4.0/>), which permits use, sharing, adaptation, distribution and reproduction in any medium or format, as long as you give appropriate credit to the original author(s) and the source, provide a link to the Creative Commons license and indicate if changes were made.

The images or other third party material in this chapter are included in the chapter's Creative Commons license, unless indicated otherwise in a credit line to the material. If material is not included in the chapter's Creative Commons license and your intended use is not permitted by statutory regulation or exceeds the permitted use, you will need to obtain permission directly from the copyright holder.



Translating Research Results into Policy Insights to Underpin Climate Action in Ireland



Brian Ó Gallachóir, Paul Deane, and Fionn Rogan

Abstract This chapter presents innovative processes that have been developed and used to bridge the interface between the research ecosystem and policy-making ecosystem. It focuses on a specific case study, namely how energy systems modelling has been used to inform energy and climate mitigation policies in Ireland. We trace the development of energy systems modelling tools and capacity in Ireland over the past 15 years, and the key role it has played in addressing important policy questions related to delivery of a number of UN Sustainable Development Goals (SDGs). We also outline the parallel evolution of novel research communications methods, proactive engagement programmes with policy practitioners and co-production processes. Specific examples of energy and climate mitigation policies are highlighted to demonstrate how the research results have been used together with the communication and engagement methods not only to inform but also to underpin policy developments. The contributions of this work to the SDGs are highlighted, in particular SDG 13 on climate and SDG 7 on energy, but also SDG 12 on sustainable consumption and production and SDG 17 on partnerships. We conclude with a proposed seven stage approach, for energy modellers who wish to successfully bridge between the research and policy eco-systems, namely (1) undertake scientifically robust research, making methods and results openly and publicly available (2) frame research questions that respond to specific policy needs, (3) translate research results into policy insights (4) improve communications of research findings including through use of infographics (5) engage actively with policy

B. Ó Gallachóir (✉)

MaREI Centre, Sustainability Institute, University College Cork, Cork, Ireland

e-mail: b.gallachoir@ucc.ie

P. Deane · F. Rogan

MaREI Centre, Sustainability Institute, University College Cork, Cork, Ireland

School of Engineering and Architecture, University College Cork, Cork, Ireland

e-mail: jp.deane@ucc.ie; f.rogan@ucc.ie

© The Author(s) 2024

M. Labriet et al. (eds.), *Aligning the Energy Transition with the Sustainable Development Goals*, Lecture Notes in Energy 101,

https://doi.org/10.1007/978-3-031-58897-6_15

practitioners and policy makers (6) co-produce policy with policy practitioners and (7) build absorptive capacity in the policy system.

Key Messages

- Innovative processes, including co-production and building absorptive capacity, successfully bridged the interface between the energy research ecosystem and policy-making ecosystem.
- Energy systems modelling played a key role in advancing delivery of SDG 13 (climate), SDG 7 (energy), SDG 12 (sustainable consumption and production) and SDG 17 (partnerships) in Ireland.
- Transitioning from traditional energy modelling approach to co-producing policy is challenging but fulfilling.
- A seven stage approach is proposed for energy modellers who wish to successfully bridge between the research and policy eco-systems.

1 Introduction

Using research to inform, improve and influence policy decisions is not new. Although many academics have personal experience, or have attended impact training, there is a limited empirical evidence base to inform academics wishing to create impact (Olivier and Carney 2019).

The purpose of this chapter is to present a specific case study on research results which were translated into policy insights and how these insights were then used to underpin policy decisions. It draws on specific experiences over 15 years from Ireland, where University College Cork has established energy systems modelling capacity. From the outset, the team had a focus not only on developing models and undertaking future energy systems scenario analysis, but also on using the results and insights gained to directly influence Ireland's energy and climate policies. We make an important distinction between energy system *models*, which need to be continually updated, and energy system *modellers*, who need to continually reflect on the impact, usefulness and value of their research findings and insights. This chapter will describe how, over a 15 year period, the modellers experimented with and learned from a range of different research dissemination and engagement practices.

The methods section charts the development of the energy systems models, namely the TIMES Ireland Model that was developed in the period 2018–2023, and its predecessor the Irish TIMES model that was developed in the period 2008–2018. This section also discusses the scenario analyses undertaken, which connect the model capabilities with specific policy questions. Finally, this methods section also presents a number of approaches employed for translating research results into policy insights, in particular policy briefs, web portals and infographics.

The policies section highlights a number of specific energy and climate policies that have been informed, improved or influenced by the research and analyses undertaken, detailing which processes were used in each case and the lessons learned and challenges encountered. In most cases, the policies affected contribute to Sustainable Development Goal (SDG) 13: Take urgent action to combat climate change and its impacts and SDG 7: Ensure access to affordable, reliable, sustainable and modern energy for all. In some cases, the policies also contribute to SDG 12: Ensure sustainable consumption and production patterns and SDG 17: Strengthen the means of implementation and revitalize the global partnership for sustainable development.

The recommendations section provides guidance to energy modelling teams in other countries and institutions who wish to actively increase the evidence base for policy decisions but also ensure that the knowledge generated has the best opportunity to influence policy decisions. This contributes directly to SDG target 17.9 Enhance international support for implementing effective and targeted capacity-building in developing countries to support national plans to implement all the sustainable development goals.

2 Methods: From Energy Models to Communication Tools

The key methods developed and employed in this case study were the models developed, the scenarios analysed, and the communication tools employed.

2.1 TIMES Models

The Irish TIMES model and its successor the TIMES Ireland Model are both partial equilibrium models of Ireland's energy system, built using the TIMES model generator, a techno-economic modelling tool developed by International Energy Agency Energy Technology Systems Programme (IEA-ETSAP) (Chiodi et al. 2015a). TIMES models are currently used by approx. 200 energy systems modelling teams in 70 countries globally. TIMES is a linear programming model generator, which provides a technology-rich basis for estimating energy dynamics over a long-term, multiple-period time horizon. It is usually applied to the analysis of the entire energy sector of a country or a region, but may also be applied to study single sectors (e.g. the electricity sector) in detail. It maximises the total surplus, equivalent to minimising the total discounted energy system cost, over the entire time horizon while respecting environmental and many technical constraints.

There are clear limitations that need to be borne in mind when interpreting the results from TIMES models—most notably, these results are not attempts to forecast the future. The scenarios are based on different policy assumptions, and the results from one scenario are best interpreted by comparing them with the results from other

scenarios, rather than as absolute results. Regarding the absolute results, they clearly depend on the robustness of future projections of economic growth and fuel prices that drive the model. In addition, as the focus of this model is on technology choice, the representation of behavioural effects is currently represented in only a limited manner.

2.2 *Irish TIMES Model: 2008–2019*

The Irish TIMES model was a mono-regional model of the entire Irish energy system that was originally extracted from the Pan European TIMES (PET) model (Ó Gallachóir et al. 2012). It was updated and expanded by the Energy Policy and Modelling Group in University College Cork and used to build a range of energy and emissions policy scenarios to explore the dynamics behind the transition to low carbon energy systems (Chiodi et al. 2013a; Chiodi et al. 2013b) (i.e. contributing to SDG 13), to analyse energy security (Glynn et al. 2014, 2017) i.e. contributing to SDG 7, to assess impacts of limited bioenergy resources (Chiodi et al. 2015b; Czyrnek-Delêtre et al. 2016) i.e. contributing to SDG 12 and to explore interactions between the energy system and power system (Deane et al. 2012, 2015a, b), the energy system and the economy (Glynn et al. 2015) and the energy system and agriculture system (Chiodi et al. 2015c; Deane et al. 2016).

The core model contained a database of 1350 energy supply-side and demand-side technologies, which contained technical data (e.g. thermal efficiency, capacity), environmental data (e.g. emission coefficients) and economic data (e.g. capital costs) that varied over the entire time horizon (2005–2050). The exogenous model inputs were energy supply and energy service demands. On the supply side, these included indigenous energy resource availability, primary energy (mostly fuel) prices and available energy imports. On the demand side, separate energy service demand projections were derived and input from macro-economic projections of the economy to 2050.

The Irish TIMES model provided a range of future energy system configurations for Ireland that varied according to a range of policy constraints for the period out to 2050, but in each case delivering projected energy service demand requirements optimised to least cost. The *least cost optimisation* feature came to be one of the most valued features of the Irish TIMES model by Irish policy-makers. The Irish TIMES model provided a means of testing energy policy choices and scenarios, and assessing the implications for: (i) the Irish economy (technology choices, prices, output, etc.), (ii) Ireland's energy mix and energy dependence, and (iii) the environment, focusing mainly on greenhouse gas (GHG) emissions. It was used to both examine baseline projections, to assess the implications of emerging technologies, and of alternative policy choices, such as meeting renewable energy targets and carbon-mitigation strategies. The real value of the Irish TIMES model was in the insights (Ó Gallachóir et al. 2020a) it provided into some of the key challenges and

decisions facing Ireland in terms of energy and climate policy. More details about the particular insights, challenges and decisions are discussed later on in the chapter.

While many changes were made to the Irish TIMES model between 2008 and 2019, because some parts of the original model (e.g. the base year structure) were fixed and unchangeable, the UCC modelling team decided that the benefits of a more flexible and transparent model would justify the effort of building an entirely new TIMES model. This decision also coincided with the cessation of funding from Ireland's EPA for Irish TIMES and the commencement of funding for the development of a new TIMES model from that government agency's parent department, i.e. the Department of Communications, Climate Action and Environment.¹

2.3 *TIM (TIMES Ireland Model): 2019–2023*

The TIMES Ireland Model (TIM) is the successor model to the Irish TIMES Model and was developed to address specific limitations of Irish TIMES in informing updated and more ambitious near-term climate mitigation policy, in particular a government commitment to reduce greenhouse gases by an average of 7% yr. – 1 in the period to 2030 and a net-zero target for 2050, underpinned by a series of 5-year carbon budgets (Balyk et al. 2021). TIM also took advantage of new advances in energy systems optimisation modelling techniques and new data that enabled an increased temporal and geographic resolution relative to Irish TIMES.

Unlike in the Irish TIMES model, which had a fixed base year model structure, in TIM a special spatiotemporal approach was taken in the RES base year specification and scenario file data structures to allow flexible regional definitions and temporal resolution in TIM. This enabled TIM to run in multiple modes with multiple configurations of regional and temporal resolution, ranging from a single region national model at a single annual time slice, all the way to 26 counties at hourly resolution where supply–demand data are available at that spatiotemporal granularity (electricity, gas, and transport).

High temporal granularity is needed to appropriately model energy futures with high variable renewable energy systems integration, especially in scenarios with high levels of electrification of end-use demands. At the same time, high temporal granularity can be computationally expensive and can significantly increase the time required for model development and testing. This issue is addressed in TIM by constraining all time slice model input data to a single file generated with a specific temporal resolution. A time slice tool is used to aggregate raw time series data and create a file in the required format (Balyk 2022).

High spatial granularity is required to give greater policy clarity on optimal investment needs based on region- and county-specific characteristics to enable the counteraction of socioeconomic challenges such as energy poverty and

¹As of 2024, named Department of Environment, Climate and Communications

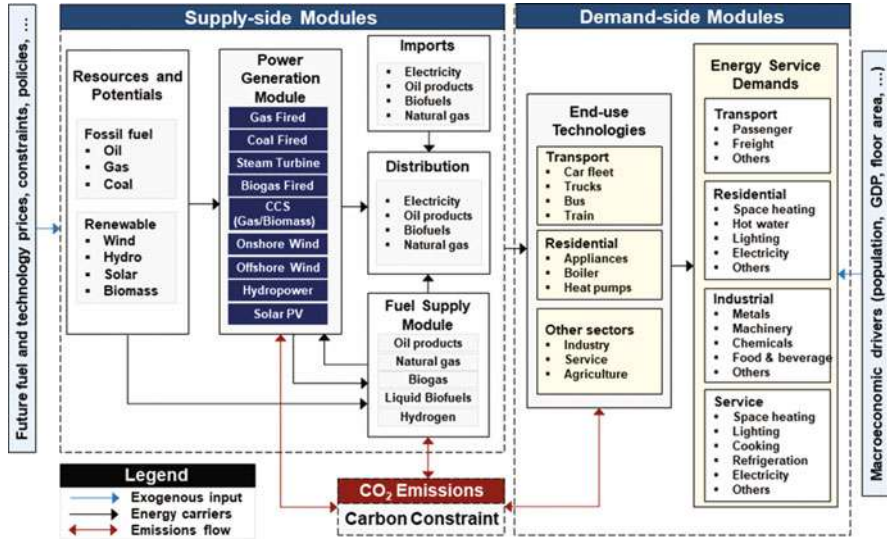

Fig. 1 Reference Energy System for TIM

infrastructure development within an optimisation framework (Aryanpur et al. 2019). This is addressed in TIM by creating model input data structures that allow specifying data and formulating constraints on both national and county levels. Internal file switches, and user shell options, can then be used to apply TIM on either of the levels. This was used for example in a specific high spatial resolution analysis focussing on transport decarbonisation (Aryanpur et al. 2022) and for a separate analysis in decarbonising residential energy use (McGuire et al. 2023).

Figure 1 shows a simplified Reference Energy System in TIM that describes the structure and energy flows including two major parts, i.e. the supply side and demand side. The former comprises energy resources, fuel production and conversion technologies (e.g. biorefineries, hydrogen production, and different power plants), transmission, and distribution infrastructure (e.g. gas pipelines and power grid). The latter covers end-use sectors (e.g. transport and residential) and the corresponding energy service demands (i.e. passenger, freight, and hot water). Energy resources incorporate both domestic fossil-based fuels and renewable resource potential. These fuels are processed and then distributed across the country. End-use technologies consume energy commodities to meet energy service demands. GHG emissions from fossil fuels combustion and process-related emissions in industry are tracked with the fuel supply module, electricity generation technologies, and sectoral consumption levels.

Energy service demands in end-use sectors are driven by growth in the population and in the economy. The model is set up to allow for alternative scenarios for these drivers, resulting in different energy service demand projections in the end-use sectors. For example, the impact of low energy demands was explicitly considered

in one scenario analysis and a complement to more typical supply side focussed studies (Gaur et al. 2022).

2.4 Scenario Analyses

The scenario analyses undertaken with the Irish TIMES and TIM models have always been carefully structured to respond to specific policy needs at the time of the analysis. As Ireland's climate mitigation policy evolved over time, new scenarios were built, and where necessary the models were further developed in order to inform the new policy questions and requirements that arose.

Ireland's key climate mitigation policy focus in 2013 was two-fold. The short term focus was to meet mandatory EU greenhouse gas emissions (GHG) targets to be achieved by the year 2020 for each EU Member State. These targets were for GHG emissions that fall outside of the EU Emission Trading Scheme and were specified in an EU Effort Sharing Agreement for non-ETS GHG emissions (EU 2009). In order to inform how Ireland might be able to meet this target, we built scenarios where we imposed separate emissions reduction targets for ETS and non-ETS related emissions and explored the energy technology systems pathways and associated costs to achieve Ireland's target to achieve a 20% reduction in non-ETS emissions by 2020 relative to 2005 levels (Chiodi et al. 2013b).

The long term Government policy focus in 2013 was to set a 2050 target for GHG emissions that aligned with the overall EU ambition for that time horizon. The European Union perspective was that industrialized countries should contribute to an overall 50% reduction in GHG emissions target by reducing GHG emissions by between 80% and 95% by the year 2050, relative to 1990 levels (European Council 2009). Against this context we built emissions reduction scenarios for Ireland focusing on a reduction in GHG emission of between 80% and 95% relative to 1990 levels and published the first ever long term energy scenario results for Ireland (Chiodi et al. 2013a).

There was a significant increase in climate ambition in Ireland in 2018/2019 in line with the growing ambition globally, and in the EU in particular, and also reflective of a changing political response nationally to climate change. This increase in ambition was both informed and underpinned by the scenario analysis we undertook and by how we translated the results into policy insights and engaged with the policy practitioners (i.e. civil servants) and policy makers (i.e. elected representatives). In this was we contributed directly to SDG target 13.2 namely *Integrate climate change measures into national policies, strategies and planning* and SDG target 17.14 *Enhance policy coherence for sustainable development*.

We also responded to the increase in ambition by building new scenarios (shown in Fig. 2) that fully stretched the capacity of the Irish TIMES model. These scenarios downscaled a number of global carbon budgets to Ireland and outlined different energy system pathways in line with different probabilities of achieving a 2 °C and 1.5 °C target. These represented the first deep decarbonization scenarios for Ireland

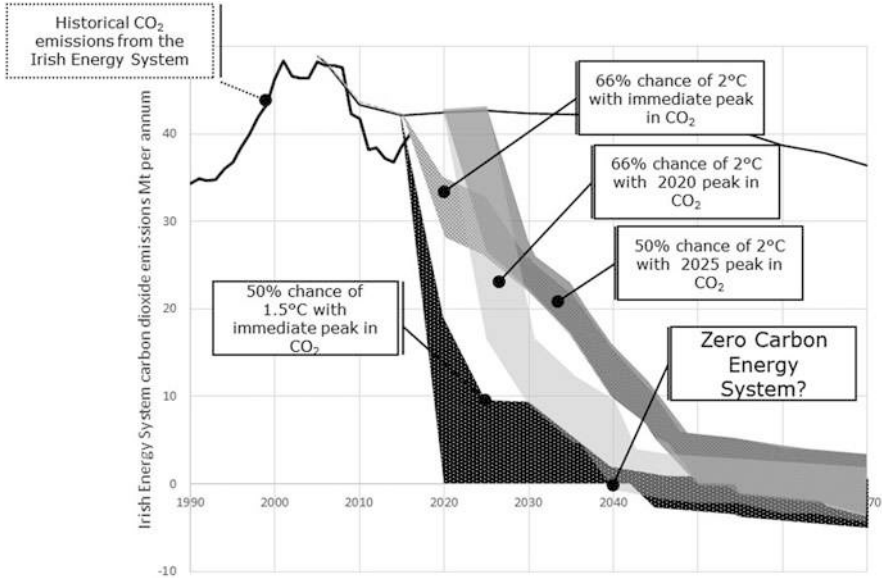

Fig. 2 Scenarios for deep decarbonization for Ireland based on equitable carbon budgets

that were consistent with the Paris Agreement and above current national EU mitigation targets using equitable carbon budgets (Glynn et al. 2019). These results showed that a net zero energy system for Ireland was technically feasible.

Ireland's Climate Action & Low Carbon Development (Amendment) Act 2021 established new targets for Ireland to reduce GHGs by 51% by 2030 relative to 2018 levels, and to achieve climate neutrality by 2050. Taking advantage of the model improvements in the TIMES Ireland Model, we developed a range of scenarios (Glynn et al. 2019) that combined both of these ambitions, and made a range of assumptions for what targets might be established for emissions reduction in agriculture (responsible for 34% of Ireland's GHG emissions).

Here the core scenario sets imposed different emissions reductions on CO₂ emissions depending on a range of pre-set possible (methane and nitrous oxide) emissions reductions imposed on the agriculture sector. The five core scenarios were:

- **A25E65:** 25% reductions from agriculture by 2030, 65% reductions from energy & industry
- **A33E61:** 33% reductions from agriculture by 2030, 61% reductions from energy & industry
- **A40E57:** 40% reductions from agriculture by 2030, 57% reductions from energy & industry
- **A51E51:** Equal mitigation, 51%, from agriculture and from energy & industry

- **A55E49**: 55% reductions from agriculture by 2030, 49% reductions from energy & industry

In addition to these core scenarios, a number of additional scenario variants were also included to take account of some key uncertainties. The variants were:

- **Early Action** where climate action is front-loaded via emissions constraints in the early years
- **Late Action** where delays are allowed to take advantage of declining costs
- **LED** where Low Energy Demand variants are achieved via amended energy service demands
- **Tech-Optimism** where faster RES, bioenergy / hydrogen imports and early CCS are assumed

2.5 *TIM Results Web APP*

In order to provide a bridge between the research ecosystem and policy-making ecosystem, University College Cork developed a web app in 2021 to share results with policy practitioners for the period 2021–2050 for a range of different scenarios that were modelled with the TIMES Ireland Model (TIM). The TIM Carbon Budgets 2021 Web App (Daly et al. 2021a) visualises most of the scenarios included in the github (Daly et al. 2021b) repository that contains these energy system scenarios for Ireland meeting decarbonisation targets for 2030 and 2050. Up to two scenarios can be selected for comparison and the difference can be computed. In addition to the scenario results visualisation, documentation in the TIM model and scenario descriptions are also available from the web app. The app has proved to be a very effective communication tool when discussing scenario results with policy makers and with other stakeholders (Fig. 3).

2.6 *Policy Briefs and Infographics*

As another bridging mechanism between science and policy, we explored a number of different ways to effectively translate research results into policy insights. The UK usefully defines a policy brief as a short document that summarises a project or key research findings and their policy implications (NCCPE 2023). When invited to present evidence to the Oireachtas (Irish Parliament) Committee on Climate Action in 2018 UCC (2018) prepared a policy brief and added it to the written and verbal testimony. In this policy brief we included a 1-page written summary of some key research findings and policy insights and accompanied the text-only 1-page summary with an infographic as presented in Fig. 4 to present which constituted headline messages (e.g. “The time to act is now”) and reinforcing imagery (designed by a graphic designer) to present the key findings in a more accessible manner.

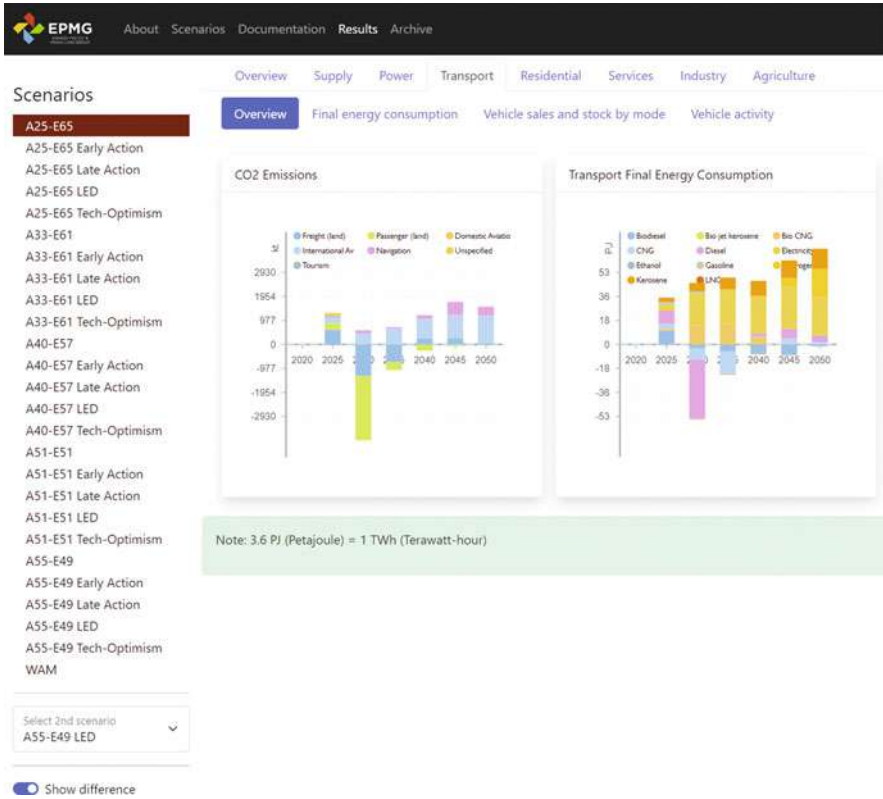

Fig. 3 Sample output from TIM Result Web App highlighting results differences for transport for two different scenarios, one with a 65% reduction in energy related CO₂ by 2030 and a second with a 49% reduction and also assumed low energy demand

The focus on this analysis and policy engagement was primarily on SDG target 13.2, namely *Integrating climate change measures into national policies, strategies and planning*, but also the parts of SDG target 13.3 relating improving institutional capacity on climate change mitigation in addition to Ireland's contribution to SDG target 7.2 increasing substantially the share of renewable energy in the global energy mix and SDG target 7.3, doubling the global rate of improvement in energy efficiency.

Other examples of policy briefs published in include one on Ireland's carbon budgets, highlighting their role as an important bridge between climate ambition and climate action (Ó Gallachóir 2021), insights on carbon capture and offsetting that was included in evidence to the Oireachtas (Parliament) Committee Pre-Legislative Scrutiny of the Climate Action and Low Carbon Development (Amendment) Bill 2020 (Glynn 2020).

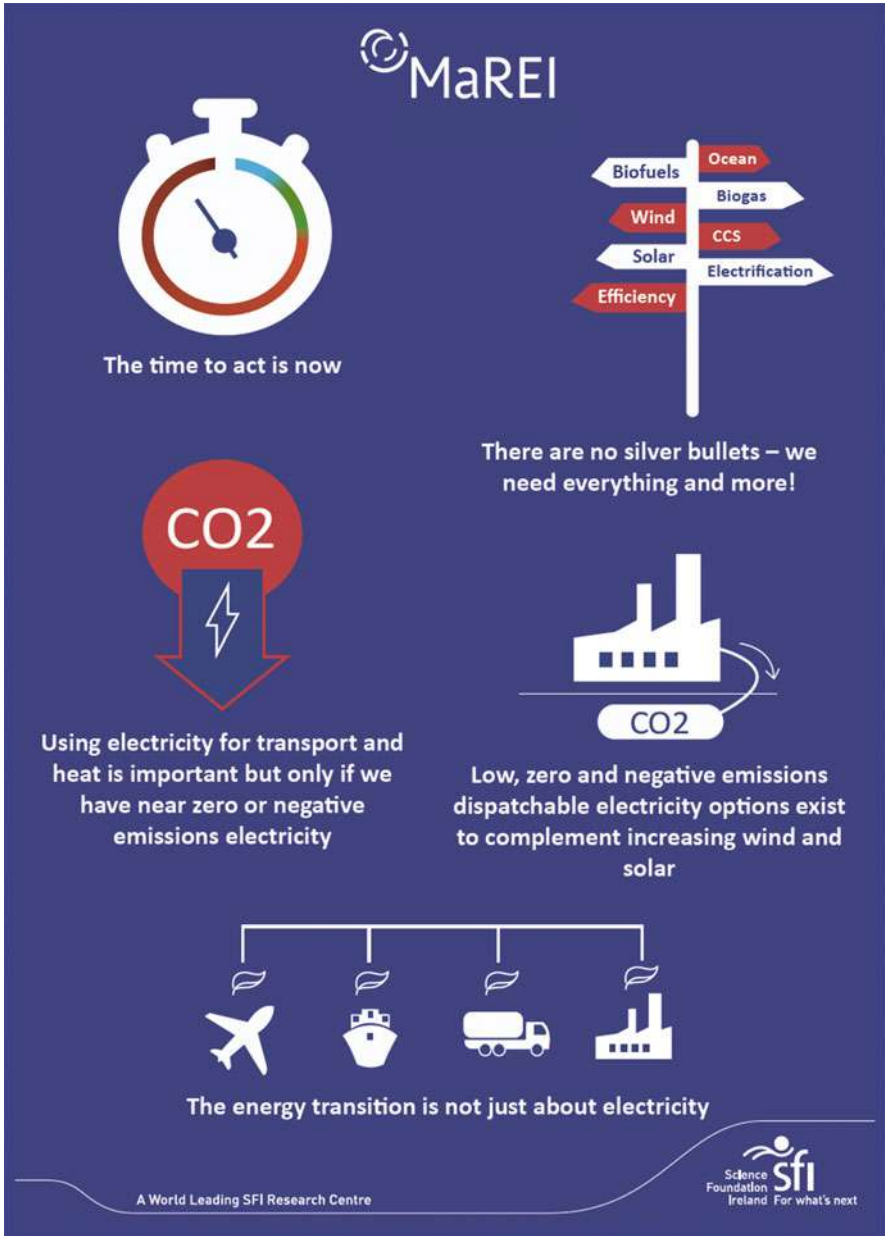

Fig. 4 Infographic as part of Policy brief to Oireachtas Committee translating research results into policy insights

These policy briefs have also been extended to include other areas of climate mitigation research, for example citizen engagement and dialogue (Ó Gallachóir et al. 2020b), contributing to SDG target 12.8 namely ensuring that people everywhere have the relevant information and awareness for sustainable development and lifestyles in harmony with nature.

Infographics can also be used separately from policy briefs. There is of course a danger that the information presented can be an oversimplification of the research results but it can be a very effective and accessible way of communicating. Figure 5 summarises insights relating to a 7% per annum reduction in GHG emissions in Ireland over the period 2021–2030 based on scenario analysis using the TIM model. The timing in 2020 was important as political parties in Ireland were trying to form a coalition Government after a general election and one of the red-line issues in the negotiations was a 7% reduction per annum in GHG emissions. We developed this infographic that accompanied a newspaper article (Daly et al. 2020) providing a text version of the same key insights from the scenario analysis. Given that this helped develop a cross-political party programme for Government, it contributes directly to SDG target 17.14, enhancing policy coherence for sustainable development.

3 Modelling to Inform Policy

Over the past ten years in Ireland there has been a significant increase in the amount of energy and climate mitigation policies introduced. National energy policies were infrequent prior to that and prompted by specific needs, for example in 1978 in response to the oil crises (Department of Industry Commerce and Energy 1978) and in 1999 when the first significant sustainable energy policy was developed (Department of Public Enterprise 1999).

3.1 2015: Climate Action and Low Carbon Development Act 2015

The Irish government was planning to legislate for climate action and low carbon development and published a Heads of Bill (General Scheme of a Climate Action and Low Carbon Development Bill) in 2013 (DECLG (Department of Environment, Community and Local Government) 2013). This raised key questions regarding the evolution of Ireland's future energy system to enable the transition to a low carbon future. The Irish TIMES model had the capacity to address these key questions.

In the period June–December 2013, the Department of the Environment, Community and Local Government commissioned UCC and the ESRI to produce a Low Carbon Energy Roadmap for Ireland to 2050 using the Irish TIMES model (Deane et al. 2013). This involved framing research questions that respond to specific policy

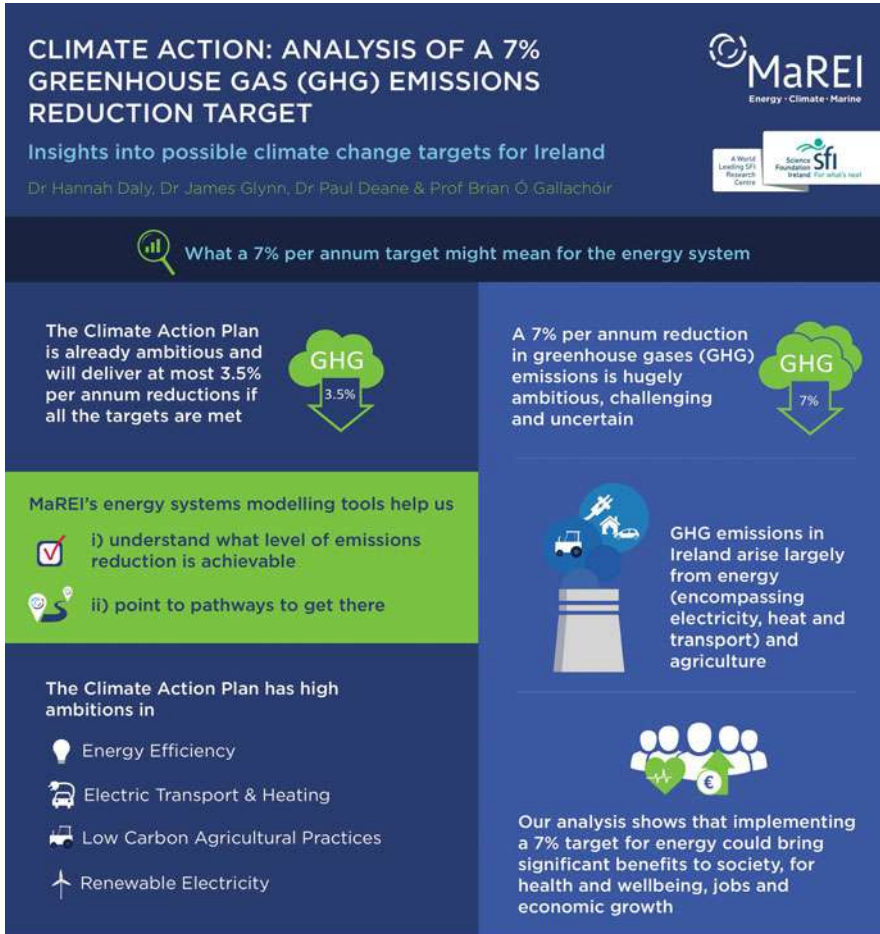

Fig. 5 Infographic highlighting insights from analysis of a 7% per annum reduction in GHG emissions for Ireland in the period 2021–2030

needs. The specific focus of this analysis was on technological changes in the energy system and the associated implications. A key policy question underpinning the analysis focused on the dynamics of the energy system moving towards a low carbon economy for two key time horizons, i.e. to 2050 and to 2030. The process involved modelling analysis and regular meetings and discussions with a number of government departments, providing technical advice and guidance on the development of a long-term strategy for Ireland. The purpose of the roadmap is to explore possible routes towards decarbonisation of the energy system, with a focus on achieving this at least cost to the economy and to society. The key issue is making well-informed policy choices. Hence, this roadmap does not stipulate which policies are necessary to achieve the transition; instead, it focuses on the key drivers and their implications for the energy system of moving to a low carbon economy.

The analysis focused on identifying ways of achieving 80% and 95% reductions in energy-related CO₂ emissions. The analysis also included the creation of a “business-as-usual” baseline (assuming no further policy actions), in order to enable comparisons between options and to help quantify the scale of the transition required. The analysis also presented results in terms of the mitigation potential for each sector (Fig. 6). All scenarios focused on the period to 2050, building on the EPA’s projections that cover the period to 2020. The researchers spent significant time designing and refining graphics that could be easily understood by a non-technical audience. This analysis was also presented to the Oireachtas Committee considering the Bill (Ó Gallachóir 2013), which was subsequently enacted in legislation in December 2015 (Government of Ireland 2015). The evidence provided highlighted the techno-economic feasibility of deep decarbonisation, which provided confidence to the policy system to legislate for climate action.

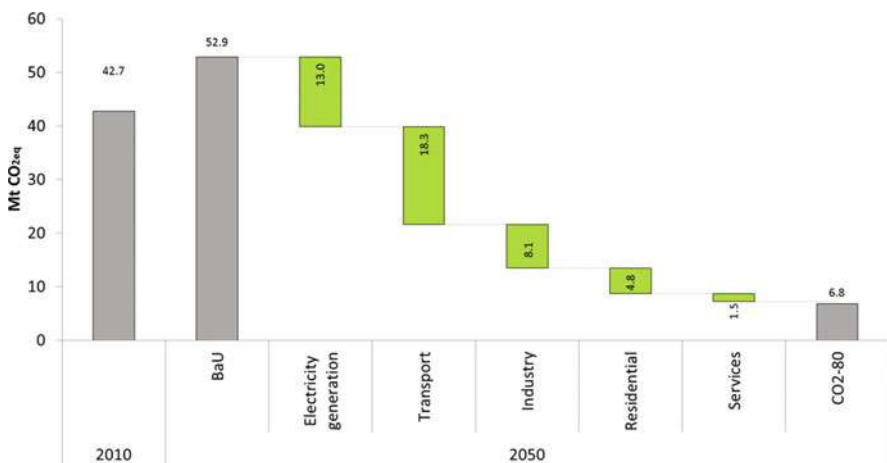

Fig. 6 Waterfall graph showing sectoral reduction in emissions in 2050 in an 80% CO₂ emissions reduction scenario relative to a Business as Usual Scenario (Deane et al. 2013)

3.2 2015: *White Paper on Energy Entitled Ireland's Transition to a Low Carbon Future 2015–2030*

The White Paper on Energy, Ireland's Transition to a Low Carbon Energy Future 2015–2030 (DCENR (Department of Communications, Energy and Natural Resources) 2015), was launched in December 2015. It provided, at that time, a complete energy policy update of actions that the government intended to take in the energy sector, with a particular focus on the period up to 2030. The Irish TIMES model was used to provide technical assistance (Ó Gallachóir et al. 2015) to inform the White Paper.

The process of bridging between science and policy in this case was different and iterative involving more direct interactions between the research team and the policy practitioners within the Department of Energy. It involved the researchers having many meetings with department officials, in particular over the period April–June 2015. The analysis undertaken not only focused on the energy transition to a low carbon future but also addressed a number of other key areas of policy, including the potential role of bioenergy in electricity generation, an assessment of the extent of energy poverty and how this might be addressed, and new approaches for quantifying energy security. In this way, the analysis addressed a number of SDGs, namely elements of SDG 13 on climate mitigation, SDG 7 on energy security and SDG 1 on addressing poverty.

The process focussed on drawing out the key policy questions of interest by actively listening to a wide range of policy makers queries and mapping these questions to specific areas or sectors of the energy system (for example residential, power sector, industry etc). Often there was a cross cutting dimension to questions with overlapping impact for a number of sectors, (for example electrification of heat, retrofitting and power sectors impacts). Once the query was well formulated and the specific part of the energy system identified, energy modelling analyses was used to examine a specific impact and this impact was compared in magnitude to a counterfactual where no change was made. This allowed policy makers to understand the isolated impact of single policy decision. Results were communicated using simple infographics, diagrams and uncomplicated narratives where the impact was clearly explained but without a detailed explanation of the theory and mathematics behind it. This type of communication and practice allow a singular focus on a specific issue and provided numbers to put with the narratives of policy decisions with formed the basis for active and insightful discussion.

This form of deep engagement went beyond informing policy with a report and tended more towards policy co-production, while acknowledging the distinct roles of the researchers and the policy practitioners. In addition, through the iterative interactions modelled on a workshop approach, we also built the capacity of the policy system to better understand the results of the modelling, along with the strengths and limitations of modelling on addressing particular policy questions. The difference in approach was also reflected in the depth of analysis that underpinned Ireland's 2015

White Paper on Energy entitled Ireland's Transition to a Low Carbon Future 2015–2030.

3.3 2017: National Mitigation Plan 2017

The Department of Communications, Climate Action and Environment (DCCAE) commissioned the SFI MaREI Centre at University College Cork (UCC) and the Economic and Social Research Institute (ESRI) to provide technical and economic advice and guidance on the development of National Mitigation Plan (NMP) for Ireland, as required under the Climate Action and Low Carbon Development Act (2015).

The National Policy Position on Climate Action and Low Carbon Development (DCCAE 2014) set an ambition of achieving at least an 80% reduction in CO₂ emissions relative to 1990 levels. In addition, the EU has proposed a 2030 emissions reduction target for Ireland. The period to 2030 is critical on the journey to achieving this long-term objective; different levels of ambition in the medium term have implications for the long-term pathway and, conversely, the long-term ambition affects the choice between medium-term options. It is important to consider these interactions to develop a coherent decarbonisation strategy.

UCC undertook this analysis with partners in 2017 (Curtin et al. 2017) to inform the development of Ireland's first NMP. We developed a NMP scenario that brings together the medium-term mandatory obligations proposed by the EU and the longer-term national ambition.

We compared this with a counterfactual business-as-usual case to explore the scale of the challenge. The NMP scenario is therefore based on the following assumptions:

- overall CO₂ emissions are 80% below 1990 levels by 2050;
- for ETS emissions, a carbon price rises to €40/t by 2030 and emissions decline 2.2% per annum thereafter to 2050;
- Ireland meets its mandatory non-ETS target for 2030 agreed by the EU.

We noted that these assumptions reflect the difficulty of determining how a national target can be achieved within the context of an EU-wide ETS. National governments have little final influence on whether ETS emissions reductions occur on their territory unless a carbon price floor (such as that in the UK) is considered; ultimately, this depends on decisions taken by the installations covered and the ETS carbon price. A key feature of the Irish TIMES model was its ability to separately and coherently model all the sectors of the economy (e.g. transport, electricity, buildings, etc) and to present the results in terms of the ETS and non-ETS sectors (Fig. 7).

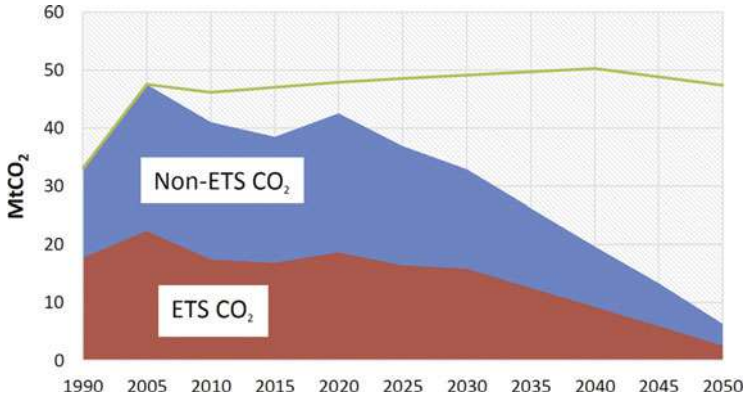

Fig. 7 NMP scenario developed to inform the National Mitigation Plan, distinguishing between energy related CO₂ emissions that fell within the scope of the EU Emissions Trading Scheme (ETS emissions) and remaining emissions (non-ETS emissions)

3.4 2021: Climate Action and Low Carbon Development (Amendment) Act 2021

In the period from 2018–2021, there was a significant increase in climate ambition and this stretched the capacity of the Irish TIMES model. The Climate Action Plan (2019) focussed on delivering the short term targets to 2030 in line with an 80% long-term emissions reduction target. However, the Plan also listed a specific action to *evaluate in detail the changes required to adopt a more ambitious commitment of net zero greenhouse gas emissions by 2050*. We responded to this need by building new scenarios and carrying out new analysis (Ó Gallachóir et al. 2019) to focus on achieving net-zero CO₂ emissions by 2050 (using carbon budgets over the period to 2050). We compared these scenarios with the pre-existing ambition to reduce emissions by 80% relative to 1990 levels by 2050, as illustrated in Fig. 8.

In 2020, the Government published new proposed legislation, namely the Climate Action and Low Carbon Development Amendment Bill 2020, proposing not only an ambition for Ireland to achieve climate neutrality by 2050, but also a doubling of the short term ambition for emissions reduction, namely to achieve on average a 7% per annum reduction in GHG emissions by 2030.

During this period, we developed a successor model, the TIMES Ireland Model (TIM) to take advantage of TIMES modelling improvements and new policy needs, as summarised in the Methods Section. In parallel with these modelling improvements, we continued to use the Irish TIMES model in order to provide continued modelling analyses to the policy makers. Against that context, we provided a scoping analysis on the 7% per annum ambition in late 2020 (Rogan et al. 2020) and preliminary results from the new TIM model in Q2 2021 (Daly et al. 2021c).

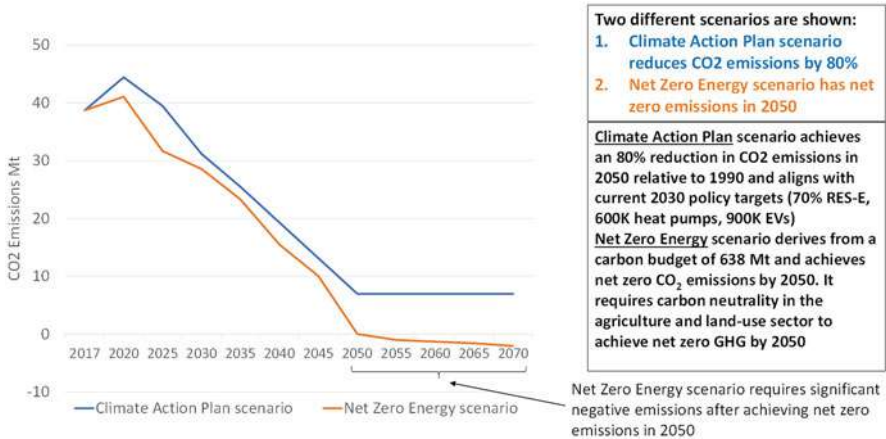

Fig. 8 Comparison of net-zero scenario (responding to increased climate ambition) with previous 80% emissions reduction scenario

In addition to supporting the policy practitioners (i.e. civil servants) in this way, we also provided evidence to policy makers (i.e. politicians) at Parliamentary hearings discussing the new legislation (referenced in Committee Report (Houses of the Oireachtas 2020). The legislation was enacted on 23 July 2021 (Houses of the Oireachtas 2021). The results and insights we presented provided confidence to the policy system to legislate for the increased ambition and put in place firm targets and governance methods. Part of this confidence came from being open and transparent about the model strengths and weaknesses and communicating to policy makers where results were robust or uncertain. This was helped by running many scenarios to isolate key variables that had an outsized impact on results or insight. This allowed policy makers to focus on key drivers of change. These insights were communicated in clear uncomplicated short briefs with non-technical explanations to the providence of results.

The Climate Act places on a statutory basis “the National Climate Objective”; that “the State shall, so as to reduce the extent of further global warming, pursue and achieve, by no later than the end of the year 2050, the transition to a climate resilient, biodiversity rich, environmentally sustainable and climate neutral economy”. The Climate Act also provides for a 51% reduction in greenhouse gases by 2030 compared to 2018 levels, and puts in place a rigorous governance structure, including a system of carbon budgeting, sectoral emissions ceilings, a national adaptation framework, sectoral adaptation plans, and annually updated Climate Action Plans, to ensure that Ireland achieves its national, EU and international climate commitments in the near- and long-term.

In addition to engaging with the policy eco-system, we also collaborated with other stakeholder (including from industry) focussing on decarbonising different sectors, including how to halve transport GHG emissions by 2030 together with the Irish Bioenergy Association (Deane 2021a), how to achieve zero emissions in electricity generation together with the Electricity Association of Ireland (Mehigan and Deane 2020) and the role of wind energy in achieving climate neutrality in Ireland by 2050 together with Wind Energy Ireland (Deane 2021b). This contributes directly to SDG target 17.16 on increasing multi-stakeholder partnerships that mobilize and share knowledge and expertise and SDG target 17.17 on encouraging and promoting effective public, public-private and civil society partnerships.

3.5 2022: Oireachtas Approval of Carbon Budgets 2022

Ireland's legislation (Climate Action and Low Carbon Development (Amendment) Act 2021) established a 5 yearly carbon budget process for the periods 2021–2025 and 2026–2030. The Act specified that the Climate Change Advisory Council would propose carbon budgets for these first two periods.

UCC's research team had two distinct roles regarding the decision making on carbon budgets. Firstly, two UCC researchers were invited members of the Carbon Budgets Committee established by the Climate Change Advisory Council to assist them in quantifying Ireland's carbon budgets. In this capacity we assessed available analysis and data and collectively produced the Council's proposed carbon budgets and presented these proposed budgets to the Joint Oireachtas Committee on Climate Action in January 2022 (Houses of the Oireachtas 2022).

Secondly, part of the evidence considered by the Carbon Budgets Committee was developed by UCC via mitigation scenarios with TIM to explore different options for energy system mitigation for consideration by the Council, focusing on the implications for energy system evolution, technology choices and demand pathways. This analysis formed a significant part of the evidence used by the Climate Change Advisory Council to propose the first set of carbon budget recommendations (Climate Change Advisory Council 2021).

The Oireachtas Committee recommended that the carbon budgets proposed be adopted, they were then approved by the Irish Government in February 2022 and then adopted by both Houses of the Oireachtas in May 2022 without the need for a vote, attesting to the cross party political support. This was a good example of how effective co-production of policy can take place where the scientific and policy communities work together on a shared challenge, in this case determining appropriate carbon budgets that take many, sometimes conflicting goals into account simultaneously, including deep decarbonisation, climate justice, economic growth, increased biodiversity, etc.

4 Conclusion and Recommendations

The key findings from this case study of 15 years energy of bridging between the research eco-system and policy eco-system are that it is very challenging but can be highly impactful. The benefits of effectively bridging between science and policy would appear obvious and the COVID-19 pandemic clearly demonstrated this. Yin et al. found that policy documents in the COVID-19 pandemic substantially access recent, peer-reviewed, and high-impact science (Yin et al. 2021).

An ex-post assessment of the science policy interfaces during the pandemic highlights the need to build and strengthening knowledge translation (i.e. interaction among the producers and users of research, removing the barriers to research use, better of tailoring information to different target audiences so that effective interventions are used more widely), a shift in the existing ‘incentive’ system of researchers (publish or perish) and building capacity in equity-centred evidence-informed decision-making (Kuchenmüller et al. 2021).

The challenges are significant however and should not be downplayed. The transition from the more traditional research approach of publishing results in a journal paper and then moving on to addressing the next research question is very far removed from the co-production approach of working with policy practitioners collaboratively on policy development. There are of course a number of different steps and approaches available to closing the gap between the science and policy communities. From our experience over a 15 year period, motivation is critically important in order to overcome the challenges and to take on the extra effort to move beyond the traditional research process towards any or all of: actively informing, influencing, underpinning and co-producing policy. Researchers that have an ambition to achieve positive policy impact from the research are more likely to succeed. Another key part of our experience is trial and error (and sometimes success) in finding methods to effectively translate research findings into policy relevant information. Actively engaging with the policy eco-system is a non-trivial challenge. Ireland being a relatively small country, with a relatively small civil service, made it easier to locate the key policy practitioners to approach, and also relatively easy to physically get to their location. Access to policy practitioners and policy makers is also aided by a culture of informal engagement being acceptable.

It is also useful to tease out some of the lessons learned from the different policy engagements over the past 15 years, a sub-set of which are touched on in this chapter. Journal papers and detailed reports provide a strong and necessary evidence base but are not sufficient without a significant effort in translating the results into policy relevant insights. Engagement is not about communicating research findings, but critically also about listening to the policy practitioners needs, and developing a clear understanding of the policy making process, which is significantly different from the research process. Rather than pushing messages and findings from research it is vital to listen and learn what is useful from their perspective. Building trust with policy practitioners can take a lot of time and effort, but is hugely important. This includes developing personal relations respecting their role, their position, and when

conversations are confidential in nature (especially when this not explicitly stated). Regular staff turnover in the civil service (as they move to different departments across the Government system to improve promotion prospects) makes this a particular challenge.

Based on this experience, coupled with the examples provided our approach can be summarised in a seven step plan that other energy systems modelling teams may find useful, in particular those who wish to bridge between the research and policy eco-systems:

1. **Undertake scientifically robust research**, submit it for peer review, publish it in scientific journals and **make methods and results openly and publicly available** (e.g. TIMES Ireland Model has peer reviewed paper, model code openly available and scenario results web interface)
2. **Frame research questions that respond to specific policy needs**, and then submit the results and insights to policy practitioners to inform policy (e.g. energy modelling analysis specifically undertaken to inform the National Mitigation Plan 2017)
3. **Translate research results into policy insights**—including through the use of ‘policy briefs’ (e.g. policy brief submitted to the Joint Oireachtas Committee on Climate Action in 2018, focusing on insights for 2030, for 2050 and on citizen engagement and dialogue)
4. **Improved communications** of research findings through the development of **infographics** (e.g. pathways to a net zero energy system)
5. **Engage actively with policy practitioners and policy makers**—this is critical to move beyond informing and towards influencing policy, mindful of the different roles and responsibilities of each (e.g. the frequent (fortnightly) meetings with Department officials during the summer of 2015 to work on the White Paper on Energy)
6. **Co-production of policy**—co-production is challenging but can be very successful (e.g. invited members of the Carbon Budgets Committee established by the Climate Change Advisory Council to assist them in quantifying Ireland’s carbon budgets. These proposed budgets adopted by both Houses of the Oireachtas in May 2022 without the need for a vote.
7. **Building absorptive capacity in the policy system**—This is a further recommendation that arises from the many interactions with the policy system. In addition to the researchers improving their communication of policy insights from the research results, the focus here is on equipping the policy makers to understand the strengths and limitations of the modelling approaches used, and improved interpretation of the scenario results generated. This requires dedicated time and resources to build policy makers’ capacity to better absorb the insights arising from the energy modelling analyses. This can be readily extended via a safe space for ‘basic’ questions, capacity building, secondments in both directions, etc.

References

- Aryanpur V, Ó Gallachóir B, Dai H, Chen W, Glynn J (2019) A review of spatial resolution and regionalisation in national-scale energy systems optimisation models. *Energy Strat Rev* 37: 100702
- Aryanpur V, Balyk O, Daly H, Ó Gallachóir B, Glynn J (2022) Decarbonisation of passenger light-duty vehicles using spatially resolved TIMES-Ireland model. *Appl Energy* 316:119078
- Balyk O (2022) Timeslice tool for TIMES models (v0.1.0) Zenodo. <https://doi.org/10.5281/zenodo.6564759>
- Balyk O, Glynn J, Aryanpur V, Gaur A, McGuire J, Smith A, Yue X, Daly H (2021) TIM: modelling pathways to meet Ireland's long-term energy system challenges with the TIMES-Ireland model (v1.0). *Geosci Model Dev* 15:4991–5019
- Chiodi A, Gargiulo M, Deane JP, Lavigne D, Rout UK, Ó Gallachóir BP (2013a) Modelling the impacts of challenging 2020 non-ETS GHG emissions reduction targets on Ireland's energy system. *Energy Policy* 62:1438–1452
- Chiodi A, Gargiulo M, Rogan F, Deane JP, Lavigne D, Rout UK, Ó Gallachóir BP (2013b) Modelling the impacts of challenging 2050 European climate mitigation targets on Ireland's energy system. *Energy Policy* 53:169–189
- Chiodi A, Giannakidis G, Labriet M, Ó Gallachóir BP, Tosato GC (2015a) Introduction: energy systems modelling for decision-making. In Giannakidis et al (eds) *Informing energy and climate policies using energy systems models*. Springer International Publishing: 15–41 (ISBN 978-3-319-16539-4).
- Chiodi A, Deane JP, Gargiulo M, Ó Gallachóir BP (2015b) The role of bioenergy in Ireland's low carbon future—is it sustainable? *J Sustain Dev Energy Water Environ Syst* 3(2):196–216
- Chiodi A, Donnellan T, Breen J, Hanrahan K, Gargiulo M, Ó Gallachóir BP (2015c) Integrating agriculture and energy within an energy systems models to assess GHG emissions reduction—a methodological approach. *Clim Pol* 16:215–236
- Climate Change Advisory Council (2021) Carbon budget technical report, October 2021. <https://www.climatecouncil.ie/media/climatechangeadvisorycouncil/Technical%20report%20on%20carbon%20budgets%2025.10.2021.pdf>
- Curtin J, deBruin K, Hanley E, Ó Gallachóir B (2017) Energy modelling to inform the National Mitigation Plan. Report to DCCAE. <http://dcae.gov.ie/documents/ESRI%20Energy%20Modelling%20Paper%20May%202017.pdf>
- Czyrnek-Delêtre M, Chiodi A, Murphy JD, Ó Gallachóir B (2016) Impact of including land use change emissions from biofuels on meeting GHG emissions reduction targets—the example of Ireland. *Clean Techn Environ Policy* 18:1745–1758
- Daly H, Glynn J, Ó Gallachóir BP (2020) The energy system could decarbonise at 7% annually but requires far-reaching action. *Irish Times Science Section*, April 30. <https://www.irishtimes.com/news/science/it-is-not-clear-if-green-party-s-emissions-reduction-target-is-feasible-1.4238995>
- Daly H, Smith A, Aryanpur V, Gaur A, McGuire J, Yue X, Glynn J, Balyk O (2021a) Carbon budget scenarios for Ireland's energy system, 2021-50 (v1.0) [data set]. Zenodo. <https://doi.org/10.5281/zenodo.5517363>
- Daly H, Smith A, Aryanpur V, Gaur A, McGuire J, Yue X, Glynn J, Balyk O (2021b) Carbon budget scenarios for Ireland's energy system, 2021-50 (v1.0) [web app]. <https://tim-carbon-budgets-2021.netlify.app/about>
- Daly H, Smith A, Aryanpur V, Gaur A, McGuire J, Yue X, Glynn J, Balyk O (2021c) Carbon budget scenarios for Ireland's energy system, 2021-50 (v1.0) [data]. <https://github.com/MaREI-EPMG/ireland-carbon-budget-scenarios-2021>
- DCENR (Department of Communications, Energy and Natural Resources) (2015) White paper on energy. Ireland's transition to a low carbon energy future 2015–2030. <https://www.gov.ie/en/publication/550df-the-white-paper-irelands-transition-to-a-low-carbon-energy-future-2015-2030/>

- Deane JP (2021a) Transport in Ireland: a pathway to halving emissions. Report for the Irish Bioenergy Association. <https://www.marei.ie/wp-content/uploads/2021/12/Irish-Bioenergy-Association-UCC-MaREI-Renewables-In-Transport-Report-Final.pdf>
- Deane JP (2021b) Our climate neutral future: Zero by 50. Report for Wind Energy Ireland. <https://www.marei.ie/wp-content/uploads/2021/03/Our-Climature-Neutral-Future-Zero-by-50-Skillnet-Report-March-2021-Final-2.pdf>
- Deane JP, Chiodi A, Gargiulo M, Ó Gallachóir BP (2012) Soft-linking of a power systems model to an energy systems model. *Energy* 42(1):303–312
- Deane JP, Curtis J, Chiodi A, Gargiulo M, Rogan F, Dineen D, Glynn J, FitzGerald J, Ó Gallachóir B (2013) Low carbon energy roadmap for Ireland. Report to Department of Environment, Community and Local Government, Dublin
- Deane JP, Gracceva F, Chiodi A, Gargiulo M, Ó Gallachóir BP (2015a) Assessing power system security. A framework and a multi model approach. *Int J Electr Power Energy Syst* 73:283–297
- Deane JP, Gracceva F, Chiodi A, Gargiulo M, Ó Gallachóir BP (2015b) Soft-linking exercises between TIMES, power system models and housing stock models. In Giannakidis et al (eds) *Informing energy and climate policies using energy systems models*. Springer International Publishing pp 315–331 (ISBN 978-3-319-16539-4)
- Deane JP, Chiodi A, Ó Gallachóir BP (2016) Irish TIMES energy systems model phase 2 (CCRP-2011-MS-3.5). Environmental Protection Agency. isbn: 978-1-84095-680-1. https://www.epa.ie/publications/research/climate-change/EPA%2D%2DResearch-Report-199_webEssentra.pdf
- DECLG (Department of Environment, Community and Local Government) (2013) General scheme of a climate action and low carbon development bill (CA&LCD bill). DECLG, Dublin
- Department of Industry Commerce and Energy (1978) *Energy-Ireland: discussion document on some current energy problems and options*. Department of Industry Commerce and Energy, Dublin, in [Catalogue lists] (Ireland. Stationery Office)
- Department of Public Enterprise (1999) *Green paper on sustainable energy*. Government Publications Office
- EC (2009) Presidency conclusions. Brussels 29/30 October 2009. In: Council of the European Union (ed), Brussels, Belgium. https://www.consilium.europa.eu/uedocs/cms_data/docs/pressdata/en/ec/110889.pdf
- EU (2009) Decision No 406/2009/EC of the European Parliament and of the Council of 23 April 2009 on the effort of Member States to reduce their greenhouse gas emissions to meet the Community's greenhouse gas emission reduction commitments up to 2020. European Parliament and Council, Editor 2009, Official Journal of the European Union p 13. <https://eur-lex.europa.eu/legal-content/EN/TXT/?uri=celex%3A32009D0406>
- Gaur A, Balyk O, Glynn J, Curtis J, Daly H (2022) Low energy demand scenario for feasible deep decarbonisation: whole energy systems modelling for Ireland. *Renew Sustain Energy Trans* 2: 100024
- Glynn J (2020) Carbon capture and offsetting in reaching carbon neutrality. Opening statement to Oireachtas committee on climate action in their deliberations on new climate legislation. https://data.oireachtas.ie/ie/oireachtas/committee/dail/33/joint_committee_on_climate_action/submissions/2020/2020-10-29_opening-statement-dr-james-glynn-marei-sfi-research-centre-for-energy-climate-and-marine-university-college-cork_en.pdf
- Glynn J, Chiodi A, Gargiulo M, Deane JP, Bazilian M, Ó Gallachóir B (2014) Energy security analysis: the case of constrained oil supply for Ireland. *Energy Policy* 66:312–325
- Glynn J, Fortes P, Krook-Riekkola A, Labriet M, Vielle M, Kypreos S, Lehtilä A, Mischke P, Dai H, Gargiulo M, Helgesen PI, Kober T, Summerton P, Merven B, Selosse S, Karlsson K, Strachan N, Ó Gallachóir BP (2015) Economic impacts of future changes in the energy system—national perspectives. In: Giannakidis et al (eds) *Informing energy and climate policies using energy systems models*, pp 359–387. isbn 978-3-319-16539-4
- Glynn J, Gargiulo M, Chiodi A, Ó Gallachóir B (2017) Energy security assessment methods: quantifying the security co-benefits of decarbonising the Irish energy system. *Energ Strat Rev* 15:72–88

- Glynn J, Gargiulo M, Chiodi A, Deane JP, Rogan F, Ó Gallachóir B (2019) Zero carbon energy system pathways for Ireland consistent with the Paris agreement. *Clim Pol* 19(1):30–42. <https://www.tandfonline.com/doi/pdf/10.1080/14693062.2018.1464893>
- Government of Ireland (2015) Climate action and low carbon development act 2015. Act No. 46 of 2015
- Houses of the Oireachtas (2020) Joint Committee on Climate Action Pre-Legislative Scrutiny on the draft of the climate action and low-carbon development (amendment) Billboard 2020, December 2020. Report 33-JCCA-01
- Houses of the Oireachtas (2021) Ireland's climate action and low carbon development (amendment) Act 2021. Act 32 of 2021. <https://www.oireachtas.ie/en/bills/bill/2021/39/>
- Houses of the Oireachtas (2022) Joint Committee on Environment and Climate Action report on the proposed carbon budgets Report 33/JCECA/06. https://data.oireachtas.ie/ie/oireachtas/committee/dail/33/joint_committee_on_environment_and_climate_action/reports/2022/2022-02-07_report-on-the-proposed-carbon-budgets_en.pdf
- Kuchenmüller T, Reeder JC, Reveiz L, Tomson G, El-Jardali F, Lavis JN, Rashidian A, Reinap M, Grove JT, Swaminathan S (2021) COVID-19: investing in country capacity to bridge science, policy and action. *BMJ Glob Health* 6(2):e005012
- Mc Guire J, Rogan F, Balyk O, Mac Uidhir T, Gaur A, Daly H (2023) Developing decarbonisation pathways in changing TIMES for Irish homes. *Energy Strat Rev* 47:101086
- Mehigan L, Deane JP (2020) Our zero e-mission future. Report for the Electricity Association of Ireland. <https://www.eaireland.com/wp-content/uploads/2021/06/Our-Zero-e-Mission-Future-Report.pdf>
- National Co-ordinating Centre for Public Engagement NCCPE (2023) A guide to working with policy makers. <https://www.publicengagement.ac.uk/do-engagement/understanding-audiences/policy-makers>
- Ó Gallachóir BP (2013) Submission to Oireachtas Joint Committee on Environment, Culture and the Gaeltacht Committee on Outline Heads of the Climate Action and Low-Carbon Development Bill. Environmental Research Institute, University College Cork, Cork. <https://www.foe.ie/assets/files/pdf/gallachirbriansubmission2pdfversion.pdf>
- Ó Gallachóir BP (2021) Carbon budgets 2021–2030: a bridge from climate ambition to climate action. <https://www.marei.ie/wp-content/uploads/2021/07/MaREI-Note-on-Irelands-first-two-Carbon-Budgets-1.pdf>
- Ó Gallachóir BP, Chiodi A, Gargiulo M, Deane P, Lavigne D, Rout UK (2012) Irish TIMES energy systems model. Environmental Protection Agency report no. CCRP 2008 3.1 Johnstown Castle, Co. Wexford, Ireland. <https://www.epa.ie/publications/research/climate-change/Irish-TIMES-Energy-Systems-Model.PDF>
- Ó Gallachóir BP, Deane P, Chiodi A, Glynn J, Rogan F (2015) Energy modelling to inform the white paper report submitted to Department of Communications, Energy and Natural Resources
- Ó Gallachóir BP, Rogan F, Daly H, Deane P, Xiufeng Y, McGuire J (2019) Long term strategy—a net zero energy system for Ireland in 2050. Report to Department of Communications, Climate Action and the Environment, 15 Nov 2019
- Ó Gallachóir BP, Deane P, Glynn J, Rogan F (2020a) The role of energy technology in climate mitigation in Ireland: Irish TIMES phase 3. EPA, Research report 326. Isbn: 978-1-84095-918-5. <https://www.epa.ie/publications/research/climate-change/research-326.php>
- Ó Gallachóir BP, Watson C, Revez A, Boyle E, McGookin C, Deane A, Byrne E, Harris C, Hughes I, Rogan F, Dunphy N, Mullally G (2020b) Citizen engagement and dialogue: submission to Oireachtas Committee Pre-Legislative Scrutiny of the Climate Action and Low Carbon Development (Amendment) Bill 2020. <https://www.marei.ie/wp-content/uploads/2020/10/MaREI-Submission-on-Citizen-Engagement-and-Dialogue-to-Oireachtas-Committee-on-Climate-Action.pdf>
- Oliver K, Cairney P (2019) The dos and don'ts of influencing policy: a systematic review of advice to academics. *Palgrave Commun* 5:21

- Rogan F, Daly H, Deane JP, Glynn J, Hore N, Ó Gallachóir BP (2020) Can the Irish energy system decarbonize by 7% p.a.? Scoping analysis submitted to Department of the Environment, Climate and Communications, 18 Dec 2020
- UCC MaREI Centre (2018) Note to joint Oireachtas committee on climate action. https://data.oireachtas.ie/ie/oireachtas/committee/dail/32/joint_committee_on_climate_action/submissions/2018/2018-12-12_submission-marei-centre_en.pdf
- Yin Y, Gao J, Jones BF, Wang D (2021) Coevolution of policy and science during the pandemic. *Science* 371:128–130

Open Access This chapter is licensed under the terms of the Creative Commons Attribution 4.0 International License (<http://creativecommons.org/licenses/by/4.0/>), which permits use, sharing, adaptation, distribution and reproduction in any medium or format, as long as you give appropriate credit to the original author(s) and the source, provide a link to the Creative Commons license and indicate if changes were made.

The images or other third party material in this chapter are included in the chapter's Creative Commons license, unless indicated otherwise in a credit line to the material. If material is not included in the chapter's Creative Commons license and your intended use is not permitted by statutory regulation or exceeds the permitted use, you will need to obtain permission directly from the copyright holder.



Retrospective of Prospective Exercises: A Chronicle of Long-Term Modelling and Energy Policymaking in France



Nadia Maïzi, Edi Assoumou, and Ariane Millot

Abstract The French prospective aims to influence the shaping of the future by exploring different scenarios and evolution, so that long-term challenges are considered in current decision-making. In practice realizing this linkage between modelers and policy makers is itself a process and comes with its own challenges. This chapter reflects on modelling to inform various energy policy assessments in France aligned with SDGs 7 (energy), 8 (economic growth), 9 (industry), 11 (cities) and 13 (climate), across several exercises around the reduction of greenhouse gas emissions, the nuclear phase-out, the implementation of a 100% renewable power system with its reliability issues and the assessment of carbon value. It is based on our practical experience at the Centre for Applied Mathematics (MINES Paris—Université PSL) where TIMES has been used as a bottom-up optimization approach to offer insights, within extended committees, to French policymakers. The model we developed is the TIMES-FR model where FR stands for France. Our experience reveals that policymakers do not fully harness the wealth of technical insights provided by researchers, as they often prioritize short or mid-term challenges. While policy perspective does not seem to need the precision and comprehensiveness of technical modelling, we show that the insights tend to penetrate at some point in the public debate and policy-making sphere, which emphasizes the relevance of using prospective and energy system models to address climate change.

N. Maïzi (✉) · E. Assoumou
Centre for Applied Mathematics, MINES Paris, PSL Research University, Sophia Antipolis,
France
e-mail: nadia.maizi@minesparis.psl.eu; edi.assoumou@minesparis.psl.eu

A. Millot
Department of Chemical Engineering, Imperial College London, London, UK
e-mail: a.millot@imperial.ac.uk

© The Author(s) 2024
M. Labriet et al. (eds.), *Aligning the Energy Transition with the Sustainable
Development Goals*, Lecture Notes in Energy 101,
https://doi.org/10.1007/978-3-031-58897-6_16

Key Messages

- Enhancing the dialogue between modellers and policy makers is a continuous process during which the technicality of models is often hard to convey as synthetic policy message.
- Our TIMES modelling experiences in France illustrate how TIMES models can support decision making and catalyse discussions on demands, technical choices and systemic interactions.
- Using the model in prospective assessments, we show that TIMES models are relevant tools to explore SDGs 7 (energy), 8 (economic growth), 9 (industry), 11 (cities) and 13 (climate).
- In the context of an acute climate crisis, it is crucial to strengthen the relation between modelling teams that shed light on possible futures and decision-makers, so that they effectively leverage the insights from the scenario results.

1 Introduction

Every decision involves the future. This is undoubtedly the reason why all decision-makers are obsessed with their relationship with the future, which has led them to turn to oracles since the dawn of time. The first divinatory technique, the Yi Ching, is attributed to the founder of the Chinese Empire around the fourth century BC. Like Arabic geomancy, it is a technique that involves constructing stories of the future from randomly drawn passages in sacred books. This desire to guess the future is part of a fatalistic credo in which everything is written in advance, the “mektoub” so dear to the Mediterranean.

In our modern societies, forecast, prediction, foresight, prospective or scenario analysis are new related and nuanced expressions of this attempt to make sense of the future. This chapter reviews a practical experience of interactions with the decision-making sphere. Over the past two decades, we have been involved in several country-level prospective exercises for France using our TIMES-FR model to answer different types of energy system-related questions for various stakeholders. These were genuine occasions to confront the short-term, time-constrained agenda of working groups, which included a large range of stakeholders, involving the open and continuous improvement of model mindset of modellers.

Were decision-makers able to understand and make use of the information we provided? Did we learn anything useful from a modelling perspective? Can these scenarios serve the Sustainable Development Goals (SDGs)? This chapter examines this experience to derive some insights into the difficulties encountered as well as the few successes we achieved and the uncertainty about the effectiveness of the dialogue. It shows how long-term analysis results can be handled to build relevant energy policies and strategies for the future, relying on a weak but persistent line of communication and at least some recognition of the contribution of each community.

First, we explicit the specific relation that is established between decision-makers and the future through prospective exercises, whereby prospective is conceived as a

way of shedding light on the future, enabling its construction. Then we underline the interest of using TIMES to provide long-term scenarios. Finally, we draw specific lessons from past exercises for France, related to SDGs 7, 8, 9, 11 and 13, illustrating the pitfalls of dialogue with policy and decision-makers.

The debate on SDGs opens a new phase or, at least, a new challenging chapter in this dialogue. It offers an opportunity to question the type of broader societal aspirations that have been addressed or were omitted in these past experiences.

2 French Prospective: Evolution of the Decision-Making Philosophy in France

To predict is always to run up against the unforeseeable, making any forecast perilous. The energy sector, for example, is full of examples of failed forecasts: unpredictable oil shocks in the 1970s, and more recently the advent of rock gas, which has turned world markets upside down, are all cataclysmic events that experts were unable to anticipate and that have caused complete market disruption. In the same vein, all attempts to forecast oil prices have been unsuccessful: none of the exercises carried out by various renowned international agencies has ever consistently tracked fluctuations in the actual price of crude.

This section resituates the French approach to the future for decision-makers in its historical context.

2.1 A Vision Driven by Technical or Operational Efficiency

In the aftermath of the Second World War, the United States used futurology, the science of forecasting to define its relationship with the future. Preoccupied with military issues in the context of the Cold War, the United States deployed technological forecasting methods to anticipate what future inventions of military equipment might look like. The work was carried out by the RAND Corporation (RAND for Research and Development), which in fact had a much broader mission of: “[. . .] furthering and promoting scientific, educational, and charitable purposes for the public welfare and security of the United States.” (RAND 2023).

Ultimately, RAND researchers had to think in terms of several possible futures: to envision the military equipment of the future, they had to consider all the factors that could determine decisive technical developments and evaluate any potential geo-strategic developments that this equipment would have to respond to. To do so, they developed a now well-known method, the Delphi method, based on a back-and-forth process that solicits expert opinion on a list of probable innovations, and whose limitations include neglecting the relationship between these innovations.

2.2 *A Philosophically Motivated Vision of Prospective*

Around the same time, in France, a new attitude emerged that laid the foundations for the French-style *prospective*. The main difference with the American approach was that prospective did not give technology the same central position in predetermining the future. For some, the impact of technology on society seemed more like a threat to the social order, or even to the survival of humanity. We should bear in mind that the context was the industrial reconstruction of the country after the Second World War, featuring national planning driven by the government.

To design these reconstruction plans, the relationship with the future had to be rethought. In particular, the preparation of the Third State Plan (1958–1961) saw a clear shift from a short-term focus to a long-term focus.

This is because the *Commissariat Général au Plan* (French General Planning Commission), in collaboration with the *Service des Etudes Economiques et Financières* (French Economic and Financial Studies Department), considered it necessary to draw up an economic projection with the aim to also capture social and cultural developments. Similarly, to prepare the Fourth Plan, projections extended to 1975. The evolution from planning to prospective had started, with the aim of producing scenarios to help arbitrate between different choices for society. This development had a profound impact on French society, with prospective becoming an integral part of central government departments (all ministries had their own prospective units), as well as in the industrial sector. Beyond the organisational level, on the theoretical level, the contribution of several intellectual figures was crucial.

2.3 *Gaston Berger's Legacy*

Although the contribution of the RAND is better known, it is worth looking at a pioneer figure of this more philosophical French school of thought, and his unique relationship with the future: Gaston Berger. Born in 1896, Berger began his career at the head of a flower fertiliser company. Curious by nature, eager to learn, and passionate about literature and philosophy, he began studying at the University of Aix-en-Provence late in life, where he forged his conviction that decision-makers needed help to apprehend the future (Berger et al. 2007). He considered himself as “a philosopher in action”: he thought that action was the very *raison d'être* of decision-makers, who, in order to act, needed to be resolutely turned towards the future. Berger was aware of living in an accelerating world in which the future would not be magically revealed to him: he had to build it.

By the time the 1950s arrived, Berger found himself living in an even more complex, fast-paced world, which he described as follows: “If he is sixty years old, one of our contemporaries has lived in three worlds; if he is thirty years old, he has experienced two... It took thousands of years for man to move from the speed of his own race to that of a galloping horse. It took him twenty-five or thirty centuries to

cover a hundred kilometres an hour. It only took him fifty to exceed the speed of sound.” (Berger et al. 2007).

For Gaston Berger, this very rapid change in society, driven by an unprecedented scientific and technical shift, justified the need to take an interest in the distant future, not as “something that has already been decided, and which we will gradually discover for ourselves, but as something to be done”— the total opposite of the forecasting approach. His prospective approach is summed up in this metaphor: “Our civilisation is like a car driving faster and faster down an unfamiliar road after dark. Its headlights have to reach further and further if we are to avoid disaster.” (Berger et al. 2007).

2.4 *Production of Long-Term Scenarios*

While the practice of prospective is disproportionately discussed regarding its quantitative performance today, not all long-term scenarios currently widely debated and submitted to the public, decision-makers and negotiators are based on models. Thus, the same climate and energy issues can be fuelled by scenarios that:

- tell a story (often one we believe in a priori) and back it up with descriptions and visions: this is what is known as storytelling based on expert opinion;
- involve backcasting, i.e., once you have set the objective you are trying to achieve, you go back in time by simulating and consolidating the trajectory that would enable you to achieve this goal, including intermediate stages;
- combine the imagination of science fiction writers with our scientific expertise, for instance in the case of the scenarios produced by the RED TEAM (2021) for the French Ministry of Defence in association with PSL Research University (Paris Sciences et Lettres).

To explore the long term, climate prospective can also rely on models that are developed to provide the closest possible match with the ‘real world’ and convey its complexity. This is the approach to the future that is widely discussed in this volume and that we are collectively exploring within the community of the Energy Technology Systems Analysis Programme (ETSAP), in which the Centre for Applied Mathematics of l’École Nationale Supérieure des Mines de Paris has been operating as reference laboratory for France since 2008.

In this diversity of frameworks to question the future, our experience illustrates that as part of larger deliberative processes, TIMES models can:

- readily contribute to SDGs 7 and 13, which are clearly energy-related;
- help describe the SDGs 8 and 9 challenges in terms of infrastructure;
- contribute to the SDG11 social dimension by questioning the end-use demands.

3 Case Study: Chronicle of the Dialogue Between TIMES and Policymaking in France

This third section provides a brief chronicle of our experience of long-term modeling as a component of the scientific policy debate in France since 2005.

3.1 *TIMES as a Useful ‘Mathematical’ Tool . . . That Merely Approximates Reality*

Our model is derived from the work initiated by the International Energy Agency (IEA) through ETSAP after the two oil crises of the 1970s. This initiative aimed to develop a tool capable of envisioning the long-term future of the energy system and, ultimately today, the associated climate issues.

The underlying hypothesis adopted by TIMES models features a single benevolent planner that induces centralised decisions based on an optimality criterion. It is justifiable to strongly call into question this hypothesis. However, optimisation is a key method that is used by scientists and essential for decision-makers. Sometimes, it is important to solve a problem optimally; at other times, optimality is not the crucial issue, either because a near-optimal solution is sufficient, or because it is difficult to associate the real problem with a simple criterion enabling judgement of the solution. Even in these cases, optimisation is useful because it gives the modeller a way of testing their thinking (Maïzi 2012). If the optimal solution is not feasible, or even ridiculous, then this may underline the need to refine the model and the thinking around it, while respecting a principle of coherence with respect to the problem to be addressed (Colasse et al. 1995) because “caution, the natural companion of ignorance, can sometimes lead to the use of an amended or different criterion” (p. 165 Massé 1991).

The static nature and the linearity property adopted by the optimal formulation of the TIMES models place the underlying optimisation within the framework of mathematical programming (Dantzig 1963). This branch of operational research emerged in 1940 in the context of scheduling or planning activities such as production planning or stock management led by large organisations and military operations. Scheduling, in the sense of planning, consists in developing a programme to determine the value of a variable (known as a decision variable) representing a quantity or a level of activity. This programme mathematically describes the restrictions inherent in planning as a set of equations or inequalities involving these variables. An acceptable plan is one that considers all these constraints. In TIMES, both the objective function and the equality or inequality constraints are linear. Although attractive, it is sometimes unrealistic to retain the linearity hypothesis to reflect the specificity of the optimal question being asked.

However, in the TIMES family of models, the optimisation hypothesis, although unrealistic in a competitive, individualistic and decentralised world, provides

valuable insights. Indeed, the results obtained through this approach correspond to the best achievable technological offer satisfying the evolution of demand that we envisage for the future. Even if this best response, this optimal response, leads to unsustainable greenhouse gas emissions, or if the model does not produce a solution, it nevertheless provides a valuable indication. It tells us that the set of hypotheses we are considering leads to undesirable or unfeasible futures. We then have to go back to the drawing board and consider different options or levers in order to change the trajectory and build a future that is both plausible and desirable (Maïzi 2012). Prospective does not aim to foresee, but rather to shed light on possible futures in order to offer “a prosthesis to the blind decision-maker seeking a calculated adventure”, as Pierre Massé urges us to do (Massé 1991).

3.2 Evolution of French Legislation on Energy and Climate

In 2024, the transition to a low-carbon energy system is one of the official objectives of French energy policy, and the main commitments set out in the law can be summarised as follows:

- –40% GHG by 2030 compared to 1990 and carbon neutrality by 2050;
- –50% of the final energy consumption by 2050 compared to 2012 (20% by 2030);
- –40% fossil fuel consumption by 2030 compared to 2012;
- 33% of renewable energy in final energy consumption by 2030 and 40% for electricity production;
- cancellation of the previous target of 50% nuclear power in electricity generation by 2035.

The 2030 objective for GHG reduction is due to be updated soon to 50% to align with the new goal set in the European Climate Law enacted in 2021 (reduction of 55% by 2030 compared to 1990 levels for the European Union) and the recent recommendation to reduce net emissions by 90% by 2040.

The adoption and subsequent definition of these objectives, set out in successive bills since the early 2000s (Fig. 1), has evolved, notably aligning France with international and European commitments showing that the challenges of SDG13 have now become a major element of French energy policy.

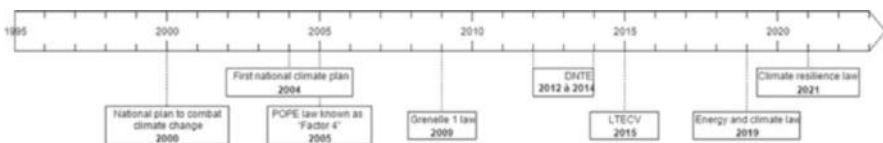

Fig. 1 Evolution of plans and laws in France from 1990 to 2021. (From A. Millot’s PhD thesis 2019). *Note:* DNTTE stands for National Debate on Energy Transition

We here look back over this chronology (Millot 2019), focusing on the legislative context of the three committees in which we participated. This serves to illustrate, at the French level, how the climate-constrained energy scenarios that we have drawn up have enabled discussions on the implications of choices and options, in terms of industrial policy, imports, costs, deployment rates of various means of production (SDGs 8 and 9), technical feasibility (SDG7), lifestyles and behaviour (SDG11) etc.

3.3 The POPE Law (Energy Policy Orientation Programme)

In 1998, the Kyoto Protocol led to the adoption of an 8% reduction target for GHG emissions by the European Union. The ensuing burden sharing approach led France to pledge to maintain its emissions at 1990 levels, which went on to be included in 2000 in the first *Plan national de lutte contre le changement climatique* (PNLCC: National Plan to Combat Climate Change).

The *Plan Climat* (Climate Plan) adopted in 2004 was designed to meet both national planning needs and European Union reporting requirements (Virloouvot 2015) by strengthening measures to combat climate change, with for example the introduction of penalty and reward schemes in the transport sector and the implementation of local climate plans.

The following year, 2005, saw the adoption of the *Programme d'orientation de la politique énergétique* (POPE: Energy Policy Orientation Programme), known as the Factor 4 law. This legislation set the target of dividing greenhouse gas emissions by a factor of 4 by 2050 compared with 1990 levels and improving energy efficiency by 2% a year starting from 2015. This law therefore introduced two novel elements: a long-term target for emissions and an energy efficiency target. Consideration was given to breaking down this target by sector, with the creation of a *Commission Énergie* (Energy Committee) within the *Centre d'Analyse Stratégique* (CAS: Centre for Strategic Analysis attached to the Prime Minister's office) to assess medium- and long-term trajectories, i.e. for 2020 and 2050 (Syrota 2008). This committee was composed of researchers including members from modelling teams, representatives of trade unions, the private energy sector, and various ministries (industry, transport, agriculture, energy, and economy). The same structure was subsequently replicated in other committees in which we participated. This gave us the opportunity to bridge the gap between the various stakeholders involved in the issues raised by SDGs 7, 8, 9, 11 and 13 as different working groups defined the macroeconomic framework, the housing and mobility demand and the policy measures.

To provide relevant insights, we carried out, using our TIMES-FR model (Maïzi and Assoumou 2014), a series of five prospective exercises for this commission, in order to identify the major trends for 2050. These exercises evaluated different reduction scenarios by varying the hypotheses of the baseline scenario. The scenario had to comply with the laws and commitments already made by France, the 2005 law and the 2015 objectives featured in the PPE (multiannual energy plan). The first version was based on the following assumptions:

- high fossil fuel prices;
- maximum deployment of nuclear potential (in terms of feasibility and eligibility);
- technological progress without disruption;
- renewable resources limited to available potential;
- compliance with legislation;
- compliance with international commitments;
- maximum exploitation of insulation potential.

Four variants of this baseline scenario then reconsidered a number of elements that we used to carry out a sensitivity analysis. These involved:

- diminishing the voluntarist character of the first scenario by reducing the exploitation of insulation potential in the residential sector successively from 100% to 50% and then to 25%, with the effect of increasing useful demand in the residential sector;
- revising mobility demand downwards and lowering gas prices;
- testing, for the industrial sector, the hypothesis of an expansion of the services sector in French industry (or of relocation) and that of maintaining a certain level of industrial growth;
- varying the level of nuclear penetration, initially unlimited and then limited respectively to 90GW and 65GW of new potential installed capacity.

These new scenarios were constrained in terms of their CO₂ emissions (relative to 1990 levels, restricted to energy use and excluding emissions from international traffic). Whatever the hypotheses used, it was established that in these different scenarios, and to make conservative hypotheses on potential technological choices, the Factor 4 constraint was unattainable. Indeed, the following technologies were not allowed in our exercises to meet demand: CO₂ capture and sequestration, deep-rock geothermal, offshore wind, hydrogen vector. Renewable source potentials were limited by expert opinion. This minimalist vision of technological progress enabled us to clarify the future in the sense of a lower threshold, which could only be improved if it turned out that one of the discarded technologies could be deployed with an acceptable cost/effectiveness ratio.

For two of our exercises, the factor 4 constraint is only possible at the expense of irrational choices, such as stopping industrial production in the steel, glass and ammonia industries. In our TIMES modelling exercise, this corresponds to an optimal solution which favours importing the quantities needed to satisfy useful demand in order to externalise CO₂ emissions so as to satisfy the Factor 4 constraint. This impossibility of determining a technological choice that satisfies the constraint is reflected in the marginal costs associated with one tonne of CO₂ avoided, which in all these exercises, often from 2020 onwards, exceed several thousand euros, indicating the failure to find a coherent solution (Table 1).

It then became clear that the trend would not allow France to achieve a CO₂ emissions reduction factor in line with the law's objective without a significant change in direction, even when varying a voluntary useful demand, as we had envisaged for the transport and residential sectors, and maintaining the industrial

Table 1 Evolution of the marginal cost of abatement per tonne of CO₂ avoided with a division by 2 (F2), by 3 (F3), by 4 (F4) of CO₂ emissions regarded as 1990 levels in 2050 for the BAU scenario

Marginal Cost €/tCO ₂	2015	2020	2025	2030	2035	2040	2045	2050
F4	44	82	490	1318	5094	9916	19,700	29,627
F3	45	110.2	456	505	1578	2443	5124	9927
F2	41	103.5	255	257	228	176	229	449

Note: It assumes limited nuclear with 58 PWR = 90 GW, residential: insulation potential 75%, transportation: greater efficiency = road freight 30%, aviation 20%, modal transfers

sector at a reasonable level of competitiveness. Furthermore, given the set of hypotheses we had agreed to restrict ourselves to, our analyses show that factor 2 appears to be a potential target in terms of reducing CO₂ emissions. One of the scenarios considered (Table 1), with marginal costs of the order of a few hundred euros, offers options for:

- the electricity generation mix, with the penetration of wind power and biomass (wood-fired power stations) balancing out a reduced nuclear capacity;
- the transport sector halving its emissions thanks to technologies based on biofuels and NGVs (Natural Gas Vehicles), which will gain significant ground from 2020 onwards;
- the residential/tertiary and energy sectors achieving a factor of 3;
- the industrial sector halving its emissions, notably by substituting electricity for non-specific gas uses.

From our recommendations, the Commission reported the following in 2008: “By 2050, given the need for growth, it seems difficult to achieve anything better than a factor of 2.5, unless we start integrating breakthrough technologies that were not selected because deemed very unlikely. To go beyond that, towards factor 4, we would have to, on the one hand, fundamentally change our behaviour and all our organisational processes and, on the other hand, rely on technological advances that are difficult to predict.” (Syrota 2008).

This is an example of concise policy-oriented statements aiming to synthesize the insights of a long series of scenario construction and modelling. Reading this statement today clearly shows the multiple SDG industrial, economic, and societal implications that were already present. However, we also have to acknowledge that very little was concretely implemented to influence behaviour, consumption, daily life, work and production.

3.4 Fukushima and Nuclear Power in France

From 2007 onwards, France gradually changed its approach to energy policy (Andriosopoulos and Silvestre 2017) and the energy issue began to be increasingly taken into account in climate policy, with the opening of debates that led to the

adoption of the Grenelle 1 and 2 laws (2009 and 2010) detailing the sectoral objectives for implementing the policy to tackle climate change. Once again, many measures from previous Climate Plans that had not been implemented were recovered and integrated (Millot 2019). In addition, the content of the Grenelle laws was largely dictated by the need to comply with European legislation (Lacroix and Zaccai 2010). In that regard, the adoption of the *Paquet Énergie Climat* (Climate Energy Package) in 2008 had a structuring role for French energy policy.

In 2011, we took part in the work of the Besson Commission on the future of the French energy system, using our France model to explore several scenarios for the development of the French energy mix at the 2050 horizon.

Here again, we produced a thorough analysis of the power sector with TIMES-FR (Maïzi and Assoumou 2007) from which elements in terms of industrial policy, operation of the power system, and consumption issues were not exploited by decision-makers. Figure 2 compared for instance the cumulated new capacity for the power sector required by 2050 in a Business-as-usual case and a politically decided progressive (PROG) and fast (FAST) nuclear phase-out. It further combines these elements with a carbon tax (t1) case or an emission limit in volume (v1).

Our contribution concluded with the following recommendations in Syrota (2008): “there are a number of findings that seem to us to be lasting and robust, whatever the technological options adopted:

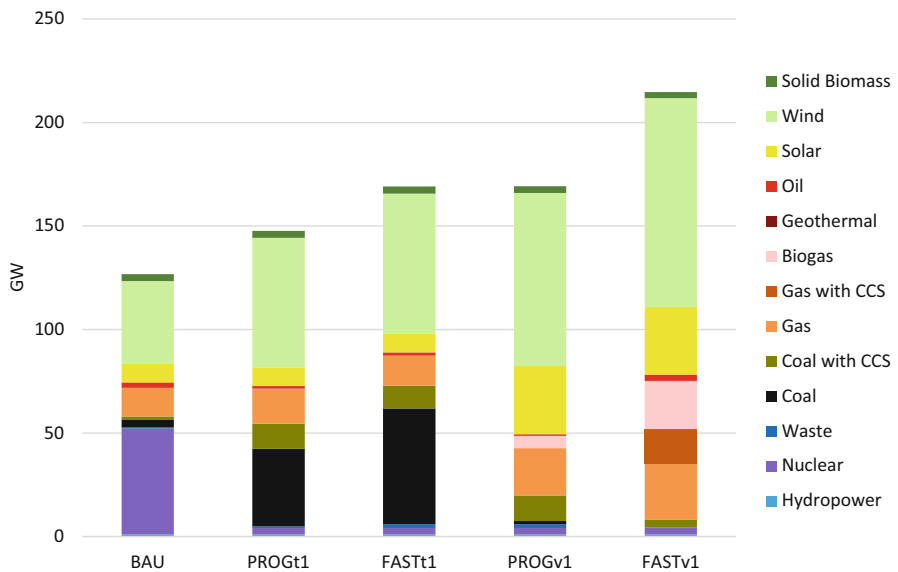

Fig. 2 New installed capacities cumulated over the horizon. *Note:* Cases are BAU (Business-as-usual case), a politically decided progressive (PROG) and fast (FAST) nuclear phase-out, combined with a carbon tax (t1) case or an emission limit in volume (v1)

- the cliff effect puts the French electricity system up against the wall: sustained investment will be needed to renew an electricity generation fleet that is reaching the end of its life;
- this situation opens up opportunities for all industrial sectors, the main challenge of which will be to sustain an ambitious rate of construction of new capacity, with specific issues, including acceptability and reliability;
- at the same time, if environmental issues are to remain high on the public policy agenda, the current paradigm of increasing electricity consumption will have to be challenged in the coming decades;
- these factors suggest that the question of long-term energy policy options cannot be defined solely in terms of technological choice and must go beyond the framework of pro- or anti-nuclear opposition.

This contribution, which is mainly a technical reflection, should be part of a wider debate on social and behavioural choices. It will be essential to involve users of electric vehicles in this debate.”

However, the conclusions of this report (Syrota 2008), as widely disseminated in the press, will only be remembered for their narrow focus on the issue of the potential extension of the life expectancy of power stations to 60 years. As pointed out in a press article (Lingaard 2012), “almost a year after the Fukushima accident, the Energies 2050 report wants to turn the page on the questioning of the atomic energy industry”. Therefore, the results of the proposed prospective exercises were not used to draw up a genuine energy programming plan.

3.5 Carbon Tax and Quinet Commission

At the end of the National Debate on Energy Transition (DNTE) launched in 2012, the *Loi de transition énergétique pour la croissance verte* (LTECV: Law on Energy Transition for Green Growth) was enacted. The green growth concept, originating from the *Grenelle de l'environnement* summit, was adopted as the main objective of the law. Economic growth therefore remains the main indicator of public policy performance, while the environment and ecological issues are seen as growth drivers aligned with SDG8 and SDG9. There is therefore no fundamental questioning of the mode of development. From this perspective, it seems difficult to seek to change lifestyles, and the measures promoted by the ministry focus more often than not on the supply side and the technological aspect, and less on the demand for energy services. Despite this context, we conducted different studies that questioned drivers of human behaviour to address demand-side mitigation policies. Relevant lessons were drawn from these studies regarding behaviour (Cayla et al. 2011; Cayla and Maïzi 2015), degrowth options (Briens 2015), and lifestyle (Le Gallic et al. 2017; Millot et al. 2018). While similar underlying hypotheses to the ones we used were used for several alternative scenarios for achieving SDGs 8, 10 and 11, decision-makers made scant use of them.

Indeed, the main way to integrate climate change action (SDG 13) into national policies in France relied on carbon value, as shown by the implementation of a carbon tax in the LTECV, whose pathway aligned with the Quinet Commission's recommendation. A previous attempt to introduce a carbon tax in the Grenelle laws of 2009 was rejected by the *Conseil constitutionnel* (Constitutional Council). However, the Quinet Commission, comprising several experts, gathered in 2008 to assess the shadow price of carbon and produced a report in 2009 recommending a progressive carbon tax, reaching €100/tCO₂ by 2030 and €200/tCO₂ by 2050 (Quinet 2008). This carbon value was established so that all public projects and all public decisions would henceforth be arbitrated by integrating their cost for the climate, i.e. their carbon cost. We participated in this effort, providing a thorough analysis of how carbon value could be a key driver to support mitigation pledges (Assoumou and Maïzi 2011).

Ten years later, as the yellow vest movement erupted, the Quinet Commission *Deux* (two) was again called on to assess the tutelary value of carbon, used for the socio-economic evaluation of public investments (Quinet 2019). In our contribution to this report, we used our TIMES-FR model to assess the pathway of the tutelary value of carbon to achieve carbon neutrality.

The marginal abatement cost of CO₂ is illustrated in Fig. 3 for two scenarios, which both achieve carbon neutrality by 2050 for France. However, the hypothesis behind the availability of carbon sinks leads to different constraints for the energy system represented in TIMES-FR. Under the low assumption, the carbon sink amounts to 75 MtCO₂ while in the high scenario, it reaches 95 Mt. CO₂. Consequently, the two scenarios give rise to two different energy systems, resulting in different total final energy consumption (Fig. 4).

However, some scenarios assessed with our model either led to infeasibilities or to marginal cost values well above €7000/tCO₂. These scenarios reflected some

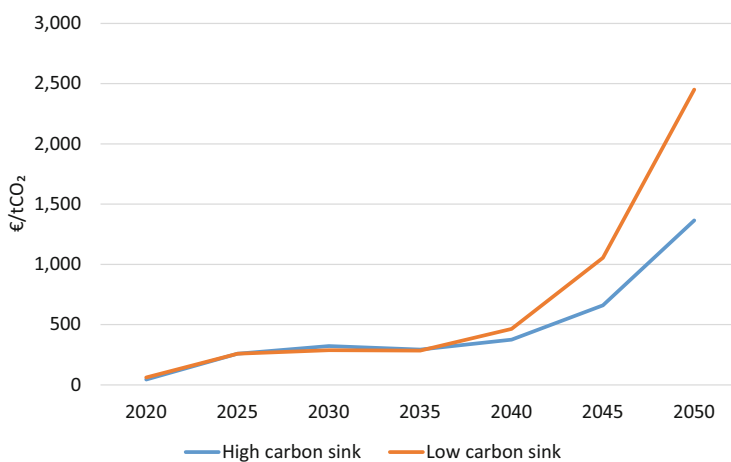

Fig. 3 Evolution of the marginal abatement cost of CO₂ with TIMES-FR for two scenarios

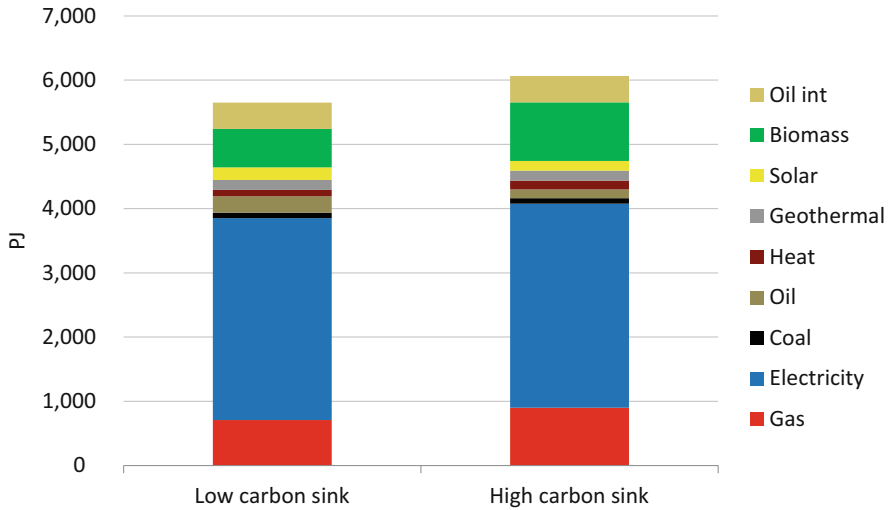

Fig. 4 Final energy consumption by 2050 with TIMES-FR for two scenarios

constraints on the availability of some technologies or the lower potential of carbon sinks and were not selected for the final report, which focused on scenarios with more acceptable values for the marginal cost of CO₂. The final figures presented by the Quinet Commission amounted to €250/tCO₂ in 2030 and €775/tCO₂ in 2050, values accepted as consensual, taking into account the disparity in the results of the different models used.

4 Conclusion on the Difficulty of Getting Key Messages Across

The chronicle of the prospective exercises we have developed testifies to the various challenges raised by France around SDGs 7, 8, 9, 11 and 13, which successively sought to divide its GHG emissions by 4 by 2050 (compared to 1990 levels) in the 2007 Syrota report, considered phasing out nuclear, implementing 100% renewables and reliability issues in the 2011 Besson report, then went on to assess carbon value in the 2018 Quinet commission to establish a climate value for action.

Through our involvement in these various government committees, we have measured the gap between:

- on the one side, our point of view as modellers wanting to shed light on the future through prospective analyses based on the TIMES model used as a prospective tool to obtain normative information from energy scenario analyses. This model's explicit formulation of the input-output relationships for each technology can be

applied to a horizon of several decades and a given final demand in order to minimise a discounted overall cost and obtain the corresponding levels of activity and investment required to create a virtual economy in which the various technologies can compete. The extensive results obtained in this way make it possible, in line with the philosophy of foresight, to work on building the future by considering measures reflecting different policies, measures or incentives;

- on the other side, the position of a pragmatic, modern decision-maker who may have less lofty aspirations for the future and may simply seek to minimise any short- or medium-term dissatisfaction resulting from difficult choices on somewhat worrying technical issues among numerous societal priorities. In this quest for immediacy, such decision-makers are reluctant to take into account all the weak signals that prospective analysis can offer, and tend to focus on specific elements, neglecting the wealth of lessons that could be learned.

In terms of energy policy objectives (SDG7), this latter issue has been clearly demonstrated since the 2000s, as energy policy has followed a cycle of around 5 years. Two to three years after the adoption of a law, a new consultation lasting 1 or 2 years is launched, leading to the adoption of new objectives and a new law. The latest law adopted in 2019 enacted the target of carbon neutrality and a new law is currently under discussion (2024). As Virlovet (2015) points out, “all national climate planning documents begin by stating that the results of the previous plan have not been achieved”. Many documents also repeat old measures from previous plans. For example, the economic instruments announced in the PNLCC 2000 (National Programme to Combat Climate Change) were not implemented but were taken up again in the 2004 and 2009 Climate Plans. Regarding the process of drafting the law, the Grenelle was a turning point in the consideration of the climate issue in energy policy (Virlovet 2015) and introduced a process of consultation with the various stakeholders. This process has been strengthened by the DNTE (National Debate on Energy Transition).

Monitoring of the objectives of the *Loi Énergie Climat* (Energy and Climate law) is scattered among several documents produced by the Ministry, which makes it difficult to understand the progress of the transition. For example, the commitments made in previous laws are not specifically monitored. As far as emissions are concerned, the 2020 target has been met, but the current reduction rate is not aligned with the rate needed to achieve carbon neutrality by 2050. On the other hand, the reduction in final energy consumption is not in line with the commitments made. In particular, the POPE law target for final energy intensity has not been met.

While we understand this difficulty of dealing with urgency combined with the idea of achieving a desirable future (namely in line with SDGs), we strongly recommend considering the use of prospective to enlighten decision-makers who take the climate issue seriously. Indeed, they can only adopt a feasible plan by adhering to this foundation of prospective disciplines, which establishes the close link between the future and action and is based on the fundamental idea that the future is not to be endured, as a fatalistic posture implies, but rather to be built. In these times of climate emergency, this is a message that needs to be revived: to look

at the long term to decide on the strategy to be deployed. In the absence of an enlightened approach, the climate issue tends to be governed by clumsy and ineffective sweeping measures.

Our prospective exercise using the TIMES model is in line with this philosophy but struggles to be adopted by decision-makers. However, in the story we have just told and beyond, we have measured that our impact (as members of the scientific community), although delayed, has sometimes penetrated the decision-making sphere. For example, the question of how the penetration of renewable energies has impacted the reliability of the electricity system (Drouineau et al. 2015), the debate on our lifestyles (Cayla et al. 2011) and the increasing scarcity of critical materials (Boubault and Maïzi 2019) are all prospective subjects that have finally found their way into the public debate and serve the related SDG7, SDG9 and SDG13. These are signs that, despite the difference in perspectives, the dialogue is constructive.

Moreover, climate prospective, since it concerns all sectors and combines many issues (economic, societal, technical, political, financial, legal, strategic, etc.), cannot be carried out employing a single type of model, nor using only models, since there are many causal loops.

Ultimately, what we are discussing here is the art of deciding, because, like French mathematician and philosopher Blaise Pascal, we believe that it is impossible to work on effective thinking without exercising climate prospective, both in order to shed light on how to envisage mitigation and adaptation options, and to ensure that the solutions of some do not become the problems of others.

References

- Assoumou E, Maïzi N (2011) Carbon value dynamics for France: a key driver to support mitigation pledges at country scale. *Energy Policy* 39(7):4325–4336
- Berger G, de Bourbon-Busset J, Massé P (2007) *Textes fondamentaux de la prospective française 1955–1966*, L'Harmattan
- Boubault A, Maïzi N (2019) Devising mineral resource supply pathways to a low-carbon electricity generation by 2100. *Resources* 8(1):33. <https://doi.org/10.3390/resources8010033>
- Briens F (2015) *La Décroissance au prisme de la modélisation prospective: Exploration macroéconomique d'une alternative paradigmatique*. Phd thesis, Ecole Nationale Supérieure des Mines de Paris
- Cayla J-M, Maïzi N (2015) Integrating household behavior and heterogeneity into the TIMES-households model. *Appl Energy* 139:56–67. issn 0306-2619
- Cayla J-M, Maïzi N, Marchand C (2011) The role of income in energy consumption behaviour: evidence from French households data. *Energy Policy* 39(12):7874–7883. issn 0301-4215. <https://doi.org/10.1016/j.enpol.2011.09.036>
- Colasse B, Pallé F, Riveline C (1995) Une pédagogie médiévale pour enseigner la gestion. *Annales des Mines Gérer et Comprendre* 38:14–32
- Dantzig GB (1963) *Linear programming and extensions*. Princeton University Press
- Drouineau M, Assoumou E, Mazauric V, Maïzi N (2015) Increasing shares of intermittent sources in Reunion Island: impacts on the future reliability of power supply. *Renew Sust Energ Rev* 46. <https://doi.org/10.1016/j.rser.2015.02.024>

- Le Gallic T, Assoumou E, Maïzi N (2017) Future demand for energy services through a quantitative approach of lifestyles. *Energy*. <https://doi.org/10.1016/j.energy.2017.07.065>
- Lingaard J (2012) Le rapport Besson sur l'énergie plaide pour une prolongation du nucléaire, www.mediapart.fr (online media)
- Maïzi N (2012) De la dimension infinie à la dimension prospective variations autour du paradigme d'optimalité, Habilitation à Diriger les Recherches, Université de Nice Côte d'Azur
- Maïzi N, Assoumou E (2007) Modélisation prospective et spécificités de la politique énergétique française. *J3eA Journal sur l'enseignement des sciences et technologies de l'information et des systèmes* 6
- Maïzi N, Assoumou E (2014) Future prospects for nuclear power in France. *Appl Energy* 136:849–859
- Massé P (1991) *Le Plan ou l'anti-hasard* (new edn). Hermann
- Millot A. (2019) Faire la transition énergétique bas-carbone ou comment réaliser l'avènement d'un mythe? Phd thesis, Ecole Nationale Supérieure des Mines de Paris
- Millot A, Doudard R, Le Gallic T, Briens F, Assoumou E, Maïzi N (2018) France 2072: lifestyles at the core of carbon neutrality challenges. In: Giannakidis G, Karlsson K, Labriet M, Gallachoir B (eds) *Limiting global warming to well below 2 C: energy system modelling and policy development*, Lecture notes in energy, vol 64. Springer
- Quinet A (2008) La Valeur tutélaire du carbone, rapport de la commission présidée par Alain Quinet, Centre d'analyse stratégique, Paris, La Documentation française
- Quinet A (2019) La valeur de l'action pour le climat: une valeur tutélaire du carbone pour évaluer les investissements et les politiques publiques, Rapport de la commission présidée par Alain Quinet, France Stratégie. La Documentation française
- RAND (2023) A brief history of RAND. <https://www.rand.org/about/history.html>. Last visited 11 Oct 2023
- RED TEAM (2021). <https://redteamdefense.org/en/home>. Last visited 11 Oct 2023
- Syrota J (2008) Perspectives énergétiques de la France à l'horizon 2020–2050 Rapport de la Commission Energie. La Documentation Française, Paris. isbn: 978-2-11-007090-6
- Virlovet G (2015) Vingt ans de lutte contre le réchauffement climatique en France: bilan et perspectives des politiques publiques. Les avis du Conseil Économique, Social et Environnemental 41115-0012. Conseil Économique, Social et Environnemental, Paris. isbn: 978-2-11-138660-0

Open Access This chapter is licensed under the terms of the Creative Commons Attribution 4.0 International License (<http://creativecommons.org/licenses/by/4.0/>), which permits use, sharing, adaptation, distribution and reproduction in any medium or format, as long as you give appropriate credit to the original author(s) and the source, provide a link to the Creative Commons license and indicate if changes were made.

The images or other third party material in this chapter are included in the chapter's Creative Commons license, unless indicated otherwise in a credit line to the material. If material is not included in the chapter's Creative Commons license and your intended use is not permitted by statutory regulation or exceeds the permitted use, you will need to obtain permission directly from the copyright holder.



Correction to: Aligning the Energy Transition with the Sustainable Development Goals



Maryse Labriet, Kari Espegren, George Giannakidis,
and Brian Ó Gallachóir

Correction to:

M. Labriet et al. (eds.), *Aligning the Energy Transition with the Sustainable Development Goals*, Lecture Notes in Energy 101, <https://doi.org/10.1007/978-3-031-58897-6>

The book “Aligning the Energy Transition with the Sustainable Development Goals”, written by Maryse Labriet, Kari Espegren, George Giannakidis, and Brian Ó Gallachóir, was originally published electronically on the publisher’s internet portal on 11th June 2024 without open access. With the author(s)’ decision to opt for Open Choice the copyright of the book changed on 3rd Oct 2023 to © The Editor(s) (if applicable) and The Author(s), under exclusive license to Springer Nature Switzerland AG 2024 and the book is forthwith distributed under a Creative Commons Attribution CC BY 4.0. ETSAP (Energy Technology Systems Analysis Program), Institute for Energy Technology (IFE), System Analysis – ETSAP, Instituttveien 18, 2027 Kjeller, Norway.

The updated version of this book can be found at
<https://doi.org/10.1007/978-3-031-58897-6>

© The Author(s) 2024
M. Labriet et al. (eds.), *Aligning the Energy Transition with the Sustainable Development Goals*, Lecture Notes in Energy 101,
https://doi.org/10.1007/978-3-031-58897-6_17

Open Access This chapter is licensed under the terms of the Creative Commons Attribution 4.0 International License (<http://creativecommons.org/licenses/by/4.0/>), which permits use, sharing, adaptation, distribution and reproduction in any medium or format, as long as you give appropriate credit to the original author(s) and the source, provide a link to the Creative Commons license and indicate if changes were made.

The images or other third party material in this chapter are included in the chapter's Creative Commons license, unless indicated otherwise in a credit line to the material. If material is not included in the chapter's Creative Commons license and your intended use is not permitted by statutory regulation or exceeds the permitted use, you will need to obtain permission directly from the copyright holder.

