

Exploring the Potential of Compressive Sensing Payloads for Earth Observation from Geostationary Platforms: An Instrumental Concept for Fire Monitoring

*Original*

Exploring the Potential of Compressive Sensing Payloads for Earth Observation from Geostationary Platforms: An Instrumental Concept for Fire Monitoring / Borrelli, Donato; Baldi, Massimo; Berndt, Dirk; Bertoncini, Lucas; Bianchi, Tiziano; Bischof, Lionel; Borque Gallego, Guzman; Carlà, Roberto; Coppo, Peter; Corti, Chiara; Corti, Francesco; Corti, Marco; Cox, Nick; Dauderstädt, Ulrike A.; Dürr, Peter; Franci, Enrico; González, Sara Francés; Gonnelli, Andrea; Guerri, Irene; Guzzi, Donatella; Humbert, Stéphane; Labate, Demetrio; Lamquin, Nicolas; Lastri, Cinzia; Magli, Enrico; Marzi, Emiliano; Migliorati, Andrea; Nardino, Vanni; Pache, Christophe; Palombi, Lorenzo; Piccirillo, Alice Maria; Pilato, Giuseppe; Suetta, Enrico; Taddei, Dario; Valsesia, Diego; Wagner, Michael; Raimondi, Valentina. - In: ENGINEERING PROCEEDINGS. - ISSN 2673-4591. - ELETTRONICO. - 51:1(2023), pp. 1-5. [10.3390/engproc2023051032]

*Publisher:*

MDPI

*Published*

DOI:10.3390/engproc2023051032

*Terms of use:*

This article is made available under terms and conditions as specified in the corresponding bibliographic description in the repository











*Publisher copyright*

(Article begins on next page)



Proceeding Paper

# Exploring the Potential of Compressive Sensing Payloads for Earth Observation from Geostationary Platforms: An Instrumental Concept for Fire Monitoring <sup>†</sup>

Donato Borrelli <sup>1</sup>, Massimo Baldi <sup>2</sup> , Dirk Berndt <sup>3</sup> , Lucas Bertoncini <sup>4</sup>, Tiziano Bianchi <sup>5</sup>, Lionel Bischof <sup>6</sup>, Guzman Borque Gallego <sup>6</sup>, Roberto Carlà <sup>2</sup>, Peter Coppo <sup>1</sup>, Chiara Corti <sup>7</sup>, Francesco Corti <sup>7</sup>, Marco Corti <sup>7</sup>, Nick Cox <sup>4</sup> , Ulrike A. Dauderstädt <sup>3</sup> , Peter Dürr <sup>3</sup>, Enrico Franci <sup>7</sup>, Sara Francesc González <sup>3</sup>, Andrea Gonnelli <sup>2</sup>, Irene Guerri <sup>1</sup>, Donatella Guzzi <sup>2</sup> , Stéphane Humbert <sup>6</sup>, Demetrio Labate <sup>1</sup>, Nicolas Lamquin <sup>4</sup>, Cinzia Lastri <sup>2</sup>, Enrico Magli <sup>5</sup> , Emiliano Marzi <sup>2</sup>, Andrea Migliorati <sup>5</sup>, Vanni Nardino <sup>2</sup> , Christophe Pache <sup>6</sup>, Lorenzo Palombi <sup>2</sup> , Alice Maria Piccirillo <sup>1</sup>, Giuseppe Pilato <sup>1</sup>, Enrico Suetta <sup>1</sup>, Dario Taddei <sup>7</sup>, Diego Valsesia <sup>5</sup> , Michael Wagner <sup>3</sup> and Valentina Raimondi <sup>2,\*</sup> 

- <sup>1</sup> LEONARDO S.p.A., 50013 Campi Bisenzio, Italy; donato.borrelli@leonardocompany.com (D.B.); peter.coppo@leonardocompany.com (P.C.); irene.guerri@leonardo.com (I.G.); demetrio.labate@leonardocompany.com (D.L.); alicemaria.piccirillo001@studenti.uniparthenope.it (A.M.P.); giuseppe.pilato@leonardocompany.com (G.P.); enrico.suetta@leonardocompany.com (E.S.)
  - <sup>2</sup> 'Nello Carrara' Institute of Applied Physics (IFAC), National Research Council (CNR), 50019 Sesto Fiorentino, Italy; m.baldi@ifac.cnr.it (M.B.); r.carla@ifac.cnr.it (R.C.); a.gonnelli@ifac.cnr.it (A.G.); d.guzzi@ifac.cnr.it (D.G.); c.laistri@ifac.cnr.it (C.L.); e.marzi@ifac.cnr.it (E.M.); v.nardino@ifac.cnr.it (V.N.); l.palombi@ifac.cnr.it (L.P.)
  - <sup>3</sup> Fraunhofer Institute for Photonic Microsystems (IPMS), 01109 Dresden, Germany; dirk.berndt@ipms.fraunhofer.de (D.B.); ulrike.dauderstaedt@ipms.fraunhofer.de (U.A.D.); peter.duerr@ipms.fraunhofer.de (P.D.); sara.francesc-gonzalez@ipms.fraunhofer.de (S.F.G.); michael.wagner@ipms.fraunhofer.de (M.W.)
  - <sup>4</sup> ACRI-ST, 06904 Sophia-Antipolis, France; lucas.bertoncini@acri-st.fr (L.B.); nick.cox@acri-st.fr (N.C.); nicolas.lamquin@acri-st.fr (N.L.)
  - <sup>5</sup> Department of Electronics and Telecommunications (DET), Politecnico di Torino, 10129 Torino, Italy; tiziano.bianchi@polito.it (T.B.); enrico.magli@polito.it (E.M.); andrea.migliorati@polito.it (A.M.); diego.valsesia@polito.it (D.V.)
  - <sup>6</sup> Centre Suisse d'Électronique et Microtechnique (CSEM), 2002 Neuchâtel, Switzerland; lionel.bischof@csem.ch (L.B.); guzman.borquegallego@csem.ch (G.B.G.); stephane.humbert@csem.ch (S.H.); christophe.pache@csem.ch (C.P.)
  - <sup>7</sup> SAITEC srl, 50063 Figline Valdarno, Italy; chiara.corti@saitesrl.com (C.C.); francesco.corti@saitesrl.com (F.C.); marco.corti@saitesrl.com (M.C.); enrico.franci@saitesrl.com (E.F.); dario.taddei@saitesrl.com (D.T.)
- \* Correspondence: v.raimondi@ifac.cnr.it; Tel.: +39-055-5226379  
<sup>†</sup> Presented at the 17th International Workshop on Advanced Infrared Technology and Applications, Venice, Italy, 10–13 September 2023.



**Citation:** Borrelli, D.; Baldi, M.; Berndt, D.; Bertoncini, L.; Bianchi, T.; Bischof, L.; Borque Gallego, G.; Carlà, R.; Coppo, P.; Corti, C.; et al. Exploring the Potential of Compressive Sensing Payloads for Earth Observation from Geostationary Platforms: An Instrumental Concept for Fire Monitoring. *Eng. Proc.* **2023**, *51*, 32. <https://doi.org/10.3390/engproc2023051032>

Academic Editors: Gianluca Cadelano, Giovanni Ferrarini and Davide Moroni

Published: 7 November 2023



**Copyright:** © 2023 by the authors. Licensee MDPI, Basel, Switzerland. This article is an open access article distributed under the terms and conditions of the Creative Commons Attribution (CC BY) license (<https://creativecommons.org/licenses/by/4.0/>).

**Abstract:** Earth observation (EO) payload performances in the infrared spectral region from geostationary platforms are often limited by spatial resolution. In this paper, we investigate an instrumental concept leveraging a compressive sensing paradigm and super-resolution architecture to implement an EO payload from a geostationary platform aimed at the monitoring of wildfires with a nominal spatial sampling distance of 500 m. The core device of the instrument is a European-technology-based micromirror array under study for space applications. Besides payload specifications and working principles, the main critical aspects and the expected impact on EO applications are discussed.

**Keywords:** compressive sensing; super-resolution; earth observation; optical payload; spatial light modulator; medium infrared; fire detection

## 1. Introduction

Earth observation (EO) data have become ever more vital to our understanding of our planet and to monitor risks. However, applications are still limited by two main factors: revisit time and spatial resolution. In particular, EO payloads in the infrared spectral region from geostationary platforms typically have a spatial resolution limited to some kilometers, but with a frequent revisit time that is crucial for monitoring rapidly changing events like wildfires.

The EU-funded H2020 SURPRISE project—acronym for “Super-resolved compressive instrument in the visible and medium infrared for earth observation applications”—has investigated the potential of the compressive sensing (CS) paradigm for the development of a CS-based payload working in the visible (VIS), near-infrared (NIR), short-wavelength infrared (SWIR), and medium infrared (MIR) spectral ranges from geostationary platforms with enhanced performance in terms of at-ground spatial sampling, onboard processing, and encryption capabilities. The study included the design and construction of a laboratory demonstrator that used a commercial digital micromirror device (DMD) as the core element to implement a CS architecture [1,2]. The laboratory demonstrator, which had 10 spectral bands in the VIS-NIR and 2 spectral bands in the MIR, was exploited to investigate in detail the capabilities of the CS-based instrumentation to improve the performance of a EO payload working in these spectral regions and to outline a roadmap for the development of a CS-based payload for earth observation from a geostationary platform.

In this paper, we present the instrumental concept of an EO payload from geostationary platform—based on the CS paradigm and implementing a super-resolution architecture—specifically conceived for the monitoring of wildfires with a nominal spatial sampling of 500 m and a revisit time from some hours at a global scale to some minutes at a regional scale.

## 2. CS-Based Instrument Concept

The idea behind the concept of a CS-based EO payload is a single-pixel camera [3]. Figure 1 shows the working principle of a single-pixel camera: the image generated by the collection optics is modulated at the image plane by a spatial light modulator (SLM)—acting as a modulation mask—and the signal transmitted through the SLM is integrated by an optical condenser and focused on a single-element detector. A set of measurements—each corresponding to a different modulation mask applied to the image—is used to reconstruct the original image using suitable CS reconstruction algorithms [4,5].

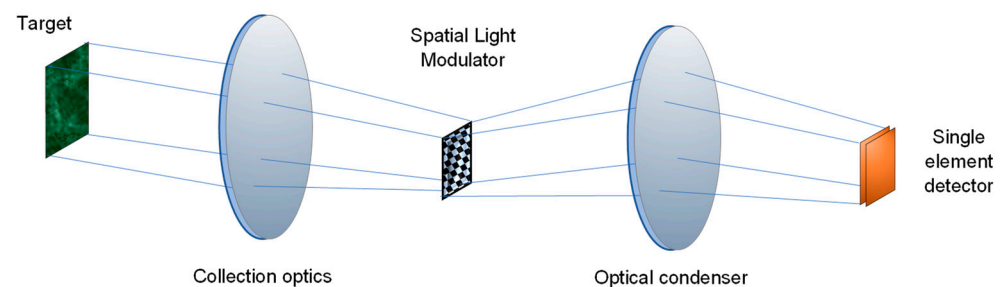

**Figure 1.** Working principle of a CS-based single-pixel camera.

In a CS-based instrument, the image can be efficiently reconstructed from a number of measurements smaller than the corresponding number of reconstructed image pixels. According to CS theory, a detector with a number of pixels equal to  $n$  can be substituted with a single-pixel camera that executes  $p \times n$  measurements, where  $p$  usually ranges from 0.1 to 0.5. The quality of the reconstructed image depends on the value of  $p$ . A CS-based system performs an inherently compressed acquisition, merging the acquisition and the compression steps in a single step. As a consequence, a data compression board—typically used to reduce the amount of data to be stored or transmitted—is not needed any longer

since the data are acquired compressed natively. The use of a modulation mask applied to the image plane for each measurement also paves the way to native encryption.

### 3. Instrument Requirements and Payload Architecture

Table 1 reports the main observational and spectral requirements for a CS-based payload for wildfires monitoring from geostationary platform.

**Table 1.** Main requirements for a geostationary CS payload for fire monitoring.

Parameter	Value
Orbit type	Geostationary
Orbit altitude	35,786 Km
Acquisition mode	Whiskbroom, Step-Stare
Spectral range	0.4–0.9 $\mu\text{m}$ (VIS)
	[1.6, 2.2] $\mu\text{m}$ (SWIR)
	[3.74] (MWIR2)
Number of spectral bands (minimum)	4 bands in the VIS; 2 in the SWIR; 1 in the MWIR
Spatial sampling (nominal)	500 m
Instrument footprint	16 Km $\times$ 16 Km

It is worth noting that a payload operating from a geostationary orbit offers the additional advantage of an almost-still-Earth scenario, which is particularly suitable for the compressive sensing acquisition mode since the latter requires the acquisition of a series of measurements of the (almost same) target (the target is meant as the area corresponding to the instrument footprint) in order to obtain the final image reconstructed. The acquisition of the entire scene—at a global, regional, or local scale—is achieved by using a bidimensional scan mirror mechanism (E-W and N-S directions). The time required for the stabilization after each microstep of the scan mirror (settling time) is the driving factor in the estimate of the time required for the acquisition of a full scene. Preliminary estimates yield a revisit time of some hours at a synoptic scale and a few minutes at local–regional scale.

According to the requirements shown in Table 1, the instrument should cover a very wide spectral range, from the VIS up to 4  $\mu\text{m}$ . In order to achieve a nominal spatial sampling of at least 500 m, a pupil diameter of about 350 mm is required, which in turn needs a large pointing mirror, due to a working inclination of 45° with respect to the Nadir.

Figure 2 shows the basic architecture of the EO payload concept that fulfil the requirement of operation in a wide spectral range from VIS to MIR. A MicroMirror Array (MMA) consisting of a 32  $\times$  32 matrix of 16  $\mu\text{m}$  pitch micromirrors is used as the SLM. The instrument relies on a single common collimator positioned after the SLM before the spectral splitting stage between the MWIR channel (MWIR 2) and the VIS-SWIR channels. The spectral splitting is achieved by using dichroic filters. The detection system is configured as a single-element detector based on photovoltaic (PV) silicon detectors for the VIS and NIR bands (from 0.4  $\mu\text{m}$  to 1.0  $\mu\text{m}$ ), while HgCdTe PV detectors are used for the SWIR/MIR bands.

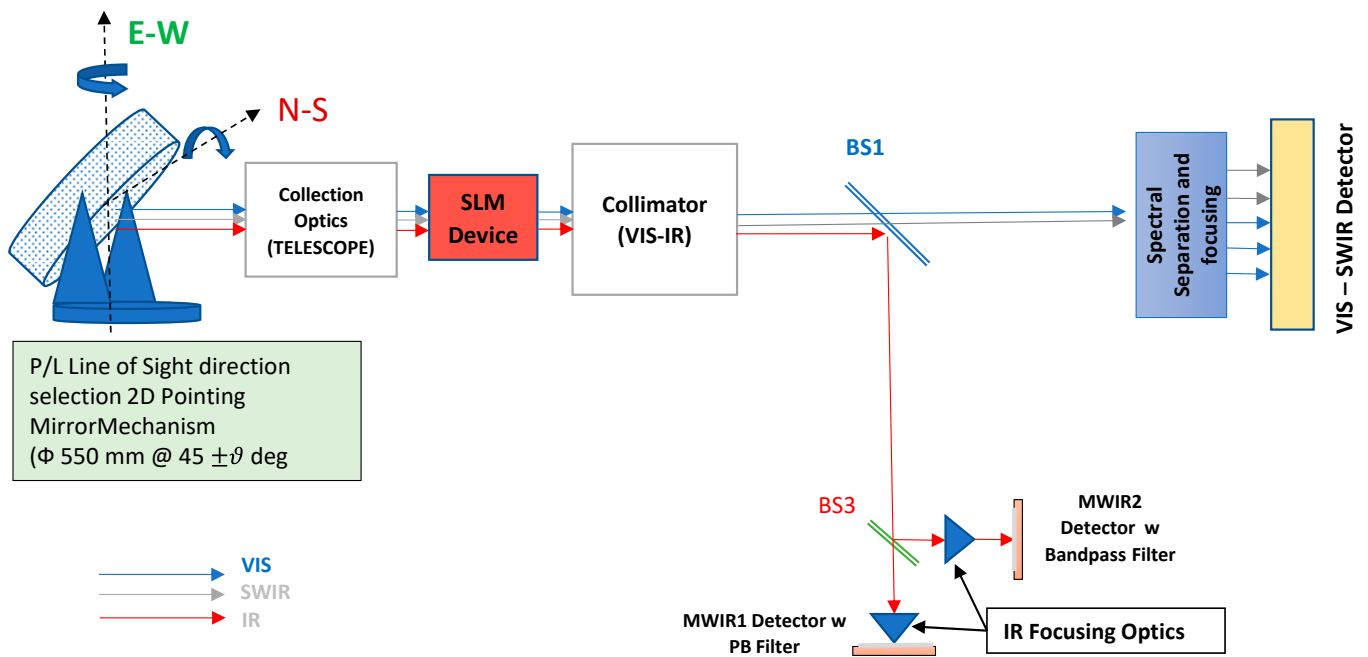

**Figure 2.** CS-based EO payload concept for whiskbroom operation from a geostationary platform.

#### 4. Conclusions

CS-based architectures for EO payloads from geostationary platforms can provide interesting features useful for enhancing their performances in terms of spatial sampling, compression, and encryption features. Here, we present a concept of a CS-based EO payload operating from a geostationary platform for fire monitoring with a spatial sampling of 500 m and frequent revisit time, from some hours at a synoptic scale to a few minutes at a local–regional scale. Next steps include outlining a development roadmap to identify the most critical aspects, solutions available, and possible technological development needed.

**Author Contributions:** Conceptualization, D.B. (Donato Borrelli), P.C., I.G., D.L., A.M.P., G.P., E.S., M.B., R.C., A.G., D.G., C.L., E.M. (Emiliano Marzi), V.N., L.P., V.R., D.B. (Dirk Berndt), U.A.D., P.D., S.F.G., M.W., L.B. (Lucas Bertoncini), N.C., N.L., T.B., E.M. (Enrico Magli), A.M., D.V., L.B. (Lionel Bischof), G.B.G., S.H., C.P., C.C., F.C., M.C., E.F. and D.T.; methodology, D.B. (Donato Borrelli), P.C., I.G., D.L., A.M.P., G.P., E.S., M.B., R.C., A.G., D.G., C.L., E.M. (Emiliano Marzi), V.N., L.P., V.R., T.B., E.M. (Emiliano Marzi), A.M. and D.V.; software, D.B. (Donato Borrelli), P.C., I.G., D.L. and A.M.P.; validation, D.B. (Donato Borrelli), P.C., I.G., D.L., A.M.P., G.P., E.S., M.B., R.C., D.G., C.L., V.N., L.P., V.R., T.B., E.M. (Emiliano Marzi), A.M. and D.V.; formal analysis, D.B. (Donato Borrelli), P.C., I.G., D.L. and A.M.P.; validation, D.B. (Donato Borrelli), P.C., I.G., D.L., A.M.P., G.P. and E.S.; investigation, D.B. (Donato Borrelli), P.C., I.G., D.L., A.M.P., D.G., L.P., C.L., V.N. and V.R.; resources, E.S. and V.R.; data curation, D.B. (Donato Borrelli), P.C., I.G., D.L. and A.M.P.; validation, D.B. (Donato Borrelli), P.C., I.G., D.L., A.M.P., G.P. and E.S.; writing—original draft preparation, D.B. (Donato Borrelli), I.G., A.M.P., D.G., C.L., E.M. and V.R.; writing—review and editing, D.B. (Donato Borrelli), D.G. and V.R.; visualization, D.B. (Donato Borrelli), I.G., A.M.P., D.G., E.M. and V.R.; supervision, D.B. (Donato Borrelli), E.S., E.M. and V.R.; project administration, E.S. and V.R.; funding acquisition, E.S. and V.R.; All authors have read and agreed to the published version of the manuscript.

**Funding:** This research was funded by the European Union’s Horizon 2020 research and innovation program under Grant Agreement No 870390.

**Institutional Review Board Statement:** Not applicable.

**Informed Consent Statement:** Not applicable.

**Data Availability Statement:** No new data were created or analyzed in this study. Data sharing is not applicable to this article.

**Conflicts of Interest:** Authors Donato Borrelli, Peter Coppo, Irene Guerri, Demetrio Labate, Alice Maria Piccirillo, Giuseppe Pilato and Enrico Suetta were employed by the company Leonardo. Authors Chiara Corti, Francesco Corti, Marco Corti, Enrico Franci, and Dario Taddei were employed by the company SAITEC. Authors Lucas Bertoncini, Nick Cox, and Nicolas Lamquin were employed by the company ACRI-ST. The remaining authors declare that the research was conducted in the absence of any commercial or financial relationships that could be construed as a potential conflict of interest.

## References

1. Raimondi, V.; Baldi, M.; Berndt, D.; Bianchi, T.; Gallego, G.B.; Borrelli, D.; Corti, C.; Corti, F.; Corti, M.; Dauderstädt, U.A.; et al. Compressive Sensing Instrumental Concepts for Space Applications. In *Proceedings of the SPIE—The International Society for Optical Engineering*; SPIE: Bellingham, WA, USA, 2022; Volume 12136.
2. Raimondi, V.; Acampora, L.; Baldi, M.; Berndt, D.; Bianchi, T.; Borrelli, D.; Corti, C.; Corti, F.; Corti, M.; Cox, N.; et al. Designing a Compressive Sensing Demonstrator of an Earth Observation Payload in the Visible and Medium Infrared: Instrumental Concept and Main Features. *Eng. Proc.* **2021**, *8*, 27. [[CrossRef](#)]
3. Duarte, M.F.; Davenport, M.A.; Takhar, D.; Laska, J.N.; Sun, T.; Kelly, K.F.; Baraniuk, R.G. Single-pixel imaging via compressive sampling. *IEEE Signal Process. Mag.* **2008**, *25*, 83–91. [[CrossRef](#)]
4. Coluccia, G.; Lastri, C.; Guzzi, D.; Magli, E.; Nardino, V.; Palombi, L.; Pippi, I.; Raimondi, V.; Ravazzi, C.; Garoi, F.; et al. Optical Compressive Imaging Technologies for Space Big Data. *IEEE Trans. Big Data* **2020**, *6*, 430–442. [[CrossRef](#)]
5. Magli, E.; Bianchi, T.; Guzzi, D.; Lastri, C.; Nardino, V.; Palombi, L.; Raimondi, V.; Taricco, D.; Valsesia, D. Compressive imaging and deep learning based image reconstruction methods in the “SURPRISE” EU project. In *Proceedings of the European Workshop on On-Board Data Processing (OBDP2021)*, Online Event, 14–17 June 2021.

**Disclaimer/Publisher’s Note:** The statements, opinions and data contained in all publications are solely those of the individual author(s) and contributor(s) and not of MDPI and/or the editor(s). MDPI and/or the editor(s) disclaim responsibility for any injury to people or property resulting from any ideas, methods, instructions or products referred to in the content.