

FBG Thermal Response Analysis for Electro-Mechanical Components Monitoring in Aerospace Systems

*Original*

FBG Thermal Response Analysis for Electro-Mechanical Components Monitoring in Aerospace Systems / Aimasso, Alessandro; Dalla Vedova, Matteo; Maggiore, Paolo. - ELETTRONICO. - (2023). (Intervento presentato al convegno 33rd European Safety and Reliability Conference (ESREL 2023) tenutosi a Southampton (United Kingdom) nel 3 -7 Settembre 2023) [10.3850/978-981-18-8071-1\_p141-cd].

*Availability:*

This version is available at: 11583/2991498 since: 2024-08-05T13:53:41Z

*Publisher:*

RESEARCH PUBLISHING

*Published*

DOI:10.3850/978-981-18-8071-1\_p141-cd

*Terms of use:*

This article is made available under terms and conditions as specified in the corresponding bibliographic description in the repository

*Publisher copyright*

(Article begins on next page)

## FBG thermal response analysis for electro-mechanical components monitoring in aerospace systems

Alessandro Aimasso

*Department of Mechanical and Aerospace Engineering, Politecnico di Torino, Italy. E-mail: alessandro.aimasso@polito.it*

Matteo D.L. Dalla Vedova

*Department of Mechanical and Aerospace Engineering, Politecnico di Torino, Italy. E-mail: matteo.dallavedova@polito.it*

Paolo Maggiore

*Department of Mechanical and Aerospace Engineering, Politecnico di Torino, Italy. E-mail: paolo.maggiore@polito.it*

Electromechanical components are widely used in aerospace systems and must meet strict reliability, safety, and environmental requirements. On the other hand, Fiber Bragg Grating (FBG) sensors are particularly advantageous to monitor specific physical parameters, like temperature or strain, due to their small size, low weight, high sensitivity, electrical passivity, and immunity to electromagnetic interference. The current study examines the performances of FBGs, enhancing their ability to read short-term thermal transients and comparing it to that of a conventional thermal probe (PT100). At first, instrumentation was placed in a climatic chamber and subjected to different thermal cycles. Specifically, an experimental set-up was developed to compare FBG's sensitivity under different fiber integration strategies. The different solutions implemented considered sensors independently from supports influence and when placed in simple example of packaging. In a second time, both environmental and punctual thermal transients were considered. The performances of the various solutions adopted were duly compared and supported by statistical analysis. Tests have shown that optical sensors have an extremely high sensitivity and a much shorter reaction time if compared to the PT100 probe. Moreover, it resulted that when FBG are integrated in other material, they are able to detect their support's temperature de facto in real time. Data collected by this work allow to consider strategic the use of FBG for thermal monitoring using a minimally invasive and extremely accurate technology.

*Keywords:* aerospace, Fiber Bragg Gratings, FBG, onboard system, optical fibers, prognostics, sensors network, smart sensor, temperature probe, thermal measurements, actuators, electro-mechanics, safety, reliability.

### 1. Introduction

Electromechanical components and, more specifically, actuators (EMAs), are emerging as an innovative technology for present and future flight control systems. Because they immediately transform electrical power into the mechanical power required to move the flight control surfaces (Taha n.d.; Deng, Foo, and Bhattacharya 2014), they have permitted the development of More Electric (Quigley 1993) and All Electric Aircraft (Howse 2003) concepts. As Garriga, Ponnusamy, and Mainini (2018) point out, broad integration of EMAs in aircraft systems would remove the requirement for a centralised hydraulic system, also guaranteeing a decrease in overall aircraft

empty weight, with benefits in terms of fuel consumption and operational costs.

A traditional EMA architecture is composed by several parts (Fig. 1): the electric motor, with its Power Drive Electronics, is linked to the user and external load through a reducer. Then, an ordinary or planetary gearbox is often attached to a mechanism for converting rotary to linear motion, either a ball-screw or a roller-screw.

Brushless Direct Current (BLDC) motors or Permanent Magnet Synchronous Motors (PMSMs) are the most often used electrical machinery for aircraft EMAs, in consideration of their excellent power-to-weight ratio and dependability (Weimer 2003)

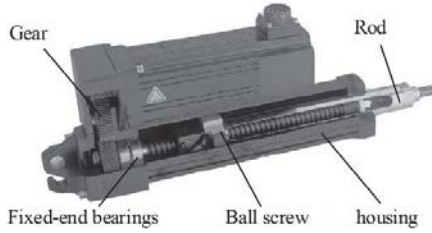

Figure 1. General EMA structure

EMAs are characterized by features that set them apart from other actuation systems. The lack of a hydraulic circuit, whether centralised or local, eliminates all problems associated with hydraulic fluid management during the product's entire lifespan. As a result, as Cronin (2012) discusses, maintenance interventions on EMAs are significantly easier.

Moreover, a great advantage of EMAs is their adaptability to small and low power applications: for example, they are widely used for flight controls on small UAVs, with some actuators weighing only a few grammes. Hydraulic systems cannot satisfy these so strict requirements in terms of miniaturisation.

However, there are certain drawbacks related to electromechanical devices use (Yin et al. 2022). For starters, their power density is substantially lower if compared to hydraulic systems. Moreover, hydraulic power actuators use the working fluid as a heat sink, while EMAs do not have this option. Thus, one of their biggest limits is represented by overheating, hence making their thermal management safety critical (Madonna et al. 2020). In fact, overheating could cause a failure occurring to the entire EMA and, when it is operating in a flying control system, it may cause the loss of the related aerodynamic surface, with potential catastrophic consequences (Missala 2014). As a result, precise and robust activities of prognostics and health monitoring are crucial in order to introduce such technologies into future aircraft designs. More precisely, to properly thermally monitor the operation of an electromechanical component (actuator), it is necessary to have sensors that are lightweight, minimally invasive, immune to electromagnetic interference, and do not present electromagnetic compatibility issues. In this sense, fiber optic sensors allow to meet all of these requirements. As previously specified, rapid overheating of an EMA above nominal values can lead to the loss of

the entire component (Wu et al. 2017). Therefore, detecting overheating as quickly as possible is an essential goal in order to increase the reliability level of EMAs.

In this work, the potential of FBG optical sensors in detecting rapid overheating will be properly described and analyzed, both when caused by a sudden change in environmental conditions and when generated by a localized heating. Although still generic and performed on samples with extremely basic geometry, the thermal transient to which the sensors were subjected allowed to firstly quantify their response.

## 2. Optical fiber and FBG sensors

Optical fiber is a mix glass and polymer material that has the ability to transport a light signal inside itself. The fiber has a cylindrical section, composed by different concentric layers called, from the inside out, *core*, *cladding*, and *coating*. Core and cladding are the two glass layers that allow the fiber to properly function. When light reaches the interface between the two layers, it undergoes a total reflection thus remaining confined inside the core and so propagating the information along the axis of the fiber. However, due to the extreme fragility of every glass fiber, these layers are protected with an additional external coating. If necessary, additional layers can be added (Kasap 2001).

FBG sensors are obtained from a section of optical fiber inside which a periodic modulation of the core's refractive index is carried out through laser photo incision. This generates a structure called a *Bragg grating*. Bragg gratings act like selective frequency mirrors, reflecting a specific frequency of the electromagnetic spectrum while allowing all others to pass through itself. The reflected frequency, called the *Bragg frequency*, represents the optical output of the sensor. This value, expressed in wavelength, is proportional to the geometry of the sensor. In this way, it is possible to correlate a specific physical deformation of the fiber with the variation of the physical parameter acting on it:

$$\lambda_B = 2n_{eff}\Lambda \quad (1)$$

Optical fiber and, more specifically, FBG sensors can provide significant advantages in prognostic and diagnostic activities of safety-

critical components and, consequently, in system health monitoring. These advantages are linked to the physical characteristics of the fiber itself. In particular, the fiber guarantees a minimum invasiveness with a pronounced lightness, providing both weight savings and the possibility of instrumenting even particularly remote areas. Furthermore, and most significantly, the fiber is immune to electromagnetic interference and, in turn, has no electromagnetic compatibility issues. This aspect is clearly crucial for monitoring components such as electromechanical actuators, which, as safety-critical components, require monitoring but are governed by electric motors. Another advantage is the electrical passivity and chemical inertness, which eliminates the possibility of creating sparks or potential fire hazards (Mihailov 2012).

As described in the introduction, overheating is one of the causes of malfunctioning of an electromechanical actuators and other components. The characteristics of FBG sensors are well suited to thermal testing activities and, more specifically, to detect rapid transients. For this reason, an experimental test campaign was conducted at Politecnico di Torino to verify the actual ability of this type of sensor to read this type of thermal transients. The performance was properly tested, quantified, and compared with traditional electronic sensors.

### 3. Test campaign

The experimental activity described in this work aims to analyze the performance of FBG sensors when exposed to a rapid change about their thermal conditions. In particular, two different scenarios are analyzed: firstly, a thermal transient that rapidly involves the entire environmental conditions to which the sensor (and therefore, ideally, the component on which it is installed) is subjected. Secondly, a highly localized heating is imposed in order to simulate a local malfunction, detected through overheating of a part of the component. Consequently, the test campaign is divided into two phases:

- A measurement cycle in a climatic chamber, which generates an "environmental" thermal transient;
- A measurement cycle on a Peltier cell, to

induce a localized thermal transient.

In particular, the test cycle carried out in the climatic chamber consists of the following steps:

- The climatic chamber is closed and brought to a temperature of 120°C for enough time to reach thermal equilibrium.
- The door of the climatic chamber is opened, applying a sudden thermal transient to the measurement environment.
- The climatic chamber is closed again but remaining turned off. The heat accumulated on the metal plates reheats the sensors, causing a new thermal transient to occur.

Although it is interesting to analyze both phases of the transient, this work mainly focuses on the heating phase, which for the PHM of an actuator (or more generally, an electromechanical component) is the most critical part and more involved in potential failures.

Different sensors were placed inside the climatic chamber:

- FBG sensor without packaging but with external coating on the fiber
- FBG sensor without packaging
- FBG sensor with external casing

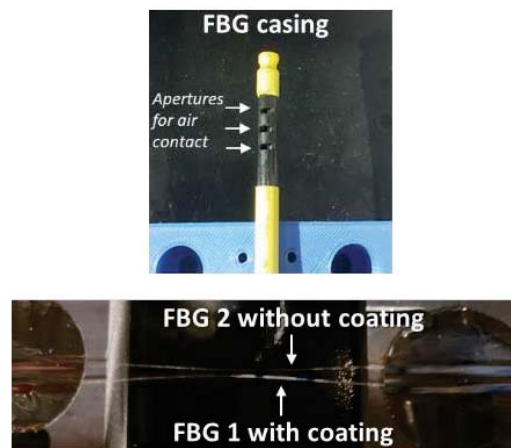

Figure 2. Sensor put in the climatic chamber

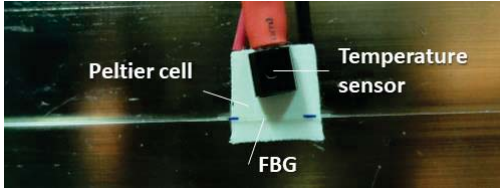

Figure 3. Sensor employed in the tests

The data collection is based on an acquisition system, already used in previous works developed by the research group (Aimasso et al. 2022) and summarized in the image below. The fundamental component is the interrogator: it is capable of generating a laser beam that is sent to the optical fibers connected to it through the appropriate channels. When the laser beam reaches the various FBG sensors, each one reflects a specific frequency. The reflected frequencies are quantified by the interrogator (in terms of wavelengths) and communicated to a PC via LAN connection. These values (the sensors output) are graphically displayed and saved in text files. The post-processing of the data was carried out using MATLAB codes.

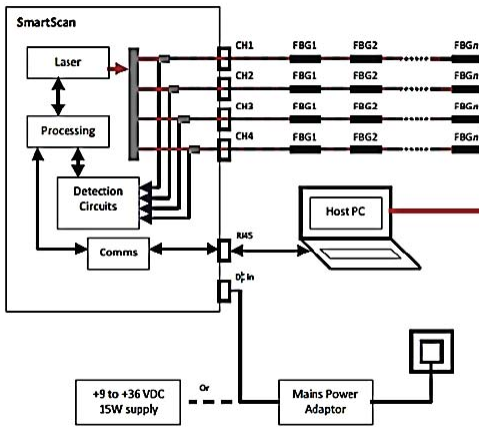

Figure 4. Optical data acquisition system.

During the experimental campaign, the ability of each sensor to adapt in the shortest possible time to the sudden change in operating temperature is therefore analysed.

**4. Results and discussion**

The first sensors whose performance has been analysed are those placed in climatic chambers.

For these ones, the heating phases can be interpolated by superimposing two distinct effects, both with exponential dynamics:

- A first, extremely fast, dynamic which indicates the rapid thermal transient imposed on the sensor.
- A second, much slower, dynamic which describes the evolution of the system towards a state of equilibrium.

Mathematically, by interpolating the experimental data in MATLAB, all the recorded evolutions were modeled as follows:

$$y(t) = Ae^{Bt} + Ce^{Dt} \tag{2}$$

However, after a first parameters calculation process, the overall transient dynamic was approximated with only a first order model, in consideration of the really low contribution of the second thermal dynamic.

Clearly this result does not exactly represent the time constant of the sensor, since it also includes the time constant of the physical cooling/heating phenomenon imposed by the opening/closing of the chamber. However, the geometry of the experimental setup imposes the same environmental conditions on all sensors. The differences recorded between them are therefore attributable to the different reaction times specific to each sensor, so making significant the comparison here reported.

Assuming exponential dynamics, the following equation is considered:

$$\Delta t = 5\tau \tag{3}$$

where  $\Delta t$  is the duration of the transient and  $\tau$  is the time constant of the system. Considering that all sensors are exposed to the same environmental conditions, the value of  $\tau$  is taken as an objective parameter to compare the performance of the sensors.

The overall thermal cycle has been repeated several times. In table 1 the mean values are reported for each sensor. The main trends are also reported in the following figures.

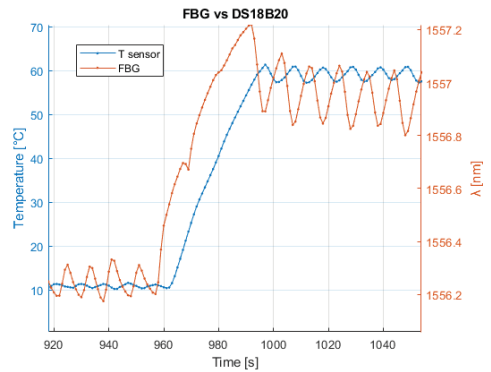
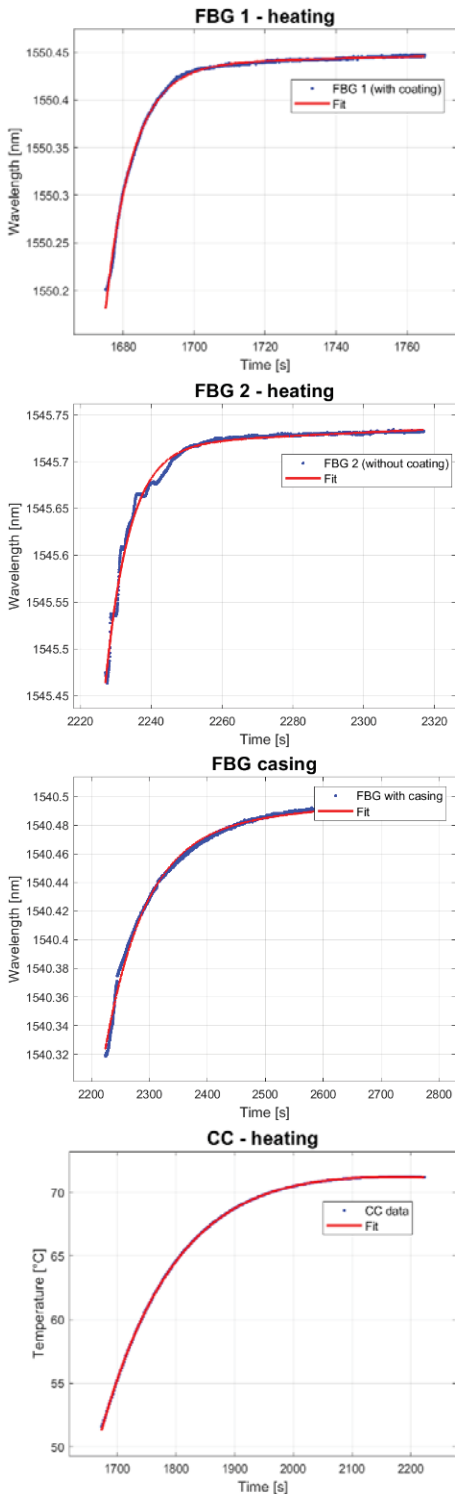

Figure 5. Graphs of different sensor responses.

An extremely fast response time of the fiber in reading the transient data can be observed. It can be seen that the sensor without packaging can provide a response time one order of magnitude faster than that of the PT100. However, it should be noted that a solution without packaging is extremely difficult to implement, and at the same time, it may increase the presence of noise in the measurements due to vibrations and other mechanical disturbances. Such disturbances can be easily overcome by implementing an external casing, albeit at the cost of a decrease in performance in terms of response time.

The same process was repeated for the sensor placed on top of a Peltier cell. In figure 5, the trend of the two data points can be observed superimposed. Here again, the rapid thermal transient of the fiber can simply be verified.

Table 1. Average calculated sensors time responses

Sensor	$\tau$ (s)
FBG with coating	8
FBG without coating	6
FBG casing	100
FBG peltier	8
PT100	80

The results are very promising and extremely encouraging. In particular, the high speed of the fiber in reading transients (and therefore possible off-nominal conditions) combined with its physical properties makes it particularly suitable for instrumenting such components. At the Politecnico di Torino, an experimental bench has been developed since several years aimed at

representing the behavior of an electromechanical actuator for aerospace applications. This experimental bench (Aimasso et al, 2021) has been designed with a modular architecture, and among the different parts, the most important components are:

- Motor driver;
- Transmission;
- Load simulator.

During next activities, FBG sensors will be placed in strategic points in order to monitor the system, improving the PHM strategies developed by the research group.

Furthermore, as described in the previous section, further studies by the research group are underway in order to be able to define and develop a sensor packaging that can combine all the requirements that emerged in this work: the need to read a very fast transient without being exposed to vibration-induced disturbances.

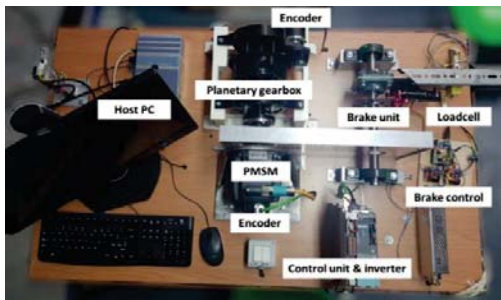

Figure 6. EMA test bench simulator.

## 5. Conclusions

New aircraft generations are now designed according to the More Electric Aircraft logic. Therefore, traditional hydraulic actuators need to be replaced with electromechanical servomechanisms. However, due to the limited amount of available data and safety and reliability issues, their use in the industry is still limited, especially for safety-critical systems such as flight controls.

Due to the electric operation of these actuators, one of the most significant problems is overheating. For this reason, EMA (Electromechanical Actuators) need to be equipped with sensors capable of quickly detecting a thermal transient outside the system's

operating conditions. FBG optical sensors, thanks to their insensitivity to electromagnetic disturbances, are particularly suitable for this task.

This paper highlights the extremely rapid responsiveness of this type of sensor, both when exposed to environmental thermal transients and when measuring point-wise transients. In particular, the sensors used in the climatic chamber demonstrated a response time one order of magnitude higher than that of a typical electronic sensor when used without additional packaging, while showing a comparable response time to the electronic sensor when used in a simple example of casing. Finally, FBG sensors showed excellent capability in reading a point heating, with a response time comparable to that measured in previous tests for sensors without packaging.

It is now possible to create a sensing system that can provide extremely accurate data even for extremely remote components (or parts of them). Consequently, FBG sensors are particularly well suited for advanced prognostic and diagnostic activities due to their minimal invasiveness, electrical passivity, and immunity to electromagnetic interference.

As a result, additional and more in-depth analyses are required in order to define a standardised procedure capable of ensuring the levels of accuracy and reliability required by aerospace regulations.

## Acknowledgments

Authors sincerely thanks ing. Matteo Bertone, ing. Paolo Girardi and ing. Gilbert Charruaz for their fundamental contribute to the development of the test bench. Authors also thanks PhotoNext and Links Foundation for their support in the optical sensors production. The research is conducted thanks to the development of the FreMe project.

## References

- Aimasso, A., P.C. Berri, and M.D.L. Dalla Vedova. 2021. "A Genetic-Based Prognostic Method for Aerospace Electromechanical Actuators." *International Journal of Mechanics and Control* 22 (2).
- Aimasso, A., M.D.L. Dalla Vedova, P. Maggiore, and G. Quattrocchi. 2022. "Study of FBG-Based

- Optical Sensors for Thermal Measurements in Aerospace Applications.” In *Journal of Physics: Conference Series*. Vol. 2293. <https://doi.org/10.1088/1742-6596/2293/1/012006>.
- Cronin, Michael J. 2012. “All-Electric vs Conventional Aircraft - The Production/Operational Aspects.” <https://doi.org/10.2514/3.44897> 20 (6): 481–86. <https://doi.org/10.2514/3.44897>.
- Deng, Yuhang, Simon Y. Foo, and Indranil Bhattacharya. 2014. “Regenerative Electric Power for More Electric Aircraft.” *IEEE SOUTHEASTCON 2014*, November. <https://doi.org/10.1109/SECON.2014.6950713>.
- Garriga, Ana Garcia, Sangeeth S. Ponnusamy, and Laura Mainini. 2018. “A Multifidelity Framework to Support the Design of More-Electric Actuation.” *2018 Multidisciplinary Analysis and Optimization Conference*. <https://doi.org/10.2514/6.2018-3741>.
- Howse, M. 2003. “All Electric Aircraft.” *IEE Power Engineer* 17 (4): 35–37. <https://doi.org/10.1049/PE:20030410>.
- Kasap, Safa. 2001. *Optoelectronics and Photonics: Principles and Practices*. Prentice Hall.
- Madonna, Vincenzo, Student Member, Paolo Giangrande, Luca Lusuardi, Andrea Cavallini, Chris Gerada, Senior Member, Michael Galea, L Lusuardi, and A Cavallini are with. 2020. “Thermal Overload and Insulation Aging of Short Duty Cycle, Aerospace Motors.” *IEEE TRANSACTIONS ON INDUSTRIAL ELECTRONICS* 67 (4). <https://doi.org/10.1109/TIE.2019.2914630>.
- Mihailov, Stephen J. 2012. “Fiber Bragg Grating Sensors for Harsh Environments.” *Sensors* 12: 1898–1918. <https://doi.org/10.3390/s120201898>.
- Missala, Tadeusz. 2014. “Electromechanical Actuators – Selected Safety-Related Problems.” *Advances in Intelligent Systems and Computing* 267: 175–86. [https://doi.org/10.1007/978-3-319-05353-0\\_18/COVER](https://doi.org/10.1007/978-3-319-05353-0_18/COVER).
- Quigley, Richard E. 1993. “More Electric Aircraft.” *Proceedings Eighth Annual Applied Power Electronics Conference and Exposition*, 906–11. <https://doi.org/10.1109/APEC.1993.290667>.
- Taha, Mohamad Hussien. n.d. “4 Power Electronics Application for More Electric Aircraft.” Accessed April 29, 2023. [www.intechopen.com](http://www.intechopen.com).
- Weimer, Joseph A. 2003. “The Role of Electric Machines and Drives in the More Electric Aircraft.” <https://doi.org/10.1109/IEMDC.2003.1211236>.
- Wu, W, Y R Lin, L C Chow, E Gyasi, J P Kizito, and Q H Leland. 2017. “Electromechanical Actuator Fan Failure Analysis and Safety-Critical Design.” *IEEE Aerospace and Electronic Systems Magazine* 32. <https://doi.org/10.1109/MAES.2017.150281>.
- Yin, Zhengyang, Niaoqing Hu, Jiageng Chen, Yi Yang, and Guoji Shen. 2022. “A Review of Fault Diagnosis, Prognosis and Health Management for Aircraft Electromechanical Actuators.” *IET Electric Power Applications* 16 (11): 1249–72. <https://doi.org/10.1049/ELP2.12225>.