

Water security: the “new normality” of informal settlements. Nature-Based Solutions as sustainable mitigation and adaptation strategies

Original

Water security: the “new normality” of informal settlements. Nature-Based Solutions as sustainable mitigation and adaptation strategies / Munoz Veloza, Monica Alexandra; Dadati, Maria Caterina; Giordano, Roberto; Savio, Lorenzo. - In: VITRUVIO. - ISSN 2444-9091. - ELETTRONICO. - 7:1(2022), pp. 62-77. [10.4995/vitruvioijats.2022.17437]

Availability:

This version is available at: 11583/2970477 since: 2022-08-04T18:51:45Z

Publisher:

Universidad Politecnica de Valencia

Published

DOI:10.4995/vitruvioijats.2022.17437

Terms of use:

This article is made available under terms and conditions as specified in the corresponding bibliographic description in the repository

Publisher copyright

(Article begins on next page)

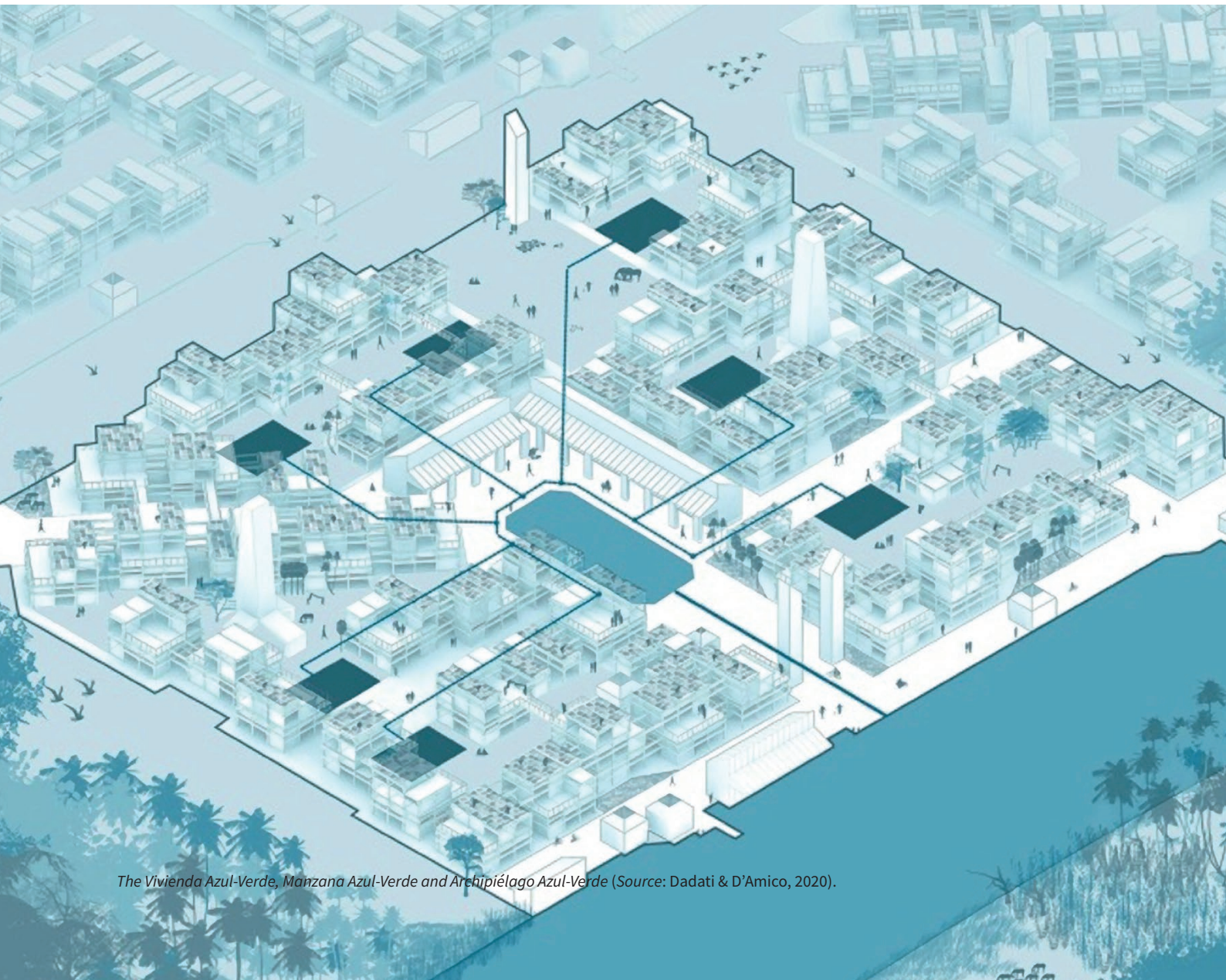
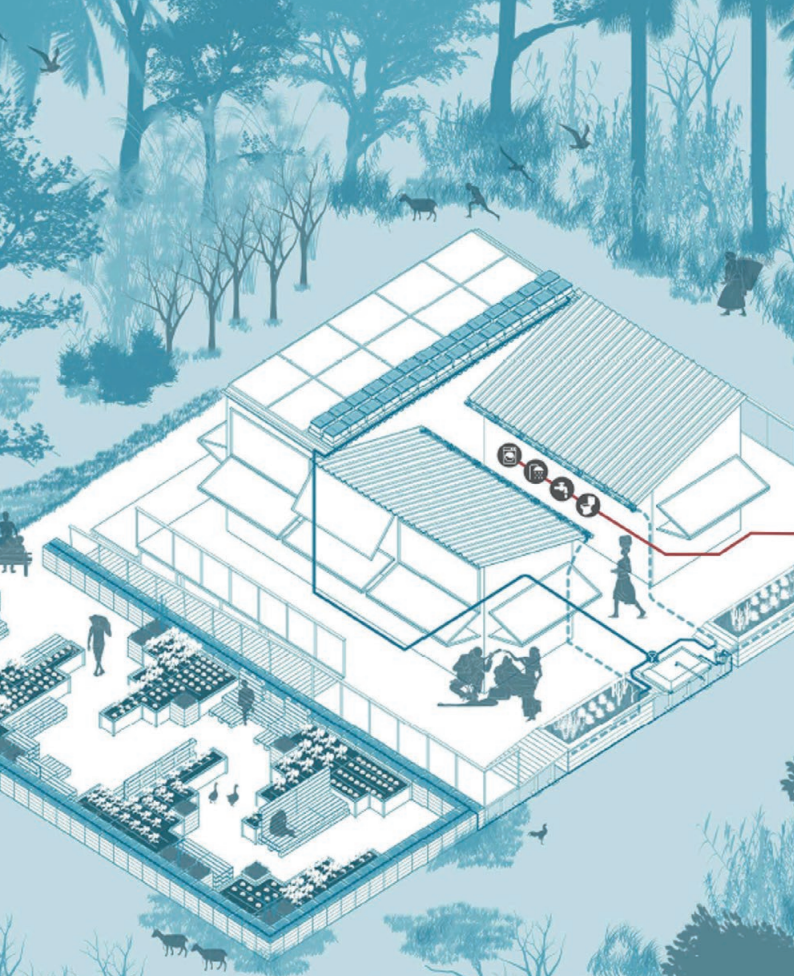

The Vivienda Azul-Verde, Manzana Azul-Verde and Archipiélago Azul-Verde (Source: Dadati & D'Amico, 2020).

Water security: the “new normality” of informal settlements. Nature-Based Solutions as sustainable mitigation and adaptation strategies

Mónica Alexandra Muñoz Veloza*, Maria Caterina Dadati, Roberto Giordano and Lorenzo Savio

Department of Architecture and Design, Politecnico di Torino
Email: * monica.munozveloza@polito.it

Abstract: The COVID-19 pandemic showed us how fragile cities are when dealing with this phenomenon. The lack of green areas, high pollution levels, and human overpopulation contributed to the increase of the urban heat island effect and proved to be the perfect ingredients for the spread of the virus that changed, perhaps forever, our ways of living inhabiting. The consequences were even more dramatic for the inhabitants of informal neighbourhoods, as these exacerbated existing problems related to economic instability and low food and water security. This paper proposes using Nature-Based Solutions to mitigate and adapt to climate change and increase access to water in informal settlements. The research study focused on analysing two technologies, the Blue-Green roof and Rain Garden, developing a prototype for each one. Considering that the practice of self-building characterises spontaneous settlements, the modules were conceived to be built by the inhabitants using recycled materials. These low-tech strategies improve indoor thermal comfort, facilitate the storage of filtered rainwater for domestic use and provide access to affordable food through domestic scale cultivation. Implementing these solutions in marginalised neighbourhoods could also empower residents to face challenges related to Global Warming, such as runoffs generated by heavy precipitations, and improve hygienic conditions to prevent the spread of diseases.

Keywords: Nature-Based Solutions; informal settlements; self-building; water collection; adaptation; mitigation.

1. Introduction

Currently, large population areas worldwide are being affected by phenomena related to human activities: climate change and incorrect urbanisation (UN Habitat, 2018). Moreover, according to the United Nations Office for Disaster Risk Reduction (UNDRR, 2020), most disaster events in the 20 years between 2000 and 2019 were floods and storms (Figure 1).

With the guidance of the public and private sectors, some cities -especially in the Global North- are already arming themselves with urban plans for greening and depaving¹ -e.g., Copenhagen Climate Adaptation Plan, 2011. They are proposing appropriate solutions aimed at achieving resilience against these phenomena – e.g., Sustainable Urban Drainage Systems (SUDS) (Zhou, 2014), floating and amphibious constructions, temporary or permanent barriers, dry or wet floodproofing, and elevation of buildings, among others (de Graaf, 2012).

In this context, the word adaptation takes on a precise meaning. It means developing actions and strategies that can make buildings less vulnerable and more resistant to health and environmental risks. Moreover, since the building is human beings’ third skin (Semper, 1989), it is rather obvious that every action and strategy affects people. Unfortunately, in marginal areas such as informal neighbourhoods that arise spontaneously,² the population does not benefit from the same support (UN Habitat, 2018).

In 2020, the COVID-19 pandemic made evident the vulnerability of millions of habitants of informal settlements due to the precarious conditions in which they live (Corburn et al., 2020). Poor sanitary conditions such as overcrowded dwellings and lack of running water made

it very difficult for these communities to take measures to avoid contagion. (OECD, 2020: 1). Another factor that contributed negatively was the need for people to leave the house every day to get money and food through informal activities. According to official figures, slum dwellers were one of the population groups that suffered the most from the virus’ direct and indirect effects (ILO, 2020; IDB, 2021):³ higher rates of infection and mortality, increased unemployment, greater economic instability and reduced food security, to name a few.

This paper focuses on one case study, particularly in the informal neighbourhood *El Pozón* in *Cartagena de Indias*, Colombia. It is located near the southern bank of the *La Virgen* swamp, where a multiplicity of houses, primarily self-constructed, arise spontaneously and without any building regulations. In most cases, the uncontrolled- and inexperienced - housing construction has generated different problems regarding primary living conditions. Furthermore, due to its proximity to the mangrove’s lagoon, the settlement and others in the area have been subject to flooding several times in the past, being the most severe episode in 2011.⁴

The *Pontificia Universidad Javeriana* of Bogota (PUJ) and the *Politecnico di Torino* tried to provide an appropriate response for more resilient and sustainable development of the neighbourhood through the project *PEI Máquina Verde - El Arca*.

A housing prototype of the project was proposed and built for the international competition *Solar Decathlon Latin America & Caribbean (SDLA&C) 2019*, which took place in Cali, Colombia, and in which the authors of this article participated as part of the *PEI Máquina Verde - El Arca* design and construction team.⁵

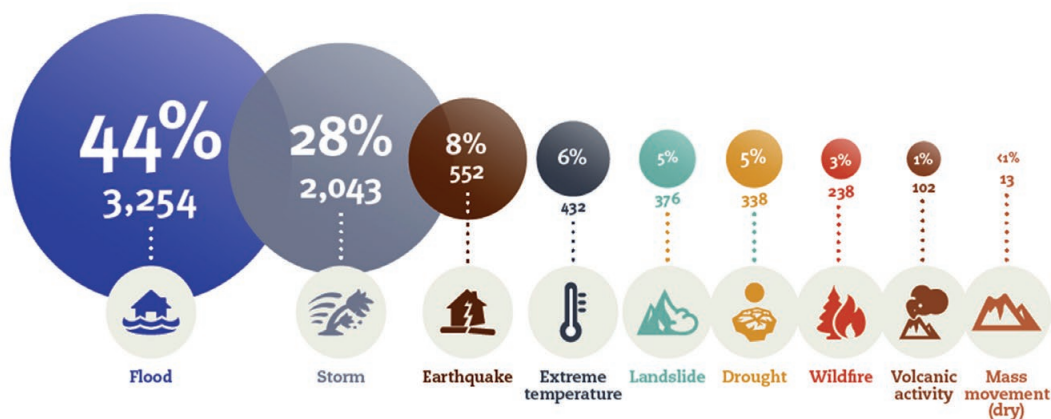

Figure 1 | Percentage of occurrences of disasters by disaster type (2000-2019). Source: UNDRR, 2022, p.10.

The particular assignment of the authors was to determine the hydraulic design of the prototype housing module with a sustainability focus regarding the saving, recovery and reuse of water resources. This experience has brought the team to work with experts in the field and local companies. At the same time, information was acquired about the water needs of the occupants and forecast consumption and the savings of individual equipment were planned.

Following the realisation of the prototype at the Solar Decathlon competition in January 2020, the team carried out further visits to *El Pozón*. The tours to the area provided an idea to integrate Natural-Based Solutions into the house’s plumbing system to collect and clean rainwater.

The main objective of this study is to identify a possible strategy of mitigation and adaptation (UN, 2015) to both climatic and health phenomena. Through a scalable, sustainable and cost-effective solution, it is intended to help the residents of this neighbourhood by enhancing their resilience in future crisis periods. This idea was developed during the first six months of the pandemic, a time in which it became clear the importance of projects that can function as containment measures to tackle infections without neglecting the importance of being prepared for extreme natural events.

Considering the neighbourhood’s waste management challenges and after proper research of modules currently present on the market⁶ and patents that serve this function,⁷ it was decided to use waste materials to design a Blue-Green roof and a Rain Garden module that can be self-built.

The study demonstrates the performance of these technologies as water management strategies from the microscale of the *PEI Máquina Verde - El Arca* housing prototype to its Masterplan. The proposal included using Natural-Based Solutions both on private spaces - roofs and backyards - and green public areas through a connected network system.

The study also leaves the door open to using Blue-Greens Roof and Rain Gardens in the houses currently built in the neighbourhood (Figure 2). It could improve residents’ quality of life by guaranteeing access to water for domestic use. Thus, it would be a helpful tool to respond better to disease outbreaks such as COVID-19 while providing environmental benefits.

On a larger scale, this project could also help reduce the environmental pollution that affects the swamp that borders the neighbourhood by improving waste



Figure 2 | Informal houses of *El Pozón* with different levels of consolidation. Photos were taken during the visits to the neighbourhood. Source: Mónica Muñoz.



Figure 3 | *El Pozón*, the neighbourhood. Source: Dadati & D’Amico, 2020, p.60.

management. Moreover, it could counteract floods caused by the neighbourhood’s location in a landfill area (Figure 3) and increasingly frequent storms (Ayala García & Meisel Roca, 2017).

2. From rural to urban in the Colombian Caribbean

The different social groups that have interacted on the territory of Colombia over the centuries have brought with them their own culture, customs, and lifestyles, contributing to the ethnic diversity of the nation. Although the Colombian State recognised this condition in the Constitution of 1991, race-related conflicts are still present today and imbalances – social and economic inequalities - between communities and territories (Sánchez-Torres, 2017). For all these reasons, the internal – mainly rural - populations are displaced and are continually forced to move to the cities in search of better living conditions.

According to official data from the International Fund for Agricultural Development (IFAD) in 2018, “in rural Colombia, 7.2 per cent of the population -3.5 million citizens- lived in extreme poverty”⁸. For this segment of the population, the opportunities for access to adequate education and employment are minimal (Sánchez-Torres, 2017).

In addition to these problems, there are also environmental difficulties, mainly caused by the rising temperatures and the sudden changes in rainfall, which affect the coastal areas that have become subject to frequent flooding (UN Habitat, 2018). One of the areas where the population is mainly affected by this issue is the Bolívar department, whose capital city - *Cartagena de Indias* - fully reflects the social and economic inequality of the nation (Hernandez Correa, 2018).

The historic centre of *Cartagena de Indias* is the most important tourist nucleus in the country. However, investigating the city’s most recent history, a severe imbalance between the more central areas and the outskirts can be noticed. Such imbalance has increased social problems - that affect most contemporary Colombian cities - such as insecurity, poverty, a deficit in services and infrastructure, and environmental issues (Ayala García & Meisel Roca, 2017).

One of the most known neighbourhoods on the periphery is *El Pozón*, located in the northeast area of the city (Figure 4). Its history represents the urban invasion phenomenon in Latin America, which is one of the most common means for low-income inhabitants to have a house. Generally, they illegally occupied suburban or rural

areas by establishing their settlements out of the bounds of the administrative borders.



Figure 4 | Territorial framework of *Cartagena de Indias*. Source: Dadati & D’Amico, 2020, p.56.

3. Case study: *EL Pozón, Cartagena de Indias*

In addition to its social and economic problems, *El Pozón* is characterised by a contradictory environmental situation. On the one hand, it suffers the problem of floods due to its proximity to the La Virgen swamp and heavy seasonal rainfall (Figure 5). The unplanned relationship between nature and construction exposes the buildings to the risk of direct flooding, causing irreparable damage and forcing inhabitants to move or rebuild their homes cyclically. On the other hand, the domestic water supply is problematic, especially in the dry season.

Two characteristics that the fieldwork highlighted were, on the one hand, the interest in having fruit and ornamental plants in the houses and the willingness of the inhabitants to take care of them (Figure 6),⁹ and on the other hand, the incorporation of productive activities in the living space (Figure 7). These widely used practices in *El Pozón* are representative of the cultural baggage that the inhabitants inherit and bring with them to the city from their rural places of origin.

Unfortunately, the lack of water during some months makes cultivation very costly since it is necessary to pay to bring this precious yet scarce commodity from other neighbourhoods (Guarín Cobos, 2003). Another problem that hinders planting is the type of land on which the

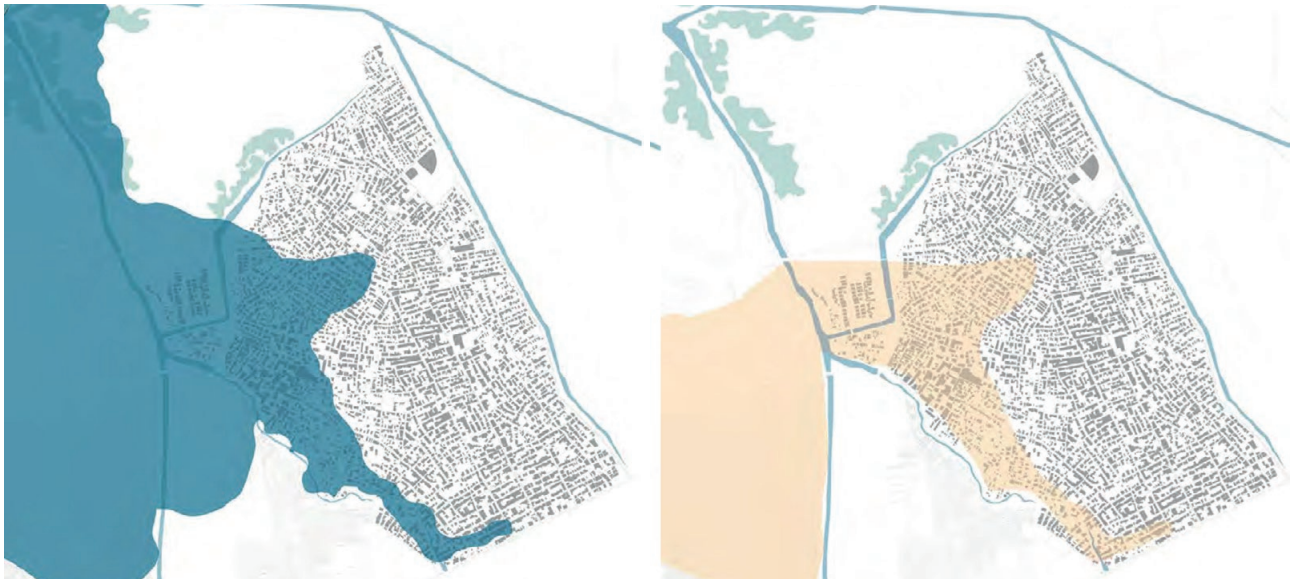

Figure 5 | Sea-level rise (left) and Stormwater Flooding (right). Source: Dadati & D’Amico, 2020, p.62.



Figure 6 | The importance of fruit and ornamental vegetation inside the dwellings. Source: Caterina Dadati.

neighbourhood was built since it was stolen from the swamp and filled with construction and demolition waste. According to interviews with the inhabitants, they complained that the soil was too dry and it hard to grow some species.

El Pozón began in the early 1990s as an illegal neighbourhood, an invasion of the *La Virgen* swamp by people arriving mainly from villages and rural areas of the region. Many of them were obliged to migrate because of forced displacement and violence. The form of occupation was based on the principle of the “4 sticks’ law”; it stated that whoever took possession of a plot on the swamp’s water, with a maximum size of 6x12 meters and took responsibility for filling it. This possession makes him/herself the land owner, and he/she could build his/her house. Some



Figure 7 | Informal restaurant in the backyard of a house. Source: Mónica Muñoz.

of the houses in *El Pozón* continue to be illegal, but others have become legal through agreements with the government. However, the expansion and filling of the swamp continue to inflict serious damage on the natural system of the area, causing the swamp to become an open sewer¹⁰ (Figure 8).

During the pandemic, this neighbourhood registered the highest numbers of infections and deaths in the city and the country (CARACOL, May 12, 2020). Two of the leading causes were: the need for many inhabitants of the sector to go out daily to earn money and provide food for their families and the lack of clean water and sanitation for hand-washing (OECD, 2020: 1).



Figure 8 | The bodies of water are in a high state of disrepair. Photos were taken during the visits to the neighbourhood. *Source:* Caterina Dadati and Marco D'Amico.

As a result of these alarming figures, the national government ordered in May 2020 the temporary closure of this and other nearby informal neighbourhoods - no one could get in or out - making it even more challenging to get food and water (EL TIEMPO, May 27, 2020).

4. Reference study: The *PEI Máquina Verde* – *El Arca* Project

As previously mentioned, shortly before the beginning of the pandemic, the academic project *PEI Máquina Verde*

- *El Arca* was presented. The following is a brief description of the stages and features.

After several research activities, surveys and visits to *El Pozón*, the neighbourhood population's dynamics, relationships and basic needs were determined and served as the basis for the Urban Master Plan proposal, focusing on two essential themes: social housing and family habitability. *PEI Máquina Verde - El Arca* proposed a reconnection of the human-nature relationship through a physical transition between urban expansion and the fragile ecosystem. The idea was to develop a social housing archipelago along with the construction of an Urban Boundary for Protection and Control of the swamp.

The team decided to reach the density of 120 households per hectare in the archipelago, implementing a system of piled habitational units that could generate a healthy urban environment for the community's social development. Considering the risk and vulnerability conditions that may generate flood cycles, the blocks of bi-familiar modules are disposed as stilt units connected through platforms, allowing water circulation to go below, contemplating different levels of flooding along with the urban proposal.

The architectural project was also elaborated following a set of energy, comfort, social and economic requirements and some concepts taken from several visits to *El Pozón*. For instance, the prototype house was developed modularly with a c-shaped plan and a central patio that encourages circulation, ventilation and exposure to the sun, allowing the inside and the outside to blend. The concept of frame is predominant in the project and helpful in responding to different housing needs. The house was conceived as a subjective container: an ark. The house is reconfigurable with progressivity features that can be added according to a specific family's requirements (Figure 9).

The *PEI Máquina Verde - El Arca* prototype uses passive technologies for ventilation of the rooms through the correct configuration of the openings that favour the exploitation of the prevailing winds and the protection from solar radiation. The energy needed is satisfied by ten photovoltaic panels - 9 m² - placed above the fixed roof of the social area. The need for hot water is guaranteed by five prototype panels - made by the team - that act as solar collectors and do not require electricity for operation.

As far as the hydro sanitary system is concerned, the purpose is to reuse water through strategies that reduce consumption and allow more efficient storage. The two sources of the system are potable water supplied from the aqueduct and rainwater collected through the roof

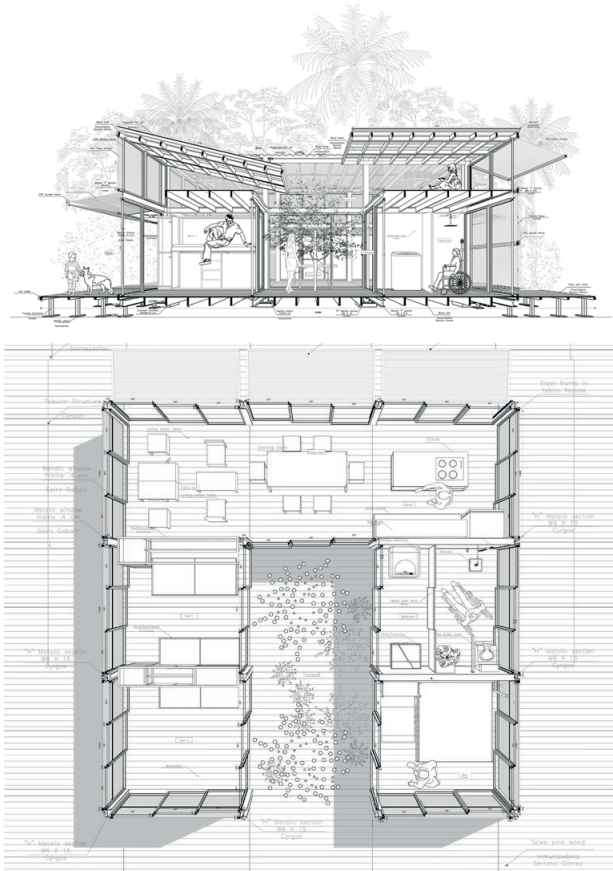

Figure 9 | Perspective section, plan of the PEI Máquina Verde – El Arca prototype and photo of the structure under construction. Source: PEI Team.

surface. Due to the mobile system roof that follows a three-module order, it was necessary to think of a particular system of gutters for water recollection and a flexible pipe to connect the gutters to the downpipes (Figure 10).

5. Design the adaptation: the *vivienda Azul-Verde*

After constructing the PEI Máquina Verde – El Arca module for the SDLA&C 2019 competition, it was decided to study



Figure 10 | Mobile system roof and flexible water recollection solution. Source: PEI Team.

the possibility of raising the amount of rainwater collected to limit use for domestic activities and the scarce potable water available. Although necessary in the global context, this matter is relevant in informal settlements such as El Pozón, where access to drinking water is not always guaranteed. Moreover, inhabitants are already accustomed to collecting water as it was a common practice in the rural areas where they used to live. The following is a description of the two Natural-Based Solutions used: Blue-green roof and Rain Garden.

As far as the roof is concerned, the main intention was to study the implementation of a modular blue-green roof. This is due to the fact that, in addition to increase the water capturing surface of the roof, the placement of an extra-green - layer ensures better indoor environmental conditions, as it contributes to its insulation capacity. Once the existing typologies were studied and the elements and materials that compose them were analysed, the next step was to contextualise them within *El Pozón* in order to design a module that could fit into the housing prototype.

For this reason, in addition to implementing the territorial analyses already made for the competition, further inspections of the site project were conducted between January and February 2020. Thanks to the collaboration of various social cooperatives active in the area. It must be underlined how the knowledge of the territory has been facilitated by the great sense of conscience of the social leaders. The accompanying activity was carried out mainly by Mirian Correa, social leader and part of the *Corporación para el Medio Ambiente*, who organised the various inspections and interviews with citizens.

The main topic of discussion with the inhabitants concerned the theme of rainwater collection: whether they do it and, if so, by what method. At the time, a precise configuration of the green module had not yet been defined, so examples already on the market and suggestions on how this collection could take place were shown to the inhabitants. During the last two visits, following increased awareness of the final objective of the investigation process, an attempt was made to understand which materials were most used by the residents and how was their disposal process.

A scouting process was led to identify a range of materials similar in composition and (or) function to those required for the module’s construction. The ones more readily available, particularly those considered waste materials, were selected to design a module that the inhabitants could self-build with recycling -local -resources simply following the assembly instructions. The final design of this low-tech and low-cost solution was not only the result of the research and scouting phase but also of the collaboration with the inhabitants of the neighbourhood.

The module is divided into a fixed one and a movable one. The first one consists of a lower tank, in which the overflow water is collected, that is composed as follows: a box made of plywood panels (1 cm) that allows the entire module to be anchored to the roof, covered with a truck tarpaulin (0.3 cm) that acts as the waterproofing. On the lower tank rests the fruit box, which holds all the elements of the green roof stratigraphy: the egg container, the coconut fibre, and the growing medium. The egg container works as a drainage tray, allowing the water to collect in the egg pockets, whilst the coconut fibre (0.3 cm) holds the growing medium in position. A soilless modified mix made of 50% sand, 30% clay and 20% compost is the most suitable choice for the module.

Particular attention was paid to the anchoring methods since the module is designed to be easily assembled and disassembled, given the need for maintenance.

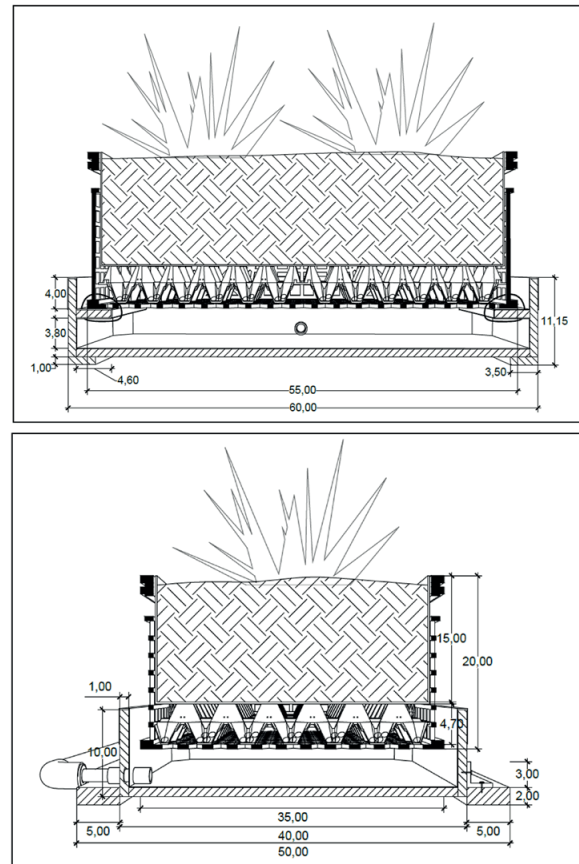

Figure 11 | Sections of the Blue-green roof module. Source: Dadati & D’Amico, 2020, p.145.

For this reason, the technology of the anchoring follows the two parts division.

The lower tank must be inserted in a structure that guarantees its fixing: in this case, the structure is a wooden frame to which the module is attached with screws. Instead, the upper part must be easier to remove as it requires constant maintenance. Thereby, the fruit box is placed on two horizontal supports inside the short sides of the lower tank and anchored to it with adjustable clamps (Figure 11 and Figure 12).

The operation of the module replicates precisely that of a green roof stratigraphy. When it rains, the water filters into the ground. It fills the ovoid cavities that collect water, which then goes up by capillarity in the soil above, with consequent nourishment of the vegetation. When all the ovoid slots are filled, the overflow process begins so that water flows out of the tray. Since the cavities are connected, and the holes are 3 cm higher than the edge, for the process to begin, all cavities must be filled evenly, and the water must reach a certain level throughout the tray (Figure 13).

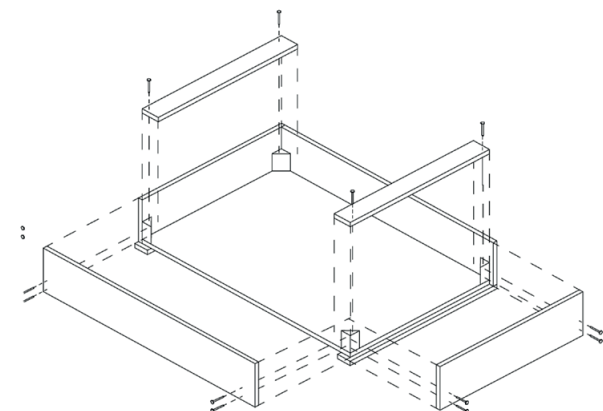
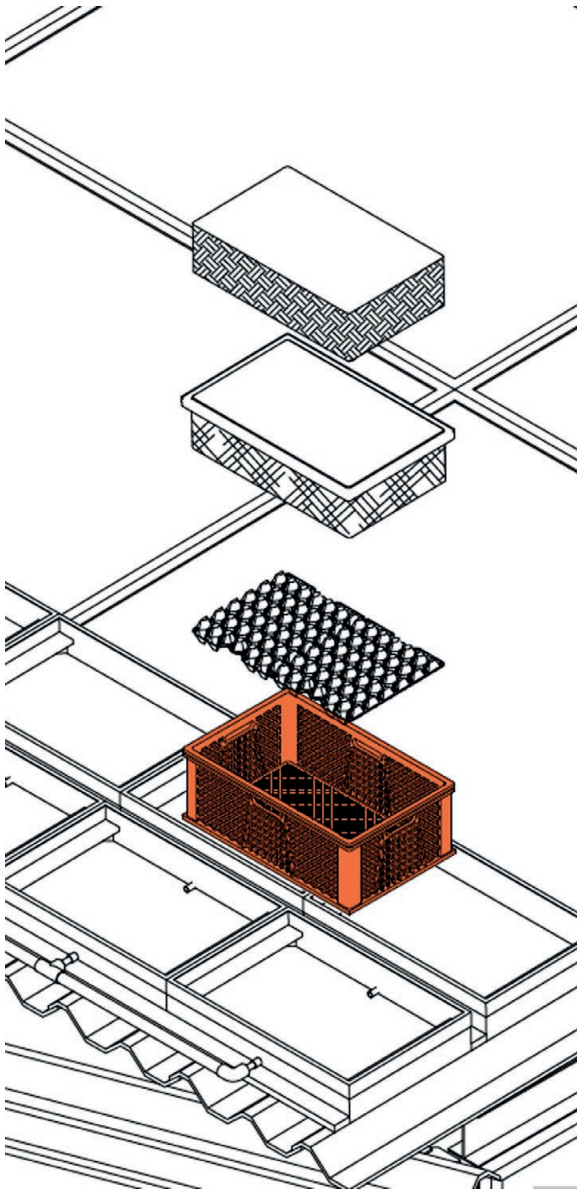

Figure 12 | Exploded axonometric showing the different elements that compose the blue-green roof module. Source: Dadati & D’Amico, 2020, p.143.

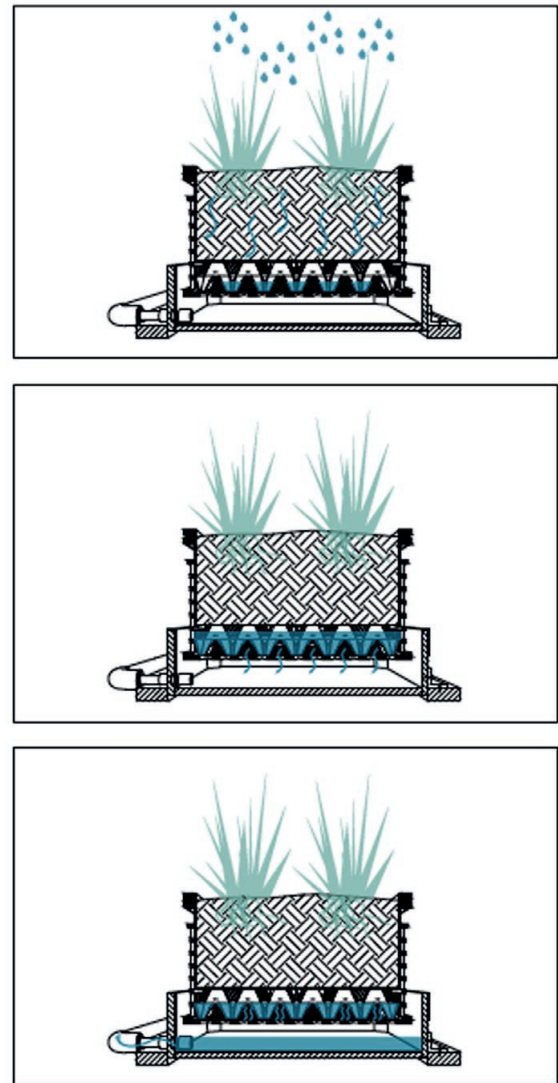

Figure 13 | The functioning of the blue-green roof module. Source: Dadati & D’Amico, 2020, p.146.

In the examples encountered, water escapes from the module and flows over the roof surface. In the module presented here, the wood tank collects the excess water and, slowing down the precipitation pressure further, sends it to the main rainwater tank. It must be noted that, according to the typology of the roof, the upper part of the module can work and can be used independently. The module’s configuration causes the overflow process to start at a capacity of 6,8 l/m², while the amount of water stored in the tanks is 50 l/m². The process also contributes to slowing down runoff and reduces the amount of water conveyed into the traditional drainage networks.

Once the solution for the roof was identified and prototyped, the focus was on increasing the roof's permeable surface through the rain garden placement. The sizing was the first step of the design process. The surface area to contain the rain loads during a storm was sized (Figure 14). Only the two lateral pitches of the PEI Máquina Verde - El Arca roof (40 sqm) were considered to calculate the catchment area because they are the only ones equipped with gutters and downspouts. The average storm intensity (5.88 mm/h) was calculated based on the data collected from the central meteorological station of Cartagena de Indias: Rafael Nuñez, located in the city airport.

CATCHMENT AREA (1)

$$A_c = \text{length} \times \text{width} \times P_{\text{rain}} \times c_{\text{runoff}} = 5,93\text{m} \times 3,90\text{m} \times 1 \times 0,85 = 19,68 \text{ m}^2$$

TOTAL CATCHMENT AREA (2)

$$A_{\text{Clot}} = A_{C1} + A_{C2} = 19,68 \text{ m}^2 + 19,68 \text{ m}^2 = 39,36 \text{ m}^2 = 40 \text{ m}^2$$

P_{rain} = percentage of rain that ends up in the downpipe; the project provides only one downpipe per slope, so it is considered 1 (100%).
 c_{runoff} = runoff coefficient.

RAINFALL VOLUME (3)

$$V_{\text{runoff}} = A_{\text{Clot}} \times [I_{\text{mm}} / (t \times (1 \text{ m} / 1000 \text{ mm}))] \times t = 40 \text{ m}^2 \times [5,88 \text{ mm} / (1 \text{ h} \times (1 \text{ m} / 1000 \text{ mm}))] \times 1 \text{ h} = 2,73 \text{ m}^3$$

I_{mm} = average peak precipitation in 24 hours.
 t = time period considered for the duration of an event.
1m / 1000mm = conversion of the measurement units.

POOLING DEPTH (4)

$$d = 500 \text{ mm}$$

THE AREA OF THE RAINGARDEN (5)

$$A_{\text{garden}} = V_{\text{runoff}} / [d \times (1 \text{ m} / 1000 \text{ mm})] = 2,73 \text{ m}^3 / [500 \text{ mm} \times (1 \text{ m} / 1000 \text{ mm})] = 5,46 \text{ m}^2 = 6 \text{ m}^2$$

Figure 14 | Catchment area. Source: Dadati & D'Amico, 2020, p.149.

In the case study, the rain garden was placed on the wooden deck in a container made of the same planks removed from the wooden deck itself. In this way, it is not necessary to use additional material to that estimated for the construction of the prototype. The rain garden layers are featured as follows (from the bottom layer up): 1) waterproof membrane; 2) gravel; 3) pea-gravel; 4) sub-base of sand. Finally, the topsoil is made of 50% sand, 25% compost, and 25% loam (Figure 15). The rain garden is connected to the traditional rainwater collection system through pipes that run in a pipette to control the flow of water that reaches the module and its speed. The water starts to fill the container until it reaches the height of the pipette that connects all the systems to the rainwater tank. In this case, gutters supply the water, and then such water falls directly on the rain garden and the paved surfaces on the sides. Overall, the drained water

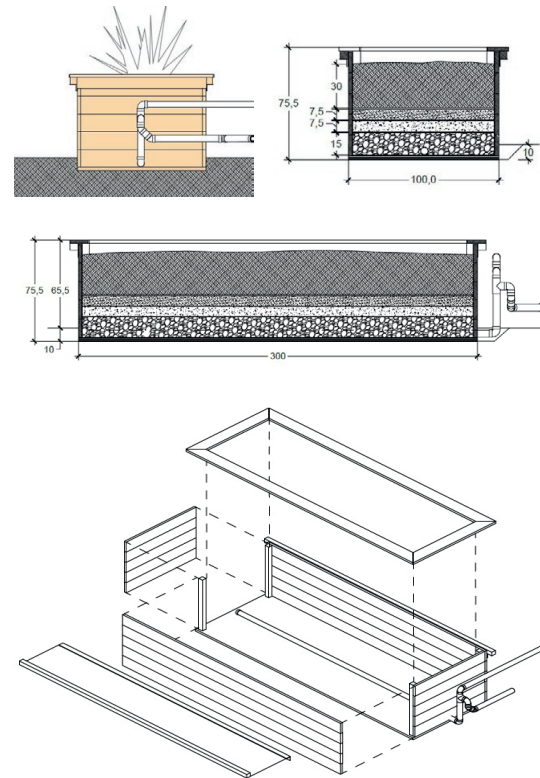

Figure 15 | Rain Garden Sections and exploded axonometric. Source: Dadati & D'Amico, 2020, pp.151-152.

amount is higher than a usual drainage system. As soon as the water level reaches 90 degrees, it starts to fill the pipes, reaching the primary supply system. An amount of the water will be absorbed by the ground, guaranteeing the nourishment of the plants (Figure 16).

Although the PEI Máquina Verde - El Arca project mainly focused on designing and constructing a single building (Figure 17), a part of the research work was devoted to understanding the relationship between the building and the surrounding urban space. Such analysis is relevant when it is intended to investigate how the nature-based solutions connect to other dwellings and the built environment.

Figure 18 and Figure 19 provide a proposed connection between the Natural-Based Solutions at the block and neighbourhood levels. While the blue-green roof modules and the rain gardens serving the one building, constitute adaptive actions for a single-family unit, a network of these, adequately connected, is a strategy that can promote health and well-being conditions for the entire community.

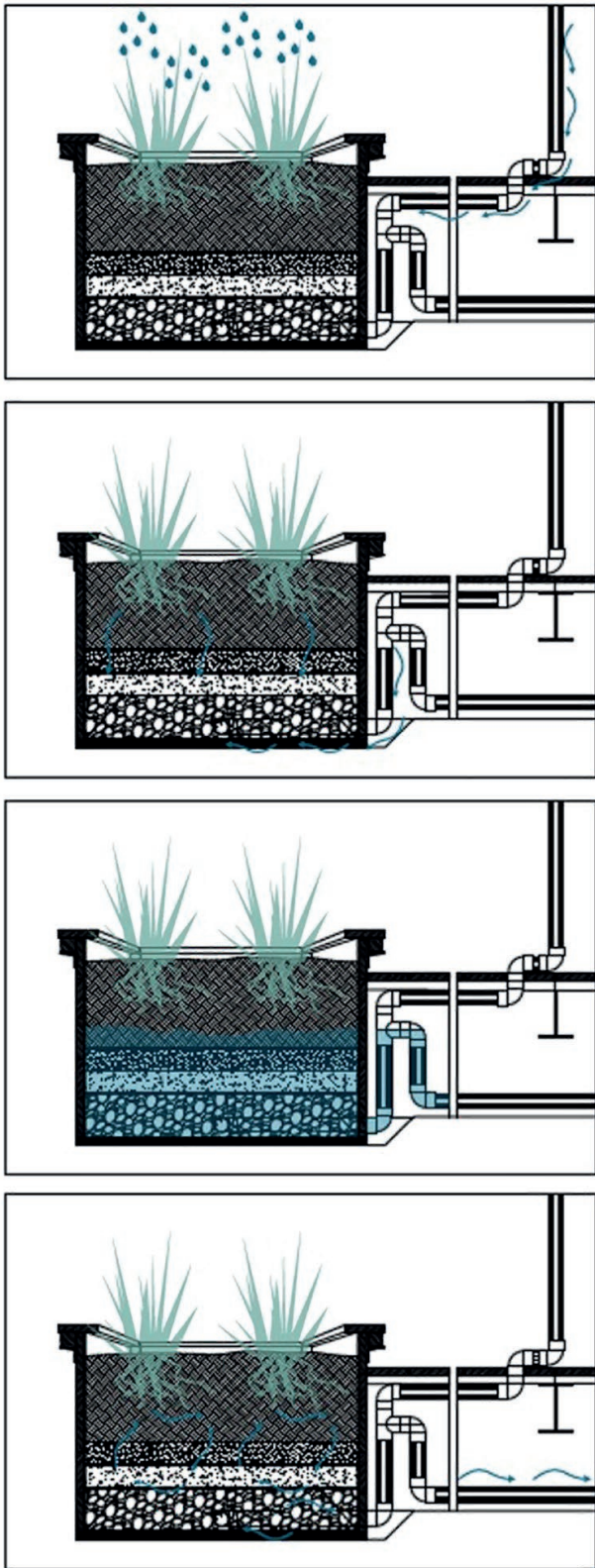

Figure 16 | The Rain Garden Functioning. Source: Dadati & D’Amico, 2020, p.153.

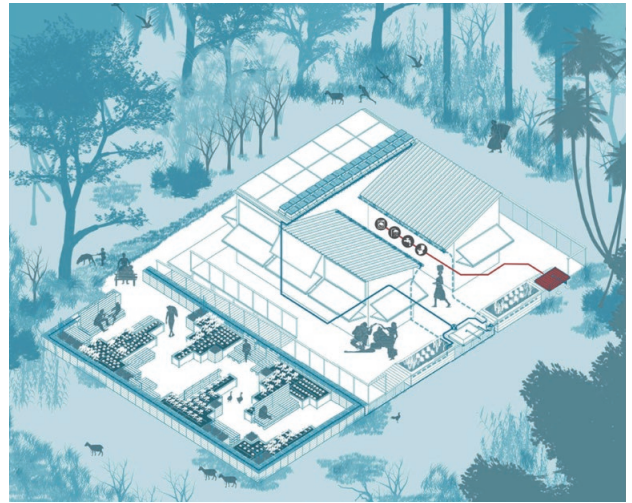

Figure 17 | The Vivienda Azul-Verde. Source: Dadati & D’Amico, 2020, p.162.

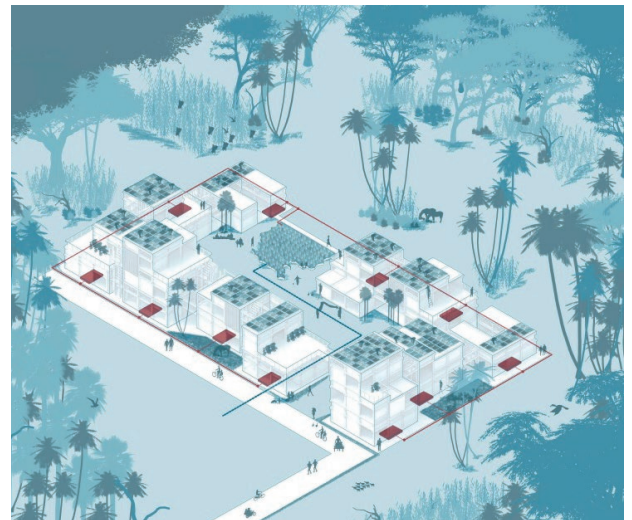

Figure 18 | The Manzana Azul-Verde. Source: Dadati & D’Amico, 2020, p.164.

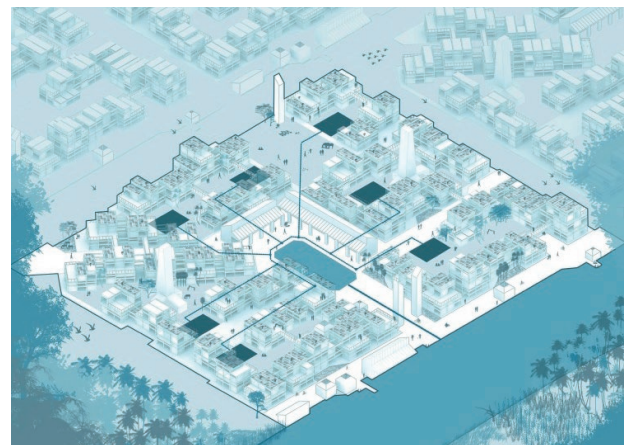

Figure 19 | The Archipiélago Azul-Verde. Source: Dadati & D’Amico, 2020, p.165.

6. Adaptive model to sanitary and climatic conditions

Being able to store and use rainwater for sanitation activities and growing fruits and vegetables in the domestic space contributes to ensuring that the “new normality” of informal neighbourhood residents is based on water security as well as on environmental health and resilience.

Our work focused on the impact of nature-based solutions at the project level. It sought to stimulate further insights into the effectiveness of self-building technological solutions and their performance at the macro-scale level.

The *PEI Máquina Verde – El Arca* adaptable living module was proposed to form an entire extension of *El Pozón*. In the same way, the blue-green roof technology module makes multi-scale its connotation. Although the focus of the study was the scale of the building, it is important to underline how the effectiveness of the proposed model increases proportionally with its application on a large scale. Therefore, the attempt was to present a pilot project based on the reference study (Figure 20) and use recycled materials to benefit the micro-system of the building and the macro-system of the neighbourhood.

It resulted in a research topic focused on a more comprehensive solution than the single modular technology. The blue-green roof module is just one of the possible solutions. In contrast, the methodology with which the research was approached, the materials, the module’s compositional characteristics, and the didactic function of the representation are intended to be an innovative proposal in sustainable design for the contemporary city.

Moreover, the general methodology adapted to the case study is conceived as flexible to other realities. In such realities, there is a tendency to search for local materials. The self-construction practice is also spreading, both as a necessity and design method attentive to environmental and social sustainability (Figure 21).

The prototype is a tangible example of self-construction: each material was selected considering the availability, which does not exclude a valorisation of available waste in the neighbourhood, and considering the costs, which are under 10 €/m² (EPA, 2008).

The blue-green roof module is a low tech, modular and scalable solution that can contribute to the mitigation of extreme stormwater events thanks to its drainage capacity. Furthermore, this technology decreases the impact of waste materials disposed of and enhances the value of water resources, in this case, the *La Virgen* swamp (Figure 22).

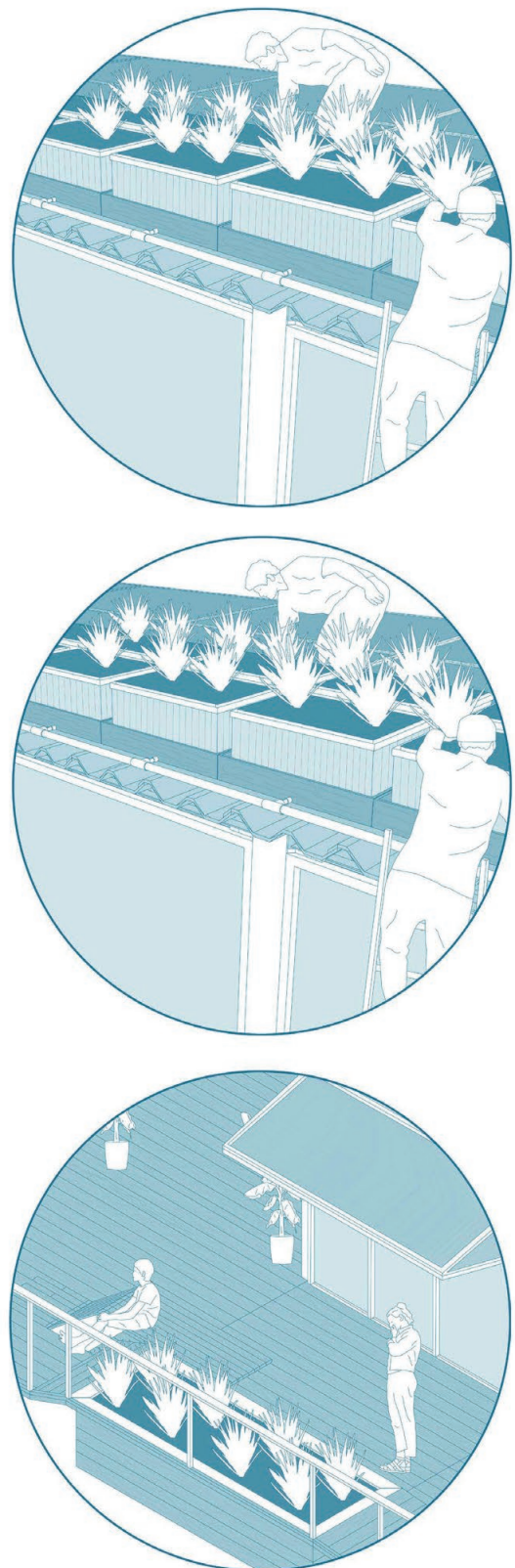

Figure 20 | Implementation of Natural-Based Solutions in *PEI Máquina Verde – El Arca* housing prototype. Source: Dadati & D’Amico, 2020, p.163.



Figure 21 | Blue-Green Roof Module prototype with recycled materials. Source: Dadati & D’Amico, 2020, p.147.

7. Conclusions

The development of the Blue-Green Roof module was carried out during the first six months of the pandemic, which generated a change in the initial approach, extending the original purpose to be an adaptive strategy for climate and health conditions.

The collection of rainwater for irrigation reuse and attached to the building systems of the PEI team’s urban proposal would avoid using the scarce drinking water that reaches the neighbourhood through the network or the inhabitants’ initiative. Furthermore, the cultivable rain gardens could provide essential food to the community.



Figure 22 | The constructed Blue-Green Roof Module prototype. Source: Caterina Dadati and Marco D’Amico.

They foster sociality and exchange within the *archipelagos* and promote economic independence.

These objectives align with SDG 6 of the United Nations: “Water and Sanitation” and SDG 2: “End hunger, achieve food security and improved nutrition and promote sustainable agriculture”. Beyond the practical result, they can trigger a radical change in the inhabitants’ behaviour, as they are directly involved in the construction and management of the technological system, being the leading actors of the change.

The pandemic has exacerbated the problems linked to the wholesomeness of life, particularly in informal settlements such as the one analysed. In addition to emergency measures, it is necessary to build, as a long-term goal, greater resilience through improving the quality of the built environment and a more conscious behaviour of the inhabitants. The developed nature-based technologies contribute in such a double direction, thanks to the bottom-up approach with which it is conceived.

The research certainly opens up a development perspective linked to large-scale experimentation of technology through a self-construction process with the inhabitants. The strength of the project design concept is the definition of the several technical elements' performance and the possibility of adapting it based on materials and elements available on site, keeping as a priority the actual feasibility with local know-how and resources through a user-centred approach.

A further development perspective is applying the same design approach to other technological systems of the house, such as solar thermal systems and technical elements, to improve the efficiency of the building envelope.

In informal contexts, it is not easy to intervene by applying “exotic” models and adapting technologies and solutions from other contexts; since they often do not find the proper support from the local social and technological support network. Improving housing quality contributes to making settlements more resilient and strengthening cooperation and social cohesion, which have proved to be fundamental in the pandemic period. Thus, a new research topic might be introduced related to the adaptation meaning and its relation to building, which was not fully addressed in the SDLA&C 2019 project.

Notes

- ¹ Removal of impervious pavements to reduce stormwater effects, increasing the land available for vegetation. (Iserhott et al., 2013)
- ² Characterised by an “involuntary informality”, meaning the one that individuals must resign themselves to accept because of their extreme poverty (Torres, 2009, p. 47).
- ³ According to the International Labour Organization (2020), by April 2020, 1.6 billion informal workers were already affected by the COVID-19 pandemic.
- ⁴ Information was obtained from interviews with the sector inhabitants and verified through journals and news reports of the time.
- ⁵ The project finished second in the overall ranking: a goal achieved thanks to the many prizes won during the competition: 2 first places in the “Engineering & Construction” and “Urban Design & Affordability” categories, 4-second places in the “Architecture”, “Innovation”, “Energy efficiency”, “Energy consumption” and a third place in the “Communication, marketing and social awareness” category, for a total of 7 awards in the ten evaluation categories.

Contributes: The authors collaborated on designing and constructing the *PEI Máquina Verde - El Arca* building, which participated and won second place in the international Solar Decathlon Latin America & Caribbean 2019 competition. This academic experience was part of the Joint Research Project initiated in 2017 between *Politecnico di Torino* and *Pontificia Universidad Javeriana* of Bogotá and funded by *Compagnia di San Paolo*¹¹ [11]. The information regarding the Natural-Based Solutions project was the subject of specific insights from the *Politecnico di Torino* research team. This in-depth study resulted from the Master's thesis of students Caterina Dadati and Marco D'Amico, and the presentation of some findings in the XI International Symposium on Environmental Engineering SIDISA 2021 held in Turin.

Acknowledgements: We want to thank the inhabitants of *El Pozón* who kindly opened their doors to us, especially Mirian Correa, community leader and our guide. We also want to thank Prof. Carlos Hernández of the Pontificia Universidad Javeriana of Bogotá, who led the interdisciplinary and inter-university work team that participated in the Solar Decathlon Latin America & Caribbean competition 2019. Special thanks to Marco D'Amico for his contribution to the design and construction phases of the *PEI Máquina Verde - El Arca* housing prototype and his research focused on integrating Natural-Based Solutions into the project.

- ⁶ e.g. Modular Green Roof Tray BZ1050 and Modular Green Roof Tray BZ2050. Dimension: 50x50 cm. Height: 10-20 cm. Company: Baozhen Technology co. City: Fujian (China). The trays are produced by modular design and are made of High-Density Polyethylene (HDPE) that presents high impact resistance, strong mechanical properties and toughness.
- ⁷ While the models on the market have particular physical characteristics, patents focus primarily on innovation in the context of the material. All patents can be found on Google Patent (www.google.com/?tbn=pts) using the reference number -e.g. Patent No.: US 7,596,906 B2.
- ⁸ Information retrieved from <https://www.ifad.org/en/web/operations/w/country/colombia>. Accessed April 5th, 2022.
- ⁹ Unfortunately, this practice contradicts the poor maintenance and the degradation of the almost non-existent public vegetation in the neighbourhood.
- ¹⁰ “Climate change, water pollution and the drivers of biodiversity loss, such as deforestation and illegal wildlife trade, may increase the risk of further pandemics, such as vector-borne or water-borne infections” (OECD, 2020: 1).
- ¹¹ For more information, see https://www.researchers.polito.it/en/funds_training/projects_and_strategic_initiatives_at_politecnico/call_for_joint_projects_for_the_internationalization_of_research

References

- Acevedo, I., Castellani, F., Lotti, G., & Székely, M. 2021 *Informalidad en los tiempos del COVID - 19 en América Latina: implicaciones y opciones de amortiguamiento*. Oficina de Planificación Estratégica y Efectividad en el Desarrollo. Bogotá: Banco Interamericano de Desarrollo. [WWW document]. URL <https://publications.iadb.org/publications/spanish/document/Informalidad-en-los-tiempos-del-COVID-19-en-America-Latina-Implicaciones-y-opciones-de-amortiguamiento.pdf> (accessed 31 march 2022).

- Agrawala, S., Dussaux, D., & Monti, N. 2020. 'What policies for greening the crisis response and economic recovery? Lessons learned from past green stimulus measures and implications for the COVID-19 crisis'. In: OECD, *Environment Working Papers*, No. 164, OECD Publishing, Paris. <https://doi.org/10.1787/c50f186f-en>
- Ayala García, J., & Meisel Roca, A. 2017. 'Cartagena libre de pobreza extrema en 2033'. *Revista del Banco de la República*, 901076, 9-28. [WWW document]. URL <https://publicaciones.banrepcultural.org/index.php/banrep/article/view/15617/16016> (accessed 31 march 2022).
- Corburn, J., Vlahov, D., Mberu, B., Riley, L., Teixeira Caiaffa, W., Faiz Rashid, S., Ko, A., Patel, S., Jukur, S., Martínez-Herrera, E., Jayasinghe, S., Agarwal, S., Nguendo-Yongsi, B., Weru, J., Ouma, S., Edmundo, K., Oni, T., & Ayad, H. 2020. 'Slum Health: Arresting COVID-19 and Improving Well-Being in Urban Informal Settlements'. *Journal, Urban Health*, 97, 348–357. <https://doi.org/10.1007/s11524-020-00438-6>
- Dadati, C., & D'Amico, M. 2020. *The Vivienda Azul-Verde: a rainwater harvesting system for El Pozón, Cartagena de Indias*. M.Sc Thesis Politecnico di Torino, Torino.
- De Graaf, R. 2012. *Adaptive urban development. A symbiosis between cities on land and water in the 21st century*. Rotterdam University Press, Rotterdam.
- El Tiempo. (2020, May 27). Los seis barrios de Cartagena que Gobierno ordenó cerrar por covid-19. *El Tiempo*. URL <https://www.eltiempo.com/politica/gobierno/coronavirus-en-cartagena-ministerio-del-interior-cierra-seis-barrios-499908> (accessed 31 march 2022).
- Guarín Cobos A. 2003. Cartagena de Indias. Asentamientos informales en la década de los 9., *Bitácora Urbano Territorial*, 7(1), 101-109. URL <https://revistas.unal.edu.co/index.php/bitacora/article/view/18785> (accessed 31 march 2022).
- Hernández Correa, C., Bucheli Agualimpia, J., & Ramírez Ibañez, C. 2018. 'Emerging heritage and social appropriation experiences in Cartagena de Indias, Getsemaní and Bocachica by the international studies program, PEI and the Project New Territories & Emerging Cartographies'. In: A. Dameri, R. Giordano, S. Gron, P. Mellano, L. Rodelo Torres, & C. Rossi González, *The culture of the city*. Politecnico di Torino, Torino.
- International Energy Agency. 2020. Green stimulus after the 2008 crisis. Learning from successes and failures. IEA Brief [WWW document]. URL <https://www.iea.org/articles/green-stimulus-after-the-2008-crisis>
- International Labour Organization. 2020 Impact of lockdown measures on the informal economy. ILO Brief [WWW document]. URL https://www.ilo.org/wcmsp5/groups/public/---ed_protect/---protrav/---travail/documents/briefingnote/wcms_743523.pdf (accessed March 31 2022).
- Iserhott, H., Murphy, M., Nativ, M., Rosewall, E. 2013. *How to depave. The Guide to Freeing Your Soil*. Depave. [WWW document]. URL https://depave.org/wp/wp-content/uploads/2019/05/Depave-How-to-Depave-Guide-v3.4_16.pdf
- Organisation for Economic Co-operation and Development. 2020. From containment to recovery: Environmental responses to the COVID-19 pandemic. OECD Brief [WWW document]. URL https://read.oecd-ilibrary.org/view/?ref=126_126460-1tg1r2aowf&title=From-containment-to-recovery_Environmental-responses-to-the-COVID-19-pandemic
- Sánchez-Torres, R.M. 2017. 'Desigualdad del ingreso en Colombia: un estudio por departamentos'. *Cuadernos de Economía*, 36(72), 139-178. URL <https://doi.org/10.15446/cuad.econ.v36n72.65880>
- Semper, G. 1989. *The Four Elements of Architecture and Other Writings*. Trans. Harry F. Mallgrave and Wolfgang Herrmann. Cambridge University Press, New York. ISBN 0-521-35475-7
- Torres Tovar, C.A. 2009. *Ciudad informal colombiana. Barrios contruidos por la gente*. Universidad Nacional de Colombia, Bogotá.
- United Nations. 2015. *Paris Agreement*. United Nations Framework Convention on Climate Change COP 21. [WWW document]. URL https://unfccc.int/sites/default/files/english_paris_agreement.pdf
- United Nations Habitat. 2018. *Pro-poor Climate Action in Informal Settlements*. United Nations Human Settlements Programme. [WWW document]. URL https://unhabitat.org/sites/default/files/2019/05/pro-poor_climate_action_in_informal_settlements-.pdf (accessed March 31 2022).
- United Nations Office for Disaster Risk Reduction. 2020. The human cost of disasters. An overview of the last 20 years 2000-2019. [WWW document]. URL <https://www.undrr.org/media/48008/download>
- U.S. Environmental Protection Agency. 2008. Green Roofs. *Reducing Urban Heat Islands: Compendium of Strategies. Draft* [WWW document]. URL <https://www.epa.gov/heat-islands/heat-island-compendium>
- Zhuo Q. 2014. 'A Review of Sustainable Urban Drainage Systems Considering the Climate Change and Urbanization Impacts'. *Water*, 6, pp. 976-992. <https://doi.org/10.3390/w6040976>