

Techno-Economic Assessment of Deep Biogas Cleaning For Solid Oxide Fuel Cell Application

*Original*

Techno-Economic Assessment of Deep Biogas Cleaning For Solid Oxide Fuel Cell Application / Rozzi, Elena; Gandiglio, Marta; Lanzini, Andrea. - ELETTRONICO. - (2023), pp. 238-239. (Intervento presentato al convegno European Fuel Cell and Hydrogen 2023 (EFC23) tenutosi a Capri - Italy nel September 13th-15th).

*Availability:*

This version is available at: 11583/2982654 since: 2023-10-02T10:26:48Z

*Publisher:*

ENEA

*Published*

DOI:

*Terms of use:*

This article is made available under terms and conditions as specified in the corresponding bibliographic description in the repository

*Publisher copyright*

(Article begins on next page)



# European Fuel Cells and Hydrogen

PIERO LUNGI CONFERENCE

# BOOK OF PROCEEDINGS

September **13th-15th** 2023  
**Capri** / Italy



**ATENA**  
FUTURE TECHNOLOGY



Italian National Agency for New Technologies  
Energy and Sustainable Economic Development



Università degli Studi  
di Napoli Parthenope



A.D. 1908  
**unipg**  
UNIVERSITÀ DEGLI STUDI  
DI PERUGIA



# European Fuel Cells and Hydrogen

PIERO LUNGHI CONFERENCE

# Proceedings

OF THE 10<sup>TH</sup> EUROPEAN FUEL CELL PIERO LUNGHI CONFERENCE

To Piero Lunghi. We miss you a lot. To you our gratitude for ever.

This book is dedicated to the memory of Piero Lunghi, creator of the European Fuel Cell Technology and Applications Conference, dear friend and colleague, who prematurely passed away in a car accident on damned November 9, 2007.

Piero made significant contributions in the field of fuel cells in the course of his too short career. He was the leading figure in the formation of the fuel cell research group at the University of Perugia and several activities and research projects initiated by him are still ongoing.

This means that, thanks to Piero, many young people are working in this exciting research field and are coming to Naples to present their results. Therefore, Piero's memory is in the conference name but Piero's contribution is still in the contents of this book.

The memory of our friend Piero, his great personal generosity and energy, survives in our hearts, his contribution and his tenacity survive in the work of young people who carry on his vision throughout the world.

Give them your passion, your strength, and make all necessary effort to realize them. There is no greater satisfaction than seeing one's ideas become reality and become part of the future of our world.

Piero strongly desired this, and constantly followed this through with conviction, passion and dedication.

For a better future, we need young researchers of this kind.



# European Fuel Cells and Hydrogen

PIERO LUNGHI CONFERENCE

CAPRI, GRAN HOTEL QUISISANA  
13 > 15 September, 2023

edited by  
Viviana Cigolotti, Francesco Marino  
2023

## ENEA

ITALIAN NATIONAL AGENCY FOR NEW TECHNOLOGIES, ENERGY  
AND SUSTAINABLE ECONOMIC DEVELOPMENT

Lungotevere Thaon di Revel, 76 / 00196 / Rome

**ISBN 978-88-8286-446-0**

### SUPPORTED BY



MINISTERO DELL'AMBIENTE  
E DELLA SICUREZZA ENERGETICA



ATENA  
FUTURE TECHNOLOGY



Italian National Agency for New Technologies  
Energy and Sustainable Economic Development



Università degli Studi  
di Napoli Parthenope



A.D. 1808  
unipg  
UNIVERSITÀ DEGLI STUDI  
DI PERUGIA



# European Fuel Cells and Hydrogen

PIERO LUNGI CONFERENCE

## Organizers



**Viviana**  
**CIGOLOTTI**

**Chairman of the Conference**  
**ENEA - Italy**



**Elio**  
**JANNELLI**

**Dept. of Engineering**  
**University of**  
**Naples "Parthenope"**  
**ATENA Scarl Italy**



**Massimiliano**  
**Della Pietra**  
**ENEA - Italy**



**Adele**  
**PIANESE**  
**University of**  
**Naples "Parthenope"**



# European Fuel Cells and Hydrogen

PIERO LUNGI CONFERENCE

## Committee

**Austria** Dr. Günter R. Simader / Austrian Energy Agency **Chile** Dr. Ana María Ruz Frias / Chilean Economic Development Agency - CORFO **France** Dr. Laurent Antoni / CEA, IPHE , Dr. Mathias Gérard/ CEA **Finland** Dr. Jari Kiviaho / VTT Technical Research Center of Finland, Dr. Marcus Rautanen / VTT Technical Research Center of Finland **Germany** Dr. Ing. Mihails Kusnezoff / Fraunhofer-Institut für Keramische Technologien und Systeme IKTS, Dr. Can Remzi Samsun / Forschungszentrum Jülich (FZJ) **Greece** Dr. Thanos Stubos / NCSR; Prof. Panagiotis Tsiakaras University of Thessaly **India** Prof. Dharam Buddhi / Uttaranchal University **Italy** Dr. Antonino Aricò / CNR ITAE, Prof. Linda Barelli / Università degli Studi di Perugia, Dr. Andrea Baricci / Politecnico di Milano, Dr. Marcello Baricco / Università di Torino, Prof. Domenico Borello / Università di Roma "La Sapienza", Prof. Barbara Bosio / Università di Genova, Prof. Stefano Campanari / Politecnico di Milano, Dr. Luigi Crema / Fondazione Bruno Kessler , Dr. Pierangela Cristiani RSE - Ricerca sul Sistema Energetico spa, Prof. Umberto Desideri / Università degli Studi di Pisa, Prof. Vito Di Noto / Università di Padova , Dr. Giorgio Graditi / ENEA, Dr. Adolfo Iulianelli / CNR ITM, Prof. Aristide Massardo / Università di Genova, Prof. Nicola Massarotti / Università di Napoli "Parthenope" , Prof. Mariagiovanna Minutillo / Università di Napoli "Parthenope" , Dr. Giulia Monteleone / ENEA, Prof. Vincenzo Palma / Università degli Studi di Salerno, Prof. Alessandra Perna / Università degli Studi di Cassino , Prof. Cesare Pianese / Università degli Studi di Salerno, Prof. Massimo Santarelli / Politecnico di Torino, Dr. Vinod Kumar Sharma / ENEA, Prof. Giuseppe Spazzafumo / Università degli Studi di Cassino, Prof. Gaetano Squadrito / CNR ITAE, Dr. Rodolfo Taccani / Università di Trieste, Prof. Stefano Ubertini / Università della Toscana, Dr. Bianca Maria Vaglieco / STEMS Istituto Motori **Japan** Dr. Eiji Ohira / NEDO New Zealand, Prof. Jim Hinkley / Victoria University of Wellington **Norway** Dr. Marie-Laure Fontaine / SINTEF **Poland** Dr. Marcin Błesznowski / Institute of PowerEngineering – IPE, Dr. Jakub Kupecki / Institute of Power Engineering - IPE **Portugal** Dr. Carmen Rangel / LNEG - National Laboratory of Energy and Geology **Spain** Prof. Justo Lobato Bajo / University of Castilla-La Mancha, Dr. Emilio Nieto Gallego / Centro Nacional del Hidrógeno (CNH2) **South Korea** Dr. Jonghee Han / Kentech **Sweden** Dr. Martin Andersson / Lund University, Dr. Carina Lagergren / KTH, **Turkey** Dr. Fehmi Akgun / TUBITAK Marmara Research Center, Dr. Isil Isik-Gulsac / Tubitak MAM, Dr. Cigdem Karadag / TUBITAK Marmara Research Center, **United Kingdom** Prof. Mirella Di Lorenzo / University of Bath, Prof. John Irvine / University of St Andrews, Prof. Vladimir Molkow / University of Ulster **USA** Prof. Jack Brouwer / University of California Irvine, Dr. Whitney Goldsborough Colella / Gaia Energy Research Institute



# European Fuel Cells and Hydrogen

PIERO LUNGI CONFERENCE

CAPRI, GRAN HOTEL QUISISANA  
13 > 15 September, 2023

## TOPICS

### HYDROGEN PRODUCTION

Electrochemical and thermochemical devices and processes: New materials and catalysts / Modelling from molecular to system scale / Stacks, cells, reactors and component manufacture and testing / Diagnostics and Process control, system engineering, hybridization / Market and Deployment, demonstration and real-world experience

### HYDROGEN STORAGE AND HANDLING

All forms of hydrogen carriers (gas, liquid, solid): stored, transported and distributed / New materials, catalysts and composites / Modelling from molecular to system scale / Component manufacture and technology testing / Diagnostics and Process control, system engineering, hybridization / Market and Deployment, demonstration and real-world experience

### HYDROGEN CONVERSION

Fuel cells, turbines, engines and burners / New materials, catalysts and composites / Modelling from molecular to system scale / Component manufacture and technology testing / Diagnostics and Process control, system engineering, hybridization / Market and Deployment, demonstration and real-world experience

### BIOLOGICAL PROCESSES IN THE GREEN HYDROGEN VALUE CHAIN

Biological processes for hydrogen production, fuel production, power production, Microbial & Enzymatic Bioelectrochemical Systems, energy harvesting and resource recovery. New materials and composites / Modelling from molecular to system scale / Component manufacture and technology testing / Diagnostics and Process control, system engineering, hybridization / Demonstration and real-world experience

### HYDROGEN MOBILITY

Vehicles, vessels and rolling stock - development, deployment and refuelling / New materials and catalysts / Modelling from cell to system scale / System and component manufacture and testing / Diagnostics and Process control, system engineering, hybridization / Market and Deployment, demonstration and real-world experience

### HYDROGEN FOR INDUSTRY

Decarbonizing steel manufacturing, refineries, chemical processes, high-temperature industrial heat / Manufacturing processes and upscaling / Modelling from molecular to system and infrastructural scale / Diagnostics and Process control, system engineering, hybridization / Market and Deployment, demonstration and real-world experience

### INTEGRATED HYDROGEN SYSTEMS

Integrating H<sub>2</sub>+RES technologies; Power-to-X pathways, Hybrid (micro)grids with hydrogen technologies; Grid balancing and curtailment; Multi-energy systems, Hydrogen Valleys - matching production and end use / System engineering, system modelling / Control systems, control algorithms & logics / Techno-Economic Analysis, Thermo-economic analysis, Exergo-economic analysis / Market and Deployment, demonstration and real-world experience

### CROSS-CUTTING AND OVERARCHING

Roadmaps, strategies and national plans / Energy system modelling / Market analysis / Sustainability analysis (LCA and Social LCA) / Education and training / Legal and administrative practice / Regulation, Codes and Standards (RCS) / Safety



# European Fuel Cells and Hydrogen

PIERO LUNGI CONFERENCE

## SPONSORED BY



## SUPPORTED BY



REGIONE CAMPANIA



MINISTERO DELL'AMBIENTE  
E DELLA SICUREZZA ENERGETICA



L'informazione b2b sulla filiera dell'idrogeno



Hydrogen Europe  
Research

## ORGANIZED BY



ATENA  
FUTURE TECHNOLOGY



Italian National Agency for New Technologies,  
Energy and Sustainable Economic Development



Università degli Studi  
di Napoli Parthenope



A.D. 1508  
unipg

UNIVERSITÀ DEGLI STUDI  
DI PERUGIA





# European Fuel Cells and Hydrogen

PIERO LUNGI CONFERENCE

**MAIN SPONSOR**



The Clean Hydrogen Partnership (as per its legal name Clean Hydrogen Joint Undertaking) is a unique public private partnership supporting research and innovation (R&I) activities in hydrogen technologies in Europe.

Its aim is to strengthen and integrate EU scientific capacity, in order to accelerate the development and improvement of advanced clean hydrogen applications. The three members of the Joint Undertaking are the European Union, represented by the European Commission, the fuel cell and hydrogen industries represented by Hydrogen Europe and the research community represented by Hydrogen Europe Research.

The research and innovation activities of the Clean Hydrogen JU are guided to a large extent by EU's Hydrogen Strategy and the policy developments in this context, contributing to its implementation. Its main focus is on renewable hydrogen production, as well as hydrogen transmission, distribution and storage, alongside selected fuel cell end-use technologies in transport, buildings and industry

For more information please consult: [www.clean-hydrogen.europa.eu](http://www.clean-hydrogen.europa.eu)



**ATENA**  
FUTURE TECHNOLOGY



Italian National Agency for New Technologies,  
Energy and Sustainable Economic Development



Università degli Studi  
di Napoli Parthenope



A.D. 1308  
**unipg**  
UNIVERSITÀ DEGLI STUDI  
DI PERUGIA



# European Fuel Cells and Hydrogen

PIERO LUNGI CONFERENCE

# Proceedings

OF THE 10<sup>TH</sup> EUROPEAN FUEL CELL PIERO LUNGI CONFERENCE



ATENA  
FUTURE TECHNOLOGY



Italian National Agency for New Technologies,  
Energy and Sustainable Economic Development



Università degli Studi  
di Napoli Parthenope



A.D. 1308  
unipg  
UNIVERSITÀ DEGLI STUDI  
DI PERUGIA



# European Fuel Cells and Hydrogen

PIERO LUNGI CONFERENCE

# Contents



ATENA  
FUTURE TECHNOLOGY



Italian National Agency for New Technologies,  
Energy and Sustainable Economic Development



Università degli Studi  
di Napoli Parthenope



A.D. 1308  
unipg  
UNIVERSITÀ DEGLI STUDI  
DI PERUGIA

## Table of Content

<b>TOPIC 1: HYDROGEN PRODUCTION</b> .....	<b>17</b>
A cost-effective green hydrogen production by proton exchange membrane water electrolysis (PEMWE).....	18
Characterization of $Sr_{0.7}Ce_{0.3}MnO_{3-\delta}$ as Co-free oxygen electrode material for solid oxide cells.....	20
Copper-based single and double perovskites electrodes for solid oxide cells.....	22
Lignin based future catalysts for hydrogen production .....	24
Hydrogen production by cellulose aqueous phase reforming overlaid double hydroxide-derived catalysts .....	26
Hydrogen production by glycerol photoreforming over different Pt/TiO <sub>2</sub> catalysts .....	28
Ultrapure Hydrogen from Syngas with a Composition Typical of Biomass Gasification and Conditioned in Pd/Ag Membrane Reactor .....	30
Production Of Hydrogen-Rich Syngas from Biomass Gasification by Double Step Steam Catalytic Tar Reforming.....	32
Innovative Hybrid Anodic Electrode For Water Electrolysis: Synergistic Combination Of Magnesium Ferrite, Hard Carbon, And Ruthenium Oxide For Enhanced Electrochemical Efficiency.....	34
Numerical and experimental investigation of the effect of gas flow configuration on the performance of a solid oxide electrolyzer .....	36
Experimental Evaluation of a Power-to-Gas System for Green Hydrogen Production.....	38
Compositional analysis of SOFC short stacks operating under different feedstocks: experimental analysis and model-based interpretation.....	40
Microscale Modelling of Two-phase Transport in Porous Transport Layers in Water-Electrolysis Processes.....	42
Three dimensional CFD simulation of polypropylene steam gasification in a bench scale rig .....	44
Carbon-Free Hydrogen Generation via Biogas Steam Reforming in Membrane Reactors: from Single Stage to Integrated Systems .....	48
ADVANCEPEM project: A cost-effective and pressurized green hydrogen production by PEM water electrolysis .....	50
Enhancement of Thermophysical Properties and Assessment of Heat-Transfer by Ti- And Si-Based Nanofluids for Fuel-Cell Cooling.....	52
Molten Carbonate Reversible Cells for carbon capture .....	54
Accelerated Stress Test Protocols for SOFC.....	56
Multi-Flanges for intensive cell development and LCT for Large cell and stack evaluation .....	58
Performance of Reversible MCFC Fueled By Raw Gas from Biomass Gasification .....	60
Validation of Solid Oxide Fuel Cell short Stack test bench in SO-FREE Project .....	62



# European Fuel Cells and Hydrogen

PIERO LUNGI CONFERENCE

September 13th-15th 2023  
Capri / Italy

Supporting research & innovation of hydrogen technologies through EU-wide harmonisation - developing terminology, testing protocols, test procedures and methods for performance and durability of electrolysis cells and electrolyser stacks.....	64
3D Additive Manufacturing of Bipolar Plates for PEMFCs .....	67
Hydrogen enriched syngas from integration of thermochemical processes: devolatilization of softwood waste/coffee grounds pyrolysis char .....	69
Experimental investigation of green hydrogen production via Molten Carbonate Electrolysers directly coupled with PV .....	73
Continuous Bunsen reaction of the Sulfur – Iodine thermochemical cycle for the production of green H <sub>2</sub> : Experimental and Modelling.....	75
Technological Pathways to produce compressed and highly pure Hydrogen from solar power.....	77
Analysis of Testing Conditions Variability on ECM Parameters Identification from EIS Measurements of SOEC Stack .....	78
Analysis of an MCEC using the Distribution of Relaxation Time technique.....	80
Hydrogen Production Systems – a Review.....	82
Hydrogen in a future energy system – Business models and application in the transport sector .....	84
Levelized cost of hydrogen with different water electrolysis technologies: a comparison review .....	86
<b>TOPIC 2: HYDROGEN STORAGE AND HANDLING .....</b>	<b>88</b>
Innovative Nanostructured Oxygen Electrodes for Solid Oxide Cells.....	89
CVD Grown Graphene for Anticorrosive Layers in Hydrogen Transport and Distribution Pipelines .....	91
Experimental Thermal Conditioning of Metal Hydrides Canisters for Hydrogen Storage.....	93
A Numerical Investigation of Underground Hydrogen Storage .....	95
Thermal management strategies for a high-capacity H <sub>2</sub> stationary storage system with metal hydride tanks .....	97
An innovative infrared thermal imaging method for hydrogen leakage detection in PEM fuel cells.....	99
Analysis of hydrogen/battery hybrid energy storage systems in building microgrids.....	101
<b>TOPIC 3: HYDROGEN CONVERSION .....</b>	<b>103</b>
Hydrogen crossover investigation at intermediate temperatures (IT) in PEMFCs.....	104
New PBI electrospun membranes for HTPEM-FCs applications .....	106
Crosslinked PVA films as an alternative PEM in LTFCs applications .....	108
Comparison of the fitting parameters of a semi-empirical polarization model applied to two anode supported Solid Oxide Fuel Cells for the determination of reaction mechanisms and kinetic parameters.....	110
Fibre shape effect on two-phase behaviour in gas diffusion layers and gas channels of PEMFCs – A numerical study .....	112
Reheating as an option to increase the efficiency of a novel power generation system based on ammonia oxy-combustion .....	116



# European Fuel Cells and Hydrogen

PIERO LUNGI CONFERENCE

September 13th-15th 2023  
Capri / Italy

Understanding Charge, Mass, and Heat Transfer in Fuel Cells for Transport Applications – Insights from the CAMELOT Project .....	118
Performance Assessment and Spectroscopic Studies of Solid Oxide Fuel Cells Operating With CO <sub>2</sub> -Rich Oxidizing Streams for an Innovative Hybrid Power Cycle.....	120
Fabrication and Characterization of Planar Electrolyte-Supported SOFCs Made By Tape Casting and Spraying Techniques .....	126
Environmental Impacts on PEM-Fuel Cells in Maritime Application.....	128
CapLab: Electrochemical Cells.....	130
Development of matrices for Molten Carbonate Fuel Cells.....	132
A Unitized Reversible Fuel Cell For In Operando Sxas and Xas Analysis for Fuel Cells and Electrolyzers .....	134
Development of an Operating Strategy for PEM Fuel Cell Systems based on Real-time Fault Diagnosis.....	136
Innovative Model-Based Diagnostic Algorithm for Leakage Isolation and Identification in an SOFC System for Micro-CHP Applications .....	138
HT-PEFC based CCHP systems and operational strategies for datacenter energy savings and Net Zero achievement .....	140
Analysis of Signal Patterns by Load on Fuel Supply System and Fault Diagnosis Method Using It in PEMFC System Using Urban Gas .....	142
Development of a Highly Efficient Co-SOEC-Based Power-to-Liquid Plant .....	144
Designing for flexible use of hydrogen and natural gas: the SO-FREE project.....	146
From direct use of ammonia in solid oxide fuel cells to the next generation of ammonia fuel cell systems ....	148
<b>TOPIC 4: BIOLOGICAL PROCESSES IN THE GREEN HYDROGEN VALUE CHAIN.....</b>	<b>150</b>
Bioelectrochemical Systems – from fundamentals in robotics to real world applications.....	151
Optimization of ternary Biochar-Copper-Hydroxyapatite multicomposites composition to be used as cathodes for bioelectrochemical power to gas .....	152
Bioelectrochemical Power-To-Methane Approach in Double Pot Bioreactors.....	154
BIO-Hydrogen, the CNR activity in the framework of AdP-PNRR program .....	156
CO <sub>2</sub> capture by <i>Ralstonia eutropha</i> in Bioelectrochemical Systems (BESs) under different operational conditions.....	158
<b>TOPIC 5: HYDROGEN MOBILITY.....</b>	<b>160</b>
Design space exploration through Liquid H <sub>2</sub> tank preliminary sizing and Design of Experiments analysis ....	161
Accelerated Stress Testing for carbon supports using different ionomers in half-cell gas diffusion electrode setup .....	163
Spatially Resolved Catalyst Degradation in PEMFCs under Repetitive Start-Up and Shut-Down Operation ....	165
A Coupled 2D Macro-homogenous MEA model for Proton Exchange Membrane Fuel Cells.....	167
Multiphysics Modeling for Evaluating the Efficiency of Next-Generation PEM Fuel Cells for aviation.....	169



# European Fuel Cells and Hydrogen

PIERO LUNGI CONFERENCE

September 13th-15th 2023  
Capri / Italy

Methodology for design and optimization of straight parallel flowfield channels of PEM fuel cell .....	171
Limiting Factors and Mitigation Solutions for Freezing Conditions of Aeronautic PEMFC Systems .....	173
State-of-Health Observer for Polymer Electrolyte Membrane Fuel Cells .....	175
Real-time estimation of degradation in PEM fuel cells .....	177
Hydrogen fuel cells for decarbonizing inland waterway shipping .....	179
A Study on Performance Analysis of PEM Fuel Cell Using Real-Time Humidity Distribution Measurement ....	181
A novel hybrid method for PEMFC systems fault diagnosis .....	183
Development of a procedure for mixture formation analysis for H <sub>2</sub> DIICEs .....	185
Optimizing Hydrogen Refueling Station Infrastructure for Heavy Duty Freight Transport in Italy .....	187
Forecasting Of a Degradation Indicator for Proton Exchange Membrane Fuel Cells .....	189
Preliminary Techno-economic assessment on small scale Methanol-based-Solid Oxide Fuel Cell system for maritime application .....	192
Towards the design of a hydrogen-powered ferry for zero-emissions passenger transport .....	194
Innovative thermal management systems for fuel cell electric aircraft applications .....	196
Assessing the Competitiveness of Hydrogen Trains: Uncertainties, Sensitivity Analysis, and Regional Perspectives .....	198
BIIM - Design and development of an electric vessel equipped with Salt Battery, PEMFC and Metal Hydride Storage .....	200
FLAGSHIPS – Zero Emission Vessels for European Rivers .....	202
Economic and environmental life cycle assessment of diesel, natural gas, biomethane, electric and hydrogen bus systems for extra urban public transportation .....	204
SHIPFC: A European Project for Green Shipping .....	206
A comprehensive experimental investigation on the fuel cell powertrain of a yard tractor for sustainable port handling operations .....	207
<b>TOPIC 6: HYDROGEN FOR INDUSTRY .....</b>	<b>208</b>
Feasibility Analysis of Green Ammonia Production Based On Solid Oxide Electrolysis Cell Technology .....	209
Techno-economic Analysis and Optimization of Hybrid Energy Storage Systems for Decarbonization in Energy-Intensive Industries .....	211
<b>TOPIC 7: INTEGRATED HYDROGEN SYSTEMS .....</b>	<b>213</b>
Dynamic modeling and simulation of alkaline water electrolysis system .....	214
Reversible PEM Fuel Cell Modeling: A Comprehensive Analysis .....	216
Dynamic modeling of a solid oxide fuel cell system integrated with absorption chiller for ship propulsion ....	217
Dynamic simulation of PEM water electrolysis system with detailed 2D stack model .....	219
Hybrid energy storage with negative carbon emission combining renewables and hydrogen technologies ...	221



# European Fuel Cells and Hydrogen

PIERO LUNGI CONFERENCE

September 13th-15th 2023  
Capri / Italy

Vanadium Flow batteries: a path to long duration energy storage .....	223
Effect of Multifuel Approach on SOFC System Performance and Architecture Requirements .....	224
Analysis of on Board Liquid Hydrogen Cold Energy Utilization in Ship Fuel Cells Power Plants.....	226
Improving Energy Self-Sufficiency of a Multi-Energy System through Hydrogen Storage and Fuel Cell CHP....	228
A Comprehensive Classification of Hydrogen Refuelling Stations: Factors and Global Comparisons .....	230
Hydrogen Refuelling Procedures and Equipment for Aviation and Maritime Sectors: A Technical Overview and Regulatory Landscape .....	232
Designing and Sizing of a Green Liquid Hydrogen Supply Chain for Ship Refueling.....	234
Energy Management Control Strategies Addressing The rSOC Degradation Phenomena In A Polygeneration Microgrid.....	236
Techno-economic assessment of a concentrated solar heat supported high temperature electrolysis process using a thermal energy storage .....	238
Techno-Economic Assessment of Deep Biogas Cleaning For Solid Oxide Fuel Cell Application .....	240
Modelling green hydrogen systems in the decarbonization of hard-to-abate sectors: a case study on cement industry .....	242
Hydrogen: A Storage Solution of Renewable Energy for Habitable Mobile Modules. Life Zero energy mod Project.....	244
Hydrogen powered portable generators for the decarbonization of music festivals and outdoor events .....	246
TH2ICINO: Towards Hydrogen Integrated Economies in Northern Italy.....	248
<b>TOPIC 8: CROSS CUTTING AND OVERARCHING .....</b>	<b>250</b>
Digital twin of autonomous surface marine vehicles: RAISE experience.....	251
Enhancing Safety of Liquid and Vaporized Hydrogen Transfer Technologies in Public Areas for Mobile Applications.....	253
Green Hydrogen: a wider vision for policies .....	255
Does the Environmental Kuznets Curve Hypothesis Hold. Evidence from European countries.....	257
Determinants of the EU region's hydrogen technologies innovation .....	259
Planning the role of hydrogen in the Campania region smart energy transition .....	261
Hydrogen Valleys: a catalyst for advancing the global hydrogen value chain .....	263
The hydrogen role in the Italian energy system for Net-Zero CO <sub>2</sub> .....	265
On the use of ecosystemic knowledge approach for the definition of new guidelines for hydrogen as maritime fuel.....	267
The Viability of Climate Neutral Districts Integrating “Power on Demand” and “Power to Hydrogen” regimes: A Comparative Study of Simulation Tools.....	269
A multi-criteria design tool for performance comparison of innovative energy systems for maritime sector.....	271
Hydrogen as an export commodity – costs and energy retention of hydrogen carriers within the export value chain .....	273





# European Fuel Cells and Hydrogen

PIERO LUNGI CONFERENCE

September 13th-15th 2023  
Capri / Italy

Unsteady simulation of a gas pipeline considering several hydrogenblends.....	275
Assessing the relative importance of hydrogen for a decarbonizedItalian energy system through a model based scenario analysis.....	277
Exploring the Viability and Applications of Green Hydrogen: AComprehensive Assessment of Project Success .....	279
Enviromental And Economic Impact Assessment Of Using Fully Recycled Platinum As Catalyst In Pem Fuel Cells – A Review Study.....	281
The Carbon Footprint of Hydrogen Produced with State-of-the-Art Renewable Electricity in Italy Using Life Cycle Assessment Methodology .....	283
Novel Methods of Testing For Measurement of Natural Gas andHydrogen Mixtures (THOTH2) .....	285
Comparative Study of Metal Oxide Nanoparticle Composites forHydrogen Gas Sensing .....	287



# European Fuel Cells and Hydrogen

PIERO LUNGI CONFERENCE

September 13th-15th 2023  
Capri / Italy

## TOPIC 1: HYDROGEN PRODUCTION



## A cost-effective green hydrogen production by proton exchange membrane water electrolysis (PEMWE)

Stefania Siracusano <sup>\*a</sup>, Fausta Giacobello <sup>a</sup>, Antonino Aricò <sup>a</sup>

\* corresponding author: stefania.siracusano@itae.cnr.it

<sup>a</sup> CNR-ITAE Institute of Advanced Energy Technologies, National Research Council, Via Salita S. Lucia Sopra Contesse 5, 98126, Messina, Italy

*Keywords: Hydrogen production, Water electrolysis, Proton exchange membrane, Non-PGM catalysts.*

### **Abstract**

The present work provides an electrochemical single cell assessment of a non-PGM anode catalyst for PEM electrolysis applications. A solid-state procedure was used to obtain Ag/Ti-suboxides, from silver nitrate and titanium suboxides with Magneli phase. The thermal reduction process promoted the inclusion of silver within the Ti-suboxides. The MEA, consisting of Ag/Ti-suboxides anode, Pt/C cathode catalysts and 212 NAFION<sup>®</sup> membrane, showed promising performance and durability characteristics in comparison to analogues alkaline systems based on PGM-free catalysts. At 80 °C, performances, of 0.6 A cm<sup>-2</sup> at 2 V and 2 A cm<sup>-2</sup> at 2.2 V IR-free were observed together with an elevated stability during steady-state operation.

### **Introduction:**

Minimization of high-cost metal electrocatalyst is necessary to achieve cost-effective green hydrogen production by proton exchange membrane (PEM) water electrolysis (WE). The large increase of the cost of Ir recently observed [1] requires individuating alternative catalyst solutions for the oxygen evolution reaction (OER) in PEMWE. The OER is the rate determining step of the electrolysis process requiring high-cost noble metals with significantly highloading.

### **Material and methods:**

A non-platinum group metal (non-PGM) anode catalyst based on silver and titanium suboxide[2] was prepared and used for the oxygen evolution reaction in a PEMWE cell. By using a solid-state synthesis procedure, a silver nitrate and titanium suboxides (Ti<sub>n</sub>O<sub>2n-1</sub>) with



Magneli phase powders were mixed and subjected thereafter to a thermal treatment at 300 °C in a 50% H<sub>2</sub>/N<sub>2</sub> gas stream to promote the inclusion of silver within the Ti-suboxides structure. A membrane - electrode assembly (MEA), consisting of the anode Ag/ Ti<sub>n</sub>O<sub>2n-1</sub> and conventional Pt/C cathode catalysts deposited on a 212 NAFION® membrane (thickness 50 μm), was investigated to assess the performance and durability of the PGM free oxygen evolution catalyst in an acidic environment.

### Results:

A promising performance, of 0.6 A cm<sup>-2</sup> at 2 V/cell at 80 °C, and an excellent stability (degradation rate < 14 μV/h during a 1000 h test) were achieved for the electrolysis cell based on a cost-effective metal anode electrocatalyst.

Post operation analysis showed some catalyst agglomeration and migration of silver onto the membrane which was indicative of lower interaction with the TiOx phase. An increase of the oxidation states for Ag and Ti was also observed. However, such modifications did not produce relevant performance losses. In general, there is still a good possibility of improving catalyst properties in terms of dispersion, particle size and interface with the solid polymer electrolyte in a PEM electrolysis cell.

### Conclusions:

the developed Ag/TiOx catalyst effectively requires some improvements before becoming a satisfactory replacement for the IrOx benchmark. Our work was essentially addressed to provide a basis for an alternative catalyst formulation that could undergo to successive amelioration. As mentioned above, the required improvements regard the achievement of a mesoporous catalyst morphology, a decrease of the particle size, a better inclusion of Ag in the Ti suboxide structure etc.

### Acknowledgment

The authors acknowledge the financial support from the PROMET-H2 project. This project has received funding from the European Union's Horizon 2020 research and innovation programme under grant agreement No 862253.

### References

- [1] <https://pmm.umicore.com/en/prices/>.
- [2] S. Siracusano, V. Baglio, C. D'Urso, V. Antonucci, A.S. Aricò, *Electrochim. Acta* 54 (2009) 6292–6299.



## Characterization of $\text{Sr}_{0.7}\text{Ce}_{0.3}\text{MnO}_{3-\delta}$ as Co-free oxygen electrode material for solid oxide cells

Yevgeniy Naumovich <sup>\*a,b</sup>, Dzyana Boiba<sup>c</sup>, Aleksey Yaremchenko<sup>c</sup>, Stanisław Jagielski<sup>a,b,d</sup>

\* corresponding author: Yevgeniy.Naumovich@ien.com.pl

<sup>a</sup> Institute of Power Engineering, Mory 8, 01-330 Warsaw, Poland

<sup>b</sup> CTH2 - Center for Hydrogen Technologies, Institute of Power Engineering, Augustowka 36, Warsaw 02-981, Poland

<sup>c</sup> CICECO - Aveiro Institute of Materials, Department of Materials and Ceramic Engineering, University of Aveiro, 3810-193 Aveiro, Portugal

<sup>d</sup> The Faculty of Power and Aeronautical Engineering, Institute of Heat Engineering, Warsaw University of Technology, Nowowiejska 21/25, 00-665 Warsaw, Poland

**Keywords:** anode, electrolysis, manganite, SOEC

### Abstract

Strontium-cerium manganite with perovskite structure was characterized as a possible anode for the high-temperature solid oxide electrolysis cells, including fuel-assisted electrolysis. It was demonstrated that  $\text{Sr}_{0.7}\text{Ce}_{0.3}\text{MnO}_{3-\delta}$  has thermal expansion matching that of zirconia and ceria-based electrolytes. Its stability enables operation under moderately reducing conditions, down to  $p(\text{O}_2)$  of  $10^{-16}$ - $10^{-18}$  atm at 700-800°C. The electrochemical performance of  $\text{Sr}_{0.7}\text{Ce}_{0.3}\text{MnO}_{3-\delta}$  anode can be efficiently enhanced by impregnation of  $\text{PrO}_x$  or GDC.  $\text{Sr}_{0.7}\text{Ce}_{0.3}\text{MnO}_{3-\delta}$  anode with  $\text{PrO}_x$  activation demonstrated an anodic overpotential of ~50 mV at 0.35 A/cm<sup>2</sup> at 750°C.

**Introduction:** Most efficient oxygen electrodes for solid oxide cells (SOC) are derived from cobaltites with perovskite structure. SOC stacks can be used for the generation of energy (SOFC), conversion of excessive green power to fuels or goods (SOEC), or for balancing the electric grids (rSOC). However, cobalt is one of the so-called critical raw materials, and its very modest supply is shared between the production of batteries, magnetic alloys, and special steels. Seeking for materials with a combination of properties, which allows replacing lanthanum strontium cobaltite (LSC) and cobaltite-ferrite (LSCF), becomes an actual problem with the growing demand for SOC stacks. One of the alternative options is  $\text{Sr}_{0.7}\text{Ce}_{0.3}\text{MnO}_{3-\delta}$  (SCM), a mixed ionic and electronic conductor with a perovskite structure. Contrary to the “classic” lanthanum-strontium manganites, which are pure electronic conductors,  $\text{Sr}_{0.7}\text{Ce}_{0.3}\text{MnO}_{3-\delta}$  demonstrates modest ionic conductivity, comparable with LSCF [1]. Due to higher stability to reduction, expected for manganites in comparison with Co-containing perovskites, SCM may be a possible solution for the anode of the fuel-assisted electrolyzer cells (SOFE), which are a promising solution for the conversion of the low-quality fuels to hydrogen [2, 3]. Characterization of SCM as a SOFC cathode was not fully successful, likely due to problems with the electrolyte-electrode interface [4, 5].

**Objectives:** The main objective of the present study was the characterization of  $\text{Sr}_{0.7}\text{Ce}_{0.3}\text{MnO}_{3-\delta}$  as a possible anode for the high-temperature electrolysis cells, in particular, for the fuel-assisted electrolysis.

**Material and methods:** Powder of the  $\text{Sr}_{0.7}\text{Ce}_{0.3}\text{MnO}_{3-\delta}$  was synthesized using the glycine-nitrate method with calcinations at 900-1300°C to obtain single-phase material. Gas-tight ceramic with a relative density of 94% was sintered for 5h at 1450°C in air. Button-size electrochemical cells were prepared using 8YSZ solid electrolyte in the shape of the disks with 1.0 mm thickness, with the  $\text{Ce}_{0.9}\text{Gd}_{0.1}\text{O}_{2-\delta}$  (GDC) Sr diffusion barrier, and Pt counter and reference electrodes. SCM electrodes were



sintered at 1000°C. Electrochemical measurements were conducted using Autolab AUTOLAB PGSTAT 302 galvanostat. The thermal and chemical expansion was measured using a Linseis L75 dilatometer. XRD data were collected on a Rigaku D/Max-B diffractometer. Electrical conductivity relaxation (ECR) measurements were done in the  $p(\text{O}_2)$  range of 0.002-0.21 atm at 800-950°C.

**Results:** SCM ceramics has a tetragonal perovskite structure (space group  $I4/mcm$ ). The average thermal expansion of SCM ceramics under oxidizing conditions at 30-1100°C is  $12.3 \times 10^{-6} \text{ K}^{-1}$ , i.e., it is compatible with  $\text{ZrO}_2$ ,  $\text{CeO}_2$  and  $\text{LaGaO}_3$ -based solid electrolytes. However, excessive chemical expansion was observed in reducing atmospheres, which may lead to delamination of the electrode layer at  $p(\text{O}_2) = 10^{-16}$ - $10^{-14}$  atm. Low- $p(\text{O}_2)$  phase stability limit corresponds to  $\sim 10^{-18}$  atm at 750°C, which may be acceptable for a SOFEC anode but not for a SOFC anode or SOEC cathode material. ECR measurements revealed that the ionic conductivity of SCM is ca.  $10^{-4}$ - $10^{-3} \text{ S/cm}$  at 875-950°C, which is more than an order of magnitude lower than the values observed for the LSCF and is in good agreement with published data [1]. Herewith, the surface exchange does not limit ionic transport, which can be considered a positive feature for the electrode material. Total conductivity in air is ca. 300 S/cm and decreases to 40 S/cm under reducing conditions. SCM demonstrated insufficient chemical compatibility with YSZ; reactivity products include  $\text{CeO}_2$ ,  $\text{SrMnO}_3$  and  $\text{SrZrO}_3$ . Electrochemical measurements showed that, while the polarization of the pristine SCM anode is relatively high, impregnation with GDC or  $\text{PrO}_x$  leads to a significant reduction in the polarization resistance, up to 10 times for the later activator. The anodic overpotential of the electrolyte-supported cell was as low as 50 mV at the current density of 0.35  $\text{A/cm}^2$  at 750°C and 0.50  $\text{A/cm}^2$  at 800°C. The first attempts to prepare electrode-supported cells using semi-commercial half-cells [6] were not successful due to excessive Sr diffusion through the GDC interlayer and reactivity with 8YSZ.

**Conclusions:**  $\text{Sr}_{0.7}\text{Ce}_{0.3}\text{MnO}_{3-\delta}$  demonstrates a moderate performance as an anode for SOEC and potentially SOFEC, which can be effectively enhanced by impregnation. The material shows good thermal compatibility with state-of-the-art electrolytes; however, high activity of Sr requires additional measures to protect 8YSZ from the formation of insulating interlayers.

**Acknowledgments:** This work was done in the scope of projects CARBOSTEAM (POCI-01-0145-FEDER-032295) and CICECO-Aveiro Institute of Materials (UIDB/50011/2020, UIDP/50011/2020 & LA/P/0006/2020) financed by the FCT/MCTES/FEDER, project UMO- 2018/30/M/ST8/00675 funded by the NCN, and project ACT-SOC funded by the FCT and NAWA (BPN/BPT/2021/1/00041/U/00001).

## References

- [1] Materials Letters 57 (2003) 3017– 3021, DOI: 10.1016/S0167-577X(02)01423-4
- [2] Int J Hydrogen Energy 28(2003) 483-490 DOI: 10.1016/S0360-3199(02)00135-0
- [3] Int J Hydrogen Energy 41 (2016) 11857 -1867 DOI: 10.1016/j.ijhydene.2016.05.205
- [4] Solid State Ionics 262 (2014) 349–353, DOI: 10.1016/j.ssi.2013.11.013
- [5] Russian Journal of Electrochemistry, 50 (2014), 713–718, DOI: 10.1134/S1023193514080084
- [6] "Research activity - Cerel" <https://cerel.pl/en/research-and-development/research-activity/> Viewed 27.04.2023.



## Copper-based single and double perovskites electrodes for solid oxide cells

Krystian Machaj<sup>a,b,c</sup>, Anna Niemczyka<sup>b</sup>, Piotr Winiarz<sup>d</sup>, Yevgeniy Naumovich<sup>a,b</sup>, Konrad Świerczek<sup>d</sup>, Ryszard Kluczowski<sup>e</sup>, Kun Zheng<sup>d</sup>

\* corresponding author: krystian.machaj@ien.com.pl

<sup>a</sup>Institute of Power Engineering, Department of High Temperature Electrochemical Processes

Mory 8 St., 01-330 Warsaw/Poland

<sup>b</sup>Center for Hydrogen Technologies CTH<sub>2</sub>, Institute of Power Engineering  
Augustówka 36 St., 02-981 Warsaw/Poland

<sup>c</sup>Wroclaw University of Science and Technology, Department of Cryogenics and Aerospace Engineering, Wybrzeze Wyspianskiego 27, 50-370 Wroclaw, Poland

<sup>d</sup>AGH University of Science and Technology, Krakow, Poland,  
Adam Mickiewicz 30 St., 30-059 Cracow/Poland

<sup>e</sup>Institute of Power Engineering, Ceramic Department CEREL,  
Techniczna 1 St., 36-040 Boguchwała/Poland

**Keywords:** *solid oxide cells, copper, air electrode, MIEC*

**Abstract:** Copper-based material with perovskite structure was characterized as a possible air electrode material for high-temperature solid oxide cells. It was demonstrated that LaNi<sub>0.5</sub>Cu<sub>0.5</sub>O<sub>3-δ</sub> oxide has chemical compatibility with a commonly employed CGO buffer layer. However, due to the low performance of cells using this material on the air electrode, single and double copper-based nickel-free perovskites were selected for further study.

**Introduction:** The significance of hydrogen to the world economy keeps growing. Between 2018-2020 alone, more than 20 significant government documents were issued to plan the deployment of hydrogen, and by the end of 2021, more than 30 countries had developed hydrogen strategies or were in the process of developing them [1,2]. Consequently, production of hydrogen, based on CO<sub>2</sub>-free processes, should increase considerably. One of the leading technologies being evaluated for widespread implementation in this field is Solid Oxide Electrolysis (SOE). Due to their excellent catalytic activity and high mixed ionic-electronic conductivity (MIEC), cobalt-based oxides with mixed ionic and electronic conductivity are state-of-the-art air electrode materials for SOC [3]. However, the predicted continuous growth of the demand in the next decades (related to the Li-ion batteries market), and the politically unstable location of main cobalt mines causes the high supply risk of cobalt. For that reason, cobalt has been listed as a critical raw material (CRM) by the European Union (EU) since 2020 [4]. In addition, toxicity of this material and the socioeconomic concerns



associated with its mining production are further impetuses for research and development of alternative air electrodes.

The copper-based materials seem to be a feasible and economically beneficial option alternative to the other air electrodes dedicated to SOC that have been proposed in the literature. With the implementation of copper, partial or complete replacement of cobalt is possible. In addition, the use of copper-based materials is justified by interesting physicochemical features of the parent  $\text{LaCuO}_3$  perovskites including high electric conductivity and significant catalytic activity. Previous research on  $\text{LaNi}_{0.5}\text{Cu}_{0.5}\text{O}_{3-\delta}$  oxide has demonstrated its chemical compatibility with a commonly employed CGO buffer layer. In addition, the potential of this material for use as an air electrode for SOC operating in both modes was confirmed [5].

**Objectives:** The main objective of the present study was the characterization of copper-based materials as a possible air electrode for the high-temperature solid oxide cells.

**Material and methods:** In this work Cu-based single and double perovskites, from  $\text{La}_{1-x}\text{Ba}_x\text{CuO}_{3-\delta}$  and  $\text{LnSr}_{0.5}\text{Ba}_{0.5}\text{CoCuO}_{5+\delta}$  (where Ln: Sm, Gd, Pr, Nd) groups, respectively, were assessed in terms of their physicochemical properties – structure, stability, and transport properties. The selected oxides, characterized with the most promising properties, were used for preparation of the fuel electrode-based cells with size of  $5 \times 5 \text{ cm}^2$ . The preliminary electrochemical studies of developed SOCs included measurements of current density-voltage curves and electrochemical impedance spectra (EIS) in 650-800 °C temperature range in electrolyze and rSOC modes. The studies were supplemented with analysis of microstructure of as-prepared and after testing cells extended by SEM-EDS analysis.

**Results and Conclusions:** Physical and chemical properties of obtained materials confirmed that proposed Cu-based oxides with perovskite related structure seem to be suitable for SOC applications. As presented for symmetrical electrolyte-based cells the polarization resistivity ( $R_p$ ) of air electrode can reach values below  $0.15 \Omega \text{ cm}^2$  at 700°C. For  $\text{La}_{1-x}\text{Ba}_x\text{CuO}_{3-\delta}$ ,  $R_p$  was determined to be  $0.041 \Omega \text{ cm}^2$  at 700°C. For  $\text{GdSr}_{0.5}\text{Ba}_{0.5}\text{CoCuO}_{5+\delta}$  and  $\text{SmSr}_{0.5}\text{Ba}_{0.5}\text{CoCuO}_{5+\delta}$  w 700°C  $R_p$  was  $0.126 \Omega \text{ cm}^2$  and  $0.124 \Omega \text{ cm}^2$  respectively.

**Acknowledgment:** This project was financially supported by the National Science Centre, Poland, within project no. 2020/37/B/ST8/02097.

## References

- [1] IRENA. Geopolitics of the energy transformation: the hydrogen factor. 2022.
- [2] IRENA. Green hydrogen: A guide to policy making. 2020.
- [3] Vinoth Kumar R et al. Renewable and Sustainable Energy Reviews 2022;156.
- [4] European Commission. COMMITTEE AND THE COMMITTEE OF THE REGIONS Critical Raw Materials Resilience: Charting a Path towards greater Security and Sustainability 1. n.d.
- [5] Niemczyk A, et al. Efficient and Economically Favorable Co-Free Air Electrodes for Solid Oxide Cells. ECS Trans 2021;103:1497–504.





## Lignin based futur catalysts for hydrogen production

Elisabetta Borsella<sup>a</sup> \*, Pietro Colucci<sup>b</sup> and Heiko Lange<sup>c</sup>

<sup>a</sup> Research Centre ENEA Casaccia, Via Anguillarese 301, 00123 Rome, Italy

<sup>b</sup> Research Centre ENEA Trisaia, SS 106 Jonica km 419+500, 75026 Rotondella, Italy

<sup>c</sup> Department of Earth and Environmental Sciences – University of Milano-Bicocca, Piazza della Scienza 1, 20126 Milan, Italy

### Abstract

Biochar is a promising catalyst for hydrogen production in the biomass gasification process. Based on preliminary results, it seems possible to regulate the formation conditions (heating rate, process temperature, reaction time) of biochar from thermochemical processes applied to lignin in such a way as to produce materials that maintain some of the typical functional groups of lignin, particularly in terms of oxygen-containing functionalities, and that can therefore be appropriately modified for the production of higher value-added products. Lignin-based biochar has been investigated using different technical lignins in order to understand, based on their functional characteristics, which ones could be opportunely functionalized to be used as a catalyst in gasification processes. Four different technical lignins, namely two different kraft lignins and two different organosolv lignins, were tested; for comparison, liginosulfonate lignin and alkali lignin, both, were also studied.

Biochars from the various lignins have been obtained by vacuum pyrolysis using a new heating system with a heating rate of 700°C per minute. Samples were heated up to 600°C, and temperature was held for 2 minutes; the process is suitable to avoid possible side reactions, as well as condensation reactions and formation of unwanted products. Biochar so obtained was characterized by specific surface and porosity analysis, thermogravimetric analysis, elemental analysis, scanning electron microscopy and nuclear magnetic resonance. Liquid and gaseous fractions formed during the thermal processes were analysed by a gas chromatograph coupled to a mass spectrometer. During the pyrolysis process, phenolic compounds and/or AHs can be produced, showing promising applications in biochemical intermediates and biofuel additives.

From the preliminary results, liginosulphonate and alkaline lignins seem to be the most reluctant to react, highlighting an unsuitability for the formation of a functionalizable biochar. Furthermore, the high sulfur content present in liginosulfonate lignin and also in the derived biochar makes it less suitable for its use as a starting material for catalysts development. Differently, the technical lignins appear to be the most promising lignins in the production of



functionalizable biochar. Tga analysis on pyrolytic biochar shows a great thermal stability at 600 °C compared to their precursor lignins and BET and NMR studies show biochar structures easily malleable to the insertion of catalytically active metals.



## Hydrogen production by cellulose aqueous phase reforming over layered double hydroxide-derived catalysts

Andrea Fasolini<sup>\*a</sup>, Eleonora Tosi Brandi<sup>a</sup>, Francesco Basile<sup>a</sup>,

<sup>\*</sup> corresponding author: andrea.fasolini2@unibo.it

a) Dip. Chimica Industriale "Toso Montanari", Università di Bologna, Viale Risorgimento 4,  
40136 Bologna, BO, Italy

Keywords: Aqueous Phase Reforming, Cellulose, Hydrogen, Hydrotalcites.

### Abstract

**Introduction:** In the frame of the hydrogen economy, the development of different processes for hydrogen production from renewable is being envisioned. For instance, waste biomasses such as cellulose can be catalytically treated to obtain hydrogen. Usually, cellulose is first hydrolysed to yield an aqueous solution of glucose. The latter can be further treated in the aqueous phase reforming (APR), which is a catalytic process similar to methane steam reforming, that gives hydrogen and carbon monoxide from a carbon-based substrate [1,2]. However, differently from methane, glucose is a complex substrate including C-C bonds and C-O bonds, in addition to C-H ones. This makes it easier to decompose the molecule and decreases the temperature required for the endothermic reforming reaction (200-250°C). For this reason, the process can be carried out at autogenous pressure in the liquid phase (aqueous phase reforming).

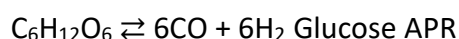

Moreover, the employment of low temperatures allows to carry out together the reforming reaction and the water gas shift one (WGS). The latter consumes the produced CO and increases hydrogen production.

Thus, the combined reactions can lead to hydrogen production from glucose around 250°C. However, glucose decomposition by polymerization occurs when this molecule is heated up over 150°C leading to the formation of solid humins [3], hindering hydrogen generation and blocking the catalyst active sites. In this work we used a one-pot approach, employing directly a cellulose aqueous mixture in APR using a proper catalyst with both acid-base and redox functionalities. In this way, cellulose hydrolysis was carried out in a controlled way, producing low concentrations of glucose that were readily consumed by reforming, avoiding humins formation. This approach requires the employment of tailored catalysts. In this context, layered double hydroxide (LDH) derived catalysts are suitable candidates for aqueous phase reforming of cellulose. LDH are anionic clays where positively charged hydroxide layers are alternated to ones containing carbonate anions. LDH can be exploited as catalyst precursors



because different cations can be crystallized into the LDH structure (such as Ni, Mg and Al for this work) and because they can be decomposed to oxides by calcination. In addition, reducible cations such as Ni can be extracted as nanoparticles after reduction by molecular hydrogen.

**Objectives:** This work aims at directly producing hydrogen from waste cellulose by aqueous phase reforming using tailored catalysts.

**Material and methods:** The LDH-based catalysts were prepared by coprecipitation, then calcined to obtain the corresponding mixed oxides. The final catalysts, composed of Ni<sup>0</sup> over MgAl mixed oxide were obtained by reduction under H<sub>2</sub>. The catalysts were characterized by means of XRD, nitrogen physisorption, TEM, TPD and TPR/OR analyses. Cellulose (1.5g), catalyst (0.4g) and water (50.0g) were charged in an autoclave under N<sub>2</sub> or H<sub>2</sub> and heated up to 250°C. The gas and liquid products were analysed by GC and HPLC respectively.

**Results:** The obtained Ni<sup>0</sup>/Mg(Al)O catalysts showed the copresence of redox and acid-base functionalities, needed to catalyze reforming and hydrolysis as well as retro aldol reaction respectively. In glucose APR, very low hydrogen production was obtained due to the formation of insoluble products (humins), while a consistent hydrogen yield (>20%), was obtained using cellulose, highlighting the advantages of making a one-pot process that couples hydrolysis and APR. The effect of Ni content was also investigated. Increasing it provided an initial increase in hydrogen yield, while at higher contents it decreased due to the formation of large Ni particles which decreased the total metallic surface area. The study was also concentrated on the identification of liquid products and reaction pathways leading to them, an area that is seldom treated in the existent literature. Glucose was not found in the liquid phase, indicating that its consumption by APR is faster than its generation from cellulose by hydrolysis. Among the other products, glucose was transformed mainly into lactic acid, acetic acid and ethylene glycol. The latter is probably an intermediate in hydrogen production as it can be easily reformed to produce hydrogen. Counterintuitively, the addition of hydrogen in the reaction atmosphere since the first stages of the process allowed to push glucose hydrogenolysis to short chain alcohols further increasing overall hydrogen production by reforming of them.

**Conclusions:** LDH-derived catalysts were prepared in this work and applied to cellulose APR for hydrogen production. The catalyst showed interesting hydrogen yields which outperformed a commercial catalyst. In addition, the results were higher than those that could be obtained directly using glucose.

## References

- [1] Fasolini, A. et al. *Catalysts* 9.9 (2019): 722.
- [2] Fasolini, A. et al. *Catalysts* 9.11 (2019): 917.
- [3] Taghavi, S. et al. *Processes* 8.7 (2020): 843.



## Hydrogen production by glycerol photoreforming over different Pt/TiO<sub>2</sub> catalysts

Valeriia Maslova<sup>a,b</sup>, Andrea Fasolini<sup>a</sup>, Michele Offidani<sup>a</sup>, Stefania Albonetti<sup>a</sup>, Francesco Basile<sup>\*a</sup>,

\* corresponding author: f.basile@unibo.it

<sup>a</sup>Dip. Chimica Industriale "Toso Montanari", Università di Bologna, Viale Risorgimento 4, 40136 Bologna, BO, Italy

<sup>b</sup>Université de Lyon, C2P2 (UMR 5265 CNRS, Université de Lyon 1, CPE Lyon), France

Keywords: Hydrogen, microemulsion, photocatalysis, TiO<sub>2</sub>.

### Abstract

**Introduction:** Among the hydrogen sources, the use of waste biomass or biomass-derived feedstocks can be an alternative to water electrolysis. In this view, glycerol, a cheap and renewable biomass feedstock was used as a substrate in the present work, as it is found as a waste in biodiesel production. Although glycerol can be converted by steam or aqueous phase reforming at temperatures above 200°C [1], photoreforming of glycerol is a greener alternative able to yield hydrogen at room temperature aided by solar light and the presence of a photocatalyst [2]. Among them, titania is the most used material, usually functionalized with metal nanoparticles. However, the chemical and morphological properties of TiO<sub>2</sub>, as well as the metal deposition method, highly affect the catalytic activity and these can be tailored by appropriate synthetic methods. Here, titania was produced by a microemulsion procedure and functionalised with Pt by incipient wetness impregnation or deposition precipitation techniques, the catalysts were fully characterized and then applied to photocatalytic reforming of glycerol in aqueous media.

**Objectives:** This work aims at developing active catalysts for glycerol photoreforming by tuning the synthetic procedures and at understanding the correlation between the properties and activity of the catalyst.

**Material and methods:** In this work four types of TiO<sub>2</sub> were used: two commercial TiO<sub>2</sub> powders, CristalACTiV DT-51 and Degussa P25, and two lab-synthesized TiO<sub>2</sub> using a microemulsion system [1]. This method allows preparing TiO<sub>2</sub> powders with anatase (TiO<sub>2</sub>-m\_A) and rutile (TiO<sub>2</sub>-m\_R) polymorphs depending on the reaction time. Platinum nanoparticles (NPs) in 1.5% wt. were deposited by two different methods over the TiO<sub>2</sub> supports: incipient wetness impregnation and deposition-precipitation (DP), followed by subsequent calcination and reduction in the flow of hydrogen (10%v/v in N<sub>2</sub>, 350°C). The

catalytic tests were conducting feeding in a slurry containing the catalyst and an aqueous solution of glycerol, irradiated for 6 h with a solar simulator.

**Results:** The obtained catalysts allowed to produce hydrogen from glycerol photoreforming and the results demonstrate that phase composition of TiO<sub>2</sub> influences both the selectivity of intermediates and hydrogen production rates. Anatase is more selective towards glyceraldehyde, while the presence of rutile promotes a more selective reaction towards glycolaldehyde. Rutile also shows a higher productivity of hydrogen compared to anatase. The analysis of liquid phase products suggests the mechanism of glycerol photoreforming illustrated in Figure 1. Besides, Pt NPs prepared by DP method showed superior rate of hydrogen production than classical impregnation, because of the small and homogeneously distributed nanoparticles. The effect of the synthetic method of titania support and their photocatalytic activity was also discussed.

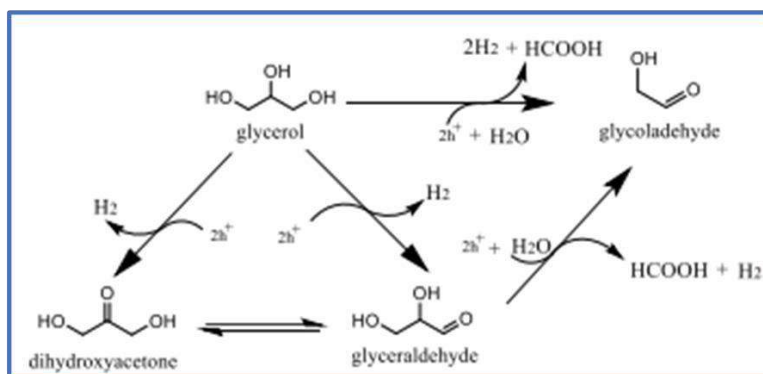

Figure 1: hypothesised reaction mechanism of glycerol photoreforming.

**Conclusions:** The effect of the synthetic method and phase composition of titania photocatalysts as well as the deposition method of Pt nanoparticles was investigated, and this work demonstrates the possibility of developing suitable catalysts to convert biomass derivatives by solar irradiation to chemicals and hydrogen.

## References

- [1] Maslova, V., et al, *Catalysis Today*, 380 (2021)
- [2] Lolli, A., et al, *Molecules*, 23, 11 (2018).



## Ultrapure Hydrogen from Syngas with a Composition Typical of Biomass Gasification and Conditioned in Pd/Ag Membrane Reactor

N. Cerone<sup>a</sup>, F. Zimbardi\*<sup>a</sup>, L. Contuzzi<sup>a</sup>, L. Fabbiano<sup>b</sup>, G. Zito<sup>b</sup>, M. Carnevale<sup>a</sup>, V. Valerio<sup>a</sup>

\* corresponding author: [francesco.zimbardi@enea.it](mailto:francesco.zimbardi@enea.it)

<sup>a</sup> ENEA, Dip. Tecnologie Energetiche e Fonti Rinnovabili – SS Ionica 106, Rotondella (MT) 75026 Italy

<sup>b</sup> Politecnico di Bari, Dip. di Meccanica, Matematica e Management, Via Orabona 4 - 70125 Bari

*Keywords: Membrane reactor, permeation, syngas, WGS.*

### Abstract

**Introduction:** Lignocellulosic biomass is a suitable source of green hydrogen that can be produced via thermochemical path. Stream of ultrapure hydrogen and high yields can be obtained by using membrane reactors (MR) which are based on the selective permeation of hydrogen through Pd membranes. The synergy of permeation and equilibrium needs to be investigated to optimise process design, starting from syngas obtained from biomass gasification.

**Objectives:** Hydrogen separation in reactive and unreactive devices was experimentally investigated at bench scale by using Pd-Ag permeation units and MRs connected in a train able to treat 0.25 Nm<sup>3</sup>/h (STP) of syngas. The permeation flow of H<sub>2</sub> through the membranes and the CO conversion in CO<sub>2</sub> and H<sub>2</sub> achievable with the water gas shift reaction (WGS) in MRs were investigated in a set of experiments varying pressure, temperature and steam flow.

**Material and methods:** Mixes of H<sub>2</sub>, CO, CO<sub>2</sub>, CH<sub>4</sub>, and eventually N<sub>2</sub>, were used to simulate the typical composition of the syngas obtained from the PRAGA plant, which is a pilot gasification plant, built at ENEA Research Center of Trisiaia. The production of H<sub>2</sub> can be increased through a reaction between CO and H<sub>2</sub>O in the WGS reaction that is an exothermic reaction characterized by no variation of the total mole number. The equilibrium is favourable to H<sub>2</sub> formation at low temperature and high H<sub>2</sub>O /CO ratio, though the presence of a catalyst is required to achieve fast kinetics. The H<sub>2</sub> permeability in Pd increases with the Ag content and reaches a maximum at around 23 wt% of Ag and this was the composition of the membranes that were used. In the membrane reactor the catalyst is inner confined in a tube made of a Pd based membrane. The experiments were carried out using two parallel lines each made of one permeator and one MR. About 50 g of a commercial catalyst based on platinum and zirconium oxide is located inside each MR. A design of experiments (DOE) was elaborated consisting of 6 tests carried out at 4, 6 or 8 bar ; 300 °C, 325 °C, 350 °C and steam flow regulated to be 1.1, 1.5 and 2 times the stoichiometric value to achieve the complete



conversion of CO. The mix of gas was heated by an electric heater then split in two streams and sent to the hydrogen separation unit/ permeation unit to separate the Hydrogen. Subsequently, the retentate stream was mixed with the steam and sent to the MR / reaction unit where the water gas shift reaction occurs. The retentate and the permeate stream compositions and mass flow rate were analysed at different process conditions. The gas flow of each component of the mix and the permeated H<sub>2</sub> were measured by mass flow-meters.

**Results:** 3D graphs were drawn to show the functional dependence of the permeation from the pressure, temperature and steam, the surfaces interpolated the experimental data. The H<sub>2</sub> permeation through the membrane increased with the operating pressure and with the temperature. In the MR, the CO conversion in H<sub>2</sub> was calculated using the concentration (measured by GC) in the molar flow in the feed and retentate stream, and then compared to the theoretical yields expected in a GIBBS reactor. In most of the cases the yields were very close to the theoretical values, and at the highest T, P and H<sub>2</sub>O/CO we measured conversion yields slightly higher than that calculated for a closed system. The highest conversion was obtained at the highest value of H<sub>2</sub>O/CO ratio, as thermodynamically expected. The pressure also acted positively on the yield because with the increasing of the pressure the H<sub>2</sub> permeation also increased and the removal of H<sub>2</sub> from the reaction side shifted the reaction towards further H<sub>2</sub> formation. The temperature affected the process in two opposite ways: low temperatures favoured higher yields, whereas low temperature depressed H<sub>2</sub> permeation.

**Conclusions:** The permeation allows reaching the thermodynamic limit expected in a closed system and in some cases overpass the threshold. The H<sub>2</sub> permeated from a MR is on average 3.4 times higher than the one measured with the permeator unit. Most likely this is due to the presence of local superheated points in the membrane that positively affects the permeation process. The pre-permeation step increases the total flow of ultrapure H<sub>2</sub> but does not affect significantly the production of new H<sub>2</sub> from WGS and should be used only for the syngas in which the H<sub>2</sub> content is high.

#### **Acknowledgment**

Work funded by the Ministero dell'Ambiente e della Sicurezza Energetica through the Piano Operativo di Ricerca.

#### **References**

- [1] Cerone, Nadia, and Francesco Zimbardi. "Gasification of Agroresidues for syngas production." *Energies* 11.5 (2018): 1280.
- [2] Tosti, Silvano, et al. "Design and process study of Pd membrane reactors." *International Journal of Hydrogen Energy* 33.19 (2008): 5098-5105.





## Production Of Hydrogen-Rich Syngas from Biomass Gasification by Double Step Steam Catalytic Tar Reforming

N. Cerone <sup>a</sup> F. Zimbardi\*<sup>a</sup>, L. Contuzzi <sup>a</sup>, N. Strijugas <sup>b</sup>, J. Eimontas <sup>b</sup>, M. Carnevale <sup>a</sup>, V. Valerio <sup>a</sup>, A. Villone <sup>a</sup>

\* corresponding author: [francesco.zimbardi@enea.it](mailto:francesco.zimbardi@enea.it)

<sup>a</sup> ENEA, Dip. Tecnologie Energetiche e Fonti Rinnovabili – SS Ionica 106, Rotondella (MT) 75026 Italy

<sup>b</sup> Lithuanian Energy Institute, Breslaujos st. 3, LT-44403 Kaunas

Keywords: Biomass, Gasification, Catalyst, Tar

### Abstract

**Introduction:** The production of hydrogen from lignocellulosic biomass through gasification offers several advantages. Using biomass as a carbon source contributes to the reduction of greenhouse gas emissions, as biomass absorbs CO<sub>2</sub> during its growth. Furthermore, the produced hydrogen can be used as a clean fuel or chemical. When using residues of the agriculture, agroindustry, silviculture, the use of this feedstock improves circularity in bioeconomy. The biomass gasification is carried out at high temperatures with a sub stoichiometric input of oxygen respect to the combustion. This leads to the thermal decomposition generating as main product synthesis gas (syngas) composed of CO, H<sub>2</sub>, CO<sub>2</sub>, and low percentage of CH<sub>4</sub> as well other light hydrocarbons. The syngas undergoes several purification processes to remove condensable organic molecules that can constitute a significant fraction of the products. Subsequently, technologies such as catalytic steam reforming can be used to convert these complex organic molecules and CO into new hydrogen and cleaning the syngas to produce a stream usable, for example, in methanol or Fischer Trophs synthesis.

**Objectives:** The work was designed to assess the efficiency of using two types of catalysts operating in series for tar reforming in order to clean syngas and increase hydrogen content in the upstream. First, the raw syngas was passed through a bed of dolomite, which is quoted to provide conversion of tar among 44% - 97% being the most efficient among the cheap catalysts. Then, the partially cleaned syngas passed in a bed of Ni/CeO<sub>2</sub>/Al<sub>2</sub>O<sub>3</sub> that is quoted to provide conversion higher than 98% because of the intimate interaction between Ni and CeO<sub>2</sub> that can play important role on the steam gasification of organic molecules, in particular avoiding coke deposits.

**Material and methods:** For the study a side stream of the gasification plant PRAGA with a nominal input of 20-30 kg/h of feedstock, more details on the rigs and methods are reported elsewhere [1]. For this campaign hazelnut shells were used as feedstock as the gasification was optimized in previous studies. Air flow of 26 kg/h and 3.5 kg steam overheated at 160 °C were used as gasifying agent to convert 20 kg/h of shells (95 % DM). Streams of about 2.5 m<sup>3</sup>/h of syngas, corresponding to about 1/20 of the total gas flow in the gasifier, were draft from the reactant bed at height of 0.728 m, in the following reported as stream A, and at 0.936 m from the grate, in the following reported as stream B, they were respectively about 0.5 m and 0.2 m below the top of the bed of biomass which was 1.2 m - 1.1 m from the grate. The raw syngas was conveyed through a thermally insulated line at 250°C to a

cracking section consisting of two reactors in series each having a length of 60 cm and a diameter of 50 mm (useful volume 1960 cm<sup>3</sup>). The system was placed in a vertical electric furnace to control the temperature at 800 °C. The whole pilot rig, including the gasifier and catalytic section, is equipped with online measurement of non-condensable gases (N<sub>2</sub>, H<sub>2</sub>, CO, CO<sub>2</sub>, CH<sub>4</sub>, O<sub>2</sub>) by online GC analysis. The syngas is sampled at the exit of the gasifier for offline analysis of water and organic volatiles, following the CEN/TS 15439:2006 procedure. Qualitative and quantitative GC MS analysis was also carried out when the tar content was too low for the CEN method as happened in the syngas after the catalytic treatment. Air nitrogen was used as tracer for the mass balance. As regards the used catalysts, dolomite was activated by calcination overnight at 900°C. The Ni/CeO<sub>2</sub>/Al<sub>2</sub>O<sub>3</sub> was prepared by impregnation with Ni(NO<sub>3</sub>)<sub>2</sub>·6H<sub>2</sub>O of the commercial substrate Puralox SCFa 160 Ce20, a gamma-Alumina, containing 20% of CeO, that was provided as tablets 3 mm x 3 mm. After the impregnation, the sample was dried at 110 °C for 4 h, then calcinated at 600 °C for 3 h [2].

**Results:** The composition of the streams draft from the bed was significantly different from that draft from the top of the gasifier in the typical configuration and operation. In particular, the tar content was 1.82 g/m<sup>3</sup> in the stream A and 2.6 g/m<sup>3</sup> in the stream B versus a value of 54 g/m<sup>3</sup> measured in the upstream. This finding confirmed that most of the pyrolysis occurred in the top layers of the bed. The gas composition also depends on the height from which the syngas is draft. For example, the H<sub>2</sub> content increased along the height from 15 % (A), to 19 % (B) and was 22 % in the updraft. The composition of the gas out the cracking reactor was compared to the input. In the case of the stream A the H<sub>2</sub> content increased from 15% to 29% which, in moles, corresponded to an increase of 112%. On the basis of the CO reduction a minor contribute, i.e. molar increase of 27%, originated from WGS, the remaining 85% was from the steam reforming of the tar that was converted for 98%. Analogously, the stream B was enriched of H<sub>2</sub> with a molar gain of 137%, of which 103% was derived from tar conversion.

**Conclusions:** The tar contained in stream of syngas from pilot gasifiers was reacted in a train of two catalytic reactors up to the conversion of 98 %. After the treatment, the H<sub>2</sub> production increased up to 137%, part was from the conversion of CO by WGS (34%) while most was from the steam tar reforming. Using two catalysts, one cheap and moderately performant, the other more expensive and complex to produce, is an effective strategy to clean up syngas from tar and increasing the hydrogen production from biomass. This is a valuable option for the gasification occurring at low temperature characterized high energy efficiency, simple and robust operation, but also producing relatively large quantity of organic volatiles.

#### **Acknowledgment**

Work funded by EC H2020, contract n. 731101, and by the Ministero dell'Ambiente e della Sicurezza Energetica through the Piano Operativo di Ricerca. SASOL Italy kindly donated the substrate Puralox.

#### **References**

- [1] Cerone, Nadia, et al. "Experimental investigation of syngas composition variation along updraft fixed bed gasifier." *Energy Conversion and Management* 221 (2020): 113116.
- [2] Nishi kawa, Jin, et al. "Catalytic performance of Ni/CeO<sub>2</sub>/Al<sub>2</sub>O<sub>3</sub> modified with noble metals in steam gasification of biomass." *Catalysis today* 131.1-4 (2008): 146-155.



## Innovative Hybrid Anodic Electrode For Water Electrolysis: Synergistic Combination Of Magnesium Ferrite, Hard Carbon, And Ruthenium Oxide For Enhanced Electrochemical Efficiency

Pietro Colucci<sup>2</sup>, Heiko Lange<sup>3</sup>, Livia della Seta<sup>1</sup>, Claudia Paoletti<sup>1</sup>, Elisabetta Borsella<sup>1</sup>

<sup>1</sup>Research Centre ENEA Casaccia, Via Anguillarese 301, 00123 Rome, Italy

<sup>2</sup> Research Centre ENEA Trisaia, SS 106 Jonica km 419+500, 75026 Rotondella, Italy

<sup>3</sup>Department of Earth and Environmental Sciences – University of Milano-Bicocca, Piazza della Scienza 1, 20126 Milan, Italy

### Abstract

Water electrolysis represents a promising technology for green hydrogen production, necessitating the development of efficient and stable electrodes. In this study, we present the design and characterization of an innovative hybrid anodic electrode that incorporates a synergistic combination of magnesium ferrite (MF), hard carbon (HC), and ruthenium oxide (RuO<sub>2</sub>).

Commercial electrodes typically consist of single materials with limited catalytic activity and durability. In contrast, the hybrid anodic electrode demonstrates significant improvements in electrochemical efficiency. The MF component serves as a robust supporting structure, providing thermal stability and corrosion resistance, ensuring prolonged electrode lifespan during the electrolysis process. The inclusion of HC, derived from lignin pyrolysis, offers conductivity and a porous surface that facilitates ion diffusion. The addition of RuO<sub>2</sub> as a catalyst for the Oxygen Evolution Reaction (OER) enhances overall electrochemical efficiency, promoting oxygen generation at the anode during water electrolysis.

Comprehensive analyses were conducted using electrochemical, structural, and morphological characterization techniques such as X-ray diffraction (XRD), thermogravimetric analysis (TGA), specific surface area determination using the BET analysis, and scanning electron microscopy (SEM). These analyses provide detailed insights into the structure, chemical composition, and surface properties of the hybrid anodic electrode.

The results of this study demonstrate the superior performance of the innovative hybrid anodic electrode compared to commercial alternatives. This novel electrode exhibits higher catalytic activity, improved durability, and overall enhanced electrochemical efficiency.



This research establishes a fundamental basis for further studies aimed at the design and optimization of advanced electrodes for water electrolysis, paving the way for the development of sustainable technologies for efficient hydrogen production.



## Numerical and experimental investigation of the effect of gas flow configuration on the performance of a solid oxide electrolyzer

Silvia Lo Conte<sup>a</sup>, Francesca Santoni<sup>b</sup>, Davide Pumiglia<sup>b</sup>, Francesco Marino<sup>b</sup>, Maria Cristina Annesini<sup>a</sup>,  
Maria Anna Murmura<sup>a</sup>

<sup>a</sup> University of Rome "La Sapienza", Department of Chemical Engineering Materials and Environment, Via Eudossiana 18,  
00184 Rome, Italy

<sup>b</sup> Department of Energy Technologies and Renewable Sources, Laboratory of Energy Storage, Batteries and Hydrogen  
Production and Use (TERIN-PSU-ABI), ENEA Italian National Agency for Energy, New Technologies and Sustainable  
Economic Development, C.R. Casaccia, Rome, Italy;

### Introduction:

High temperature electrolysis of water is an interesting process for the production of green hydrogen as it allows to reduce the electrical energy input compared to low temperature electrolysis processes while limiting the temperature requirements with respect to thermochemical processes. Among the high temperature electrolysis processes, solid oxide electrolysis is the most mature technology. The performance of solid oxide electrolysis cells (SOECs) is affected by several factors, including the characteristics of the main cell components, the operating temperature, and the flow rate, flow configuration and composition of the gas feed. The main reactions taking place at the cathode and anode of the cell are, respectively,

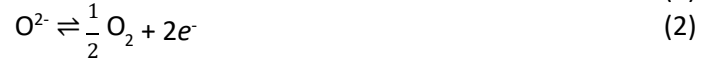

The present work is an experimental and modelling study of a planar SOEC, carried out with the main aim of investigating the effect of the gas flow configuration on the performance of the system.

### Modelling:

A 2D model was developed to describe the main transport phenomena in the gas channels, electrodes, and electrolyte. Isothermal conditions were assumed. The modelled cell is shown in Figure 1.

Within the gas channels, the main phenomena that were accounted for were mass transport by convection and diffusion, along with the momentum balance equation. The main equations are therefore

$$\nabla \cdot \mathbf{j}_i + \rho \mathbf{u} \nabla \omega_i = 0 \quad (3)$$

$$\nabla \cdot (\rho \mathbf{u}) = 0 \quad (4)$$

where  $\mathbf{j}_i$  is the diffusive flux of the  $i$ -th component, described through the Stefan-Maxwell equation

$$\mathbf{j}_i = -\rho \omega_i \sum_k D_{ik} \left( \nabla x_k + \frac{1}{P} [(x_k - \omega_k) \nabla P] \right) \quad (5)$$

where the terms  $D_{ik}$  represent the binary diffusion coefficients,  $x_k$  is the molar fraction of the  $k$ -th component, and  $\omega_i$  is the mass fraction of the  $i$ -th component.  $P$ ,  $\rho$ , and  $\mathbf{u}$  are the operating pressure, gas density, and velocity vector, respectively. The gas density was evaluated from the ideal gas equation of state. In the porous electrodes, mass transfer of the gaseous components, ionic and

electric charge transfer and the electrochemical reaction were accounted for, yielding, for charge conservation

$$\nabla \cdot \mathbf{i}_s = -i_{v,TOT} \quad (6)$$

where  $\mathbf{i}_s$  is the current density and  $i_{v,TOT}$  represents the rate of electron production following the electrochemical reaction, expressed through the Butler-Volmer equation.

Finally, ionic transport in the electrolyte phase was considered. The overall charge conservation leads to the condition

$$\nabla \cdot \mathbf{i}_s + \nabla \cdot \mathbf{i}_l = 0 \quad (7)$$

where  $\mathbf{i}_l$  is the current density in the electrolyte phase. The rate of charge transport in both the electrolyte and electrodes is related to the electrical potential through the conductivity according to Ohm's law.

### Experimental:

In this study, a sensitivity analysis based on flow, temperature, and steam conversion factor variations was performed with the aim of providing detailed experimental information for the validation of the 2D computational model. For each tested condition, besides the evaluation of cell's electrochemical performance in electrolysis mode (EIS and IV curves), localized gas composition and temperature sampling at the fuel electrode surface were made accessible by means of a peculiar experimental setup developed by ENEA and reported in Figure 1. This configuration is designed to test single cells of sizes  $10 \times 10 \text{ cm}^2$  (active area  $9 \times 9 \text{ cm}^2$ ) and consists of several components separated by gaskets made of Thermiculite 866LS or CL87 produced by Flexitallic. This multilayer configuration allows to obtain a gas-tightness and electrical insulation of the SOC single cell at the same time. The fuel side case is the innovative core of the setup: it is equipped with 11 capillary tubes distributed along the for gas and temperature sampling. The gas composition and temperature distribution are monitored from 5 coordinates across the direction of flow and at 7 coordinates in the direction of flow, resulting in an efficient mapping of surface composition, thus allowing to detect the variation of thermodynamic and chemical conditions across the fuel electrode surface in a steady state and in real time [1].

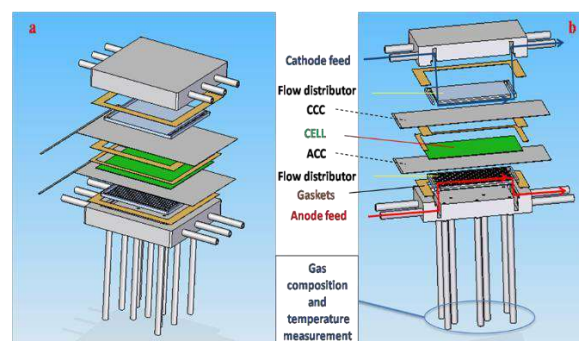

Figure 1 - Exploded view (a) and cross section (b) drawings of the multisampling housing [1]

### Bibliography:

[1] F. Santoni, D. Silva Mosqueda, D. Pumiglia, E. Viceconti, B. Conti, C. BoiguesMuñoz, B. Bosio, S. Ulgiati and S. J. McPhail, In-situ study of the gas-phase composition and temperature of an intermediate-temperature solid oxide fuel cell anode surface fed by reformat natural gas. Journal of Power Sources, 2017, Volume 370, p. 36-44. doi: 10.1016/j.jpowsour.2017.09.078



## Experimental Evaluation of a Power-to-Gas System for Green Hydrogen Production

R. Adinolfi Borea<sup>a</sup>, M. A. Ancona<sup>\*b</sup>, M. Bianchi<sup>b</sup>, L. Branchini<sup>b</sup>, F. Ferrari<sup>b</sup>, F. Melino<sup>b</sup>, P. Pilati<sup>a</sup>

\* corresponding author: [maria.ancona2@unibo.it](mailto:maria.ancona2@unibo.it)

<sup>a</sup> Università degli Studi di Salerno - Dipartimento di Ingegneria dell'Informazione ed Elettrica e Matematica applicata (DIEM), Via Giovanni Paolo II, 132 - 84084 Fisciano (SA)

<sup>b</sup> Alma Mater Studiorum - Università di Bologna, Department of Industrial Engineering (DIN), Viale del Risorgimento 2, 40136 Bologna, Italy

Keywords: Green Hydrogen production – PEM Electrolyzer – Experimental set-up – Renewable sources

### Abstract

#### Introduction:

The use of hydrogen as an energy carrier represents an interesting prospect for the decarbonisation of the energy sector, promising to stabilize RES fluctuations by storing excess energy in periods of lower demand and returning it, through innovative fuel cells, engines and gas turbines, when users' energy needs increase [1-3].

#### Objectives:

In this context, the purpose of the current study is therefore to propose an experimental approach to evaluate the operational strategies that combine green hydrogen production systems, based on PEM electrolyzers technology, to renewable generators, with the aim of optimizing the system energy management. The test plant is part of the Joint Lab "HC-hub-ER – Hydrogen and Carbon use through Energy from Renewables" between Eni S.p.A. and Università di Bologna.

#### Material and methods:

The final layout of the test plant is given in Fig. 1 and consists of a power supply line and a hydrogen production and storage section as well as the measurement and data acquisition chain. More specifically, the main components of the electrical conversion system are two photovoltaic modules in monocrystalline silicon 220 W each, a 2.5 kW solar simulator and a three-phase power inverter able to guarantee a total power input to the hydrogen generator of about 3 kW. Subsequently, the hydrogen production and storage chain consists of a commercial PEM electrolyzer (2.5 kW maximum electrical absorption), capable of producing 500 NI/h of hydrogen at a maximum working pressure of 15 bar with a purity of 99.999%, and a low-pressure hydrogen storage system in metal hydrides (MH) canisters for a total storage capacity of about 600 SI at 10 bar. The data acquisition and control system of the test bench is based on the use of National Instruments<sup>TM</sup> instrumentation and has been realized in LabVIEW<sup>TM</sup> environment. At the same time, it was decided to realize a calculation model of the entire system in Matlab/Simulink<sup>TM</sup> environment to be run in a Real-Time Simulink target machine and feed with the main physical parameters acquired during the plant operation, in order to validate the proposed operational strategy.

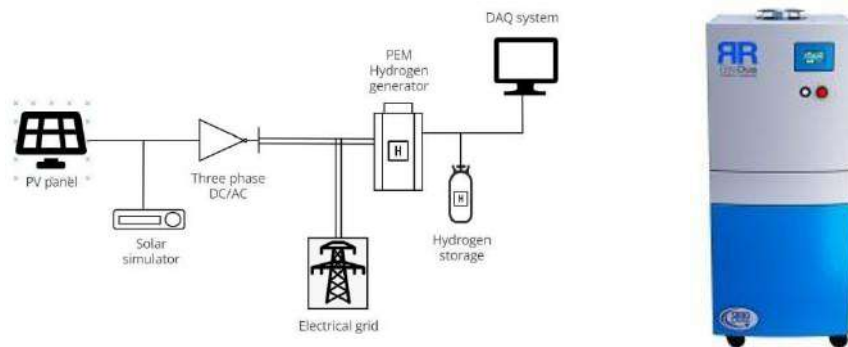

**Figure 1:** System layout and commercial PEM Electrolyzer

## Results:

The first experimental investigations allowed to characterize the behaviour of the PEM generator in response to the variation of the main electrical input parameters and at the same time to know more in detail its Balance of Plant (BoP) which interacts with the PEM stack. The next phases of the project will include a focus on the electrical supply chain, both by the analytical and experimental side, to optimize its coupling with the electrolyzer.

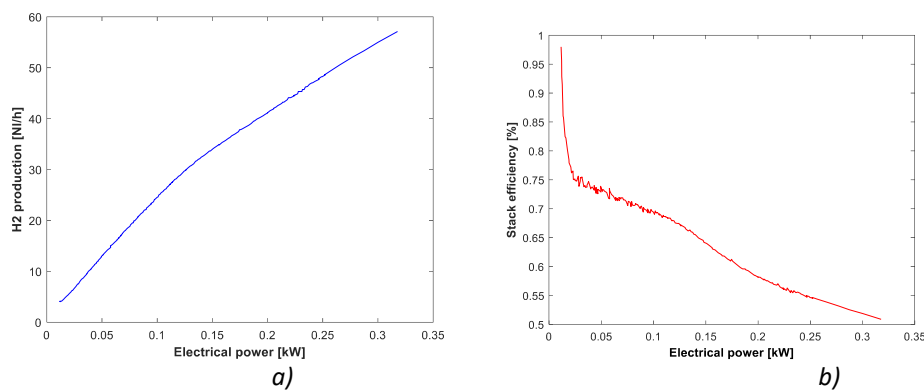

**Figure 2:** Preliminary results: *a)* produced hydrogen flow rate [NI/h] and *b)* stack efficiency as a function of its electrical power consumption.

## Conclusions:

This paper aims to present a test bench for the experimental characterization of Power-to-Gas (P2G) systems for green hydrogen production and storage. This approach will allow to evaluate the operational strategies that combine hydrogen generators to renewable sources, with the aim of optimizing the system energy management.

## References

- Quarton, C.J., Samsatli, S. The value of hydrogen and carbon capture, storage, and utilisation in decarbonising energy: Insights from integrated value chain optimisation. (2020). *Applied Energy*, 257, art. 113936.
- IEA (2021), Hydrogen, IEA, Paris. Available at: <https://www.iea.org/reports/hydrogen>.
- IRENA (2018), Hydrogen from renewable power: Technology outlook for the energy transition, International Renewable Energy Agency, Abu Dhabi.





## Compositional analysis of SOFC short stacks operating under different feedstocks: experimental analysis and model-based interpretation.

Francesca Santoni<sup>1,\*</sup>, Gabriele Loreti<sup>2</sup>, Andrea Monforti Ferrario<sup>1,2,\*</sup>, Francesco Marino<sup>1,3</sup>,  
Viviana Cigolotti<sup>1\*</sup>

Corresponding author: [francesca.santoni@enea.it](mailto:francesca.santoni@enea.it)

<sup>1</sup> Department of Energy Technologies and Renewable Sources, Laboratory of Energy Storage, Batteries and Hydrogen Production and Use (TERIN-PSU-ABI), ENEA Italian National Agency for Energy, New Technologies and Sustainable Economic Development, C.R. Casaccia, Via Anguillarese 301, 00123 Rome, Italy

<sup>2</sup> DEIM - Department of Economics, Engineering, Society and Business Administration, University of Tuscia, 01100, Viterbo, Italy

<sup>3</sup> Dipartimento di Ingegneria, Università degli Studi di Napoli Parthenope, Centro Direzionale ISOLA C4, 80133 Napoli, Italy

### Introduction:

Solid Oxide Fuel Cells (SOFC) are a highly efficient electrochemical conversion devices which, thanks to the high operating temperature (between 650-850°C, according to the cell design) allow fuel flexibility. In fact, such devices can process carbonaceous fuels and/or mixtures through internal reforming (to a certain degree) producing hydrogen that subsequently participates the electrochemical reaction. Therefore, SOFC systems are a promising option for highly efficient co-generation in future gas distribution networks, where increasing interest is being put into mixing hydrogen in the existing natural gas pipelines or even reconverting part of the pipeline infrastructure to pure hydrogen transportation and distribution. In this work, an integrated experimental/modelling analysis is carried out for two different types of SOFC short stacks: electrolyte-supported (121 cm<sup>2</sup>) and anode-supported (127 cm<sup>2</sup>).

### Objectives and Methods:

The stacks are fed with laboratory gas mixtures to simulate different scenarios of gradual transition of the gas network from natural gas, to blends, and finally to pure hydrogen. For each stack design the different inlet composition scenarios are tested under different operating conditions to obtain a performance and compositional map varying current, utilization factor and temperature. In particular, the focus of the present work is put in the analysis of the inlet vs. outlet composition of the fuel gas, based on experimental data obtained by Gas Chromatography (GC) measurements at the fuel gas inlet and outlet in each condition. A multi-step improved equilibrium-based model of the gas conversion



processes is then developed, comprising both the chemical (reforming and shift reactions at chemical equilibrium at operating temperature) and electrochemical (electro-oxidation of hydrogen driven by the current) gas conversion routes.

### **Results and Conclusions:**

The model results in terms of gas composition are compared and validated by experimental GC data obtained. The principal results are resumed in the form of bullet points:

- In the hydrogen scenario, the experimental results from the GC analysis are quite identical to the simulated ones, confirming that the system correctly follows the stoichiometry of the electro-oxidation reaction at the outlet as a function of the imposed current.
- The blended and natural gas scenarios present a more complex gas mixture due to the presence of CO, CO<sub>2</sub>, and CH<sub>4</sub> which expands the possible gas conversion pathways considering not only the electro-oxidation of H<sub>2</sub> but also the chemical reactions such as Steam Methane Reforming (SMR) and Water Gas Shift (WGS) occurring within the SOFC. For both the short stack studied the CO conversion is not complete, while the CH<sub>4</sub> conversion results are complete for the Anode-supported short stack but not for the electrolyte-supported.

### **Acknowledgment:**

This research was conducted in the research center ENEA Casaccia, and it has been done within the frame of two projects: SO-FREE project (*Solid oxide fuel cell combined heat and power: Future-ready Energy*, supported by Fuel Cells and Hydrogen 2 Joint Undertaking, grant agreement n°. 101006667), and W2H2 (*Waste to hydrogen*, supported by Horizon 2020 Framework Programme, grant agreement n°952593).

## Microscale Modelling of Two-phase Transport in Porous Transport Layers in Water-Electrolysis Processes

S. Erdogan<sup>\*a</sup>, F. Durmus<sup>a,b</sup>, L. Feierabend<sup>a</sup>, B. Kaufmann<sup>a</sup>, M. Pilaski<sup>a</sup>, H. E. Hoster<sup>a,b</sup>

\* corresponding author: [s.erdogan@zbt.de](mailto:s.erdogan@zbt.de)

<sup>a</sup> The Hydrogen and Fuel Cell Center ZBT GmbH, D-47057 Duisburg

<sup>b</sup> University of Duisburg-Essen, the Chair of Energy Technology, D-47057 Duisburg, Germany

Keywords: Lattice Boltzmann method, porous transport layer, two-phase flow, water - electrolysis

### Abstract

Water Electrolysis (WE), here specifically the Polymer Electrolyte Water Electrolysis (PEM-WE), is a well-established process for the production of hydrogen. However, to reduce capital costs and increase the electrochemical efficiency, the efficient utilization of the expensive noble metal catalysts must be maximized. Especially at high current densities, the generated gases may occupy active catalyst sites due to incomplete desorption and inhibit the access of water to the active sites required for the electrochemical process. The porous transport layer (PTL) plays an important role in the mass transport efficiency of the process by providing pathways for water to reach the catalyst sites and for the removal of the produced hydrogen and oxygen. Therefore, tools to investigate the two-phase flow in PTLs are crucial to specifically improve the microstructures with regard to their mass transport properties under electrolysis-relevant flow conditions.

In this study, the Lattice Boltzmann Method (LBM) in conjunction with the Multicomponent Shan-Chen (MCSC) pseudopotential model<sup>1</sup> is employed to model the two-phase flow in PTLs and the wetting behaviour of the fluids in contact with the solid matrix. The simulations are performed using the open-source software Palabos<sup>2</sup>. The inherent numerical parameters for the LBM and the MCSC are calibrated by comparing corresponding single bubble simulations with the Volume-of-Fluid (VOF) method. The LBM is finally used for simulation of two-phase flow within PTLs, where the domain is initially filled with water and then infiltrated with O<sub>2</sub>.

Two different types of industrial PTLs are analyzed: a woven and a sintered fibre structure (Figure 1). For each sample, the influence of the wetting properties (hydrophilic and hydrophobic) on the gas distribution in the porous domain is investigated. PTLs with a hydrophilic surface property, regardless of being structured or unstructured, exhibit a lower

total O<sub>2</sub> saturation as shown in Figure 2. From a purely fluidic perspective, the woven PTL with hydrophilic wetting properties indicates advantages due to lower breakthrough pressure and lower hold-up for the gas phase.

The performance of the same PTL types is to be measured in an electrolysis cell at high current operating conditions. Consequently, the corresponding mass transport losses are isolated via electrochemical impedance spectroscopy (EIS) measurements and compared to the numerical results from the two-phase transport simulations of the PTLs.

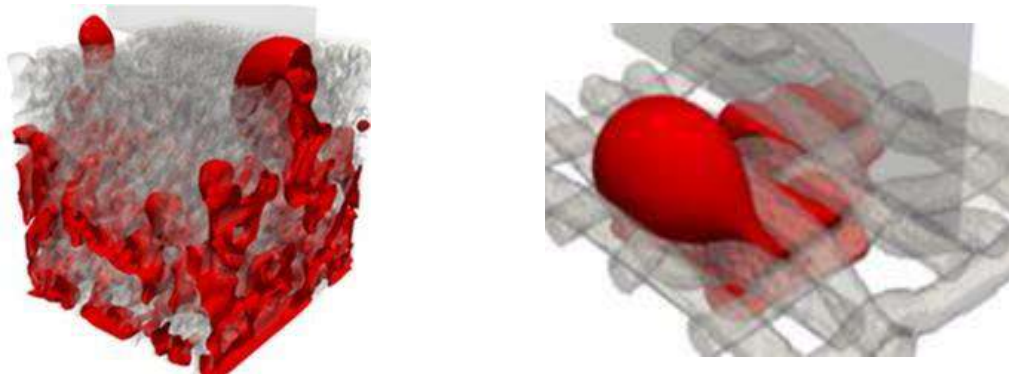

Figure 1: Gas (red) invasion into hydrophilic PTLs: comparison of an unstructured sintered fibre morphology (left) to a structured woven morphology (right).

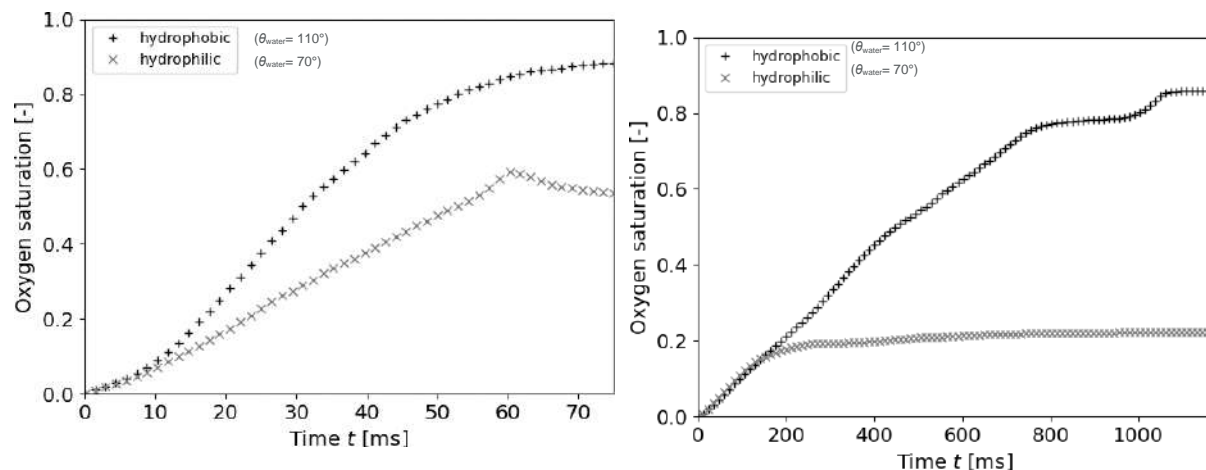

Figure 2: Saturation of oxygen as a function of time for the hydrophobic and hydrophilic PTLs: an unstructured sintered fibre morphology (left) and a structured woven morphology (right).

## References

- [1] Shan, X.; Chen, H. Lattice Boltzmann Model for Simulating Flows with Multiple Phases and Components. *Phys. Rev. E* **1993**, *47* (3), 1815–1819. DOI: 10.1103/PhysRevE.47.1815.
- [2] Latt, J.; Malaspina, O.; Kontaxakis, D.; Parmigiani, A.; Lagrava, D.; Brogi, F.; Belgacem, M. B.; Thorimbert, Y.; Leclaire, S.; Li, S.; Marson, F.. Palabos: Parallel Lattice Boltzmann Solver. *Comput. Math. Appl.* **2021**, *81*, 334–350. DOI: 10.1016/j.camwa.2020.03.022.



## Three dimensional CFD simulation of polypropylene steam gasification in a bench scale rig

A. Vitale<sup>a</sup>, A. A. Papa<sup>a,\*</sup>, A. Di Carlo<sup>a</sup> S. Rapagnà<sup>b</sup>

\* corresponding author: [alessandroantonio.papa@univaq.it](mailto:alessandroantonio.papa@univaq.it)

<sup>a</sup> University of L'Aquila, Department of Industrial and Information Engineering & Economics, Piazzale Ernesto Pontieri 1, 67100 L'Aquila, Italy

<sup>b</sup> University of Teramo, via R. Balzarini 1, 64100 Teramo, Italy

Keywords: hydrogen; steam gasification; CFD; plastic waste treatment

### Abstract

**Introduction:** The circularity of plastics is being boosted generally through the promotion of new lifestyles and behaviors (such as "how to use and reuse plastics"), new eco-design standards (such as "design for recycling" and "design from recycling"), as well as creative recovery techniques that can improve the quantity and quality of recovered resources and limit landfilling. Nevertheless, only a fraction of these plastics can be processed in conventional recycling plants due to the co-presence of various and generally non-compatible polymers, containing different kinds of additives, pigments, and fillers. In addition, the recovered resources are often of lower quality, which complicates their reintroduction into the market. The above explains why chemical recycling methods, which enable the production of fuels, chemicals, and hydrogen from waste plastic, are gaining popularity. "Feedstock recycling" refers to advanced plastic chemical recycling techniques for the decomposition of solid polymeric materials into a variety of fundamental chemical constituents. When the waste has low homogeneity and is contaminated by non-polymeric components, these techniques are seen advantageously from an economic and environmental standpoint.

Fluidized bed gasification looks to be one of the most promising feedstock recycling techniques. The gasification process converts solid waste and biomass into a fuel gas (syngas), through a series of heterogeneous and homogeneous reactions taking place in a reducing atmosphere. The obtained syngas contains large amounts of CO and H<sub>2</sub>, with smaller amounts of CH<sub>4</sub>. It can be used in a wide range of final applications, aiming at the generation of energy (with fuel cells), fuels (hydrogen), and drop-in chemicals.

**Objectives:** In this work, polypropylene (PP) was selected as the object of study, it is one of the most widely used thermoplastic materials in the world (the global market volume of PP is around 75 million tons and this figure continues to grow exponentially) [1]. PP represents an important portion within plastic waste along with PE, PS, PVC and PET and also one of the basic constituents of mixed plastic waste (i.e., the waste left downstream of separate collection, which cannot be conveniently recycled from an environmental and economic point of view). Computational fluid dynamics simulations are a useful tool to investigate the hydrodynamics inside fluidized bed reactors, and there has been great progress in the last decades in the accuracy of its predictions.



**Material and methods:** In this work a three-dimensional computational fluid dynamics (CFD) model was developed for the simulation of polypropylene's gasification process in a lab-scale bubbling fluidized bed gasifier using hybrid EL approach, integrating the Eulerian approach for gas flow and the MP-PIC approach for the solid phase. One implementation of the MP-PIC approach is the commercial code Barracuda by CPF Software, LLC [2]. In the model, the fluid dynamics are combined with the devolatilization kinetics, heterogeneous and homogeneous reaction rates are described by the Arrhenius expression. The homogeneous and heterogeneous reactions are solved using volume-average chemistry on the Eulerian grid.

A first laboratory-scale fluidized bed reactor was used to implement the devolatilization step. The tests were carried out using nitrogen as the fluidizing medium; both the bed and nitrogen flow rate were selected to minimize secondary gas-phase reactions and achieve high reliability of the released products. These conditions are also coupled with reasoning on mixing-related effects for accurate estimation of devolatilization times. From the tests on the reactor at different operating temperatures, the kinetic expression capable of describing the thermal decomposition at the operating temperature was derived and also, the quantitative and qualitative distribution of the products released during the devolatilization (volatiles, char, ash, and aromatic hydrocarbons) was obtained.

A second laboratory-scale facility was used to perform steam gasification tests of the same pellets, also in this case, qualitative and quantitative analysis of the volatiles, char and aromatic hydrocarbon was performed.

**Results:** Using the kinetic law expressing pellet consumption within the fluidized bed coupled with the distribution of products obtained from the devolatilization tests provides a comprehensive overview of the devolatilization that can be implemented in the CFD simulation of gasification. The results of the gasification tests were then used to validate the model.

To accurately represent the behavior of the laboratory-scale polypropylene gasification process, kinetic laws for homogeneous and heterogeneous reactions were selected from the literature and properly adapted.

**Conclusions:** The developed model can be implemented in the study and simulation of more complex cases such as industrial ones by providing an indication of their possible behavior.

Such a model thus provides important support in the area of modeling and sizing of fluidized bed gasification reactors on an industrial scale, behavior usually analyzed by cold models obtained by downsizing that do not implement heat transfer phenomena and chemical kinetics.

## References

[1] Polypropylene global market volume 2015-2029 | Statista

<https://www.statista.com/statistics/1245169/polypropylene-market-volume-worldwide/>.

[2] D. Tokmurzin et al., Energy Convers. Manag. <https://doi.org/10.1016/J.ENCONMAN.2022.115925>



## Testing and characterization of a 5 kW SOE stack: full load, partial load and hot-standby mode analysis

F. Panaccione\*, E. Crespi, M. Bolognese, L. Prattico, M. Testi

\* corresponding author: fpanaccione@fbk.eu

Fondazione Bruno Kessler, Via Sommarive, 18, 38123 Povo (TN), Italy

Keywords: Hydrogen Production, Hot Stand-By, SOE, Stack Characterization

### Abstract

**Introduction:** The purpose of the study is to characterize a 5 kW SOE stack, to analyse its performance when operated in different working conditions, mainly full load, partial load and hot standby mode. The stack characterization is required to implement similar SOE stacks in relevant environment, as planned in the PROMETO project, where 25 kW pilot systems will be designed and tested. The systems will be powered by PV electricity and heat from a concentrated solar power plant and will produce hydrogen to be injected into the natural gas grid or for ammonia generation.

**Objectives:** The objectives of this work are:

1. To characterize the 5 kW SOE stack when producing hydrogen at full load and at partial operation, under different operating conditions.
2. To identify the optimal conditions to operate the stack in hot-standby mode, keeping the stack warm without producing hydrogen while preserving the stack's health. Hot-standby operation mode is required for example during the night, when renewable electricity from the sun is not available for green hydrogen production.

**Material and methods:** The stack characterization is performed through an experimental campaign, which has been carried out at FBK facilities using a dedicated test bench. The stack is tested at different voltages (ranging from the OCV value, ~63V, and 100 V), operating temperature (i.e., varying the temperature setpoint of the reactants heaters and of the stack heater between 680°C and 760°C), steam flowrate entering the stack (ranging from 360 g/h and 1900 g/h), and hydrogen concentration in the steam entering the stack.

**Results:** The experimental campaign has allowed to identify the stack current (proportional to hydrogen production) in many different conditions. Additionally, the stack has been characterized in terms of Area Specific Resistance (ASR) [1] [2] and concentration overvoltage at high current density [3]. For example, Figure 1 shows that, fixed the operating temperature and steam flowrate, to increase the hydrogen production a drop in the theoretical stack efficiency (i.e., the ratio between thermoneutral voltage and stack voltage,  $V_{th}/V$  [4]) is required, moving from the endothermic to the exothermic region). Performances are positively affected by an increase in temperature or steam flowrate. Performance obtained at thermoneutral voltage (Figure 2) are of main importance for the definition of the control of the produced hydrogen flowrate. According to the experimental results, two different control strategies are identified, both keeping the stack at constant voltage and differing for the way in which the hydrogen generation is controlled: i) varying the steam flowrate supplied to the stack while working at maximum steam utilization and constant temperature, ii) varying the stack temperature while the steam flowrate is controlled to have a low steam utilization. The hot-standby tests have allowed to analyse the decay of the stack performance over time in three different operating conditions:

- Hydrogen-enriched forming gas (20% H<sub>2</sub> and 80% N<sub>2</sub>) flowing in the negative electrode. Air flows in the positive electrode. No power is applied to the stack.
- Hydrogen-enriched steam (20% H<sub>2</sub> and 80% steam) flowing in the negative electrode. Air flows in the positive electrode. No power is applied to the stack.
- No flow in the negative electrode. Air flowing in positive electrode side. Application of constant voltage (1 V per cell) to the stack.

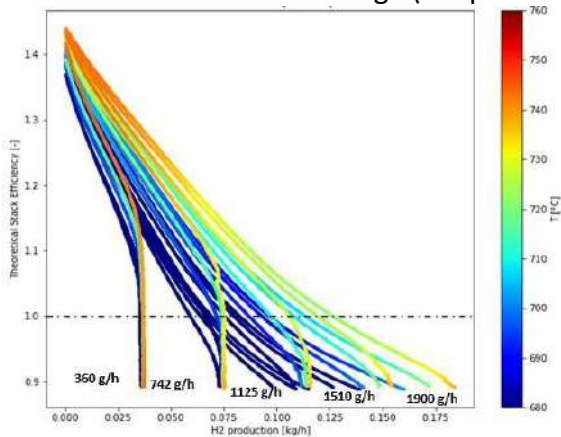

Figure 1 - Theoretical stack efficiency vs hydrogen production.

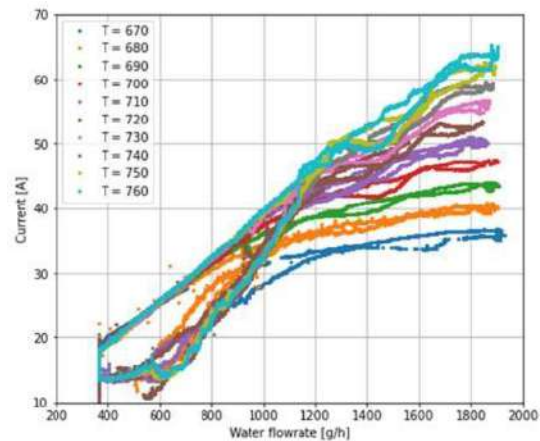

Figure 2 – Current values measured for different steam flow rates and set point temperatures.

For each standby mode, the performance of the stack after 200 hours has been compared to the initial value (health check). While standby mode a) and b) showed negligible performance variation, standby mode c) shows a relevant performance drop, possibly caused by the oxidation of the electrode for a reverse flow of air in the negative electrode.

**Conclusions:** In conclusion, this work includes an innovative analysis of a 5 kW SOE stack, which is tested not only at nominal full load operation, but also at partial load and in hot standby mode. The identification of the stack performance in different operating conditions has allowed to define a control for the hydrogen production as well as to identify the best conditions to keep the system hot when hydrogen is not produced.

### Acknowledgment

The project has received funding from the Fuel Cells and Hydrogen 2 Joint Undertaking (now Clean Hydrogen Partnership) under Grant Agreement n° 101007194 - Prometeo. The Joint Undertaking receives support from the European Union's Horizon Europe research and innovation program, Hydrogen Europe, and Hydrogen Europe Research. This paper and the research behind it would not have been possible without the support of SOLYDERA teams (Dr. Stefan Diethelm and Dr. Dario Montinaro) for the supply of the modified SOE stack and the sharing of technical specifications.

### References

- [1] L. Barelli et al., "Airflow Management in Solid Oxide Electrolyzer (SOE) Operation: Performance Analysis," *ChemEngineering*, doi: 10.3390/chemengineering1020013.
- [2] X. Zhang et al. "Improved durability of SOEC stacks for high temperature electrolysis," *Int. J. Hydrogen Energy*, doi: 10.1016/j.ijhydene.2012.09.176.
- [3] M. Ni et al., "Parametric study of solid oxide steam electrolyzer for hydrogen production," *Int. J. Hydrogen Energy*, doi: 10.1016/j.ijhydene.2007.03.001.
- [4] A. A. AlZahrani et al., "Thermodynamic and electrochemical analyses of a solid oxide electrolyzer for hydrogen production," *Int. J. Hydrogen Energy*, doi: 10.1016/j.ijhydene.2017.03.186.





## Carbon-Free Hydrogen Generation via Biogas Steam Reforming in Membrane Reactors: from Single Stage to Integrated Systems

Adolfo Iulianelli<sup>a\*</sup>, Henry Bryan Trujillo Ruales<sup>a</sup>, Kamran Ghasemzadeh<sup>b</sup>, Cristina Italiano<sup>c</sup>, Lidia Pino<sup>c</sup>, Antonio Vita<sup>c</sup>

\* corresponding author: [a.iulianelli@itm.cnr.it](mailto:a.iulianelli@itm.cnr.it), [adolfo.iulianelli@cnr.it](mailto:adolfo.iulianelli@cnr.it)

<sup>a</sup> National Research Council – Institute on Membrane Technology (CNR-ITM), via P. Bucci 17C at University of Calabria, Rende (CS), 87036 - Italy

<sup>b</sup> Manchester University,

<sup>c</sup> National Research Council - The Advanced Energy Technology Institute (CNR-ITAE), Salita Santa Lucia Sopra Contesse 5, Messina (ME), 98126 - Italy

Keywords: biogas, hydrogen, membrane reactor, steam reforming

**Abstract:** Currently, H<sub>2</sub> is produced industrially through an environmentally impacting process such as the steam reforming of natural gas. Using biogas instead of the former could constitute an eco-friendly option that, combined to the utilization of intensified solutions such as the membrane reactors, may allow the production of carbon-free H<sub>2</sub> in a unique stage process. This work shows the potential of the membrane reactors, under single stage or as an integrated multi-stages system, to generate carbon-free H<sub>2</sub>, meeting the targets set by the European Clean H<sub>2</sub> Partnership under the Strategic Research & Innovation Agenda 2021-2027.

**Introduction:** Biogas steam reforming (BSR) reaction has gained growing attention as a candidate to substitute natural gas in the generation of H<sub>2</sub> without releasing additional CO<sub>2</sub> in the environment [1]. Meanwhile, in order to meet the pressing needs of the energy infrastructure decarbonisation, the generation of carbon-free H<sub>2</sub> in membrane reactors (MRs) has attracted particular relevance as an intensified solution with respect to the conventional reformers, making the H<sub>2</sub> generation and its separation possible in the same process unit at milder conditions [2].

**Objectives:** In this work, an integrated two-stages system constituted of a Pd-based MR in series with a Pd-based membrane purifier is studied and compared to a single stage Pd-based membrane reactor with the purpose of meeting the target values (2020-2024) set by the European Clean H<sub>2</sub> Partnership regarding the generation and recovery of decarbonized H<sub>2</sub> from the steam reforming of a synthetic biogas stream.

**Material and methods:** The two-stages experimental system deals with a self-supported Pd-Ag MR (Stage 1) to carry out the BSR reaction to generate H<sub>2</sub>, partially recovered as a high

grade H<sub>2</sub> stream in the permeated side, while the H<sub>2</sub> fraction still present in the unpermeated stream is further separated in a supported Pd/Al<sub>2</sub>O<sub>3</sub> membrane purifier (Stage 2).

**Results:** The single stage MR allowed a CH<sub>4</sub> conversion of around 100% (Figure 1) and a H<sub>2</sub> recovery of 40% at feed ratio 2/1, 400 °C and 0.2 h<sup>-1</sup> of space velocity, while the integrated system allowed a global H<sub>2</sub> recovery of 80% (1<sup>st</sup> stage + 2<sup>nd</sup> stage) with a mean purity of 99.99%, reached at 350 kPa. These performance allowed to meet the targets 2020-2024 of H<sub>2</sub> recovery and purity set by the Clean Hydrogen Joint Partnership.

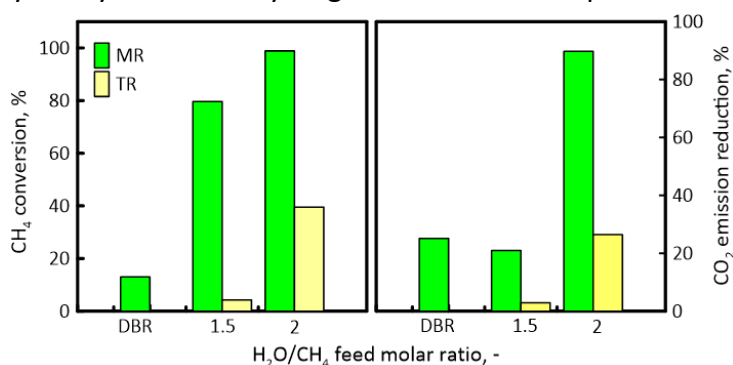

Figure 1. Single stage MR performance at 400 °C, 0.2 h<sup>-1</sup> and 350kPa.

**Conclusions:** The integrated membrane-based system allowed to recover globally H<sub>2</sub> up to 80% with a mean purity of 99.99% over the total amount produced during the steam reforming of biogas. Furthermore, this study pointed out the possibility of depleting a significant amount of CO<sub>2</sub> fed to Stage 1 (Figure 1), as part of the model biogas stream, up to achieving a net CO<sub>2</sub> reduction equal to 92% at 400 °C and 350 kPa.

**Acknowledgment:** PLUG-IN project, PRIN - Nr. 2020N38E75 and the Research Agreement (POR)-PNRR-“Hydrogen Research - Mission M2-C2 - Investment 3.5: LA1.1.25 and LA1.2.7 are acknowledged to fund different parts of this work.

## References

- [1] S.D. Angeli, L. Turchetti, G. Monteleone, A.A. Lemonidou, Catalyst development for steam reforming of methane and model biogas at low temperature, *Appl. Catal. B Env.*, 181 (2016) 34-46.
- [2] A. Iulianelli, S. Liguori, J. Wilcox, A. Basile, Advances on methane steam reforming to produce hydrogen through membrane reactors technology: a review, *Catal. Rev. Sci. Eng.*, 58 (2016) 1-35.



## ADVANCEPEM project: A cost-effective and pressurized green hydrogen production by PEM water electrolysis

Antonino Salvatore Aricò <sup>\*a</sup>

\* corresponding author: [arico@itae.cnr.it](mailto:arico@itae.cnr.it)

<sup>a</sup> CNR-ITAE Institute of Advanced Energy Technologies, National Research Council, Via Salita S. Lucia Sopra Contesse 5, 98126, Messina, Italy

Keywords: Hydrogen production, Water electrolysis, Proton exchange membrane.

### Abstract

The direct production of highly pressurised hydrogen from electrolytic water splitting can save relevant amounts of energy compared to down-stream gas compression. The aim of ADVANCEPEM is to develop a novel polymer electrolyte membrane (PEM) electrolyser which can produce hydrogen at very high pressures (200 bar) thus reducing the energy consumption required for post-compression. Very pure and high pressure electrolytic hydrogen can be directly used in various industrial processes such as ammonia synthesis requiring up to 200-300 bar, hydrogenation of oils and other hydrogenation processes in refineries requiring feed pressures up to 200-250 bar, methanol synthesis requiring 70 bar etc. and for direct injection into the high-pressure gas grid (~ 80 bar).

Another key goal is development of a cost-effective technology enabling large-scale application of PEM electrolysers. A significant reduction of capital costs will be achieved by minimising critical raw materials, developing low-cost coated bipolar plates, operation of the electrolyser at a high production rate while maintaining high efficiency (about 80% vs. HHV) and safe operation. ADVANCEPEM aims to develop a set of breakthrough solutions at materials, stack and system levels to increase hydrogen pressure to 200 bar and current density to 5 A cm<sup>-2</sup> for the base load, while keeping the nominal energy consumption <50 kWh/kg H<sub>2</sub>. Reinforced Aquivion® polymer membranes with enhanced conductivity, high glass transition temperature and increased crystallinity, able to withstand high differential pressures, will be developed for this application[1]. This innovative membrane will be operated at high temperature 90-140 °C under high pressure to provide for increased energy efficiency. To mitigate hydrogen permeation to the anode and related safety issues, efficient recombination catalysts will be integrated into both membrane and anode structure[2-4]. The new technology will be validated by demonstrating a high-pressure electrolyser of 50 kW



nominal capacity with a production rate of about 24 kg H<sub>2</sub>/day in an industrial environment. The project will also deliver a techno-economic analysis to assess reduction of the electrolyser CAPEX and OPEX. The consortium comprises an electrolyser manufacturer, membrane and catalyst supplier, a membrane electrode assembly (MEA) developer and an end-user for demonstrating the system.

### **Acknowledgment**

The authors acknowledge the financial support from the ADVANCEPEM project. This project is supported by the Clean Hydrogen Partnership and its members including top-up funding by the UK Research and innovation under grant agreement No 101101318. This Joint Undertaking receives support from the European Union's Horizon Europe research and innovation programme, Hydrogen Europe and Hydrogen Europe research.

### **References**

- [1] Siracusano, S., Pantò, F., Tonella, S., Oldani, C., Aricò, A.S. Reinforced short- side-chain Aquivion® membrane for proton exchange membrane water electrolysis, (2022) International Journal of Hydrogen Energy, 47 (35), p. 15557.
- [2] Pantò, F., Siracusano, S., Briguglio, N., Aricò, A.S. Durability of a recombination catalyst-based membrane-electrode assembly for electrolysis operation at high current density (2020) Applied Energy, 279, art. no. 115809,
- [3] Briguglio, N., Pantò, F., Siracusano, S., Aricò, A.S., Enhanced performance of a PtCo recombination catalyst for reducing the H<sub>2</sub> concentration in the O<sub>2</sub> stream of a PEM electrolysis cell in the presence of a thin membrane and a high differential pressure (2020) Electrochimica Acta, 344, art. no. 136153.
- [4] Briguglio, N., Siracusano, S., Bonura, G., Sebastián, D., Aricò, A.S. Flammability reduction in a pressurised water electrolyser based on a thin polymer electrolyte membrane through a Pt-alloy catalytic approach. (2019) Applied Catalysis B: Environmental, 246, pp. 254-265.



## Enhancement of Thermophysical Properties and Assessment of Heat-Transfer by Ti- And Si-Based Nanofluids for Fuel-Cell Cooling

Veronica Testa<sup>\*a, b</sup>, Marcello Romagnoli<sup>a, b</sup>, Maria Cannio<sup>a</sup>, Alessandro d'Adamo<sup>a, b</sup>,  
Paolo E. Santangelo<sup>b, c</sup>

\* corresponding author: [vertesta@unimore.it](mailto:vertesta@unimore.it)

<sup>a</sup> Università di Modena e Reggio Emilia- Dipartimento di Ingegneria "Enzo Ferrari"

<sup>b</sup> Centro Interdipartimentale di Ricerca e per i Servizi nel settore della produzione, stoccaggio ed utilizzo dell'Idrogeno H<sub>2</sub> - MO.RE

<sup>c</sup> Università di Modena e Reggio Emilia - Dipartimento di Scienze e Metodi dell'Ingegneria

Keywords: global heat transfer coefficient, nanoparticles, thermal conductivity, viscosity

### Abstract

**Introduction:** Proton Exchange Membrane Fuel Cells (PEMFC) is considered an eco-friendly and sustainable solution for power generation towards substituting fossil fuels and reducing pollutant emissions in the automotive sector. Fuel cells operate at temperatures below 100 °C and produce electricity as a result of the redox reaction between hydrogen and oxygen. Nanofluids have been recently employed in PEMFC cooling systems, thanks to their enhanced thermophysical properties: added nanoparticles, typically with a size on the order of 1 to 100 nm, dispersed in the base fluid, significantly increase thermal conduction [1]. These nanoparticles can be made from a variety of materials, including metals, nitrides (e.g., TiN), oxides (e.g., SnO<sub>2</sub>, TiO<sub>2</sub>, Al<sub>2</sub>O<sub>3</sub>, SiO<sub>2</sub>) and carbon-based materials. The recent widespread use of nanofluids in PEMFC is promoted by the need for reducing the overall size of the system, which is key in mobile applications. This work is focused on the use of Ti-based (e.g., TiN, TiO<sub>2</sub>) and Si-based (e.g., SiO<sub>2</sub>) nanoparticles dispersed in a water/ethylene glycol (W/EG) mixture at different concentrations, with the aim to improve cooling efficiency. The increased thermal conductivity may allow to remove heat from the PEMFC stack more effectively, which can lead to an improved fuel efficiency, reduced emissions and more cost-effective manufacturing processes. As an unprecedented contribution, nanoparticle concentration is optimized to maximize thermal conductivity, together with minimizing reduction of specific heat capacity due to the low specific heat capacity of nanoparticles. Notably, the particle small size implies a decrease in their specific heat capacity as a result of quantum confinement effects, which is a remarkable drawback.

**Objectives:** The main scope is to assess the optimal amount of nanoparticles to enhance heat transfer, also containing the associated costs. To minimize clogging, it is instrumental to select type and concentration of nanoparticles added to the base coolant and to appropriately design the cooling channels to attain the desired flowrate under the imposed pumping power.



Moreover, stability of the prepared suspensions is addressed to maintain optimal performance.

#### **Material and methods:**

1. Powder characterization in terms of nanostructure, particle size distribution and dispersion in the base fluid employing Scanning Electron Microscopy (SEM) and laser scattering granulometer;
2. Evaluation of chemical stability through Zeta-potential measurements: it includes variation of sonication time by ultrasonic and mechanical stirrer to reduce agglomeration, modification of particle concentration, inclusion of surfactants to reduce attractive forces and insertion of citric acid to fix pH of the involved suspension;
3. Measurement of dynamic viscosity and thermal conductivity towards an optimal composition in comparison with the base fluid, which includes cost evaluation, toxicity and environmental impact associated with the use of nanoparticles;
4. Heat transfer assessment of coolants through a dedicated experiment.

**Results:** The use of different nanoparticles – either individually or combined – enhances heat-removal capabilities, as heat transfer coefficient increases with respect to the base fluid. The experimental dataset supports the augmented heat transfer by nanofluids, accompanied with higher pressure losses. Enhanced heat transfer allows inserting a smaller cooling system, thus resulting in a reduction in the required space. However, the heat-exchanger design, the desired flowrate of the coolant and ambient temperature are also very impactful on the overall heat dissipation. Increasing flowrate yields greater heat transfer rate, but also implies larger energy consumption by the circulating pump. The present work emphasizes the importance to balance heat transfer rate with energy consumption towards higher efficiency, also relating that to nanofluid composition.

**Conclusions:** Nanofluids have been extensively studied as potential coolants, thanks to their higher thermal conductivity, which leads to enhanced heat transfer and cooling performance. However, their use is still limited in industry, due to major challenges in scaling up their production and concerns about their stability and long-term performance. As a comprehensive approach to their design, the higher-pressure losses and the impact of the imposed flowrate on overall efficiency of the cooling system are considered and quantified.

#### **References**

- [1] S. U. S. Choi and J. A. Eastman, 'Enhancing thermal conductivity of fluids with nanoparticles', *Nano Energy*, vol. 2, no. 5, pp. 845–855, Oct. 1995, doi: 10.1016/J.NANOEN.2013.02.007.



## Molten Carbonate Reversible Cells for carbon capture

Audasso E.\*, Kim K.I., Park J.H., Jun Y.B., Jo J.W., Nam S.W., and Yoon S.P.

\* corresponding author: [audassoe@kist.re.kr](mailto:audassoe@kist.re.kr)

Center for Hydrogen-Fuel Cell Research Group, Korea Institute of Science and Technology  
5 Hwarang-ro, 14-gil, Seongbuk-gu, Seoul, 402-792, Korea

Keywords: Carbon capture, Long-term test, Molten carbonate reversible cell, performance analysis

### Abstract

Molten carbonate reversible cells are a valuable tool for carbon capture while also producing energy and hydrogen/syngas. However, their performance is still to be thoroughly investigated and they are not yet ready for direct commercialization. In this work the authors explored molten carbonate reversible cells to prove their possible commercial use studying their performance both in term of operating parameters effects (temperature, gas composition) and long-term operations. The results showed that their application is possible and can help in reducing CO<sub>2</sub> emissions.

### Introduction:

Molten carbonate cells are chemical devices that can be used for energy or hydrogen/syngas production to decrease the fossil fuel and thus help in the mitigation of climate changes. Recently, their use in direct (fuel cell [1]), reverse (electrolysis cell [2]), and reversible mode has been investigated for carbon capture as they can move CO<sub>2</sub> from a low concentrated high current stream to a high concentrated low current stream facilitating further capture steps. As both electrolysis via molten carbonate cells and reversible operating mode have not been extensively studied, in this work the authors will investigate the performance of such cell to understand the limits and benefits of their possible use.

### Objectives:

Objective of this study is to evaluate the performance of reversible molten carbonate cells. The focus will be put on (1) evaluating the effects of temperature and gas concentrations, especially for what concern electrolysis mode that still need investigation, (2) on long-term performance.

### Material and methods:

For the experimental campaign different 10x10 cm<sup>2</sup> single cells were tested. For the fuel electrode a Ni-Al alloy was used, for the air electrode lithiated NiO,  $\gamma$ -LiAlO<sub>2</sub> for the matrix, and a eutectic mixture of LiCO<sub>3</sub>/NaCO<sub>3</sub> in the ratio 52/48 for the electrolyte that differs from the currently more investigated Li/K electrolyte cells.

## Results:

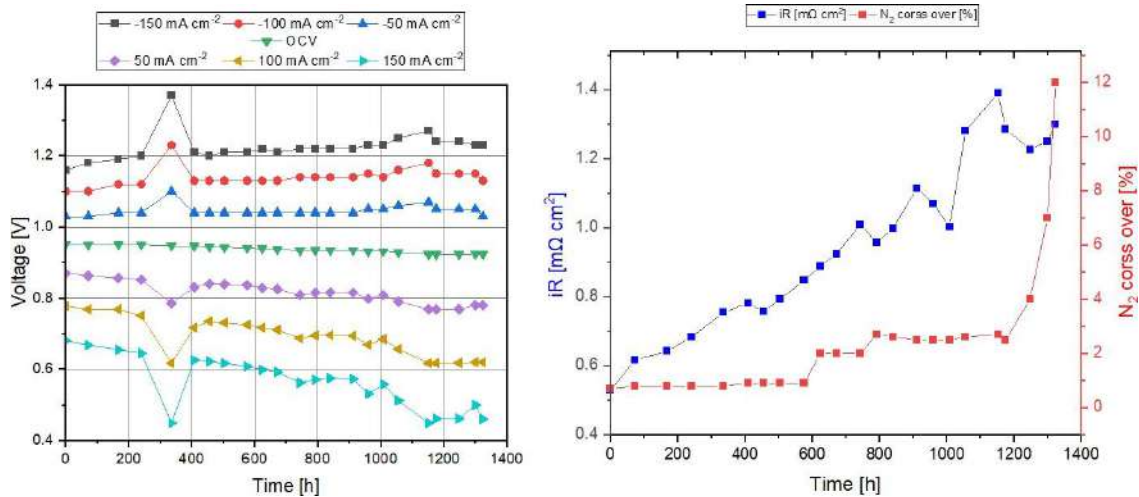

Figure 1: Long-term performance of a molten carbonate cell operating in reversible mode at different times.

Figure 1 presents the results of a long-term test at 923 K. The cell was operated alternating between fuel cell and electrolysis mode. The performance in term of I-V curves were collected at fixed intervals going from  $-150 \text{ mA cm}^{-2}$  to  $150 \text{ mA cm}^{-2}$ . Together EIS curves were measured to study the cell degradation and  $\text{N}_2$  cross-over was evaluated using gas chromatography. The cell showed good and stable performance for the first 1000 hours. After, due to electrolyte depletion and subsequent increase of cell resistance the cell suddenly died.

Analysis of the influence of operating temperature and gas concentrations also showed that the cell are cable to cope with different operating conditions.

## Conclusions:

The results of the experimental campaign indicate that molten carbonate cell working in reverse mode can be positively applied to reduce the use of fossil fuels while also helping in the reduction of carbon emissions.

## Acknowledgment

The work was supported by the Brain Pool Program of the National Research Foundation of Korea (NRF)), granted financial resources from the Ministry of Education, Science & Technology, Republic of Korea (2021H1D3A2A02083087).

## References

- [1] J. Rosen, T. Geary, A. Hilmi, R. Blanco-Gutierrez, C.Y. Yuh, C.S. Pereira, L. Han, R.A. Johnson, C.A. Willman, H. Ghezal-Ayagh, T.A. Barckholtz, Molten Carbonate Fuel Cell Performance for CO<sub>2</sub> Capture from Natural Gas Combined Cycle Flue Gas, *J Electrochem Soc*, 167 (2020) DOI: ARTN 064505 10.1149/1945-7111/ab7a9f.
- [2] E. Audasso, K.I. Kim, G. Accardo, H.S. Kim, S.P. Yoon, Investigation of molten carbonate electrolysis cells performance for H<sub>2</sub> production and CO<sub>2</sub> capture, *J Power Sources*, 523 (2022) 231039 DOI: <https://doi.org/10.1016/j.jpowsour.2022.231039>.



## Accelerated Stress Test Protocols for SOC

D. Vladikova<sup>\*a,b</sup>, B. Burdin<sup>a</sup>, A. Sheikh<sup>a</sup>, P. Piccardo<sup>c</sup>, M. Krapchanska<sup>a</sup>,  
D. Montinaro<sup>d</sup>, R. Spotorno<sup>c</sup>

\* corresponding author: [d.vladikova@iees.bas.bg](mailto:d.vladikova@iees.bas.bg)

<sup>a</sup> Institute of Electrochemistry and Energy Systems, Bulgarian Academy of Sciences, 10 Acad. G. Bonchev, 1113 Sofia, Bulgaria

<sup>b</sup> Institute for Sustainable Transition and Development, Students Campus, Trakia University, 6015 Stara Zagora, Bulgaria

<sup>c</sup> Dipartimento di Chimica e Chimica Industriale, University of Genova, Via Dodecaneso 31, 16146 Genoa, Italy

<sup>d</sup> SOLIDpower S.p.A, Via Trento 115/117, 38017 Mezzolombardo, Italy

*Keywords: accelerated stress tests, protocols, SOFC/SOEL*

**Abstract:** This work aims at presenting an algorithm for the development of Accelerated Stress Test protocols (AST) for Solid Oxide Cells (SOC). Twelve protocols were elaborated in the frames of the FCH JU2 project AD ASTRA. An example is given in more details for AST protocol for *ex-situ* aging of the fuel electrode by chemical redox-cycling.

**Introduction:** Solid Oxide Cells have an important role in the energy sector, ensuring opportunities for integration of renewable energy sources into the overall energy system. However, the applications still meet durability and costs barriers. Considering the expected useful commercial maintenance-free lifetime of up to 80 000 hours for stationary applications, a challenging objective is to maintain the initial, or close to initial performance for as long as possible. The work on life time improvement needs long term electrochemical tests for accumulation of reliable data that may continue several years, which is unaffordable for the fast commercialization. A problem-solving approach is the introduction of Accelerated Stress Tests, applying high levels of stress for a shorter period. The experimental conditions should activate the same degradation mechanisms as in non-accelerated testing, thus preventing the system from irreversible changes which may bring to false results.

**Objectives:** The main goal of this presentation is to demonstrate an approach for elaboration of AST protocols which have been developed in the FCH JU Project AD ASTRA.

**Approach:** A testing and characterization combination of: (i) new samples designed for AD ASTRA, and (ii) old samples from previous field tests (performed by SOLIDPOWER and SUNFIRE) was used. A special data bank was introduced as a friendly tool for storing in an organized way inputs from field tests, previous projects, as well as the data generated within the project experimental campaigns “form cradle to grave”.

**Results:** From the performed experiments 12 AST protocols were elaborated. Two main approaches in respect to the introduction of the stressor were applied:

- *In-situ* aggravated tests which generate harsh operational conditions (6 Protocols);
- *Ex-situ* artificial ageing which reproduces faster the degraded condition of critical component or interface in respect to calendar aging in nominal conditions.

The protocols follow one and the same structure, giving information about: selected AST approach; samples used; experimental set-up; nominal operation parameters; stressor and stress factor; acceleration factor (AF):

$$AF = \frac{t_{long\ term\ test}}{t_{AST\ bringing\ to\ the\ same\ degradation}}$$

In the end of the protocol there is an example showing its application and the results obtained.

In this presentation an example of AST protocol using *ex-situ* aging of the fuel electrode by chemical redox-cycle aging in a cell configuration before operation is discussed in more details. The oxidation conditions are selected to ensure mild partial oxidation which does not cause irreversible changes. The deepness of oxidation in a single cycle is adjusted by the value of the resistance in the oxidized state, monitored by impedance, for which a special procedure is developed. As seen in the table below, 20 redox cycles cause degradation similar to that produced after 4000 hours testing. Taking into consideration that 20 redox cycles of a cell can be performed for about 50 hours, the AF is estimated to be about 80.

	20 redox	4000 h	6000 h
$i, A/cm^2$	$\frac{U_{in} - U_{20\ red}}{U_{in}} \cdot 100$ [%]	$\frac{U_{in} - U_{4000\ h}}{U_{in}} \cdot 100$ [%]	$\frac{U_{in} - U_{4000\ h}}{U_{in}} \cdot 100$ [%]
0,28	2,5	2,07	3,70
0,50	4,5	4,35	7,13

**Conclusions:** The project AD ASTRA developed a convenient and clear algorithm for AST Protocols for SOC which can be used for further introduction of ASTs and protocols. The application of a standard form facilitates both the development of new protocols as well as their application.

**Acknowledgments:** The research leading to these results received funding from FCH JU2 under Grant agreement № 825027. This Joint Undertaking receives support from the European Union's Horizon 2020 research and innovation program and Hydrogen Europe.



## Multi-Flanges for intensive cell development and LCT for Large cell and stack evaluation

Raphael Ihringer <sup>\*a</sup>, Jean Girardon <sup>a</sup>, Pierre Coquoz<sup>a</sup>

\* raphael.ihringer@fiaxell.com

<sup>a</sup> Fiaxell Sarl

EPFL Innovation Park PSE-A

1015 Lausanne

Switzerland

*Keywords: multi-testing, large cell, stack testing*

### Abstract

Two new test benches have been developed at Fiaxell. One is the multi-Flanges allowing to test 4 cells in one run. All the functionalities of the Open flanges, such as integrated steamer, real or ideal condition testing, ceramic housing on air side, gas processing are kept apart short stacking.



4-MF: Multi-Flanges™ allowing to test 4 cells in a same run

The second test rig is the LCT for Large Cell Tester. It has been designed for cell dimension starting from 90 X 90 mm and ending with the size of 130 mm X 170 mm. Again all the Open Flanges functionalities are kept. The LCT is no delivered for short stack of maximum 3 cells. In the second part of 2022, heat exchanger made with proper material will be ready for market. It will allow to test up to 30 cells.



# European Fuel Cells and Hydrogen

PIERO LUNGI CONFERENCE

September 13th-15th 2023  
Capri / Italy

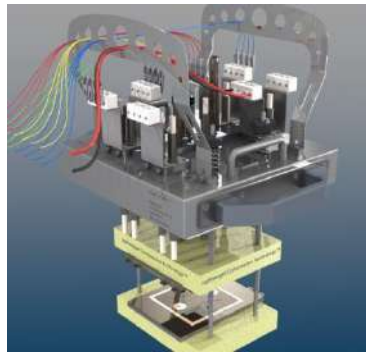

LCT™ Large cell tester equipped with Lightweight  
Compression Technology™



## Performance of Reversible MCFC Fueled By Raw Gas from Biomass Gasification

Deniz Yildiz\*, Juan Pedro Pérez Trujillo, Klas Engvall, and Carina Lagergren

\* corresponding author: dyildiz@kth.se

Department of Chemical Engineering, KTH Royal Institute of Technology,  
SE-100 44 Stockholm, Sweden

*Keywords: Reversible Molten Carbonate Fuel Cell, Molten Carbonate Electrolysis Cell, Hydrogen Production, Biomass Gasification*

### Abstract

**Introduction:** In order to meet the 2050 net zero emission goals, fossil fuel-based energy and chemical production paths need to be replaced by renewable energy resources. Biomass gasification has been identified as a promising route for production of renewable fuels. However, raw gas produced from biomass gasification requires further processing both to remove various pollutants and to elevate the hydrogen concentration in the gas mixture to improve the energy density. Reversible molten carbonate fuel cell (RMFC) emerges as a candidate technology not only for direct power and fuel production applications, but also for integrated applications in renewable energy production and CO<sub>2</sub> separation systems [1]. RMFC is a durable technology [2] with a wide tolerance range to fuel variability and is a potential technology to function as a part of various biomass gasification scenarios due to its tolerance to varying operating conditions also in electrolysis mode (MCEC) [3]. This work presents an experimental study to explore the use of RMFCs in combination with the raw gas from biomass gasification to evaluate the potential to integrate the cell into a biomass gasification process. Successful operation of the electrochemical unit on this gas can enhance the gasification technology by providing a sustainable and efficient method for cleaning and upgrading of the raw syngas stream.

**Objectives:** The purpose of the study is to investigate the electrochemical performance of the lab-scale RMFC with “simulated” raw gas mixtures that represent product gas compositions from different types of biomass gasification. Elucidation of the electrochemical performance of RMFC with raw syngas can allow for the design and fine-tuning of the technology for integrated applications.

**Material and methods:** The feasibility and operating limits of RMFC are explored via polarisation curves and electrochemical impedance spectroscopy (EIS) measurements. A so-called button cell with 3 cm<sup>2</sup> geometric surface area was used to carry out the analysis with conventional fuel cell components for the fuel electrode, oxygen electrode and matrix, i.e., Ni, NiO and  $\gamma$ -LiAlO<sub>2</sub>, respectively. The eutectic mixture 62/38 % (Li/K)<sub>2</sub>CO<sub>3</sub> was used as electrolyte. The button cell allows for isolated measurements for the individual electrodes, as well as, the overall cell.

**Results:** Steady-state polarisation curves and EIS were obtained at varied humidity at the Ni electrode inlet and varied cell temperatures measurements while the inlet gas on the NiO side was unaltered. The dry composition of the model gas represents a typical composition of raw gas from air gasification and it constituted 10, 16, 14, and 4 mol% for H<sub>2</sub>, CO, CO<sub>2</sub>, and CH<sub>4</sub> respectively, balanced in Ar. Water content was varied between 20, 30, and 40 mol%. The iR-

corrected polarisation curves (Figure 1) exhibit continuous behaviour which indicates that it is feasible to operate the cell reversibly with the model raw gas from air gasification. The overpotential in the electrolysis mode decreases with increased humidity in the Ni electrode inlet gas, as the increased content of water enhances the electrolytic processes.

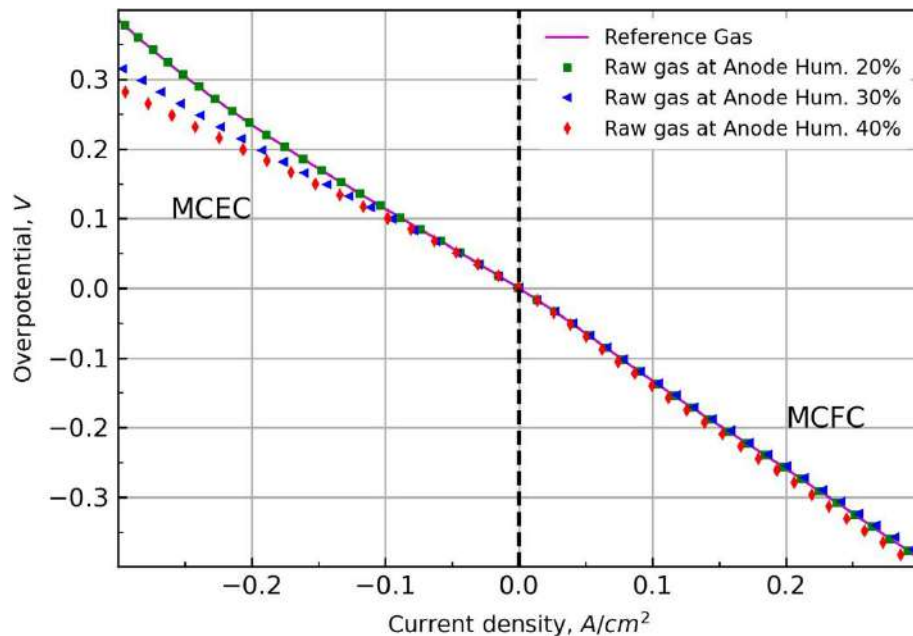

**Figure 1:** Comparison of iR-corrected polarisation curves for the RMCFC at 650 °C

**Conclusions:** Electrochemical measurements elucidated that the RMCFC exhibits good performance in both fuel cell and electrolysis modes with the simulated raw gas from biomass gasification. This indicates the feasibility of using RMCFC in both operational modes in an integrative manner in biomass gasification applications. Further studies are necessary to gain an understanding of tolerance limits to aromatics such as toluene.

**Acknowledgements:** This work was sponsored by the Swedish Energy Agency. The cell components were provided by Ansaldo Fuel Cells in Italy.

### References

- [1] E. Audasso, K.I. Kim, G. Accardo, H.S. Kim, S.P. Yoon, Investigation of molten carbonate electrolysis cells performance for H<sub>2</sub> production and CO<sub>2</sub> capture, *J. Power Sources*. 523 (2022). <https://doi.org/10.1016/j.jpowsour.2022.231039>.
- [2] L. Hu, G. Lindbergh, C. Lagergren, Performance and Durability of the Molten Carbonate Electrolysis Cell and the Reversible Molten Carbonate Fuel Cell, *J. Phys. Chem. C*. 120 (2016) 13427–13433. <https://doi.org/10.1021/acs.jpcc.6b04417>.
- [3] S. Mesfun, J. Lundgren, A. Toffolo, G. Lindbergh, C. Lagergren, K. Engvall, Integration of an electrolysis unit for producer gas conditioning in a bio-synthetic natural gas plant, *J. Energy Resour. Technol.*, Transactions of the ASME. 141 (2019). <https://doi.org/10.1115/1.4040942>.

## Validation of Solid Oxide Fuel Cell short Stack test bench in SO-FREE Project

Francesco Marino<sup>a,b</sup>, Lorenzo Arcidiacono<sup>a</sup>, Francesca Santoni<sup>a\*</sup>, Andrea Monforti Ferrario<sup>a,c</sup>, Luca Simonetti<sup>a</sup>, Antonio Scotini<sup>a</sup>, Arda Hatunoglu<sup>d</sup>

\* corresponding author: francesca.santoni@enea.it

<sup>a</sup> Department of Energy Technologies and Renewable Sources, Laboratory of Energy Storage, Batteries and Hydrogen Production and Use (TERIN-PSU-ABI), ENEA, Rome, Italy;

<sup>b</sup> Department of Engineering, Università degli Studi di Napoli Parthenope, Napoli, Italy;

<sup>c</sup> Department of Industrial Engineering and Mathematical Sciences (DIISM), Università Politecnica delle Marche, Ancona, Italy;

<sup>d</sup> Department of Engineering Sciences, Università degli Studi Guglielmo Marconi, Rome, Italy.

### Introduction:

Solid Oxide Fuel Cells (SOFCs) are proving to be a promising option for highly efficient co-generation in future gas distribution networks, allowing to contribute to the decarbonization of the residential and industrial sectors. When it comes to residential employment, normally power below 5 kWe -  $\mu$ CHP - the FC is the only energy conversion system that maintains a high efficiency even at these scales, thus  $\mu$ CHP units can be distributed at the end users for the local and simultaneous production of electricity and heat from chemical energy vectors, avoiding transport and distribution losses of these secondary vectors. The SO-FREE project fits in this scenario, with the overall objective to development of a SOFC-based system for fuel-flexible CHP generation with the realization of a standardized stack-system interface able to allow full interchangeability of stack types..

### Objectives and Material&Methods:

ENEA R.C. carries out experimental activities, at the short-stack level, related to the electrochemical characterization and performance mapping of the two stack models supplied by project partners (Elcogen E350 and Fraunhofer IKTS MK35x). To ensure and demonstrate the interoperability of the SOFC stacks, both of them have to be tested on the same test bench, specially built up for the project. In Figure 1 the short stack integration in ENEA test bench is shown. The scope of this work is the short stack test bench preliminary validation, to check that the electrochemical performances are aligned with the values obtained from the stack manufacturer during the Factory Acceptance Tests. The campaign is performed in reference conditions varying the fuel utilization factor (60%-75%-80%) in order to evaluate the performance of the stacks to be integrated into the system.

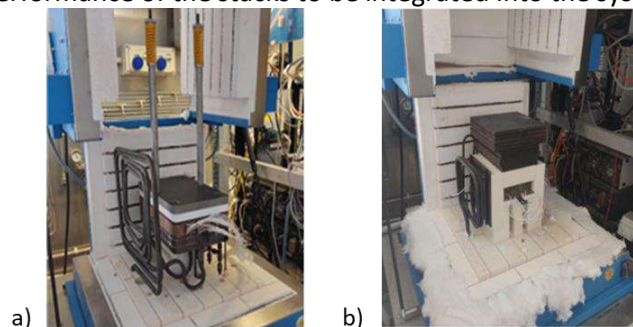

Figure 1 Integrated E350 short stack (a); and MK351 short stack (b).

## Results :

In Figure 2 the comparison between the performance, using reference conditions, obtained by ENEA and the two manufacturers are shown.

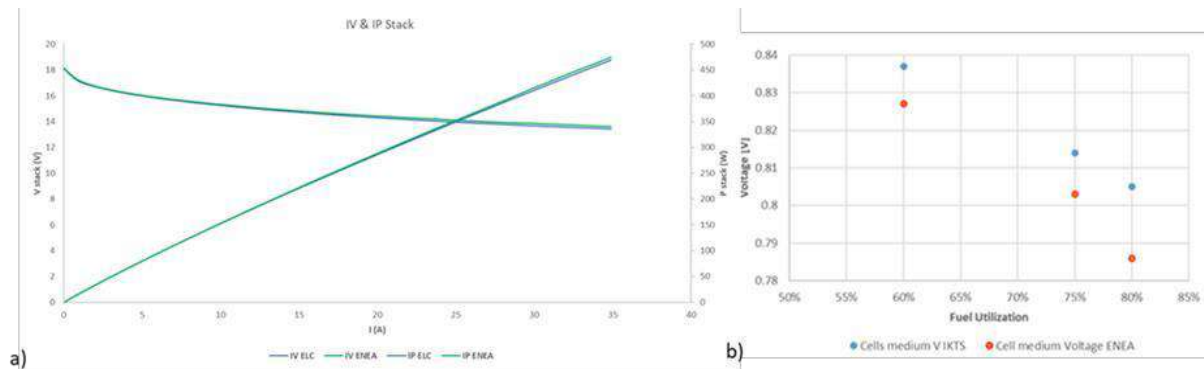

Figure 2 Reference test: IV curves ENEA-ELCOGEN comparison (a), Cells voltages ENEA-IKTS comparison (b).

The concept of the test for ELC is significantly different from that of IKTS: the validation of the setup ELC side consists of evaluating the electrical performances of the entire stack through IV curves, by definition obtained in non-steady state conditions. The voltage and the power obtained at the maximum current (35 A) are 13.61 V and 475 W for ENEA and 13.4 V and 469.4 W for ELC, which are by all means comparable.

From IKTS side instead the interest is shifted towards the electrical performances of each cell, assessed in a stable working condition. The medium voltages measured in ENEA are respectively 0.827 V, 0.803V, and 0.786 V for the 60-75-80% of UF, while the measured medium voltages for the same conditions in IKTS are slightly higher, 0.837 V, 0.814 V, 0.805 V. The values obtained in the two facilities are in any case very similar, with a maximum relative error of 2.4% at UF 80%.

## Conclusions:

The stack performances achieved in ENEA in these preliminary tests are entirely comparable with those of the two manufacturers. Firstly, these results confirm the short-stack test bench validation, proven by the accurate juxtaposition of data from ENEA and manufacturers; on the other hand, they demonstrate the full interoperability of stack types.

## Acknowledgment:

This research has been done within the frame of SO free project (Solid oxide fuel cell combined heat and power: Future-ready Energy, supported by Fuel Cells and Hydrogen 2 Joint Undertaking), grant agreement no. 101006667, and conducted in the research center ENEA Casaccia.





## Supporting research & innovation of hydrogen technologies through EU-wide harmonisation - developing terminology, testing protocols, test procedures and methods for performance and durability of electrolysis cells and electrolyser stacks

Thomas MALKOW, Alberto Pilenga

European Commission, Joint Research Centre, Westerduinweg 3, 1755 LE Petten, The Netherlands

### **Abstract**

Ongoing efforts in harmonising electrolysis techniques for producing green hydrogen from diverse renewable energy sources (such as wind, solar, and hydropower) actively support research and innovation under Horizon Europe. These activities form part of the annual work programme of the Clean Hydrogen Joint Undertaking. They focus on developing harmonised terminology, testing protocols, and evaluation methods to assess the performance (hydrogen production rate, energy efficiency) and durability (lifetime, degradation) of electrolyser technologies at cell and stack levels. This harmonisation is facilitated through collaboration with partners from EU-funded projects. The targeted electrolysis technologies include low-temperature water electrolysis in alkaline water electrolyser, anion-exchange membrane water electrolyser, proton-exchange membrane water electrolyser, as well as high-temperature steam electrolysis in solid oxide electrolyser and proton conducting electrolyser. JRC coordinates these efforts, leading to consensus on common definitions, terms, and guidelines for reliably evaluating research and development progress on electrolysis cells and electrolyser stacks. The outcomes of these evaluations enable meaningful and accurate comparisons of test results, facilitating the setting and revision of research and innovation priorities, development milestones, and technological benchmarks. Consequently, informed decisions regarding the selection of electrolysis technology most suitable for specific applications are possible. The documents resulting from these harmonisation activities are for the research community and industry alike, intending to promote development, facilitate demonstration, and fostering the widespread deployment of robust electrolysis technologies for green hydrogen production. It is worth noting that the experience gained and tangible outcomes achieved through these activities are utilised in the formulation of international standards by the International Organization for Standardization and the International Electrotechnical Commission.

## Investigating the effects of operating conditions on physicochemical processes in a lab-scale molten carbonate electrolysis cell

Silvia Lo Conte<sup>\*a</sup>, Simone Mataloni<sup>b</sup>, Massimiliano Della Pietra<sup>b</sup>, Maria Anna Murmura<sup>a</sup>,  
Maria Cristina Annesini<sup>a</sup>

\* corresponding author: [silvia.loconte@uniroma1.it](mailto:silvia.loconte@uniroma1.it)

<sup>a</sup> University of Rome "La Sapienza", Department of Chemical Engineering Materials and Environment, Via Eudossiana 18,  
00184 Rome, Italy

<sup>b</sup> Department of Energy Technologies and Renewable Sources, Laboratory of Energy Storage, Batteries and Hydrogen  
Production and Use (TERIN-PSU-ABI), ENEA Italian National Agency for Energy, New Technologies and Sustainable  
Economic Development, C.R. Casaccia, Rome, Italy;

*Keywords: co-electrolysis, electrochemical impedance spectra, molten carbonate cell*

### Introduction:

The co-electrolysis of water and CO<sub>2</sub> is a well-established process for converting electrical energy into chemical energy, which can help reduce the problem of the imbalance between the intermittent rate of electricity production from renewable sources and the continuous demand from the grid. In high-temperature electrolysis, some of the energy required for the process is in the form of heat, reducing the demand for electrical energy. Solid oxide electrolysis is the most mature technology of this kind, while the use of molten carbonate electrolysis cells (MCECs) has been demonstrated more recently. These cells can operate at lower temperatures compared to SOECs, namely 550-700°C, and can be used to exploit CO<sub>2</sub>-rich waste streams typically available in industrial environments, by converting them at the cathodic compartment into high-value syngas products. The main reactions taking place at the cathode and anode of the cell are, respectively,

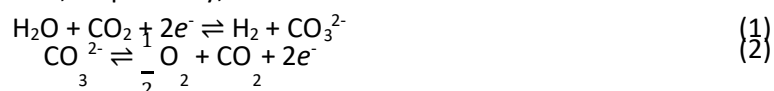

Although research on MCECs has increased recently, there is still a need for a better understanding of the physicochemical processes occurring within the cell to optimize its performance. The objective of this study is to characterize the electrochemical performance of a lab-scale MCEC, identifying the underlying physicochemical phenomena that take place within the cell. The impact of various operating parameters, including inlet gas composition and temperature, on each process, is examined to pinpoint the optimal operating conditions for this technology more precisely.

### Materials and methods:

Experimental data were obtained from the laboratory button cell unit with a geometrical electrode area of 3 cm<sup>2</sup>. Two reference electrodes, consisting of gold (Au) wires in equilibrium with a gas mixture of 33/67% O<sub>2</sub>/CO<sub>2</sub>, are placed in separate chambers filled with the same electrolyte as that in the cell. These chambers are connected to the cell through a capillary with a gold plug. The state-of-the-art components used in the study were provided by KIST (Korean Institute of Science and Technology, South Korea). A schematic drawing of the laboratory cell is shown in Figure . The cell and electrodes

electrochemical performance was evaluated by galvanostatic polarization tests and electrochemical impedance spectroscopy (EIS) under each of the different operating conditions tested. The frequency spectra were recorded at two different operating conditions, including open circuit voltage and electrolysis cell mode applying 100 mA/cm<sup>2</sup> to the cell.

MCECs are complex electrochemical devices, in which many processes occur at the same time, each process being characterized by its typical relaxation time. However, when two or more processes have similar relaxation times, it becomes difficult to separate and distinguish their individual contributions to the overall impedance of the cell. The Distribution of Relaxation Times (DRT) [1] method was used to deconvolute the impedance spectra, thus separating individual processes occurring within the cell. This method involves decomposing the impedance response of the system into a distribution of relaxation times, which represents the different characteristic timescales of the underlying electrochemical processes. By analyzing the DRT, valuable insights into the contributions of various relaxation processes and their impact on the overall impedance behavior can be gained. To elucidate the nature of each peak obtained with this method, the cell was operated under different predefined conditions, recording an EIS measurement for each of them, starting from a reference condition, and varying each time one of the following parameters: temperature, H<sub>2</sub>O content, and CO<sub>2</sub> content in the fuel electrode gas. This study represents one of the first application of the DRT approach to this technology allowing to understand the physicochemical origin of the individual polarization processes controlling the cell performance and the degradation.

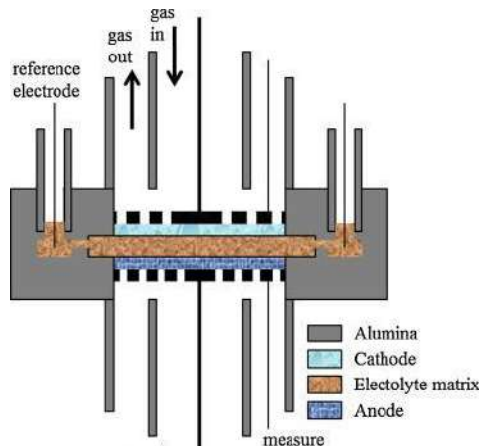

Figure 1 - Schematic drawing of the laboratory cell unit [2]

## Acknowledgement

This research was funded by the European Union – NextGenerationEU from the Italian Ministry of Environment and Energy Security, POR H2 AdP MEES/ENEA with involvement of CNR and RSE, PNRR – Mission 2, Component 2, Investment 3.5 “Ricerca e sviluppo sull’idrogeno”, CUP: I83C22001170006

## References

- [1] F. Santoni et al., “Accurate in-operando study of molten carbonate fuel cell degradation processes -part I: Physiochemical processes individuation,” *Electrochim Acta*, vol. 291, pp. 343–352, Nov. 2018, doi: 10.1016/J.ELECTACTA.2018.08.100.
- [2] M. Della Pietra, S. J. McPhail, S. Prabhakar, U. Desideri, S. W. Nam, and V. Cigolotti, “Accelerated test for MCFC button cells: First findings,” *Int J Hydrogen Energy*, vol. 41, no. 41, pp. 18807–18814, Nov. 2016, doi: 10.1016/J.IJHYDENE.2016.07.021.

## 3D Additive Manufacturing of Bipolar Plates for PEMFCs

Baltasar Toharias\*<sup>a</sup>, Christian Suárez<sup>a</sup>, Gracia Cabello<sup>a</sup>, Alfredo Iranzo<sup>a</sup>, Javier Santaolaya<sup>b</sup>, Felipe Rosa<sup>a</sup>

\* corresponding author: btoharias@us.es

<sup>a</sup> Thermal Engineering Group, Energy Engineering Department, School of Engineering, University of Seville, Spain

<sup>b</sup> Center for Advanced Aerospace Technologies (CATEC), Seville, Spain

*Keywords: Fuel cell, Bipolar plate material, Oxidation, Additive manufacturing methods*

**Abstract:** In the present work, the behaviour of a Proton Exchange Membrane Fuel Cell (PEMFC) with a serpentine parallel flow field design has been experimentally investigated. Conventionally machined graphite bipolar plates (BP) and aluminium bipolar plates produced by selective laser melting (SLM) were used. In both cases, various physical properties of the BPs were analysed in addition to the presence of post-test corrosion. The results showed a better I-V curve for the aluminium BPs, but the coating applied is not able to prevent corrosion.

**Introduction:** The most commonly used materials for the manufacturing of BPs in PEMFC fuel cells are graphite, with excellent corrosion resistance but poor mechanical properties, and aluminium, with good electrical conductivity and excellent mechanical properties. The main disadvantage is that they need to be coated to prevent corrosion [1]. The most common methods of manufacturing BPs are machining or stamping. However, much research has been done on the structure and dimensions of the flow field to improve the transfer capability of two-dimensional flow fields. In this context, additive manufacturing methods such as SLM appear as they allow the spatial distribution of the composition to be controlled with almost no geometrical constraints, allowing three-dimensional flow fields [2].

**Objectives:** To analyse the feasibility of introducing SLM in the manufacturing of BPs in PEMFC.

**Materials and methods:** A fuel cell with an active area of 50 cm<sup>2</sup> was analysed. The graphite BP has a serpentine parallel channel design and was machined conventionally, while the aluminium BP was fabricated using SLM, which allows for internal channels in the plate, as shown in the Figure 1 a. Electrical and thermal conductivity and surface roughness were compared for both BPs. A coating was applied to the aluminium BP after SLM.

**Results:** The tests are performed under different operating conditions. The reference test has an operating temperature of 65 °C, a pressure of 0.5 bar, an anode stoichiometry of 1.3, a cathode stoichiometry of 2.5 and a relative humidity (RH) of the anode and cathode of 60 %. (Figure 1 b).

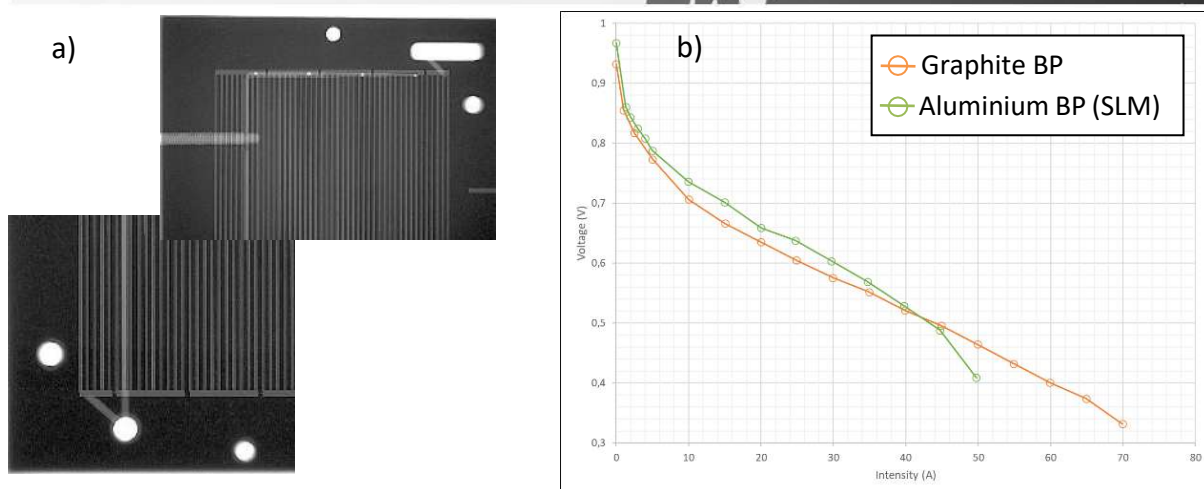

Figure 2. a) Tomography of BP and b) Polarisation curve for graphite BP and aluminium BP

The presence of corrosion was analysed by observing the composition of the coating before and after the test.

**Conclusions:** The manufacture of aluminium BPs by SLM allows the creation of three-dimensional flow designs that achieve better performance in the I-V curve than BPs machined in graphite. However, corrosion is present in the aluminium BPs after testing, so the coating method needs to be reconsidered.

#### Acknowledgment:

- Grant PID2019-104441RB-I00 funded by MCIN/AEI/10.13039/501100011033
- Grant TED2021-130706B-I00 funded by MCIN/AEI/10.13039/501100011033 and by the European Union NextGenerationEU/ PRTR
- VI PPIT and VII PPIT from the University of Seville and the Research, Technology and Innovation Centre (CITIUS) of the University of Seville
- Spanish Ministry of Economy and Competitiveness (Grant UNSE15-CE2962), funded by AEI/FEDER UE co-funded with ERDF funds

#### References:

- [1] Xiong K, Wu W, Wang S, Zhang L. 2021. Modeling, design, materials and fabrication of bipolar plates for proton exchange membrane fuel cell: A review. *Applied Energy* 301:117443.
- [2] Kong D, Ni X, Dong C, Zhang L, Man C, Yao J, Xiao K, Li X. 2018. Heat treatment effect on the microstructure and corrosion behaviour of 316L stainless steel fabricated by selective laser melting for proton exchange membrane fuel cells. *Electrochimica Acta* 276:293-303.



## Hydrogen enriched syngas from integration of thermochemical processes: devolatilization of softwood waste/coffee grounds pyrolysis char

L. Bartolucci<sup>a</sup>, S. Cordiner<sup>a</sup>, A. Di Carlo<sup>b</sup>, P. Mele<sup>a</sup>, V. Mulone<sup>a</sup>, A. A. Papa<sup>b,\*</sup>, A. Vitale<sup>b</sup>

\* corresponding author: [alessandroantonio.papa@univaq.it](mailto:alessandroantonio.papa@univaq.it)

<sup>a</sup>University of Rome Tor Vergata, Department of Industrial Engineering, via del Politecnico 1, 00133 Rome, Italy

<sup>b</sup>University of L'Aquila, Department of Industrial and Information Engineering & Economics, Via G. Gronchi 18, 67100 L'Aquila, Italy

*Keywords: hydrogen; steam gasification; biochar; polygeneration energy systems*

### Abstract

**Introduction:** Global actions to reduce climate change are increasingly referring to hydrogen, as a vector of great interest for energy storage from renewable sources and as key element to sustainable mobility and decarbonization of hard-to-abate industrial sectors. Biomass is a renewable energy source widely distributed worldwide and at low cost; its use is often anchored in traditional practices and obsolete technologies. Thermochemical processes (gasification, pyrolysis) allow the conversion of the energy potential of residual biomass in high-value products, such as syngas, bio-oil, and biochar, the solid residue of the pyrolysis process. Many works have recently been published on the integration of pyrolysis and gasification processes since biochar is a bioenergetic vector characterized by a high carbon content and a reduced content of volatile and oxygen (up to 10 %wt.) [1], still having potential energy that can be effectively converted into the gasification process. Furthermore, a two-stage process can be one of the alternatives for tar reduction, a crucial aspect for improving hydrogen separation efficiency and using syngas in engines or fuel cells [2].

**Objectives:** In this work, the production of hydrogen-enriched syngas through the steam gasification of biochar is investigated. First, softwood residues (SW) and dried spent coffee grounds (CG), two widely diffused feedstocks in many European countries, are pyrolyzed. Then, biochar samples were pelletized and subjected to devolatilization tests.

**Material and methods:** A 500 g/h screw-type reactor is employed for the intermediate pyrolysis process in the temperature range of 400-500°C under nitrogen atmosphere. The devolatilization tests are carried out in a fluidized bed reactor to reproduce real application conditions. Online analyzers are used to identify and quantify the devolatilization products.

Downstream the reactor, heavy hydrocarbons are collected using a tar sampling unit. Elemental and thermogravimetric analyses are carried out on the solid samples after each process to evaluate the mass and energy balances of the integrated pyrolysis-devolatilization concept and estimate the hydrogen and syngas yields accurately. Finally, devolatilization tars are analyzed with GC-MS to consider the actual impact of pyrolysis pretreatment on BTX and polycyclic aromatic hydrocarbons (PAH) concentrations.

**Results:** The effectiveness of the pyrolysis process in the removal of volatiles is analyzed by reporting the elemental and thermogravimetric analysis of biochar at various temperatures (Figure 1). The results of the devolatilization tests highlight the significant influence of the pyrolysis pretreatment conditions. The biochar obtained under higher severity conditions leads to lower gas production in devolatilization tests, with reduced CO and CO<sub>2</sub> due to lower oxygen availability in the feedstock. After the devolatilization of SW residues, the residual char increases from 22% for raw SW to 70% for the pyrolysis char obtained at 500 °C.

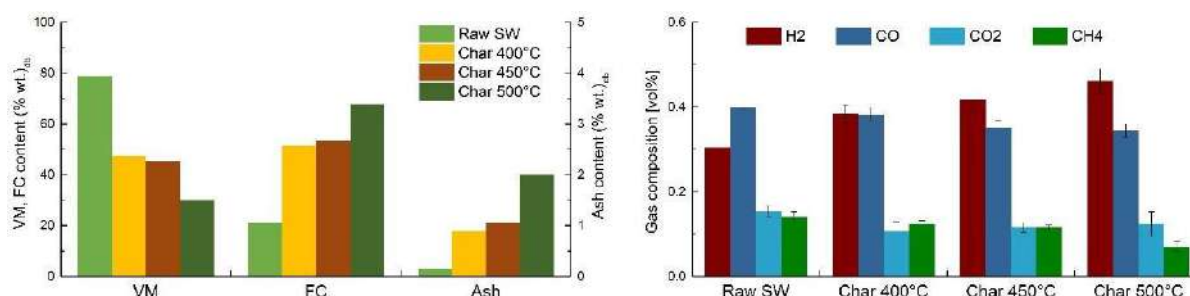

**Figure 3:** Proximate analysis and syngas composition of devolatilization tests (850°C) of pyrolysis char obtained in the temperature range 400-500°C for SW residues.

**Conclusions:** These results show how a temperature increase in pyrolysis pretreatment leads to a solid biochar with higher fixed carbon content, reduced volatile matter, and oxygen content halved compared to that of raw feedstock; moreover, ash content, whose role as a catalyst for cracking activity is reported to be an important element of biochar reactivity, is evaluated. The gas produced exhibits an increased H<sub>2</sub> content with the rise in pretreatment temperature. It is noteworthy that the remaining char could result in higher H<sub>2</sub> production during gasification conditions. Furthermore, the tar content decreases with the increasing severity of the pretreatment.

## References

- [1] H. Cay, et al., Energy and Fuels. 33 (2019) doi.org/10.1021/ACS.ENERGYFUELS.9B01354.
- [2] P. V. Aravind, W. De Jong, Progress in Energy and Combustion Science. 38 (2012) doi.org/10.1016/j.pecs.2012.03.006.

## Effect of Operating Conditions on Molten Carbonate Electrolysis Cell Performance: Experimental Study

Simone Mataloni<sup>\*a</sup>, Silvia Lo Conte<sup>b</sup>, Massimiliano Della Pietra<sup>a</sup>, Francesca Santoni<sup>a</sup>

\* corresponding author: [simone.mataloni@enea.it](mailto:simone.mataloni@enea.it)

<sup>a</sup> Department of Energy Technologies and Renewable Sources, Laboratory of Energy Storage, Batteries and Hydrogen Production and Use (TERIN-PSU-ABI), ENEA Italian National Agency for Energy, New Technologies and Sustainable Economic Development, C.R. Casaccia, Rome, Italy;

<sup>b</sup> University of Rome "La Sapienza", Department of Chemical Engineering Materials and Environment, Via Eudossiana 18, 00184 Rome, Italy

*Keywords: co-electrolysis, molten carbonate cell, gas chromatography, syngas*

### Introduction:

Molten carbonate electrolysis cells, taking advantage of the co-electrolysis of water and CO<sub>2</sub>, represent an innovation in the scientific landscape as devices for converting electrical energy into chemical products and as devices for the capture and utilization of carbon. Hydrogen, water, and carbon dioxide are supplied to the fuel electrode. The electrochemical reactions occurring in the cell are the following:

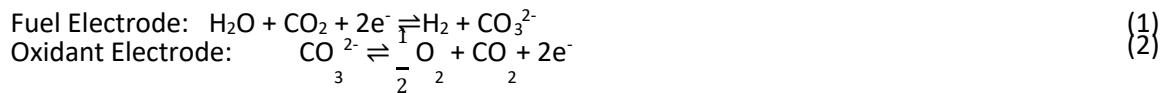

Molten carbonate cells operate at high temperatures, specifically between 550 and 700°C. At these temperatures, the gases supplied to the fuel electrode, in addition to being involved in the above-mentioned electrochemical reactions, can participate in other chemical reactions favored by operative conditions and electrode catalysts. In particular, we observe the Reverse Water Gas Shift Reaction:



Depending on the concentration of CO<sub>2</sub> and operating temperatures, a higher or lower production of carbon monoxide can be observed, depleting reactants from the electrochemical reaction and reducing the concentration of hydrogen exiting the cell. The objective of this study is to evaluate the effect of H<sub>2</sub>O and CO<sub>2</sub> concentrations supplied to the cell and the temperatures variation on the H<sub>2</sub> production capabilities.

### Material and methods:

The experimental data were obtained through an analysis of the performance of a single-cell unit with a geometric surface area of 100 cm<sup>2</sup>. The materials and state-of-the-art data were provided by the Korean Institute of Science and Technology (KIST). The cell is housed within a steel casing equipped with conduits for the supply of gases and water vapor to the electrodes. The casings also serve as electrical connections from the furnace exterior to the cell itself.



In order to study the cell's performance, its behavior was observed by independently varying the partial pressure of water vapor and CO<sub>2</sub> in the feed. Additionally, sensitivity analysis was conducted at three different temperatures: 620, 650 and 680°C .

For each combination of gas composition entering the fuel electrode, at each temperature, galvanostatic polarization (I-V) tests were conducted. Following the determination of the polarization curve, significant current densities were selected for each test. While maintaining the cell under the chosen load conditions, gas chromatographic analysis was performed on the fluxes exiting the fuel electrode. The experimental analysis of the cell's response to different concentrations, temperatures, and current densities allows for a careful evaluation of its performance. Gas chromatographic analysis, on the other hand, allows for the observation of the productivity of chemical and electrochemical reactions and how they are influenced by the operating conditions.



*Figure 4 - Experimental sequence*

### Conclusions:

Experimental studies have allowed for the evaluation of cell performance in terms of water and CO<sub>2</sub> consumption and hydrogen production. Variations in operating conditions have also been observed to impact the production of carbon monoxide derived from the reverse water gas shift reaction. An outgoing gas stream from the cell, enriched with hydrogen and CO, holds potential interest for its utilization as syngas in the production of liquid and/or gaseous fuels, such as methane, methanol, or ethanol. However, it is important to note that if the intention is to employ the hydrogen produced in fuel cells, carbon monoxide may act as a catalyst poison. Therefore, depending on specific objectives, careful consideration of the operating conditions is necessary.

### Acknowledgment

This research was funded by the European Union - NextGenerationEU from the Italian Ministry of Environment and Energy Security, POR H2 AdP MEES/ENEA with involvement of CNR and RSE, PNRR - Mission 2, Component 2, Investment 3.5 "Ricerca e sviluppo sull'idrogeno", CUP: I83C22001170006

### References

- [1] Monforti Ferrario A, Santoni F, Della Pietra M, Rossi M, Piacente N, Comodi G, Simonetti L. A system integration analysis of a molten carbonate electrolysis cell as an off-gas recovery system in a steam-reforming process of an oil refinery. *Frontiers in Energy Research*. 2021 Apr 21;9:655915.



## Experimental investigation of green hydrogen production via Molten Carbonate Electrolysers directly coupled with PV

Della Pietra M.\*<sup>a</sup>, Mataloni S.<sup>a</sup>, Lo Conte S.<sup>b</sup>, Loreti G.<sup>c</sup>, Cigolotti V.<sup>a</sup>

\* corresponding author: [massimiliano.dellapietra@enea.it](mailto:massimiliano.dellapietra@enea.it)

<sup>a</sup> Department of Energy Technologies and Renewable Sources, Laboratory of Energy Storage, Batteries and Hydrogen Production and Use (TERIN-PSU-ABI), ENEA Italian National Agency for Energy, New Technologies and Sustainable Economic Development, C.R. Casaccia, Rome, Italy;

<sup>b</sup> University of Rome "La Sapienza", Department of Chemical Engineering Materials and Environment, Via Eudossiana 18, 00184 Rome, Italy;

<sup>c</sup> DEIM - Department of Economics, Engineering, Society and Business Administration, University of Tuscia, 01100, Viterbo, Italy;

### Keywords:

- *Green hydrogen, Molten Carbonate Electrolysis Cells, PV*

### Abstract

#### Introduction:

In the field of green hydrogen production via electrolysis, several technologies gained more and more attention in the recent years. Among them, high temperature electrolysers (especially Solide Oxide Electrolysis Cells SOEC) jumped on the stage as one of the most efficient process to produce hydrogen. Together with SOEC electrolysers also Molten Carbonates Cells (MCCs) started to be investigated as a promising device for hydrogen production due to the high conversion rate obtainable and lack of precious metals composing them. MCCs differ significantly from SOCs in terms of operative conditions (e.g. reactants, operating temperature) and the performance of such devices have not been extensively investigated. Particularly only one work has been carried out on the degradation of MCCs operated in long term tests [1] and it was operated on a lab scale cell (3 cm<sup>2</sup>), while other studies on single repeating units (81 cm<sup>2</sup>) focused more on the performance evaluation varying several operative conditions [2,3]. The ambitious goal of this work is to carry out a long-term test on a MCC single repeating unit able to mimic the direct coupling of the electrolyser with PV during a typical meteorological year.

#### Objectives:

Aim of the experimental campaign is to continuously monitor the electrochemical performance of a molten carbonate electrolyser in load following configuration, simulating twelve typical days of PV distributed during the year. This approach will shade light on the dynamic behaviour of molten carbonate electrolysis pointing out degradation effects occurring during progressive increases and decreases of power load.

### Material and methods:

To effectively tackle the aforementioned issues the first step was to quantify the solar radiation in a typical meteorological year using the opens source tool from EU Photovoltaic Geographical Information System (PVGIS) geolocated at ENEA Casaccia R.C.. Subsequently a typical day for each month has been extrapolated basing this choice on the maximum standard deviation in term of power produced. Finally, a MCC single repeating unit has been powered following the profiles previously obtained. The experimental procedure is summarized in figure 1.

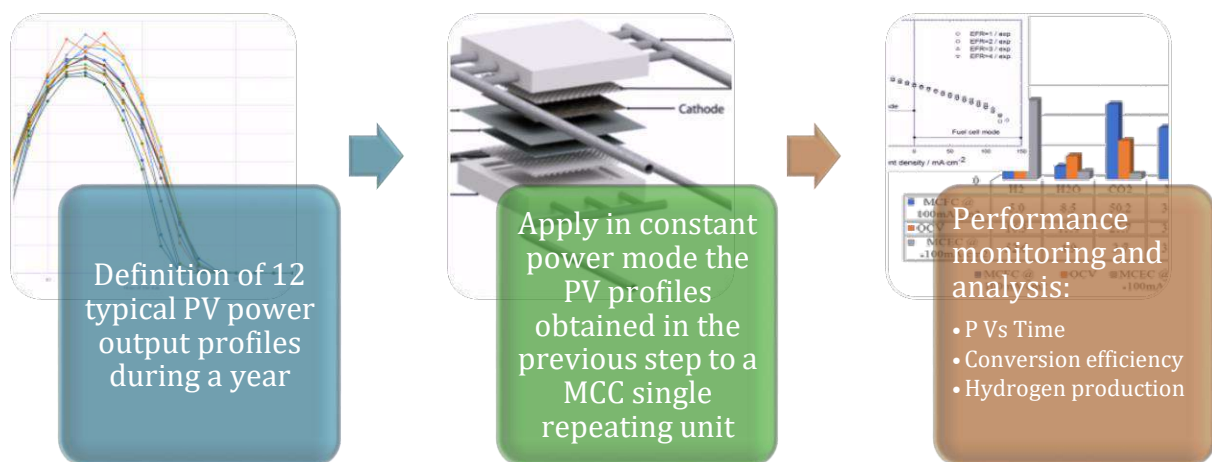

### Acknowledgment

This research was funded within WASTE2H2 project, that, has received funding from the European Union's Horizon 2020 research and innovation programme under grant agreement no 952593.

### References

- [1] Lan Hu, Göran Lindbergh, and Carina Lagergren. "Performance and Durability of the Molten Carbonate Electrolysis Cell and the Reversible Molten Carbonate Fuel Cell" J. Phys. Chem. C 2016, 120, 13427–13433
- [2] Juan PedroPerez-Trujillo, Francisco Elizalde-Blancas, Massimiliano Della Pietra, Stephen J.McPhail; "A numerical and experimental comparison of a single reversible molten carbonate cell operating in fuel cell mode and electrolysis mode" Applied Energy, Volume 226, 15 September 2018, Pages 1037-1055
- [3] Juan PedroPerez-Trujillo, Francisco Elizalde-Blancas, Stephen J.McPhail, Massimiliano Della Pietra, Barba Bosio. "Preliminary theoretical and experimental analysis of a Molten Carbonate Fuel Cell operating in reversible mode" Applied Energy Volume 263, 1 April 2020, 114630.



## Continuous Bunsen reaction of the Sulfur – Iodine thermochemical cycle for the production of green H<sub>2</sub>: Experimental and Modelling

Alice Bertino<sup>a\*</sup>, Maria Beatrice Falasconi<sup>a</sup>, Leone Mazzeo<sup>a</sup>, Alberto Giaconia<sup>b</sup>, Giampaolo Caputo<sup>b</sup>, Salvatore Sau<sup>b</sup>, Vincenzo Piemonte<sup>a</sup>

*\*Corresponding author E-Mail: [alice.bertino@unicampus.it](mailto:alice.bertino@unicampus.it)*

<sup>a</sup> *Faculty of Science and technology for sustainable Development and One Health, Unit of Chemical-physics Fundamentals in Chemical Engineering, University Campus Bio-medico of Rome, Via Alvaro del Portillo, 21, 00128 Rome, Italy*

<sup>b</sup> *Department of Energy Technologies and Renewable Sources, ENEA, Casaccia Research Center, Via Anguillarese, 301, 00123 Rome, Italy*

*Keywords: Continuous lab-scale set-up; green H<sub>2</sub>; liquid-liquid equilibrium; sulfur-iodine cycle.*

### Abstract

**Introduction:** The Bunsen reaction is the central node of the Sulfur – Iodine (SI) thermochemical cycle and is expressed as follows:

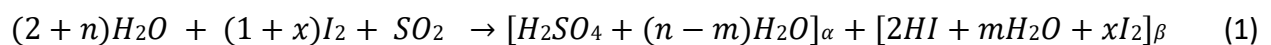

where  $n$  and  $x$  are the H<sub>2</sub>O and I<sub>2</sub> excesses, respectively, required for complete separation of the two product sulfuric ( $\alpha$ ) and HI $x$  ( $\beta$ ) liquid phases [1].

**Objectives:** When the SI cycle is powered by a solar source to produce green H<sub>2</sub>, a continuous functioning of the Bunsen reactor is desirable. Thus, the primary objective of this work was to build a continuous counter-current flow Bunsen reactor with a maximum SO<sub>2</sub> capacity of 10 NL h<sup>-1</sup>. Moreover, a macroscopic model was developed and validated using the reactor experimental data. Finally, a fitting of literature data was used to express the equilibrium partition coefficients of the various components in the two liquid ( $\alpha$  and  $\beta$ ) product phases.

**Material and methods:** The Bunsen reaction was carried out up to 6 hours in a packed continuous three-phase column reactor (T = 353 K, P = 1 atm) where  $G = 0.22$  mol h<sup>-1</sup> gaseous SO<sub>2</sub> and  $L = (2 + n)G$  liquid H<sub>2</sub>O were continuously fed from the bottom, while the two  $\alpha$  and  $\beta$  liquid phases were continuously collected from the top and the bottom, respectively. The lower section of the column was filled with inert tantalum ring packing to aid dispersion of SO<sub>2</sub>, resulting in a free reactor volume of  $V = 150$  mL. Above the inert filling, a molar flow rate  $S = (1 + x)G$  of I<sub>2</sub> was fed in the form of solid pellets, which were restored as they were depleted during the reaction to always guarantee I<sub>2</sub> saturation at the  $\alpha$ - $\beta$  interface.

For this reactor, where the simultaneous reaction and separation of  $\alpha$  and  $\beta$  takes place, a macroscopic model was built where functions of the type  $\ln K_i = f(x_i^\beta)$  for the equilibrium

partition coefficients  $K_i$  were obtained through a fitting of literature data.

**Results:** The fitting for  $K_{HI}$  and  $K_{H_2SO_4}$  ( $K_{I_2}$  and  $K_{H_2O}$  not displayed due to space limitations) and experimental data vs model results are shown in **Figure 1** and **Table 1**, respectively.

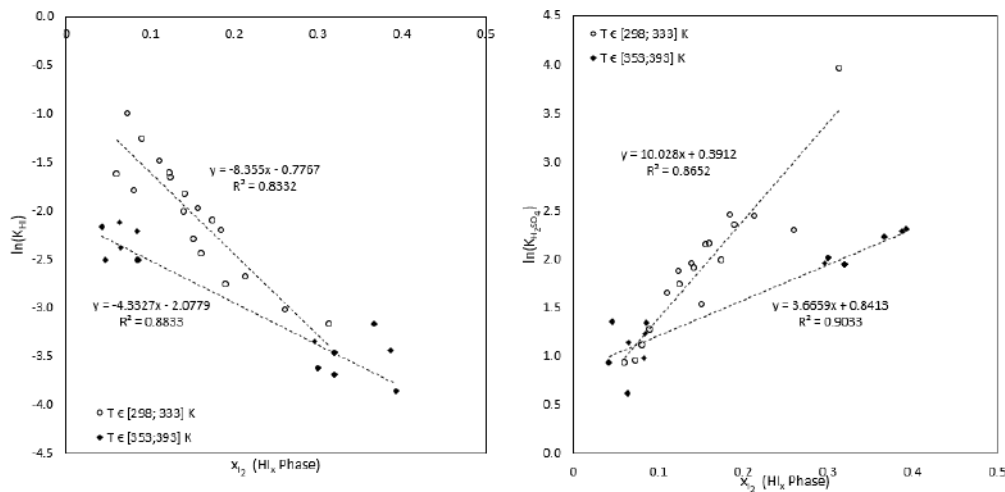

**Figure 1.** Fitting to find the functions  $\ln K_i = f(x_i^\beta)$  for  $i = HI$  and  $H_2SO_4$

**Table 1.** Experimental data ( $n = 10.05$ ,  $x = 4.3$ ) vs model

Molar fraction	Sulfuric phase $\alpha$				Hydroiodic phase $Q$			
	$x_{HI}^\alpha$	$x_{H_2O}^\alpha$	$x_{I_2}^\alpha$	$x_{H_2SO_4}^\alpha$	$x_{HI}^\beta$	$x_{H_2O}^\beta$	$x_{I_2}^\beta$	$x_{H_2SO_4}^\beta$
Experimental	0.01	0.82	0.01	0.17	0.14	0.52	0.33	0.02
Model	0.00	0.81	0.00	0.19	0.14	0.52	0.31	0.03
	<b>1 h</b>	<b>2 h</b>	<b>3 h</b>	<b>4 h</b>	Average (Exp.)		Model	
$\alpha$ (mL h <sup>-1</sup> )	20.0	22.5	20.0	20.08	20.08 ± 1.2		19.8	

**Conclusions:** This work introduces several innovations: the experimental set-up incorporates a unique approach of introducing solid  $I_2$  pellets in successive steps to maintain saturation conditions at the liquid-liquid interface, and is described with a novel model; unlike previous studies that focused on thermodynamic models examining only binary  $I_2/H_2O$ ,  $I_2/HI$  and  $H_2SO_4/H_2O$  systems, this study pioneers the description of the global equilibrium of all four components in the two Bunsen product phases through the fitting of partition coefficients.

## References

- [1] A. Giaconia *et al.*, "Experimental study of two phase separation in the Bunsen section of the sulfur – iodine thermochemical cycle," *Int. J. Hydrogen Energy*, vol. 32, pp. 531–536, 2007, doi: 10.1016/j.ijhydene.2006.08.015.



## Technological Pathways to produce compressed and highly pure Hydrogen from solar power

Mariya E. Ivanova<sup>1</sup>, Laura-Alena Schäfer<sup>1,2</sup>, Norbert H. Menzler<sup>1,2</sup>, Olivier Guillon<sup>1,2,3</sup>, et al.

\* Corresponding Author: m.ivanova@fz-juelich.de

### **Abstract:**

<sup>1</sup> Forschungszentrum Jülich GmbH, Institute of Energy and Climate Research (IEK-1), Jülich, Germany

<sup>2</sup> RWTH Aachen University, Institute of Mineral Engineering (GHI), Department of Ceramics and Refractory Materials, 52064 Aachen, Germany

<sup>3</sup> Jülich-Aachen Research Alliance: JARA-Energy, 52425 Jülich, Germany

Hydrogen (H<sub>2</sub>) produced from renewables has a growing impact on the global energy dynamics towards sustainable and carbon-neutral economy. The share of green H<sub>2</sub> is still too low to meet the net-zero target, while the demand for high-quality hydrogen continues to rise. These factors amplify the need for economically viable H<sub>2</sub> generation technologies. The present talk will make an overview of the existing technologies for high-quality H<sub>2</sub> production based on solar energy. Technologies such as water electrolysis (PV coupled to electrolyzers), photoelectrochemical and solar thermochemical water splitting, liquid metal reactors and plasma conversion utilize solar power directly or indirectly (as carbon-neutral electrons) and will be reviewed from the perspective of their current development level, technical limitations and future potential for the generation of highly pure and compressed H<sub>2</sub> [1].

**Key words:** *H<sub>2</sub> generation, Water electrolysis, Water splitting, Methane pyrolysis, H<sub>2</sub> purification and compression*

### **Acknowledgements**

The Helmholtz Association of German Research Centres (HGF) and the Federal Ministry of Education and Research (BMBF), Germany are acknowledged for supporting the development of solar powered H<sub>2</sub> generation technologies within the frame of the Innovation Pool Project “Solar H<sub>2</sub>: highly pure and compressed”, HGF research program “Materials and Technologies for the Energy Transition” (MTET).

### **Reference:**

[1] M. E. Ivanova et al., Angew. Chem. Int. Ed. 2023, e202218850

## Analysis of Testing Conditions Variability on ECM Parameters Identification from EIS Measurements of SOEC Stack

Pierpaolo Polverino<sup>\*a</sup>, Cesare Pianese<sup>a</sup>, Bertrand Morel<sup>b</sup>, Julien Manzi<sup>b</sup>, Žiga Gradišar<sup>c</sup>, Jan Pieter Ouweltjes<sup>d</sup>

\* corresponding author: ppolverino@unisa.it

<sup>a</sup> Department of Industrial Engineering, University of Salerno, via Giovanni Paolo II 132, 84084, Fisciano (SA), ITALY.

<sup>b</sup> Univ. Grenoble Alpes – CEA/LITEN, 17 rue des Martyrs, F-38054 Grenoble, FRANCE.

<sup>c</sup> Jožef Stefan International Postgraduate School, Jamova cesta 39, SI-1000 Ljubljana, SLOVENIA.

<sup>d</sup> SolydEra SA, Avenue des Sports 26, 1400, Yverdon-les-Bains, SWITZERLAND

*Keywords: Solid Oxide Electrolyser Cell, Electrochemical Impedance Spectroscopy, Equivalent Circuit Model, Parameters Identification Sensitivity*

### Abstract

In the last years, hydrogen emerged as one of the most viable options for the energy transition from fossil fuels to sustainable and zero-emission energy sources. The possibility to use hydrogen as energy storage medium by producing it from Renewable Energy Sources (RES) excess energy through water electrolysis fostered its capability of being a key competitor of batteries, especially for large scale storage.

To date, electrolyser technologies are still showing durability levels below the desired targets. This could be improved by employing more advanced monitoring, diagnostics and fault mitigation tools. The design of such tools requires proper algorithms that can take advantage of information being acquired non-invasively on the systems that otherwise may stay unnoticed, and the use of advanced probing techniques, such as Electrochemical Impedance Spectroscopy (EIS).

Among the several diagnostic approaches, the use of Equivalent Circuit Models (ECMs) allow expressing the performance of electrolysers through physics-related parameters that provide detailed lumped or discrete information about the electrochemical losses inside the electrolyser components by proper fitting of the EIS spectra.

This work presents the investigation of the effects related to the variability of EIS testing methodologies and operating conditions on the identification of ECM parameters for diagnostic purposes. The experimental data have been measured on a 6-cell solid oxide electrolyser (SOEC) stack under defined nominal and faulty operating conditions, to support the development of adequate advanced characterization methodologies for SOEC stacks operated in the field.



First, the measured EIS and long-term data are described, analyzed and classified in order to identify the most representative operating variables and the defined set-points for each measurement. Then the acquired EIS spectra are fitted with an ECM model and the corresponding parameters are associated to the identified operating conditions. Finally, the sensitivity of the parameters identification is assessed by observing the influence exerted by the monitored variables and the considered EIS stimuli (sinusoidal or PRBS).

This analysis is fundamental for designing the statistical significance of the ECM parameters that will be used for diagnostic purposes. In this way, the proper classification of nominal and faulty conditions can be performed, taking into account the deviation of the achieved operating condition with respect to the defined set-points and the way the EIS measurements are performed.





## Analysis of an MCEC using the Distribution of Relaxation Times technique

Juan Pedro Pérez Trujillo\*, Deniz Yildiz, Lan Hu, Göran Lindbergh, Carina Lagergren

\* Corresponding author: [jppt@kth.se](mailto:jppt@kth.se)

Applied electrochemistry, Department of Chemical Engineering, KTH Royal Institute of Technology, SE-100 44 Stockholm, Sweden

*Keywords: Molten Carbonate Electrolysis Cell, Distribution of Relaxation Times, Electrochemical Process Identification, Hydrogen Production*

### Abstract

**Introduction:** Molten Carbonate fuel cell (MCFC) is a commercialised and mature technology employed for big-scale power production [1]. Nevertheless, there are some scientific and technical opportunity areas to explore [2], including the operation in electrolysis mode. There are a number of experimental, numerical and thermo-economic studies analysing the performance of Molten Carbonate Electrolysis Cells (MCECs). The experimental studies were mainly carried out at lab-scale level with button and single cells. In the case of button cells, they offer the possibility to carry out half-cell measurements which helps to analyse the electrodes independently. Among the different experimental techniques, the electrochemical impedance spectroscopy (EIS) enables fast diagnostics of the cells although it is difficult to identify the individual processes occurring in the system. In this regard, EIS can be complemented with the Distribution of Relaxation Times (DRT) technique which is useful to identify and understand the influence on different processes of the operating conditions [3].

**Objectives:** The aim of this work is to present and identify the processes that take place in the electrodes of an MCEC and how they influence the total impedance in a full cell operation. A correct process identification could help to propose more accurate equivalent circuit models or to carry out analytical timescale analysis.

**Material and methods:** A 3 cm<sup>2</sup> button cell was used to carry out the analysis using standard components for the fuel electrode, oxygen electrode and matrix, i.e., Ni, NiO and  $\gamma$ -LiAlO<sub>2</sub>, respectively. The eutectic mixture 62/38 % (Li/K)<sub>2</sub>CO<sub>3</sub> was used as electrolyte. The inlet composition of the gases and the cell temperature were varied, one at a time, as described in [4,5] in open-circuit voltage (OCV) and under electrolysis operation.

**Results:** The half-cell measurements show that the major contribution to the polarisation overpotentials comes from the NiO electrode as shown by the EIS spectra from Figure 1a. It is also indicated that the effect of each electrode is additive if the experimental conditions are

maintained steady. The greater contribution of the NiO electrode is also depicted using the Bode plots, Figure 1b, although the impedance of the individual processes is shown altogether. The DRT facilitates separation and identification of peaks correlated with the individual processes in each electrode, Figure 1c, and their contribution in the full cell. In total four peaks per electrode were identified and five peaks for the full cell measurements. Additional results indicate that the intensity of the peaks as well as the polarisation resistance is lower in electrolysis than in OCV because the production of O<sub>2</sub> and CO<sub>2</sub> in the NiO electrode improves the diffusion and activity of the cell.

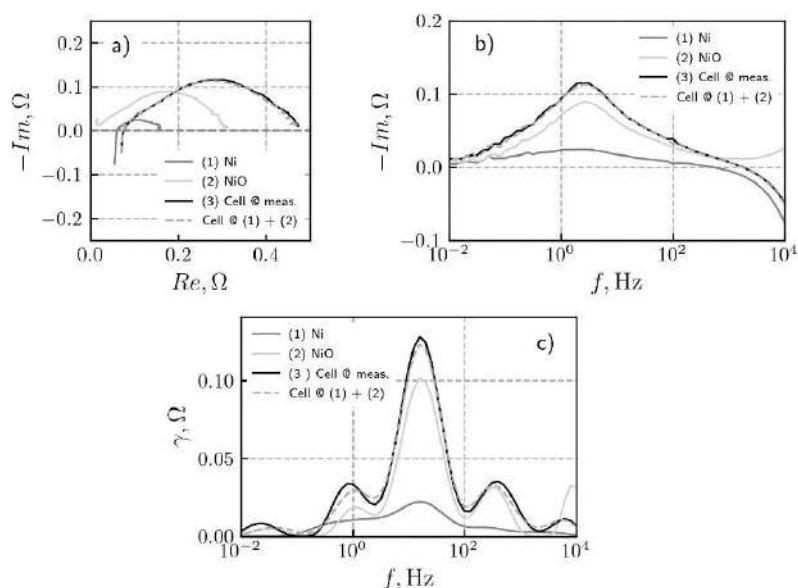

Figure 5. a) EIS, b) Bode, and c) DRT spectra of the electrodes and full cell in OCV, operating at 650°C and standard gas mixtures.

**Conclusions:** The DRT offers a qualitative analysis of processes in MCEC using the EIS spectra. In this work the impedance half-cell measurements helped to identify four peaks per electrode where the major contribution is due to the species diffusion which occurs in the range of approximately 1-100Hz.

## Acknowledgement

This work was sponsored by the Swedish Government research program “STandUP for Energy”. The cell components were provided by Ansaldo Fuel Cells in Italy.

## References

- [1] A. Moreno, V. Cigolotti, M. Della Pietra, L. Leto, S.J. McPhail, International status of molten carbonate fuel cells technology 2015, ENEA. (2015).
- [2] J.R. Selman, C.-C. Chen, Scientific and technical maturity of molten carbonate technology, Int J Hydrogen Energy. 37 (2012) 19280–19288. <https://doi.org/10.1016/j.ijhydene.2012.06.016>.
- [3] S. Dierickx, A. Weber, E. Ivers-Tiffée, How the distribution of relaxation times enhances complex equivalent circuit models for fuel cells, Electrochim Acta. 355 (2020) 136764. <https://doi.org/10.1016/j.electacta.2020.136764>.
- [4] L. Hu, G. Lindbergh, C. Lagergren, Operating the nickel electrode with hydrogen-lean gases in the Molten Carbonate Electrolysis Cell (MCEC), Int J Hydrogen Energy. 41 (2016) 18692–18698.
- [5] L. Hu, G. Lindbergh, C. Lagergren, Electrode kinetics of the Ni porous electrode for hydrogen production in a Molten Carbonate Electrolysis Cell (MCEC), J Electrochem Soc. 162 (2015) F1020–F1028.

## Hydrogen Production Systems – a Review

Gabriele Micciché<sup>\*a</sup>, Sonia Longo<sup>a</sup>, Maurizio Cellura<sup>a</sup>, Manfredi Picciotto Maniscalco<sup>b</sup>, Marco Ferraro<sup>b</sup>

\* corresponding author: gabriele.micciche@unipa.it

<sup>a</sup> affiliation: Department of Engineering, University of Palermo, Viale Delle Scienze Ed.9, 90128 Palermo, Italy

<sup>b</sup> affiliation: National Research Council of Italy – Institute for Advanced Energy Technologies, Viale Delle Scienze Ed.9, 90128 Palermo, Italy

*Keywords: hydrogen, environmental impact, Life Cycle Assessment*

**Introduction:** Hydrogen is considered as one of the pillars of the European decarbonization strategy, boosting a novel concept of the energy system in line with the EU's commitment to achieve clean energy transition. This paper reviews several production pathways to produce hydrogen (Brown, Grey, Blue, Turquoise and Green) to assess the most promising technologies to reach the European Green Deal carbon neutrality goals by 2050.

**Objectives:** The objective is to produce the first review work of hydrogen production systems state of art, from the point of view of carbon emissions produced by the various technologies on the market and on a laboratory scale.

**Material and methods:** A collection of five papers, which brings together about 40 examples of hydrogen production technologies, was used as the basis for this work. The common thread that binds almost all the articles is the use of harmonized emission data obtained by applying the Harmonization Protocol proposed by Valente et al.[1] The measuring gauge of the analysis will be the use of a single environmental impact indicator, the Global Warming Potential (GWP).

**Results:** Since the data collected are very heterogeneous, they were first divided into two main categories concerning the technological category to which the hydrogen production processes in question belongs – Thermochemical and Electrochemical Processes – and then, each one, into other two categories to separate processes which use renewable energy sources from those which use non-renewable energy sources. The following table reports the original and harmonized GWP values retrieved from the five articles mentioned before:

		GWP [kgCO <sub>2</sub> -eq/kgH <sub>2</sub> ]	Harmonized GWP [kgCO <sub>2</sub> -eq/kgH <sub>2</sub> ]	ice
Nonrenewable Thermochemical Processes	Steam Methane Reforming with Carbon capture and storage	3,32	-	[2]
	Steam Methane Reforming with CO <sub>2</sub> capture and storage	3,9	4,7	[3]
	Steam Methane Reforming	9,89	-	[2]
	Steam Methane Reforming (Spain)	10,6	11,4	[3]
	Coal Gasification with CO <sub>2</sub> capture and storage (German coal mix)	7,00	7,70	[3]
	Coal Gasification (German coal mix; sulphur co-product)	23,10	24,40	[3]
	Coal Gasification (China Coal mix)	26,40	24,40	[3]
	Coal Gasification (German coal mix)	27,00	27,50	[3]
Renewable Electrochemical Processes	via Plasma using RE and Fossil NG	0,91	-	[2]
	via Plasma using RE and Renewable NG	-5,22	-	[2]



# European Fuel Cells and Hydrogen

PIERO LUNGI CONFERENCE

September 13th-15th 2023  
Capri / Italy

	Fermentation	-	5,78	[4]
	Biogas Steam Reforming	-	7,11	[4]
	Wood Gasification	-	8,55	[4]
	Bio-int. Steam Reforming	-	10,72	[4]
	Microbial Electrolysis Cells	-	13,49	[4]
Nonrenewable Electrochemical Processes	SOEC-Italian Grid Electricity	25,64	-	[5]
	Electrolysis (European mix 2014)	27,60	28,30	[3]
	Grid electrolysis (European mix 2010)	28,7	29,6	[3]
	SOEC-NG Electricity	28,93	-	[2]
	Electrolysis (German electricity mix)	32,00	29,90	[3]
	Grid electrolysis (European mix 2005)	34,00	34,50	[3]
	Electrolysis (Natural Gas Electricity)	43,00	43,80	[3]
	SOEC-Coal Electricity	43,95	-	[2]
	Grid electrolysis (China Electricity mix 2005)	53,00	51,80	[3]
	Grid electrolysis (Australian Electricity mix 2005)	67,00	68,50	[3]
	Electrolysis (Coal Electricity)	70,00	71,80	[3]
Renewable Electrochemical Processes	Wind-Electrolysis	0,0325	-	[2]
	PV-Alkaline Electrolysis [Suleman et al. (2015)] (Canada)	0,37	0,65	[6]
	PV-Electrolysis	0,37	-	[3]
	SOEC-Hydro Electricity	0,72	-	[2]
	SOEC-Nuclear Electricity	2,11	-	[2]
	PV-PEM Electrolysis [Granovskii et al. (2007)] (US)	2,15	2,16	[6]
	SOEC-Wind Electricity	2,26	-	[2]
	PV-PEM Electrolysis [Lundeberg et al. (2019)] (Sweden)	2,31	3,80	[6]
	PV-Alkaline Electrolysis [Ozbilen et al. (2011)] (Canada)	2,41	2,63	[6]
	PV-PEM Electrolysis [Cetinkaya et al. (2012)] (Canada)	2,50	2,58	[6]
	PV-Alkaline Electrolysis [Lundeberg et al. (2019)] (Sweden)	2,60	4,09	[6]
	PV-PEM Electrolysis [Reiter and Lindorfer (2015)] (EU)	3,05	3,13	[6]
	PV-PEM Electrolysis [Schmidt Rivera et al. (2019)] (EU)	3,05	3,15	[6]
	PV-PEM Electrolysis [Granovskii et al. (2007)] (US)	3,67	3,72	[6]
	PV-Alkaline Electrolysis [Simons et al. (2011)] (Spain)	4,30	4,40	[6]
	SOEC-Solar Electricity	4,63	-	[2]
	PV-Alkaline Electrolysis [Koroneos et al. (2004)] (Germany)	5,71	4,69	[6]
	PV-PEM Electrolysis [Pereira and Coelho (2013)] (Germany/Portugal)	6,20	5,80	[6]
PV-Alkaline Electrolysis [Lombardi et al. (2011)] (Italy)	6,40	6,64	[6]	
SOEC-Biomass Electricity	14,36	-	[2]	

**Conclusions:** Considering GWP, looking at market-ready technologies, electrolysis coupled with renewable energies is the undisputed winner of this analysis ( $0,0325 \div 6,20 \text{ kg}_{\text{CO}_2}/\text{kg}_{\text{H}_2}$ ).

## References

- [1] A. Valente, D. Iribarren, and J. Dufour, "Harmonised life-cycle global warming impact of renewable hydrogen," *J Clean Prod*, vol. 149, pp. 762–772, Apr. 2017, doi: 10.1016/j.jclepro.2017.02.163.
- [2] J. Diab, L. Fulcheri, V. Hessel, V. Rohani, and M. Frenklach, "Why turquoise hydrogen will be a game changer for the energy transition," *Int J Hydrogen Energy*, vol. 47, no. 61, pp. 25831–25848, Jul. 2022, doi: 10.1016/j.ijhydene.2022.05.299.
- [3] A. Valente, D. Iribarren, and J. Dufour, "Harmonised carbon and energy footprints of fossil hydrogen," *Int J Hydrogen Energy*, vol. 46, no. 33, pp. 17587–17594, May 2021, doi: 10.1016/j.ijhydene.2020.03.074.
- [4] M. Buffi, M. Prussi, and N. Scarlat, "Energy and environmental assessment of hydrogen from biomass sources: Challenges and perspectives," *Biomass Bioenergy*, vol. 165, Oct. 2022, doi: 10.1016/j.biombioe.2022.106556.
- [5] A. Mehmeti, A. Angelis-Dimakis, C. B. Muñoz, M. Graziadio, and S. J. McPhail, "Eco-thermodynamics of hydrogen production by high-temperature electrolysis using solid oxide cells," *J Clean Prod*, vol. 199, pp. 723–736, Oct. 2018, doi: 10.1016/j.jclepro.2018.07.166.
- [6] O. Kanz, K. Bittkau, K. Ding, U. Rau, and A. Reinders, "Review and Harmonization of the Life-Cycle Global Warming Impact of PV-Powered Hydrogen Production by Electrolysis," *Frontiers in Electronics*, vol. 2, 2021, [Online]. Available: <https://www.frontiersin.org/articles/10.3389/felec.2021.711103>



## Hydrogen in a future energy system – Business models and application in the transport sector

Herman Hansson\*, Mirjam Särnbratt\*\*, Nathalie Fransson\*\*, Kerstin Sernhed\*, Kristina Lygnerud\*., Martin Andersson \*

\* Lund University

\*\* IVL – Swedish Environmental Institute

### Abstract

For a hydrogen based energy system to take-off, there is a need to understand hydrogen business models, and to specifically understand efficient production and distribution to the transport sector. Previous studies have focused on specific parts of business models, such as revenue streams, price models or profitability, but have failed to take a holistic approach to business models that also includes analyses of value proposition, customer segments, relationships, and channels as well as partnerships, resources and activities required to achieve the value proposition. This study adopts a holistic view of business models and conducts an analysis of the future boundary conditions, i.e. conditions in 2045 that will affect the business of hydrogen actors. Based on two studies, several possible boundary conditions were collected.

Our first study combined a literature review with an interview study to compile the current state of knowledge on business models for hydrogen in the transport sector. The literature review was initiated by recent reports and articles covering the different ways of value creation that can be associated with hydrogen production and consumption – most importantly hydrogen manufacturing, power grid flexibility, and waste heat. Progressively, a structured literature search approach was taken, utilizing different scientific databases and different combinations of the search words “hydrogen”, “business model(s)”, “transport”, and “filling station(s)”. The interview study investigated, in a semi-structured way, how different actors in the sector (including producers, distributors, and tank station owners of hydrogen) as well as customers (haulage and public transport companies), described their business model of today.

Our second study aimed to broaden the horizon and assess the business models beyond the near future, more specifically the year 2045. Potential boundary conditions were collected via investigating different governing and strategic documents from a national, EU-wide, and global perspective, as well as technological and techno-economical assessments. These boundary conditions of the future covered regulatory, technological, and behavioural aspects of the business landscape of hydrogen in the transport sector. When a list of possible boundary conditions had been collected, a workshop was held, investigating which



of the potential boundary conditions, collected in the study, that could be validated by actors in the value chain of hydrogen-driven transport.

The resulting boundary conditions enabled a discussion of a few qualitative future scenarios of 2045. These scenarios could be compared to the current state of hydrogen business models, thus identifying potential gaps and a direction to how hydrogen actors of today can develop their business. The discussion was conducted from a Swedish perspective since the validating interviews and workshop was made together with Swedish actors. However, the report also included an international outlook, and while the conclusions are specifically validated among Swedish actors, similarities to other countries can potentially be seen.

## Levelized cost of hydrogen with different water electrolysis technologies: a comparison review

F. Romano<sup>\*a</sup>, M. Minutillo<sup>b d</sup>, V. Cigolotti<sup>c d</sup>, A. Pianese<sup>d</sup>

\* Corresponding author: fabiana.romano001@studenti.uniparthenope.it

<sup>a</sup> Department of Engineering, University of Naples Parthenope, Naples, Italy

<sup>b</sup> Department of Industrial Engineering, University of Salerno, Fisciano, Italy

<sup>c</sup> ENEA - Italian National Agency for New Technologies, Energy and Sustainable Economic Development, Naples, Italy

<sup>d</sup> ATENA Future Technology, Naples, Italy

*Keywords: Water electrolysis technologies, hydrogen production, LCOH.*

**Abstract:** To support the exploitation of the hydrogen production from water by using the electrolysis process, in this paper an economic analysis, based on the evaluation of the levelized cost of hydrogen (LCOH), is carried out by considering the 2023-2050 scenarios.

**Introduction:** Electrolysis technology is considered an excellent solution to make possible hydrogen production. The Alkaline (AWE), the Proton Exchange Membrane (PEMWE) and the Solid Oxide (SOEC) electrolyzers are the most studied as the current and future technologies for the green hydrogen production from renewable sources.

**Objectives:** This study aims to calculate the LCOH to identify the average price at which hydrogen must be sold to break even financially.

**Material and methods:** The cost analysis is based on the evaluation of the CAPEX, O&M and replacement costs of AWE, PEMWE and SOEC. Table 1 summarizes the technical data as well as the cost parameters of these electrolyzers as available from IRENA report [1].

*Table 1. Technical and economic parameters of electrolyzers in the 2020-2050 scenarios.*

Parameters	AWE		PEMWE		SOEC	
	2020	2050	2020	2050	2020	2050
Stack unit size (MW)	1	10	1	10	0.005*	0.2
Average Stack efficiency (kWh/kg H <sub>2</sub> )	56.5	42	56.5	42	42.5	35
Average System efficiency (kWh/kg H <sub>2</sub> )	64.0	45	66.5	45	45.0	40
Average H <sub>2</sub> production (kg/h)	17.7	23.8	17.7	23.8	23.5	28.6
Average O <sub>2</sub> production (kg/h)	142.0	190.0	142.0	190.0	188.0	229.0
Average H <sub>2</sub> O utilization (kg/h)	177.0	238.1	177.0	238.1	235.3	285.7
Average Stack CAPEX (min. 1 MW, €/kW)	248.4	92.0	368.0	92.0	1,840.0	184.0
Average System CAPEX (min. 10 MW, €/kW)	441.6	92.0	598.0	92.0	920.0**	92.0

\* This size is not significant on industrial scale, but currently only these data are available.

\*\* This is an assumption of the authors according to other costs on SOEC systems available the literature.

For a more detailed CAPEX assessment, the factorial method [2] and the conversion factor inherent in the Chemical Engineering Plant Cost Indices (CEPCI) [3] are adopted.

$$CAPEX = C \cdot \sum \text{factored costs} \quad (1)$$

$$CAPEX_{2022} = CAPEX_{2020} \cdot CEPCI_{2022}/CEPCI_{2020} \quad (2)$$

The total costs and revenues calculated of each electrolysis system are shown in Table 2.

Table 2. Total costs and revenues of the electrolyzers.

Parameters	AWE		PEMWE		SOEC	
	2023	2050	2023	2050	2023	2050
Capital costs (k€/y) – CAPEX	4,715.4	1,082.3	6,464.0	1,082.3	13,106.0	1,310.6
O&M costs* (k€/y) – C <sub>O&amp;M</sub>	1,172.2	701.7	1,288.9	701.7	1,507.5	755.9
Replacement costs** (k€/y) – C <sub>rep</sub>	118.6	43.9	175.6	43.9	878.2	87.8
Revenues*** (k€/y) – R <sub>O<sub>2</sub></sub>	103.1	138.6	103.1	138.6	137.0	166.4

\*Maintenance costs 3%·CAPEX [4], Service and Operating costs 2%·CAPEX and 1%·CAPEX, respectively [5]. H<sub>2</sub>O consumption costs 0.009 €/kg [5]. Average cost of electricity in Europe 100 €/MWh (2023) [6], 70 €/MWh (2050) [7]. \*\*Replacement costs 35%·CAPEX [4]. \*\*\*Oxygen price 0.13 €/m<sup>3</sup> [8].

The LCOH is calculated by considering the system's lifetime to be 20 years (N) and by applying the following equation [9]:

$$LCOH = \frac{(CAPEX + \sum_{n=1}^N C_{O\&M,n,actualized} + C_{rep,n=t,actualized} - \sum_{n=1}^N R_{O_2,n,actualized}) \cdot CRF}{m_{H_2,annual}} \quad (3)$$

The CRF is the capital recovery factor, i.e. the index used to calculate the present value of an annuity. It is calculated considering the real interest rate *Ir* (based on a nominal discount rate of 3% and an inflation rate of 2% [9]) and the duration of the system.

**Results:** The calculated LCOH is 9.55 €/kg, 11.10 €/kg and 13.06 €/kg for the 2023 scenario and 3.31€/kg, 3.31 €/kg and 2.96 €/kg for the 2050 scenario for the AWE, PEMWE and SOEC electrolyzer, respectively.

**Conclusions:** At 2050 the SOEC technology will become the most competitive and the LCOH will be under 3 €/kg.

**Acknowledgment** This Joint Undertaking receives support from the European Union's Horizon 2020 Research and Innovation Program, Hydrogen Europe and Hydrogen Europe Research.

## References

- [1] I. Renewable Energy Agency, *Making the breakthrough: Green hydrogen policies and technology costs*. 2021. Available: [www.irena.org](http://www.irena.org)
- [2] "Factorial Techniques applied in Chemical Plant Cost Estimation: A Comparative Study based on Literature and Cases."
- [3] "Chemical Engineering Plant Cost Index.  
[https://personalpages.manchester.ac.uk/staff/tom.rodgers/Interactive\\_graphs/CEPCI.html?reactors/CEPCI/index.html](https://personalpages.manchester.ac.uk/staff/tom.rodgers/Interactive_graphs/CEPCI.html?reactors/CEPCI/index.html)."
- [4] R. Hancke et al. *Energy Convers Manag*, doi: 10.1016/j.enconman.2022.115642.
- [5] D. Jang et al. *Energy Convers Manag*, doi: 10.1016/j.enconman.2022.115499.
- [6] "Electricity prices in Europe fell significantly in January 2023. <https://gmk.center/en/posts/electricity-prices-in-europe-fell-significantly-in-january-2023/>."
- [7] "EU Energy Outlook to 2060. <https://energypost.eu/eu-energy-outlook-to-2060-how-will-power-prices-and-revenues-develop-for-wind-solar-gas-hydrogen-more/>."
- [8] Y. Zhou et al. [www.theicct.org](http://www.theicct.org)communications@theicct.org
- [9] A. Perna et al. *Energy Convers Manag* doi: 10.1016/j.enconman.2023.116702.





## TOPIC 2: HYDROGEN STORAGE AND HANDLING

## Innovative Nanostructured Oxygen Electrodes for Solid Oxide Cells

E. Djurado\*<sup>a</sup>, Ö. Çelikbilek<sup>a</sup>, R. Sharma<sup>a</sup>, L. Yefsah<sup>a,b</sup>, J. Laurencin<sup>b</sup>

\* corresponding author: Elisabeth.Djurado@grenoble-inp.fr

<sup>a</sup> Univ. Grenoble Alpes, Univ. Savoie Mont Blanc, CNRS, Grenoble INP, LEPMI, 38000 Grenoble, France

<sup>b</sup> Univ. Grenoble Alpes, CEA, LITEN, DTCH, 17 rue des Martyrs, 38054 Grenoble, France

*Keywords: Solid oxide cells, Microstructure, Electrostatic spray deposition, oxygen electrode.*

### Abstract

Solid oxide cells (SOCs), operating from 750 to 850°C, are efficient electrochemical systems for electricity generation (fuel cell mode, SOFC) and hydrogen production (electrolysis mode, SOEC). One solution to increase the lifetime consists of decreasing the operating temperature to 650-750 °C. However, in this case, one of the main challenges is to improve the oxygen electrode efficiency by enhancing the oxygen reduction/evolution reaction. To tackle this issue, it is important to choose suitable materials with adequate physical-chemical properties and to optimize the microstructure and architecture to further increase the electrochemical performances.

**Introduction:** In the context of lowering the operating temperature of SOC to 650-750 °C to improve the SOC durability, the electrode reaction kinetics become relatively insufficient. Thus, there is great potential to master the microstructure, architecture, interfaces, and composition of oxygen electrodes in SOC to increase the electrodes' performance and reduce cell overpotentials.

**Objectives:** This work aims to design novel optimized oxygen electrodes with improved mixed ionic-electronic properties to be used as more efficient oxygen electrodes in SOC. Indeed, it is of high importance to control the electrode microstructure and composition to obtain large surface areas. These properties are essential to increase the number of active sites for the oxygen reduction/evolution reaction (ORR/OER) and to enhance the ionic transfer at the electrode/electrolyte interface.

**Material and methods:** The design of three different oxygen electrodes such as  $(La_{0.7}Sr_{0.3})_{0.95}(Co_{0.2}Fe_{0.8})O_{3-\delta}$ ,  $La_{2-x}Pr_xNiO_{4+\delta}$ , and  $Pr_6O_{11}$  is reported using the typical screen-printing (SP) process, and the innovative electrostatic spray deposition (ESD) technique. ESD



stands out as a promising low-cost and parameter-controlled method to fabricate microstructural features at the nanometer length scale. It allows producing thin films with original morphologies by a nano-texturing approach. Indeed, the grain size, porosity, surface area, architecture, and the film thickness can be tailored to obtain desired electrode microstructures and architectures. Structural (XRD and TEM), microstructural (SEM), compositional (STEM) coupled with EDX, and electrochemical characterizations (EIS), were employed to study the correlation between microstructure, composition, architecture, interfaces, and electrochemical properties for the investigated oxygen electrodes.

**Results:** Here, we report recent advances in the design of  $\text{La}_{0.6}\text{Sr}_{0.4}\text{Co}_{0.2}\text{Fe}_{0.8}\text{O}_{3-\delta}$  (LSCF) [1],  $\text{La}_{2-x}\text{Pr}_x\text{NiO}_{4+\delta}$  (LPNO) [2] with  $0 \leq x \leq 2$ , and  $\text{Pr}_6\text{O}_{11}$  [3] oxygen electrodes with grain size and porosity at the nanometre length scales. These active functional layers are fabricated using ESD. This talk will show our latest electrochemical performance results of these innovative oxygen electrodes investigating the role of the nanostructure and the electrode/electrolyte interface. The correlation between microstructure, composition, grain size, interfaces, and electrochemical properties is discussed in detail for the different investigated oxygen electrodes. To conclude, the suitability of these materials with innovative and controlled microstructure as durable air electrodes for SOECs has been proven to be promising.

**Conclusions:** Our investigations suggest that the ESD process is a suitable low-cost method to manufacture unique optimized porous and nanostructured oxygen electrodes with reproducibility. Three MIEC oxygen electrodes, A-site deficient  $(\text{La}_{0.7}\text{Sr}_{0.3})_{0.95}\text{Co}_{0.2}\text{Fe}_{0.8}\text{O}_{3-\delta}$  perovskite, the  $\text{La}_{2-x}\text{Pr}_x\text{NiO}_{4+\delta}$  (with  $x = 0, 0.5, 1$  and  $2$ ) solid solution, and  $\text{Pr}_6\text{O}_{11}$ , a decomposition product of the  $\text{LaPrNiO}_{4+\delta}$  nickelate, have shown one of the lowest values of polarization resistances in the literature and excellent performances in single-cell tests.

### Acknowledgment

This work was funded by the French Project Mimosa from “Institut Carnot Energies du Futur”.

### References

- [1] O. Celikbilek, et al., *J. Mater. Chem. A*, 7, 25102, (2019).
- [2] N.I. Khamidy, et al., *Journal of Electroanalytical Chemistry*, 849, 113373, (2019).
- [3] R.K. Sharma, et al., *Journal of Power Sources*, 419, 171-180, (2019).

## CVD Grown Graphene for Anticorrosive Layers in Hydrogen Transport and Distribution Pipelines

Brigida Alfano, Maria Lucia Miglietta \*, Ettore Massera, Anna De Girolamo and Tiziana Polichetti\*

\* corresponding author: mara.miglietta@enea.it; tiziana.polichetti@enea.it

Agenzia nazionale per le nuove tecnologie, l'energia e lo sviluppo economico sostenibile (ENEA), P.le E. Fermi 1, Portici, I-80055 Naples, Italy

*Keywords: CVD graphene, graphene coating, hydrogen embrittlement.*

### Abstract

#### Introduction

*Hydrogen has emerged as a clean and sustainable energy carrier with numerous applications, including fuel cells and energy storage [1-2]. However, H<sub>2</sub> poses unique challenges due to its ability to permeate through metal pipelines, causing embrittlement and corrosion [3] thus leading to pipeline failures and increasing maintenance costs. To mitigate these problems, the development of effective anticorrosive coatings is crucial. Graphene, with its exceptional mechanical, electrical and barrier properties, has shown great potential as a corrosion-resistant material [4-6]. Chemical vapour deposition (CVD) techniques offer a scalable and controllable method for synthesizing high-quality graphene films [7].*

#### Objectives:

*The aim of this research is to contribute to the advancement in the understanding of graphene coatings as anti-hydrogen penetration layers in carbon steel. Here we present a part of the preliminary results of the first year of the research line framed within the Operational Research Plan on H<sub>2</sub>, dedicated precisely to this issue.*

#### Materials and Methods:

*CVD graphene synthesis was realized directly onto steel substrates (grade 304) by using a H<sub>2</sub>/CH<sub>4</sub> mixtures at a constant temperature of 950°C at a pressure of 0.5 Torr, followed by a cooling phase in Ar/H<sub>2</sub> atmosphere for 30 minutes at a pressure of 10 Torr. Two different samples were produced by changing the growth phase duration, 8 and 30 min, respectively.*

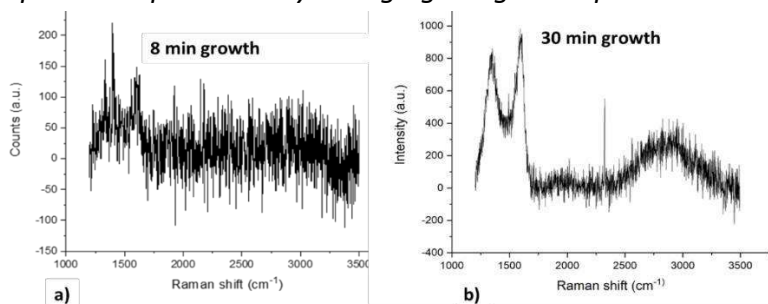

*Figure 1. Raman spectra of graphene grown on stainless steel with 8 minutes of methane exposure (a) and 30 minutes methane exposure (b).*

The samples were successively characterized by Raman spectroscopy and scanning electron microscopy. Figure 1 displays a comparison of the spectra: the sample grown for 30 minutes exhibits a more defined spectrum than that of the 8 minutes, revealing that the growth time plays a crucial role in the growth process. It should be noted that the shape and the position of the peaks are attributable to graphene oxide rather than pure graphene, probably due to the presence of oxygen in the substrate composition. We also verified that increasing the quantity of material did not lead to an improvement in its quality: indeed, SEM investigations (Figure 2) suggest the presence of a large quantity of carbonaceous material, which appears in the form of amorphous agglomerates.

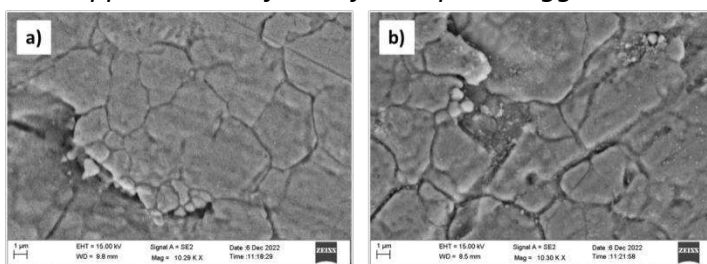

Figure 2. SEM images (a) before and (b) after 30 min growth on the SS substrate.

**Conclusions:** We have demonstrated the possibility of direct growth of graphene on steel, however the process needs to be further optimized in order to obtain a continuous graphene film, free from impurities and carbonaceous agglomerates.

### Acknowledgment

This research was funded by the Italian Ministry of Ecologic Transition (MiTE) through Operational Research Plan (POR), in the framework of Next Generation EU, Project title “Research and development of technologies for the H<sub>2</sub> supply chain”.

### References

- [1] «<https://am.pictet.it/blog/articoli/mercati-e-investimenti/transizione-ecologica-recovery-plan-e-idrogeno>,» [Online].
- [2] «<https://www.mase.gov.it/comunicati/pnrr-mite-450-milioni-sviluppare-la-filiera-dell-idrogeno-verde>,» [Online].
- [3] R. Gangloff e B. Somerday, “Gaseous hydrogen embrittlement of materials in energy technologies”, Volume 1 (2012) Woodhead Publishing Limited, Cambridge (UK).
- [4] J.S. Bunch, S.S. Verbridge, J.S. Alden, A.M. Van Der Zande, J.M. Parpia, H.G. Craighead, and P.L. McEuen, “Impermeable atomic membranes from graphene sheets”, *Nano letters*, 8(8), (2008), pp.2458-2462.
- [5] K. Shi, S. Xiao, Q. Ruan, H. Wu, G. Chen, C. Zhou, S. Jiang, K. Xi, M. He and P.K. Chu, “Hydrogen permeation behavior and mechanism of multi-layered graphene coatings and mitigation of hydrogen embrittlement of pipe steel”, *Applied Surface Science*, 573, (2022), pp.151529-151540.
- [6] T.H. Nam, J.H. Lee, S.R. Choi, J.B. Yoo, and J.G. Kim, “Graphene coating as a protective barrier against hydrogen embrittlement”, *International journal of hydrogen energy*, 39(22), (2014), pp.11810-11817.
- [7] Bahri, M., Gebre, S.H., Elaguech, M.A., Dajan, F.T., Sendeku, M.G., Tlili, C. and Wang, D., 2023. Recent advances in chemical vapour deposition techniques for graphene-based nanoarchitectures: From synthesis to contemporary applications. *Coordination Chemistry*



## Experimental Thermal Conditioning of Metal Hydrides Canisters for Hydrogen Storage

R. Adinolfi Borea<sup>a</sup>, M. A. Ancona<sup>\*b</sup>, A. De Pascale<sup>b</sup>, F. Ferrari<sup>b</sup>, S. Ottaviano<sup>b</sup>, A. Peretto<sup>b</sup>, P. Pilati<sup>a</sup>

\* corresponding author: [maria.ancona2@unibo.it](mailto:maria.ancona2@unibo.it)

<sup>a</sup> Università degli Studi di Salerno - Dipartimento di Ingegneria dell'Informazione ed Elettrica e Matematica applicata (DIEM), Via Giovanni Paolo II, 132 - 84084 Fisciano (SA)

<sup>b</sup> Alma Mater Studiorum - Università di Bologna, Department of Industrial Engineering (DIN), Viale del Risorgimento 2, 40136 Bologna, Italy

*Keywords: Hydrogen – Metal Hydrides – Experimental set-up – Thermal management system*

### Abstract

#### Introduction:

Hydrogen as an energy carrier could be a new additional strategy to decarbonise the energy sector [1]. It can be produced by electrolysis starting from the surplus power of renewable sources and then be stored and reconverted into electricity by means of fuel cells, without pollutant emissions, when needed. Hydrogen storage is one of the major issues to its diffusion on a large scale [2]; among the different methods, storing hydrogen in the form of metal hydrides is certainly a promising technology [3]. However, this process is not mature yet and further studies are needed to make this storage system competitive. In particular, due to thermal behaviour of metal hydrides during the absorption/desorption phases, the heat management of the storage system need to be improved, in order to enhance the reaction kinetics in the metal sites [3].

#### Objectives:

This work aims to propose an experimental test bench, built to characterize and optimize the thermal conditioning and management of low-pressure metal hydrides (MH) canisters for hydrogen storage, fed by a green hydrogen production line. More in detail, the final objective of the study is to propose an experimental approach to assess the energy performance of the MH storage system, for stationary applications and without any hydrogen compression stage.

#### Material and methods:

The current layout of the experimental set-up is shown in Fig.1 and is composed by a PEM electrolyzer, able to produce 30 Sl/h of H<sub>2</sub> at 11 bar, with a maximum power consumption of 300 W (AC), a hydrogen storage system, represented by three metal hydride canisters of 200 Sl each, that can store H<sub>2</sub> at a maximum pressure of 10 bar, and finally by a self-built thermal conditioning system, represented by a closed water cooling circuit. The test bench monitoring system has been realized in LabVIEW™ environment and is based on National Instruments™ instrumentation, while to provide the optimized control of the thermal conditioning system it was chosen to run a numerical model in a Simulink™ Real-Time target machine with the main physical quantities acquired as input parameters.

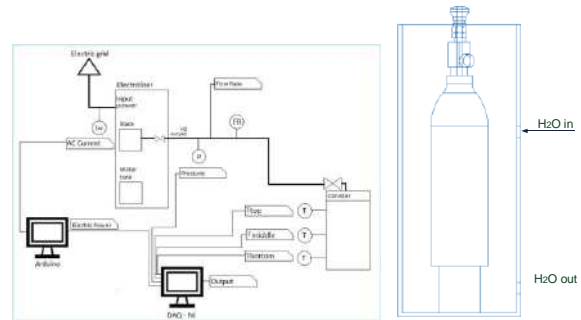

**Figure 1:** Experimental set-up and current layout of the system

## Results:

The preliminary experimental investigations on the proposed system allowed to map over time the surface thermal profile of the cylinders for different temperature values of the cooling water (Fig. 2), storage pressure and hydrogen filling/emptying flow rate. These measurements represent the starting point to monitor the energy performance and round-trip efficiency of the hydrogen production and storage chain by means of MH technology.

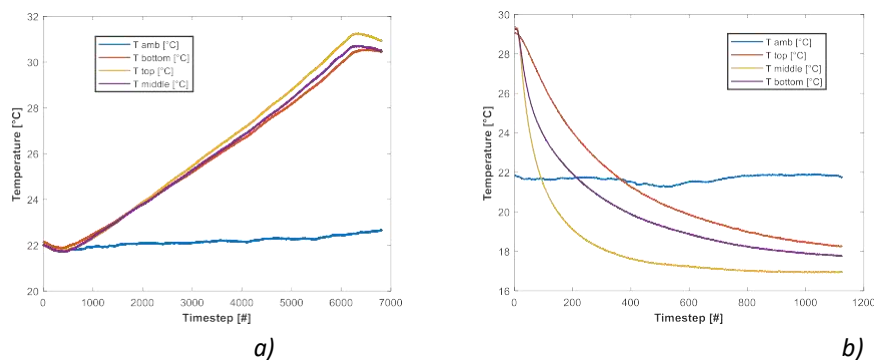

**Figure 2:** Preliminary results: surface temperature behavior at the top, middle and bottom of the canister during the *a)* absorption and *b)* desorption phases with a cooling water set-point temperature of 22°C

## Conclusions:

This paper aims to present an experimental test bench for the characterization of green hydrogen storage systems by means of metal hydride (MH) canisters. This approach will allow to evaluate the energy performance of the system and the hydrogen storage efficiency as a function of its thermal behaviour during the phases of absorption and desorption with the aim of optimizing thermal management.

## References

- C.J. Quarton, S. Samsatli. "The value of hydrogen and carbon capture, storage, and utilisation in decarbonising energy: Insights from integrated value chain optimisation". (2020). *Applied Energy*, 257, art. 113936.
- M. Sankir, N. D. Sankir. "Hydrogen Storage Technologies", John Wiley & Sons, 2018.
- P. Adametz, K. Müller, W. Arlt. "Energetic evaluation of hydrogen storage in metal hydrides". *INTERNATIONAL JOURNAL OF ENERGY RESEARCH Int. J. Energy Res.* 2016; 40:1820–1831.



## A Numerical Investigation of Underground Hydrogen Storage

Farhad Farajimoghadam<sup>\*a</sup>, Alessandro Vaccari<sup>a</sup>, Diego Viesi<sup>a</sup>, Luigi Crema<sup>a</sup>

\* corresponding author: ffarajimoghadam@fbk.eu

<sup>a</sup> Center for Sustainable Energy, Fondazione Bruno Kessler, Via Sommarive, 18, 38123, Povo (TN), Italy

*Keywords: Hydrogen, Storage, Simulation, Underground*

### **Abstract**

#### **Introduction:**

Underground Hydrogen Storage (UHS) simulations have emerged as a critical tool in understanding and optimizing the large-scale seasonal storage of hydrogen for various applications. As a clean and sustainable energy carrier, hydrogen plays a pivotal role in replacing fossil fuels and reducing greenhouse gas emissions. However, the challenge lies in effectively and securely storing large quantities of hydrogen for long durations, in complex geological settings, which necessitates advanced simulation techniques.

Advancements in computational modeling and simulation have enabled researchers to investigate UHS systems in a comprehensive and cost-effective manner. By simulating different storage scenarios and analyzing various parameters, such as geological formations, types of storage reservoirs, and operating conditions, scientists can evaluate the suitability and performance of UHS options.

These simulations provide valuable insights into the behavior and dynamics of hydrogen within porous rock formations, salt caverns, or depleted hydrocarbon reservoirs. By mapping the movement of hydrogen and predicting its behavior under varying pressure, temperature, and composition conditions, researchers can identify potential risks, optimize storage efficiency, and ensure the safe and reliable operation of UHS systems [1,2].

Moreover, UHS simulations offer a platform to study potential challenges and develop strategies to mitigate them. This includes investigating issues related to hydrogen leakage, migration, or interaction with surrounding materials (geochemical and microbial reactions, geomechanical phenomena), as well as optimizing injection and withdrawal strategies to ensure seamless transportation and utilization. Additionally, simulations enable researchers to assess the overall environmental impact and potential risks associated with UHS, facilitating the development of robust regulatory frameworks and safety guidelines [3].

#### **Objectives:**

The objective is to develop a straightforward benchmark model that can be applied to various real field-scale reservoir case studies. This approach requires adjusting the characteristics and parameters of new reservoirs to fit the specific conditions.

#### **Material and methods:**



The simulation involved the utilization of various models and modules within the COMSOL Multiphysics software. Due to the complexity of simulating hydrogen behavior in underground storage, the coupling of phase transport in porous media, Darcy's law, and transport of concentrated species in porous media was necessary.

For the reservoir and wellbore, a simple geometry was adopted. It consisted of a cylindrical shape with a specified radius, with a central line representing the wellbore.

The simulation accounted for two phases: gas and liquid. The gas phase comprised different gases within the porous medium, characterized by given porosity and permeability. Starting from initial values, a transient simulation spanning several days was performed.

### Results:

A preliminary result of gas volume fraction and pressure of the gas in the reservoir is shown in the contours below. The time span for the simulation is 100 days.

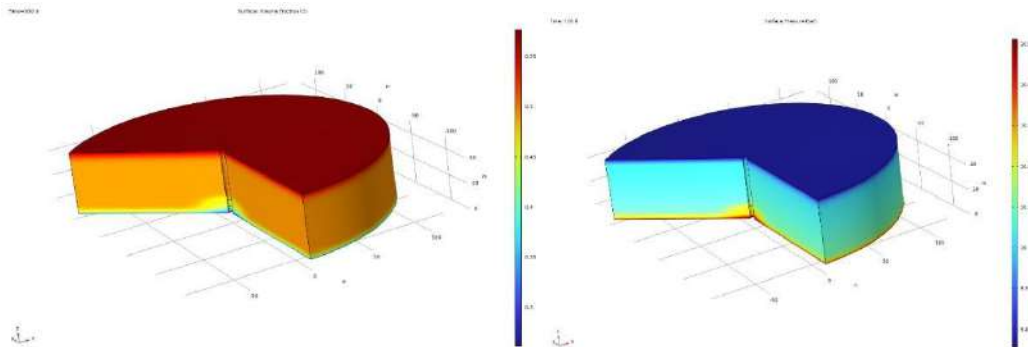

Figure 6 Contours of reservoir after injection of hydrogen for 100 days. A) gas volume fraction(left) B) Gas pressure (right)

### Conclusions:

More detailed results and conclusion will be available in the full paper.

### Acknowledgment:

This work has been done as a part of HyUSPRE project which is co-funded by European Union, through the Fuel Cells and Hydrogen 2 Joint Undertaking under grant agreement No 101006632. This Joint Undertaking receives support from the European Union's Horizon 2020 research and innovation programme, Hydrogen Europe and Hydrogen Europe Research. The authors acknowledge the support of the involved institutions.

### References:

- [1] Hogeweg, S., Strobel, G. & Hagemann, B. Benchmark study for the simulation of Underground Hydrogen Storage operations. *Comput Geosci* 26, 1367–1378 (2022).
- [2] Yousefi, H., 2021. Design considerations for developing an underground hydrogen storage facility in porous reservoirs
- [3] Ghasemi, M., Omrani, S., Mahmoodpour, S., & Zhou, T. (2022). Molecular dynamics simulation of hydrogen diffusion in water-saturated clay minerals; implications for Underground Hydrogen Storage (UHS). *International Journal of Hydrogen Energy*, 47(59), 24871-24885.

## Thermal management strategies for a high-capacity H<sub>2</sub> stationary storage system with metal hydride tanks

Gabriele Scarpati\*<sup>a</sup>, Giovanni Di Ilio<sup>a</sup>, Elio Jannelli<sup>a</sup>

\* corresponding author: gabriele.scarpati001@studenti.uniparthenope.it

<sup>a</sup> University of Naples "Parthenope"

*Keywords: Design of thermal management systems, Hydrogen storage for stationary applications, Numerical modelling of absorption/desorption processes, Metal hydrides*

**Objectives:** In this study, several layout configurations and thermal management strategies are analysed, to compare their effects on the absorption and desorption processes of a metal hydride tank for hydrogen storage in stationary applications. The storage system is designed with a modular approach, where each module consists of a cylindrical element, to provide a hydrogen capacity of 250 kg at low nominal pressure (~ 30 bar), such that the system can be placed inside a 20 feet container, thus making it transportable and scalable.

**Material and methods:** The analysis is carried out through 2D numerical modelling and simulation on COMSOL Multiphysics (v. 5.6). The material selected is the Hydralloy C5<sup>®</sup> [1]. First, the kinetic and equilibrium pressure models are validated with experimental data reported in the literature [2–4]. Afterwards, a parametric analysis is conducted to determine a suitable size for the single module. Finally, different thermal management strategies are considered, including internal/external natural/forced convection with air and water in single and multi-channels configurations, addition of expanded natural graphite (ENG) powder into the metal hydride, and conductive heat transfer by transversal aluminium rods. In Table 1 the list of the different implemented strategies is reported.

*Table 1 – List of the thermal management configurations.*

Case ID	H <sub>2</sub> inlet		Convection		External fluid		Internal fluid		Channels config.			Aluminium rods	ENG
	Base	Axial channel	Natural	Forced	Air	Water	Air	Water	None	Single	Multiple		
01		✓	✓		✓				✓				
02	✓		✓		✓				✓				
03		✓		✓		✓			✓				
04		✓		✓		✓			✓				✓
05	✓			✓		✓			✓				
06	✓			✓		✓		✓		✓			
07	✓			✓		✓			✓				✓
08	✓			✓		✓			✓			✓	
09		✓		✓		✓		✓			✓		✓
10	✓			✓	✓		✓			✓			✓

The reference test-cases consider 10 minutes of charging or discharging processes, by imposing an initial temperature of 303.15 K and a pressure of 30 or 1 bar, respectively. Hydrogen is assumed to be

carried from (hydrogenation) or out (dehydrogenation) the base of the cylinder or from an axial channel (in the latter case, the convection effect is taken into consideration).

**Results:** Average and maximum temperature, as well as pressure and concentration profiles over time are obtained for the different cases and compared. Figure 1 shows the temperature field at the end of the hydrogenation process and the average temperature profile, for a specific case, as an illustrative example. In general, the influence of the hydrogen inlet strategy is found to be negligible. On the other hand, the introduction of a small quantity (5 wt.%) of ENG is very effective in the reduction of the temperature peaks and the increase of the amount of absorbed or desorbed hydrogen. In terms of cost-benefit balance, the best configuration for the module is made by a cylinder with single axial channel, whose size is: 200 cm height, 44 cm external diameter and 20 cm internal diameter; both inside the channel and outside the external walls of the tank are exposed to the forced convection of air and 5 wt.% of ENG is added to the alloy. In this case, 20 modules are needed to meet the 250 kg hydrogen capacity of the storage system.

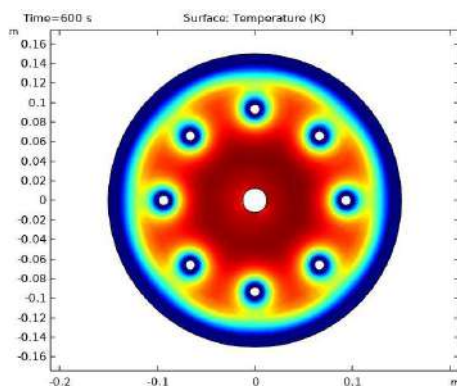

Figure 7 – Temperature plot for case 9 at  $t=600s$ .

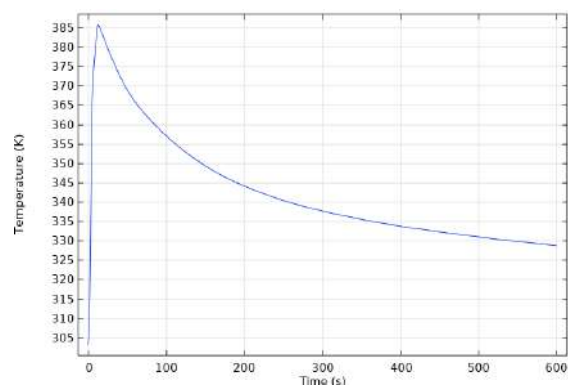

Figure 8 – Average temperature vs time for case 9.

**Conclusions:** According to the results, a key factor towards an effective thermal management strategy is the addition of a high conductive material to the alloy. Moreover, slender cylinders with a single channel allow to make the thermal management more effective. Finally, the simultaneous implementation of multiple strategies takes to very good results, especially in terms of maximum capacity, while the reduction of the average and maximum temperature peaks is less evident.

### Acknowledgment

Progetto POR Campania FESR 2014/2020, “MHyMOST” – Metal Hydrides-based hYdrogen storage for MOBILE and STationary applications

### References

- [1] G. Capurso, et al. Appl. Phys. A 122, 236 (2016), doi:10.1007/s00339-016-9771-x
- [2] M. Ron, J. Alloys Compd., 283, 178-191 (1999), doi:10.1016/S0925-8388(98)00859-7
- [3] V. M. Skripnyuk, M. Ron, J. Alloys Compd., 293–295, 385-390 (1999), doi:10.1016/S0925-8388(99)00375-8
- [4] K. Herbrig, et al., Int. J. Hydrog. Energy, 38, 7026-7036 (2013), doi:10.1016/j.ijhydene.2013.03.104



## An innovative infrared thermal imaging method for hydrogen leakage detection in PEM fuel cells

M. Totaro<sup>b</sup>, G. Risitano<sup>b</sup>, D. F. Santonocito<sup>b</sup>, O.Barbera<sup>a</sup>, G. Giacoppo<sup>\*a</sup>

\* corresponding author: [giacoppo@itae.cnr.it](mailto:giacoppo@itae.cnr.it)

<sup>a</sup> Consiglio Nazionale delle Ricerche – Istituto di Tecnologie Avanzate per l'energia "Nicola Giordano" CNR-ITAE– Via Salita S. Lucia sopra Contesse, 5 98126 Messina ME

<sup>b</sup> Università degli Studi di Messina-Dipartimento di Ingegneria – C.da di Dio 98158 S. Agata Messina, ME

### Abstract

**Introduction:** Fuel cells sealing systems and gaskets are prone to degradation due to their polymeric nature. The extreme environment in the fuel cells can cause the change of chemical and mechanical properties of the fuel cell gasket [1]. Sealing failure in a fuel cell can have detrimental effects not only on the efficiency but also can compromise the safety of the system operation. Due to the progressive diffusion of fuel cell technologies especially in the automotive industry, the application of hydrogen leakage diagnosis methods is essential for the safe operation of proton exchange membrane fuel cell systems. In the last years, special attention to the detection of hydrogen leakage was paid. Localizing the leakage is fundamental not only for diagnostic and safety purposes but also for maintenance and repairing aspects that are preliminary to the full stack disassembly. Previous studies showed that IR thermography (IR-T) has been used to reveal fuel cell MEA defects due to manufacturing or operating conditions [1],[2]. In [3] Bender et al. employed IR-T to highlight MEA degradation caused by accelerated stress tests (ASTs) through a specific device they developed. Ashgari et al. [4], adopted IR-T to detect internal crossover in a damaged fuel cell stack and find the leak locations. To the best of our knowledge, there has been a lack of scientific literature dealing with the use of IR-T to reveal external hydrogen leakage from a fuel cell.

**Objectives/novelty:** In this work, a novel approach using IR-T for detecting hydrogen leakage from a fuel cell with failed gasket was developed. The proposed method can provide information about the leak location in a fuel cell stack cell and correlate the measured temperature at the leak source with the hydrogen leak rate.

**Materials and Methods:** A Green Light G70 test station was used for operating the fuel cell and controlling the temperature and flow rate of hydrogen and nitrogen provided at the anode side. The single cell has an active area of 50 cm<sup>2</sup> with a parallel serpentine flow field and uses Teflon as a gasket material. As the performed tests are intended to investigate the leakage outside the cell, the MEA is used as a separator only. A thermal camera FLIR SC640 placed in front of the station was adopted for IR-T analysis. An active thermal tracer was placed above the cell, and it is used to reveal the gas leakage. The active tracer is made of carbon paper sprayed with catalyst ink on one side, with the same width as the test cell. To induce the external leakage at the anode side, the correspondent gasket was trimmed in the middle while the cathodic was left integer and assembled with the MEA. The assembled cell was then fed with a mixture of nitrogen and hydrogen at the anode (95%N<sub>2</sub> - 5%H<sub>2</sub>) and the temperature distribution on the thermal tracer surface, was measured by the IR camera.

**Results:** If the cell is operated with nitrogen at ambient temperature, the thermal tracer is unable to reveal gas leakage from the cell. Otherwise, if the cell is fed with the N<sub>2</sub>-H<sub>2</sub> mixture, the hydrogen reacts with the ambient air onto the activated surface of the tracer. The reaction produces heat that is captured by the thermal camera. The temperature contour develops vertically like a “plume”, in which the is maximum at the tracer base close to the leak source and decreases along the thermal tracer’s height where the hydrogen concentration is expected to lower. In the width direction of the tracer, the temperature starts from the ambient temperature and reaches the maximum where it is located the gasket defect, and then suddenly reduces to the ambient temperature again. Fig. 2 a) and b) show that there is a direct correlation between the hydrogen leak rate and the maximum temperature in the defect location. As the total flow rate is changed from 50 to 75 ml/min the maximum temperature increases accordingly from 65°C to 110°C indicating more heat is released by the chemical reaction. Fig. 2c shows the temperature profile along the length of a line placed on the edge between the thermal tracer and the cell. The temperature peak is greater with the highest leak flow rate, while the peak width does not change significantly with the leakage flow rate.

**Conclusions:** A new approach that uses Infra-Red Thermography has been developed for revealing external hydrogen leakage in a fuel cell with damaged gaskets. The developed method can provide the position of the hydrogen leak in a fuel cell and correlate the leak rate with the maximum temperature recorded. The easiness of application and the extreme practicality in use, allow this method to be used for detecting hydrogen leaks from fuel cell stacks or piping.

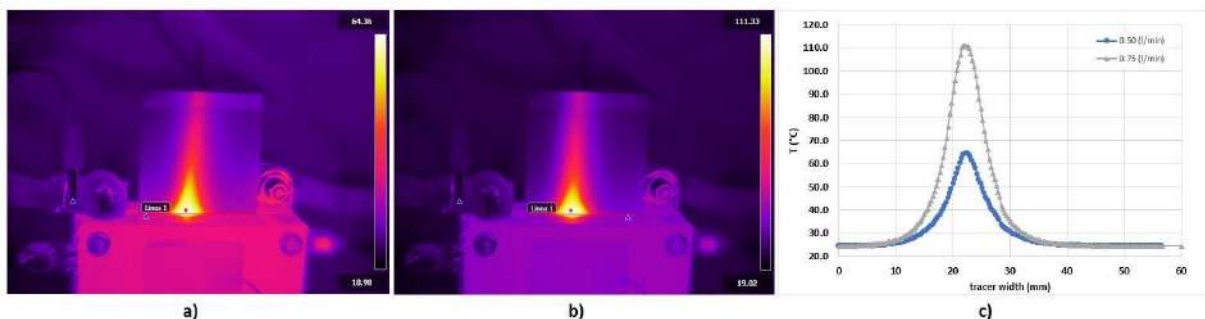

Fig. 2 a) IR image of the hydrogen leakage on the thermal tracer at 50 and 75 ml/min b), c) temperature profile along the thermal tracer width.

## References

- [1] Das PK, Weber AZ, Bender G, Manak A, Bittinat D, Herring AM, et al. Rapid detection of defects in fuel-cell electrodes using infrared reactive-flow-through technique. *J Power Sources* 2014;261:401–11. <https://doi.org/10.1016/J.JPOWSOUR.2013.11.124>.
- [2] Aieta N V., Das PK, Perdue A, Bender G, Herring AM, Weber AZ, et al. Applying infrared thermography as a quality-control tool for the rapid detection of polymer-electrolyte-membrane-fuel-cell catalyst-layer-thickness variations. *J Power Sources* 2012;211:4–11. <https://doi.org/10.1016/j.jpowsour.2012.02.030>.
- [3] Bender G, Felt W, Ulsh M. Detecting and localizing failure points in proton exchange membrane fuel cells using IR thermography. *J Power Sources* 2014;253:224–9. <https://doi.org/10.1016/j.jpowsour.2013.12.045>.
- [4] Asghari S, Fouladi B, Masaeli N, Imani BF. Leak diagnosis of polymer electrolyte membrane fuel cell stacks. *Int J Hydrogen Energy* 2014;39:14980–92. <https://doi.org/10.1016/j.ijhydene.2014.07.044>.



## Analysis of hydrogen/battery hybrid energy storage systems in building microgrids

Elio Simeoni<sup>a</sup>, Giovanni Di Ilio<sup>a</sup>, Elio Jannelli<sup>a</sup>

\* corresponding author: [elio.simeoni001@studenti.uniparthenope.it](mailto:elio.simeoni001@studenti.uniparthenope.it)

<sup>a</sup> University of Naples "Parthenope"

*Keywords: Energy efficient buildings; Hydrogen storage; Techno-economic analysis*

**Abstract:** In order to achieve a drastic emissions reduction as dictated by different international agreements, it is mandatory to reduce the fossil fuel dependence. One way to obtain this aim consists in vary the electricity production through an energy mix derived by renewable energy sources. In particular, buildings require a significant share of energy: thus, achieving a net-zero energy buildings is an ambitious yet crucial task towards the reduction of the global greenhouse gas emissions in the near future. In this context, this study presents a novel hybrid renewable energy system for residential buildings: the system is integrated with a battery pack (BP), an Electrolyzer (EL), a PEM Fuel Cell (PEMFC) and a metal hydride tank for low-pressure hydrogen storage (MH); the electrical energy is produced from a photovoltaic system (PV) whose size is defined according to the available area on the roof of the selected building. The system is designed by following a parametric approach, where the size of each component is varied in order to find a near-optimal configuration in terms of energy saving. Thus, a proper energy management strategy is proposed and the system operation is assessed for a selected residential environment test-case.

**Introduction:** Because of the discontinuous energy production, energy storage or a backup power system is needed for photovoltaic systems. Batteries can be used for daily storage but for seasonal storage this technology is not practical because of the low storage capacity and the high cost. Storing energy in the form of hydrogen is a possible solution for both daily and seasonal storage. Modeling of PV-EL hydrogen system is important for their planning and control strategies in many applications such as residential heating and electricity production. Besides these, PEM types can be efficiently coupled to co-generation systems due to their small size, high power production capabilities, and high efficiencies. Using PEMFC, hot water and/or vapor can also be utilized for household applications such as the Domestic Hot Water demand.

**Objectives:** The main objective of this study is to design a reliable and efficient solar hybrid energy system based on hydrogen as an energy carrier, for a self-sufficient residential building. That is, an energy and economic analysis is conducted in this work to assess the actual feasibility and the potential of a system integrating a PV field with hydrogen technologies to supply the whole energy demand of a residential building located in a southern Italy. In particular, the hydrogen storage is made of a metal hydride tank operating at low-pressure, and its thermal management requirements are accounted for. Moreover, a reversible heat pump is assumed to provide cooling and heating demand, while the domestic hot water (DHW) is produced by exploiting the waste heat produced by fuel cell and electrolyzer during operation. In this scenario, all the utilities request such as electrical energy, heating/cooling and DHW, could be satisfied by the system. The conceived system allows the users to reduce the electrical energy withdrawing from the grid while, at the same time, making possible to sell the exceeding amount of electricity produced to the grid, thus alleviating costs and improving energy efficiency.



# European Fuel Cells and Hydrogen

PIERO LUNGI CONFERENCE

September 13th-15th 2023  
Capri / Italy

**Material and methods:** The main energy source of the designed system is represented by a PV field; the produced energy fulfills the utility and, in case of a surplus, energy can be either stored as electrical energy in the BP or used to produce hydrogen by means of electrolysis. The stored energy in form of electricity or hydrogen can be then used to cover the lack of produced energy when sun radiation becomes insufficient. In particular, an energy flux control logic based on a feedback control on the battery and hydrogen tank states of charge is implemented to suitably balance the storage system. Moreover, the waste heat produced by FC and EL during their operation is recovered and used to satisfy the DHW request from the utilities. The analysis is referred to the city of Naples, Italy, over a period of a year. The system is modeled and simulated in MATLAB environment. The FC and the EL are modeled by means of normalized realistic power/consumption curves, while no BP model is used, rather an average constant efficiency is considered to take into account of its energy loss during charging/discharging. The analysis is carried out by evaluating the energy and economic performance of the system for a range of FC and EL sizes, while the BP capacity is pre-determined basing on the electrical energy demand of the building for two days.

**Results:** In the following Figure, the power profiles for the main energy system components over three representative days are shown, as an illustrative example, for the specific case where the size of the PV plant is set to 18 kW, while EL and FC have 10 kW and 4 kW of nominal power, respectively.

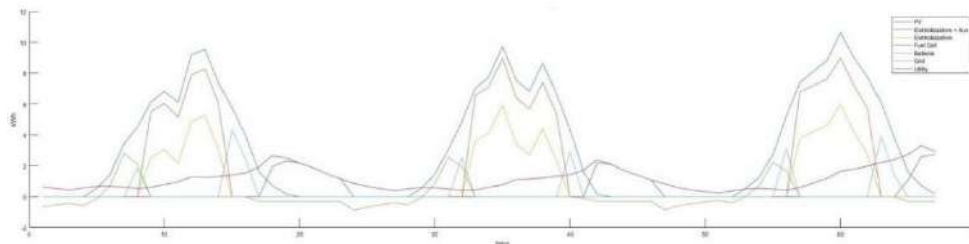

Next, the hydrogen and battery states of charge are shown for the same case over a 1-year period.

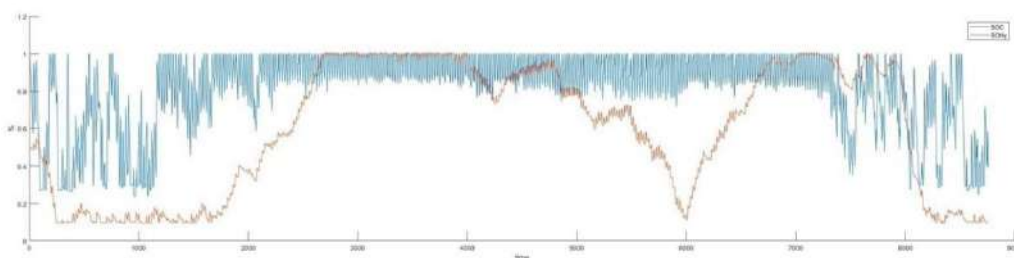

Different optimization parameters are assessed, such as: grid-dependency, average cost for energy, domestic hot water production. As a main finding from the study, a near-optimal configuration of FC, EL and PV is found which minimizes the grid-dependency.

**Conclusions:** A solar energy system integrating batteries and hydrogen technologies for the energy supply of a residential building is assessed throughout this study. The results show that the implementation of such a system in an urban district scenario made of grid-interactive buildings may provide significant benefit in term of cost of electricity and environmental pollution, towards the development of a smart, efficient, energy community.



# European Fuel Cells and Hydrogen

PIERO LUNGI CONFERENCE

September 13th-15th 2023  
Capri / Italy

## TOPIC 3: HYDROGEN CONVERSION





## Hydrogen crossover investigation at intermediate temperatures (IT) in PEMFCs

Martina Butori\*<sup>a</sup>, Björn Eriksson <sup>a</sup>, Henrik Ekström<sup>ab</sup>, Nikola Nikolić<sup>a</sup>, Göran Lindbergh<sup>a</sup>,  
Carina Lagergren<sup>a</sup>, Rakel Wreland Lindström<sup>a</sup>

\* corresponding author: butori@kth.se

<sup>a</sup> Department of Chemical Engineering, KTH Royal Institute of Technology,  
SE-100 44 Stockholm, Sweden

<sup>b</sup> COMSOL AB, Tegnérgatan 23, SE-111 40 Stockholm, Sweden

*Keywords: Hydrogen crossover, Intermediate Temperature Proton Exchange Membrane Fuel Cell, hydrogen partial pressure, 80 – 120 °C*

### **Abstract**

#### **Introduction:**

Proton Exchange Membrane Fuel Cells (PEMFCs) represent a promising choice for the energy system for the next generation of heavy-duty vehicles (HDVs) because they ensure long driving ranges, quick start-up and, most importantly, do not emit pollutants. However, PEMFCs generally operate in the temperature range of 60 – 80 °C, which leads to cumbersome cooling system in HDVs. To improve this aspect a higher operating temperature range is desirable: the intermediate temperature range (IT), 80 – 120 °C [1]. There is limited literature available on commercial materials operated at IT and more research is required in this field. In particular, there is a lack of information on the hydrogen crossover behaviour when a differential pressure across the membrane is applied, which is a typical condition used in transportation applications.

#### **Objectives:**

In this work, the hydrogen crossover of a PEMFC is investigated *in situ* in the IT range and for a wide range of relative humidity (RH) conditions. Symmetric and asymmetric pressure configurations are compared to quantify the impact of hydrogen crossover as a function of its concentration and the differential pressure across the membrane. Results are then modelled to extract general trends and different commercial materials are compared.

#### **Material and methods:**

Nafion-based catalyst coated membranes (CCMs) with reinforcement (Nafion HP) and without reinforcement (Nafion 211) are prepared by spraying. The membrane electrode assemblies (MEAs) and Sigracet 29 BC GDLs are assembled in a 0.95 cm<sup>2</sup> fuel cell, connected to the setup and heated as described in [2]. To quantify the hydrogen crossover, linear sweep voltammetry is employed in different pressure configurations when using hydrogen on one side of the cell and inert gas on the other side. A systematic approach is used and three configurations are tested: both sides are gradually symmetrically pressurized (red curves), only the hydrogen side is

gradually pressurized, while the inert gas side is at ambient pressure (blue curves) and the hydrogen side is pressurized by progressively diluting the gas stream with the purpose of maintaining the same hydrogen partial pressure, while the inert gas side is unchanged (black curves).

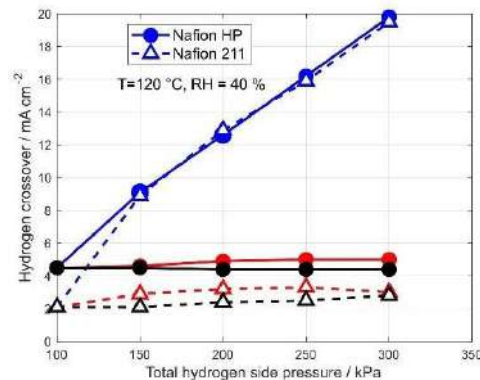

## Results:

As shown in the figure, the hydrogen crossover is highly dependent on the pressure conditions applied. As expected, the case on which only the hydrogen side is pressurized results in the highest crossover given the differential pressure across the membrane and the high hydrogen concentration gradient. Lower crossover is measured at ambient pressure for Nafion 211 compared to Nafion HP. The temperature and relative humidity have a smaller influence on hydrogen crossover compared to the gas pressures.

## Conclusions:

By systematically studying hydrogen crossover in the IT range for a wide RH interval and pressures, it is possible to shed light on which operating condition contributes the most to the crossover of hydrogen in a PEMFC. The use of commercial materials and realistic operating conditions links this work directly to the applications and can be useful to carefully choose the conditions at which the fuel cell should operate.

## Acknowledgment

Swedish Foundation for Strategic Research: PUSH - Production, Use, and Storage of Hydrogen (Project number ARC19-0026), the Swedish Energy Agency via Swedish Electromobility Centre (SEC) and the Swedish governmental initiative StandUp for Energy

## References

- [1] Wang et al. "Materials, technological status, and fundamentals of PEM fuel cells – A review", Materials Today, 2020
- [2] Butori et al., "The Effect of Oxygen Partial Pressure and Humidification in Proton Exchange Membrane Fuel Cells at Intermediate Temperature", J. Power Sources, 2023

## New PBI electrospun membranes for HTPEM-FCs applications

Emmanuel De Gregorio<sup>a,b\*</sup>, Carlo De Luca<sup>c</sup>, Alessio Occhicone<sup>b</sup>, Giuseppina Roviello<sup>b</sup>, Claudio Ferone<sup>b</sup>, Oreste Tarallo<sup>c</sup>, Viviana Cigolotti<sup>a</sup>, Elio Jannelli<sup>b</sup>, Luis Alexander Hein<sup>d</sup>, Alfonso Pozio<sup>a</sup>

<sup>a</sup> *Laboratory for Energy Storage, Batteries and Hydrogen Production and Utilization Technologies, Department of Energy Technologies and Renewable Sources, ENEA—Italian National Agency for New Technologies, Energy and Sustainable Economic Development*

<sup>b</sup> *University of Naples “Parthenope”, Department of Engineering, Centro Direzionale, Isola C4, 80143 Naples, Italy<sup>c</sup> University of Naples “Federico II”, Department of Chemical Sciences, Complesso Universitario di Monte Sant’Angelo, 80126 Naples, Italy*

<sup>d</sup> *NANOFABER srl, Via Anguillarese 301, 00123, Roma*

**\*Corresponding author:** Emmanuel De Gregorio, [emmanuel.degregorio001@studenti.uniparthenope.it](mailto:emmanuel.degregorio001@studenti.uniparthenope.it)

### Introduction

High-Temperature Proton Exchange Membrane Fuel Cell (HTPEM-FC) is a type of fuel cell that operates at elevated temperatures, typically between 120°C and 200°C. HTPEM-FCs offer several advantages over traditional low-temperature PEM-FCs. The high operating temperature allows for more efficient electrochemical reactions <sup>[1]</sup> and improves fuel tolerance <sup>[2]</sup>. HTPEM-FCs are also more resistant to carbon monoxide poisoning, which is an issue in low-temperature fuel cells <sup>[1]</sup>. A polymer commonly used as a PEM material in HTPEM-FCs is polybenzimidazole (PBI, Fig.1) which has excellent chemical and thermal stability and is able to withstand the harsh acid environment of the fuel cell while maintaining its integrity over long periods of operation.

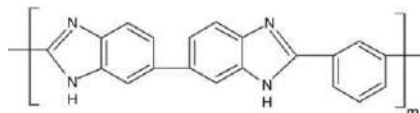

**Figure 1 – PBI chemical structure**

In order to enhance its proton conductivity, PBI membranes are usually doped with phosphoric acid. The acid serves as a proton carrier, facilitating the hopping of protons within the membrane, which is crucial for the functioning of the cell <sup>[3]</sup>. However, solution-cast phosphoric acid-doped PBI proton exchange membranes have some disadvantages that can negatively affect their long-term durability and performance, including (a) high acid adsorption, which can lead to swelling reducing mechanical stability <sup>[4]</sup>; (b) a difficult production process, as solution casting requires hazardous solvents and careful control of the production and drying processes to achieve a uniform thickness (c) mechanical fragility.

In order to contribute to the development of efficient and durable phosphoric acid doped PBI PEMs with improved performances, in this contribution we suggest the use of electrospun ones. These new electrospun membranes could provide several advantages compared to those obtained by solvent casting. In particular, electrospinning could allow precise control of membrane morphology and thickness: by adjusting parameters such as polymer concentration, solvent composition, and electrospinning conditions, the membrane’s fibre diameter, pore size, and overall structure can be tailored to specific requirements. Moreover, electrospun membranes could in principle offer a significantly larger surface area compared to conventional casting methods, thus facilitating the impregnation and retention of phosphoric acid, which is essential for the proton conduction mechanism. Finally, electrospinning will allow the creation of a highly interconnected network ultrafine fibres, typically in the nanometre range <sup>[4]</sup>. This will result in a high surface area-to-volume ratio, which will promote efficient proton conduction through the membrane. This morphology will also result in improved mechanical properties of the material, as the fibrous structure we aim to produce with aligned and/or

interconnected fibres, will provide high tensile strength and good flexibility, ensuring the integrity of the membrane during operation.

### Objective and methods

The main purpose of this work is to obtain nanofibres based PBI membranes through electrospinning technique by identifying the main parameters for obtaining continuous fibres with controlled morphology.

### Results and conclusions

Starting from a commercial PBI solution (S26, PBI Product®, Charlotte, US), several polymer solutions have been obtained at different concentrations by dilution in dimethylacetamide (DMAc). The modulation of operating parameters such as voltage, flow rate, needle-collector distance, temperature, and relative humidity (RH) made it possible to obtain several membrane specimens, whose morphology was studied by SEM (Fig.2).

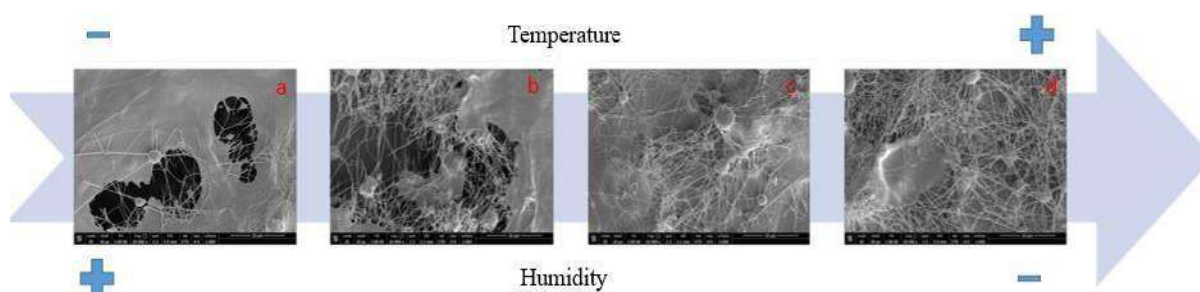

**Figure 2** – Nano fibrous structure evolution by varying temperature and humidity (SEM analysis): a)  $V= 20kV$ ;  $T=35^{\circ}C$ ;  $RH=36\%$  - b)  $V= 15kV$ ;  $T= 35^{\circ}C$ ;  $RH=25\%$  - c)  $V=20 kV$ ;  $T= 40^{\circ}C$ ;  $RH= 26\%$  - d)  $V=20 kV$ ;  $T=40^{\circ}C$ ;  $RH=25\%$

The performed tests, despite being very preliminary, already show the influence of the of the explored operating parameters on the structure of the membrane. As a matter of fact, it is possible to note a strong correlation between the morphological characteristics of the membranes and the temperature and humidity at which the experiment was conducted. At room temperature ( $20^{\circ}C$ ) and humidity (30%), PBI does not present a well-defined fibrous structure, indeed, the polymer chains are agglomerated in clusters due to poor evaporation of the solvent. Instead, tests carried out at higher temperatures (between 35 and  $40^{\circ}C$ ) and variable humidity (20-26%) show an incipient fibrous structure with fibre diameters varying in the nanometre range. However, also in this case, a discontinuous structure is evident, which can be attributed to the high viscosity of the polymer solution and, consequently, the different behaviour of the fluid in the electrification process. Hence, increasing temperature and varying humidity allow the obtainment of a fibrous structure, which can be further improved through optimization of the operating parameters. This optimisation will be performed starting from SEM micrographs and by using the DOE technique and ANOVA statistical regression. The resulting materials will be doped with phosphoric acid and their electrochemical properties will be tested by proton conductivity and impedance analysis (EIS), comparing their performance with that of commercially used PBI membranes.

### References

- [1] Wainright, J.S. et al. *ECS Proceedings Volumes* 2002, 31, 440
- [2] Araya, S.S. et al. *Internation Journal of Hydrogen Energy* 2016, 41, 21310-21344
- [3] Ozdemir, Y. et al. *Internation Journal of Hydrogen Energy* 2017, 42, 2648-2657
- [4] Li, Q. et al. *Fuel Cells* 2004, 4, 3

## Crosslinked PVA films as an alternative PEM in LTFCs applications

Carlo De Luca<sup>a \*</sup>, Emmanuel De Gregorio<sup>b, d</sup>, Alessio Occhicone<sup>b</sup>, Giuseppina Roviello<sup>b</sup>, Claudio Ferone<sup>b</sup>, Viviana Cigolotti<sup>c</sup>, Elio Jannelli<sup>b</sup>, Oreste Tarallo<sup>a</sup>

<sup>a</sup>University of Naples "Federico II", Department of Chemical Sciences, Complesso Universitario di Monte Sant'Angelo, 80126 Naples, Italy

<sup>b</sup>University of Naples "Parthenope", Department of Engineering, Centro Direzionale, Isola C4, 80143 Naples, Italy

<sup>c</sup>Laboratory for Energy Storage, Batteries and Hydrogen Production and Utilization Technologies, Department of Energy Technologies and Renewable Sources, ENEA—Italian National Agency for New Technologies, Energy and Sustainable Economic Development

<sup>d</sup>ENEA Italian National Agency for Energy, New Technologies and Sustainable Economic Development, Department of Energy Technologies and Renewable Sources, Laboratory of Energy Storage, batteries and Hydrogen Production and Use (TERIN PSU ABI), C.R. Casaccia, Rome, Italy;

\*Corresponding author: Carlo De Luca, carlo.deluca@studenti.unina.it

### Introduction

A Low-Temperature Proton Exchange Membrane Fuel Cell (LTPEMFC) consists of an anode and a cathode separated by a PEM. This type of FC uses a proton conductive polymer membrane as electrolyte and operates at relatively low temperatures (60-90 °C), by electrochemically combining hydrogen fuel and oxygen to produce electricity, water, and heat. They are known for their high power density, compact size, and quick response to changes in power demand [1]. Despite perfluorosulfonic acid polymer (Nafion<sup>®</sup>) has been widely used as a benchmark material in LTPEMFCs due to its excellent properties, [2] there are ongoing efforts to develop alternative PEM with improved performance, lower cost, and enhanced durability. In this contribution we propose new polyvinyl alcohol (PVA, Fig.1a) based membranes crosslinked with an alternative sulfonating crosslinking agent, the 5-Sulfoisophthalic acid monosodium salt (sSPTA, Fig.1b), characterized by good proton conductivity and water management together with good mechanical properties, and thermal stability. [3]

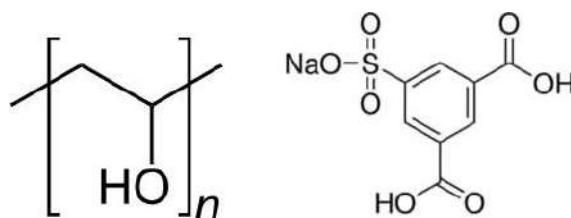

Figure 1 – (a) PVA and (b) 5-Sulfoisophthalic acid monosodium salt.

### Aim

In this work, our goal is to find new polymeric materials characterized by a whole range of properties for the development of innovative protonic membranes that can be used in LTPEMFCs in place of Nafion<sup>®</sup>.

### Methods

Crosslinked and sulfonated films were cast from aqueous solutions of commercial PVA samples with different molecular masses and different sSPTA to PVA content (10% - 40% wt) according to the following scheme:

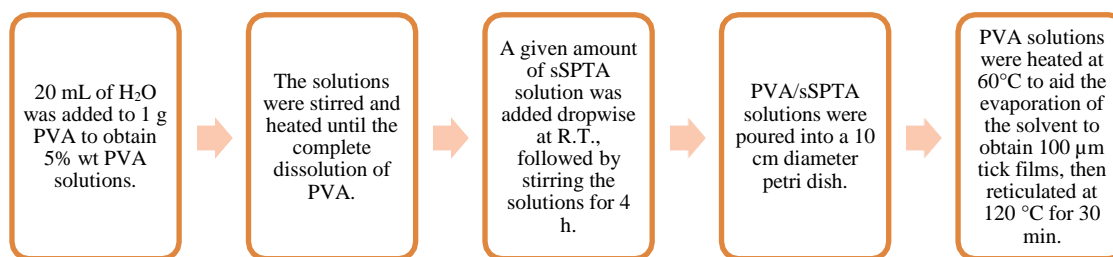

The obtained samples were characterized from a structural point of view by WAXD, TGA, and FT-IR and by determining water uptake (WU), and ion exchange capacity (IEC).

### Results

Fig.2a shows IEC values of the sulfonated PVA membranes as a function of sSPTA content, suggesting as expected that IEC of the membranes strongly increases with the amount of sulfonic group. Fig.2b shows that WU values of the membranes are relatively constant with the increase in weight of sSPTA; moreover, the newly developed PVA films do not dissolve in water, a sign that crosslinking has been successful.

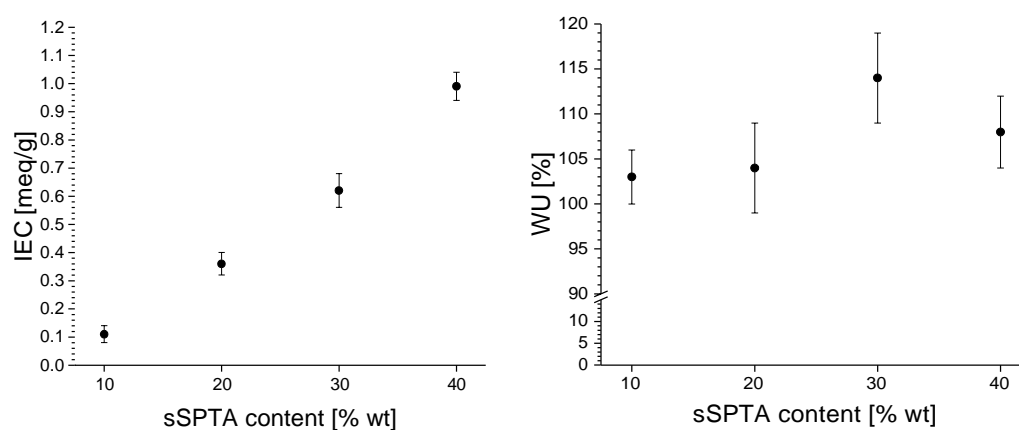

**Figure 2** – (a) IEC and (b) WU values of the sulfonated PVA membranes as a function of sSPTA content.

### Conclusions

Crosslinked proton exchange PVA/sSPTA membranes were successfully obtained by solvent casting ready to be used in fuel cells. Preliminary results show that the electrochemical and physical properties of these membranes seem to be significantly enhanced with increasing the concentration of the crosslinking agent. In particular, the sulphonated membrane is more thermally stable than the non-sulfonated one. IEC of the sulfonated PVA membranes increases with the amount of sSPTA up to 0.99 meq/g in the case of the sample with 40 % wt of sSPTA whereas WU is constant (~100%). Further studies are in progress to improve the chemical, physical and mechanical properties of the developed membranes.

### References

- [1] S. A. Gold, «Low-Temperature Fuel Cell Technology for Green Energy,» in *Handbook of Climate Change Mitigation.*, New York, NY, Springer, 2012.
- [2] F. M. Collette, F. ThomINETTE, H. Mendil-Jakani e G. Gebel, «Structure and transport properties of solution-cast Nafion membranes subjected to hygrothermal aging,» *Journal of Membrane Science*, vol. 435, pp. 242-252, 2013.
- [3] J. Chanthad e J. Wootthikanokkhan, «Effects of Crosslinking Time and Amount of Sulphophthalic Acid on Properties of the Sulfonated Poly(vinyl alcohol) Membrane,» *Journal of Applied Polymer Science*, vol. 101, n. 3, pp. 1931-1936, 2006.



## Comparison of the fitting parameters of a semi-empirical polarization model applied to two anode supported Solid Oxide Fuel Cells for the determination of reaction mechanisms and kinetic parameters

Giacomo Tamburrano\*<sup>1</sup> [g.tamburrano@lab.unimarconi.it](mailto:g.tamburrano@lab.unimarconi.it), Alessandro Dell'Era<sup>2</sup> [alessandro.dellera@uniroma1.it](mailto:alessandro.dellera@uniroma1.it), Arda Hatunoglu<sup>1,3</sup> [arda.hatunoglu@uniroma1.it](mailto:arda.hatunoglu@uniroma1.it), Andrea Monforti Ferrario<sup>4</sup> [andrea.monfortiferrario@enea.it](mailto:andrea.monfortiferrario@enea.it), Luca Del Zotto<sup>5</sup>, [luca.delzotto@uniecampus.it](mailto:luca.delzotto@uniecampus.it) and Erwin Ciro<sup>1</sup> [e.ciro@lab.unimarconi.it](mailto:e.ciro@lab.unimarconi.it)

\* corresponding author: [g.tamburrano@lab.unimarconi.it](mailto:g.tamburrano@lab.unimarconi.it)

<sup>1</sup>Department of Engineering Sciences, Università degli Studi Guglielmo Marconi, 00193 Rome, Italy

<sup>2</sup>Department of Basic and Applied Science for Engineering, Sapienza University of Rome, 00161 Rome, Italy

<sup>3</sup>Department of Astronautics, Electrical and Energy Engineering, Sapienza Università di Roma, Via Eudossiana 18, 00184 Rome, Italy

<sup>4</sup>ENEA, Laboratory of Energy Storage, Batteries and Hydrogen Production & Use, Department of Energy Technologies and Renewable Sources (TERIN-PSU-ABI), Italian National Agency for New Technologies, Energy and Sustainable Economic Development, C.R. Casaccia, Via Anguillarese 301 – 00123 Rome, Italy

<sup>5</sup>Centro di Ricerca su Energia, Ambiente e Territorio, Università Telematica eCampus, 22060 Novedrate, Italy

*Keywords: Solid Oxide Fuel Cells; Fitting; Electrochemical characterization; Clean Energy*

### Introduction:

Nowadays, the need for clean and efficient alternatives to fossil fuels is increasingly evident. Fuel Cells (FC) are one of the most promising electrochemical devices able to produce electrical and thermal energy. Among the different types of cells, Solid Oxide Fuel Cells (SOFCs) operate at high temperatures, have high conversion efficiencies and can be fed with different kinds of fuels, including carbon-based ones, which makes them suitable for generating stationary electrical power and heat [1,2,3].

### Objectives:

The main objective in this investigation is the development of a suitable fitting tool for different SOFCs to obtain information of the single electrode starting of the acquisition from the whole system.

### Material and methods:

In this work a semi-empirical electrochemical polarization model based on fitting of experimental I–V curves is presented. The empirical parameters of the model are extrapolated via fitting of experimental datasets of two different anode supported button cell, where obtained at different temperatures (ranges from 650 °C to 700 °C and from 700 °C to 800 °C according to the cell design) and with different hydrogen concentrations as fuel gas (ranges from 10-15% to 90%).

Utilizing two different approximations of the Butler-Volmer equation applied on experimental data of the whole FC system it has been possible to determine the numerical values for kinetic parameters of the polarization model such as the exchange current density activation energy and limit currents. Finally, from the empirical



parameter values, an estimation of the most probable reaction mechanisms [4,5] occurring in the cells has been performed on the basis of the charge transfer coefficients determination, allowing also to calculate coherent kinetics parameters also for the single electrodes.

#### **Results:**

From the results the obtained exchange current densities [6] ranges from 0.018 to 0.048 A/cm<sup>2</sup> for O<sub>2</sub> reduction and from 0.033 to 0.6 A/cm<sup>2</sup> for H<sub>2</sub> oxidation and subsequently the activation energies [7] with a range from 60 to 66 kJ/mol and from 100 to 120 kJ/mol for anodic and cathodic electrochemical processes respectively.

A critical comparison of the results obtained was performed in order to identify the effect of different hydrogen and temperature conditions, as well as the effect of different cell characteristics on their electrochemical processes, catalytic activity and mass transfer phenomena within the electrodes, which are reflected in the kinetic parameters obtained. The estimation of such parameters can highlight criticisms related to the cell electrochemical processes and help address possible solutions for obtaining an effective improvement of SOFC performance.

#### **Conclusions:**

The presented study made it possible to develop a new analysis method for solid oxide fuel cells. The results obtained are in line with those found in literature and prove the correctness of the model developed. The great innovation lies in being able to derive information on individual cell components from information on the system as a whole.

#### **Acknowledgment**

The authors acknowledge ENEA and its Laboratory of Energy Storage, Batteries and Hydrogen Production & Use, Department of Energy Technologies and Renewable Sources, as well as European Union's Horizon 2020 research and innovation program under grant agreement No 815284 BLAZE and 101006656 GICO project.

#### **References**

- [1] A.Boudghene Stambouli, E Traversa, Solid oxide fuel cells (SOFCs): a review of an environmentally clean and efficient source of energy, *Renewable and Sustainable Energy Reviews*, Volume 6, Issue 5, 2002, Pag 433-455
- [2] Arnab Choudhury, H. Chandra, A. Arora, Application of solid oxide fuel cell technology for power generation—A review, *Renewable and Sustainable Energy Reviews*, Volume 20, 2013, Pag 430-442
- [3] Qidong Xu, Zengjia Guo, Lingchao Xia, Qijiao He, Zheng Li, Idris Temitope Bello, Keqing Zheng, Meng Ni (2022) A comprehensive review of solid oxide fuel cells operating on various promising alternative fuels. *Energy Conversion and Management* 253
- [4] W.G. Bessler, M.Vogler, H.Störmer, D. Gerthsen, A. Utz, A. Weberd and E. Ivers-Tifféede, Model anodes and anode models for understanding the mechanism of hydrogen oxidation in solid oxide fuel cells, *Phys. Chem. Chem. Phys.*, 2010, 12, 13888–13903.
- [5] M. Gong, R.S. Gemmen, X. Liu, Modeling of oxygen reduction mechanism for 3PB and 2PB pathways at solid oxide fuel cell cathode from multi-step charge transfer. *Journal of Power Sources* 201 (2012) 204– 218.
- [6] T. Fukumoto, N. Endo, K. Natsukoshi, Y. Tachikawa, George F. Harrington, S.M. Lyth, J. Matsuda, K. Sasaki, Exchange current density of reversible solid oxide cell electrodes, *international journal of hydrogen energy* 47 (2022) 16626 16639.
- [7] X. Zhang, L.Wang, M. Espinoza, T. Li, M. Andersson, Numerical simulation of solid oxide fuel cells comparing different electrochemical kinetics, *Int J Energy Res.* 2021;45:12980–12995.





## Fibre shape effect on two-phase behaviour in gas diffusion layers and gas channels of PEMFCs – A numerical study

Danan Yang\*, Himani Garg\*, Martin Andersson \*

\* Dept. Energy Sciences, Lund University, Lund Sweden

### Abstract

Flooding and dehydration considerably impact power performance and stability in proton exchange membrane fuel cells (PEMFCs). The GDL (gas diffusion layer) plays an important role in enabling reactant gas transport to the electrode and removing product water from the electrochemical reaction sites. GDLs come in different shapes to suit various PEMFCs, however, the GDL structural shape influence on internal water transport performance remains uncertain. Here, we study this, by comparing straight and curved GDLs. Straight and curved GDLs are reconstructed, using the same through-plane fiber diameter, porosity distribution, domain size and PSD (pore size distribution). The liquid transport through the straight and curved GDL and the assembled GCs (gas channels) is then simulated with the VOF (volume-of-fluid) approach in OpenFOAM 7.0. The results indicates that the capillary pressure and total water saturation in straight and curved GDLs are similar, while the liquid breakthrough locations and through-plane local water saturation level differ considerably. Additionally, the GC variation in water saturation displays a with time increasing difference. For straight-fiber GDL, larger water slugs, located in the corner of the top and side surfaces of the GC, are observed for a later simulation time. For a curved-fiber GDL more separated droplets in the GC domain are observed, which flow out of the GC at a faster speed compared with the slug for straight fibres.

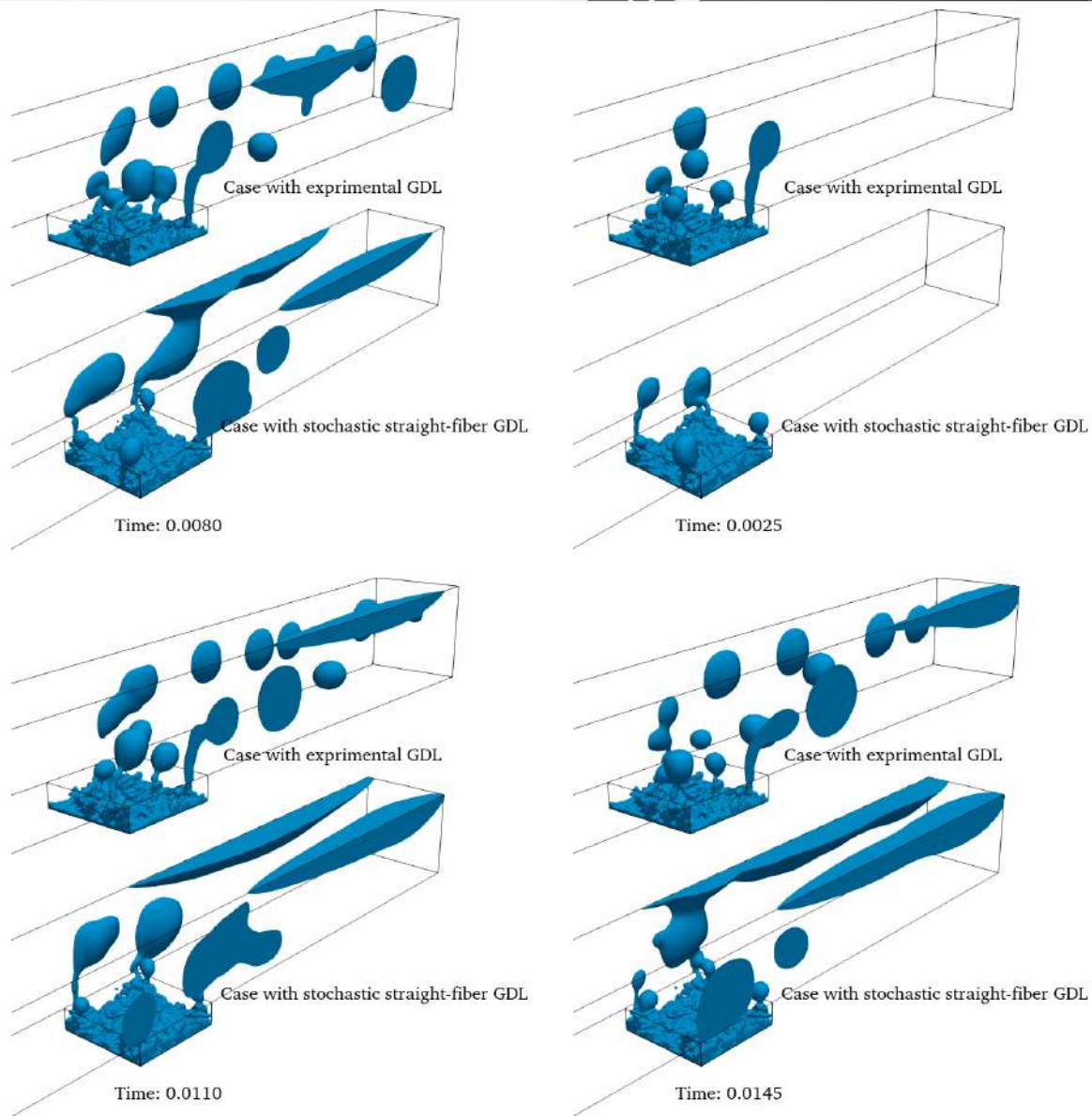

Figure 1: The time-varying water transport for straight and curved GDL fibers using 3D scalar clip plots, focusing on volume fractions larger than 0.5. The time scale in the figure is second. Both cases exhibits a similar water breakthrough timestep, but with substantially different breakthrough positions.

## Ejector design for fuel cell and assessment on its scalability

C. Antetomaso<sup>a</sup>, A. Irimescu<sup>a</sup>, S. S. Merola<sup>a</sup>, B. M. Vaglieco<sup>a</sup>, S. Di Micco<sup>b</sup>, E. Jannelli<sup>b</sup>

<sup>a</sup> CNR STEMS, Naples, Italy

<sup>b</sup> University of Naples "Parthenope", Naples, Italy

### Introduction

The commonly used layout for Proton Exchange Membrane Fuel Cells (PEMFC) involves the use of a recirculation circuit for the anodic gas that didn't take part in the redox reaction in the Catalyst Layer (CL) of the membrane. For this purpose, the ejector present itself as an interesting technology: in spite to a pump, it has no moving parts and does not require power to work, thus increasing the overall efficiency of the cell. On the other hand, ejectors are really sensitive to load changes and require an attentive design process. Nozzle diameter and position, convergent and divergent angle, ratio between nozzle and mixing chamber diameter are some of the project parameters whose optimisation usually proceed by trial and error. Aim of this work is to develop and validate a 3D CFD model for an ejector of a 5000 W PEMFC and then design three new geometries to be coupled with a 3000 W, a 1000 W and a 300 W cells. Finally, scalability and convenience of an ejector for different static power request are assessed.

### Methodology

The ejector model is developed using the commercial software Ansys FLUENT 2023 R1. The data used for the validation phase came from Nikiforow et al. [1], who reported the primary and secondary flow for an ejector under several operative conditions. Table 1 reports considered cases for model validation phase, while Figure 1 shows the comparison between experimental data and simulations results. The design phase of the other ejectors started from the base geometry described by Nikiforow and followed some "rule of thumbs" proposed by other studies [2,3,4].

**Table 1.** Case simulated during model validation

Case	Primary pressure [barg]	Recirculation pressure [barg]	Outlet pressure [barg]
1	1,0	0,5	0,5
2	2,0	0,5	0,5
3	3,0	0,5	0,5
4	4,0	0,5	0,5
5	5,0	0,5	0,5
6	6,0	0,5	0,5

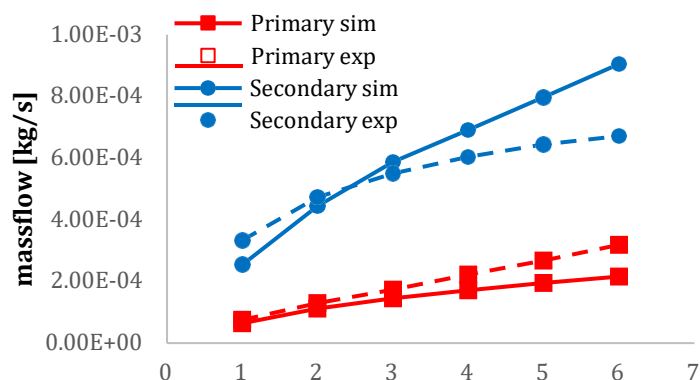

**Figure 1.** Comparison of primary and secondary flow

The main difference lays on the nozzle diameter, that can be evaluated using the following formula:

$$m_{h2} = C * \pi * \left(\frac{D_n}{2}\right)^2 * p_p * \sqrt{\gamma * \frac{M_{h2}}{R * T_p} * \left(\frac{2}{\gamma+1}\right)^{\frac{\gamma+1}{\gamma-1}}} \quad (1)$$

where  $m_{h2}$  is the maximum hydrogen mass flow,  $C$  is the discharge coefficient,  $D_n$  is the nozzle outlet diameter,  $p_p$  is the maximum primary pressure,  $\gamma$  is the isentropic expansion factor,  $M_{h2}$  is the molar weight of hydrogen,  $R$  is the gas constant and  $T_p$  is the temperature at primary inlet. Other design parameters are calculated as function of nozzle diameter. Calculation led to choosing 0,4 mm, 0,25 mm and 0,1 mm as nozzle diameter for the 3000 W, the 1000 W and the 300 W cell respectively. Table 2 shows the main dimensions used in ejectors design.

**Table 2.** Ejectors design parameters

Ejector	Nozzle diameter [mm]	Mixing section diameter [mm]	Mixing section length [mm]	Nozzle X position [mm]	Diffuser outlet diameter [mm]	Diffuser Angle [°]
5000 W [1]	0,50	2,0	16,0	1,8	10,0	5,0
3000 W	0,40	1,6	9,6	1,6	8,0	5,0
1000 W	0,25	1,0	6,0	1,0	5,0	5,0
300 W	0,10	0,4	2,4	0,4	2,0	5,0

## Conclusions

The 3D CFD model of an ejector for a 5000 W PEMFC system has been validated with and it has been used as starting point for the design of a 3000 W, a 1000 W and a 300 W PEMFC anodic gas recirculation system. With the aim to provide an efficient and cost-saving solution realized through 3D printing, it is possible to assert that 1000-3000 W represents the lower feasibility limit: the used methodology suggests that, as smaller energetic system (and thus reduced mass flow rate) are considered, the dimension of nozzle start to approach values that require particular and expensive machining. In this context, evaluating operative conditions and needs of the selected energetic system is fundamental to choose the best alternative between pumps, ejectors and no-recirculation setup.

## References

- [1] Nikiforow, K., et al. "Designing a hydrogen gas ejector for 5 kW stationary PEMFC system—CFD-modeling and experimental validation." *International Journal of Hydrogen Energy* 41.33 (2016)
- [2] Brunner, Douglas A., et al. "Design and characterization of an electronically controlled variable flow rate ejector for fuel cell applications." *International journal of hydrogen energy* 37.5 (2012)
- [3] Hosseinzadeh, Elham, et al. "Numerical analysis of transport phenomena for designing of ejector in PEM forklift system." *International journal of hydrogen energy* 39.12 (2014)
- [4] Maghsoodi, A., E. Afshari, and H. Ahmadikia. "Optimization of geometric parameters for design a high-performance ejector in the proton exchange membrane fuel cell system using artificial neural network and genetic algorithm." *Applied Thermal Engineering* 71.1 (2014)

## Reheating as an option to increase the efficiency of a novel power generation system based on ammonia oxy-combustion

A. Cammarata<sup>a</sup>, P. Colbertaldo<sup>\*,a</sup>, S. Campanari<sup>a</sup>

\*corresponding author: [paolo.colbertaldo@polimi.it](mailto:paolo.colbertaldo@polimi.it)

<sup>a</sup> Department of Energy, Politecnico di Milano – Via Lambruschini 4A, 20156, Milan, Italy

**Keywords:** ammonia, oxy-combustion, power generation, reheating.

### Abstract

Ammonia is a promising hydrogen-based energy vector. In the HiPowAR project, an innovative system is developed, based on oxy-combustion of ammonia in a membrane reactor and expansion of the obtained nitrogen-steam mixture. The system combines high temperature and pressure (typical of gas turbines) and large expansion ratio (typical of steam cycles). This work studies the impact of reheating, which proves advantageous, with stronger benefits at lower temperature.

### Introduction

The need to reduce carbon emissions is driving the research for cleaner sources of energy. In this framework, storing excess renewable power into synthetic fuels has been identified as a necessary strategy to decouple generation and use of power in both time and space. Although H<sub>2</sub> is recognized as the benchmark clean synthetic fuel, using hydrogen derivatives might reduce storage and transport costs. Among these, ammonia (NH<sub>3</sub>) has the advantage of zero carbon emissions upon oxidation.

The potential use of ammonia as a clean energy vector has driven research towards its use as a fuel in power generation systems, both combustion- and fuel cell-based [1,2]. The HiPowAR project aims at using ammonia in a novel system, which applies oxy-combustion by supplying pure oxygen to the oxidation chamber by means of integrated oxygen transport membranes (see Figure 9-left). The oxygen membrane material primarily considered is Ba<sub>0.5</sub>Sr<sub>0.5</sub>Co<sub>0.8</sub>Fe<sub>0.2</sub>O<sub>3-δ</sub> (BSCF) [3]. The resulting hot and pressurized nitrogen-steam mixture (about 90%mol H<sub>2</sub>O) is expanded to produce useful work [4]. Liquid water is recirculated to moderate the temperature in the membrane reactor (MR).

A high system efficiency is expected, combining a high maximum cycle temperature, due to the internal combustion typical of gas turbines, and a large expansion ratio, possibly sub-atmospheric, as typical of steam Rankine cycles. Moreover, the techniques used in either cycle can be used to increase the system efficiency, like blade cooling, usually implemented in gas turbines to increase the turbine inlet temperature (TIT), or bleeding and reheating, which are often used in steam Rankine cycles.

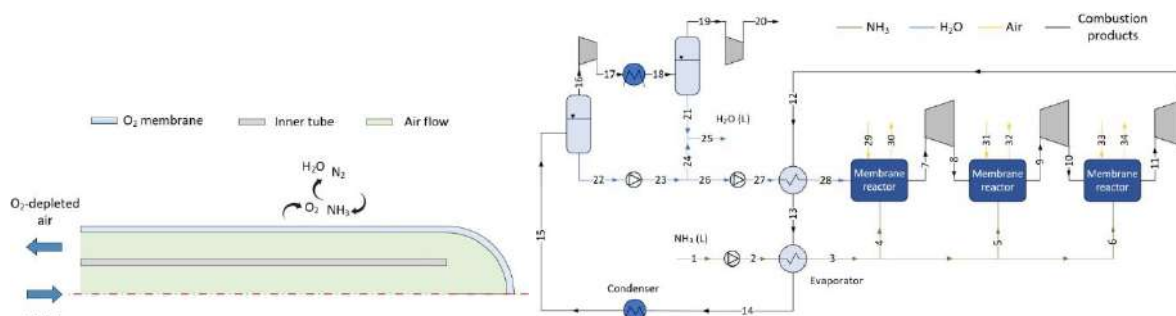

Figure 9 – (left) Double capillary oxygen membrane used within the membrane reactor to deliver pure oxygen for ammonia oxidation; (right) HiPowAR system configuration with double reheating, scheme A.

### System description, Methods, and Data

The purpose of this work is to evaluate the effects of reheating on the efficiency of the HiPowAR system. Figure 9-right shows the configuration of the HiPowAR system including a double reheating process. Ammonia is oxidized using pure O<sub>2</sub> in a series of three MRs, each composed of several tubular membranes. The hot gas-steam mixture is sequentially expanded, down to sub-atmospheric pressure (0.1-0.12 bar). After heat recovery and water condensation, the off-gas (mainly N<sub>2</sub>) is compressed to ambient pressure (#20). Liquid water (stream #28) is recovered and used as temperature moderator.

The model is implemented in Aspen Plus<sup>®</sup>, assuming reasonable values for polytropic efficiency and heat losses. Two system configurations are investigated. In scheme A, the maximum system pressure (streams #27 and #2) is selected to guarantee a 10°C pinch-point temperature difference in the ammonia evaporator, which thus exploits waste heat. In scheme B, the evaporator is removed and liquid ammonia is sent to the MRs and a larger maximum cycle pressure is employed (50 bar).

### Results and Discussion

Results are shown in Table 2, focusing on system electric efficiency ( $\eta_{el}$ ), which account also for additional loss terms like gearbox, electric generator efficiency, and auxiliaries' consumption.

The maximum cycle temperature significantly increases the system efficiency, as in conventional power generation systems (note that in the 1350°C case, ceramic materials should be used for the expanders, since blade cooling is not present). Scheme B performs slightly better than scheme A, except for the 850°C case with no reheating, where the minimum system pressure is kept at 0.3 bar to avoid liquid droplets formation during expansion. In scheme A the design of reactors and expanders is simplified, thanks to the lower maximum pressure. In all cases, reheating significantly increases the system efficiency due to the lower irreversibilities related to the introduction of heat in the cycle. The benefits of reheating are more evident for scheme B due to the larger expansion ratio, which increases the fraction of heat that is introduced at relatively large temperature. Finally, reheating is more impactful when the maximum cycle temperature is lower (cases at 850°C), which is attributed to the larger irreversibility related to the introduction of heat in the cycle when the *TIT* is relatively low.

Table 2 – Effect of reheating on the system electric efficiency for different turbine inlet temperature (*TIT*), for both scheme A and B.

<i>TIT</i> [°C]	Reheating	Scheme A			Scheme B		
		$p_{max}$ [bar]	$p_{min}$ [bar]	$\eta_{el}$ [%]	$p_{max}$ [bar]	$p_{min}$ [bar]	$\eta_{el}$ [%]
1350	No	16	0.12	54.1	50	0.1	54.8
1350	Yes	14	0.1	58.8	50	0.1	60.2
850	No	16	0.12	42.1	50	0.3	40.7
850	Yes	14	0.1	48.2	50	0.1	50.2

### Acknowledgment

The HiPowAR project has received funding from the European Union's Horizon 2020 research and innovation programme under grant agreement n. 951880.

### References

- [1] O. Kurata, N. Iki, T. Matsunuma, T. Inoue, T. Tsujimura, H. Furutani, H. Kobayashi, A. Hayakawa, Performances and emission characteristics of NH<sub>3</sub>-air and NH<sub>3</sub>-CH<sub>4</sub>-air combustion gas-turbine power generations, *Proc. Combust. Inst.* (2016) 3351–3359. <https://doi.org/10.1016/j.proci.2016.07.088>.
- [2] M. Kishimoto, H. Muroyama, S. Suzuki, M. Saito, T. Koide, Y. Takahashi, T. Horiuchi, H. Yamasaki, S. Matsumoto, H. Kubo, N. Takahashi, A. Okabe, S. Ueguchi, M. Jun, A. Tateno, T. Matsuo, T. Matsui, H. Iwai, H. Yoshida, K. Eguchi, Development of 1 kW-class Ammonia-fueled Solid Oxide Fuel Cell Stack, *Fuel Cells*. 20 (2020) 80–88. <https://doi.org/10.1002/fuce.201900131>.
- [3] J.X. Yi, H.L. Lein, T. Grande, S. Yakovlev, H.J.M. Bouwmeester, High-temperature compressive creep behaviour of the perovskite-type oxide Ba<sub>0.5</sub>Sr<sub>0.5</sub>Co<sub>0.8</sub>Fe<sub>0.2</sub>O<sub>3-δ</sub>, *Solid State Ionics*. 180 (2009) 1564–1568. <https://doi.org/10.1016/j.ssi.2009.09.014>.
- [4] A. Cammarata, P. Colbitaldo, S. Campanari, Simulation of the HiPowAR power generation system for steam-nitrogen expansion after ammonia oxidation in a high-pressure oxygen membrane reactor, in: *E3S Web Conf. - Proc. 76th ATI Annu. Congr.*, 2021: pp. 1–17. <https://doi.org/10.1051/e3sconf/202131208016>.



## Understanding Charge, Mass, and Heat Transfer in Fuel Cells for Transport Applications – Insights from the CAMELOT Project

Patrick Fortin<sup>\*a</sup>, Yejung Choi<sup>a</sup>, Thor Aarhaug<sup>a</sup>, Jake Coole<sup>b</sup>, Dharshini Fongalland<sup>b</sup>, Silvain Buche<sup>b</sup>, David Harvey<sup>c</sup>, Jiri Hrdlicka<sup>c</sup>, Senén Moya<sup>d</sup>, Hien Ngyen<sup>e</sup>, Severin Vierrath<sup>e</sup>, Fanny Byström<sup>f</sup>, Lukas Hansen<sup>f</sup>, Victor Shokhen<sup>f</sup>

\* corresponding author: [patrick.fortin@sintef.no](mailto:patrick.fortin@sintef.no)

<sup>a</sup> SINTEF AS

<sup>b</sup> Johnson Matthey Fuel Cell

<sup>c</sup> FAST Simulations

<sup>d</sup> Technische Universität Chemnitz

<sup>e</sup> University of Freiburg IMTEK

<sup>f</sup> PowerCell

*Keywords: Catalyst Layer, Fuel Cell, Proton Exchange Membrane, Water Transport*

### Abstract

**Introduction:** Proton Exchange Membrane Fuel Cells (PEMFCs) are a promising solution for zero-emission vehicle propulsion owing to their high energy density, low operating temperature, and high efficiency. The CAMELOT project brings together world-leading industrial, institutional, and academic partners within the fuel cell industry to improve the power density of fuel cells by understanding the performance limitations of state-of-the-art (SoA) and beyond SoA PEMFC membrane electrode assemblies (MEAs).

**Objectives:** The overall objective of improving PEMFC power densities through increased understanding of the underlying MEA limitations will be achieved through the following specific objective:

- i. Diagnose the fundamental transport properties that limit performance in SoA and beyond-SoA fuel cell components and MEAs.
- ii. Extend a leading open-source model to enable the accurate simulation of SoA MEAs using automotive fuel cell geometries.
- iii. Produce MEAs with features that have the potential to enable disruptive performance increases and to validate the open-source model for beyond-SoA MEAs.
- iv. Propose new beyond-SoA MEA designs in automotive fuel cell geometries that address SoA performance limitations and provide simulation tools that guide rational development of new MEA concepts.

**Material and methods:** In-depth parametrisation of fuel cell components through extensive ex-situ and in-situ characterisation has been performed to provide input to the modelling activities. The two major modelling advances achieved by the CAMELOT project are i) the improvement of water uptake and transport models, especially concerning ultra-thin PEMs, and ii) extending a leading open-source model (FAST-FC) to enable accurate simulation of



beyond SoA fuel cell performance and voltage loss breakdown. CAMELOT has developed a series of beyond-SoA fuel cell components to ensure that the modelling inputs are representative of SoA component properties. A series of proton exchange membranes with varying thicknesses were prepared and a range of ex-situ experiments (e.g., dynamic vapor sorption, water permeability, water uptake and swelling) were carried out to gather water uptake and permeability properties for the water transport models. Additional in-situ fuel cell characterisation was carried out on a series of catalyst coated membranes (CCMs) to extract physical, chemical, and electrochemical properties (e.g., exchange current density, Tafel slope, Ohmic resistance, hydrogen crossover, and electrochemically active surface area, etc.) important properties of the catalyst and membrane components as inputs to improve the physics-based fuel cell performance model.

**Results:** Significant results from the project to be highlighted in this presentation include the development of a water transport model with improved description of water uptake and transport in thin ionomeric layers, the development of a predictive modelling framework from which we can identify the most important material parameters to reach our MEA performance targets of  $2.7 \text{ A/cm}^2$  at  $>0.67 \text{ V}$  with total catalyst loadings  $<0.08 \text{ mg}_{\text{Pt}}/\text{cm}^2$ , the development of ultrathin ( $< 10 \text{ }\mu\text{m}$ ) proton exchange membranes and ultra-low loading cathode catalyst loadings ( $0.08 \text{ mg}_{\text{Pt}}/\text{cm}^2$ ), the development of catalyst coated membranes (CCMs) with in-plane catalyst and ionomer gradients, and extensive in-situ fuel cell characterization of the SoA CAMELOT CCMs/MEAs.

**Conclusions:** Within the CAMELOT project, beyond state-of-the-art fuel cell components have been developed and characterized. The materials properties determined through extensive characterization have been incorporated into open-source modelling frameworks to further guide the optimized development of next-generation fuel cell components. The models developed within CAMELOT have identified the materials properties with the largest influence on MEA performance and we have made suggestions for reaching the ambitious fuel cell performance target of  $2.7 \text{ A/cm}^2$  at  $>0.67 \text{ V}$  with total catalyst loadings  $<0.08 \text{ mg}_{\text{Pt}}/\text{cm}^2$ .

### **Acknowledgment**

The CAMELOT project has received funding from the Fuel Cells and Hydrogen 2 Joint Undertaking (now Clean Hydrogen Partnership) under grant agreement No 875155. This Joint Undertaking receives support from the European Union's Horizon 2020 Research and Innovation program, Hydrogen Europe and Hydrogen Europe Research.





## Performance Assessment and Spectroscopic Studies of Solid Oxide Fuel Cells Operating With CO<sub>2</sub>-Rich Oxidizing Streams for an Innovative Hybrid Power Cycle

M. Pagliari<sup>a</sup>, D. Montinaro<sup>b</sup>, E. Martelli<sup>a</sup>, S. Campanari<sup>a</sup>, A. Donazzi<sup>a\*</sup>

\* corresponding author: [alessandro.donazzi@polimi.it](mailto:alessandro.donazzi@polimi.it)

<sup>a</sup> Politecnico di Milano, Milan, Italy

<sup>b</sup> SolydEra SpA, Mezzolombardo, Italy

*Keywords: carbon dioxide, power generation, Solid Oxide Fuel Cells*

### Abstract

In an innovative hybrid cycle (SOS-CO<sub>2</sub> cycle) the SOFC cathode is fed with high concentrations of carbon dioxide. Long-term tests on applicative size SOFCs with this unconventional oxidant stream showed a lower the power output when supplying CO<sub>2</sub>. The performance remained stable in time and was completely reversible. Spectroscopic characterization of the cathodic material does not suggest any degradation phenomenon induced by the exposure to CO<sub>2</sub>.

**Introduction:** In the energy transition framework, power production systems which integrate Solid Oxide Fuel Cells (SOFCs) can provide high electric efficiencies and low carbon emissions. The SOS-CO<sub>2</sub> cycle [1], a novel blue power technology, couples a semi-closed regenerative intercooled Brayton cycle with a CO<sub>2</sub> capture system and a SOFC unit. In this innovative application, the fuel side of the cell is fed with a reformat feed, while the oxidant stream is a mixture of O<sub>2</sub> and CO<sub>2</sub> with unusually high fraction. The SOFC performance and the durability of cathodic materials under CO<sub>2</sub>-rich conditions requires careful evaluation.

**Objectives:** The objective of this work is to assess at single-cell level the performances and the long-term stability of commercial-sized SOFCs under the conditions required by the SOS-CO<sub>2</sub> technology. Special attention is dedicated to the interaction between the peculiar CO<sub>2</sub>-rich oxidizing stream and the cathodic materials of the cells.

**Material and methods:** 5x5 cm<sup>2</sup> anode-supported cells (SolydEra) featured a LSCF-GDC cathode (La<sub>0.6</sub>Sr<sub>0.4</sub>Co<sub>0.2</sub>Fe<sub>0.8</sub>O<sub>3</sub> - Ce<sub>0.9</sub>Gd<sub>0.1</sub>O<sub>1.95</sub>), coated by LSC (La<sub>0.6</sub>Sr<sub>0.4</sub>CoO<sub>3</sub>). Performance and durability tests were conducted with a Horiba – FuelCon C50 Evaluator test station. Experiments were performed at 700°C, collecting polarization (I/V) and Electrochemical Impedance Spectroscopy (EIS) curves. The SOFC was characterized post-mortem with XRD, SEM, IR ATR and Raman spectroscopies. Further insights were obtained with EIS tests on symmetric cells and characterization of LSCF powders.

**Results:** Tests on applicative-size cells with 7% humidified H<sub>2</sub> and the O<sub>2</sub>/CO<sub>2</sub> mixture highlighted an initial 26% power loss compared to the base case with air. Deconvolution of impedance spectra using the Distribution of Relaxation Times (DRT) revealed that the CO<sub>2</sub> supply affected the peaks between 10 Hz and 1 kHz. CO<sub>2</sub>-rich feed conditions were maintained for over 350 h under constant voltage (0.85 V). The power output remained stable and periodic I/V curves and EIS spectra did not suggest any degradation of the cell (Figure 10). Complete reversibility was observed when feeding air to the cathode, suggesting that CO<sub>2</sub> exerts exclusively a kinetic effect. This was further investigated with symmetric cell testing. LSCF powders were aged at 700°C for 175 h supplying the same CO<sub>2</sub>-rich gas feed. Ex-situ analyses of the aged SOFC and powder samples did not highlight neither the formation of secondary phases on the perovskite surface nor permanent modifications in the lattice caused by the exposure to CO<sub>2</sub>.

**Conclusions:** Long term testing and material characterization support the feasibility of operating the SOFC under CO<sub>2</sub>-rich cathodic supply for its integration in the SOS-CO<sub>2</sub> technology.

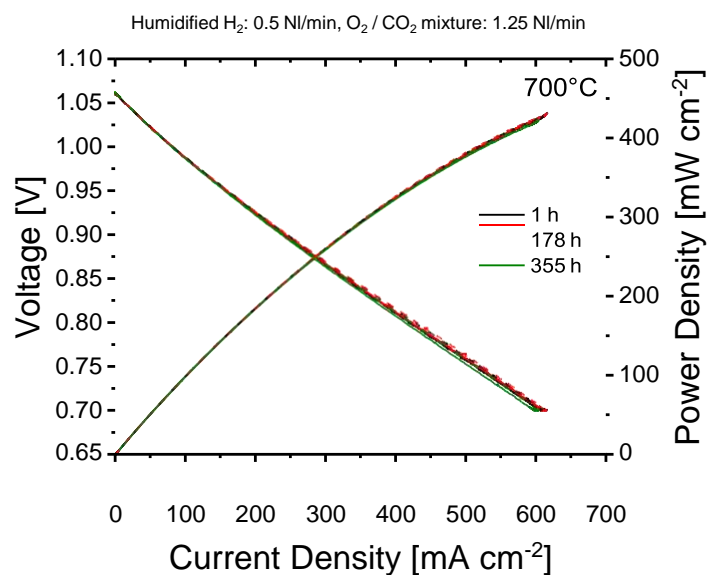

**Figure 10** - I/V curves of industrial SOFC over 355 h of O<sub>2</sub> / CO<sub>2</sub> mixture supply.

## References

[1] Scaccabarozzi, R. et al. *Applied Energy* **2021**, 290, 116711.

## Development of an air-independent 8kW-large area fuel cell stack, manufacturing issues and influence of oxygen concentration on electrochemical performances

O.Barbera<sup>\*a</sup>, L. Andoloro<sup>a</sup>, A.Di Blasi<sup>a</sup>, N. Briguglio<sup>a</sup>, G.Dispenza<sup>a</sup>, G. Brunaccini<sup>a</sup>, A. Dellacasa<sup>b</sup>, G.Giacoppo<sup>a</sup>.

<sup>\*</sup>corresponding author: Orazio Barbera

<sup>a</sup> Consiglio Nazionale delle Ricerche, Istituto di Tecnologi Avanzate per l'Enrgia "N. Giordano" (CNR-ITAE),  
Messina/Italy

<sup>b</sup>Fincantieri s.p.a. Genova/Italy

*Keywords: fuel cell stack, hydrogen conversion, pure oxygen, fuel cell stack design*

This work illustrates the design, manufacturing and testing of a large-area 48-cells fuel cell stack with a rated power of 8 kW. In particular, the effect of different oxygen concentrations on performance was investigated. Moreover, issues related to the dimensional tolerances in MEA manufacturing are highlighted to demonstrate how they can negatively affect the ability of the stack's operation due to the gases' crossover.

### Introduction

Environmental concerns and diminishing fossil fuel reserves are generating demand for new energy conversion technologies that can provide improved or alternative methods of energy conversion and power generation. Polymer electrolyte membrane fuel cells (PEFC) are widely regarded as alternative stationary and mobile power sources with potentially zero or minimal environmental impact. [1]. Very less studies have been found on the effect of oxygen concentration on the performance of PEFC, especially in large-area and high cell number stacks [2]. Furthermore, there is no information in the literature on the quality required for the engineering of active components, such as the membrane electrode assembly. This work depicts the influence of various oxygen flow rates on the performance of a PEFC stack of 246 cm<sup>2</sup> active area and 48 cells. In addition, the unfavourable effects on stack operation due to non-compliance with the tolerances in the MEA construction are investigated, and the adopted mitigation strategy is illustrated.

### Objectives

The objective of the research work was to intend how the oxygen concentration affects the stack performances and to increase and disseminate the knowledge on large-area fuel cell stack design, manufacturing and assembly.

### Methodology

The calculation of the electrical parameters of the PEFC stack started from the power and efficiency requirements (3.5 kW rated power, 60%). In addition, operative pressure was set to 3 bar<sub>abs</sub>. This value, as experienced in [3], was considered the best compromise between performance, mechanical stresses and gasket sealing issues. The stack voltage was set at 36 V. The fuel cell stack had these characteristics: power 3.5 kW, voltage 36 V, single cell voltage 0,76 V, active area 246 cm<sup>2</sup>, cell number 48. Fuel cell tack was designed using an in-house developed design methodology [3-5] and manufactured (Fig.1). Composite graphite was used for bipolar plates, steel for clamping plates, copper for current collectors, and Teflon for gaskets.

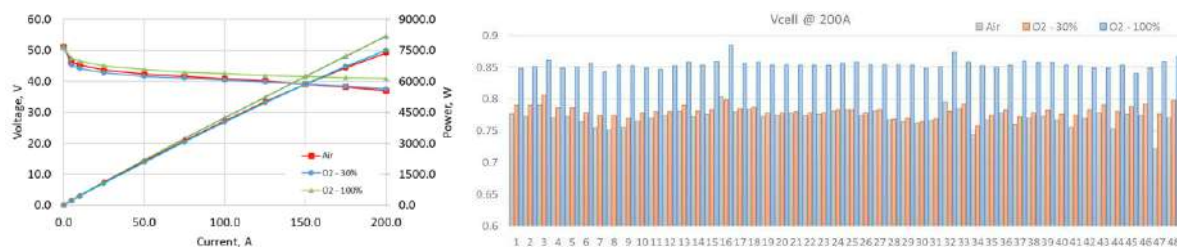

**Fig.1:** Virtual assembly of the stack (left), manufactured stack on the test bench (centre), gasket design modification (right)

As can be seen in Fig. 1 (right), between the Gas Diffusion Layer (GDL, Sigracet 29 BC, dark in colour) and the gasket (white) there was an empty area which was not covered by either the GDL or the gasket. This area prevented the graphite elements from correctly transmitting clamping pressure, resulting in an unloaded band approximately 1-1.5 mm wide, sufficient to short the reagent and coolant manifolds and cause unacceptable internal fluids' cross-over. The design of the gasket was modified, reducing the open-area dimensions which accommodate the GDL to cancel the distance between these two parts. This has made to reduce to acceptable levels the internal cross-over.

## Results

Fig. 2 shows the trend of the I-V curves as the oxygen concentration. The polarization curves were recorded in Air and with N<sub>2</sub>/O<sub>2</sub> mixtures at 30% and 100% oxygen respectively. The stack can operate correctly with Air and pure oxygen at the cathode. Stack performance improves as the oxygen concentration at the cathode increases. The fuel cell stack achieved a maximum current of 200 A (813 mA/cm<sup>2</sup>) at 41 V, corresponding to a power of 8192 W. By using pure oxygen performance improves by about 10% at 200 A. In addition, as Fig 2 (right) shows, an increase in oxygen concentration improves the uniformity of single-cell voltage distribution.



**Fig.2:** Polarization curves recorded with different oxygen concentrations (left), single cell voltage distribution (right)

## Conclusions

A 246 cm<sup>2</sup>-active area 48-cell PEFC stack was designed, manufactured and tested with different oxygen concentrations. Tolerance issues in the MEA design were successfully overcome by modifying the gasket design, and the importance of accuracy in MEA manufacturing was highlighted. The maximum power of 8.2 kW was achieved at 200 A with a good distribution of the single-cell voltage and a 10% stack performance improvement using pure oxygen.

## Acknowledgement

Authors gratefully acknowledge funding from the FINCANTIERI s.p.a. under grant agreement PON MISE – Bando “Industria Sostenibile” PON I&C 2014-2020, di cui al D.M. 1 Giugno 2016 – Prog n. F/090041/01-02/X36 “TecBIA”

## References

- [1]. G. Karimi<sup>1</sup>, Xianguo Li, Analysis and modeling of PEM fuel cell stack performance: Effect of in situ reverse water gas shift reaction and oxygen bleeding, *Journal of Power Sources* 159 (2006) 943–950,
- [2]. Rohan Kumar, K.A. Subramanian, Enhancement of efficiency and power output of hydrogen fuelled proton exchange membrane (PEM) fuel cell using oxygen enriched air, *International journal of hydrogen energy* 48 (2023) 6067 -6075
- [3]. Giacoppo G., Hovland S., Barbera O., 2 kW Modular PEM fuel cell stack for space applications: Development and test for operation under relevant conditions, *Applied Energy* (2019) 1683-1696.
- [4]. Squadrito G., Giacoppo G., Barbera O., Urbani F., Passalacqua E., Borello L., Musso A., Rosso I., Design and development of a 7kW polymer electrolyte membrane fuel cell stack for UPS application, *International Journal of Hydrogen Energy* 35 (2010) 9983 – 9989
- [5]. Barbera O., Stassi A., Sebastian D., Bonde J.L., Giacoppo G., D'Urso C., Baglio V., Aricò A.S. , Simple and functional direct methanol fuel cell stack designs for application in portable and auxiliary power units, *International Journal of Hydrogen Energy* (2016) 12320-12329



## Performance Evaluation of two SOFC Stack Technologies Operated under CHP System Relevant Conditions: Replicability Study

Francesco Marino<sup>a,b</sup> \*, Francesca Santoni<sup>a</sup>, Andrea Monforti Ferrario<sup>a</sup>, Michał Wierzbicki<sup>c,d</sup>, Piotr Ostrowski<sup>c,d</sup>, Viviana Cigolotti<sup>a</sup>, Elio Jannelli<sup>b</sup>

\* corresponding author: francesco.marino005@studenti.uniparthenope.it

<sup>a</sup> Department of Energy Technologies and Renewable Sources, Laboratory of Energy Storage, Batteries and Hydrogen Production and Use (TERIN-PSU-ABI), ENEA Italian National Agency for Energy, New Technologies and Sustainable Economic Development, C.R. Casaccia, Rome, Italy;

<sup>b</sup> Department of Engineering, Università degli Studi di Napoli Parthenope, Napoli, Italy;

<sup>c</sup> Institute of Power Engineering, Warsaw, Poland

<sup>d</sup> Center for Hydrogen Technologies (CTH2), Institute of Power Engineering, Warsaw, Poland

### Introduction:

The rush towards carbon neutrality is having a significant impact on the path undertaken by research, when it comes to renovating the world energy paradigm. Currently the potential of hydrogen, widely considered as one of the key factors for such purpose, is leading to an increasing interest on the fuel cell technology. Amongst all, Solid Oxide Fuel Cells (SOFCs) are undergoing a significant development and are starting to be used in a variety of applications.

The main advantage related to this technology is the ability to operate efficiently with a wide inlet fuel composition range: this makes them extremely suitable and attractive for Combined Heat and Power (CHP) applications.

### Objectives and Methods:

In this work the activities conducted in the framework of the European Project “SO-FREE” are presented. An experimental campaign was carefully planned and carried out with two different short-stacks:

- 15 cell planar Anode Supported Cell (ASC) SOFC short-stack.
- 10 cell planar Electrolyte Supported Cell (ESC) SOFC short-stack.

For data reliability both stack configuration were tested by two different Research Centres (ENEA and IEN). The main purpose was to evaluate the performances of today’s commercial SOFC technology when fed by a wide range of fuels (natural gas, hydrogen and blends) at conditions expected at system operation level. Various case studies for gas grid scenarios were evaluated (including current condition and grid transition into a 100% hydrogen network). The experimental campaign covers stack testing at different gas mixture, temperatures, fuel utilization factor (FU), partial and full load operation.

The same testing protocol has been employed, for each short-stack, both by the manufacturer and by the two testing partners, in order to evaluate its electrochemical and energy outputs by means of IV curves and in stable operating points. The quality and reliability of the campaign results was proven through a comparison of the data obtained by the two testing partners involved and performances expected by the stack manufacturers.

### Results and Conclusion:

Each short-stack has been successfully tested at both facilities. The outcomes achieved on stack voltage, power and efficiency line up in every condition evaluated, deviating from each other (and from the data provided by the respective manufacturer) by **less than 5%** for all studied cases.

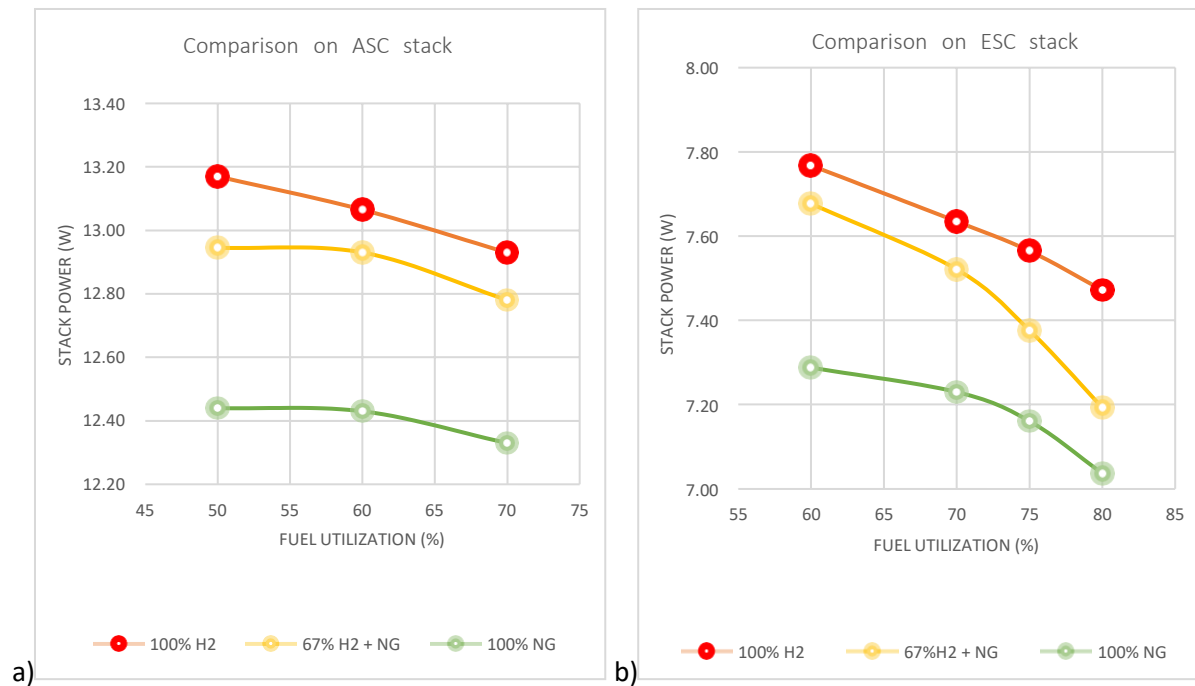

Figure 1: Performance maps obtained at ENEA on both stacks tested, with relative stack efficiency; ASC stack (a) and ESC (b);

A graphical summary of the results obtained at ENEA is reported in Figure 1, and a brief description of the performance trends is provided in the following bullet points:

- High variation with increasing FU for reformate compositions;
- Challenging operation at low temperature and high FU (especially with reformate gas compositions);
- Similar performance between high temperature ranges (710-660°C and 835-850°C for anode supported and electrolyte supported cell design respectively) but significant performance drops at lower temperatures (640°C and 780°C for anode supported and electrolyte supported cell design respectively); 10-20 W loss;
- Power output 100%H<sub>2</sub>>67%H<sub>2</sub>+NG>100%NG – stack-level efficiency analysis to be performed;
- Complete CH<sub>4</sub> conversion in reformate conditions in gas analysis under load for the electrolyte supported cell stack, favored by higher nominal operating temperature (850°C vs. 660°C).



## Fabrication and Characterization of Planar Electrolyte-Supported SOFCs Made By Tape Casting and Spraying Techniques

C. Montes, A. Pardo, M. Martínez de Sarasa Buchaca, E. Nieto, \*R. Campana.

\* corresponding author

### INTRODUCTION

During the last years, solid oxide fuel cells (SOFC) have emerged as a green and efficient technology to convert the chemical energy of hydrogen and other fuels, into electricity and heat [1]. SOFC are developed employing ceramic materials and operate between 600 and 1000°C, at which the electronic and electric properties of these materials exhibit their best behavior.

Planar SOFC supports are usually manufactured by tape casting, which allows the fabrication of large-surface, thin ceramic tapes with controlled morphologies. As for the coatings, wet powder spraying (WPS) is suitable for different geometries and applicable in large-area ceramic layers.

Owing to its excellent mechanical and chemical stability in oxidizing and reducing environment and high ionic conductivity, 8 mol% Y<sub>2</sub>O<sub>3</sub> stabilized ZrO<sub>2</sub> (YSZ) is the most used electrolyte. Ni-YSZ cermet fulfills most of the requirements of an ideal anode, due to the high catalytic activity of nickel for hydrogen oxidation and its thermal expansion coefficient (TEC), close to YSZ one, which assures a good adherence. Concerning the cathode, perovskite materials such as La<sub>0.6</sub>Sr<sub>0.4</sub>FeO<sub>3</sub> (LSF) or La<sub>0.8</sub>Sr<sub>0.2</sub>MnO<sub>3</sub> (LSM) are widely used since they show a good oxygen reduction catalytic activity. In order to prevent the formation of poorly conducting secondary phases, such as La<sub>2</sub>Zr<sub>2</sub>O<sub>7</sub> or SrZrO<sub>3</sub>, the use of protective barriers like gadolinium doped ceria (GDC) between the cathode and electrolyte is commonly used.

This work describes the fabrication and characterization of electrolyte-supported SOFCs by tape casting and WPS layer deposition.

### RESULTS AND DISCUSSION

#### A. Development of cells

Electrolyte-supported cells synthesized in this work consist of a dense electrolyte of YSZ, a porous anode made by Ni-YSZ, a diffusion barrier interlayer of GDC and a porous cathode of LSM.

For the fabrication of the YSZ tapes, different formulations were prepared until the amount of binder (B-1000) and dispersant (D-3005) were optimized in the slurry. After dryness, 180 µm thick green tapes were obtained (Figure 1a). The sintering process was performed at 1400 °C, obtaining highly dense tapes with suitable microstructure. The deposition of the electrode layers was carried out using an Iwata Eclipse HP-BCS airbrush. The starting powders were suspended in 2-propanol and dispersed using D-3005, and graphite was added as external pore former for the anode NiO-YSZ formulation. The different layers were sintered at 1050 °C, 1050 °C and 1350 °C

for 2 h, for GDC, LSM and NiO-YSZ respectively. In this way, cells with a thickness of 200  $\mu\text{m}$  and different diameters have been developed (Figure 1b).

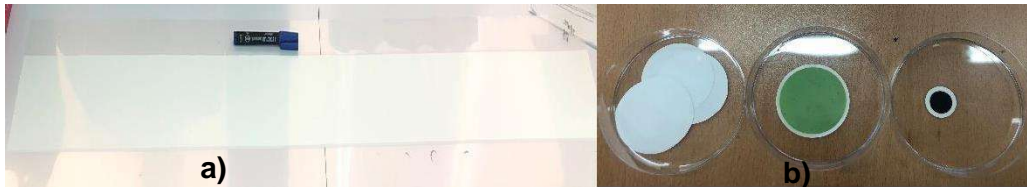

Fig. 1. Photographs of (a) the top view of the green tape and (b) sintered cells.

### B. Electrochemical Characterization

Current-voltage and current-density characteristics of a model cell at 850  $^{\circ}\text{C}$ , 800  $^{\circ}\text{C}$  and 750  $^{\circ}\text{C}$  are shown in Figure 2a.

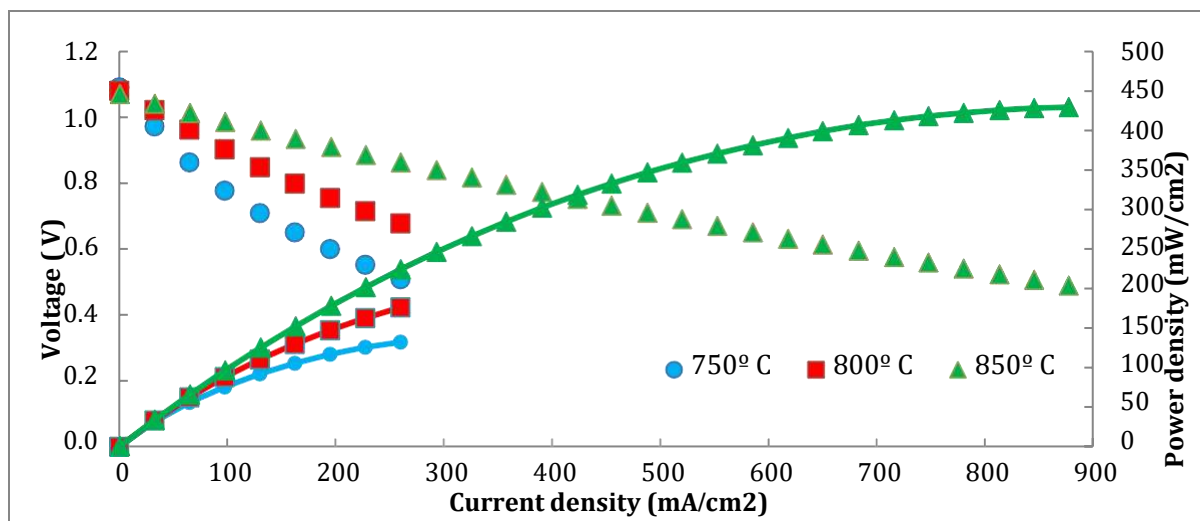

Fig. 2. I-V and I-P curves at 850  $^{\circ}\text{C}$ , 800  $^{\circ}\text{C}$ , 750  $^{\circ}\text{C}$  of a model cell.

### CONCLUSION

In this work, different SOFC cells have been prepared and characterized. The experimental study shows good electrochemical performances. Currently, a long-term degradation study is being performed to evaluate the efficiency of the cells.

### REFERENCES

M. Singh, D. Zappa, E. Comini (2021). Solid oxide fuel cell: Decade of progress, future perspectives and challenges, *International Journal of Hydrogen Energy* 46(54), 27643-27674.





## Environmental Impacts on PEM-Fuel Cells in Maritime Application

Dr. Nils Baumann\*<sup>a</sup>, Roberto Di Stefano<sup>a</sup>, Michael Hanß<sup>a</sup>, Thomas Wannemacher<sup>a</sup>

\* corresponding author: [n.baumann@proton-motor.de](mailto:n.baumann@proton-motor.de)

<sup>a</sup> Proton Motor Fuel Cell GmbH, Benzstr. 7, 82178 Puchheim, Germany

*Keywords: LT-PEM Fuel Cells, Inclination, Salt Spray, Water Management*

**Introduction:** Fuel cells have emerged as a promising technology with significant potential to transform the maritime industry. By generating electricity through a chemical reaction between hydrogen and oxygen, fuel cells offer several advantages. They provide clean and efficient power, reducing greenhouse gas emissions and improving air quality. Overall, fuel cells have the potential to revolutionise the maritime environment by providing sustainable power solutions. This research was carried out as part of the EU-funded project "e-SHYIPS".

**Objectives:** LT-PEM Fuel cells in maritime environments are exposed to significantly different environmental conditions than most land-based applications. Here we present results of laboratory tests of two environmental impact factors in maritime applications, inclination of the fuel cell stack as might happen during normal ship movement due to wave motion, as well as salt contamination on the air side, due to salt spray. These experiments are critical to understand the effects of maritime environments on fuel cells and to be able to take appropriate measures to prevent damage or lifetime reduction.

**Material and methods:** 1.) Inclination Tests: A Proton Motor full stack (36 kW) was mounted in a lying position (all media connections on the stack point towards the front) on a specially adapted test rig and inclined in two perpendicular axes with an angle of 23° (example seen in figure 1). A total of 9 positions were tested – no inclination, inclination to either side and corresponding combinations. In each position a performance curve was recorded as well as



continuous operation for 20 min at maximum power point. After each test the stack was brought back to the same reference point.

*Figure 1: Stack at inclination towards the back and left.*

2.) Salt Spray Tests: Test series was conducted on short stack with 5 cells. Defined amounts of 3.8 wt.-% NaCl solution were injected into the air feed directly before the

stack. After each contamination step a performance curve was recorded, as well as continuous operation at maximum and intermediate power point. After several contamination cycles, a final reconditioning of the stack was performed with humidified air (100% r.H.).

**Results and Discussions:** 1.) Inclination of stack with media outlets positioned upwards always leads to a decrease of performance. Additionally, the difference between lowest individual cell potential to average cell potential increased. Moreover, the purge interval on the anode side had to be shortened to maintain stable performance. All points are a measure of hindered water removal. The difference in cell voltage was 2 – 15 mV, corresponding to a total power loss of 0.8 kW. Even though the stack performance was worse compared to level operation, it was still constant during the 20 min operating time and did not decrease further. Stable fuel cell operation must be ensured with appropriate mounting position of the stack, or if that is not possible, with adjusted operating parameters.

2.) Contamination of the stack air feed with salt spray led to ongoing loss of cell potential at constant current, resulting in a voltage drop of 10 to 30 mV in the worst case. Additionally, the cell potential homogeneity decreased significantly, leading to instable stack operation. Final reconditioning of the stack was sufficient to regenerate the stack performance to near initial performance. Measurement of electrical conductivity of product water showed that a high salt concentration can only be seen after several contamination steps, indicating a certain level of absorption of salt ions inside the stack. It can also be seen that the conductivity decreased again after the final reconditioning process, corroborating the assumption that salt

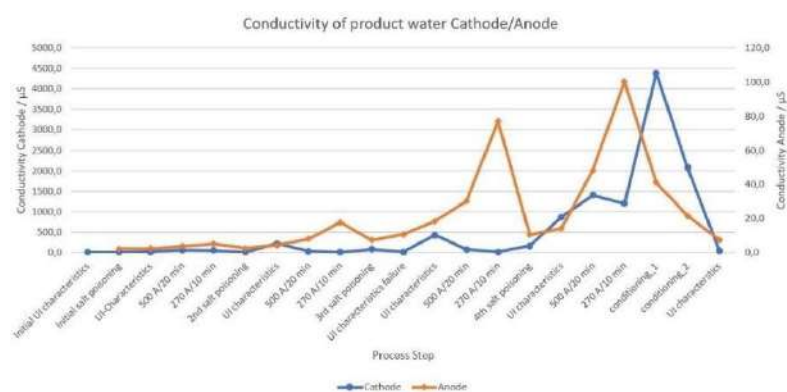

can be flushed out with humidified air stream. A high conductivity (i.e., salt concentration) is also observed on the anode side. This can be explained by a crossover of salt from the cathode side inside the stack.

Figure 2: Product water conductivity of cathode (blue) and anode (red) during test series.

### Acknowledgment

“The e-SHyIPS project has received funding from the Fuel Cells and Hydrogen 2 Joint Undertaking (now Clean Hydrogen Partnership) under Grant Agreement No 101007226. This Joint Undertaking receives support from the European Union’s Horizon 2020 Research and Innovation programme, Hydrogen Europe and Hydrogen Europe Research”.



## CapLab: Electrochemical Cells

M. Archetti<sup>a</sup>, F. Bianchi<sup>b</sup>, B. Bosio<sup>b</sup>, D. Bove<sup>a\*</sup>, I. Capestro<sup>a</sup>, L. Cardona<sup>b</sup>, R. Risso<sup>b</sup>

\* corresponding author: [ing.dariobove@gmail.com](mailto:ing.dariobove@gmail.com)

<sup>a</sup> Ecospray Technologies S.R.L., Alzano Scrivia (AL), Italy

<sup>b</sup> Department of Civil, Chemical and Environmental Engineering, University of Genova, Via Opera Pia 15, 16145 Genova, Italy

Keywords: Carbon Capture, Decarbonization, Electrochemical Cells, MCFC, Experimentation.

### Abstract

Molten Carbonate Fuel Cell (MCFC) is a promising technology in terms of Carbon Capture (CC). The main difference between this technology and the other CC techniques, such as the conventional amine method, is that MCFCs can produce additional energy during the capture. In addition, MCFCs can also efficiently separate CO<sub>2</sub> also from exhausts having very low CO<sub>2</sub> concentration. For these reasons, the establishment of the new CAPLAB laboratory dedicated to MCFCs for CC signifies a commitment to advancing CC technologies, underscoring the importance of collaboration and innovation in tackling global energy and environmental challenges.

### Introduction:

Nowadays, various industries, including coal-fired and natural gas-fired power generation, steel, cement, and shipping, are under pressure to reduce their CO<sub>2</sub> emissions [1-3]. One promising solution is MCFC technology, which captures CO<sub>2</sub> while generating electricity, making it cost-effective. The future market for this technology is difficult to quantify, but major investing countries include Japan, the United States, Southeast Asia, and Europe. To advance research and development in Molten Carbon Fuel Cells for carbon capture, the cutting-edge CAPLAB has been established as a joint venture between UNIGE and Ecospray. Located in a specialized research environment, CAPLAB facilitates advanced studies and experimentation for MCFC design, optimization, and application in carbon capture scenarios.

### State-of-the-Art Instrumentation:

The laboratory is equipped with a wide range of instruments to enable characterization of MCFCs. Key instruments present in the laboratory refers to two main sections:

Testing: the laboratory houses small-scale MCFC facilities that can be used to perform tests and experiments using different feeding gases, monitoring electrical current, voltage and temperature, performing Electrochemical Impedance Spectroscopy, checking outlet gases by gas chromatography. This enables researchers to evaluate new materials, component design, and thermal management strategies specific to carbon capture applications.

Manufacturing: the laboratory offers precision mixing and coating machines, equipment such as tape casting and screen printing, furnaces and several auxiliaries. In addition, sophisticated testing



and characterization instruments like a porosimeter allow the quality analysis of the fabricated MCFC components.

#### **Research Objectives:**

The CAPLAB aims to address several key aspects related to MCFCs in CC, including:

**Advanced Material Development:** Researchers will focus on the synthesis and characterization of innovative materials and innovative fabrication processes for MCFC components. Exploring new chemical compositions, new techniques, and physical properties will be essential to improve the efficiency, stability, and the scalability at industrial level of the fuel cells.

**Performance Optimization:** Through in-depth studies and experimentation, the laboratory seeks to optimize the performance of MCFCs maximising CO<sub>2</sub> capture ability as well as energy conversion efficiency in carbon capture applications. This includes specific stack engineering and operating condition optimization.

#### **Collaborations and Partnerships:**

The MCFC laboratory will actively promote collaboration with other research institutions, universities, and companies to facilitate knowledge exchange, resource sharing, and expedited development of fuel cell technologies. Workshops, conferences, and joint projects will be organized to foster effective collaboration among industry experts.

#### **Conclusion:**

The inauguration of the CAPLAB dedicated to MCFCs for CC applications represents a significant step forward in advancing clean and efficient energy technologies and aims to promote widespread adoption of MCFCs, contributing to the transition to a sustainable energy future with a specific focus on carbon capture.

#### **References:**

- [1] R. Cooper, D. Bove, E. Audasso, M.C. Ferrari, B. Bosio, A feasibility assessment of a retrofit Molten Carbonate Fuel Cell coal-fired plant for flue gas CO<sub>2</sub> segregation, *Int. J. Hydrog. Energy* 46 (2021) 15024-15031
- [2] M. Spinelli, D. Di Bona, M. Gatti, E. Martelli, F. Viganò, and S. Consonni, Assessing the potential of molten carbonate fuel cell-based schemes for carbon capture in natural gas-fired combined cycle power plants, *J Power Sources* 448 (2020) 227223
- [3] M. Spinelli, M. C. Romano, S. Consonni, S. Campanari, M. Marchi, and G. Cinti, Application of molten carbonate fuel cells in cement plants for CO<sub>2</sub> capture and clean power generation, *Energy Procedia* 63 (2014) 6517–6526



## Development of matrices for Molten Carbonate Fuel Cells

L. Cardona<sup>a</sup>, D. Bove<sup>a,b,\*</sup>, R. Risso<sup>a</sup>, J. F. Basbus<sup>a</sup>, M. Archetti<sup>b</sup>, B. Bosio<sup>a</sup>

\* corresponding author: [dario.bove@unige.it](mailto:dario.bove@unige.it)

<sup>a</sup> *Department of Civil, Chemical and Environmental Engineering, University of Genova, Via Opera Pia 15, 16145 Genova, Italy*

<sup>b</sup> *Ecospray Technologies S.R.L., Alzano Scrivia (AL), Italy*

*Keywords: Molten Carbonate Fuel Cells, electrolyte matrix, experimental synthesis and characterisation*

### **Abstract**

One of the key drivers of today's industry is the need for the reduction of carbon emissions, one way this can be archived is through carbon capture (CC). Amongst the most interesting new technologies, the Molten Carbonate Fuel Cells (MCFC) are very interesting for the possibility of providing electric current whilst doing CC. MCFC main components are the two electrodes and the ceramic matrix where the electrolyte is stored. This matrix is getting a lot of attention because of its multiple function: electron insulation, gas barrier between anode and cathode and support for the molten electrolytes. The aim of this work was to study different production techniques and understand which parameters have an impact on the matrix functioning.

### **Introduction:**

Molten carbonate fuel cells (MCFC) are of high interest today, for their capability to both provide electricity while also being able to provide CCS from low CO<sub>2</sub> concentration streams. To do this the cell needs high temperatures of around 650°C where the carbonates, that are used as electrolyte for the cell, melt and are therefore able to be used as ionic charge carriers. Such as electrolyte fills the ceramic matrix which must guarantee high stability, mechanical resistance, as well as insulation for electrons and gases. Matrix state-of-the-art consists of inert lithium aluminate (LiAlO<sub>2</sub>) as  $\alpha$ - and  $\gamma$ - phase depending on working conditions. Matrix state-of-the-art consists of inert lithium aluminate (LiAlO<sub>2</sub>). It is produced usually by tape casting with organic solvents and can include reinforcement agents to optimise porosity (>50 %), pore size (< 1  $\mu$ m), specific surface area (> 10 m<sup>2</sup>/g), and mechanical strength (> 100 gf/mm<sup>2</sup>) [1].



### **Objectives:**

Starting from recipes coming from the Korean Institute of Science and Technology [2], Fuel Cell Poland [3] and the Institut de recherche de Chimie Paris [4] that use different materials, additives and production steps, the aim was to analyse and compare the proprieties of these matrixes after solvent evaporation and material sintering, simulating the working conditions of the MCFC cell.

### **Material and methods:**

The studied recipes are based on traditional  $\text{LiAlO}_2$ , where the main differences are in the dispersing agents, antifoam agents and solvents used, that differ in quantity and type. Despite different details, the main production steps can be summarised as: a first ball mixing phase of the main raw materials, then the addition of plasticising agents, followed by a second mixing step, afterward the mixture degassing, followed by tape casting and in the end drying. To allow for uniform comparison, the matrixes were prepared following the same procedure rules at the CapLab, a joint venture laboratory between the University of Genoa and the company Ecospray Technologies. The SEM was used for a visual analysis, while XRD was used to identify the crystalline phase. Further tests will include porosity analysis using a mercury porosimeter, while typical resistance test will be made to evaluate the mechanical strength.

### **Results and conclusions:**

All the results will be presented and discussed, showing the validity of the used recipes, allowing for a validation of the literature data and giving a good insight in which aspects could be targeted for further improvement. As far as some future advances go, these could be targeted towards the heightening of the mechanical strength, as the durability of the matrix is still a main concern for the cell lifetime.

### **References**

- [1] A. Sheikh, F. Bianchi, D. Bove, B. Bosio, "A review on MCFC matrix: state-of-the-art, degradation mechanisms and technological improvements", to be submitted.
- [2] J. Kim, J. Han, S. Yoon, S. Nam, T. Lim, H. Kim, "Mechanical properties of the lithium aluminate matrix for MCFC reinforced with metal oxide materials", Current Applied Physics, Volume 10, Issue 2, Supplement, 2010.
- [3] Baron R, Wejrzanowski T, Milewski J, Szablowski L, Szczesniak A, Fung K Z. Manufacturing of  $\text{LiAlO}_2$  matrix for molten carbonate fuel cell by high energy milling. Int J Hydrogen Energy 2018.
- [4] PhD thesis, Ersan Gürbüz, PSL Research University, Chimie ParisTech, Institut de recherche de Chimie Paris, IRCP.



## A Unitized Reversible Fuel Cell For In Operando Sxas and Xas Analysis for Fuel Cells and Electrolyzers

Bogar M.<sup>\*a</sup>, Yakovlev Yurii<sup>b</sup>, Pollastri S.<sup>c,d</sup>, Heinz Amenitsch<sup>e</sup>, Roberto Biagi<sup>b</sup>, Rodolfo Taccani<sup>a</sup>, Iva Matolínová<sup>b</sup>

\* corresponding author: marco.bogar@dia.units.it

<sup>a</sup> Department of Engineering and Architecture, University of Trieste, Via Alfonso Valerio 6/1, 34127 Trieste, Italy.

<sup>b</sup> Faculty of Mathematics and Physics, Charles University, Prague, Czech Republic.

<sup>c</sup> Department of Physics, Computer Science and Mathematics, University of Modena and Reggio Emilia, Via Campi 103, 41125 Modena, Italy.

<sup>d</sup> Elettra - Sincrotrone Trieste S.C.p.A., SS 14 - km 163,5, 34149, Basovizza, Trieste, Italy.

<sup>e</sup> Graz University of Technology, Institute for Inorganic Chemistry, Stremayrgasse 9, 8010 Graz, Austria.

*Keywords: in-operando degradation, SAXS, XAS, PEM fuel cells and electrolyzers*

### Abstract

**Introduction:** Producing efficient and cost-effective fuel cell systems and water electrolyzers is then fundamental for promoting the spread of green hydrogen generation and use. In this scenario, fuel cell technology remarkably improved in the last decades, promoting Proton Exchange Membrane Fuel Cells (PEMFCs) use in the automotive and in transportation sectors. Nonetheless, the complex architecture of fuel cells and electrolyzers, still slows down the research and development required for improving their efficiency and lifetime, and contemporary reducing their production costs, which are still strongly bounded to the cost of catalyst materials[1]. Important achievements in optimizing fuel cell architecture and/or catalyst loading, were obtained thanks to analysis carried out in-operando analysis carried out at synchrotron radiation facilities, where important insights about fuel cell operation and degradation were revealed. In particular, Small Angle X-Ray Scattering (SAXS) is suitable for revealing catalyst morphological evolution [2], while X-Ray Absorption Spectroscopy (XAS) allows to depict reaction kinetics [3] and to quantify the degree of catalyst oxidation [4].

**Objectives:** The aim of this work consisted in developing an electrochemical cell able to operate as reversible unified electrochemical cell (RUEC), optimized for studying chemical and morphological evolution of catalyst materials designed for PEMFCs, for PEM Water Electrolyzers (PEMWEs), and for RUECs to be studied by combining electrochemical characterization with SAXS and XAS.

**Material and methods:** Two different Membrane Electrode Assemblies (MEAs) for PEMFCs, loaded with commercial catalyst materials composed by Pt and Pt<sub>3</sub>Co nanoparticles were



characterized in pristine conditions at first; then catalyst evolution undergoing break-in procedure and subjected to Accelerated Stress Tests (AST) were monitored by means of in operando XAS and in operando SAXS. The analysis was then repeated on a commercial Ir/Pt catalyst for a PEMWE. All of the results were complemented with electrochemical analysis (cyclic voltammetry and impedance spectroscopy).

**Results:** Concerning the in-operando investigation of the Pt-loaded-MEA for PEMFCs, most of the reduction of the catalyst electro-activity of Pt was observed within the first 2000 cycles, in agreement with results from electrochemical data and with the recorded evolution of the particle size distribution, where an increase in particle size and agglomeration were revealed. When the Pt<sub>3</sub>Co-loaded-MEA for PEMFCs was analysed, most of the chemical evolution was detected during the break-in procedure, and a less pronounced coarsening was detected when running AST.

**Conclusions:** This work confirmed the effectiveness of properly designed electrochemical cell was demonstrated being able to reliably measure and combine electrochemical data, XAS spectra, and SAXS patterns, allowing to perform a comprehensive and deep characterization of catalyst performance undergoing the different operational regimes of PEMFCs and PEMWEs. Additionally, this work defines a benchmark for future studies of novel catalyst materials for either PEMFCs and PEMWEs.

### Acknowledgment

All of the authors acknowledge the CERIC-ERIC Consortium for the access to experimental facilities and the financial support.

### References

- [1] Y. Wang, D. F. Ruiz Diaz, K. S. Chen, Z. Wang, and X. C. Adroher, "Materials, technological status, and fundamentals of PEM fuel cells – A review," *Mater. Today*, vol. 32, no. February, pp. 178–203, 2020, doi: 10.1016/j.mattod.2019.06.005.
- [2] I. Martens, R. Chattot, and J. Drnec, "Decoupling catalyst aggregation, ripening, and coalescence processes inside operating fuel cells," *J. Power Sources*, vol. 521, p. 230851, Feb. 2022, doi: 10.1016/j.jpowsour.2021.230851.
- [3] N. Ishiguro and M. Tada, "Structural Kinetics of Cathode Events on Polymer Electrolyte Fuel Cell Catalysts Studied by Operando Time-Resolved XAFS," *Catal. Letters*, vol. 148, no. 6, pp. 1597–1609, Jun. 2018, doi: 10.1007/s10562-018-2383-7.
- [4] S. Pollastri *et al.*, "Characterization of innovative Pt-ceria catalysts for PEMFC by means of ex-situ and operando X-Ray Absorption Spectroscopy," *Int. J. Hydrogen Energy*, vol. 47, no. 14, pp. 8799–8810, 2022, doi: 10.1016/j.ijhydene.2021.12.241.





## Development of an Operating Strategy for PEM Fuel Cell Systems based on Real-time Fault Diagnosis

Hwanyeong Oh<sup>\*a,b</sup>, Yoon-Young Choi<sup>a</sup>, Minjin Kim<sup>a,b</sup>, Young-Jun Sohn<sup>a,b</sup>,  
Tae-Hyun Yang<sup>a</sup>, Won-Yong Lee<sup>a</sup>

\* corresponding author: [hyoh@kier.re.kr](mailto:hyoh@kier.re.kr)

<sup>a</sup> Fuel Cell Laboratory, Korea Institute of Energy Research, Daejeon, 34129, Republic of Korea

<sup>b</sup> Hydrogen Energy Engineering, University of Science and Technology, Daejeon, 34113, Republic of Korea

*Keywords: Fault diagnosis, Fault-tolerant control, Fuel cell system, Real-time*

**Introduction:** Fuel cell systems are complex and interdependent, with various characteristics including materials, electrochemistry, fluids, and heat management. A fault in a subsystem can lead to a system-wide fault [1], particularly in the fuel cell stack, which is a passive power generation device that relies on proper air, fuel, water, and heat management for optimal performance. Abnormalities in air, fuel, humidity, temperature, and other factors due to specific faults can directly affect stack lifespan and performance, and severe faults can cause irreversible stack degradation [2]. Therefore, early diagnosis of faults and appropriate response strategies are crucial. By the way, repair and replacement of components in a system that is operating can be costly and inefficient [3].

**Objectives:** In this study, we propose an operating strategy that utilizes real-time operational data to diagnose fuel cell faults early and determine whether to continue the operation, change control, stop the operation for repair, or perform a repair when the operation stops.

**Methods:** A hierarchical structure for effective Fault Detection and Diagnosis (FDD) is applied based on representative residuals of subsystems/components [1, 4]. After fault diagnosis, the operating strategy takes into account factors such as control stability, system efficiency, and stack durability. Fault-tolerant control can be achieved through feed-back control using real-time predicted values from other measured values or feed-forward control using fixed control signal values corresponding to normal conditions.

**Results:** Accurate diagnosis was achieved for various component faults, such as leakages, air blowers, flow meters, coolant pumps, thermocouples, and others, with a fault magnitude of less than 10% using residual-based fault diagnosis. After fault diagnosis, the decision-making process varies depending on the type and magnitude of the fault. The typical categories of decision-making are summarized in Table 1.

**Table 3. An example of the operating strategy depending on the result of the fault diagnosis.**

Diagnosed Fault Type	Decision after Fault Diagnosis
Flow meter fault, thermocouple fault for control	Fault-tolerant control
Filter clogging, heat exchanger fouling, leakage before flow meter, blower/pump fault, pressure sensor	Perform repair when the operation stops
Leakage after flow meter, blower/pump control signal of 100 %	Stop the operation for repair

**Conclusions:** The proposed method can diagnose fuel cell system faults and make appropriate decisions in real-time to maintain system operational efficiency, prevent stack degradation, and minimize maintenance costs.

### Acknowledgment

This work was supported by the framework of the research and development program of the Korea Institute of Energy Research (C3-2425) and the Korea Institute of Energy Technology Evaluation and Planning (KETEP) grant funded by the Korean Government (MOTIE) [20203030030040].

### References

- [1] Lee WY, Oh H, Kim M, Choi YY, Sohn YJ, Kim SG. Hierarchical fault diagnostic method for a polymer electrolyte fuel cell system. *International Journal of Hydrogen Energy*, 2020;45:25733-46.
- [2] Won J, Oh H, Hong J, Kim M, Lee WY, Choi YY, Han SB. Hybrid diagnosis method for initial faults of air supply systems in proton exchange membrane fuel cells. *Renewable Energy* 2021;180:343-52.
- [3] Seo SH, Oh SD, Park J, Oh H, Choi YY, Lee WY, Kwak HY. Thermodynamic, exergetic, and thermo-economic analyses of a 1-kW proton exchange membrane fuel cell system fueled by natural gas. *Energy* 2021;217:119362.
- [4] Oh H, Lee WY, Won J, Kim M, Choi YY, Han SB. Residual-based fault diagnosis for thermal management systems of proton exchange membrane fuel cells. *Applied Energy* 2020;277:115568.



## Innovative Model-Based Diagnostic Algorithm for Leakage Isolation and Identification in an SOFC System for Micro-CHP Applications

Pierpaolo Polverino\*<sup>a</sup>, Sabrina Sica<sup>a</sup>, Cesare Pianese<sup>a</sup>

\* corresponding author: ppolverino@unisa.it

<sup>a</sup> Department of Industrial Engineering, University of Salerno, via Giovanni Paolo II 132, 84084, Fisciano (SA), ITALY

*Keywords: Solid Oxide Fuel Cells, Fault Diagnosis, Leakage, Modelling*

### **Abstract**

It is well established by now the role of hydrogen and fuel cells (FCs) as pivotal technologies for the rapid transition within the current energetic scenario, although FC performance and durability are still below the targets set by governing bodies. To improve their performance and reliability, diagnostic and control tools can provide significant impact, complementary to material design and system optimal architecture.

In this context, the work presented in this paper deals with the design and verification in simulated environment of an innovative diagnostic algorithm for fault monitoring, detection, isolation and identification of leakages occurring in a Solid Oxide Fuel Cell (SOFC) system for micro-Combined Heat and Power (micro-CHP) applications.

The SOFC system is modelled according to physical-based approach, accounting for mass and energy balance of each component, to simulate its operation in both nominal and faulty states. The considered faults are leakages distributed in various points of the system.

A Fault Tree Analysis (FTA) is first performed to connect all the faults to their symptoms through dedicated Fault Trees (FT), and a preliminary qualitative Fault Signature Matrix (FSM) is compiled to attempt fault detection and isolation. As remarked by the authors in other previous works, qualitative fault isolation brings eventually to fault clustering issues (i.e., hindering the univocal isolation of the faults), and a more effective approach should be introduced to achieve univocal diagnosis.

The mathematical model of the system is therefore used to carry out a quantitative investigation, calculating residuals values, defined as the percentage deviations of the monitored variables from nominal conditions, at different fault locations and magnitudes. Generally, to perform fault isolation, a set of thresholds shall be introduced, designed as trade-off between false alarm and missed fault rates. However, even though a quantitative FSM is obtained, the detection and isolation process is highly affected by the threshold value choice.



The key innovation brought by the present work consists in the definition of mathematical relations (i.e., functions) that represent the behaviour of residuals at different fault locations and magnitudes. These functions are used directly as reference patterns for fault detection and isolation without the need for any threshold setting. Moreover, this approach also solves the fault clustering issue with great accuracy even with faults that present the same symptoms pattern. The algorithm performance is assessed in simulated environment with satisfactory accuracy and robustness.



## HT-PEFC based CCHP systems and operational strategies for data center energy savings and Net Zero achievement

Minjin Kim<sup>\*ab</sup>, Seonghyeon Ham<sup>ab</sup>, Yoon-Young Choi<sup>a</sup>, Hwanyeong Oh<sup>a</sup>, Young-Jun Sohn<sup>ab</sup>

\* corresponding author: [minjin@kier.re.kr](mailto:minjin@kier.re.kr)

<sup>a</sup> Fuel Cell Research Center, Korea Institute of Energy Research, Daejeon, 34129, Republic of Korea

<sup>b</sup> Hydrogen Energy Engineering, University of Science and Technology, Daejeon 34113, Republic of Korea

*Keywords: CCHP(combined cooling, heat and power) system, Data center, HT-PEFC(High temperature polymer electrolyte fuel cell), Operational optimization.*

### Abstract

**Introduction:** In order to reduce carbon emissions as the problem caused by climate change becomes serious, the data center, an energy-intensive building, is actively conducting research to replace some or all of the power required for the data center with eco-friendly hydrogen fuel cells without carbon emissions [1]. Prior research is needed before applying hydrogen fuel cells to data centers, such as energy consumption reduction effects and Net Zero achievement [2].

**Objectives:** This study aims to present an economic operation strategy that can achieve Net Zero of the data center by utilizing the HT-PEFC(High temperature polymer electrolyte fuel cell)-based CCHP(combined cooling, heat and power) system using hydrogen as a power source for the data center. Data centers use more than 40% of their power usage to produce cold heat to remove the heat produced by IT devices. Therefore, using the CCHP system, which makes electricity and cold heat together with hydrogen, is economical by increasing energy efficiency for electricity and cold heat supply as well as 100% eco-friendly power supply.

**Methods:** The configuration of the CCHP system was proposed to most efficiently supply electricity and cold heat to the data center, which is manufactured without carbon emission. The hydrogen-based HT-PEFC-based CCHP system has been proposed as a structure to create cold heat by supplying more than 100 degrees of recovery heat recovered from HT-PEFC operating at high temperatures of 120 to 180 degrees to the heater pump's generator. In addition, the operation efficiency of the proposed CCHP system was maximized by applying a free cooling method to maximize the cooling effect of the data center. The operation strategy

of the proposed system was presented by performing operation optimization for the following two purposes. 1) HT-PEFC for data center aims to maximize energy conversion efficiency to minimize hydrogen fuel use, and 2) to achieve Net Zero by covering the entire power consumption of the data center in the proposed system.

**Results:** The system proposed in this study is shown in Figure 1, and the effect of increasing energy efficiency and reducing CO<sub>2</sub> emissions according to the operation strategy of the proposed system is shown in Figure 1. As shown in 2. As a result of the simulation, the total power consumption compared to the existing system decreased by 3,618MWh per year, and it is possible to achieve Net Zero for case D, E, and F among a total of six proposed strategies.

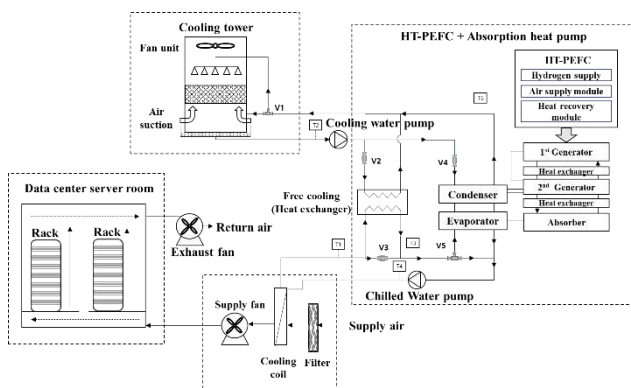

**Fig. 11 Proposed CCHP system for data center**

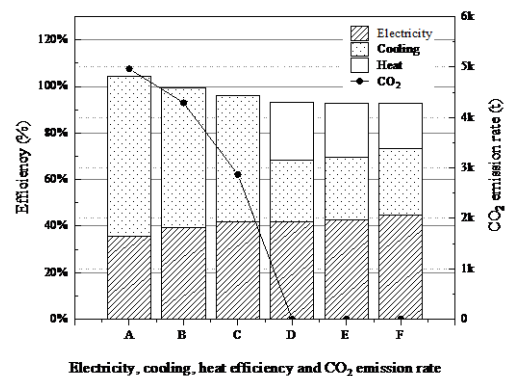

**Fig. 2 Results of operational optimization**

**Conclusions:** We propose an HT-PEFC-based CCHP system to reduce electricity consumption in data centers where electricity consumption is rapidly increasing day by day, and verify the utility of the proposed system based on the actual data center's annual energy demand data.

### Acknowledgment

This work was conducted under the framework of Research and Development Program of the Korea Institute of Energy Research (KIER) (C3-2425).

### References

- [1] S. Authayanun and V. Hacker, "Energy and exergy analyses of a stand-alone HT-PEMFC based trigeneration system for residential applications", *Energy Conversion and Management*, Vol. 160, 2018, pp. 230-242, doi: <https://doi.org/10.1016/j.enconman.2018.01.022>.
- [2] S. Ham, D. Park, W. Y. Lee and M. Kim, "Simulation to analyze operation strategy of combined cooling and power system using a high-temperature polymer electrolyte fuel cell for data centers", *International Journal of Hydrogen Energy*, Vol. 48, No. 22, 2023, pp. 8247-8259, doi: <https://doi.org/10.1016/j.ijhydene.2022.11.257>.



## Analysis of Signal Patterns by Load on Fuel Supply System and Fault Diagnosis Method Using It in PEMFC System Using Urban Gas

Yoon-Young Choi <sup>a\*</sup>, Hwanyeong Oh<sup>a</sup>, Minjin Kim<sup>a,b</sup>, Young-Jun Sohn<sup>a,b</sup>, Won-Yong Lee<sup>a</sup>

\* corresponding author: [ychoi@kier.re.kr](mailto:ychoi@kier.re.kr)

<sup>a</sup> Fuel Cell Laboratory, Korea Institute of Energy Research, Daejeon, 34129, Republic of Korea

<sup>b</sup> Advanced Energy and System Engineering, University of Science and Technology, Daejeon, 34113, Republic of Korea

*Keywords: Fuel cell system, Fault diagnosis, Steam reformer*

**Introduction:** The polymer fuel cell system utilizing city gas is an alternative energy technology that generates electricity and heat through electrochemical reactions of hydrogen and oxygen, producing only water as a byproduct. Among the various types of fuel cell systems, the polymer electrolyte membrane fuel cell (PEMFC) has drawn attention as a promising technology for residential and commercial applications due to its high energy efficiency, low emissions, and low operating temperatures[1]. However, the fuel supply system of the PEFC can be subject to various failures and malfunctions that can hinder the performance of the system[2]. In order to improve the reliability and performance of the fuel supply system, this study analyzes the signal patterns of the system under different loads and proposes a fault diagnosis method using these signal patterns. The results of this study could contribute to the development of more efficient and reliable fuel cell systems for practical applications[1,3].

**Objectives:** In this study, the early diagnosis of fuel cell system faults caused by fuel supply system anomalies, such as hydrogen starvation and CO poisoning, within the fuel cell system is aimed to be prevented. For this purpose, load-dependent signal patterns and signal patterns based on simulated BOP faults at specific loads were analyzed.

**Methods:** To implement a residential fuel cell system, a 1 kW-class PEMFC test bed was built in this study. In particular, a hydrogen production system using steam reforming was established and each signal was collected through LabView. The urban gas used was provided locally and mainly composed of methane with a content of about 80 %. The fuel cell operating temperature was set to 60 °C, and the output load was set between 500-800 W, with data



collected under steady-state conditions for each signal. Regarding the diagnosis of BOP faults in the fuel supply system, a hierarchical structure is applied for fault detection and diagnosis[1,3]. Among these, one case was selected for each of hydrogen starvation and CO poisoning, which was confirmed through impedance measurement in the fuel cell.

**Results:** Based on the analysis of signal patterns of BOPs for fuel supply system according to each output load of the fuel cell stack, a consistent pattern was observed, and fault simulation experiments were conducted at 800W. A total of 20 sets of fault simulation data were obtained for fault diagnosis, and the possibility of responding to fault diagnosis was confirmed based on the set values. Among them, performance degradation values and impedance change data were obtained for fuel depletion due to hydrogen leakage in the stack anode and CO concentration increase (CO poisoning) due to air leakage in the selective oxidizer anode (a performance degradation of 3% and 9% in the stack, respectively).

**Conclusions:** The content of this study aims to diagnose fuel cell system faults early in a fuel cell system using city gas reforming, thereby increasing the durability of the fuel cell system and reducing maintenance costs.

**Acknowledgment:** This work was supported by the Korea Institute of Energy Technology Evaluation and Planning (KETEP) grant funded by the Korean Government (MOTIE) [grant number 20213030030190, Development of Smart DPO(Design, Production, Operation) Open Platform for Fuel Cell System].

## References

- [1] Lee WY. (2017). "Fault Detection and Diagnosis Methods for Polymer Electrolyte Fuel Cell System." Trans. of Korean Hydrogen and New Energy Society **28**(3): 252-272
- [2] Kim, J.d. (2011). "Status and Perspective of Residential Fuel Cell System." Korean Industrial Chemistry News **14**(2): 26-38.
- [3] Lee, W.-Y., et al. (2020). "Hierarchical fault diagnostic method for a polymer electrolyte fuel cell system." International Journal of Hydrogen Energy **45**(47): 25733-25746..





## Development of a Highly Efficient Co-SOEC-Based Power-to-Liquid Plant

Manuel Tandler<sup>\*a</sup>, Bernd Reiter<sup>a</sup>

\* corresponding author: [manuel.tandler@avl.com](mailto:manuel.tandler@avl.com)

<sup>a</sup> AVL List GmbH

*Keywords: Power-to-Liquid, eFuel Production, Co-Electrolysis*

### **Abstract**

This work presents AVL's most recent development activities in the field of SOEC-based power-to-liquid (PtL) technology within the project "Innovation Liquid Energy" (German: "Innovation Flüssige Energie"), funded by the Austrian Climate and Energy Fund. The overall objective of the project is the development and realization of a PtL plant with a combined water and carbon dioxide high-temperature electrolysis (co-SOEC) coupled with a Fischer-Tropsch (FT) synthesis for the production of synthetic fuel. The 200 kW SOEC system, developed by AVL, will be the building block for MW-scale PtL plants. In a first step, a detailed thermodynamic analysis of various plant configurations as well as the plant concept of a fully integrated SOEC-FT PtL plant was carried out. The project provides the unique possibility to design the complete PtL plant taking into account the optimization and integration of both processes, the SOEC and the FT-process, in the most efficient manner. This is seen as a major technological advantage over current PEM-FT based PtL solutions with, for example, limited possibilities of heat integration. Especially, the heat integration between both processes as well as the product tail gas recycling will be the key for overall efficiencies of 50-55 %. The heat generated by the exothermic FT-process is efficiently used in the endothermic electrolysis process. High temperatures on similar levels in both processes, SOEC and FT, facilitate a highly efficient heat integration with minimum waste heat. Furthermore, the product tail gas after the product processing stage which cannot be directly turned into useful FT-products (such as naphtha, diesel and waxes), contains still a significant amount of chemical energy which is efficiently used by recycling the gas into the process. This increases the product yield and carbon efficiency. Eventually, data from the current design is used for the economic analysis of large-scale synthetic diesel production. The economic results are based on a sensitivity analysis considering plant CAPEX, full load operating hours, efficiency and electricity price. As a result, the required boundary conditions for a price in the range of 1-3 EUR/L will be discussed.



### **Introduction:**

In the project “Innovation Liquid Energy”, a concept of a highly efficient solid oxide electrolysis combined with a Fischer-Tropsch synthesis shall be investigated. On lab-scale SOEC applications, AVL could demonstrate 80% power-to-gas efficiency already, while state-of-the-art alkaline and PEM technologies show efficiency levels between 60-70%. Smart coupling of a FT-synthesis optimized for interconnection with SOEC technology allows total PtL efficiencies above 55%. This represents an extraordinary increase of efficiency compared to systems with alkaline or PEM technology with prognosed efficiencies of 43% [3]. Fraunhofer IKTS delivers SOEC stacks and stack modules based on well-known MK35x stack technology which is already validated in Co-electrolysis [2], [3].

### **Objectives:**

Development, design and build-up of a 200kW PtL plant based on co-SOEC technology with

- > 55% overall plant efficiency
- Production quantity of 100.000 litres/year Syncrude (assumption 24/7/365 operation)

### **Material and methods:**

AVL SOC development approach, ESC cell technology, FT tail gas heat integration, FT heat recovery for steam production

### **Results:**

- Co-SOEC results on stack and module level available confirming el. efficiency level in syngas production
- First BoP components and sub-systems available and tested
- References of FT operation using synthetic gas from different sources on a reference FT catalyst available soon

### **Conclusions:**

- Simulations show system feasibility and highest efficiencies.

### **References**

- [1] D. H. König, N. Baucks, R.-U. Dietrich and A. Wörner, “Simulation and evaluation of a process concept for the generation of synthetic fuel from CO<sub>2</sub> and H<sub>2</sub>,” Energy, vol. 91, pp. 833-841, 2015.
- [2] S. Megel, C. Dosch, S. Rothe, C. Folgner, N. Trofimenko, A. Rost, M. Kusnezoff, E. Reichelt, M. Jahn, A. Michaelis, C. Bienert and M. Brandner, “Co-Electrolysis with CFY-Stacks,” in SOFC-XV: 15th Int. Symposium on SOFC, Hollywood, FL, USA, 2017
- [3] “HydroMetha Project,” 2019.



## Designing for flexible use of hydrogen and natural gas: the SO-FREE project

Stephen McPhail<sup>a</sup>, Viviana Cigolotti<sup>b</sup>, Mathias Innerkofler<sup>c</sup>, Matti Noponen<sup>d</sup>, Stefan Megel<sup>e</sup>, Carlo Tregambe<sup>f</sup>, Michal Wierzbicki<sup>g</sup>, Lukasz Bubniak<sup>h</sup>, Luca Del Zotto<sup>j</sup>

\* corresponding author: [stephen.mcphail@kiwa.com](mailto:stephen.mcphail@kiwa.com)

<sup>a</sup> KIWA (NL)

<sup>b</sup> ENEA (IT)

<sup>c</sup> AVL (AT)

<sup>d</sup> Elcogen Oy (SF)

<sup>e</sup> Fraunhofer IKTS (DE)

<sup>f</sup> ICI (IT)

<sup>g</sup> IEN (PL)

<sup>h</sup> PGE (PL)

<sup>j</sup> Università Guglielmo Marconi (IT)

*Keywords: Solid oxide fuel cells, combined heat and power, system demonstration, fuel flexibility*

### Abstract

Hydrogen and methane are the most effective gaseous vectors of energy, as they can be conveniently derived both from fossil and renewable sources. The objective of the SO-FREE project is the development of a fully future-ready solid oxide fuel cell (SOFC)-based system for conversion of the carrier to combined heat and power (CHP). This means a versatile system concept for efficient, near-zero emission, fuel-flexible and truly modular power and heat supply to end users in the residential, commercial, municipal and agricultural sectors. The project aims at the delivery of a pre-certified SOFC-CHP system allowing an operation window from zero to 100% H<sub>2</sub> in natural gas and with additions of purified biogas. Furthermore, the SO-FREE project will endeavour the realization of a standardized stack-system interface, allowing full interchangeability of SOFC stack types within a given SOFC-CHP system. This interface design will be proposed for international standardization so that commercial barriers to full and free competition between SOFC stack suppliers and system integrators could be levelled. This interoperability will be proved by a double demonstration period: two systems will be run for 9 months each, each operating, alternately, two different stacks, which will be exchanged between the



two systems. As a final proof of robustness and flexibility, the two stacks integrated in each of the two systems will be characteristic of the extreme ends of the spectrum of SOFC operating temperatures: 650°C (anode-supported cells) and 850°C (electrolyte-supported cells). The challenges in a safe, efficient and cost-effective design of such a system are numerous and arduous, and the SO-FREE consortium is dealing with them all. This presentation will give a taste of the progress made and the difficulties overcome.

### **Acknowledgment**

This project has received funding from the Clean Hydrogen for Europe Joint Undertaking (JU) under grant agreement No 101006667. The JU receives support from the European Union's Horizon 2020 research and innovation programme and Italy, Austria, Finland, Germany, Poland, Netherlands, United Kingdom

### **References**

[www.so-free.eu](http://www.so-free.eu)



# European Fuel Cells and Hydrogen

PIERO LUNGI CONFERENCE

September 13th-15th 2023  
Capri / Italy

## From direct use of ammonia in solid oxide fuel cells to the next generation of ammonia fuel cell systems

Luca Praticò<sup>\*a</sup>, Chiara Curzel<sup>b</sup>, Matteo Testi<sup>a</sup>, Dario Montinaro<sup>b</sup>

\* corresponding author: [prattico@fbk.eu](mailto:prattico@fbk.eu)

<sup>a</sup> Sustainable Energy centre, Bruno Kessler Foundation, Via Sommarive 18 Trento, Italy

<sup>b</sup> SolydEra SpA, viale Trento 115/117, 38017 Mezzolombardo, Italy

*Ammonia SOFC; SOFC; Ammonia fuel; Green Ammonia.*

### Abstract

One of the most interesting alternatives in hydrogen carriers is represented by ammonia. Ammonia represents a considerable part of the hydrogen market, where about 45% of the total pure hydrogen produced is employed for ammonia synthesis[1]. Along with the employment as a chemical intermediate for fertilizer production, ammonia could be used directly as a fuel presenting better characteristics if compared to hydrogen, like volumetric energy density and storage conditions. In particular, ammonia could feed solid oxide fuel cells (SOFC) directly, presenting high conversion efficiencies and no nitrous oxide emissions [2]. SOFC can exploit ammonia in two ways, either preliminarily cracked into molecular nitrogen and hydrogen or directly fed into the cells. The latter is called Direct Ammonia Solid Oxide Fuel Cell (DA-SOFC). In this case, when the temperature rises above 600K, the ammonia is thermally cracked almost totally. However, the kinetics of the decomposition is slow and accelerates with higher temperatures.

The sustainable energy centre of Bruno Kessler Foundation, an independent research centre in Trento (Italy), has conducted several experimental activities on the exploitation of ammonia as a fuel directly feeding SOFC. The test facility is equipped with a test bench SSTB-01, provided by SolydEra, capable of working with short stacks, i.e. six anode supported SOFC. In this context, Zandrini et al. [3] compared the performances of cells provided by Solydera with pure hydrogen, ammonia and H<sub>2</sub>-N<sub>2</sub> in a stoichiometric ratio of 3:1. The results showed that performances present, in the case of pure ammonia, a bend that limits the maximum power to ca 0.29W/cm<sup>2</sup> lower than the corresponding hydrogen flow (0.32W/cm<sup>2</sup>), at 760°C and fuel utilization of 68%. This phenomenon increases at lower temperatures and at higher fuel utilizations. To explain this effect, the authors proposed that the ammonia is not completely cracked inside the stacks, thus reducing the voltage by concentration over losses and activating the safety threshold. In this work, additional tests were conducted with the same test platform on a new six-cell stack with similar characteristics, reproducing the performances presented by Zandrini, with a similar voltage drop at high current densities if fed by pure ammonia. Additionally, this test campaign included a long-term test with pure ammonia in galvanostatic mode conducted at 760°C and fuel utilization of 63% (0.4A/cm<sup>2</sup>).

The results, reported in Figure 1, show no particular degradation of performances, where the power produced maintain the same level, i.e.  $0.317\text{W}/\text{cm}^2$ , during the 500h of the test. The absence of degradation is also confirmed by benchmark test, i.e. polarization curves, that denote similar performance before and after the long-term test. Further tests should be conducted to characterize better the stack fed by ammonia, which could be a 2000h long test or evaluate the cracking of ammonia inside the SOFC.

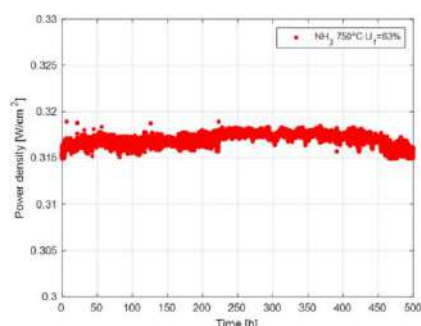

Figure 12- Power density level during 500h long-term test conducted in galvanostatic mode at  $750^{\circ}\text{C}$ ,  $U_f$  equal to 63% and  $0.4\text{A}/\text{cm}^2$

Furthermore, FBK activities are now focused on the “Horizon Europe” project AMON, which aims to develop an innovative system that efficiently converts ammonia into electric power using a SOFC. The project will focus on designing essential components of the system, such as the fuel cell, ammonia cracker, ammonia burner, and anode gas recirculation. Additionally, the entire Balance of Plants will be engineered, and compliance with ammonia use will be verified for all specific parts and components. The SOFC employed in the final system is based on an 8kW G8x Stack from SolydEra. Although the pilot demonstration will be conducted on a small scale, the AMON project aims to scale up the engineering to create a system suitable for applications in ports, the maritime environment, and autonomous power systems. The consortium is formed by several research and industrial partners like DTU, EPFL, VTT, SolydEra, Alfa Laval, HSLU, EFCF and Sapio.

#### Acknowledgement

The project has received funding from the Clean Hydrogen Partnership under Grant Agreement n°101101521 — AMON. The Partnership receives support from the European Union's Horizon Europe research and innovation program, Hydrogen Europe, and Hydrogen Europe Research

#### References

- [1] ‘The future of hydrogen’, IEA, 2019. [Online]. Available: <https://www.iea.org/reports/the-future-of-hydrogen>
- [2] S. S. Rathore, S. Biswas, D. Fini, A. P. Kulkarni, and S. Giddey, ‘Direct ammonia solid-oxide fuel cells: A review of progress and prospects’, *International Journal of Hydrogen Energy*, vol. 46, no. 71, pp. 35365–35384, 2021.
- [3] M. Zandrini, M. Testi, M. Trini, P. Daniele, J. Van Herle, and L. Crema, ‘Assessment of ammonia as energy carrier in the use with reversible solid oxide cells’, *International Journal of Hydrogen Energy*, vol. 46, no. 58, pp. 30112–30123, Aug. 2021, doi: 10.1016/j.ijhydene.2021.06.139.



## **TOPIC 4: BIOLOGICAL PROCESSES IN THE GREEN HYDROGEN VALUE CHAIN**



## Bioelectrochemical Systems – from fundamentals in robotics to real world applications

Ioannis A. Ieropoulos

Water & Environmental Engineering Group, Civil, Maritime and Environmental Engineering  
Faculty of Engineering and Physical Sciences, Boldrewood Campus, University of Southampton,  
SO16 7QF, UK.

Email: [i.ieropoulos@soton.ac.uk](mailto:i.ieropoulos@soton.ac.uk)

Microbial fuel cells (MFCs) is a promising platform technology for a number of applications. MFCs work on anaerobic/electroactive microbial metabolism, which results in electricity being produced whilst organic matter (consumed as fuel) is being treated. MFCs usually consist of two half-cells, separated by an ion exchange membrane and electrons flow from the bacterial (negative) half-cell, to the positive half-cell, through a circuit. Amongst a plethora of organic waste products and materials tested in MFCs, human urine has been reported as an effective fuel for electricity generation. Urine is responsible for 10% of organics, 75% of nitrogen and 50% of phosphorous found in domestic wastewater, and yet volumetrically, it only constitutes less than 5% at municipal level. It is therefore of significantly advantageous if waste separation was implemented at source, for more efficient downstream wastewater treatment.

This talk will present results from the practical implementation perspective of MFCs in a range of applications, thereby making the case for a platform technology that can be used in off-grid and citywide inclusive environments. The talk will show the chronological development of the technology, from the early robotics implementation to the most recent application in sanitation. Work from the Urine-tricity programme that has been running for 10 years, showing the potential of MFCs in treating human urine will be presented. Different MFC designs, including ceramic-based with power generation and organics degradation are being discussed. When ceramics are appropriately exploited, this results in the generation of an electrochemically activated solution, known as the catholyte, which is a valuable by-product that can be used as a disinfectant. This catholyte is an alkaline, high in salt (thus high in conductivity) liquid that is produced due to the electro-osmotic drag and has been shown to achieve pathogen killing. MFCs can also be generally used as a biosensor to monitor the organics in an aqueous medium, through the analogue signal produced. The MFC technology has also been successfully scaled up and implemented as a power source for lighting, in remote, previously unsafe toilet environments, and for this reason, has been named Pee Power®. More recently, emphasis has been given on the pathogen killing properties of MFCs, whilst generating electricity and results from this work will also be presented for different pathogenic species.

The talk concludes with the case for microbial fuel cells as a platform technology for multiple a range of environments including sanitation, renewable energy generation, production of value-added products via elemental recycling and wastewater treatment.





## Optimization of ternary Biochar-Copper-Hydroxyapatite multicomposites composition to be used as cathodes for bioelectrochemical power to gas

P. Cristiani<sup>\*a</sup>, G. Ghiara<sup>b</sup>, S. Campisi<sup>c</sup>, M. Bigica<sup>c</sup>, A. Goglio<sup>d</sup>, F. Formicola<sup>e</sup>, F. Adani<sup>d</sup>, F. Tulli<sup>a</sup>,  
M. Balordi<sup>a</sup>, A. Gervasini<sup>c</sup>

\* corresponding author: pierangela.cristiani@rse-web.it

<sup>a</sup> Ricerca sul Sistema Energetico S.p.A., Via Rubattino 54, 20134 Milano, Italy

<sup>b</sup> Department of Environmental Science and Policy, University of Milan, Via Celoria 2, 20133, Italy

<sup>c</sup> Dipartimento di Chimica, Università degli Studi di Milano, Via Golgi 19, 20133, Italy

<sup>d</sup> Department of Agricultural and Environmental Sciences, University of Milan, Via Celoria 2, 20133, Italy

<sup>e</sup> Department of Heart and Environmental Science, University of Milan, Via Celoria 2, 20133, Italy

*Keywords: Electromethanogenesis, Power-to-gas, BET2G, Hydrogen to biomethane, CO2RR*

### Abstract

**Introduction:** Within the power-to-gas (P2G) concept, bioelectrochemical systems were explored as alternative ways of producing hydrogen and, by adding CO<sub>2</sub>, methane (BEP2G). The innovative process producing methane from CO<sub>2</sub> is known as electromethanogenesis [1]. Indeed, bioenergy constitutes approximately 10% of the global primary energy requirement, with biomethane representing 3% of the overall demand. However, further advancements in materials engineering are still needed to fully unlock the potential of P2G as for instance the development of effective materials for bioelectrodes. In a recent study carried out by the authors [2], bioelectrochemical CO<sub>2</sub> reduction processes were explored, using a cost-effective composite material. This composite consists of porous carbon from a maize stalk (biochar), copper (Cu) and hydroxyapatite (Ca<sub>5</sub>(PO<sub>4</sub>)<sub>3</sub>OH, HAP) nanoparticles. Very good methane production rates were achieved from bioelectrochemical systems where cathodes were made of biochar doped with 20 wt.% Cu and 10 wt.% HAP, reaching a maximum of 866±199 mmol m<sup>-2</sup> d<sup>-1</sup> with a coulombic efficiency of 64%. Following this premise, further investigation is required to optimize the preparation of biocathodes and maximize methane production.

**Objectives:** In this study, we focused on optimizing the multi-step protocol for biocathode production using a Full factorial Design approach. This approach allowed to statistically predict the best composition of the composite material in a certain experimental range, also gathering the most precise response in terms of methane generation from the tests according to the specific system configuration. Different concentration of Cu, HAP and biochar were tested and considered as independent variables: combinations from 10 to 20 wt. % of Cu and HAP on a biochar substrate were prepared and deposited on previously pyrolyzed biochar electrodes (projected surface area of 7.5 cm<sup>2</sup>) using a dip-coating technique.

**Methods:** A Full Factorial Design approach was used in determining the appropriate proportions of composite constituents (biochar, Cu, and HAP). The morphological and structural properties of the



composites were characterized using surface techniques as scanning electron microscopy (SEM), surface area measurements, and X-ray powder diffraction (XRD). Subsequently multicomposites were used as cathodes in a dual chamber bioelectrochemical cell, under mesophilic conditions (45°C) and a CO<sub>2</sub> supply of 55 mmol per day, employing a strain of hydrogenotrophic microorganisms from the Archaea domain, which were enriched from the inoculum collected from a biogas plant. The methane production was monitored for 7 days from the headspace of the cathodic compartment using gas chromatographic techniques. Also, molecular (next generation sequencing of 16S RNA on the multicomposites) and solution analyses (ionic chromatography) were employed to verify the enrichment of the bacteria on the cathodes and the possible by-products occurring from the CO<sub>2</sub> reduction reaction.

**Results:** The multi-technique characterization, combining N<sub>2</sub> adsorption/desorption isotherms, solid-liquid phase titrations with probe molecules, bicarbonate titration and infrared spectroscopy demonstrated that encapsulating hydroxyapatite on the surface of biochar can effectively improve the performance of multi-composite cathodes in the electromethanogenesis. The hydroxyapatite-containing composites exhibit 3 times higher surface area (30 m<sup>2</sup> g<sup>-1</sup>) than the undoped biochar (10 m<sup>2</sup> g<sup>-1</sup>). Moreover, the exposure of the multifunctional HAP surface with acidic and basic moieties, can not only facilitate the adhesion of microorganisms, but also act as a pH buffer and promote the adsorption of reacting species (protons, bicarbonate), thereby dramatically increasing their local concentration at the electrode/solution interface. Consequently, the incorporation of HAP enables the multi-composites to achieve faster reaction kinetics.

**Conclusion:** The best composite revealed to be the biochar doped with a 10 wt.% Cu and 10 wt.% HAP, resulting in an efficient reduction of CO<sub>2</sub> into CH<sub>4</sub> with very impressive production rates of 10.6±0.36 mol m<sup>-2</sup> d<sup>-1</sup> and a pH stabilization at the interface, with an efficiency of the energy conversion to methane of more than 95%. This is the best performance of electromethanogenesis never achieved from the literature data. However, experimentation was carried out at a very small scale. A substantial scaling up of the bioelectrical system is necessary for moving from the lab scale to a pilot prototype.

**Acknowledgement:** This work has been financed by the Research Fund for the Italian Electrical System under the Contract Agreement between RSE S.p.A. and the Ministry of Economic Development - General Directorate for the Electricity Market, Renewable Energy and Energy Efficiency, Nuclear Energy in compliance with the Decree of April 16th, 2018

## References

- [1] Geppert et al. Trends in Biotechnology (2016), 34, 11, 879:894
- [2] Ghiara et al. Sustainable Energy Technologies and Assessments, Vol. 57, 2023, 103274.

## Bioelectrochemical Power-To-Methane Approach in Double Pot Bioreactors

G. Soggia<sup>\*,a</sup>, A. Goglio<sup>a</sup>, F. Adani<sup>a</sup> and P. Cristiani<sup>b</sup>

\* corresponding author: gabriele.soggia@unimi.it

<sup>a</sup> Gruppo Ricicla Lab., Department of Agricultural and Environmental Sciences, University of Milan, Via Celoria 2, 20133, Italy;

<sup>b</sup> Ricerca sul Sistema Energetico S.p.A., Via Rubattino 54, 20134 Milano, Italy

*Keywords: bioelectrochemical power-to-methane, double-pot bioreactor, low-cost bioreactor, natural CO<sub>2</sub> emissions, renewable energy*

### Abstract

**Introduction:** One of the main challenges linked with renewable energy production is energy storage during periods of low demand and high productivity. Power-to-methane (P2M) approach is gaining interest due to availability of infrastructure for methane (CH<sub>4</sub>) storage, distribution, and consumption. Bio-electrochemical P2M (BEP2M) is considered more advantageous over catalytic P2M due mainly to milder reaction conditions. Usually, BEP2M technology uses a double step process, consisting in a chemical electrolyser to produce hydrogen (first step) and an anaerobic bioreactor inoculated with hydrogenotrophic microorganisms (Archaea domain) where hydrogen and CO<sub>2</sub> gas mix are injected achieving methane (second step).

**Objectives:** The aim of the study was to create and validate a low-cost and high-tech single step configuration for BEP2M, using a simple bioreactor configuration which allows lab studies and application to soil gas vents. The single step BEP2M, directly produces methane from a CO<sub>2</sub>-rich stream.

The bioreactor was built using low-cost and environmentally friendly materials (terracotta and graphite), targeted to a subsequent scaling up to pilot scale for soil environments. A pivotal part of the research is the simplicity of the system design and the reduction of environmental impact that can be achieved recovering CO<sub>2</sub> stream from natural gas emissions.

**Material and methods:** The bioreactors were assembled using two terracotta pots, as shown in Figure 1. Titanium mesh was used as anode, located in the intersection of the two pots,

while the inside was filled with graphite that acted as cathode. Bioreactors were inoculated with a thermophilic methanogenic inoculum from RSE S.p.A. (Milan, Italy) and sunk in a basin full of tap water at 55 °C. The CO<sub>2</sub> was supplied in the lower part of the bioreactor by means of a long needle. Produced gas was collected thanks to a needle on the top of the bioreactor connected to a gasbag. The cathode polarization was 2 V. Potential and current data were recorded by means of a data logger. The composition of the gas was analyzed by means of gas-chromatograph.

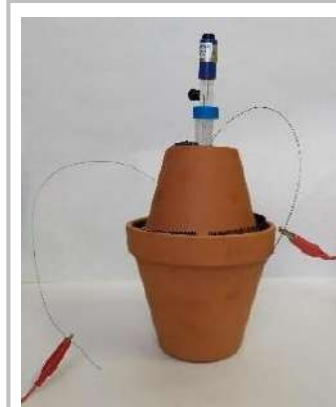

**Figure 13** - Lab-scale bio-electrochemical power-to-methane

**Results:** With the lab-scale double pot bioreactor we were able to produce CH<sub>4</sub> starting from CO<sub>2</sub> reaching percentages higher than 90% of CH<sub>4</sub> in the headspace and outlet gas. The double pot configuration demonstrated to be suitable for simplify testing of sets of different types of charcoal, soils, and other cathode materials. Thereafter, the scaling up using larger bioreactor will allow us to produce CH<sub>4</sub> in situ by harvesting natural CO<sub>2</sub> emissions and using electricity from renewable sources such as from photovoltaic source.

**Conclusions:** Storage of surplus electricity produced from renewable resources is critical to reduce energy losses. The use of low-cost materials such as biochar and graphite for electrodes and terracotta separator will foster the scalability of this model. The production of CH<sub>4</sub> by BEP2M technologies might mitigate the CO<sub>2</sub> emissions from natural gas reservoir producing fuel by renewable non-programmable source out of grid. The validation of this bioreactor configuration could pave the way for low-cost in-situ scaling up of BEP2G approach for energy storage from natural CO<sub>2</sub> emission.

#### References:

1. Schievano A., Goglio A., Erckert C., Marzorati S., Rago L., Cristiani P., Organic waste and bioelectrochemical systems: a future interface between electricity and methane distribution grids, *Detritus* (2018), 01, 57:63
2. Geppert F., Liu D., van Eerten-Jansen M., Weidner E., Buisman C., ter Heijne A., Bioelectrochemical power-to-gas: state of the art and future perspectives. *Trends in Biotechnology* (2016), 34, 11, 879:894
3. Ishii S., Imachi H., Kawano K., Murai D., Ogawara M., Uemastu K., Nealson K. H., Inagaki F., Bioelectrochemical stimulation of electromethanogenesis at a seawater-based subsurface aquifer in a natural gas field. *Front. Energy Res.* (2019), 6:144



# European Fuel Cells and Hydrogen

PIERO LUNGI CONFERENCE

September 13th-15th 2023  
Capri / Italy

## BIO-Hydrogen, the CNR activity in the framework of AdP-PNRR program

Gaetano Squadrito<sup>a</sup>, Massimo Trotta<sup>b</sup>, Pierfrancesco Cerruti<sup>c</sup>, Stefano Gandolfi<sup>d</sup> and  
Giuliana d'Ippolito<sup>e</sup>

*Consiglio Nazionale delle Ricerche (CNR)*

*a Istituto di Tecnologie Avanzate per l'Energia "Nicola Giordano" (CNR-ITAE), via Salita S. Lucia sopra  
Contesse 5, 98126 Messina, Italy*

*b Istituto Processi Chimico Fisici (CNR-IPCF), Via Orabona, 4, 70126 Bari, Italy*

*c Istituto Polymeri, Compositi e Biomateriali (CNR-IPCB), Via Campi Flegrei, 34 - fabbricato 70, 80078  
- Pozzuoli (NA), Italy*

*d Istituto di Scienze e Tecnologie Chimiche "Giulio Natta" (CNR-SCITEC), Via Mario Bianco 9, 20131  
Milano, Italy*

*e Istituto di Chimica Biomolecolare (CNR-ICB), Via Campi Flegrei, 34, 80078 Pozzuoli (NA), Italy*

*\* Presenter author. Tel.: +39 090 624274; fax: +39 090 624247.*

*E-mail address: gaetano.squadrito@itae.cnr.it (G. Squadrito).*

### **Abstract**

According to the European Recovery & Resilience policies launched to react to COVID-19, Italy launched its own "Piano Nazionale di Recupero e Resilienza – PNRR" (National Plan of recovery and resilience) supported by EU. Within the actions, a significant effort for research was considered, and hydrogen technologies were considered as the training technologies for de-carbonisation and future energy market.

In particular, the Minister for Energy Transition (now renamed Minister of Environment and Energy Security) launched the research agreement "AdP - Research and Development of technologies for the hydrogen supply chain" (AdP-Hydrogen), with an investment of 110 M€.. The program foreseen an intensive collaboration between the three main research bodies involved in energy and environmental research (ENEA, CNR and RSE). The aims are: reinforce the collaboration between the three research bodies, and speed-up the technology transfer to industry of hydrogen technologies. For this reason the AdP-Hydrogen research program covers all the aspects of hydrogen value chain, including the new promising early stage hydrogen technologies that could be of interest for the national hydrogen value chain.

The program is divided in Topics, Work Packages and Line of Activity, where each research body contribute with research activities that are complimentary each other. In this framework the Line of Activity 1.1.30 "Development of sustainable biological processes and bioreactors for the production of hydrogen with bacteria and/or photosynthetic



microorganisms from by-products and biomass of the agro-food industry” (SusBioH), falls within the new promising approaches for sustainable hydrogen production.

As clearly exposed in the title the SusBioH research activity aim is the valorisation of waste water by producing hydrogen as a high added value product. This approach will allow the concomitant depuration and reuse of waste water with the production of hydrogen and, possibly other valuable products, thus reducing the today energy consumption for waste water treatment.

The research activity was started in July 2022 and foreseen:

- Bio-chemical studies on anaerobic hypthermophiles bacteria of the Thermotogale order for bio-hydrogen production and CO<sub>2</sub> capture.
- Study of Micro-algae and cianobacters for the production of hydrogen fomr waste water.
- Photo-fermentation of organic compound from polluting water and soil.
- Development of materials for bacteria and micro-organism support, linkage and growth
- Development of a new concept bio-reactor prototype for hydrogen production for demonstrating technology application potentialities and its transfer to industry.

In this way the SusBioH research activity will contribute the four UN Sustainable development goals:

Goal 6 – Clean water and sanitation

Goal 7 – Affordable and clean energy

Goal 9 – Industry, innovation and infrastructures

Goal 11 – Sustainable cities and communities.

In this presentation the premises, the aims and the research plan of LA 1.1.30 are presented together with a selection of the first year research results.

### **Acknowledgement**

This research was funded by the European Union – NextGeneration EU from the Italian Ministry of Environment and Energy Security POR H2 AdP MMES/ENEA with involvement of CNR and RSE, PNRR - Mission 2, Component 2, Investment 3.5 "Ricerca e sviluppo sull'idrogeno", CUP: B93C22000630006.



## CO<sub>2</sub> capture by *Ralstonia eutropha* in Bioelectrochemical Systems (BESs) under different operational conditions

Rosa Anna Nastro<sup>a</sup>, Vincenzo Pasquale<sup>a</sup>, Claudio Avignone Rossa<sup>b</sup>

(a) Department of Science and Technology, University of Naples “Parthenope”, Naples Italy;

(b) Department of Microbial Sciences, University of Surrey, United Kingdom;

e-mail: rosa.nastro@uniparthenope.it

**Objectives:** Inorganic carbon assimilation in bioelectrochemical systems can vary according to the operational conditions, the microbial species, and the substrates present in the catholyte [1]. *Ralstonia eutropha* (formerly *Cupravidus necator*) is listed among candidate microorganisms for CO<sub>2</sub> capture and reuse for its ability to produce polyhydroxyalkanoates (PHAs) [2]. The present work is aimed at investigating the electrosynthesis of Polyhydroxyalkanoates (PHAs) from inorganic carbon at the cathode of Microbial Electrochemical Cells (MECs) with a poised potential of -955 mV vs Ag/AgCl (-750 mV vs SHE) by using a 1.5V Lithium battery at the cathode of Microbial Fuel Cells (MFCs) using a pre-established bioanode formed by a *Shewanella oneidensis* MR1 and *Pseudomonas aeruginosa* PA1430/CO1 consortium. We used glycerol as sole source of carbon and energy at the anode to explore the establishment of a cooperative catabolism due to an efficient direct/indirect Interspecies Electron Transfer (IET) between bioanodes and biocathodes, similar to those occurring in anaerobic/anoxic natural environments [2]. If successful, the IET might sustain CO<sub>2</sub> capture at the cathode, providing reducing equivalent sufficient to optimize the inorganic carbon assimilation, thus carrying out the process without the need for an external source of energy.

**Materials and methods:** We tested CO<sub>2</sub> assimilation efficiency and PHAs production in two-chamber MFCs connected to a 1000 Ω resistor and MECs constructed with carbon cloth electrodes and cation exchange membranes. MECs experiments were conducted by applying at the cathode a potential of -700 mV vs Ag/Ag/Cl reference electrode. Cyclic Voltammetry (CV) was performed at the cathode at a rate of 1 mV/s. We inoculated a *Shewanella oneidensis* / *Pseudomonas aeruginosa* consortium in the anode of all systems, using glycerol 0.4% as the source of carbon and energy. The catholyte was a mineral medium for chemolithotrophic growth (DSMZ 81 medium), sparged with a gas mixture containing 2% O<sub>2</sub>, 10% CO<sub>2</sub>, 10% H<sub>2</sub> and 78% N<sub>2</sub>. The consumption of CO<sub>2</sub> was measured at the headspace of both BESs and control cultures by an ElectroLab CO<sub>2</sub>/O<sub>2</sub> Off-Gas Analyser (Biotech). The production of PHAs was investigated by staining *Ralstonia eutropha* cells with Red Nile (80 µg/mL) dissolved in dimethyl sulfoxide [DMSO] followed by fluorescence confocal microscopy (Nikon Ti-Eclipse with A1M Confocal microscope).

**Results:** Compared to the control cultures, *R. eutropha* showed an increased CO<sub>2</sub> capture rate of 73% in MECs and 64% in MFCs connected to an external load of 1000 Ω. Cyclic Voltammetry (CV) carried out over the range -1V to +1 V at the cathodes of both MECs and MFCs\_1000 Ω revealed the presence of a reduction peak at -370 mV and -280 mV vs Ag/AgCl at pH 6.6 and 6.2 respectively in MECs and MFCs. The exposition to a poised potential of -955 mV increased *R. eutropha* ability to assimilate CO<sub>2</sub>.



Further tests carried out with *R. eutropha* grown at the cathode of MECs revealed an increased ability to assimilate inorganic carbon and to produce PHAs in comparison to the controls. These results may be explained by the possible activation of membrane-bound enzymes involved in electron transfer from the cathode to the microbial biofilm. The confocal microscope analysis revealed a different biofilm structure in presence and absence of an external potential, with a denser and better-structured biofilm in MFCs biocathodes, thus confirming the negative effect of the poised potential (-955 mV vs Ag/AgCl) on biofilm formation. Further, we detected a lower amount of PHAs granules in MECs than in the MFCs and controls. Nevertheless, the results obtained by CVs showed a higher cathodic current in MECs, which might be related to biosynthesis of metabolites other than PHAs. If confirmed, this may signify that low-energy systems could be better candidates for PHAs biosynthesis, unlike acetate or other metabolites.

Conclusions: The MFCs, despite achieving lower CO<sub>2</sub> capture efficiency, were able to sustain *R. eutropha* metabolism at the cathode using glycerol as the sole source of energy and carbon. The application of an external potential allowed a higher CO<sub>2</sub> capture rate, but lower PHAs production and a less dense biofilm. Further analyses are needed to characterize the metabolites produced by *R. eutropha* in different operational conditions.

#### Acknowledgment

This research was supported by a C1NET BBSRC Proof of Concept Grant (UK), the Italian Ministry for the University and the Research (PON Ricerca e Innovazione “Istruzione e ricerca per il recupero – REACT-EU”) and the PHOENIX COST ACTION (CA-19123) - Protection, Resilience, Rehabilitation of damaged environment (PHOENIX). CAR was partially funded by EU-Grant GREENER (European Union's Horizon 2020 Research and Innovation Programme Grant Agreement No 826312).

#### References

[1] Noori M.T., Mohan S.V., Min B. Microbial electrosynthesis of multi-carbon volatile fatty acids under the influence of different imposed potentials, *Sustainable Energy Technologies and Assessments*; 45, 2021, 101118, ISSN 2213-1388, <https://doi.org/10.1016/j.seta.2021.101118>.

[2] Shannon N. Nangle, Marika Ziesack, Sarabeth Buckley, Disha Trivedi, Daniel M. Loh, Daniel G. Nocera, Pamela A. Silver. Valorization of CO<sub>2</sub> through lithoautotrophic production of sustainable chemicals in *Cupriavidus necator*. *Metabolic Engineering*; 62, 2020, 207-220. <https://www.sciencedirect.com/science/article/pii/S1096717620301361>

[2] Nastro RA, Salvian A, Kuppam C, Pasquale V, Pietrelli A, Rossa CA. Inorganic Carbon Assimilation and Electrosynthesis of Platform Chemicals in Bioelectrochemical Systems (BESs) Inoculated with *Clostridium saccharoperbutylacetonicum* N1-H4. *Microorganisms*. 2023; 11(3):735. <https://doi.org/10.3390/microorganisms11030735>





## TOPIC 5: HYDROGEN MOBILITY



## Design space exploration through Liquid H<sub>2</sub> tank preliminary sizing and Design of Experiments analysis

Filippo Mazzonei<sup>\*a</sup>, Roberta Biga<sup>b</sup>, Camilo Andrés Manrique-Escobar<sup>b</sup>, Eugenio Brusa<sup>a</sup>,  
Cristiana Delprete<sup>a</sup>

\* corresponding author: [filippo.mazzonei@polito.it](mailto:filippo.mazzonei@polito.it)

<sup>a</sup> Department of Mechanical and Aerospace Engineering (DIMEAS), Politecnico di  
Torino, 10129 Torino, Italy

<sup>b</sup> Leonardo Labs, Leonardo S.p.A., Corso Francia 426, 10146, Torino, Italy

*Keywords: Preliminary design, Hydrogen storage, Aviation*

### Abstract

#### Introduction:

Climate changes have been the reason of increasing interest in alternative solutions to the use of fossil fuels during the last decade. In addition, the efforts towards this direction have been recently and rapidly increasing due to the energetic crisis highlighting the need for alternative and sustainable energy sources for both environmental and geopolitical reasons. Complying with the needs for energy arising from different industrial sectors is a great challenge and there is not a unique answer. In this context hydrogen has the potential to become the solution able to fulfill even the most diverging requirements. As an energy carrier hydrogen can enable the creation of an energy network including different energy sources, as renewables or nuclear, transportation systems, through pipelines, trains or trucks, and final users, like production plants, especially those classified under the so called hard-to-abate sector, or vehicles.

Among the many players involved in this challenging hydrogen revolution, the transports sector also saw an increasing interest in new technologies. Automotive, especially heavy-duty vehicles, maritime and aviation sectors are facing hard technical issues that are transforming the design approaches applied up to now.

#### Objectives:

The aim of the present work is to explore the design space related to the hydrogen storage in the aeronautic sector.

#### Material and methods:

The analysis is then carried out through a model of a liquid hydrogen tank, whose objective is to quantitatively evaluate the outcomes of different solutions. As it can be



# European Fuel Cells and Hydrogen

PIERO LUNGI CONFERENCE

September 13th-15th 2023  
Capri / Italy

seen from the following figure the analysis has been divided into three steps: geometric, mechanical, and thermal design. The hydrogen tank sizing has been carried out by considering the requirements coming from each one of the three design phases, their mutual influences, and the very stringent constraints, commonly known in the aeronautic sector, imposed at the higher system level, like a precisely calibrated quantity of stored fuel to comply with the minimum weight restrictions.

To clearly understand the influence of the many design parameters and to prioritize them a further Design of Experiments (DoE) analysis has been applied.

## Results:

The design of the hydrogen storage tank is performed aiming at satisfying various requirements. The information that can be depicted from the results and the charts resulting from the preliminary analysis are crucial to avoid certain solutions and focus on the most promising ones. The flexible model shown in the present work revealed to be essential in efficiently exploring the design space.

## Conclusions:

The investigation of the outputs coming from the tank sizing model and the DoE analysis revealed to be fundamental in the exploration of the design space and in the definition of a roadmap for the following design phases.

## Acknowledgment

## References

- [1] Brewer, G. Daniel. *Hydrogen Aircraft Technology*. Boca Raton: CRC Press, 1991.
- [2] Winnefeld, Kadyk, T., Bensmann, B., Krewer, U., & Hanke-Rauschenbach, R. (2018). Modelling and Designing Cryogenic Hydrogen Tanks for Future Aircraft Applications. *Energies (Basel)*, 11(1), 105–. <https://doi.org/10.3390/en11010105>

## Accelerated Stress Testing for carbon supports using different ionomers in half-cell gas diffusion electrode setup

Giovanni Marco Carrabba<sup>1,\*</sup>, Alessandro Hugo Antonio Monteverde<sup>1</sup>

<sup>1</sup> Department of Applied Science and Technology, Politecnico di Torino, Corso Duca degli Abruzzi 24, 10129, Turin, Italy.

\*Presenting author: E-mail address: giovanni.carrabba@polito.it (G. Carrabba).

### Abstract

The corrosion of the carbon support in a proton exchange membrane fuel cells (PEMFC) is a critical degradation mechanism. This mechanism is important because affect PEMFC performance through the detachment of catalyst particles from the carbon support, the collapse of the electrode pore network, the breaking of catalyst connectivity, and the increase of the catalyst particle size [1]. In particular, the mainly types of carbon blacks used as support materials for the catalyst are typically degraded by the start-up/shutdown process due to electrochemical oxidation [2]. The Accelerate Stress Testing (AST) protocol for carbon supports (triangular wave potential cycle between +1.0 V and +1.5 V vs RHE with a scan rate of 0.05 V s<sup>-1</sup>), published in 2013 by U.S. DRIVE FCTT, is the most applied to correctly simulates the actual startup/shutdown [3]. In this study, the carbon corrosion was evaluated for ink made of a commercial catalyst (Tanaka-TEC10V50E) with three different ionomers differing in the side-chain structure and equivalent weight (Nafion, Aquivion D98 and Aquivion D79).

The electrochemically active surface area (ECSA), mass and specific activity were evaluated before and after 5000, 10000 and 15000 cycles in order to evaluate the corrosion trend over time for the catalyst layers composed by the three different ionomers.

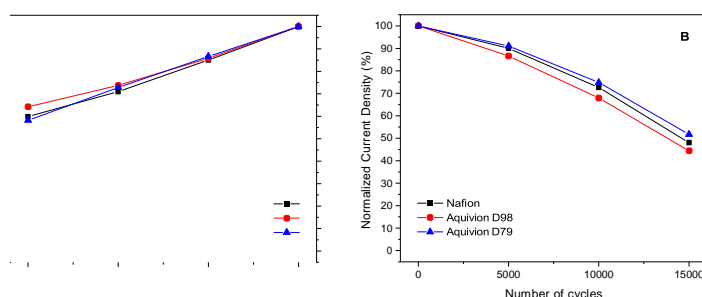

**Fig.1.** (A) ECSA measured at cycles 0 and after 5000, 10000 and 15000 cycle of AST, normalized to the value at beginning of life. (B) Current Density measured at 0.85 V vs RHE at 0 cycles and after 5000, 10000 and 15000 cycle of AST, normalized to the value at beginning of life. Tests were carried out with GDE half-cell set setup in 1 M HClO<sub>4</sub> at 25 °C with a Pt load of about 0.25 mg<sub>Pt</sub>/cm<sup>2</sup> with an ionomer to carbon (I/C) ratio of 1. Modified triangular wave of the AST protocol for carbon support from +1.0 V and +1.5 V to +1.2 V and +1.7 V.

The Fig.1 shows the trend of ECSA and current density (CD) at 0, 5000, 10000 and 15000 cycles of AST, and the values are normalized to the value at beginning of life. In the Fig.1



# European Fuel Cells and Hydrogen

PIERO LUNGI CONFERENCE

September 13th-15th 2023  
Capri / Italy

(A), it can be seen that the ECSA decreases with cycle number which is indicative of dissolution and agglomeration of the Pt nanoparticles. The type of ionomer does not affect carbon corrosion, in fact all three catalyst layers follow the same trend as the number of AST cycles changes. As can be seen in the figure, the same phenomena occurs for the CD, that decreases with cycle number which is again indicative of the decrease of catalyst utilization during the cycling. Also in this case, the type of ionomer does not affect carbon corrosion. The really interesting result is that the ECSA and CD do not decrease significantly dramatically after 15000 cycles. In fact, as can be seen in the Fig. 1 (A), the value of ECSA, regardless of the type of ionomer, decreases by about 40% after 15000 cycles, thus falling widely within the target impose by U.S. DRIVE FCTT [3]. Regarding the CD (Fig, 1 (B)), the value, regardless of the type of ionomer, decreases by about 50% after 15000 cycles, which again falls well within the target [3].

## References:

- [1] N. Macauley, D. D. Papadias, J. Fairweather, D. Spornjak, D. Langlois, R. Ahluwalia, K. L. More, R. Mukundan, and R. L. Borup, *J. Electrochem. Soc.*, 2018, 165, 3148-3160.
- [2] Y. C. Parka, K. Kakinumaa, M. Uchidaa, D. A. Tryka, T. Kaminoa, H. Uchidab, M. Watanabea, *Electrochim. Acta*, 2013, 91, 195-207.
- [3] U.S. DRIVE, Fuel cell Tech Team cell component accelerated stress test and polarization curve protocols for PEM fuel cells, Available from: [https://www.energy.gov/sites/default/files/2015/08/f25/fcto\\_dwg\\_usdrive\\_fc\\_tt\\_accelerated\\_stress\\_tests\\_jan2013.pdf](https://www.energy.gov/sites/default/files/2015/08/f25/fcto_dwg_usdrive_fc_tt_accelerated_stress_tests_jan2013.pdf), (Accessed 23 June 2023).



## Spatially Resolved Catalyst Degradation in PEMFCs under Repetitive Start-Up and Shut-Down Operation

Andraž Kravos<sup>\*a</sup>, Ambrož Kregar<sup>a</sup>, Tomaž Katrašnik<sup>a</sup>

<sup>\*</sup> corresponding author: andraz.kravos@fs.uni-lj.si

<sup>a</sup> Faculty of Mechanical Engineering, University of Ljubljana, Aškerčeva 6, Ljubljana, SI

*Keywords: Fuel cell, Spatially Resolved Catalyst Degradation, Start-up, Shut-down*

**Abstract** Developing accurate models for monitoring and controlling proton exchange membrane fuel cells (PEMFCs) is challenging due to the need to adequately represent physical phenomena while maintaining high computational speed, parameter identifiability and state observability. Gas crossover proves to be one of critical factors affecting FC performance and degradation during start-up (SU) and shut-down (SD). In this work, we present an extension of the modelling framework that considers gas crossover, electrochemical reactions on the platinum band (PB) and its effects on mixed potentials. Furthermore, due to the physicochemical consistent basis and 1D+1D spatial resolution, the potential swing during the SU-SD is inherently modelled, resulting in localised electrolysis operation in FC. The extended modelling framework achieves high predictability and provides insight into the temporal and spatial evolution of local operating conditions that directly influence catalyst degradation.

**Introduction:** PEMFCs are promising for zero-emission automotive and heavy-duty vehicles. Although the progress in terms of lifetime, performance, and efficiency of PEMFCs is undeniable, the degradation phenomena of individual components associated with unavoidable operating conditions such as SU-SD remain a major challenge to overcome. Using advanced control strategies, like virtual sensors, is a promising approach to avoid adverse operating conditions and minimize degradation effects. However, developing virtual sensor models with both sufficient depth and computational speed requires selecting key phenomena, such as gas crossover, which significantly affect PEMFC performance and degradation during SU-SD. To enable appropriate modelling of the SU-SD operating conditions while allowing its use in observer applications, we have recently developed a thermodynamically consistent electrochemical model [1] based on a physics-based 1D+1D two-phase PEMFC model that provides a consistent system-level treatment of the liquid-water dynamics in all most influential regions of the PEMFC [2]. In this work, the model is extended to include the effects of the N<sub>2</sub>, O<sub>2</sub> and H<sub>2</sub> crossover, as well as electrochemical reactions at the PB in the membrane. In addition, the model considers the electrochemical reaction of permeated O<sub>2</sub> with H<sub>2</sub> on the anode side and vice-versa on the cathode side, resulting in a modified mixed potential at each of the PEMFC. As a direct result of these

extensions the newly developed modelling framework not only enables modelling of the potential swing during the SU-SD, which can lead to a localised electrolysis operation in the FC, but also provides a basis for linking to physical modelling of degradation phenomena [3].

**Material and methods:** The crossover of H<sub>2</sub>, O<sub>2</sub> and N<sub>2</sub> through the membrane and their temporal dynamics due to gas diffusion and electrochemical reactions at the PB in the membrane can be written in 1D in the x-direction as:

$$\frac{\partial c_{O_2}(x,t)}{\partial t} = D_{O_2} \frac{\partial^2 c_{O_2}(x,t)}{\partial x^2} + j_{x,O_2}(x = PB, t), \quad \frac{\partial c_{N_2}(x,t)}{\partial t} = D_{N_2} \frac{\partial^2 c_{N_2}(x,t)}{\partial x^2} + j_{x,H_2}(x = PB, t),$$

where D are the diffusion coefficients assumed to be concentration independent and  $j_x$  are the H<sub>2</sub> and O<sub>2</sub> sinks on the PB.

During the validation phase, the developed modelling framework was calibrated on SU of experimental segmented cell (presented in detail in [4]) by differential evolution, varying the values of activation energies, reaction constants and membrane proton conductivity.

**Results:** The experimental sequence was used in a coupled modelling framework to simulate both performance and catalyst degradation, including platinum degradation rate and carbon catalyst support corrosion rate affecting CO<sub>2</sub> mass flow. CO<sub>2</sub> formation is based on the interaction between platinum and carbon oxides and hydroxides, with longer residence time at low or high potential contributing to the formation of C-OH and Pt-OH radicals and OH, respectively. This interaction leads to a significant increase in CO<sub>2</sub> formation as the potential changes. As the potential increases, C-OH is exposed to the Pt-OH and OH radicals formed at high potentials, leading to the reaction: Pt-OH + C-OH → C\* + Pt\* + CO<sub>2</sub> + 2H<sup>+</sup>. This reaction produces CO<sub>2</sub>, which is then continuously produced in smaller quantities at high potential when C-OH reacts with water (COH + H<sub>2</sub>O → C\* + CO<sub>2</sub> + 3H<sup>+</sup> + 3e<sup>-</sup>).

**Conclusions:** The results of the developed modelling framework show a high degree of agreement with experimental data and provide a detailed spatially and temporally resolved evolution of local operating conditions between SU-SD. As such, they enable prediction of the CO<sub>2</sub> emissions. By capturing the latter, the developed modelling framework represents a relatively simple in-situ application of model-based virtual sensors for advanced monitoring and control of PEMFC system, not only from the point of view of performance improvement, but also from the point of view of mitigation and reduction of the degradation rate.

**Acknowledgment:** The research is partially funded by the Slovenian Research Agency (funding No. P2-0401), CD Laboratory for Innovative Control and Monitoring of Automotive Powertrain Systems and European Union's Horizon 2020 Grant Agreement No. 101007170 - MORELife.

## References

- [1] A. Kravos et al. J. Power Sources, 454 (2020), 0378-7753.
- [2] A. Kravos et al. J. Power Sources, 541 (2022) 231598.
- [3] A. Kravos et al. Energies 14, (2021), 4380.
- [4] O. Lottin et al. ECS Transactions, 69, 17, (2015), 1065.



## A Coupled 2D Macro-homogenous MEA model for Proton Exchange Membrane Fuel Cells

Marcus Ringström<sup>\*a</sup>, Henrik Ekström<sup>a,b</sup>, Gabor Toth<sup>c</sup>, Göran Lindbergh<sup>a</sup>, Rakel Wreland Lindström<sup>a</sup>

\* corresponding author: rings@kth.se

<sup>a</sup> Department of Chemical Engineering, KTH Royal Institute of Technology, SE-100 44 Stockholm, Sweden

<sup>b</sup> COMSOL AB, Tegnérgatan 23, SE-111 40 Stockholm, Sweden  
PowerCell Sweden AB, Ruskvädersgatan 12, 41834, Gothenburg, Sweden

*Keywords: Gas diffusion layer, Proton Exchange Membrane Fuel Cell, porosity, flow field*

### **Abstract**

#### **Introduction:**

The Gas diffusion Layer (GDL) plays a key role in Proton Exchange Membrane Fuel Cell (PEMFC) operation as it provides pathways for reactant gas distribution and manages the complex two-phase flow dynamics occurring within the porous structure, at the same time it conducts electrons and distributes heat within the cell. The combination of the high porosity associated with the material and the repetitive flow field land channel structure, compressive mechanical loads exerted on the flow field land induces large spatial variations of the effective porosity field within the GDL which have a large influence on gas distribution, two-phase transport, and heat distribution within the cell [1].

#### **Objectives:**

Very scarce information is found in the literature regarding the influence of different GDLs and flow field design on fuel cell performance. Furthermore, experimental characterization of the orthotropic mechanical properties is limited to a small number of GDLs which reduce the predictiveness of the macro-homogenous models presented in the open literature. This work aims at bridging those gaps by presenting a fully coupled 2D macro-homogenous MEA model that considers orthotropic compression of the GDL and the influence of the inhomogeneous porosity distribution on mass, heat, two-phase and charge transport for GDLs with different characteristics. Ex-situ measurements for a range of different GDLs have been presented in previous work [2].

#### **Material and methods:**



A systematic approach investigating the effects of anisotropy, flow field design, effective diffusivity, capillary-pressure saturation functions and operating conditions on fuel cell performance has been conducted for five different GDLs with different PTFE loadings with and without MPL.

### Results:

Initial results indicate that the inhomogeneous compression exerted on the flow field lands induces spatial variations of the effective porosity which impedes oxygen transport from the flow field land to the catalyst layer. It is observed that the saturation and oxygen transport profiles is highly inhomogeneous and compression dependent.

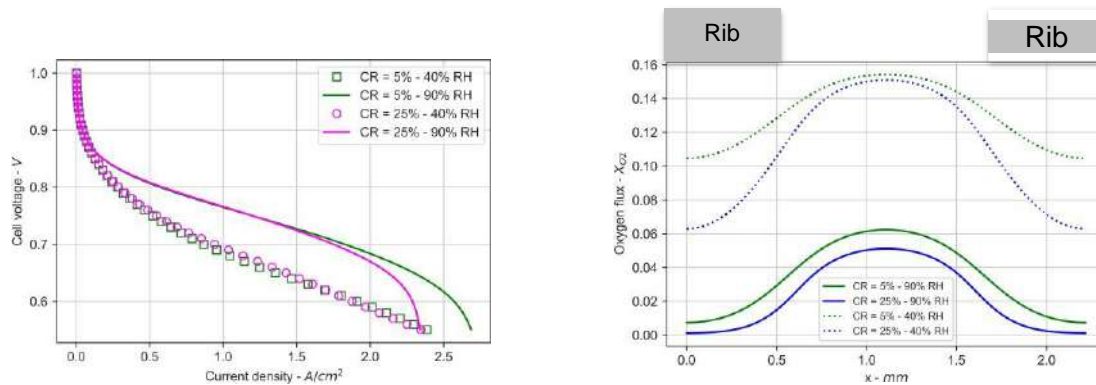

### Conclusions:

Fuel cell performance have shown to be highly dependent on mechanical compression. A sound mechanical characterization of GDLs is therefore of critical importance to assess performance under various operating conditions. Porosity has been identified as a critical property that governs the transport of mass, heat, charge, and water within the cell. For increased model predictiveness, interfacial thermal and electrical contact resistances between adjacent components should be experimentally characterized as a function of compression and implemented in the development of continuum fuel cell models.

### Acknowledgment

Swedish Electromobility Center (project number), PowerCell Sweden AB

### References

- [1] P. A. García-Salaberri, M. Vera, and R. Zaera, "Nonlinear orthotropic model of the inhomogeneous assembly compression of PEM fuel cell gas diffusion layers," *Int. J. Hydrogen Energy*, vol. 36, no. 18, pp. 11856–11870, Sep. 2011, doi: 10.1016/j.ijhydene.2011.05.152.
- [2] Ringstrom *et al.*, "Orthotropic Mechanical and Through-plane Thermal Characterization of Gas Diffusion Layers in Proton Exchange Membrane Fuel Cells", manuscript in progress



## Multiphysics Modeling for Evaluating the Efficiency of Next-Generation PEM Fuel Cells for aviation

Maria Chiara Massaro\*<sup>a</sup>, Elisa Revello <sup>a</sup>, Alessandro Hugo Antonio Monteverde<sup>a</sup>

\* corresponding author: maria.massaro@polito.it

<sup>a</sup>Department of Applied Science and Technology, Politecnico di Torino, Corso Duca degli Abruzzi 24, 10129 Torino, Italy.

*Keywords: Aircraft electrification, aircraft retrofitting, hydrogen technologies, PEM fuel cell modeling*

### Abstract

**Introduction:** Fossil-based aviation fuels need to be replaced with renewable energy carriers in order to meet global climate targets. In this field, a viable long-term solution could be the adoption of hydrogen-powered fuel cells, which offer the advantage of near-zero emissions. Fuel cell prerequisites for mobile applications are high efficiency, fast start up and load following, lightness and compactness. The hydrogen-fueled PEMFC is currently the most suitable technology, but several technological gaps still hinder its employment in the aeronautical field: the removal of large quantities of low-temperature heat, the size of hydrogen storage, and the overall system efficiency. Even optimizing the balance of plant, fuel cell performance remains a central issue: improving efficiency would have a beneficial effect on heat generation, but also on reagents flow rates and auxiliary equipment size.

**Objectives:** In this work, a multi-physics, steady-state 1D model is presented for the assessment of PEMFC performances. The results of the model are used for the sizing of an all-electric regional aircraft, in terms of weight.

**Material and methods:** A semi-empirical model was employed for a preliminary analysis of the main key parameters of a fuel cell [1]. Subsequently, a more complex and accurate 1D model was implemented [2]. The model focuses on the crucial through-plane transport processes and employs a computationally efficient approach based on macro-homogeneous modeling. High-fidelity was achieved through the integration of two-phase flow, non-isothermal effects and the addition of bipolar plates to the most studied geometry of MEA. Finally, the outputs of the model were employed for the retrofitting of a commercial regional aircraft from a kerosene-based system to a PEMFC-based one.



**Results:** The base case study involved a commercially available PEMFC that was reconfigured by varying both the operating conditions and the most impactful features of the geometric layers. Therefore, through a sizing procedure, the optimal characteristics of the PEMFC for the regional aircraft were identified.

**Conclusions:** The combination of semi-empirical, CFD and sizing models could contribute to a general statement of the consolidated FC technologies for the short and medium-range aviation and, at the same time, to an evaluation of the most efficient technologies in a futuristic perspective for new targets derivation.

#### References

- [1] Spinelli P. et al., Journal of Power Sources; doi:10.1016/j.jpowsour.2007.10.040.
- [2] Vetter R., Schumacher J. O., Computer Physics Communication; <https://doi.org/10.1016/j.cpc.2018.07.023>.



## Methodology for design and optimization of straight parallel flow field channels of PEM fuel cell

Delio Casadei<sup>\*a</sup>, Andrea Baricci<sup>a</sup>, Diego Croci<sup>b</sup>, Alessandro Palmieri<sup>b</sup>, Gianmario Picciotti<sup>b</sup> and Andrea Casalegno<sup>a</sup>

\* corresponding author: [delio.casadei@polimi.it](mailto:delio.casadei@polimi.it)

<sup>a</sup> Politecnico di Milano, Department of Energy, Via Lambruschini 4A, 20156, Milano, Italy

<sup>b</sup> Eldor Corporation S.p.A., Via don Paolo Berra 18, 22030, Orsenigo, Italy

*Keywords: flow field, heavy duty, operating conditions, PEM fuel cell.*

### Abstract

**Introduction:** The variation of operating conditions going from air inlet section to air outlet section of a fuel cell stack leads to heterogeneities in performance and to an increase of local degradation. The design of the gas distributors is of primary importance to ensure high efficiency and high durability.

**Objectives:** The work aims to develop a methodology to design the graphite-based flow field of PEM fuel cell, targeting the local geometry optimization of straight parallel channels of cathode gas distributors, to achieve the targets set by the U.S. Department of Energy for heavy duty applications [1].

**Material and methods:** The experimental campaign is carried out with a small-scale testing tool made in-house, with active an area of 10 cm<sup>2</sup>, characterized by straight parallel flow field channels. The reduced active area together with high anode and cathode stoichiometries ensures uniform and controlled operative conditions. Catalyst coated membranes and gas diffusion layers are selected among state of the art materials to ensure good test reproducibility [2].

A 1D model is used to identify the local operating conditions occurring in different positions of the straight parallel channels of a PEMFC stack for heavy duty applications under different load requirements. Graphite-based gas distributors with different channel width and rib thickness are experimentally characterized to determine the effect of each geometric parameter. The results obtained in small-scale configuration under different operating conditions are used to design a full-scale gas distributor with locally optimized geometry.

**Results:** Graphite-based gas distributors with different geometry configurations (Figure 1.A) were produced and tested. Polarization curves under pure oxygen conditions (Figure 1.B) highlight the effect of the ratio between rib thickness and channel width on ohmic loss: the increase of contact surface between GDL and CCM improve the electric contact, reducing the value of high frequency resistance. Each gas distributor geometry was characterized under real operating conditions, the obtained power is reported as function of the channel length (Figure 1.C): ohmic loss affects the region close to the air inlet, while oxygen concentration reduction leads to a consistent performance decrease in the region close to the air outlet section.

**Conclusions:** It has been developed an innovative methodology to locally optimize the geometry of a cathode flow field with straight parallel channels. It has been evaluated the impact of the rib to channel width ration on performance, a higher value is beneficial from the air inlet section up to the middle of the cathode channel length. Mass transport loss becomes the limiting phenomenon from the middle of the channel length up the air outlet section mainly because of the oxygen reduction, in this region the flow field geometry should present lower rib to channel ratio and lower channels cross section area in order to increase gas velocity and to reduce mass transport loss. Relying on the obtained experimental results, the geometry of a full-scale straight parallel flow field can be locally optimized.

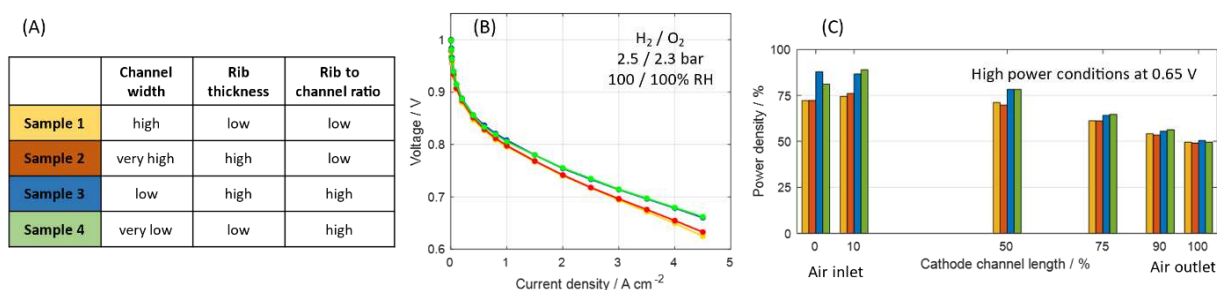

Figure 1. (A) Cathode flow field geometric parameters of tested samples; (B) polarization curves under H<sub>2</sub>/O<sub>2</sub> and 100% RH conditions; (C) power density as function of the cathode channel length computed under high power conditions at 0.65 V.

## Acknowledgment

The author acknowledge Eldor Corporation S.p.A. for the support in the project.

## References

- [1] Adams J. DOE H2 Heavy Duty Trucks Targets (2020).
- [2] Bisello, A., Colombo, E., Baricci, A., Rabissi, C., Guetaz, L., Gazdzicki, P., & Casalegno, A. (2021). Journal of the Electrochemical Society, 168(5).



## Limiting Factors and Mitigation Solutions for Freezing Conditions of Aeronautic PEMFC Systems

G. Montaner Ríos\*, F. Becker, C. Gentner  
German Aerospace Center (DLR)  
Institute of Engineering Thermodynamics  
Hein-Saß-Weg 22, 21129, Hamburg, (Germany)  
Tel.: +49-711-6862-670 Gema.MontanerRios@dlr.de

*Keywords: Aviation, Freezing, Mitigation, PEMFC*

### **Abstract**

The use of proton exchange membrane fuel cells (PEMFC) in aircraft applications to reduce the environmental impact of the aviation sector has gained interest in the last few years due to their high-power density. Nevertheless, under freezing conditions, PEMFCs exhibit limitations that must be overcome prior to their implementation in commercial aviation. During storage at temperatures below 0°C, the water remaining in the cells can freeze and may damage the fuel cell components. Moreover, the ice formed during the freeze start-up reduces the system efficiency and reliability as well as can cause several degradations to the cells. This work summarizes the key limiting factors and describes different methods to reduce degradation due to subfreezing temperatures and to enhance the freeze start of aeronautic PEMFC systems. Furthermore, this study discusses the suitability of the mitigation solutions and strategies to meet the severe requirements of weight, procedures time, degradation, and parasitic energy consumption of the aviation industry and the development state of the technologies. Mitigation solutions to avoid degradation during storage at subfreezing conditions include material selection, single-cell-, stack- and system-improved design (e.g. by reducing thermal mass), preventing the stack from freezing by keeping it warm and avoiding ice formation during storage (e.g. gas purging based solutions at shutdown or using an antifreeze solution). But at extremely low temperatures (e.g. -40°C) eliminating freeze-related damage by using gas purging methods consume too much time and parasitic energy. Therefore, in extreme winter scenarios, the use of an antifreeze solution during storage is recommended. Procedures for freeze start-up are mainly based on heating the stack to achieve temperatures above the freezing point as quickly as possible and can be classified into external heating (e.g. using an electric heater, catalytic burner, or a metal hydride) and internal heating (e.g. controlling the voltage or the reactant gases). Since internal heating solutions don't avoid ice formation completely, they are not recommended at temperatures where relevant ice formation starts to occur (according to the literature -15°C). In addition, guidelines to define robust shutdown and startup



procedures of PEMFC systems at subzero temperatures down to -40 that optimize durability while enabling quick and reliable freeze start are provided.

### **Acknowledgment**

The authors would like to thank the Federal Ministry of Transport and Digital Infrastructure of Germany for the financial support of this work (research project number 03B10704C).



## State-of-Health Observer for Polymer Electrolyte Membrane Fuel Cells

Zhang Peng Du<sup>\*a</sup>, Sandro Kofler<sup>a</sup>, Tit Voglar<sup>b</sup>, Andraž Kravos<sup>b</sup>, Martin Vrlic<sup>a</sup>, Stefan Jakubek<sup>a</sup>,  
Christoph Hametner<sup>c</sup>

\* corresponding author: [zhang.peng.du@tuwien.ac.at](mailto:zhang.peng.du@tuwien.ac.at)

<sup>a</sup> Institute of Mechanics and Mechatronics, TU Wien, Getreidemarkt 9, 1060 Vienna, Austria

<sup>b</sup> Faculty of Mechanical Engineering, University of Ljubljana, Aškerčeva cesta 6,  
1000 Ljubljana, Slovenia

<sup>c</sup> Christian Doppler Laboratory for Innovative Control and Monitoring of Automotive  
Powertrain Systems, TU Wien, Getreidemarkt 9, 1060 Vienna, Austria

*Keywords: degradation, Kalman filter, polymer electrolyte membrane fuel cell, state-of-health*

**Abstract:** The polymer electrolyte membrane fuel cell (PEMFC) is a promising candidate for sustainable mobile applications but is prone to degradation. State-of-health observers assist in extending the lifetime by enabling online diagnosis. This work introduces a novel state-of-health observer simultaneously estimating the PEMFC gas composition (for degradation diagnosis) and a degradation-related time-varying parameter (to assess the state of health). It is based on an extended Kalman filter, and the modeling basis is a control-oriented PEMFC model. The validation is conducted via simulation where artificial degradation is considered, and the excellent estimation results of oxygen mass and ohmic membrane resistance are shown.

**Introduction:** The PEMFC has good prospects for replacing internal combustion engines in mobile applications. However, the challenge of its limited lifetime (e.g., carbon corrosion due to fuel starvation) has to be resolved for increased market penetration. Here, observers assist in resolving the challenge by enabling online diagnosis (e.g., gas composition estimation). Observers simultaneously estimating the current state of health and the internal gas composition for degradation diagnosis of PEMFCs have not been reported in the literature. This paper presents a state-of-health observer based on a control-oriented PEMFC stack model [1] to bridge this knowledge gap. The observer is based on an extended Kalman filter algorithm [2], and it simultaneously estimates the PEMFC gas composition and a degradation-related time-varying parameter (bulk membrane ohmic contact resistance). The validation is conducted in a simulation study, and the estimation results for the oxygen mass ( $MSE = 4 \cdot 10^{-12}$ ) and the membrane resistance ( $MSE = 4 \cdot 10^{-6}$ ) are shown. The estimation performance is excellent, which serves as the basis for experimental validation.

**Fuel Cell Model:** The modeling basis [1] is a zero-dimensional control-oriented PEMFC stack model derived from a 30 kW system test stand. This model is beneficial because it is modeled in a physically motivated way to obtain meaningful internal states, and the concentration modeling is experimentally validated. The model has nine states (four masses each in the cathode and the anode,



membrane water activity), ten inputs (current, temperature, two pressures, two relative humidities, two valve positions, mass flow, power), and five outputs (stack voltage, three pressures, mass flow).

**State-of-Health Observer:** The designed observer is based on [2], an extended Kalman filter algorithm for nonlinear systems. Compared to the standard setting of state estimation, the model state vector is extended with the observed time-varying parameters to estimate them simultaneously. So, changes in degradation-related parameters, which affect the outputs, allow conclusions about the system's state of health. These parameters are modeled as integrated white noise.

**Results:** The designed observer is validated in simulation, and the used excitation signal is a chirp current signal, as given in [1]. The signal is repeated many times to reach an overall experiment length of 100 h, and an increasing trend is artificially implemented to the bulk membrane ohmic contact resistance to demonstrate degradation. Gaussian noise is added to the simulated outputs, serving as the observer's "measured" input, which provides degradation and gas composition information from the "reality." Only the estimation of the cathode oxygen mass and the resistance are shown in Fig. 1 to keep this work concise. The assumed real signals are thick, and the estimated counterparts are thin. In Fig. 1a, the observer corrects the wrong initializations within seconds, and in Fig. 1b, the estimation follows the increasing trend of the resistance over many hours, indicating degradation.

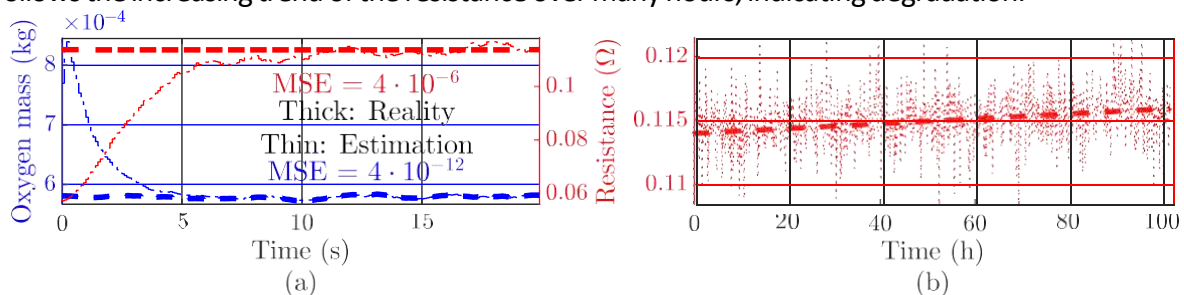

Fig. 1: Estimation results of cathode oxygen and bulk membrane contact resistance. MSE is based on the 100 h experiment.

**Conclusions:** A state-of-health observer was developed based on a control-oriented PEMFC model, which simultaneously estimates gas composition and degradation. It is validated via simulation, and the result is promising to pursue the research in this direction. The following steps are a more in-depth results analysis and a validation with real experimental data.

**Acknowledgment:** This project is supported with funds from the Climate and Energy Fund and implemented in line with the "Zero Emission Mobility" programme (grant number 878123). The research was partially funded by the CD Laboratory for Innovative Control and Monitoring of Automotive Powertrain Systems.

## References

- [1] Du, Z. P., Steindl, C., Jakubek, S., & Hametner, C. (2023). Concentration Estimation for Fuel Cells: Design of Experiments, Nonlinear Identification, and Observer Design With Experimental Validation. *IEEE Access*, 11, 10453–10470. <https://doi.org/10.1109/ACCESS.2023.3241227>
- [2] Bavdekar, V. A., Deshpande, A. P., & Patwardhan, S. C. (2011). Identification of process and measurement noise covariance for state and parameter estimation using extended Kalman filter. *Journal of Process Control*, 21(4), 585–601. <https://doi.org/10.1016/j.jprocont.2011.01.001>

## Real-time estimation of degradation in PEM fuel cells

Johanna Bartlechner\*<sup>a</sup>, Martin Vrlić<sup>a</sup>, Christoph Hametner<sup>b</sup>, Stefan Jakubek<sup>a</sup>

\* corresponding author: [johanna.bartlechner@tuwien.ac.at](mailto:johanna.bartlechner@tuwien.ac.at)

<sup>a</sup> TU Wien, Institute of Mechanics and Mechatronics, Getreidemarkt 9, 1060 Vienna, Austria

<sup>b</sup> TU Wien, Christian Doppler Laboratory for Innovative Control and Monitoring of Automotive Powertrain Systems, Getreidemarkt 9, 1060 Vienna, Austria

*Keywords: dynamic operation, extended Kalman filter, PEM fuel cell, State-of-Health observer*

**Abstract:** A novel approach to estimate degradation of a PEM fuel cell during dynamic operation based on the extended Kalman filter is presented. The algorithm is tested on measurement data. A good agreement between measurement and observer is obtained for the whole lifetime. The estimated change in State-of-Health aligns with literature.

**Introduction:** PEM fuel cell vehicles are considered to be a major contender for electric vehicles due to many advantages, such as high-power density, zero-emission technology and fast refuelling technology. However, the lifetime of fuel cell systems used in dynamic applications is still limited due to degradation, resulting in a significant loss of performance and efficiency over time. To actively prevent degradation during dynamic operation, the use of advanced model-based control strategies is essential. As degradation progresses, the system behaviour changes and the initial model may no longer be able to adequately predict the cell behaviour. To counteract this, state and parameter observers are deployed.

**Objectives:** Using an extended Kalman filter (EKF) and a physically-motivated model [1] augmented with a State-of-Health (SoH) indicator  $\theta_{\text{SoH}}$ , the change in system behaviour due to degradation is estimated. This SoH indicator is correlated with a change in electrochemical properties, in particular the membrane conductivity. The addition of the SoH indicator to the model provides a good match between measurement and observer over the entire lifetime while requiring minimal corrective action of the physical states by the observer and providing information on the current SoH of the fuel cell during operation.

**Material and methods:** A constrained EKF is implemented in combination with a zero-dimensional performance model [1]. The non-linear model is augmented to include a SoH indicator that detects changes in membrane conductivity. The proposed SoH-observer is tested on single cell measurement data [2] imitating driving conditions through the standardised Fuel Cell Dynamic Load Cycle (FC-DLC) protocol.

**Results:** Figure 1 shows the performance of the SoH-observer. At the beginning of life measurement, simulation and observer align and the SoH indicator is estimated to be around one. Over time, the difference between simulation and measurement increases as

degradation is not included in the model. By adjusting the SoH indicator, the observer is able to compensate for this discrepancy (middle and right).

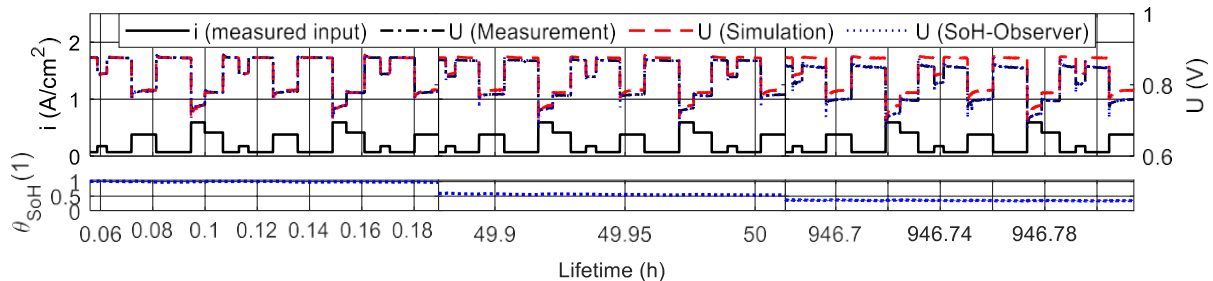

Figure 14: Comparison of voltage responses (measurement (black), simulation (red), observer (blue)) for three points in time. Current and voltage response (top), corresponding estimated SoH indicator  $\theta_{SoH}$  (bottom).

In Figure 2 the measured voltage response (top) during the FC-DLC test is plotted and the evolution of SoH indicator is shown for four points in the life of the cell (bottom). The observed degradation pattern, a steep decline at the beginning of life followed by a flattening curve, is consistent with literature.

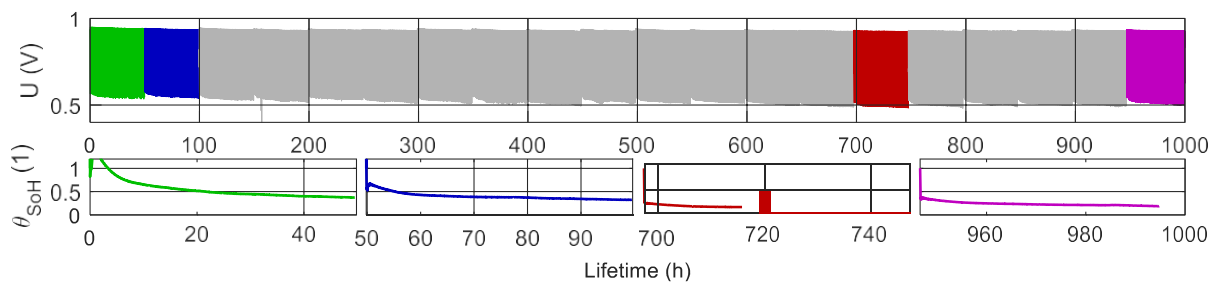

Figure 15: Data for whole lifetime. Voltage during dynamic operation (top), estimated SoH indicator  $\theta_{SoH}$  for four out of 20 consecutive experiments (bottom).

**Conclusions:** A methodology for real-time degradation estimation is presented and tested with measurements. There is ongoing work to extend the algorithm with further SoH indicators and correlating them with specific degradation mechanisms as well as using the methodology to implement model-based control strategies to actively prevent degradation.

### Acknowledgment

This work was supported by the project AlpeDHues (FFG. No. 40604346).

### References

- [1] Ritzberger, D., Hametner, C., Jakubek, S. (2020). A Real-Time Dynamic Fuel Cell System Simulation for Model-Base Diagnostics and Control: Validation on Real Driving Data. *Energies*, 12, 3148. <https://doi.org/10.3390/en13123148>
- [2] Zuo, J., Lv, H., Zhou, D., Xue, Q., Jin, L., Zhou, W., Yang, D., Zhang, C. (2021). Long-term dynamic durability test datasets for single proton exchange membrane fuel cell. *Data in Brief*, 35, 106775. <https://doi.org/10.1016/j.dib.2021.106775>

## Hydrogen fuel cells for decarbonizing inland waterway shipping

M. Rivarolo <sup>\*a</sup>, G.N. Montagna <sup>a,b</sup>, T. Lamberti<sup>b</sup>, S. Barberis <sup>a</sup>

\* corresponding author: [massimo.rivarolo@unige.it](mailto:massimo.rivarolo@unige.it)

<sup>a</sup> Thermochemical Power Group, University of Genoa, via Montallegro 1, 16145 Genoa, Italy

<sup>b</sup> h2boat, via Antonio Cecchi 4/4, 16129 Genoa, Italy

*Keywords: PEM fuel cells; hydrogen mobility; hydrogen integrated systems; modelling.*

This RH2IWER (Renewable Hydrogen for Inland Waterway Emission Reduction) Horizon European Project, launched on 1<sup>st</sup> March 2023 and coordinated by VTT [1], aims at creating a solid basis for the acceleration of hydrogen fuel cell powered vessels in inland waterway shipping by demonstrating six commercially operated vessels. The demonstrative vessels include container, bulk and tanker vessels with installed power in the range 0.6 – 2 MW. The project also includes the study of replication potential in different EU scenarios, considering passenger ferries operating in Italian lakes. This paper aims to present the RH2IWER Project, focusing on a preliminary study for the feasibility on a lake passenger ferry operating in Italy.

**Introduction:** The importance of decarbonizing transport sector is recognized since years at EU level. While some sectors (i.e. rail) have already began quickly this process, reducing the impact in terms of emissions for shipping sector (both maritime and inland waterways) is a process that are still moving the first steps. Today the largest part of ships in operation worldwide and in EU employs high pollutant fuels, based on oil products. In 2018, ships calling at EU and European Economic Area ports emitted around 140 million tons of CO<sub>2</sub> and inland navigation accounted for 13.5% of the EU's GHG emissions [2]. The use of hydrogen fuel cells on vessels represents an important step towards zero emission navigation and has been investigated in many research projects recently [3]. However, the application to several kinds of vessels for inland waterways represents an important innovation.

**Material and methods:** The case study considered for the analysis is the *Tonale* passenger ferry boat, operating in Garda Lake (Italy) and owned by *Navigazione Laghi* company [4]. The vessel can host nearly 1,000 people, has 54.4 m of length and a beam of 10.8 m. It is equipped with two traditional 550 kW engines fuelled by Marine Diesel Oil (MDO). The vessel operates 210 days per year. One of the project's aims is to evaluate the retrofiting, installing a similar power by hydrogen fuel cells, considering H<sub>2</sub> storage in compressed tanks at 350 bar. A preliminary analysis is performed throughout the W-ECOMP software [5], developed by the Thermochemical Power Group at University of Genoa for time-dependent analysis of energy systems. The software is used to simulate a typical navigation day, managing the demand in order to minimize vessel's fuel consumption. Off-design curves and cost functions of the different prime movers (ICE, fuel cells) are implemented in the software libraries.

**Results:** Results are shown in Figure 1 for a typical navigation day (about 8 hours between Garda and Desenzano villages, with one hour stop where H<sub>2</sub> refuelling can be performed). In the original configuration, the propulsion is satisfied by the two engines, with a daily MDO consumption of nearly

1400 litres/day. In the alternative configuration, the demand profile is covered by five 200 kW PEM fuel cells (installed power 1 MW), with limited batteries support for peak shaving. Thanks to high PEMFC efficiency (in particular at partial loads), a significant fuel saving can be obtained. Table 1 compares the two solutions.

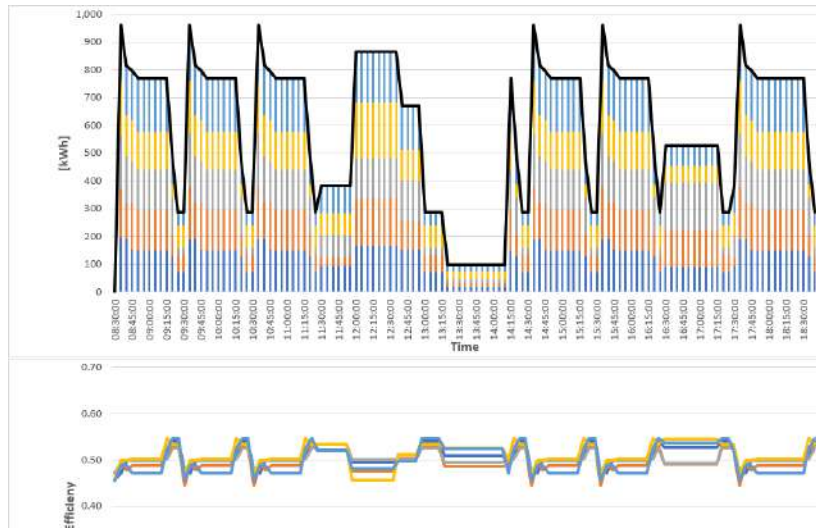

Figure 1: energy production by PEM Fuel Cells and efficiency

Table 1: main daily results

Technology	Modules	Daily el. Demand [kWh]	Daily fuel consumption [kg]	Average efficiency [%]	Daily CO <sub>2</sub> emissions [kg]
ICE - MDO	2 x 550 kW	5410	1180	38.5	3670
PEMFC – H <sub>2</sub>	5 x 200 kW	5410	320	50.6	-

**Conclusions:** The RH2IWER project aims to demonstrate the use of PEM Fuel Cells hydrogen solutions for inland navigation. A first assessment of a technological alternative for passenger ferry in Garda Lake (Italy) is carried out based on real vessel operating there. The analysis, carried out with the W-ECOMP software tool developed by UNIGE, shows good potential of PEMFC according to the vessel's demand profile. The solution will be investigated more in detail in the next future, considering also the integration onboard of the H<sub>2</sub> systems for both propulsion and storage.

**Acknowledgment** The RH2IWER project is supported by the Clean Hydrogen Partnership and its members Hydrogen Europe and Hydrogen Europe Research (grant agreement N. 101101358). Funded by the European Union. Views and opinions expressed are however those of the authors only and do not necessarily reflect those of the European Union. Neither the European Union nor the granting authority can be held responsible for them.

#### References

- [1] <https://cordis.europa.eu/project/id/101101358>
- [2] <https://www.eea.europa.eu/publications/maritime-transport/>
- [3] <https://flagships.eu/>
- [4] [https://www.navigazionealghi.it/wp-content/uploads/2021/08/TONALE\\_Ita.pdf](https://www.navigazionealghi.it/wp-content/uploads/2021/08/TONALE_Ita.pdf)
- [5] <http://www.tpg.unige.it/TPG/portfolio-item/w-ecomp/>



## A Study on Performance Analysis of PEM Fuel Cell Using Real-Time Humidity Distribution Measurement

Young-Jun Sohn<sup>\*a,b</sup>, Hwanyeong Oh<sup>a</sup>, Yoon-Young Choi<sup>a</sup>, Minjin Kim<sup>a,b</sup>, Won-Yong Lee<sup>a</sup>

\* corresponding author: yjsohn@kier.re.kr

<sup>a</sup> Fuel Cell Laboratory, Korea Institute of Energy Research, Daejeon, 34129, Republic of Korea

<sup>b</sup> Advanced Energy and System Engineering, University of Science and Technology, Daejeon, 34113, Republic of Korea

*Keywords: Relative humidity, Fuel cell system, Real-time cell test*

**Introduction:** The ion conductivity of the electrolyte is the most crucial factor influencing the performance of low-temperature polymer electrolyte fuel cells. To maintain or enhance ion conductivity, a high relative humidity within the membrane is required. However, the excessive water flooding caused by high humidity adversely affects mass transport in the catalyst layer. Therefore, finding the optimal humidity conditions is vital for water management in fuel cells. The humidity inside the fuel cell reacts sensitively to variables such as current density, temperature, and pressure, exhibiting an unpredictable non-uniform distribution.

**Objectives:** This study aims to analyze the correlation between the performance characteristics of fuel cells and relative humidity. For this purpose, a cell design was developed to experimentally measure the humidity distribution inside the fuel cell.

**Methods:** In this study, a fuel cell capable of real-time humidity measurement within its internal environment was designed and fabricated, enabling simultaneous performance evaluation and humidity monitoring.

**Results:** We fabricated a large active area fuel cell and conducted IV performance evaluation. To simultaneously evaluate performance and measure humidity distribution, a fuel cell separator plate with humidity sensors was employed. By analyzing the relationship between fuel cell voltage, current, and humidity distribution, we investigated the impact on the performance characteristics of the fuel cell.



# European Fuel Cells and Hydrogen

PIERO LUNGI CONFERENCE

September 13th-15th 2023  
Capri / Italy

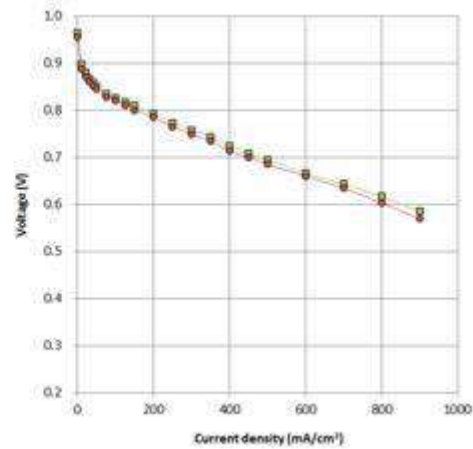
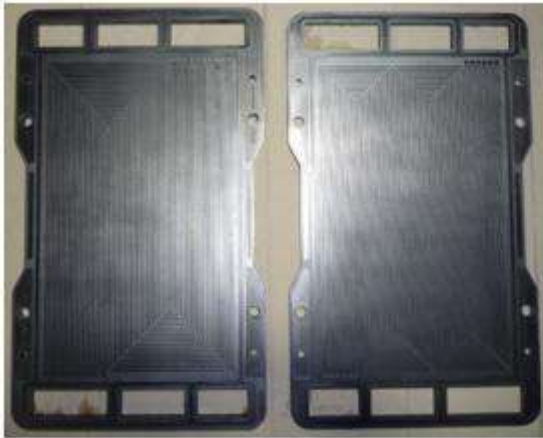

**Conclusions:** The humidity distribution within the fuel cell was found to be highly sensitive to operating voltage, current, and internal temperature, showing a strong correlation. Optimization of humidity distribution is crucial for enhancing fuel cell performance. Key factors for achieving optimal humidity distribution include the design of flow channels in the separator plate and determining the optimal operating conditions.

## Acknowledgment

This work was supported by the Korea Institute of Energy Technology Evaluation and Planning (KETEP) grant funded by the Korean Government (MOTIE) [grant number 20203010030010].

## A novel hybrid method for PEMFC systems fault diagnosis

Chiara Pettorossi\*<sup>a</sup>, Mathias Gerard <sup>a</sup>, Vincent Heiries<sup>b</sup>, Sébastien Rosini<sup>a</sup>

\* corresponding author: [chiara.pettorossi@cea.fr](mailto:chiara.pettorossi@cea.fr)

<sup>a</sup> Univ. Grenoble Alpes - CEA/LITEN, 38054, Grenoble, France

<sup>b</sup> Univ. Grenoble Alpes - CEA/LETI, 38054, Grenoble, France

*Keywords: Artificial intelligence, fault diagnosis, hybrid method, PEM fuel cell.*

### Abstract

**Introduction:** Polymer electrolyte membrane fuel cells (PEMFCs) are the most promising energy conversion devices using hydrogen in the field of transportation. To allow for large-scale development of the PEMFC technology, the research is focusing on reducing the cost and increasing the durability of the systems. Fault diagnosis plays an extremely important role in addressing the problem [1]. In fact, since multiple faults can occur in PEMFCs causing performance loss and degradation, early detection and isolation of such faults can increase the life span of the system. Among the most relevant faults in PEMFCs, in this study we focus on water management faults and starvation faults [2]. These faults cause loss of the active surface and membrane mechanical and chemical degradation, which are permanent deteriorations, and, thus, have a direct impact on the lifetime of the system and must be avoided. Therefore, this study concentrates on fault detection and isolation (FDI) of PEMFC systems, proposing a novel methodology for accurate FDI.

**Objectives:** The objective of the research is to develop an innovative approach that addresses the challenges associated with FDI of PEMFC systems. The methodology is designed to overcome the limitations of the existing techniques, namely pure model-based and pure data-driven methods for fault diagnosis, and achieve high accuracy. While most of the algorithms developed for FDI in a variety of engineering fields rely on the availability of large faulty datasets, this represents a major issue for PEMFCs due to the difficulty of collecting data in real operating systems. To alleviate the problem, we propose a hybrid method combining a physics-based model of PEMFCs and artificial intelligence (AI). The innovative approach aims at reducing the reliance on large data while achieving accurate fault diagnosis. Moreover, the physics-based model is beneficial because it integrates the physics into the AI algorithm, effectively avoiding the much-disputed nature of black-box models.

**Material and methods:** The proposed methodology combines AI algorithms with a physics-based model in a hybrid framework to enhance the performance and robustness of the FDI algorithm, while facing paucity of data. In fact, if data-driven approaches allow to capture



complex non-linear dependencies among data and to extract relevant features for fault diagnosis, the physics-based model allows enlightening the physics of the PEMFC system. The hybridization strategy follows two steps. First, AI is used to correct imperfect parts of the physics-based model, specifically those related to approximations made when modeling the PEMFC system. By so doing, the accuracy of the model is enhanced. Subsequently, the up-to-date physics-based model is used to generate a labeled dataset in a wide range of nominal and faulty operating conditions. The physics-informed data serve to augment the available information for fault diagnosis by complementing experimental data in

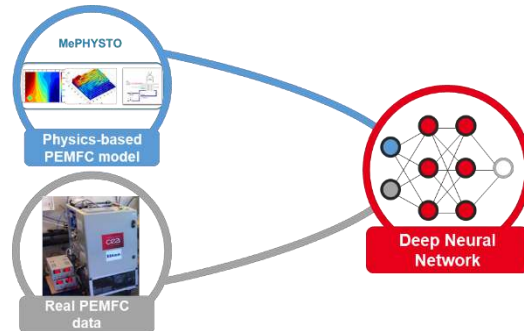

Figure 16 – Proposed hybrid fault diagnosis method.

the training of the FDI algorithm and, eventually, to gain high generalization ability.

**Results:** Although the experimental validation is currently underway, preliminary assessments of the methodology show promising results. Dynamic conditions were simulated using the physics-based model to generate nominal and fault data. Then, the FDI algorithm was trained using this dataset, which incorporates physics information, resulting in a high level of accuracy. This confirms the ability of the physics-based model to reproduce faulty signals in PEMFC systems and suggests that introducing this source when training fault diagnosis algorithms can bring additional, meaningful information. The potential of the methodology to detect and isolate faults, even with limited experimental data, holds significant implications in fault diagnosis of PEMFC systems.

**Conclusions:** This study presents a novel method for PEMFC fault diagnosis. The results highlight the potential of combining a physics-based model of PEMFC with AI to overcome the main issues encountered in fault diagnosis. Future work will focus on further developments and validation of the methodology using experimental data.

### Acknowledgment

This project has received funding from the PEPR-H2, national French project, called Durasys-PAC (<https://www.pepr-hydrogene.fr/projets/durasys-pac/>).

### References

- [1] J. Aubry, N. Y. Steiner, S. Morando, N. Zerhouni, and D. Hissel, "Fuel cell diagnosis methods for embedded automotive applications," *Energy Reports*, vol. 8, pp. 6687–6706, 2022, doi: 10.1016/j.egyr.2022.05.036.
- [2] G. Jullian, C. Cadet, S. Rosini, M. Gerard, V. Heiries, and C. Bérenguer, "Fault Detection and Isolation for Proton Exchange Membrane Fuel Cell Using Impedance Measurements and Multiphysics Modeling," *Fuel Cells*, vol. 20, pp. 558–569, 2020, doi: 10.1002/fuce202000022.

## Development of a procedure for mixture formation analysis for H<sub>2</sub> DI ICEs

Maria Rosaria Gaballo\* <sup>a</sup>, Antonio Arvizzigno<sup>a</sup>, Nello Medoro<sup>a</sup>, Magda Elvira Cassone  
Potenza<sup>a,b</sup>, Giuseppe Anaclerio<sup>b</sup>, Marco Torresi<sup>b</sup>, Sergio Mario Camporeale<sup>b</sup>

\* corresponding author: [MariaRosaria.Gaballo@it.bosch.com](mailto:MariaRosaria.Gaballo@it.bosch.com)

<sup>a</sup> Powertrain Solutions, Engineering PT System Testing IT – CVIT, Modugno, Italy

<sup>b</sup> Department of Mechanics, Mathematics and Management (DMMM), Polytechnic  
University of Bari, Italy

*Keywords: hydrogen, ICE, injection*

**Abstract** Different injection configurations have been compared by means of CFD simulations to assess the quality of the mixing process in a Hydrogen (H<sub>2</sub>) Direct Injection (DI) ICE.

**Introduction:** ICEs powered by H<sub>2</sub> are one of the solutions to gain a carbon-neutral mobility. Due to the properties of a such a fuel, the DI technology is the best option to gain a good volumetric efficiency and to avoid backfiring issues. Therefore, industry is committed in finding the best solutions to get a nearly homogeneous H<sub>2</sub>-air mixture inside the cylinder.

**Objectives:** Authors have compared different injector geometries, injection timings, rail pressure for two operative points to evaluate the homogenization of the H<sub>2</sub>-air mixing.

**Material and methods:** To get insights of the mixing process, Unsteady RANS simulations have been carried out by means of the commercial code AVL Fire. The computational domain has been discretized using a cartesian mesh, setting the mean cell size equal to 1.6 mm [1]. For the turbulence closure, the three-equation k- $\zeta$ -f model has been preferred to the classical k- $\epsilon$  model due to a better computation of the turbulent kinetic energy (TKE). After a validation step, three different injector caps (reported in Figure 2) have been tested, all sharing the same outlet area. The first one (04X) is featured by a fully circular outlet section, with the jet axis inclined of 60° with respect to the cylinder axis. The second one (04XK) is characterized by an annular exit section, and the last cap has six holes equally spaced along the azimuthal direction. To assess the quality of the mixing process, authors have developed a methodology made up of the following steps: **1**) evaluation of the uniformity index (UI) of the charge **2**) comparison of the lambda distribution at spark timing (at 10° bTDC) **3**) assessment of the TKE level induced by the injection.

**Results:** For the sake of brevity, the authors here provide a comparison of the different caps for the operative point featured by a BMEP of 7 bar, an injection pressure of 19 bar, and a lambda of 3. In all of the cases, the start of injection (SOI) is fixed at 155° bTDC. The 04X and

the 6-hole caps provide a greater level of homogenization with respect to the 04XK injector (Figure 1a). At spark-timing, the UI relative to the 04X and the 6-hole caps is 0.89, while the UI of the 04XK is about a 10% smaller. This result is confirmed by the lambda-distributions reported in Figure 2. Interestingly, the mixing process of the 6-hole cap does not lead to the onset of zone featuring a lambda greater than 2, hence NO<sub>x</sub> emission can be expected to be negligible. Higher levels of the turbulent kinetic energy are observed for the 04X and 6-hole caps, which can promote a quicker combustion process (Figure 1b). The analysis of the swirl and tumble indices, not reported here for the sake of brevity, reveals that the 04X promotes the homogenization of the charge by triggering an intense tumble motion, and the same effect is achieved by the 6-hole caps exploiting the swirl motion. Conversely, the 04XK is not able to trigger none of the in-cylinder motions, resulting in a lower uniformity index and wider lambda distribution.

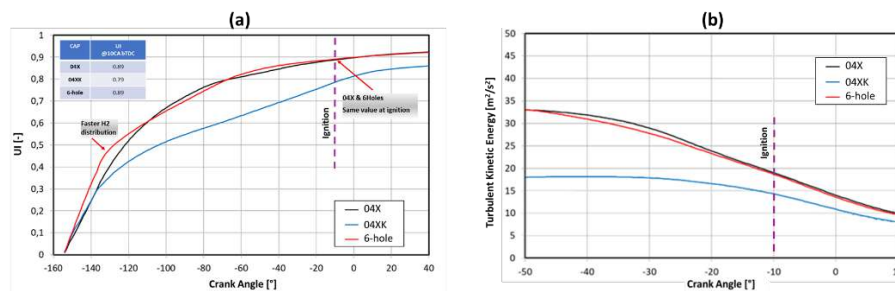

Figure 1: (a) evolution of the UI for the three different caps compared and (b) assessment of the different levels of the TKE.

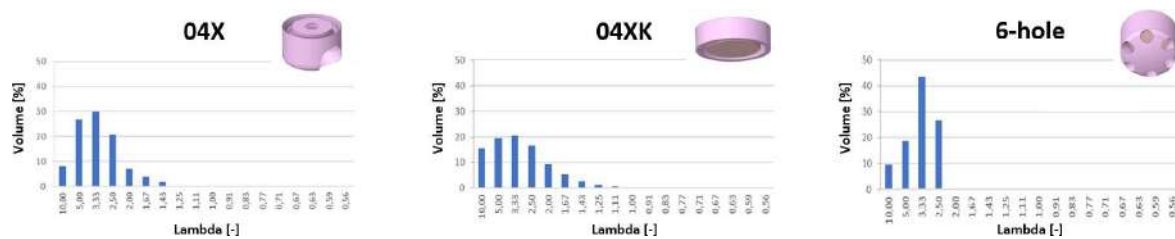

Figure 2: lambda distributions for the three different caps at 10° BTDC.

**Conclusions:** A three-step methodology has been employed to assess the quality of the mixing process in a H<sub>2</sub> DI ICE. The methodology has been applied to compare different injector geometries, revealing how the capability to trigger the swirl and tumble motion – along with possibility to generate turbulence - leads to higher levels of the charge homogenization.

## References

[1] Cassone Potenza, M.E., et al. - 3D CFD analysis of Mixture Formation in Direct-Injection Hydrogen-fueled Internal Combustion Engines, J. Phys.: Conf. Ser. - DOI 10.1088/1742-6596/2385/1/012080



## Optimizing Hydrogen Refueling Station Infrastructure for Heavy Duty Freight Transport in Italy

Antonio DE PADOVA<sup>a</sup>, Francesco Demetrio MINUTO\*<sup>a</sup>, Andrea LANZINI<sup>a</sup>

\*corresponding author: francesco.minuto@polito.it

<sup>a</sup> Energy Center Lab – Polytechnic of Turin, via Paolo Borsellino 38/16, 10152 Turin, Italy

<sup>b</sup> Department of Energy (DENERG) - Polytechnic of Turin, Corso Duca degli Abruzzi 24, 10129, Turin, Italy

*Keywords: hydrogen refuelling stations, heavy duty transport, road freight transport*

### Abstract

**Introduction:** In line with the EU Green Deal and the stated goal of achieving carbon neutrality by 2050, a massive decarbonization of the transport sector is necessary. The reduction of the carbon footprint of the Heavy Duty (HD) transport system, in particular, is crucial for a significant decrease in CO<sub>2</sub> emissions. Even if heavy-duty vehicles represent only the 2% of the total circulating fleet in Europe [1], they account for approximately the 27% of CO<sub>2</sub> emissions related to total road transport and about the 5% of all greenhouse gases (GHGs) emissions in the European Union (EU) [2]. Freight transport trucks, in particular, account for the 85% of these emissions [3]. Therefore, the transition to low- or zero-emission vehicles (ZEV), based on alternative powertrains, is essential to achieve the goals which have been set. Fuel Cell Hydrogen Electric Vehicles (FCHEV) are a promising technology especially for the decarbonization of long-haul freight transport, having greater autonomies and shorter refueling times compared to other alternatives and since no significant payload losses are observed with respect to internal combustion engine vehicles [4]. Since high investment costs are required for the realization of the refueling infrastructure, a proper design and dimensioning are therefore essential to accelerate the diffusion of these vehicles in everyday applications.

**Objectives:** This model can be a useful evaluation tool for strategic choice of the sites in which Hydrogen Refuelling Stations (HRS) should be located. Its purpose is to minimize the costs associated with developing the HRS infrastructure in Italy while identifying the routes where a shift to Fuel Cell Electric Vehicles should be prioritized. This strategic approach aims to have a significant impact on the decarbonization of the entire national freight transport system.

**Material and methods:** A database, developed as part of the ETISPlus project [5], has been used and adapted using the last statistics [6] to provide a comprehensive characterization of freight transport traffic flows at a NUTS-3 level. These data are crucial in identifying the potential routes that could be traversed by FCHEVs. Taking into consideration the decarbonization targets set by the European Union and anticipated technological advancements, various market share scenarios for FCHEVs have been assumed for the year 2030. This timeframe has been chosen as short-to-medium term year for the sizing of the HRS infrastructure.



A market analysis of the nowadays commercially available vehicles was conducted, resulting in the definition of key operational parameters, such as the fuel economy of the vehicles (i.e. specific consumption of hydrogen for a range of 1 km). This value was taken as a conservative input assumption as the efficiency of the powertrain is expected to increase already in the next few years, thus leading to a lower fuel consumption.

An optimization algorithm, the Capacitated Node Flow Refuelling Location Model (CN-FRLM) [7] is used to develop a potential configuration of the HRS infrastructure on the Italian territory. The objective of this algorithm is to minimize the number of facilities to be placed over the Italian E-road network to satisfy hydrogen's demand of the whole FCHEVs' circulating fleet. Initially, an Uncapacitated Node Flow Refueling Location Model (UN-FRLM) is applied to determine the overall hydrogen demand that needs to be met. Subsequently, we introduced nodes to represent the refueling stations, taking into account the capacity constraints defined by H2 Mobility in Germany for refueling Heavy-Duty (HD) vehicles. These standard hubs have a daily capacity of either 2,000 or 4,000 kg [8]. In the latter case, the capacity constraint leads to an increase in the required number of facilities compared to the results obtained from the UN-FRLM.

**Results:** Two configurations of the HRS infrastructure are proposed and illustrated, based on the technological selection for the on board hydrogen storage pressure. Specifically, two options are considered: 350 or 700 bar, which represent nowadays the most mature technologies and widespread solutions in this field. These choices result in different maximum vehicle ranges for the same tank volume. For each configuration a sensitivity analysis is performed, to assess the impact of various parameters (e.g. the assumed initial fuel tank level) on the distribution of the stations within the infrastructure.

**Conclusions:** This optimization model facilitates informed decision-making, driving the strategic development of the HRS infrastructure to support the transition towards sustainable transport solutions in Italy. It identifies optimal deployment locations and prioritizes hub placement, considering two scenarios of technological adoption in hydrogen storage systems.

## References

- [1] ACEA, Report - Vehicles in use Europe 2022, 2022
- [2] European Environment Agency (EEA), "Carbon dioxide emissions from Europe's heavy-duty vehicles", 2020, from: <https://www.eea.europa.eu/themes/transport/heavy-duty-vehicles>
- [3] European Environment Agency (EEA), "Reducing greenhouse gas emissions from heavy-duty vehicles in Europe", 2022, from: <https://www.eea.europa.eu/publications/co2-emissions-of-new-heavy>
- [4] H. Basma, F. Rodríguez, Fuel cell electric tractor-trailers: Technology overview and fuel economy, ICCT, 2022
- [5] European Transport Policy Information System-Development and implementation of data collection methodology for EU transport modelling, "D6 ETISplus Database Content and Methodology", January 2013
- [6] Eurostat, Road freight transport measurement (road\_go), available at: [https://ec.europa.eu/eurostat/cache/metadata/en/road\\_go\\_esms.htm](https://ec.europa.eu/eurostat/cache/metadata/en/road_go_esms.htm)
- [7] P.K. Rose, R. Nugroho, T. Gnann, P. Plötz, M. Wietschel, M. Reuter-Oppermann, Optimal development of alternative fuel station networks considering node capacity restrictions, Transportation Research Part D: Transport and Environment, Volume 78, 2020, 102189, ISSN 1361-9209, <https://doi.org/10.1016/j.trd.2019.11.018>.
- [8] H2-Mobility, Overview Hydrogen Refuelling for Heavy Duty Vehicles, 2021

## Forecasting Of a Degradation Indicator for Proton Exchange Membrane Fuel Cells

Diana Sofía Mendoza\*, Nadia Yousfi Steiner\*, and Daniel Hissel\*

\* Université de Franche-Comté, FEMTO-ST, FCLAB, UTBM, CNRS, Belfort, France

*Keywords: Fuel cell, degradation, forecasting, hybrid-based model*

**Abstract** This work presents a methodology to perform a prediction of a degradation indicator for Proton Exchange Membrane Fuel Cells (PEMFC). The proposed approach uses a hybrid-based fuel cell degradation model to identify the degradation indicator. This work employs Echo State Networks (ESNs) to perform a forecasting of the degradation coefficient.

**Introduction:** Fuel cell technology has gained significant attention as a promising alternative to conventional energy sources due to its high energy efficiency and minimal environmental impact. However, one of the major challenges associated with fuel cell systems is the occurrence of degradation over time, which negatively impacts their performance and lifespan. Evaluating the degradation level of fuel cells offers valuable information about their remaining useful lifetime (RUL), allowing for proactive maintenance measures to be implemented prior to critical failures.

**Objectives:** Identify a degradation factor using a hybrid fuel cell degradation model. Forecast the degradation indicator to determine the end-of-life of the fuel cell.

**Material and methods:** The model propose an empirical coefficient  $\alpha$  representing the degradation of the PEMFC. This coefficient  $\alpha$  has been integrated into the Nerst Equation (1) that describes the voltage model of the fuel cell. Where  $V_0$  represents the reversible cell voltage, the gas constant is denoted as  $R$ , the operating temperature as  $T$ , the Faraday constant as  $F$ , the charge transfer coefficients of the electrodes as  $a$ , the stack internal current as  $i_{loss}$ . The exchange current at the electrodes is represented as  $i_0$ , the equivalent ohmic resistance as  $R_{eq}$ , and the limiting current at the cathode as  $i_L$ .

$$V(i) = V_{fc} - \frac{RT}{2aF} \ln\left(\frac{i_{loss} + i}{i_0}\right) - iR_{eq} - \frac{RT}{2F} \ln\left(\frac{i_L}{i_L - i}\right) \quad (1)$$

The model of degradation proposes the increase of  $R_{eq}$  and the decrease of  $i_0$  over the time at the same rate [1] [2]. A time-varying variable  $\alpha(t)$  is chosen to describe the deviation of the parameters  $R_{eq}$  and the decrease of  $i_0$ , which reflects the state of health of the fuel cell.

$$R_{eq} = R_{eq-init} (1 + \alpha(t)) \quad (2) \quad i_0 = i_{0eqnit} (1 - \alpha(t)) \quad (3)$$

The new model including  $\alpha(t)$  on the Nerst Equation is presented in 4.

$$V(i) = V_{fc} - \frac{RT}{2aF} \ln\left(\frac{i_{loss} + i}{i_0}\right) - iR_{eq} (1 + \alpha) - \frac{RT}{2F} \ln\left(\frac{i_L}{i_L - i}\right) \quad (4)$$



# European Fuel Cells and Hydrogen

PIERO LUNGI CONFERENCE

September 13th-15th 2023  
Capri / Italy

A dataset is necessary to perform the methodology of the degradation coefficient. The PHM2014 data set experiment is selected. The measures of degradation of the voltage over the time of this dataset is presented in blue Figure 2. The degradation model (4) contain parameters that need to be found. Parameters as  $\alpha$ ,  $i_{loss}$ ,  $i_0$ ,  $R_{eq}$ ,  $i_L$  are found using the Levenberg–Marquardt Algorithm (LMA) and the polarization curve for the initial time at 0 hours. The voltage and density current over the time from PHM2014 are organized segments, using LMA an  $\alpha$  is computed for each segment.

**Results:** The identification of the degradation coefficient for 300 segments is presented in Figure 1. To ensure the accuracy of prognostics, the degradation information extracted from the signal is subjected to smoothing using a Savitzky-Golay filter. The values obtained in the Figure 1, the current density, and the model presented in the Equation (4) are used to re-build a new voltage signal. The comparison of the re-built signal and the measures signal is presented in the Figure 2. This, with the objective of demonstrate the capacity of the coefficient to model the degradation. The forecasting of the degradation coefficient is done using ESNs and it is presented in the Figure 3, using 70% of the original data for training the coefficient is predicted 400 steps.

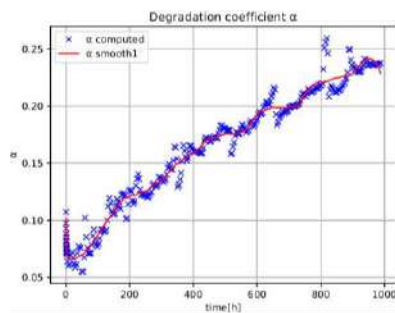

Fig. 1. Degradation Coefficient

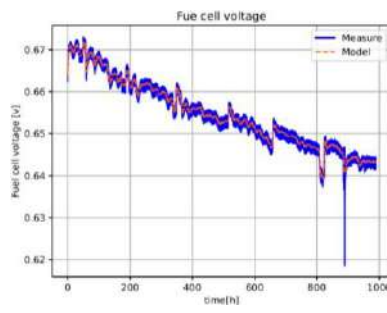

Fig. 2: Fuel Cell Voltage Model

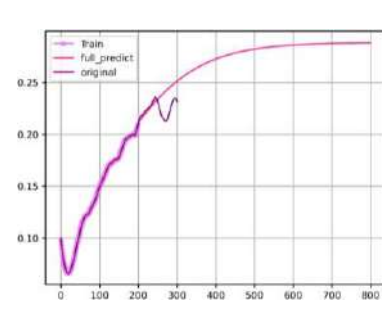

Fig.3: Forecasting of 400 steps

**Conclusions:** This work proposed a methodology to do a long-term forecasting of a degradation indicator for PEMFC. The proposed approach utilized a hybrid-based fuel cell degradation model that incorporates a degradation coefficient into the polarization curve model. This hybrid-based degradation model takes as input experimental data from the dataset PHM2014, including voltage and current measurements over the time and polarization curve characterizations. The output of this hybrid-based degradation model is the degradation coefficient. The prediction of the degradation coefficient, is done using ESN.

## References

- [1] Yue, Meiling, et al. "Degradation identification and prognostics of proton exchange membrane fuel cell under dynamic load." *Control Engineering Practice* 118 (2022): 104959.
- [2] Jouin, Marine, et al. "Degradations analysis and aging modeling for health assessment and prognostics of PEMFC." *Reliability Engineering & System Safety* 148 (2016): 78-95.





## Preliminary Techno-economic assessment on small scale Methanol based-Solid Oxide Fuel Cell system for maritime application

S. Di Micco <sup>\*a</sup>, A. Alfano<sup>b</sup>, M. Innerkofler<sup>c</sup>, V. Cigolotti<sup>d</sup>, M. Minutillo<sup>e</sup>

\* corresponding author: [simona.dimicco@uniparthenope.it](mailto:simona.dimicco@uniparthenope.it)

<sup>a</sup> Department of Engineering, University of Naples “Parthenope”, Naples, Italy

<sup>b</sup> ELCOGEN OY, NIITTYVILLANKUJA 4, VANTAA 01510, Finland

<sup>b</sup> AVL LIST GMBH, HANS-LIST-PLATZ 1, GRAZ 8020, Austria

<sup>d</sup> ENEA - Italian National Agency for New Technologies, Energy and Sustainable Economic Development, Naples, Italy

<sup>e</sup> Department of Industrial Engineering, University of Salerno, Fisciano, Italy

*Keywords: methanol, hydrogen carrier, zero-emission vessels, shipping decarbonization.*

**Abstract:** This study aims to analyse an innovative naval propulsion solution to favour the decarbonisation process of maritime transportation sector.

**Introduction:** Methanol is a potential alternative fuel for maritime transport; its usage allows having meaningfully reduction in atmospheric SO<sub>x</sub>, NO<sub>x</sub>, PM and CO<sub>2</sub> emissions. The interest in using methanol as fuel for maritime sector is rapidly growing.

**Objectives:** In this study, a small-scale methanol-based SOFC system for the propulsion of zero-CO<sub>2</sub> vessel has been analysed through a techno-economic point of view.

**Material and methods:** This study is focused on the tecno-economic assessment of a methanol-based SOFC system. The SOFC stack is the ElcoStack E3000 developed by Elcogen (3kW). Figure 1 shows the system layout. The system has been modelled and the numerical results have been used for performing economic evaluations based on the definition of two economic KPIs: the Specific Capital Expenditure (S<sub>CAPEX</sub>) and the Specific Operating & Maintenance Expenditure (S<sub>O&M</sub>):

$$KPI_1 = S_{CAPEX} = \frac{C_{inv} + C_{BoP}}{Installed\ Power\ kW} \left[ \frac{\text{€}}{kW} \right] \quad (1)$$

$$KPI_2 = S_{O\&M} = \frac{C_{operating} + C_{maintenance}}{Installed\ Power} \left[ \frac{\text{€}}{kW} \right] \quad (2)$$

Table 1 summarizes the investment costs as well as the operating and maintenance costs for the SOFC stack and the BoP of the system.

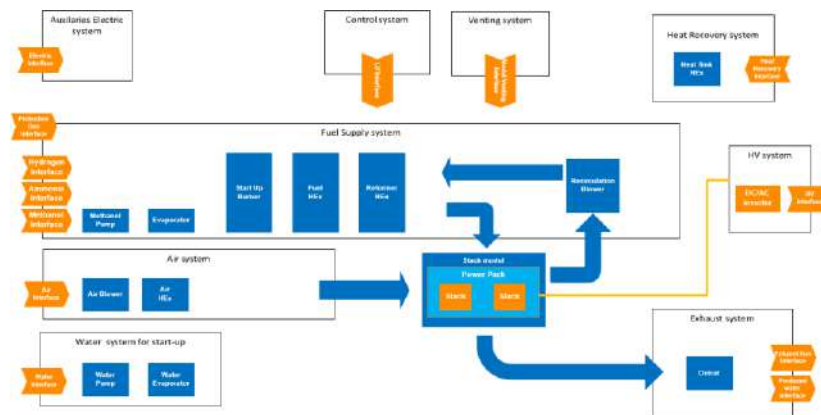

Fig.1. Methanol-based SOFC system schematic layout

Table 1. Cost items for the Methanol-based SOFC system

Components	Investment Cost [1]	Maintenance Cost [2]	Operating Cost [3]
SOFC stack module	900\$/kW	5% * C <sub>inv</sub>	
SOFC BoP	172.5% * C <sub>inv</sub>	5% * C <sub>inv</sub>	
Methanol			0.5 €/kg (av. value)

**Results:** From technical point of view, the main operating conditions are listed in Table 2. From the economic perspective, the defined KPIs are equal to 2452.5 €/kW and 122.91 €/kW for  $KPI_1$  and  $KPI_2$ , respectively.

Table 2. Operating conditions of the Methanol-based SOFC system

Stream	Temperature (°C)	Pressure (bar)	Mass flow (kg/h)
Air blower	20	1.079	31.02
Methanol Pump	30	1.128	1.69
Recirculation Blower	283	1.124	4.86
Reformer HE	480	1.112	6.56
Air HE	558	1.045	31.02
Exhaust	677	1.039	8.67

**Conclusions:** The proposed energy system for the maritime application is still quite expensive but the possibility of using renewable methanol allows achieving environmental advantages.

**Acknowledgment:** This research received fundings from Horizon 2020 (G.A.101069828).

## References

1. S. Samanta, D. Roy, S. Roy, A. Smallbone, and A. P. Roskilly, *Renew. Sustain. Energy Rev.* **179**, 113278 (2023)
2. Battelle Memorial Institute, *Manufacturing Cost Analysis: 1, 5, 10 and 25 KW Fuel Cell Systems for Primary Power and Combined Heat and Power Applications* (2017)
3. H. Zhang and U. Desideri, *Energy* **199**, 117498 (2020)



## Towards the design of a hydrogen-powered ferry for zero-emissions passenger transport

G. Di Ilio<sup>a,h\*</sup>, A. Bionda<sup>b</sup>, R. Ponzini<sup>c</sup>, F. Salvatore<sup>c</sup>, V. Cigolotti<sup>d,h</sup>, M. Minutillo<sup>e,h</sup>, C. Georgopoulou<sup>f</sup>, K. Mahos<sup>g</sup>

\* corresponding author: [giovanni.diilio@uniparthenope.it](mailto:giovanni.diilio@uniparthenope.it)

<sup>a</sup> University of Naples "Parthenope", Department of Engineering, Naples, Italy

<sup>b</sup> Politecnico di Milano, Department of Design, Milan, Italy

<sup>c</sup> CINECA – HPC Department, Rome, Italy

<sup>d</sup> ENEA - Italian National Agency for New Technologies, Energy and Sustainable Economic Development, Naples, Italy

<sup>e</sup> University of Salerno, Department of Industrial Engineering, Salerno, Italy

<sup>f</sup> DNV, Piraeus, Greece

<sup>g</sup> Levante Ferries, Athens, Greece

<sup>h</sup> ATENA Future Technology, Naples, Italy

**Keywords:** *hydrogen-fueled ship; virtual towing tank; zero-emissions maritime transport*

**Abstract:** This paper proposes a methodological approach aimed at supporting the retrofit design process of a car-passenger ferry, operating in the Greece's western maritime zone, whose conventional powertrain is replaced with a fuel cell hybrid system. Basing on the energy requirements of the vessel retrieved from data provided by the shipping company, three hybrid powertrain configurations are proposed and, for each of them, a new vessel layout is defined to allocate the new components. Finally, the developed vessel configurations are simulated in a virtual towing tank environment, in order to assess their hydrodynamic response in comparison with that for the original one.

**Material and methods:** The vessel under investigation is the *Fior Di Levante*, a RoPax ferry managed by the Greek operator Levante Ferries, for the carriage of people (up to 1200 passengers), commercial vehicles and private cars, that is a case-study in the framework of the EU-funded HORIZON 2020 project e-SHyIPS. This ferry is propelled by 2 Diesel-engines of 3520 kW nominal power each, and it also equipped with 4 auxiliary Diesel-gensets, each having 650 kW of nominal power.

In the proposed hydrogen-powered configuration of the ship, all main and auxiliary Diesel engines are replaced by a hybrid fuel cell/battery system, connected to azimuthing electric motors to propel the ship. The main requirement for the new H<sub>2</sub> vessel is that it has to achieve the same performance of the original vessel. Therefore, the H<sub>2</sub> powertrain is designed upon the evaluation of the overall power requested to the energy systems of the original vessel.

The design strategy pursued in the rearranging of the on-board technical spaces attempts to minimize the impact of new H<sub>2</sub> system adoption without modifying decks number, and hull shapes and with minor changes in term of vessel's centre of gravity. To this aim, a 3D model was developed for each of the three configurations. Full and mid load conditions were then examined via LincoSim tool, a

virtual towing tank, in order to assess the hydrodynamic performance of the proposed H<sub>2</sub>-based layout, in terms of drag resistance in calm water conditions.

**Results:** The underlying design concepts behind the three proposed solutions, the size of fuel cell (FC) and battery, and the computed H<sub>2</sub> consumption, for each case, are summarized in the following Table:

Config. #	Description	FC rated power [MW]	Battery pack capacity [MWh]	H <sub>2</sub> consumption [kg/day]
1	Battery neglected; FC sized on total installed power of original vessel.	9.64	0	2192
2	Battery sized on a one-day at berth conditions; FC sized on max power request during sailing.	7.52	13.4	1648
3	Battery sized for peak power requests. FC sized on power requested for sailing at a speed of 15 kn	5.26	2.3	2278

The computed drag profiles for full load conditions are shown in the next Figure as an illustrative example, along with the relative percentage difference with respect to the baseline configuration.

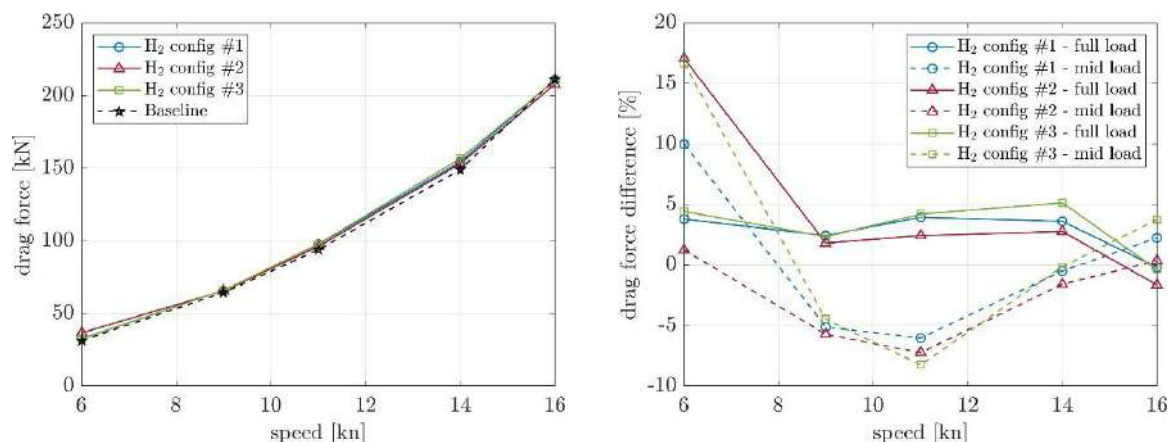

The general trend of the drag resistance over speed remains substantially the same, among all vessel's configurations, when considering both full and mid load conditions. This result provides that all the designed hydrogen-powered vessel's layouts do not lead to any disadvantage in terms of hydrodynamic performance.

**Conclusions:** Findings from this analysis show that: i) overall, minimal but not negligible differences are found among the baseline Diesel and the new hydrogen vessels configurations, and ii) the hydrodynamic performance of the three H<sub>2</sub>-based configurations are very close to each other in both full and mid load conditions. This points out the need of choosing the best hybrid configuration for the vessel mainly on the base of use-case requirements rather than hydrodynamic aspects.

**Acknowledgment:** This research has received funding from the Fuel Cells and Hydrogen 2 Joint Undertaking (now Clean Hydrogen Partnership) under grant agreement No 101007226, project e-SHyIPS.



## Innovative thermal management systems for fuel cell electric aircraft applications

Stefano Favre<sup>\*a</sup>, Castrese Di Marino<sup>b</sup>, Flavio Di Fede<sup>b</sup>, Eugenio Brusa<sup>a</sup>, Cristiana Delprete<sup>a</sup>

<sup>\*</sup> corresponding author: stefano.favre@polito.it

<sup>a</sup> Department of Mechanical and Aerospace Engineering (DIMEAS), Politecnico di Torino, 10129 Torino, Italy

<sup>b</sup> Leonardo Labs, Leonardo S.p.A., Corso Francia 426, 10146, Torino, Italy

*Keywords: Aviation, Electric Propulsion, Fuel cells, Thermal management*

### Abstract

**Introduction:** The topics of product sustainability and pollutant emission reduction have all become increasingly relevant factors in the design and approval of the latest generations of engineering devices, especially in the transport field. Total or partial electrification of propulsion systems emerged as the most promising solution to the problem, with the automotive industry already proposing a relatively wide selection of products.

The aerospace sector, however, is still struggling to present designs suitable for competitive mass transport, with the currently available models being mostly single-seat aircrafts. The main hindrance to the introduction of significant on-board electrification relies in the very low energy-to-weight ratios offered by currently available electric energy storage solutions. Amongst them, hydrogen powered fuel cells, and their associated storage devices, represent a more promising candidate, when compared to batteries and supercapacitors. However, despite providing favourable energy-to-weight ratios, the significantly lower efficiency of the fuel cell stacks (about 50% of the total hydrogen stored power), introduces important amounts of waste heat that needs to be effectively dissipated. Therefore, optimal design of aircraft-based Thermal Management System (TMS) is to be considered a crucial asset in the development of the next generation of more electric, medium to big scale aircraft.

**Objectives:** Taking into consideration all previously presented issues, the intended purpose of this paper is the investigation, analysis, and description of the various TMS solutions currently available in the aerospace literature, with the purpose to identify the models and methods most suited specifically for the development of hybrid-electric aircrafts.



Furthermore, a deepening about fuel tank-heat sink solutions is specifically carried out, while a preliminary proposal of requirements analysis is conducted for said architecture.

**Material and methods:** Deep investigation of the available literature was the starting point of this study. Prosecuted by the means of Scopus library and other relevant texts, this research led to an ample collection of related articles. Upon completing a bibliographic and bibliometric study of the results, acquired knowledge is applied in a preliminary evaluation of a possible TMS for medium sized aircraft by the means of MBSE approach.

**Results:** Advantages and disadvantages of each proposed cooling system are presented. Examples of applications are proposed for each architecture, when available, and possible enhancement solutions and challenges are also be described. Particular attention is placed on the conceptualization of systems suitable for a fuel cell, hybrid-electric, medium scale aircraft. Consequently, designs exploiting the potential heat capacity of the stored kerosene are taken into greater consideration, with a brief confront amongst the various possible fuel heat sink architectures being presented. Finally, a preliminary study of the system requirements associated with such solution is proposed, via the exploitation of Model Based System Engineering (MBSE) methodologies.

**Conclusions:** The investigation of all currently available aviation based TMS offers a wide selection of possibilities when it comes to the selection of components, architectures, and systems. Amongst them, solutions capable of exploiting the heat capacity of stored jet-fuel to absorb hydrogen fuel cell generated waste heat, appear as a most favourable proposal for hybrid aircraft applications.

## References

- [1] Kellermann, H., Habermann, A.L., Vratny, P.C., Hornung, M., 2020. Assessment of fuel as alternative heat sink for future aircraft. *Applied Thermal Engineering* 170, 114985. <https://doi.org/10.1016/j.applthermaleng.2020.114985>
- [2] Liu, Y., Lin, G., Guo, J., Zhu, J., 2022. Dynamic prediction of fuel temperature in aircraft fuel tanks based on surrogate. *Applied Thermal Engineering* 215, 118926. <https://doi.org/10.1016/j.applthermaleng.2022.118926>
- [3] Manna, R., Ravikumar, N., Harrison, S., Goni Boulama, K., 2022. Aircraft fuel thermal management system and flight thermal endurance. *Trans. Can. Soc. Mech. Eng.* 46, 308–328. <https://doi.org/10.1139/tcsme-2021-0146>
- [4] Van Heerden, A.S.J., Judt, D.M., Jafari, S., Lawson, C.P., Nikolaidis, T., Bosak, D., 2022. Aircraft thermal management: Practices, technology, system architectures, future challenges, and opportunities. *Progress in Aerospace Sciences* 128, 100767. <https://doi.org/10.1016/j.paerosci.2021.100767>



## Assessing the Competitiveness of Hydrogen Trains: Uncertainties, Sensitivity Analysis, and Regional Perspectives

Antoine Belleguie<sup>\*ab</sup>

\* corresponding author

<sup>a</sup> AME Dpt., Gustave Eiffel University, Champs-sur-Marne 77420, France

<sup>b</sup> Alstom, Research and Development, Saint-Ouen-sur-Seine 93400, France

*Keywords: hydrogen trains; decarbonization; energy price; sensitivity analysis*

### Abstract

**Introduction:** As the push for decarbonization in the rail industry continues, hydrogen trains have emerged as a promising alternative to traditional diesel-powered locomotives. However, the competitiveness of hydrogen trains, as well as their technical feasibility, environmental impact, and economic assessment, varies across different geographical regions. This study aims to provide a comprehensive analysis of these factors, focusing on the adoption of hydrogen trains as a decarbonized traction alternative.

**Objectives:** The main objectives of this study are to evaluate the competitiveness of hydrogen trains compared to other decarbonized rail alternatives by assessing the Total Cost of Ownership (TCO) and Total External Costs (TEC) associated with their implementation and to identify regional differences in the choice of decarbonized traction, and explore the factors influencing these choices.

**Material and methods:** A combination of calibration and sensitivity tests, empirical application of linear regression models, and the identification of uncertainties will be employed in the analysis. The TCO and TEC of hydrogen trains will be assessed by considering the Total Cost of Acquisition (TCA), operating costs (including energy cost, driver cost, track access charges, insurance cost, and extra costs), and maintenance cost (predictive, preventive, and corrective). External costs, such as climate change, air pollution, noise pollution, and accidents, will also be analyzed. Real-world experiences and market deployment challenges associated with hydrogen trains will be investigated, focusing on different geographical regions.



**Results:** The results will highlight the regional variations in the adoption of hydrogen trains, as well as the technical feasibility, environmental impact, and economic assessment in different regions. By considering both the environmental impact and the economic equation over the lifetime of the rolling stock, this study allows for a comprehensive and advanced understanding of the competitiveness of hydrogen rail solutions. It enables comparisons of this competitiveness with other decarbonized alternatives and the current diesel-powered solution, highlighting the importance of evaluating these interconnected factors together. Furthermore, the study will provide insights into the uncertainties and challenges faced by decision-makers when considering hydrogen trains as a decarbonized traction alternative.

**Conclusions:** This research will offer valuable insights into the competitiveness of hydrogen trains such as the factors influencing the choice of decarbonized traction in different geographical areas and the challenges in adopting hydrogen trains as a sustainable alternative to diesel-powered locomotives. The findings will contribute to the understanding of the hydrogen train market and inform decision-makers in the rail industry.

### **Acknowledgment**

We would like to express our gratitude to the SPLOTT laboratory of Gustave Eiffel University and Alstom for their support throughout this research.

### **References**

- [1] Bigo, S. (2020). Green traction alternatives in the rail industry: A review of current technologies and future trends. *Journal of Rail and Transport Engineering*, 12(3), 45-58.
- [2] Lelieveld, J., Klingmüller, K., Pozzer, A., Burnett, R. T., Haines, A., & Ramanathan, V. (2019). Effects of fossil fuel and total anthropogenic emission removal on public health and climate. *Proceedings of the National Academy of Sciences*, 116(15), 7192-7197.





## BIIM - Design and development of an electric vessel equipped with Salt Battery, PEMFC and Metal Hydride Storage

Giaime Niccolò Montagna<sup>a,b</sup>, Thomas Lamberti<sup>b</sup>, Stefano Barberis<sup>a,b</sup>, Massimo Rivarolo<sup>a</sup>, Aristide F. Massardo<sup>a</sup>

\* corresponding author: [Stefano Barberis – stefano.barberis@unige.it](mailto:stefano.barberis@unige.it)

<sup>a</sup> Università degli Studi di Genova – Department of Mechanical Engineering – Thermochemical Power Group

<sup>b</sup> BluEnergyRevolution scarl

*Keywords: Fuel Cell Vessel, metal hydride, PEMFC, hybrid propulsion*

### Abstract

The goal of this paper is to present the results of BIIM (Battello Ibrido Innovativo Modulare) project whose goal is to develop and realize an electric vessel equipped with Salt Battery, PEMFC and Hydride Storage. In the paper the main phases of project development are presented with a focus on the on-board integration (from an electrical, thermal and safety point of view) of both a 45 kW PEMFC and a Metal Hydride Storage.

**Introduction:** Fuel Cell (FC) equipped vessels are more and more developed all around the world, both for propulsion and on-board electricity generation [1], nevertheless demonstration projects are currently underway and complex both for regulatory and vessel design compatibility aspects. At the same time, the ambitious targets set by the International Maritime Organization (IMO) for reducing greenhouse gas emissions from shipping require radical actions and potentially hybridization of solutions. In order to tackle IMO challenges it is therefore important to: i) study potential hybrid layouts where FCs can interoperate with other clean energy solutions (E.g. battery), ii) promote small scale demonstration projects to collect relevant lessons learnt and pave the ground for future upscale and demonstration. Starting from authors' experience in designing FC equipped vessels [2][3] and operating FC in maritime/marina environment [3][4], this paper presents the results of BIIM project, from its design approach up to the realization of hybrid boat prototype (presented on 31<sup>st</sup> March 2023). The project valorised the design an existing vessel with an overall length of 13 meters, has a wooden hull and superstructure with covering in natural fibres and resins.

**Objectives:** BIIM project foresaw the design and construction of an integrated life-size prototype using environmentally sustainable materials (wood), with diesel Internal Combustion Engines (ICEs - 2x90 kW) and electric propulsion (2x30 kW), powered (via an innovative hybrid transmission) by salt batteries and PEMFC (45 kW) coupled with a metal hydride storage (MH AB<sub>5</sub> type – 6 kg H<sub>2</sub> – identified as most relevant H<sub>2</sub> storage on board for safety and balancing aspects). The role of PEMFC is mostly to operate as range extender of salt batteries, whose management needs to be properly taken into account not only at electric level but at thermal level (as well as MH) too due to their nature. At this purpose the project tackled different on-board integration challenges (electric, safety and ventilation, thermal management) to be briefly presented in this paper/presentation.

**Material and methods:** BIIM Hybrid Boat design initially foreseen, was updated along the project lifetime, also to tackle different challenges that the consortium encountered: among them realization of ventilated areas and hydrogen venting to guarantee on-board safety, optimal management of heat sources on board (e.g. heat from FCs, heat from ICEs, saltwater valorisation for cooling..), high power DC buses, PEMFC case (starting from a NUVERA E-45 module) to guarantee self-ventilation, optimal design of MH storage ("towers") to guarantee thermal management, on-board integration and vessel balancing...

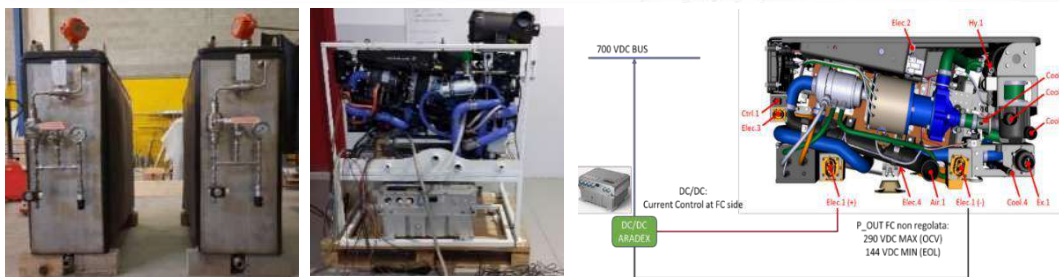

Fig.1 Technological solutions installed on board (MH towers, PEMFC system and power converter solution for integration with battery)

**Results:** Thanks to the cooperation of all BIIM consortium partners, the project targeted a first executive design of the vessel (increasing the power capacity of PEMFC and batteries – as well as their energy capacity) and then their realization and integration on board of the BIIM hybrid boat that has been presented in Lavagna marina on 31<sup>st</sup> March 2023.



Fig.2 Pictures from BIIM Hybrid boat first launching sailing in Lavagna Marina in March 2023

**Conclusions:** This paper presents the main challenges that the BIIM project encountered to design and realize a hybrid boat equipped with diesel ICEs, battery and PEMFCs able to operate with zero emissions. The vessel will now operate for five years in Golfo dei Poeti area, for touristic and local marina services. Next steps and R&D activities will be mostly dedicated to: sailing testing campaign monitoring, identification of most suitable hydrogen refuelling strategies, vessel certification and classification, vessel control enhancement (e.g in this moment the shift from ICE to electric sailing has to be performed with the propulsion system off) etc.

**Acknowledgment:** Project co-financed by the Liguria European Regional Development Fund 2014-2020. Consortium led by Duferco Engineering and involving NAMES, Costruzioni Navali Tigullio, Blue Energy Revolution, Vulkan Italia and I.Mar.S.

## References

- [1] Elkafas, A.G.; Rivarolo, M.; Gadducci, E.; Magistri, L.; Massardo, A.F. Fuel Cell Systems for Maritime: A Review of Research Development, Commercial Products, Applications, and Perspectives. *Processes* 2023, 11, 97. <https://doi.org/10.3390/pr11010097>
- [2] E. Gadducci, T. Lamberti, M. Rivarolo, L. Magistri, Experimental campaign and assessment of a complete 240-kW Proton Exchange Membrane Fuel Cell power system for maritime applications, *International Journal of Hydrogen Energy*, Volume 47, Issue 53, 2022, Pages 22545-22558, ISSN 0360-3199, <https://doi.org/10.1016/j.ijhydene.2022.05.061>.
- [3] E. Gadducci, T. Lamberti, M. Rivarolo, L. Magistri, Experimental campaign and assessment of a complete 240-kW Proton Exchange Membrane Fuel Cell power system for maritime applications, *International Journal of Hydrogen Energy*, Volume 47, Issue 53, 2022, Pages 22545-22558, ISSN 0360-3199, <https://doi.org/10.1016/j.ijhydene.2022.05.061>
- [4] T. Lamberti, A. Sorce, L. Di Fresco and S. Barberis, "Smart port: Exploiting renewable energy and storage potential of moored boats," *OCEANS 2015 - Genova*, Genova, Italy, 2015, pp. 1-3, doi: 10.1109/OCEANS-Genova.2015.7271376.



## FLAGSHIPS – Zero Emission Vessels for European Rivers

Jyrki Mikkola<sup>\*a</sup>, Mathieu Longueville<sup>b</sup>, Dirk de Jong<sup>c</sup>, Christina Mikkelsen<sup>d</sup>, Alexandre Bellot<sup>e</sup>, Pavel Berg<sup>f</sup>, Arber Haxhiu<sup>g</sup>, Pål Gunnar Eide<sup>h</sup>, Colin Bettini<sup>i</sup>, Marius Knutsen<sup>j</sup>

\* corresponding author: [jyrki.mikkola@vtt.fi](mailto:jyrki.mikkola@vtt.fi); +358401701744

<sup>a</sup> VTT Technical Research Centre of Finland, Espoo, Finland

<sup>b</sup>Compagnie Fluviale de Transport, Le Havre, France

<sup>c</sup>Future Proof Shipping, Rotterdam, Netherlands

<sup>d</sup>Ballard Power Systems Europe, Hobro, Denmark

<sup>e</sup>LMG Marin, Toulouse, France

<sup>f</sup>LMG Marin AS, Bergen, Norway

<sup>g</sup>ABB, Helsinki, Finland;

<sup>h</sup>SEAM, Norway

<sup>i</sup>Persee, Lyon, France

<sup>j</sup>NCE Maritime CleanTech, Stord, Norway

*Keywords: hydrogen, inland waterway, PEM fuel cells, shipping*

### Abstract

**Introduction:** The whole shipping industry is going through a systemic change which will last over the coming decades. Use of conventional fossil fuels is now recognized as unsustainable motivating a transition towards zero-emission operations. Clean hydrogen and fuel cells are one of the most promising options for true zero-emission shipping. When using hydrogen as a fuel, fuel cells only emit water and heat as local emissions. Pure hydrogen and PEM (polymer electrolyte membrane) fuel cells have reached sufficient technical maturity to be implemented on board vessels. This option is particularly suited to the inland waterway sector because of shorter routes and lower power requirements. This means that energy storage needs and propulsion power are lower than for example in deep sea shipping.

**Objectives, material and methods:** FLAGSHIPS is an EU funded project which aims to deploy two commercially operated hydrogen-fueled vessels. In the river Seine in the center of Paris (FR), a self-propelled barge will be used to deliver goods along the river. The other demonstration vessel is a container vessel operating between Rotterdam (NL) and Duisburg (GE). In both demonstration cases, compressed clean hydrogen, produced locally with electrolyzers powered mainly by renewable electricity, will be used. With these two demonstration cases the benefits of hydrogen-based power train in waterborne applications will be showcased. Vessels are expected to start operations during 2023. After the 18 month demonstration period in the project, shipowners aim and expect to maintain the ships in normal commercial operation.



**Results:** The key learnings in design and deployment of PEM fuel cell based power train for shipping will be presented. Also, during the project, valuable information has been gathered from the classification and approval process of novel solutions with hydrogen as a fuel.

**Conclusions:** The project concentrates on the development and deployment of hydrogen fuel cells in commercial operation in inland waterways. These technologies for zero emission shipping have reached sufficient technical maturity to constitute viable alternatives for the decarbonisation of shipping. However, the lack of prescriptive rules for hydrogen (storage, utilisation, delivery,...) remain the largest bottleneck to the massive roll out of such solutions. Thus, early and extensive collaboration with class societies and approving bodies is critical to the success of hydrogen and fuel cell based shipping.

### **Acknowledgment**

The FLAGSHIPS project has received funding from Clean Hydrogen Partnership (previously Fuel Cells and Hydrogen 2 Joint Undertaking) under grant agreement No 826215. This Joint Undertaking receives support from the European Union's Horizon 2020 research and innovation program and from Hydrogen Europe.



## Economic and environmental life cycle assessment of diesel, natural gas, biomethane, electric and hydrogen bus systems for extra urban public transportation

Claudio Carbone<sup>\*a</sup>, Nicola Sanzò<sup>a</sup>, Rodolfo Mero<sup>a</sup>, Riccardo Dorsini<sup>b</sup>, Giuseppe Nigliaccio<sup>a</sup>, Fernando Ortenzi<sup>a</sup> and Alessandro Agostini<sup>a</sup>

\* corresponding author: [claudio.carbone@enea.it](mailto:claudio.carbone@enea.it)

<sup>a</sup> Department of energy technologies and renewables, Italian National Agency for New Technologies, Energy and Sustainable Economic Development (ENEA), Italy

<sup>b</sup> Department of Management, University of Sapienza, Rome, Italy

*Keywords: biomethane, hydrogen; LCA; LCC; transportation sector.*

### Abstract

**Introduction:** The transportation sector emits one third of the total EU greenhouse gas (GHG) emissions. It plays a crucial role in the current effort for the reduction of fossil fuels consumption both to reduce GHG emissions and to improve air quality. In Italy, the transportation sector is mainly reliant on fossil fuels, such as gasoline and diesel: in the case of bus vehicles, 93.3% are powered by diesel and 4.4% by methane. Electrification or the use of hydrogen can be powerful drivers in the decarbonization of the mobility system while ensuring a domestic and secure energy supply. Public transportation and publicly managed fleets are the fastest means for the decarbonization as they can be directly influenced by public administrations and supported by public funding. Local air quality issues and high levels of pollution are one of the main drivers to promote the transition from Diesel to Battery Electric Vehicles (BEV) or Fuel Cell Electric Vehicles (FCEV) bus fleets in urban areas by policy makers. In this regard, both technologies BEV and FCEV have no harmful tailpipe harmful combustion emissions and thus fully comply with the aim of improving air quality. If the environmental scope goes beyond the local urban air quality, life cycle assessment (LCA) studies can provide a clearer view of the environmental impact of the different bus technologies, when considering the electricity mix and the technology applied for the hydrogen production (steam reforming from natural gas SMR or electrolysis using electricity from renewables).

**Objectives:** In this study, we compare the economic and environmental performances of different bus technologies by modelling the systems in a case study of extra urban public transport in the City of Rome.

**Material and methods:** An attributional environmental LCA was performed to provide a comprehensive assessment of the potential environmental impacts (the energy demand, the



GHG emissions and the overall atmospheric particulate matter emissions) and benefits associated with the operation of the different buses used for public transportation in Rome. Five different value chains were compared in this study: traditional diesel engine, electric powertrain (BEV), hydrogen fuelled (FCEV), methane (CNG) and biomethane (from manure, waste and maize/sorghum) fuelled vehicles. A life cycle cost analysis (LCC) was also performed on the same systems, based on the calculation of the total cost of ownership (TCO, €/km). The function of the systems modelled is fuelling the extra urban buses fleet of Rome (200 km per day per vehicle), while the functional unit is vehicle running for one km (vkm).

**Results:** The high energy efficiency of the BEV buses has a clear positive impact in terms of GHGs emissions and energy demand. In all scenarios analysed, BEV show a positive environmental performance with respect to the diesel baseline system. We can state that BEV has a clear positive environmental impact even if the electricity used is not 100% renewable but more than 50% of the mix is based on fossil fuels (current national electricity mix) as in the present Italian case study. The switch to FCEV leads to more differentiated environmental figures, due the lower energy efficiency of this technology: from very negative and worse than the diesel option if hydrogen is produced from steam-methane reforming (grey hydrogen), and even worse if the electrolyser process for the hydrogen production is supplied by the current national electricity mix (yellow hydrogen); while they can be considered a valid solution, and comparable to BEV, if contributing to a further penetration of renewable electricity by producing hydrogen from renewable energy resources (green hydrogen). Biomethane buses are competitive, in terms of environmental performances, if the feedstock used is manure and organic biowaste, while for the use of energy crops lead to negative outcomes.

The LCC results show that the TCO of hydrogen buses is always higher than the other systems, while the bus system fuelled by biomethane from biowaste is the most convenient, not taking into account the use phase. Increasing the mileage, in the range 170-200 km electric buses become cheaper than buses fuelled by biomethane from maize and in the range 250-300 km results even cheaper than diesel and CNG vehicles.

These results are to be considered valid only in a context where the range of BEV is sufficient to guarantee operability for a full day of passenger transport.

**Conclusions:** In literature the economic and environmental performance of different extra urban transport system technologies are not fully explored in a consistent way; studies normally are limited to the comparison of a limited number of technologies, while we included all potential alternatives for extra urban road buses. Our results show that hydrogen and biomethane will be able to contribute to the efforts for transport decarbonisation, working together with electrification and not in competition with it, filling that gap that could not be technically or cost-effectively covered by batteries.



## SHIPFC: A European Project for Green Shipping

A.K. Stubos<sup>1</sup>, E. Stamatakis<sup>1,2</sup>

<sup>1</sup>National Centre for Scientific Research Demokritos, Greece

<sup>2</sup>Institute of Geoenergy, FORTH, Greece

*Keywords: Green Shipping, Green Ammonia Energy System, NH3 Powered SOFC*

### **Abstract**

The Ship FC European project is demonstrating a full-scale ammonia fuel cell system on board a commercial vessel. When realised, it will give ship owners confidence in ammonia as a fuel and Solid Oxide fuel cells as a future solution. Demonstrating this in an energy system of MW scale on a commercial ship is an extremely bold endeavour - only made possible by a visionary and courageous consortium.

Being a frontrunner in such a new technology is a demanding task, and the ShipFC project is currently experiencing a number of challenges, which, among others, affect the project timeline. Solid Oxide Fuel Cells still have an immature value chain, where suppliers are in the process of establishing their business models. As a frontrunner pushing the boundaries of Megawatt-sized fuel cells, ShipFC is experiencing that this value chain is not yet fully set up for large-scale production.

So far, the research carried out in the ShipFC project has yielded positive results, paving the way for solid oxide fuel cells as a valid route toward emission-free shipping. Recently, project partner Alma Clean Power announced the achievement of a key milestone, as their design of the 1 MW ammonia fuelled SOFC system, received Approval in Principle from DNV.

Particular aspects related to the safe use of ammonia on-board the ship are examined through modelling and simulations and certain examples will be discussed in the presentation.

### **Acknowledgment**

SHIPFC has received funding from the Fuel Cells and Hydrogen Joint Undertaking under Grant Agreement No 875156. This Joint Undertaking receives support from the EU Horizon 2020 Research & Innovation programme and from Hydrogen Europe.



## A comprehensive experimental investigation on the fuel cell powertrain of a yard tractor for sustainable port handling operations

Altomonte, A. <sup>\*a</sup>, Di Ilio, G. <sup>a</sup>, Pianese A<sup>a</sup>., Cigolotti, V. <sup>b</sup>, Jannelli, E. <sup>a</sup>

\* corresponding author: [andrea.altomonte001@studenti.uniparthenope.it](mailto:andrea.altomonte001@studenti.uniparthenope.it)

<sup>a</sup> Dept. of Engineering University of Naples Parthenope Naples, Italy

<sup>b</sup> ENEA

*Keywords: Fuel cell hybrid vehicle, CAN acquisition system, Electric powertrain testing, Fuel cell testing*

### **Abstract**

This paper explores the potential of hydrogen-fuelled powertrains as an eco-friendly solution for sustainable transportation, with a focus on logistics operations in ports. To this aim, the paper investigates on the conversion of a heavy-duty diesel engine of a yard tractor into a hybrid fuel cell/battery powertrain.

The study conducts experimental measurements on a dynamic test bench, using real duty cycles obtained from an on-field acquisition campaign for a yard tractor operating in the port of Valencia, Spain. Real-time data is collected through custom instrumentation from the CAN bus system of the vehicle.

A set of preliminary tests is initially performed for the original diesel engine of the vehicle. Afterwards, a detailed analysis is conducted for the newly designed fuel cell electrified powertrain. Special emphasis is put on the electric motor and fuel cell characterization. The efficiency of the fuel cell powertrain and the hydrogen consumption during a typical work-shift of the vehicle are evaluated. Finally, an accurate estimation of the kinetic energy recovery through regenerative braking along the duty cycles is provided. The results demonstrate that energy recovery significantly reduces the request of energy to the power unit needed to accomplish the duty cycles, with respect to the original powertrain, thus leading to reduced amount of hydrogen fuel for a single work-shift. This research highlights the significance of fuel cell powertrain testing methodologies in promoting the adoption of fuel cell vehicles and sustainable transportation practices in the maritime industry.





# European Fuel Cells and Hydrogen

PIERO LUNGI CONFERENCE

September 13th-15th 2023  
Capri / Italy

## TOPIC 6: HYDROGEN FOR INDUSTRY



## Feasibility Analysis of Green Ammonia Production Based On Solid Oxide Electrolysis Cell Technology

Fiammetta Rita Bianchi<sup>a</sup>, Dario Bove\*<sup>a</sup>, Lucia Cardona<sup>a</sup>, Riccardo Risso<sup>a</sup>, Barbara Bosio<sup>a</sup>

\* corresponding author: [ing.dariobove@gmail.com](mailto:ing.dariobove@gmail.com)

<sup>a</sup> Department of Civil, Chemical and Environmental Engineering (DICCA),  
University of Genova, Via Opera Pia 15b, Genova, 16145, Italy

*Keywords: Feasibility Analysis, Green Ammonia, Plant Simulation, Solid Oxide Electrolysis Cells*

**Abstract:** Ammonia is a rising candidate as energy vector in view of a higher volumetric density, an easier transport in liquid phase and a safer storage with respect to hydrogen. Moreover, its production process can be coupled with renewable sources (Power to Ammonia approach) to cope with the huge energy demand for hydrogen and nitrogen reactant formation as well as ammonia synthesis. A such configuration has different advantages showing low environmental impacts and permitting NH<sub>3</sub> local production; nevertheless, further improvements are still needed aiming at efficiency increase and process design optimization. Here, the authors propose a promising solution which involves the solid oxide electrolysis cell technology as the hydrogen source in view of its low consumption and effective heat management with ammonia synthesis reactor. The process was evaluated through plant simulations in Aspen Plus underlining peculiarities and drawbacks.

**Introduction:** Ammonia is one of the most common industrial chemicals which is involved in the manufacture of several products and more recently as an alternative energy carrier to direct hydrogen use. The state-of-art process at industrial scale consists of Haber-Bosch loop which allows a quite pure ammonia production (> 99%) from hydrogen and nitrogen. Nevertheless, it has a significant energy consumption due to N<sub>2</sub> strong triple bond, requiring high temperatures and pressures to favour reaction kinetics, and high GHG emissions deriving commonly hydrogen from hydrocarbons (Methane to Ammonia) [1]. Aiming at ammonia production decarbonization, the research has focused on identifying innovative solutions which allow mild reaction conditions or alternative reactants to avoid molecular nitrogen [2]. Since these processes are not competitive yet, the most effective solution consists of revamping traditional Haber-Bosch plants by introducing more eco-friendly processes for hydrogen production, such as biomass thermochemical decomposition (Biomass to Ammonia) and water electrolysis (Power to Ammonia) [3].

**Objectives:** In this framework, the work presents a feasibility analysis of green ammonia production based on solid oxide electrolysis cell technology upstream Haber-Bosch loop. The reference process was evaluated in term of energy efficiency and reactant demand, compared to also possible alternative plant designs using solid oxide cell as oxygen concentrator [4].

**Methods:** The reference Power to Ammonia process is schematized in *Figure 1*, considering the coupling with renewable sources. The plant simulation was performed in Aspen Plus, where different

sub-processes were analysed: (i) solid oxide cell electrolysis cells for hydrogen generation, (ii) cryogenic air separation unit for nitrogen production and (iii) Haber-Bosh loop including a refrigeration unit for ammonia removal and reactant recirculation. Ammonia synthesis was modelled through an equilibrium reactor. Whereas a simplified version of SIMFC/SIMEC (SIMulation of Fuel Cells and Electrolysis Cells), an ad-hoc in home-built Fortran code executable on Aspen Plus, was used for solid oxide cell performance prediction. It consists of a 0D stationary model, where material and energy balances are solved for hydrogen and oxygen electrode side respectively applying a detailed electrochemical kinetics [5].

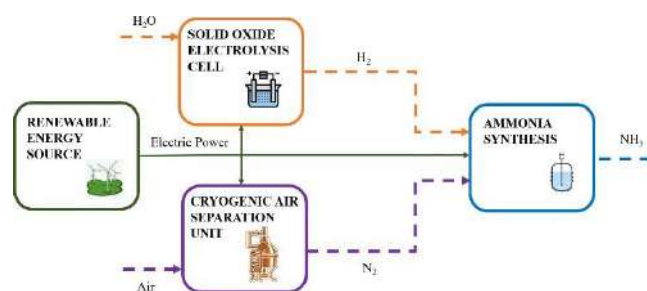

Figure 17: Power to Ammonia plant.

**Results:** The target capacity is a  $\text{NH}_3$  production of more than 120 ton/day. Stacked cells consist of anode supported design with an active area of  $127.8 \text{ cm}^2$  each, working at around  $750 \text{ }^\circ\text{C}$  and 1 bar. Whereas the ammonia synthesis occurs under  $500 \text{ }^\circ\text{C}$  and 200 bar feeding pure hydrogen and nitrogen in a molar ratio equal to 3. *Table 1* summarizes the main results.

Table 4: Main performance of Power to Ammonia reference plant.

Parameter	Value
Produced ammonia [ton/h]	5.2
Purity degree [%]	>99
Required hydrogen [ $\text{Nm}^3/\text{h}$ ]	11,200
Required nitrogen [ $\text{Nm}^3/\text{h}$ ]	3,733
Electric power [MW]	43.7

**Conclusions:** Despite the significant electricity demand with respect to traditional Methane to Ammonia plants (up to 70%), the proposed process can avoid GHG emissions and compact the plant design producing pure hydrogen within a single unit. Moreover, high temperature cell technology reduces the electrolysis energy consumption (around 25% lower than low temperature cells) and optimizes the system thermal balance using the heat available from exothermic steps to generate the steam feed.

## References

- [1] K. Lee et al., Green Chem. 24 (2022) 4830–4844.
- [2] A.G. Olabi et al., Energy Convers. Manag. 277 (2023) 116594.
- [3] D.R. MacFarlane et al., Joule. 4 (2020) 1186–1205.
- [4] J.B. Hansen et al. ECS Trans. 91 (2019) 2455–2465.
- [5] F.R. Bianchi et al, Energies 13 (2020) 5058.



## Techno-economic Analysis and Optimization of Hybrid Energy Storage Systems for Decarbonization in Energy-Intensive Industries

Francesco Demetrio Minuto<sup>\*a,b</sup>, Marcel Stolte<sup>a,b</sup>, Andrea Lanzini<sup>a,b</sup>

\* corresponding author: francesco.minuto@politpo.it

<sup>a</sup> Department of Energy, Politecnico di Torino, Corso Duca degli Abruzzi 24, 10129 Torino, Italy

<sup>b</sup> Energy Center Lab, Politecnico di Torino, Via Paolo Borsellino 38/16, 10138 Torino, Italy

*Keywords: ybrid energy storage systems, Hydrogen-based gas turbines, Industry decarbonization, Techno-economic analysis*

### **Abstract**

**Introduction:** Climate change and increasing CO<sub>2</sub> emissions have intensified the need for decarbonization in energy-intensive industries. Hydrogen has emerged as a promising alternative fuel source for gas turbines [1].

**Objectives:** This study aims to explore the potential of hydrogen in decarbonizing energy-intensive industries and evaluate the role of hybrid energy storage systems, consisting of electrochemical and hydrogen storage.

**Material and Methods:** We simulate a scenario with 100% renewable grid electricity and a CO<sub>2</sub> tax policy, comparing a business-as-usual (BAU) methane-based gas turbine model with a hydrogen-based gas turbine model. Design parameters, such as the size of photovoltaic plants, wind turbines, batteries, electrolyzers, and hydrogen storage, are varied. Particle swarm optimization and genetic algorithms are employed to optimize the hybrid storage system, minimizing costs and environmental impacts [2].

**Results:** Our analysis reveals the feasibility and environmental benefits of implementing hydrogen-based energy storage systems in energy-intensive industries. Key parameters, such as electricity cost, CO<sub>2</sub> cost, and capital expenditure (CAPEX), significantly influence the sizing and design of the plant.



Conclusions: The study provides a comprehensive understanding of hydrogen's potential as a sustainable alternative to traditional energy sources, contributing to global efforts to reduce CO<sub>2</sub> emissions and address climate change.

## References

- [1] Alhuyi Nazari, M. et al. (2022) 'Utilization of hydrogen in gas turbines: A comprehensive review', *International Journal of Low-Carbon Technologies*, 17, pp. 513–519. doi:10.1093/ijlct/ctac025.
- [2] Hannan, M.A. et al. (2020) 'Review of optimal methods and algorithms for sizing energy storage systems to achieve decarbonization in microgrid applications', *Renewable and Sustainable Energy Reviews*, 131, p. 110022. doi:10.1016/j.rser.2020.110022.



## TOPIC 7: INTEGRATED HYDROGEN SYSTEMS



## Dynamic modeling and simulation of alkaline water electrolysis system

Dohyung Jang<sup>a</sup>, Haeseong Shin<sup>a</sup>, Jinyoung Ham<sup>a</sup>, Heesun Shin<sup>a</sup>, Sanggyu Kang<sup>\*a</sup>

\*corresponding author: sgkang@snu.ac.kr

<sup>a</sup> Department of Naval Architecture and Ocean Engineering, Seoul National University; 1 Gwanak-ro, Gwanak-gu, Seoul 08826, Republic of Korea

*Keywords: Alkaline water electrolysis system, Dynamic modeling, Hydrogen production, System optimization*

### Abstract

**Introduction:** As renewable energy capacity is rapidly expanding, discharged or curtailed energy is increasing as well. At this time, Power-to-Gas technology which converts surplus power into hydrogen and stores it is considered a promising way can solve this problem. However, due to unstable renewable power generation, the water electrolysis system is exposed to very fluctuating loads which greatly affected hydrogen production efficiency.

**Objectives:** Our previous studies [1], [2] on the steady state of the system were conducted to determine the optimal conditions which maximize hydrogen production. It presented the development of a simulation model of the alkaline water electrolysis system and the performance for major variables such as temperature, pressure, and electrolyte flow rate. However, it did not concern the system performance during the transient state. It is needed to develop a dynamic model that can determine the response characteristics of the system to load change and analyze the sensitivities of variables.

**Material and methods:** In this study, a two-dimensional dynamic model of an alkaline water electrolysis system was presented using Matlab-Simulink<sup>®</sup>. The model was developed based on numerical methods through physical phenomenon analysis such as energy transport and mass transport. The stack consists of a diffusion layer and electrode for both the cathode and anode sides and a diaphragm layer in the middle. The model divides each layer in the longitudinal direction as well and analyzes a total of 20 control volumes to determine the dynamic behavior. Physics changes at each volume are applied to cell voltage calculations to find changes in the electro-chemical performance of the stack. Meanwhile, among the system BOPs, heat exchangers and pumps have the dominant influence on the response delay. The

response of such devices to the target condition change was simulated in consideration of heat mass or fluid flow inertia.

**Results:** The developed AWE stack dynamic model was simulated for changes in operating conditions such as operating temperature, pressure, and electrolyte circulation flow rate. In particular, through conditional constraint simulations, it was possible to understand the delay in dynamic response due to the mass transfer and heat transfer, respectively. It is investigated how each physics affects cell voltage profile formation and is analyzed its influence by time series. The convergence delay right after the load change was created by the mass transfer model. The influence caused by the energy transfer delay is followed by those caused by the mass transfer. The ohmic overvoltage was the dominant voltage component that represents both influences.

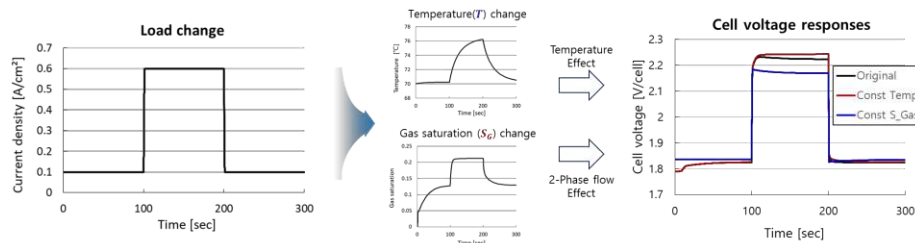

**Figure 18: Dynamic load change and voltage response by featured physics**

**Conclusions:** Through the analysis of simulation results, it is possible to present optimal conditions for improving the dynamic response of the water electrolysis system to load changes. At this time, there are contrary results to the optimization direction derived from the static system analysis of the previous studies. Thus, the optimization plan may be chosen according to the purpose of the system operation. Based on the results of this study, it is planned to analyze the actual hydrogen production efficiency that reflects the dynamic response characteristics of water electrolysis when applying the renewable energy generation profile.

## Acknowledgment

## References

- [1] D. Jang et al., Numerical modelling and analysis of the effect of pressure on the performance of an alkaline water electrolysis system, *Applied Energy* 287 (2021).
- [2] D. Jang et al., Numerical modeling and analysis of the temperature effect on the performance of an alkaline water electrolysis system, *Journal of Power Sources* 506 (2021).





## Reversible PEM Fuel Cell Modeling: A Comprehensive Analysis

Mirosław Maciąg, Jarosław Milewski\*

\* corresponding author: [jaroslaw.milewski@mail.com](mailto:jaroslaw.milewski@mail.com)

Warsaw University of Technology, Faculty of Power and Aeronautical Engineering, 21/25  
Nowowiejska street

*Keywords: PEM Fuel Cell, reversible cell, model, validation*

### **Abstract**

There's an increasing demand for energy storage systems to equalize our present energy distribution, and one promising solution is PEM Fuel Cell systems that use the chemical energy of hydrogen for storage. Reversible PEM cells are especially crucial in these systems because they can function in both electrolyzer and Fuel Cell modes. This research develops a model of reversible PEM cells in electrolysis mode utilizing the equivalent circuit method, which is then empirically verified on a lab setup with a reversible PEM Fuel Cell. The electrical and ionic resistances of the membrane, as well as the maximum current of a PEM electrolyzer, are adjusted according to the empirical data. The model's validation considers a variety of pressures, excessive pressures on the membrane, and flow rates induced by pressure disparities. The model is highly precise, with an average relative error of 1.47% and a lower relative error of 1.16% for currents ranging from 0.05 to 0.5 A. It also demonstrates greater accuracy for lower water flow rates, and additional analysis based on two-phase flow models could reduce errors in flow rates due to pressure differences exceeding 8 kPa. In comparison to linear models used for Fuel Cells, the model introduced in this paper provides greater accuracy, while extremely complex models accounting for activation losses, Ohmic losses, and concentration losses yield even fewer errors. This model strikes a balance between complexity and precision, making it a handy tool for exploring the behavior of reversible PEM Fuel Cells in electrolysis mode.

## Dynamic modeling of a solid oxide fuel cell system integrated with absorption chiller for ship propulsion

Siwoong Kim<sup>a</sup>, Taebeen Kim<sup>a</sup>, Sanggyu Kang<sup>\*a</sup>

\* corresponding author: sgkang@snu.ac.kr

<sup>a</sup> Department of Naval Architecture and Ocean Engineering Seoul Nat'l Univ.

*Keywords: Solid oxide fuel cell (SOFC), Absorption chiller, Dynamic modeling, System analysis*

**Abstract :** In this study, a dynamic model of a SOFC system integrated with an absorption chiller system was developed by Matlab-Simulink®. The system has performed dynamic simulation based on the ship's load profile and was simulated to compare system efficiency in two system configurations, with and without boilers, and two operating modes: rated operation and electrical load subsequent operation.

**Introduction:** As the International maritime organization (IMO) strengthens regulations on greenhouse gas emissions from ships operating at sea, the need to use eco-friendly fuel is emerging. In eco-friendly energy, fuel cells have been regarded as the most promising power source because they can directly convert chemical energy into electrical energy and have high electrical efficiency [1].

**Objectives:** The objective of this study is to develop a tri-generation system that supplies thermal and cooling energy as well as electricity through absorption chiller system utilizing the high-temperature exhaust gas of the SOFC system. And this study has developed an integrated system through a dynamic model of the SOFC system and absorption chiller by Matlab-Simulink® and derived an optimal scenario through performance analysis under various operating conditions.

### Material and methods:

#### A. Electrochemical model

The cell voltage (1) is determined by subtracting the activation (3), ohmic (4) and concentration overvoltage (5) from the nernst voltage (2) as shown in the following equation.

$$V_{cell} = E_{Nernst} - V_{act} - V_{ohm} - V_{conc} \quad (1), \quad E_{Nernst} = E^0 + \frac{RT}{2F} \ln \left( \frac{P_{H_2} (P_{O_2})^{0.5}}{P_{H_2O}} \right) \quad (2), \quad V_{act} = \frac{RT}{\alpha_A F} \sinh^{-1} \left( \frac{i}{i_{0,A}} \right) + \frac{RT}{\alpha_C F} \sinh^{-1} \left( \frac{i}{2i_{0,C}} \right) \quad (3)$$

$$V_{ohm} = \beta \cdot i \frac{t \cdot T}{A \cdot \exp\left(\frac{-\Delta G_{act}}{RT}\right)} \quad (4), \quad V_{conc} = \frac{RT}{nF} \left(1 + \frac{1}{\alpha_c}\right) \ln \left( \frac{i_L}{i_L - i} \right) \quad (5)$$

#### B. Energy conservation & mass conservation

The energy and mass conservation of dynamic is determined by the formation enthalpy of  $H_2O$  with the generated electric work, enthalpy flux and mole flow rates into or out of the control volume as shown in the equation below.

$$NC_v \frac{dT}{dt} = \sum \dot{N}_{in} h_{in} - \sum \dot{N}_{out} h_{out} + \Delta H \cdot \frac{i}{nF} - \frac{V \cdot i}{1000} \quad (6), \quad \frac{d(N\bar{X})}{dt} = \dot{N}_{in} \bar{X}_{in} - \dot{N}_{out} \bar{X}_{out} + \dot{R}_{H_2O} \quad (7)$$

**Results:** The SOFC-absorption chiller system is composed of the SOFC stack, blower, pump, catalytic combustor, reformer, heat exchanger, generator, condenser, absorber and evaporator as shown in Fig. 1-(a). The SOFC stack model was validated by comparing current density-voltage polarization curves between simulation and experimental data as shown in Fig. 1-(b). The simulation results show good reliability with the maximum difference of 0.03 V from the experimental data. The system efficiency was obtained according to fuel utilization and operating conditions as shown in Fig. 1-(c).

It was confirmed that it had the highest total efficiency at 70% fuel utilization, and the highest performance was shown in the system configuration without a boiler and with load following operation.

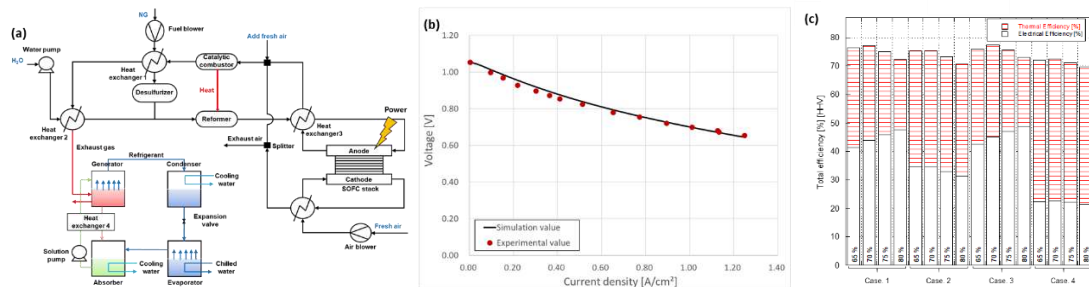

**Fig. 1. (a) Schematic diagram of the SOFC-Absorption chiller system. (b) Comparison of current density-voltage polarization curve between the simulation and the experiment data. (c) Comparison of efficiency by operation case according to fuel utilization rate.**

**Conclusions:** In this study, a dynamic model of a SOFC system integrated with absorption chiller system for ship propulsion was developed using Matlab Simulink®. The SOFC stack and absorption chiller model was validated by comparing them with experimental data. The SOFC-absorption chiller system efficiency was compared under various operating conditions and system configurations.

## Acknowledgment

This study was supported by grants from the Korea Institute of Planning and Evaluation for Technology in Food, Agriculture, Forestry and Fisheries, in the Ministry of Agriculture, Food and Rural Affairs (IPET; no. 120095033WT011).

## References

[1] Zijun Yang, Bowen Wang, Kui Jiao, Energy, 198:117365, 2020.



## Dynamic simulation of PEM water electrolysis system with detailed 2D stack model

Shin Haeseong<sup>a</sup>, Jang Dohyung<sup>a</sup>, Gilwon Kim<sup>b</sup>, Kyong-Hwan Kim<sup>b</sup>, Kang Sanggyu<sup>\*a</sup>

\* corresponding author: sgkang@snu.ac.kr

<sup>a</sup> Department of Naval Architecture and Ocean Engineering, Seoul National University

<sup>b</sup> Korea Research Institute of Ships & Ocean Eng.

*Keywords: PEM water electrolysis, Dynamic modeling, water electrolysis system, 2-D simulation.*

### Abstract

In this study, dynamic modelling of PEM water electrolysis system is developed with 2-D stack. Using this model, the dynamic response of each BOP of the system is simulated. Especially, the change of temperature, pressure and gas saturation in the stack is mainly analysed.

**Introduction:** Reduction of greenhouse gas emission is becoming very important according to international environmental issues, and accordingly, hydrogen production from renewable energy is emerging as an important research topic.

**Objectives:** Dynamic response analysis of a water electrolysis system powered by fluctuating renewable energy requires more advanced research. In particular, to analyse a harsh case such that power is supplied from offshore wind power in the floating environment, a detailed model based on physical equations need to be developed. In this study, the change of temperature, pressure and gas saturation in the stack is calculated for each control volume dynamically. Also, the BOPs such as pump and heat exchanger are modelled dynamically considering their inertia.

**Material and methods:** A dynamic model of a two-dimensional polyelectrolyte water electrolysis stack was developed using Matlab-Simulink® to check the response of the water electrolysis stack and Balance of Plants (BOP) according to time change. The control volumes of stack are divided into 9 control volumes in the direction perpendicular to the reaction plane, which include; bipolar plates, Porous Transport Layers (PTL) which is separated into 2 control volumes, electrodes, catalyst layers, and polymer electrolyte membrane. With 2D model, the control volume was separated in the direction of water supply as well. Energy, momentum and mass conservation are considered for electrochemical reaction, with two-

phase flow of water and generated gases of oxygen and hydrogen to model the bubble effect. The water pump, BOP of the system, was simulated by calculating the torque considering inertia. The Heat exchanger and EHP system are also modelled dynamically, where the temperature of the outlet fluid of the heat exchanger was calculated according to the flow rate and temperature of the inflowing fluid, and the flow rate of the refrigerant supplied was controlled to meet the operating conditions.

**Results:** From the simulation, when the current density applied to the water electrolysis was increased, the temperature of the stack increased and reached to a steady state due to heat generated. When current is applied to the stack from idle state, the pressure of the catalyst layer and the electrode layer increases due to the generation of gas inside the cell. The gas saturation, which is a measure of the bubble effect, was computed according to operating temperature and pressure, and the voltage change. Considering the changes of all variables, each effect of the variable is shown in Fig. 1.

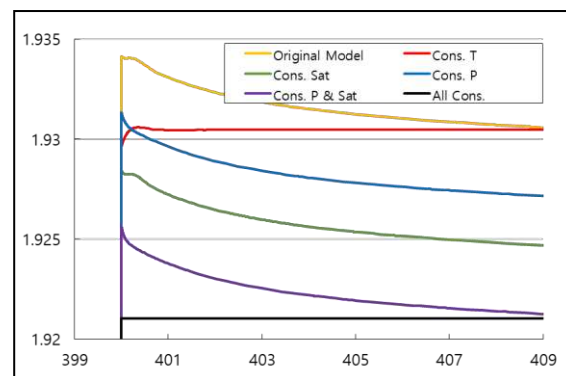

Figure 1. Voltage change of PEM water electrolysis stack according to consideration of each variable.

**Conclusions:** From this simulation, the dynamic change of the stack and BOPs of the system is analysed. Using this simulation model, it is possible to check the response and performance of the system according to the change of the size of the system component or the change of the control method.

### Acknowledgment

This research was supported by the National R&D Project “Development of fixed offshore green hydrogen production technology connected to marine renewable energy” funded by the Ministry of Oceans and Fisheries (PMS5340).



## Hybrid energy storage with negative carbon emission combining renewables and hydrogen technologies

Gabriele Loreti<sup>1</sup>, Andrea Luigi Facci<sup>1,\*</sup>, Stefano Ubertini<sup>1</sup>

\* Corresponding author: [andrea.facci@unitus.it](mailto:andrea.facci@unitus.it)

<sup>1</sup> DEIM - Department of Economics, Engineering, Society and Business Administration,  
University of Tuscia, 01100, Viterbo, Italy

Advanced energy storage systems are necessary to allow high renewable energy sources penetration, achieving the international targets for the reduction of green house gases emissions. In this context, multi-energy systems incorporating hydrogen technologies will play a crucial role. Moreover, some hard to abate sectors cannot be decarbonized, requiring the development of efficient carbon capture systems.

### **Abstract:**

In this paper, we posit an innovative energy storage system based on hydrogen electrolysis, fuel cells, and Compressed Gas Energy Storage (CGES) that can efficiently store electric energy while also indirectly capturing carbon dioxide from the atmosphere. The non dispatchable electric energy produced from a renewable energy source (i.e. wind or photovoltaic) feeds the compressor of the CGES and the electrolyzer to produce hydrogen and oxygen. The electric energy is stored in the form of hydrogen and high pressure CO<sub>2</sub>-O<sub>2</sub> mixture. When the stored energy has to be fed to the users the hydrogen is oxidized in a fuel cell, while the compressed CO<sub>2</sub>-O<sub>2</sub> mixture expands in the turbine of the CGES after combustion with biogas. The turbine exhaust is made of CO<sub>2</sub> and water and therefore the CO<sub>2</sub> can be captured after only cooling and dehumidification. We study such system through a thermodynamic model. Results show that the round trip efficiency ranges between 30% and 33%, being negligibly lower than the round trip efficiency of 35% achievable through the state-of-the-art electrolyzer and fuel cell cluster. Moreover, the system captures more than 95 g of CO<sub>2</sub> per MJ of stored electric energy. Such value is very significant when compared to the grid emission factor, that in Europe equals 80 g of CO<sub>2</sub> per MJ of produced electric energy.





## Vanadium Flow batteries: a path to long duration energy storage

Giacomo Marini, Andrea Trovò, Massimo Guarnieri

### Abstract

Energy storage is a key technology for phasing out fossil fuels in the transition to renewable energy sources and smart grids, since it can provide different services, ranging from energy management, with long discharges, to power quality, with fast responses. Recently, the interest for long duration energy storage (LDES) is also emerging, that can include multi-hour discharges as well as storage over long periods of time (seasonal storage). Different technologies are available to store energy, among which closed batteries (lithium, sodium, ...) are strong enablers, thanks to features such as low environmental impact, flexible location, scalability, stillness, high efficiency. However, closed batteries present issues e.g. life duration, safety and self-discharge. Hydrogen storage promises to cope with long term storage, but it is prone to efficiency issues. In this framework, redox flow batteries (RFBs) are emerging as a competitive option for several services. Storing energy in liquid electrolytes held in tanks outside the reactor, they provide independent sizing of energy and power, thus allowing for long discharge times at full power which are inaccessible for closed batteries. Their most developed version, the vanadium RFB, exhibits very long life, virtually no self-discharge, operation at room temperature and pressure and absence of hazard risks such as fires and explosions. While VRFBs are gaining increasing commercial importance, more research is ongoing to improve their performance and competitiveness.





## Effect of Multifuel Approach on SOFC System Performance and Architecture Requirements

Raphael Neubauer\*<sup>a</sup>, Péter Sztrinko<sup>a</sup>, Mathias Innerkofler<sup>a</sup>, Bernd Reiter<sup>a</sup>

\* corresponding author: [raphael.neubauer@avl.com](mailto:raphael.neubauer@avl.com)

<sup>a</sup> AVL List GmbH, Hans-List-Platz 1, 8020 Graz/Austria

*Keywords: ammonia, hydrogen, marine application, solid oxide fuel cell*

### Abstract

**Introduction:** Solid oxide fuel cell (SOFC) systems have the advantage to utilize different types of fuels including natural gas, liquified petroleum gas, ammonia (NH<sub>3</sub>), methanol (CH<sub>3</sub>OH) and pure hydrogen (H<sub>2</sub>). However, this often-cited fuel flexibility leads to complex system behaviors which need to be better understood with the help of extensive simulation and testing data.

**Objectives:** Within the FuelSOME project, one and the same system shall be operated with different types of fuels including NH<sub>3</sub>, CH<sub>3</sub>OH, and H<sub>2</sub>. The first objective of this work is to setup a comprehensive SOFC system model for all three types of fuels. The second objective is to use the model to better understand and steer the SOFC development into the right direction in terms of multi fuel applications for example in the maritime sector.

**Material and methods:** System understanding is the key for developing a SOFC system which shall be operated with different types of fuels. AVL has developed a 0-D system and stack analysis tool in recent years in order to develop optimized SOFC systems. This tool is based on a fully automatized parameter study including a generic architecture. The generic architecture includes the stack and main BoPs such as reformer, oxidation catalyst/off-gas burner and all kind of fuel recirculation approaches. This is mandatory for system understanding and optimization [1]. This tool allows to get a very deep and comprehensive system understanding by building empirical models for more than 100 key performance indicators (e.g. system efficiency, cell voltage, etc.) based on several thousand stationary simulation results. The stack model used in this study was calibrated with test data from an anode supported SOFC stack. All system efficiencies within this work are defined as electric AC net efficiencies at beginning of life, based on the lower heating value.

**Results:** The investigations are done in an analytical way to better understand the effect of different parameters. In doing so, the system electric was optimized by considering additional typical stack specification (e.g. max. stack air outlet temperature, max. stack single pass fuel utilization, etc.). In case of a NH<sub>3</sub> fueled system both effects of NH<sub>3</sub> concentration at stack inlet and H<sub>2</sub>O discharge rate in the recirculation path was investigated compared to the base case defined by a NH<sub>3</sub> inlet concentration of 0 vol.% and a H<sub>2</sub>O discharge rate of 0 %. The analysis is done at 3075 W DC stack power output.



The results for NH<sub>3</sub> show that the system electric net efficiency increases by 2.8 % points when the NH<sub>3</sub> inlet concentration was increased to 30 vol.%. In case of 30 % H<sub>2</sub>O discharge and 0 vol.% NH<sub>3</sub>, the system electric net efficiency increased by 3.9 % points. The increase of efficiency in both cases has different origins. In case of NH<sub>3</sub> increase at stack inlet, the cell voltage stays at the same level, however, the internal endothermic cracking of NH<sub>3</sub> significantly reduces the required air flow for cooling of the stack, and thus the air blower power consumption. For the case of 30 % H<sub>2</sub>O discharge, the air flow is only slightly reduced but the cell voltage increases significantly because of the reduced H<sub>2</sub>O concentration inside the stack and thus higher H<sub>2</sub> partial pressure inside the stack. With further increase of the H<sub>2</sub>O discharge to 90 % the efficiency reached 60.8 % with an NH<sub>3</sub> concentration of 0 vol.% at stack inlet. For these results no lower limit on the stack air flow rate was considered.

Similar investigations have been carried out for a SOFC system fueled with H<sub>2</sub> and CH<sub>3</sub>OH, where a lower stack air flow limit of 12000 NI/h was considered. In case of CH<sub>3</sub>OH no H<sub>2</sub>O discharge in the recirculation path was considered because the H<sub>2</sub>O is used in the pre-reformer of the system. The analysis of the models showed that the system electric net efficiency of CH<sub>3</sub>OH, NH<sub>3</sub>, and H<sub>2</sub> is similar for all three types of fuels up to 2400 W DC stack power (around 78 % load). However, only the efficiency of NH<sub>3</sub> increases further to 65.1 % at 3075 W of DC stack power (around 100 % load). This is significantly higher than the 55.6 and 57.2 % for CH<sub>3</sub>OH and H<sub>2</sub>, respectively. The stack air flow rate provides one of the explanations for the different efficiencies. Only for H<sub>2</sub>, the low air flow limit is not a limiting factor at 3075 W. Higher electric efficiency for NH<sub>3</sub> and CH<sub>3</sub>OH could be achieved by lowering the lower stack air flow limit. However, that would lead to a further mismatch of flow rates on the air path in the system for the three different types of fuels.

The analysis of the stack fuel flow rate at optimized operating conditions show that at 3075 W DC stack power the flow rates for the three types of fuels are between 2464 and 3762 NI/h. That is an interesting result and shows that for full load operation the optimized operation points are quite similar in terms of fuel flow rate at stack inlet.

**Conclusions:** The overall analysis of the system models show that running a SOFC system with CH<sub>3</sub>OH and NH<sub>3</sub> can lead to very high system efficiencies when optimizing the stack for low air flows rate. However, H<sub>2</sub>O discharge for NH<sub>3</sub> is important to achieve electric net efficiencies >60 %. The same is true for H<sub>2</sub> fueled system, however, other parameters must be optimized to also achieve an electric net efficiency >60 %. Overall, a multi fuel SOFC system has several challenges in terms of optimized operating conditions beside material compatibility and cost optimization and the tool developed by AVL and presented in this abstract is an innovative approach to help to solve the above-mentioned challenges.

### Acknowledgment

The authors thank the European Union for received financial support in the course of the FuelSOME project.

### References

- [1] Kwang Ho Lee, Richard K. Strand, SOFC cogeneration system for building applications, part 1: Development of SOFC system-level model and the parametric study. *Renewable Energy*, 34 (2009), 2831-2838

## Analysis of on Board Liquid Hydrogen Cold Energy Utilization in Ship Fuel Cells Power Plants

Nicola Zuliani <sup>a</sup>, Davide Pivetta <sup>a</sup>, Federico Del Mondo <sup>a</sup>, Marco Bogar <sup>a</sup>, Rodolfo Taccani <sup>\*a</sup>

\* corresponding author: [taccani@units.it](mailto:taccani@units.it)

<sup>a</sup>Department of Engineering and Architecture, University of Trieste - Italy

*Keywords: sustainable shipping, liquid hydrogen, cryogenic cold recovery, energy system modelling.*

### Introduction

For sustaining the energy transition towards greener power supply systems, low temperature Fuel Cell Systems (FCS) represent a concrete option already adopted in transportation sector, where Proton Exchange Membrane Fuel Cells (PEMFCs) are currently used as powertrain for vehicles and trains. By guaranteeing remarkable reductions of greenhouse gases emission, FCS are also interesting in the maritime sectors as a power generator for large vessels, such as cruise ships. In this extent, the onboard hydrogen storage system needs to be characterized by a sufficient capacity sustaining the ship operation over an adequate range. Among the different hydrogen storage methods available, liquid hydrogen (LH<sub>2</sub>) shows the highest volumetric and gravimetric energy densities. However, hydrogen liquefaction is a high energy demanding storage method [1]. In order to enhance on board system energy efficiency, cold recovery methods can be applied in order to exploit the LH<sub>2</sub> cold energy [2].

### Objectives

The aim of this work is analysing the possible energy technologies and configurations which can be used on ships for recovering the cold energy content of LH<sub>2</sub> and presenting a case of study referred to a cruise ship partially powered by a FCS, evaluating the overall electrical efficiency gain.

### Material and methods

At first, an evaluation on the potential exergy that can be ideally recovered from LH<sub>2</sub> is discussed [2]. Then a literature analysis on different systems that can be used for LH<sub>2</sub> cold heat recovering is accomplished [3]. Later, a case study, considering a heat recovering system based on an Organic Rankine Cycle (ORC), is undertaken. The ORC is applied onto a cruise vessel operating in the Norwegian Sea, hosting a 6 MW LH<sub>2</sub>-fed-PEMFCs-powertrain. To assess the LH<sub>2</sub> cold energy available under distinct sailing conditions, different electrical loads for the FCS were considered, enabling the evaluation of the hydrogen consumption rate, as summarized in Table 5, in function of the navigation regime.

**Table 5.** Fuel cell electrical load and considered H<sub>2</sub> flow rate at different navigation phases.

	FC Only Harbour Winter	FC Only Harbour Summer	Fjord Navigation Winter	Fjord Navigation Summer	Manoeuvring Winter	Manoeuvring Summer
Fuel Cells (kW <sub>el</sub> )	4829	4606	6000	6000	6000	6000
H <sub>2</sub> flow rate (kg/h)	291	311	433	433	433	433

### Main results and conclusions

From the literature survey, different types of energy recovering systems, as also demonstrated on analogous analysis performed on plants dedicated to liquid natural gas processing, can be considered for electricity production. However, to date and to the best of our knowledge, almost no experimental prototypes, nor system were found. Moreover, it turned out as the ORC technology is a well-established solution for the energy conversion of thermal power from different heat sources and different studies concerns the application of ORC in the marine field [4]. For the case of study addressed in this work it was shown as about 350 kW<sub>th</sub> of cold energy could be recovered by means of an ORC system that can generate about 80 kW of electric energy once the ship is in navigation regime, corresponding to an overall system efficiency increase of about +1.4%. The authors acknowledge that, different and more complex systems could allow for a higher recovery of cold energy; however, higher capital costs are expected.

### Acknowledgment

The authors acknowledge the financial support from the project sHYpS (sustainable HYdrogen powered Shipping, Horizon Europe call Horizon-CL5-2021-D5-01).

### References

- [1] Majid Aasadnia, Mehdi Mehrpooya, *Large-scale liquid hydrogen production methods and approaches: A review*, Applied Energy, Volume 212, 2018, Pages 57-83.
- [2] Lenger, M., Heinke, S., Tegethoff, W. et al. *Synergies of fuel cell system thermal management and cryogenic hydrogen exergy utilization*, Nature, Sci Rep 12, 22065 (2022).
- [3] L. Trevisani, M. Fabbri, F. Negrini, P.L. Ribani, *Advanced energy recovery systems from liquid hydrogen*, Energy Conversion and Management, Volume 48, Issue 1, 2007, Pages 146-154.
- [4] M.E. Mondejar, J.G. Andreasen, L. Pierobon, U. Larsen, M. Thern, F. Haglind *A review of the use of organic Rankine cycle power systems for maritime applications*, Renewable and Sustainable Energy Reviews, Volume 91, 2018, Pages 126-151.



## Improving Energy Self-Sufficiency of a Multi-Energy System through Hydrogen Storage and Fuel Cell CHP

Sergio Bruno<sup>\*a</sup>, Enrico De Tuglie<sup>a</sup>, Andrea Bonfiglio<sup>b</sup>, Giovanna Adinolfi<sup>c</sup>, Maria Valenti<sup>c</sup>

\* corresponding author: [sergio.bruno@poliba.it](mailto:sergio.bruno@poliba.it)

<sup>a</sup> DEI – Politecnico di Bari, Bari, Italy

<sup>b</sup> DITEN - Università di Genova, Genoa, Italy

<sup>c</sup> ENEA - Portici Research Centre, Portici (Naples), Italy

*Keywords: energy management, green hydrogen storage, multi-energy system, net-Zero Energy District*

### Abstract

**Introduction:** The study presents a methodology for assessing the performance of a multi-energy system comprising electrical and thermal loads, renewable generation from photovoltaics (PV) and wind power, battery storage, hydrogen storage with fuel cell for Combined Heat and Power (CHP) production. The proposed application shows how hydrogen storage can contribute in increasing self-sufficiency of a small town-scale energy system, towards the fulfilment of a net-zero energy (NZE) objective. Recent studies proposed to cover the whole electrical and thermal demand of a small eco-district (50 residents) through PV generation coupled with an alkaline electrolysis, hydrogen storage, fuel cell CHP system [1].

**Objectives:** The study focuses on the idea of using stored hydrogen to produce electricity and heat in a small town-scaled multi-energy system in order to improve its energy autarky and approach the ideal NZE target. The study aims to investigate whether the use of hydrogen storage coupled with a CHP fuel cell can fulfil at the same time the needs of storing the RES generation surplus and supporting the supply of thermal energy.

**Material and methods:** The methodology adopted to study the performances of the multi-energy system is based on the solution of a daily predictive optimal control problem, aiming at minimizing a suitable cost function. The use of a control problem to assess the energy behaviour of the multi-energy system is based on the rationale that complex systems, where multiple energy resources might compete in satisfying energy balance and most of RES generation is of intermittent nature, must adopt optimal techniques to fully exploit their flexibility resources. The proposed control problem is derived from the formulation of a non-

linear dynamic problem defined in the continuous time domain, which is redefined in the discrete time domain [2] and reformulated so that it can be solved through MILP techniques. Although the method is based on the recursive solution of an operational problem, the methodology can be also useful for planning, as discussed in [3].

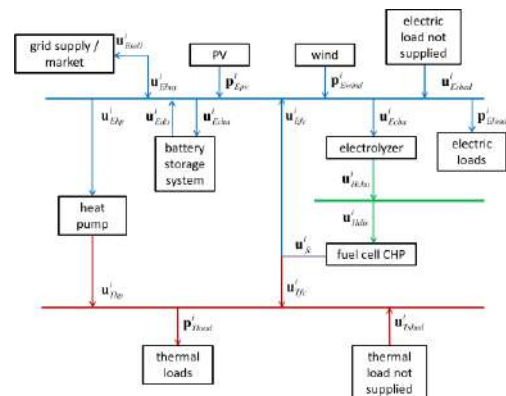

TABLE I  
SELF-SUFFICIENCY INDICES

Type of storage	SSCI	SSSI
No storage	0.5341	0.5577
battery	0.5590	0.5788
hydrogen	0.6593	0.6004
battery + hydrogen	0.6692	0.6165

**Results:** The multi-energy system used for this study is structured as in the upper figure and is modelled to supply the energy demand of a small town. Test results were obtained considering the system response during an entire year of operation. Two numerical indices were adopted: System Self Consumption Index (SSCI) and System Self Sufficiency Index (SSSI). The hourly graphs, not shown here for the sake of brevity, show how batteries are mostly used to reduce the purchase of energy from the grid. The battery discharge is in general not much related to the thermal load, whereas hydrogen is mostly used to supply the thermal load in those hours of the day characterized by the lowest COP. In the Table it can be noted how the SSCI seems to be influenced mostly by the activation of the electrolyser which permits to limit the power export for several hours during the day.

**Conclusions:** The overall impact of the hydrogen storage on self-sustainability seems to be more significant if compared with the sole battery installation. Installing both battery and hydrogen storage seems to bring only marginal improvements with respect to the sole hydrogen storage configuration. A more detailed analysis of these impacts should be also made considering different mix of RES and, therefore, different power generation volatility. Also the assumptions on selling and buying price can influence final results. These aspects will be treated in the full manuscript.

## References

- [1] J. Zhao, M. Liu, X. Zhang, and Z. Tu, "Off-grid solar photovoltaicalkaline electrolysis-metal hydrogen storage-fuel cell system: An investigation for application in eco-neighborhood in Ningbo, China," *Int. J. Hydrogen Energy*, vol. 48, no. 50, pp. 19 172–19 187, 2023.
- [2] S. Bruno et al. "Predictive dispatch across time of hybrid isolated power systems," *IEEE Transactions on Sustainable Energy*, vol. 5, no. 3, pp.738–746, 2014.
- [3] T. Brijs et al. "Evaluating the role of electricity storage by considering short-term operation in longterm planning," *Sustainable Energy, Grids and Networks*, vol. 10, pp. 104–117, 2017.



## A Comprehensive Classification of Hydrogen Refuelling Stations: Factors and Global Comparisons

M. Genovese\*<sup>a</sup>, F. Piraino<sup>a</sup>, V. Cigolotti<sup>b</sup>, M. Della Pietra<sup>b</sup>, P. Fragiaco<sup>a</sup>

\* corresponding author: [matteo.genovese@unical.it](mailto:matteo.genovese@unical.it)

<sup>a</sup> Department of Mechanical, Energy and Management Engineering, University of Calabria, Arcavacata di Rende, Cosenza, Italy

<sup>b</sup> Department of Energy Technologies and Renewable Sources, Laboratory of Energy Storage, Batteries and Hydrogen Production and Use (TERIN-PSU-ABI), ENEA Italian National Agency for Energy, New Technologies and Sustainable Economic Development, C.R. Casaccia, Rome, Italy

*Keywords: Hydrogen refuelling station, Fuel cell vehicle, Sustainability, Energy.*

### Introduction

Global development of Hydrogen Refuelling Stations (HRS) has increased significantly as a result of the shift to a hydrogen-based economy. This conference paper provides a comprehensive overview and classification of HRSs based on these key parameters, delving into the rationale underlying each classification and its implications for future infrastructure development.

### State of the art on HRS

Research in the HRS sector is currently a very active field, covering a wide range of topics ranging from technological innovation to station layout design, to optimization of pressure levels [1]. Risk analysis, safety analysis and the collection of experimental data for HRS performance tests are also topics of primary importance, confirming the ever-increasing interest of the scientific community for these energy systems. First, a key area of research relates to hydrogen storage [2].

Another crucial aspect concerns the hydrogen refuelling line [1]. Here, the most relevant challenges concern pulsation-free operation, pressure losses and hydrogen losses.

Finally, a classification of the HRS according to the most recent bibliographic surveys is presented. The classification of HRS can take place along different axes, each of which offers a different picture of the functions, benefits, and challenges of these structures. The daily capacity of HRS is one of the primary determinants of its efficiency and service capabilities. In general, stations are divided into three categories: low (less than 200 kg/day), medium (200 - 500 kg/day), and high (over 500 kg/day) capacity. The pressure levels at HRS can significantly affect the rate and effectiveness of vehicle refuelling. Based on the hydrogen supply chain,



HRS can be divided into "on-site" and "off-site". On-site stations produce hydrogen on site, which can offer benefits in terms of reduced transportation costs and potential for integration with renewable energy sources. Off-site stations, on the other hand, receive hydrogen from external sources, which can be more convenient in terms of production costs and scalability. Considering the thermodynamic state of hydrogen, stations that store hydrogen in gaseous form can be distinguished from those that store it in liquid form. This can affect factors such as energy efficiency, infrastructure needs and security. Depending on the vehicles being fuelled, HRSs may be designed primarily for light on-road vehicles, such as cars, or heavy on-road vehicles, such as trucks. Finally, the classification can be done according to the daily supply capacity, which reflects the breadth of service that a station can provide, influencing the size, design, and potential environmental and infrastructural impact of the station.

### **Conclusions**

The present manuscript aims to highlight the relevance of the hydrogen sector and HRS in the context of energy change and underline the importance of continued research to address the challenges associated with production, transportation, distribution, and efficiency of these infrastructures. The information collected and processed will be essential to define the functional requirements of the HRS such as: quantity of hydrogen supplied (kg/day of hydrogen supplied per vehicle and total), nominal refuelling pressure of the vehicles, frequency of refuelling, and nominal capacity of the HRS.

### **Acknowledgment**

This research was funded by the European Union - NextGenerationEU from the Italian Ministry of Environment and Energy Security, POR H2 AdP MEES/ENEA with involvement of CNR and RSE, PNRR - Mission 2, Component 2, Investment 3.5 "Ricerca e sviluppo sull'idrogeno", CUP: I83C22001170006.

### **References**

- [1] Genovese M, Cigolotti V, Jannelli E, Fragiaco P. Hydrogen Refueling Process: Theory, Modeling, and In-Force Applications. *Energies* (Basel) 2023;16. <https://doi.org/10.3390/en16062890>.
- [2] Genovese M, Fragiaco P. Hydrogen refueling station: Overview of the technological status and research enhancement. *J Energy Storage* 2023;61:106758. <https://doi.org/10.1016/j.est.2023.106758>.





# Hydrogen Refuelling Procedures and Equipment for Aviation and Maritime Sectors: A Technical Overview and Regulatory Landscape

M. Genovese\*<sup>a</sup>, F. Piraino<sup>a</sup>, P. Fragiacomò<sup>a</sup>

\* corresponding author: [matteo.genovese@unical.it](mailto:matteo.genovese@unical.it)

<sup>a</sup> Department of Mechanical, Energy and Management Engineering, University of Calabria, Arcavacata di Rende, Cosenza, Italy

*Keywords: Hydrogen refueling, hydrogen regulation, heavy-duty transport, fuel cell.*

## Introduction

The technical aspects of hydrogen refueling in the aviation and maritime industries are complex and require specialized infrastructure and equipment. Aviation must address issues such as rapid refueling to reduce downtime and storage solutions that account for weight and fuel capacity limitations. Maritime applications must deal with maintaining liquified hydrogen for extended periods and ensuring that storage units do not hinder vessel performance. This abstract offers a comprehensive overview of hydrogen refuelling practices, technologies, and regulatory constraints, with a focus on technical details.

## Technical requirement

Hydrogen can be stored and transported as either high-pressure gaseous hydrogen (GH<sub>2</sub>) or liquid hydrogen (LH<sub>2</sub>) [1]. GH<sub>2</sub> storage necessitates lightweight, compact tanks, which are advantageous for aircraft due to weight restrictions. However, LH<sub>2</sub> offers a greater energy-to-weight ratio, which is essential for long-distance journey, despite requiring larger, cryogenically insulated tanks. The refuelling flow rates should be comparable to those of conventional jet fuel refueling systems (approximately 3,800 liters for the Jet A-1) in order to maintain comparable aircraft turnaround times [2]. LH<sub>2</sub> has a higher energy-to-weight ratio than Jet A-1, approximately 120 MJ/kg compared to 142 MJ/kg, but has only 14% of the density of Jet A-1. LH<sub>2</sub> storage requires large, well-insulated cryogenic tanks despite this benefit. The refueling procedure requires sophisticated equipment capable of withstanding the extreme cold or high pressures associated with these forms of hydrogen.

Due to their extensive energy demands and longer operational periods, maritime vessels typically favor LH<sub>2</sub>. The primary difficulty lies in the safe handling and storage of LH<sub>2</sub> onboard, necessitating cryogenic storage tanks. The insulation of onboard storage solutions must be adequate to minimize hydrogen boil-off, which, if uncontrolled, can result in daily losses of up to 3%. Therefore, maritime refuelling infrastructure at ports must consist of large,



cryogenically insulated storage tanks and high-flow pumps [1] capable of transferring LH2 from shore storage facilities to the ship's tanks.

### **Safety and Regulatory Framework**

Storage tanks, compressors or cryogenic pumps for pressurizing or cooling the hydrogen, pressure regulators for controlling the delivery pressure, safety valves to prevent over-pressurization, and hoses or pipelines for connecting the supply to the vessel or aircraft are essential components of hydrogen refuelling equipment [3]. To ensure early leak detection and mitigation, pressure relief valves and hydrogen detectors must be able to detect concentrations of hydrogen as low as 25 % of the lower explosive limit, or approximately 1 % by volume in air.

The regulatory landscape surrounding hydrogen refuelling procedures and equipment is in flux and varies by country and industry. In the aviation industry, the Federal Aviation Administration (FAA) and the European Union Aviation Safety Agency (EASA) play vital roles in defining standards and regulations. The International Maritime Organization (IMO) is the primary is tasked with developing a regulatory framework to facilitate the use of hydrogen and fuel cells aboard ships. In addition, fueling stations must adhere to local and national fire and safety codes, such as the National Fire Protection Association (NFPA) standards in the United States.

### **Conclusions**

Hydrogen refuelling in the aviation and maritime sectors presents a multifaceted challenge requiring intricate technical solutions and stringent regulatory oversight. Despite these obstacles, the promise of a decarbonized future fueled by hydrogen presents an exciting opportunity for further research and development.

### **References**

- [1] Genovese M, Fragiaco P. Hydrogen refueling station: Overview of the technological status and research enhancement. *J Energy Storage* 2023;61:106758. <https://doi.org/https://doi.org/10.1016/j.est.2023.106758>.
- [2] Genovese M, Schlüter A, Scionti E, Piraino F, Corigliano O, Fragiaco P. Power-to-hydrogen and hydrogen-to-X energy systems for the industry of the future in Europe. *Int J Hydrogen Energy* 2023;48:16545–68. <https://doi.org/10.1016/j.ijhydene.2023.01.194>.
- [3] Genovese M, Cigolotti V, Jannelli E, Fragiaco P. Current standards and configurations for the permitting and operation of hydrogen refueling stations. *Int J Hydrogen Energy* 2023;48:19357–71. <https://doi.org/https://doi.org/10.1016/j.ijhydene.2023.01.324>.

## Designing and Sizing of a Green Liquid Hydrogen Supply Chain for Ship Refueling

A. Perna<sup>a</sup>, D. Lanni<sup>a\*</sup>, G. D'Antuono<sup>a</sup>, M. Minutillo<sup>b</sup>, V. Cigolotti<sup>c</sup>, M. Della Pietra<sup>c</sup>

\* corresponding author: [davide.lanni@unicas.it](mailto:davide.lanni@unicas.it)

<sup>a</sup> Department of Civil and Mechanical Engineering, University of Cassino and Southern Lazio, Cassino, Italy

<sup>b</sup> Department of Industrial Engineering, University of Salerno, Fisciano, Italy

<sup>c</sup> ENEA Portici, Piazzale Enrico Fermi I, Portici, Italy

*Keywords: green hydrogen, shipping refueling, liquid hydrogen, offshore wind power*

### Abstract

Green hydrogen plays a strategic role in the decarbonization of the maritime transportation. This paper is focused on the designing and sizing of a sustainable green liquid hydrogen supply chain based on an offshore liquefied production plant for ship refueling. The design-sizing procedure is based on an optimization algorithm that maximizes the hydrogen production from the renewable source.

### Introduction

Maritime transport plays a crucial role in the European economy. It accounts for roughly 80% of international trade in 2020, according to UNCTAD [1]. To accelerate the decarbonization and the reduction of pollutant emissions in maritime sector, the International Maritime Organization (IMO) has set ambitious goals that can be complied by developing a synergic integration between low or zero-carbon fuels and innovative propulsion technologies [2]. Liquid hydrogen and ammonia produced by using offshore renewable electricity are considered interesting solutions for the medium and large ship market, respectively [3],[4].

### Objectives

In this contest, the present study aims to design and size, through the development of an optimization procedure, a green liquid hydrogen supply chain (GLHSC), based on an offshore liquefied production plant for ship refueling that can assure the maximum hydrogen production from the RES (figure 1).

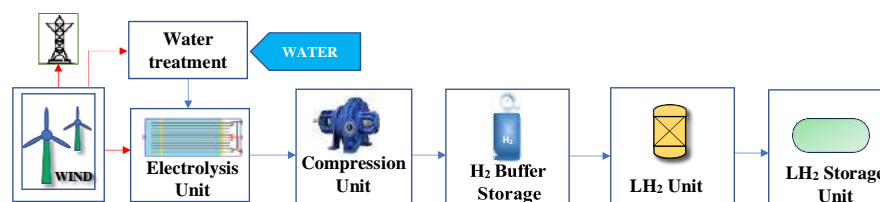

Figure 1. Schematic of the GLHSC

The plant, sized for supplying a maximum amount of LH<sub>2</sub> of 1000 kg/day, comprises a wind farm for renewable electricity generation, an electrolysis unit for hydrogen production, a water treatment unit for demineralized water production, and a hydrogen liquefaction plant for hydrogen storage and distribution to ships. Moreover, because the liquefaction unit would be in continuous operation, a buffer storage tank to store the gaseous hydrogen produced by the electrolysis unit is also considered.

## Material and methods

The sizing of the GLHSC is carried out by means of an optimization procedure (built by using the modeFRONTIER software package) based on a multi-objective genetic algorithm which interacts with a plant sizing code developed in Matlab environment.

## Results

The installation site of the offshore GLHSC (grid connected) is located at 25 km from Ravenna coast (Italy). Results of the optimization procedure in terms of components' size are reported in table 1. The annual hydrogen production is equal to 208.7 tons (the plant capacity factor is 57.2%), the annual electric energy consumption is 13260 MWh.

**Table 1. GLHSC components' size**

Parameter	Unit	Value
Wind farm size	MW	19
Electrolysis unit size	MW	5
Hydrogen compression unit size	kW	103
Hydrogen Buffer Storage capacity (at 200 bar)	kg	1200
Liquified hydrogen at full load	kg/h	41.6
LH <sub>2</sub> storage size	m <sup>3</sup>	14.1

## Conclusions

A green liquid hydrogen supply chain for ship refueling has been designed and sized by developing an optimization model based on a genetic algorithm. A 19 MW wind farm coupled with a 5 MW electrolysis unit allows to produce 208.7 tons of liquid hydrogen per year with a plant capacity factor of 57.2%.

## Acknowledgment

This research was funded by the European Union - NextGenerationEU from the Italian Ministry of Environment and Energy Security, POR H2 AdP MEES/ENEA with involvement of CNR and RSE, PNRR - Mission 2, Component 2, Investment 3.5 "Ricerca e sviluppo sull'idrogeno", CUP: I83C22001170006.

## References

1. A. Nemmour, A. Inayat, I. Janajreh, and C. Ghenai, Int J Hydrogen Energy (2023)
2. M. Ruth and S. Goessling-Reisemann, Handbook on Resilience of Socio-Technical Systems 1 (2019)
3. C. N. Bonacina, N. B. Gaskare, and G. Valenti, Int J Hydrogen Energy 47, 1279 (2022)
4. Y. Seo, H. Park, S. Lee, J. Kim, and S. Han, Int J Hydrogen Energy 48, 15126 (2023)

## Energy Management Control Strategies Addressing The rSOC Degradation Phenomena In A Polygeneration Microgrid

Califano, M.\*<sup>a</sup>, Sorrentino, M.<sup>a</sup>, Pianese, C.<sup>a</sup>

\* corresponding author: Califano, M.\*<sup>a</sup> (mcalifano@unisa.it)

<sup>a</sup> Department of Industrial Engineering, University of Salerno, Fisciano (Salerno), 84084 Italy

*Keywords: Dynamic Programming, Fuel cells degradation, Microgrids energy management, Reversible Solid Oxide Cells.*

### Abstract

**Introduction:** Economically competitive long-term energy provision and performance stability are becoming increasingly strategic for the current and upcoming energy market. In this regard, cutting-edge technologies, such as the hydrogen-based ones are particularly affected by performance reduction over time. Therefore, given the viability for adopting high temperature fuel cell and electrolyzer systems (i.e., SOFC, SOEC) for stationary applications, it results to be crucial the mitigation of degradation phenomena affecting such energy systems by means of effective energy management strategies.

**Objectives:** Such a paper is aimed at presenting control strategies for relevant technologies in the upcoming green energy-transition phase, namely polygeneration microgrids relying on reversible solid oxide cells (rSOCs) interfacing with renewable plants ( i.e., photovoltaic panels and wind turbines) to meet multiple thermal and electrical load demands. To this end, attention has been paid towards the rSOCs degradation phenomena and its mitigation applying real-time strategies allowing improving both performance and economic aspects.

**Material and methods:** This work is based on a previous one [1]. The under-discussion energy system for the proposed analyses is the microgrid depicted in the following figure:



To clearly outline the effectiveness of the presented energy management strategies applying the dynamic programming (DP) based tool, a 3-year scenario has been considered as having pivotal outcomes: i) storage system state of charge; ii) economic perspectives; iii) programmed maintenance. Addressing the first key-

point, a charge sustaining energy management strategy has been pursued by suitably considering the rSOC performance, electricity price, as well as renewable energy availability.



Whereas, in case of rSOC degradation, a non-responsive energy management may cause energy shortages over a long period, with the developed algorithm in place the load satisfaction has always been accomplished. Furthermore, by also actively considering the rSOC marked performance degradation during cold-start and frequent switching mode phases, it results to be feasible making the most of fuel cell pros, namely rSOC high power to grid (P2G) and G2P efficiencies, operative modes flexibility and co-generation capability. A literature analysis has been carried out on the rSOC degradation ([2],[3]), collecting data used in the dynamic programming tool. Not arguably, energy management is strictly linked to economic aspects that are mirrored by indices adopted in the current study: SPB and LCOE, which provide at glance the affordability of the proposed microgrid. Moving to the third bullet-point, it is fundamental for investors to know in advance which are the maintenance costs, thus, assessing clearly whether a green-investment would be profitable or not. The proposed so-called active maintenance, unlike the passive one, allows solid energy stability especially in a scenario in which virtual plants (VPPs) are major players.

**Results:** Having underlined all the entailed touching points of the paper, on the other hand, quantitatively, several analyses in a 3-year scenario with both fixed and variable degradation rates have been carried out. It is worthwhile reporting that, depending on the chosen rSOC degradation rate, a minimum of 5 kg of hydrogen and 200 kWh of thermal energy can be saved up implementing the proposed strategies, while exhibiting a SPB lower than 10 years and a LCOE below 0.3 €/kWh. Increasing the value of the degradation rate in the DP tool, it is viable to have further savings of hydrogen (up to 30 kg) and thermal energy (up to 600 kWh), which represent massive quantities compared to the load requests.

**Conclusions:** In the current energy scenario lowering economic expenditures and maintenance costs by means of the presented energy management tool would in turn mean making the proposed technological solution attractive for potential investors. Moreover, since such rSOC-based systems are either to be installed for residential or commercial purposes, the human beings' presence is straightforward and, therefore, monitoring and actively limiting the degradation effect results to be also crucial for functional safety, which finally means legal aspect.

#### **References:**

- [1] Califano M., Sorrentino, M., Rosen M.A., Pianese, C. (2022). Optimal heat and power management of a reversible solid oxide cell based microgrid for effective technoeconomic hydrogen consumption and storage. *Applied Energy*, 319:119268.
- [2] Peters, Ro., Frank, M., Tiedemann, W., Hoven, I., Deja, R., Kruse, N., Fang, Q., Blum, L., Peters, R. (2021). Long-Term Experience with a 5/15 kW-Class Reversible Solid Oxide Cell System. *Journal of The Electrochemical Society*, 168, 014508.
- [3] Schwarzes, K., Posdziech, O., Mermelstein, J., Kroop, S. (2019). Operational Results of an 150/30 kW RSOC System in an Industrial Environment. *FUEL CELLS*, 4, 374-380.



## Techno-economic assessment of a concentrated solar heat supported high temperature electrolysis process using a thermal energy storage

Timo Roeder<sup>\*a,b</sup>, Kai Risthaus<sup>a</sup>, Nathalie Monnerie<sup>a</sup>, Christian Sattler<sup>a,b</sup>

\* corresponding author: [Timo.Roeder@DLR.de](mailto:Timo.Roeder@DLR.de)

<sup>a</sup> Deutsches Zentrum für Luft- und Raumfahrt – DLR/German Aerospace Center, Institute of Future Fuels, Linder Höhe, 51147 Cologne, Germany

<sup>b</sup> RWTH Aachen University, Faculty of Mechanical Engineering, Chair for Solar Fuel Production, 52062 Aachen, Germany

*Keywords: Concentrated Solar Energy, High Temperature Electrolysis, Techno Economic Assessment*

### Abstract

**Introduction:** The reduction of greenhouse gas emissions is one of the biggest challenges in today's societies. Renewable hydrogen production is needed as a chemical feedstock to replace the use of fossil fuels. Among water electrolysis technologies, solid oxide cell reactor systems can operate at the highest electrical efficiencies by using thermal energy. Concentrated solar energy can be used to meet the high heat demand of high-temperature electrolysis. Thus, large-scale hydrogen production using solar energy and high-temperature electrolysis (HTE) promises low H<sub>2</sub> production costs, since the price of electricity is largely responsible for product cost development. However, the temporary availability of solar energy requires a suitable energy storage system. A detailed process analysis is required to investigate the cost impact of a high temperature thermal energy storage (TES) system to further reduce the electrical energy demand.

**Objectives:** It is known that a large part of thermal energy must be provided for the evaporation of water. For long-lasting operation of a HTE, thermoneutral operation is preferred. Therefore, temperatures of approx. 800°C must be provided. To ensure this permanently, either an electrical heating system or a high temperature TES is required. For the use of the TES, a techno-economic analysis must be carried out to determine more precisely the influence of the investment cost of the storage to the H<sub>2</sub> production cost.

**Material and methods:** A steady-state process simulation is performed to optimize the integration of the TES system. The TES system consists of two different units. First, the low temperature unit to store thermal energy for the evaporation of water. Second, the high temperature heat is stored in another unit to bring the HTE input streams as close as possible to the temperature level of the thermoneutral operated electrolysis cell. The developed



system configuration is used to determine the thermal energy demand provided by solar energy. The nominal parameters are used in a transient process model in Python to find a cost-optimal electrolysis size and thermal storage capacity. In addition, site-specific solar resource data is used to calculate the solar thermal power input in hourly time steps. Thus, the TES capacity and electrolysis power are adjusted to achieve the lowest cost of H<sub>2</sub> (LCOH<sub>2</sub>) for a given solar field size. The optimization is performed for the current cost parameters of the solar system [1] and electrolysis [2]. In addition, cost parameters for a future scenario are used for cost development prediction [1,2]. Furthermore, a sensitivity and uncertainty analysis is conducted using a Monte Carlo simulation.

**Results:** Most of the heat generated by concentrated solar power is used as evaporative heat. In addition, less than 10% of the heat is stored in the HT-TES unit. Therefore, the cost impact of the HT-TES unit is comparably small to that of the other components. In general, the larger the TES capacity, the smaller the HTE electrolysis can be designed to maximize H<sub>2</sub> production capacity and minimize the LCOH<sub>2</sub>. A process utilization of up to 7900 full load hours can be achieved at the studied sites. In a future cost analysis, the electricity price has the largest impact on the LCOH<sub>2</sub> variation. Thus, at higher electricity prices, the use of a high temperature TES unit is more profitable than an exothermal electrolysis operation.

**Conclusions:** High temperature electrolysis powered by solar energy is affected by the fluctuating behavior of the solar energy source. By using a high temperature thermal energy storage unit, the electrical energy consumption is reduced to a minimum which is required for the water splitting reaction. The impact of the investment costs of the high temperature thermal energy storage is comparatively small compared to other investment costs or the price of electricity. In general, the use of a high temperature thermal energy storage improves the operating conditions of a high temperature electrolysis and minimizes the total electrical energy demand. This can reduce H<sub>2</sub> production costs compared to other process configurations.

**References:**

[1] Jürgen Dersch; Simon Dieckmann; Klaus Hennecke; Robert Pitz-Paal; Michael Taylor; Pablo Ralon. LCOE reduction potential of parabolic trough and solar tower technology in G20 countries until 2030. *AIP Conference Proceedings* **2020** [2303].

[2] European Commission - Clean Hydrogen Joint Undertaking. *Strategic Research and Innovation Agenda 2021 – 2027*. [https://www.clean-hydrogen.europa.eu/knowledge-management/sria-key-performance-indicators-kpis\\_en](https://www.clean-hydrogen.europa.eu/knowledge-management/sria-key-performance-indicators-kpis_en) (accessed 2023-02-08).





## Techno-Economic Assessment of Deep Biogas Cleaning For Solid Oxide Fuel Cell Application

Elena Rozzi<sup>\*,a,b</sup>, Marta Gandiglio<sup>a</sup>, Andrea Lanzini<sup>a,b</sup>

<sup>a</sup>Department of Energy, Politecnico di Torino, Corso Duca degli Abruzzi 24, 10129 Torino, Italy

<sup>b</sup>Energy Center LAB, Politecnico di Torino, Corso Duca degli Abruzzi 24, 10129 Torino, Italy

*Keywords: biogas, deep purification, solid oxide fuel cell, techno-economic analysis*

**Abstract** - The use of biogas in fuel cells could be an attractive alternative to combustion technologies. However, biogas contains sulfur-based compounds that can be detrimental to fuel cells. A techno-economic analysis was conducted to assess the impact of the H<sub>2</sub>S cleaning system on the plant investment and operational costs.

### I. INTRODUCTION

Fuel cells powered by biogas for distributed heat and power cogeneration are an attractive alternative to combustion technologies due to their high energy conversion efficiency and low emissions of CO<sub>2</sub> and other pollutants. Moreover, they can operate in reverse mode producing hydrogen in an integrated plant where an energy surplus is generated from intermittent sources. However, biogas contains sulfur-based compounds such as hydrogen sulfide, dimethyl-sulfide, methanethiol, and carbonyl sulfide, that are detrimental for fuel cells. The European project Waste2Watts aims to design and test a flexible and cost-effective biogas clean-up unit for the deep removal of the most critical sulfur-based impurities for biogas utilization in high-efficiency fuel cell systems. The focus is on small-medium size farms, for which the optimal techno-economical solution is the deep cleaning of biogas through adsorption materials to avoid intensive gas processing treatment.

### II. METHODS

A techno-economic analysis was conducted to assess the impact of the H<sub>2</sub>S cleaning system on the levelized cost of energy (LCOE) and net present value (NPV) for a 3-kW and a 100-kW solid oxide fuel cell. The sizing of the vessel was determined for varying inlet H<sub>2</sub>S concentrations (100, 500, and 1000 ppm) and two configurations were compared. The first layout involved a single vessel where the sorbent was replaced when the H<sub>2</sub>S concentration in the outgoing flow reached 1 ppm (breakthrough based on SOFC H<sub>2</sub>S tolerance). The second configuration was a *lead and lag* layout where two reactors were used in series. When contaminant breakthrough was detected after the cleanest reactor placed downstream, the sorbent in the first reactor was replaced and the vessel were switched to ensure that the

cleanest reactor was always the last one in the sequence. This solution allows to replace the sorbent material without stopping the SOFC unit.

The experimental data of the RGM3 (Norit) activated carbon are exploited to validate the mathematical model implemented to predict the transient behavior of the contaminant concentration profile for any defined changes in the initial parameters, including feed concentration, contaminants, flow rate, sorbent material, reactor volume.

### III. RESULTS

LCOE and NPV results are displayed in Figure 1. In the case of a 3-kW plant, the cleaning unit investment cost (CAPEX) accounts for 41-43% of the overall LCOE in the single vessel scenarios, and 52-55% in the lead and lag configurations. Contrarywise, operational and maintenance costs (OPEX) for the cleaning unit accounts for 1% of the overall LCOE in the two-vessel configuration, whilst are up to 4% for the single vessel layout. However, the impact of the higher investment costs for the second vessel results in a higher LCOE and a lower NPV. Conversely, in the case of a 100-kW plant, the investment costs are mostly linked to SOFC CAPEX, while the cleaning unit has a lower impact. Therefore, the lower OPEX of the lead and lag layout results in a lower LCOE and a higher NPV compared to the single vessel configuration. Overall, the LCOE is below 0.17 €/kWh for all configurations, demonstrating that SOFC powered by biogas is a viable alternative for renewable energy production.

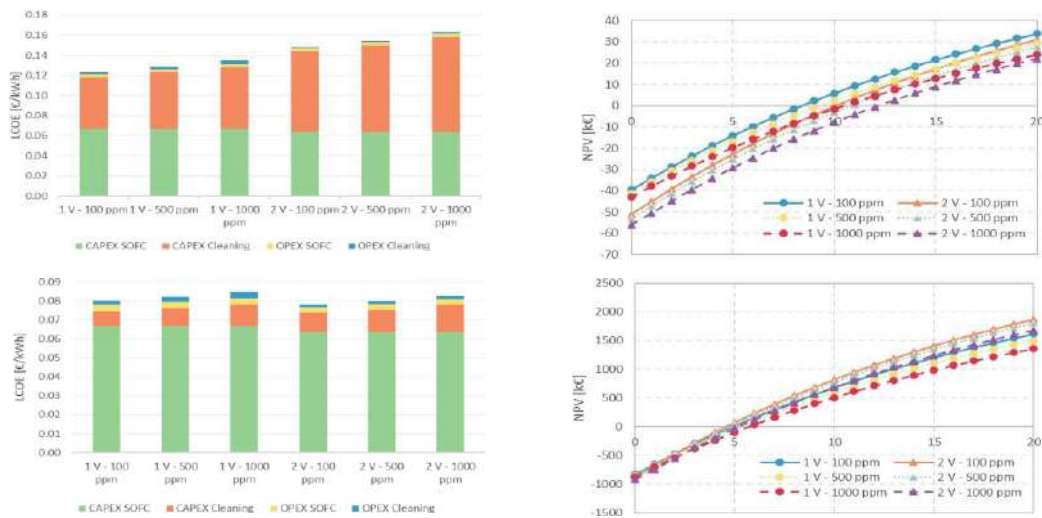

**Figure 1.** LCOE and NPV of the plant configurations proposed for a 3 kW (*above*) and 100 kW (*below*) plant.

### IV. CONCLUSIONS

The development of a flexible and cost-effective biogas clean-up unit for the deep removal of critical sulfur-based impurities can significantly improve the biogas utilization in high-efficiency fuel cell systems. The single-vessel layout is cost-effective for small-scale plants, while the lead and lag layout is more appropriate for larger-scale plants.



## Modelling green hydrogen systems in the decarbonization of hard-to-abate sectors: a case study on cement industry

Alessandro Mati<sup>\*a</sup>, Carcasci Carlo<sup>b</sup>, Alberto Mele<sup>c</sup>

\* corresponding author: [alessandro.mati@unifi.it](mailto:alessandro.mati@unifi.it)

<sup>a</sup> DIEF: Department of Industrial Engineering, University of Florence, Italy

<sup>c</sup> Centro Studi e Ricerche - Facility Management e Patrimonio, Estra S.p.A., Sede di Casamassima (Bari)

*Keywords: hydrogen GHG intensity, levelized cost of hydrogen, multi-energy system modelling, techno-economic analysis*

### Abstract

**Introduction:** The compelling need to tackle climate change has sparked considerable interest towards hydrogen in recent years as a viable clean energy solution in many fields. “Hard-to-decarbonize” industries such as steel, cement, and chemicals account respectively for 27%, 25% and 14% of industrial CO<sub>2</sub> emissions [1] and pose significant challenges to achieving a sustainable transition due to the limited availability of low-carbon options. Hydrogen provides a promising solution to this challenge, given its manifold nature as a high-energy-density fuel with a clean emissions profile, not only able to meet industrial energy demand and specific process requirements, but also offering the potential to enable long-term energy storage. In this phase of deep transformation, it is therefore of paramount interest to investigate the impact and feasibility of multi-energy systems integrating hydrogen with dedicated innovative tools capable of estimating performance with an accurate degree of detail.

**Objectives:** As most existing research has focused mainly on hydrogen production, this study aims to overcome this limitation by presenting the capabilities of a modular simulation tool developed to assess potential future scenarios involving hydrogen production, storage, and consumption in hard-to-abate applications, more specifically in the cement industry.

**Material and methods:** The Multi Energy System Simulator (MESS) [2] is a modular, bottom-up, multi-node model that enables the analysis of non-optimal solutions through simulating the energy systems. It is designed for urban-level energy system analysis with adjustable spatial resolution (i), it can be used without the need for coding through human-readable input files (ii), it can analyze systems with multiple energy carriers (e.g., electricity, heat, and fuels) and multiple players (iii) and it has been built as a free and open-source energy system model (iv). Leveraging on a library of predefined technologies, the model allows the user to create a wide range of case studies by combining them with different demand and consumption profiles provided as input within a single location unit. The system's energy balances can be performed according to different operating logics, which can prioritise hydrogen production, electricity generation or self-consumption. Considering renewable energy production and consumption profiles, the system is simulated for each timestep (hourly) to estimate the actual operation and performance of the defined hydrogen production, storage, and consumption configuration. Detailed physical models for electrolysis (PEM), compression (mechanical) and storage (cylinders) have been developed and included in the model to accurately predict the behavior of numerous configurations of hydrogen production plants over extended time periods. The key techno-economic indicators considered in this study are the LCOH [€/kgH<sub>2</sub>] and the GHG intensity [kgCO<sub>2</sub>/kgH<sub>2</sub>] of the produced hydrogen, which allow for comparing the performance of the tested configurations with the published literature in terms of economic



competitiveness and environmental sustainability of the proposed solution. The considered case study consists of the comprehensive modelling of the hydrogen supply chain to assess feasibility of decarbonization of a cement production facility. Current energy demand is satisfied via low-cost and low-GHG profile hydrogen, with the aim of addressing 25% of energy demand from kilns operation and 70% of diesel consumption from heavy-duty industrial trucks operating within the facility totalling for an annual demand of 6678 tonnes. A system configuration made of a wind farm, an electrolyser stack, a compressor and storage system and grid connection is simulated on an hourly basis. With a fixed wind generation capacity of 120 MW and a constant hydrogen demand, a sensitivity analysis is carried out to examine the performance of different combinations of electrolysers and tanks size to satisfy the demand. The minimum size of electrolyser considered is the one that ensures demand is met by operating at full load (42 MW), serving as a guaranteed minimum load even in the absence of renewables, when grid support is required.

**Results:** It is observed that as the size of electrolysers and tanks increases, the environmental parameters of the plant are enhanced at the expenses of investment and operating costs, which is reflected in an LCOH increase. This is due to a higher utilisation of the renewable source and the capacity to store higher amounts of green hydrogen. LCOH e GHG intensity parameters are defined for each configuration tested ranging from 4.87 to 6.13 €/kgH<sub>2</sub> and from 5.59 to 3.4 kgCO<sub>2</sub>/kgH<sub>2</sub>, respectively. After screening the set of identified solutions considering the CertifHy [3] limit for low-carbon hydrogen of 4.37 kgCO<sub>2</sub>/ kgH<sub>2</sub>, further analysis is conducted on the minimum LCOH configurations to define an incentive scheme to drive the adoption of solutions in heavy industries, addressing the necessity for long-term investment and policy planning. Finally, based on potential market demand for oxygen and the cement manufacturing process characteristics, further investigations are carried out into the effect of the sale and storage of this by-product on the final LCOH. To the best of the author's knowledge, this aspect has been scarcely dealt with in the literature to date.

**Conclusions:** Thanks to the methodology presented and the newly developed open-source modelling framework, the results of this study appear generalisable and reproducible in many other industrial contexts where the adoption of renewable hydrogen is expected to be essential in the near term to meet increasingly pressing climate targets.

## References

- [1] COP27: UN report shows pathways to carbon-neutrality in “energy intensive” steel, chemicals and cement industries | UNECE, (n.d.). <https://unece.org/climate-change/press/cop27-un-report-shows-pathways-carbon-neutrality-energy-intensive-steel> (accessed June 30, 2023).
- [2] P. Lubello, M. Pasqui, A. Mati, C. Carcasci, Assessment of hydrogen based long term electrical energy storage in residential energy systems, *Smart Energy*. 8 (2022) 100088. <https://doi.org/10.1016/j.segy.2022.100088>.
- [3] Towards hydrogen definitions based on their emissions intensity – Analysis - IEA, (n.d.). <https://www.iea.org/reports/towards-hydrogen-definitions-based-on-their-emissions-intensity> (accessed June 30, 2023).



## Hydrogen: A Storage Solution of Renewable Energy for Habitable Mobile Modules. Life Zeroenergymod Project

Carlos Arié\*<sup>a</sup>, Paula Barbero <sup>a</sup>

<sup>a</sup> Aragon Hydrogen Foundation

*Keywords: Habitable solution, Passivhaus, Renewable energies, Seasonal storage*

### **Abstract**

#### **Introduction:**

Modular buildings are custom-designed logistics solutions for many organizations. They are often off-grid (or micro-grid integrated) solutions, where access to public services is complicated, expensive, or unsafe. Current systems require a considerable amount of energy, usually based on fossil fuels, which implies the installation of a diesel generator to produce electricity and heating.

LIFE ZEROENERGYMOD project will improve the strength and resilience of modular buildings by minimising energy demand and eliminating diesel consumption. Saving diesel fuel not only avoids pollution and CO<sub>2</sub> emissions, but also reduces energy dependency on highly unstable economic and political conditions.

#### **Objectives:**

LIFE ZEROENERGYMOD project aims to achieve a substantial reduction in the energy consumption in a habitable module vs current solution, thanks to an excellent modular building efficiency and Passivhaus standards. Renewable energy and storage management by means of H<sub>2</sub> will ensure energy availability at any time of the day or year, regardless location.

Specifically, the objective is to design and build a modular, zero fossil fuel consumption temporary accommodation solution that can be quickly and easily deployed in camps. This prototype is expected to save 5,7kl/y diesel, reduce CO<sub>2</sub> and NO<sub>x</sub> emissions by 15 and 0.33 t/y, and generate 4 MWh from renewable energy. The overall budget is € 1,178,265, with an EU contribution of € 553,382, through LIFE program.

#### **Material and methods:**

LIFE ZEROENERGYMOD project (ZEM), coordinated by Aragon Hydrogen Foundation, started in Jun'20 and will end in May'24. The character of the project is fully demonstrative. The methodology is based on the following three key areas:

- Renewable energy: the use of a mix of renewable energy sources (photovoltaics, wind) can significantly increase reliability.
- Hydrogen-based storage system: As an energy carrier, hydrogen is a real alternative to fossil fuel economy and one of the best ways to store and manage energy cleanly. Integrated hydrogen systems coupled to RES, able to produce H<sub>2</sub> from renewable energy surplus, and re-electrify through fuel cell are completely autonomous, which is a huge benefit, especially in remote regions, where replacing H<sub>2</sub> cylinders would be a logistical challenge.
- Energy efficiency actions comprising new insulation materials and prefabricated construction techniques, aligned with Passivhaus standards.



# European Fuel Cells and Hydrogen

PIERO LUNGI CONFERENCE

September 13th-15th 2023  
Capri / Italy

## Results:

Prototype has been designed and built at partners' facilities, and subsequently disassembled, moved, and assembled at the 1<sup>st</sup> demo site (San Jorge Base, Zaragoza, Spain). 2<sup>nd</sup> half of the project focuses on prototype demonstration, monitoring and project replicability. Therefore, the first demonstration is ongoing, the first data sets are being collected and analysed to fine-tune equipment performance.

5,4kWp solar panels and a 3kW mini wind turbine provide renewable energy. When generation exceeds module's energy consumption, energy is first stored in lithium batteries that provide 2 days autonomy. Once batteries are fully charged and generation keep exceeding consumption, a 2,4 kW AEM electrolyser produces hydrogen, and a compressor stores it at 350 bar pressure in tanks located outside the module.



Figure 1 ZEM module with H2 storage tanks

AEM Electrolyser is operational and produces H<sub>2</sub> at 30 bar and it is stored in the low-pressure tank, which works as a buffer, which is currently being filled to maximum capacity to run compressor, FC, and full hydrogen system tests.

When this storage is full, the compressor comes into operation, and compresses the H<sub>2</sub> from the buffer to store it in the high-pressure tank. This H<sub>2</sub> will be used by a 2,5kW fuel cell to provide energy to the module during periods of low renewable source, increasing module autonomy up to 48 days.



Figure 2 Installed electrolyser at ZEM module

## Conclusions:

The demo campaign officially started on Jul'22, and it is expected to be extended until May 2024 at different sites. By the time this abstract was submitted, first results have been collected at 1<sup>st</sup> demo site.

In the last six months, the total consumption of the module has been slightly higher than 1850 kWh, which entails a consumption of 61 kWh/m<sup>2</sup> year, really close to the Passivhaus standards of 60 kWh/m<sup>2</sup>. Energy generation for the same period has exceeded 1850 kWh, also close to the annual production target of 4000 kWh.

Next steps of this 1<sup>st</sup> demo campaign will be to adjust automatic operation of hydrogen system, integrate it on the monitoring tool and continue collecting data with the different patterns that are given.



## Hydrogen powered portable generators for the decarbonization of music festivals and outdoor events

Donato Zangani<sup>\*a</sup>, Alessandra Cuneo<sup>a</sup>, Paula Barbero Gallo<sup>b</sup>, Stefano Limonta<sup>c</sup>

\* corresponding author: donato.zangani@rina.org

<sup>a</sup> RINA Consulting S.p.A.

<sup>b</sup> Fundación Hidrógeno Aragón

<sup>c</sup> Genport S.r.l.

*Keywords: decarbonisation of music festivals and outdoor events, portable generators*

### **Abstract**

#### **Introduction:**

Cities and their supply chains are responsible for almost 80% of the global energy consumption and over 60% of greenhouse gas emissions. It is expected that 70% of the global population will be living in urban areas by 2050. Cities are therefore central to the battle against global warming, through decarbonisation of transport, urban heating and cooling, industries and services. Within this scenario each contribution could be crucial to reach European target to be climate-neutral by 2050.

European cities, in particular during summer, are rich of food and music festivals which typically are organised outdoor and require a surplus of energy which cannot be provided by the electricity network. The consumption of energy for powering such events consume an enormous amount of electricity. Almost all music festivals are supplied by diesel fuel generators and power can represent up to 70% of an event carbon footprint, excluding audience travel and transport.

In order to address the need to decarbonise music festivals and other outdoor events, the European project EVERYWH2ERE has developed a set of hydrogen-powered portable generators in two power capacity size, 25 kW and 100 kW.

#### **Objectives: .....**

To demonstrate innovative integrated 25kW and 100 kW PEMFC systems mounted into an ATEX compliant container and connected to a pressurized H<sub>2</sub> portable storage system. The system has been tested with different load profiles in order to verify its durability for daily-intermittent usages as well as for more continuative and semi-stationary applications, representative of real use scenarios such as music festivals and outdoor events of various duration and extension.



### **Material and methods:**

The focus of the demonstrator is to have a robust and easy to set-up solution, enabling to be transported and easily connected with a “plug and play” hydrogen storage in order to fasten the refuelling and reduce installation time. Separating the H<sub>2</sub> storage box from the FC power system box also guarantees a more compact and less complicated design of the FC container for what it concerns ATEX prescriptions and presences of safety sensors/devices.

With the right sensorization and control logic, dangerous operation conditions can be detected and avoided.

Furthermore optimal control and management solutions based on Model Predictive Control, adaptive control strategies including diagnostic and prognostics functionalities, with the scope to efficiency and robustness or minimize component wearing and aging, have been developed and integrated.

### **Results:**

The first large demonstration campaign was set up in a construction site in San Sebastian (Spain) and started in March 2022 lasting until July. In the selected construction site, with a ground extension of about 82000 m<sup>2</sup>, one of the 8 tower cranes was fed by the 100 kW genset: the crane could load up to 7 600 Kgs, and the Maximum nominal power 68. 6 kW. Over the demo activities in San Sebastian, 533 hours of effective operation of the genset were detected and 935 kWh was supplied to construction site with a Consumption 247 kg of H<sub>2</sub>.

The second demonstration event was set up in MotorLand circuit in Aragon (Spain) for the MotoGP in September 2022: the giant screen installed in front of the main grandstand was successfully powered by the 100 kW genset.

Other demonstration activities are underway and include music festivals in Germany and outdoor events in Italy and Spain.

### **Conclusions:**

Hydrogen-powered portable generators in two power capacity size, 25 kW and 100 kW, have been developed specifically targeting music festivals and outdoor activities. A large demonstration campaign has been carried out and the generators are now available to power sustainable outdoor events for the decarbonisation of our urban environment.

### **Acknowledgment**

We acknowledge the funding received from the Fuel Cells and Hydrogen 2 Joint Undertaking under Grant Agreement No 779606 – EVERYWH2ERE project





## TH2ICINO: Towards Hydrogen Integrated Economies in Northern Italy - Demonstrating a Replicable Micro Hydrogen Ecosystem

Alessandra Cuneo<sup>\*a</sup>, Bruno Marcos Sodiro<sup>a</sup>

\* corresponding author: [alessandra.cuneo@rina.org](mailto:alessandra.cuneo@rina.org)

<sup>a</sup> RINA Consulting S.p.A

*Keywords: Ecosystem, hydrogen valleys, planning tools, replicability*

### **Abstract**

TH2ICINO (Towards H<sub>2</sub>ydrogen Integrated eEconomies In NOrthern Italy) supports the deployment of micro hydrogen economies for the EU by developing and demonstrating a full ecosystem integrated by 6 replicable use cases linked to the steps of the hydrogen value chain. The demonstration of the hydrogen valley will work on the four pillars of the hydrogen value chain: (i) hydrogen production, (ii) hydrogen storage, (iii) hydrogen distribution, and (iv) hydrogen consumption and will send the initial status of TH2ICINO in order to enable replication and expansion.

**Introduction:** Hydrogen will play a key role in our future energy systems and for delivering on the aim of achieving carbon-neutrality in the EU by 2050. As a clear sign of a growing and maturing hydrogen market, Hydrogen Valleys (Hydrogen Hubs) have begun to emerge all over the world. A “Hydrogen Valley” is a geographic area – a city, a region, an island or an industrial district – where several applications of hydrogen are combined in an integrated hydrogen ecosystem that consumes a significant amount of hydrogen, improving the economy and the environment around the project. TH2ICINO Valley project, that will start in September 2023, aims to develop and demonstrate a hydrogen ecosystem that covers a specific geography, starting from local/regional activities and covering multiple steps of the value chain from hydrogen production to storage, transport and off-take, to open up, in the future, the market to other stakeholders and end-users such as the local industries and the energy companies.

**Objectives:** TH2ICINO aims to support the deployment of micro hydrogen economies within the European Union (EU) by building a hydrogen ecosystem in Northern Italy. The main objectives include implementing an innovative concept for green hydrogen production, monitoring emissions trends and CO<sub>2</sub> savings, and demonstrating a replicable hydrogen ecosystem that covers the entire value chain. In addition, TH2ICINO will showcase a Master Planning Tool (MPT) that will contribute to the expansion and replicability of Hydrogen Valleys in Italy and Europe. By examining the initial status of TH2ICINO, the project aims to facilitate the replication and expansion of this model. The first stage involves the modeling, simulation, and scenario analysis, from electrolysis plant to end-user, evaluation and optimization, considering technological constraints.

**Material and methods:** The MPT utilized in this research is based on the Artelys Crystal platform [1], which is currently employed by the European Commission for analyzing energy and climate



policies (METIS1). Adapted specifically to the requirements of EU Hydrogen Valleys, the MPT will be integrated into a software suite that will provide support to local and regional decision-makers, as well as interested companies in the hydrogen sector, to develop and deploy micro hydrogen economies while ensuring scalability. Action Plans will be tailored to geographical constraints and leverage existing local assets, including renewable power sources. Newcomers will have the possibility to get into an already established environments, accounting for different levels of maturity and business strategies among current and future stakeholders in the hydrogen valley. The MPT will be validated using data obtained from the deployment of the concept design achieved in TH2ICINO.

**Results:** The project aims to decarbonize at least two sectors with strong focus on mobility and deploy different types of technologies across the value chain increasing mutual cost-effectiveness for producers and consumers, making hydrogen an attractive option in the energy mix. The implementation of an H2 Valley in an industrialized area has the potential to be a research frontier in the journey towards achieving net-zero emissions. The demonstration phase of the project involves showcasing various use cases that are essential for defining suitable business models, diversifying the valley and identifying non-technical barriers for future expansion. The demo cases include green H2 production, distribution via pipeline vs tube trailer, a Hydrogen Refueling Station and refueling from tube trailer as well as vehicle retrofitting. The target for H2 production is at least 500 t/y but the area has a much higher potential and demand will be boosted thanks to the starting of TH2ICINO. Continuous monitoring of emissions and CO2 savings is crucial to evaluate the Valley's performance. By establishing an exhaustive baseline, achievable reduction targets can be set and emissions reduced by 4400 tCO<sub>2</sub>/y which is equivalent to 1500 cars' CO<sub>2</sub>-yearly emissions.

**Conclusions:** The TH2ICINO project encompasses the entire value chain, creating a sustainable ecosystem that connects stakeholders and facilitates the links between supply and consumption. The participation of SEA Milano Airports, the operator of Malpensa International Airport (MXP), adds significant potential to ignite a hydrogen value chain in the area. TH2ICINO project aims to contribute to the broader goal of establishing sustainable hydrogen-based economies in Europe. The replicable nature of the project's outcomes, coupled with the development of the Master Planning Tool, offers valuable insights and practical guidance for the implementation of micro hydrogen economies and their potential for scalability. The project's focus on emissions monitoring and the demonstration of various use cases further emphasizes its contribution towards achieving a clean energy future.

### Acknowledgment



Funded by the  
European Union

This project has received funding from the European Union's Horizon Europe research and innovation programme under grant agreement No 101112098.

Views and opinions expressed are however those of the author(s) only and do not necessarily reflect those of the European Union or Clean Hydrogen Joint Undertaking. Neither the European Union nor the granting authority can be held responsible for them."

### References

[1] <https://www.artelys.com/crystal/super-grid/>



## **TOPIC 8: CROSS CUTTING AND OVERARCHING**



## Digital twin of autonomous surface marine vehicles: RAISE experience

V. Boscaino<sup>a</sup>, A. Odetti<sup>b</sup>, D. Di Cara<sup>a</sup>, G. Tinè<sup>a</sup>, N. Panzavecchia<sup>a</sup>, S. Aracri<sup>b</sup>, G. Bruzzone<sup>b</sup>,  
F.R. Bianchi<sup>c\*</sup>, L. Cardona<sup>c</sup>, B. Bosio<sup>c</sup>

\* corresponding author: F.R. Bianchi, E-mail: [fiammetterita.bianchi@edu.unige.it](mailto:fiammetterita.bianchi@edu.unige.it)

<sup>a</sup> Institute of Marine Engineering, National Research Council of Italy,  
via Ugo La Malfa, 153 – 90146 Palermo, ITALY

<sup>b</sup> Institute of Marine Engineering, National Research Council of Italy,  
via De Marini 6 – 16149 Genoa, ITALY

<sup>c</sup> Department of Civil, Chemical and Environmental Engineering (DICCA), University of Genoa,  
via Opera Pia 15b – 16145 Genoa, ITALY

*Keywords: digital twin, fuel cell, robotic platforms, environmental monitoring*

**Abstract:** RAISE (*Robotics and AI for Socio-economic Empowerment*) research project aims at technology innovations through data science and artificial intelligence use allowing for system operation optimization, effective monitoring and timely emergency procedure formulation. In this framework different devoted applications will be analysed including a smart Autonomous Surface Vehicle (ASV) applied as an environmental sensor carrier.

**Introduction:** Hydrogen plays a key role in the transition to alternative fuels. In fact, the endurance of a vehicle in zero-emission mode can be increased by developing a hybrid supply architecture which combines fuel cells to energy storage elements, such as batteries [1-2]. Coupling also renewable sources allows for creating self-sufficient vehicles which can be applied in remote areas and specific fields with a reduced energy demand. In addition to a proper and cost-effective technology design, their spread requires system-level simulation and digital twin approach, thus entering hardware testing confident in handling both normal and unexpected conditions. Indeed, digital twins have demonstrated a central role in a broad spectrum of applications, for instance monitoring, diagnostic and prognostic purposes, as well as design-oriented practices [3].

**Objectives:** Within the framework of the RAISE ecosystem of innovation, the digital twin modelling will be applied to an autonomous surface marine vehicle useful for sea monitoring (*Figure 1*). On-board energy supply system will be optimised considering the needs of both propulsion and auxiliary modules. Fuel cell, additional renewable sources and battery use will allow for the development of a green self-sufficient system.

**Material and methods:** Followed methodology will see a strict interdependence between experimental and modelling activity for creating an effective digital twin of the studied system. The choice of the software setup environment is a key step in view of significant impacts on the final performances. Here it will be carefully selected to operate with a wide range of components, including primary energy sources (i.e., fuel cells and batteries),

mechanical subsystems (i.e., propulsion systems), microcontroller-based modules (i.e., power management units) and even electronic circuit schematics (i.e., front-end converters). In this context, particular attention will be devoted to the development of an accurate fuel cell model, validated through the electrochemical characterization of a 300 W Proton Exchange Membrane (PEM) fuel cell stack. Finally, such a model will be integrated with the front-end conversion system, the power management unit and the propulsion section.

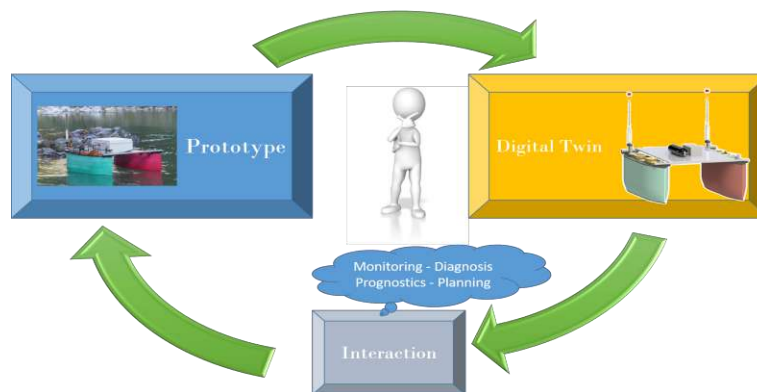

Fig. 1 - Digital Twin of an autonomous surface vehicle according to the RAISE concept.

**Results:** A comparison of predicted results with data gathered from prototype in-field sea missions will be used to evaluate the digital twin performances. Any discrepancies will be further examined in order to pinpoint and solve the digital twin module inaccuracies.

**Conclusions:** A digital twin of an autonomous surface marine vehicle will be developed and implemented within the framework of the RAISE ecosystem of innovation. The digital twin will aid at enhancing the performance of the on-board energy section, eventually offering a trajectory planning option oriented to energy saving. All gained expertise and knowledge could be also successfully applied to any other robotic platform, independently of the specific power rating.

### Acknowledgment

The research is supported by the project “Robotics and AI for Socio-economic Empowerment” (Project acronym: RAISE), within the framework of the Italian National Recovery and Resilience Plan (NRRP), Mission 4, Component 2, Investment 1.5, CUP B33C22000700006.

### References

- [1] IRENA, (2021) A Pathway to Decarbonise the Shipping Sector by 2050.
- [2] Z. Fu et al., (2023) Sustainable Energy Technologies and Assessments, 57, 103181.
- [3] M. Singh et al., (2021) Applied System Innovation, 4, 36.



## Enhancing Safety of Liquid and Vaporized Hydrogen Transfer Technologies in Public Areas for Mobile Applications

Ustolin F.\*<sup>a</sup>, Kuznetsov M.<sup>b</sup>, Jordan T.<sup>b</sup>

\* corresponding author: [federico.ustolin@ntnu.no](mailto:federico.ustolin@ntnu.no)

<sup>a</sup> Department of Mechanical and Industrial Engineering, Norwegian University of Science and Technology NTNU, Richard Birkelands vei 2B, Trondheim, 7031, Norway

<sup>b</sup> Karlsruhe Institute of Technology, Eggenstein-Leopoldshafen, 76344, Germany

*Keywords: Cryogenic and Liquid Hydrogen Transferring Technologies, Pre-Normative Research, Regulations Codes & Standards, Safety*

### Abstract

**Introduction:** Liquid hydrogen (LH<sub>2</sub>) will be needed in the near future due to the increase in hydrogen utilization as energy carrier in several new applications. International standards related to cryogenic and liquid hydrogen transferring technologies for mobile applications (filling of trucks, ships, stationary tanks) are missing, and there is lack of experience. The European project ELVHYS (Enhancing safety of liquid and vaporized hydrogen transfer technologies in public areas for mobile applications) [1] aims to provide indications on inherently safer and efficient cryogenic hydrogen technologies and protocols in mobile applications by proposing innovative safety strategies as result of a detailed risk analysis.

**Objectives:** The aim of this study is to provide a brief state of the art of cryogenic and liquid hydrogen technologies and present the new Horizon Europe project ELVHYS in which safety and efficiency of liquid and cryogenic hydrogen transfer technologies will be investigated. The focus is concentrated on safety issues for LH<sub>2</sub> technologies, and the presentations of the key points of the EU project ELVHYS: objectives, and planned activities.

**Material and methods:** The literature review is carried out by seeking for relevant sources in the literature and by exploiting the results of past pre-normative research projects such as PRESLEY [2] and SH2IFT [3].

**Results:** LH<sub>2</sub> rapidly evaporates when in contact with the atmosphere due to its ultra-low boiling point (-253°C) at atmospheric pressure. Double-walled vacuum insulated equipment (e.g. tanks, hoses) must be adopted to store and transfer LH<sub>2</sub>. The boil-off gas (BOG) formation is an issue from the energy efficiency and safety perspectives. Effective safety



devices (e.g. pressure relief valves (PRVs), breakaway couplings) must be considered when designing and operating LH2 systems. Although a few international standards exist for the design of cryogenic components (e.g. tanks [4], PRVs [5]), these regulations are missing for the operation of LH2 transfer facilities in different applications such as bunkering.

The main objective of ELVHYS is to enhance the safety level and support the development of regulations, codes and standards (RCSs) of hydrogen technologies and applications by focussing on safety and efficiency of liquid and cryogenic hydrogen transfer technologies. This is carried out by applying an inter-disciplinary approach to study both the cryogenic hydrogen transferring procedures and the phenomena that may arise from the loss of containment of a piece of equipment containing hydrogen.

**Conclusions:** A brief preliminary state of the art of liquid and cryogenic hydrogen technologies was provided in this work. The focus was placed on LH2 storage tanks, their insulation, components, and safety devices. Critical information was given on the BOG rate of this type of systems. An overview of the available international standards on the design and transfer of LH2. The aim of the state of the art was to highlight the knowledge gap still existent on the LH2 transfer technologies. The main objective of Horizon Europe project ELVHYS is to fulfil the dearth of knowledge on LH2 transfer technologies, thus enhance their safety and efficiency and aid the deployment of large-scale hydrogen technologies.

### Acknowledgment

This work was undertaken as part of the ELVHYS project No. 101101381 supported by the Clean Hydrogen Partnership and its members. UK participants in Horizon Europe Project ELVHYS are supported by UKRI grant numbers 10063519 (University of Ulster) and 10070592 (Health and Safety Executive). Funded by the European Union. Views and opinions expressed are however those of the author(s) only and do not necessarily reflect those of the European Union or the Clean Hydrogen Partnership. Neither the European Union nor the Clean Hydrogen Partnership can be held responsible for them.

### References

- [1] ELVHYS (Project No. 101101381), Horizon Europe, 2023, <https://elvhys.eu/>
- [2] PRESLEY (Grant Agreement No 779613), Horizon 2020, 2022, <https://presley.eu/>
- [3] SH2IFT (ENERGIX - 280964), 2022, <https://www.sintef.no/projectweb/sh2ift/>
- [4] ISO, Cryogenic vessels - Large transportable vacuum-insulated vessels, ISO20421-1:2019.
- [5] ISO, Cryogenic vessels - Pressure-relief accessories for cryogenic service, ISO21013-3, 2016.



# European Fuel Cells and Hydrogen

PIERO LUNGI CONFERENCE

September 13th-15th 2023  
Capri / Italy

## Green Hydrogen: a wider vision for policies

Gaetano Squadrito\*, Gaetano Maggio, Agatino Nicita

*Consiglio Nazionale delle Ricerche - Istituto di Tecnologie Avanzate per l'Energia "Nicola Giordano" (CNR-ITAE),  
via Salita S. Lucia sopra Contesse 5, 98126 Messina, Italy*

\* Presenter author. Tel.: +39 090 624274; fax: +39 090 624247.  
E-mail address: gaetano.squadrito@itae.cnr.it (G. Squadrito).

### Abstract

To face the pollution and global warming issues a shift towards renewable energy technologies is currently running in the world energy mix. Renewable energy in 2016 accounted for less than 15% of electricity, nowadays it represents 28% of the world's electricity production and 13.8% of the global energy consumption. The progressive increase of the RES power share in the electric grid introduces issues related to the natural discontinuity and fluctuations of RES, that are the object of an increasing number of investigations, and require energy storage systems to mitigate them. Although there are different possible technologies for energy storage, hydrogen is considered the most suitable choice for massive and long term storage of RES power. This is because hydrogen is an energy vector (fuel) and also a commodity gas and a feedstock for many industrial applications, so that it can also strongly contribute to decarbonisation of a number of sectors defined "hard to abate".

Nowadays, almost all hydrogen is produced by Steam Methane Reforming (SMR). According to the IEA, Global Hydrogen Review 2022, about 82% of the produced hydrogen (94 Mt, in 2021) is directly derived from methane, oil and carbon. About 18% is a by-product coming from different production technologies (e.g., naphtha reforming). Therefore, hydrogen produced by low-emission technologies is less than 1 Mt (0.7%), with the majority of this coming from fossil fuels with CCUS (about 0.7%) and only 0.04% (35 kt H<sub>2</sub>) coming from renewable electricity via water electrolysis. In 2021, the emissions associated with hydrogen production were more than 900 Mt CO<sub>2</sub>. Hydrogen production costs by these processes are low, \$1-2/kg H<sub>2</sub> for SMR and \$1-1.5/kg H<sub>2</sub> for gasification, respectively. The main challenge is how to produce hydrogen for today's and future uses at costs that are close to current ones, but without emitting CO<sub>2</sub> into the atmosphere. The two approaches currently able to meet this challenge are "blue hydrogen" and "green hydrogen". But the most important





game is played on green hydrogen, the production of which does not entail CO<sub>2</sub> emissions as only renewable energy is used.

Green hydrogen can be produced by various methods, but the most suitable and well developed technology is based on electrochemical water splitting (electrolysis), then “Green Hydrogen” is usually defined as “Hydrogen made via electrolysis using renewable electricity”. This concept has focused the policies of Europe and other developed countries, concentrating investments in this direction forgetting other production paths of green hydrogen.

Moreover, focusing the attention to electrolysis some geopolitical and social issues are coming up, like for example the water issue that is related to the necessity of having high purity water for running electrolysis. Some scholars argue that the growth of green hydrogen within the global economy could lead to geo-economic and geopolitical changes, in which new scenarios and interdependencies will be shaped. The consequences will be a different geography of energy trade with the emergence of new centres of geopolitical influence, based on the production and use of hydrogen.

In this work, starting from some considerations about available technologies, a wider concept of green hydrogen is defined. In doing so, we analysed and compared peculiar advantages and shortcomings of different green hydrogen technologies (biomass pyrolysis and gasification, water electrolysis, etc.), with a focus on the electrolysis process as the most promising method for large scale and distributed generation of hydrogen. Some geopolitical and sociotechnical aspects associated with the electrolysis and water issue are examined by looking at the hydrogen international policies’ plans. This with the purpose of supplying to policy makers an overview of possible solutions and of suggesting them a holistic approach looking at all the possible technologic approaches in front of an approach focused on a single technology.



## Does the Environmental Kuznets Curve Hypothesis Hold. Evidence from European countries

Massimiliano Cerciello\*<sup>a</sup>

\* corresponding author: Massimiliano Cerciello

<sup>a</sup> University of Naples Parthenope, Department of Economic and Legal Studies

*Keywords: CO2 emissions, environmental Kuznets curve, renewable energy, energy policies.*

### **Abstract**

**Introduction:** Greenhouse gases are considered as a key driver of climate change, posing significant threats to environmental and economic sustainability. In 2021, the European Commission launched the zero-pollution target, aiming to achieve climate neutrality by 2050. While several actions need to be undertaken in order to achieve this target, it is unclear whether and how economic growth may contribute to reducing emissions. In particular, the empirical literature is divided on the validity of the Environmental Kuznets Curve (EKC) hypothesis, according to which the relationship between economic wellbeing and environmental impact is nonlinear.

**Objectives:** Thus, this work aims to test whether the EKC hypothesis holds in Europe, proposing an empirical analysis. Moreover, it attempts to identify the key drivers of pollution in the Old Continent.

**Material and methods:** The dataset employed consists of observations for 34 European countries (of which 27 EU member states and 7 non-EU countries) between 1990 and 2017. In particular, the dependent variable considered is the amount of CO<sub>2</sub> emissions per capita, while economic wellbeing is proxied using GDP per capita. The nonlinear relationship between these variables is tested, controlling for time persistence in CO<sub>2</sub> emissions and for a number of socio-economic factors, including total energy consumption, the share of renewable energy and international trade. To address the problem of endogeneity, the Arellano-Bond estimator for dynamic panels is implemented. Moreover, the model is extended to include nonlinearities in other variables.

**Results:** this work confirms the EKC hypothesis and identifies some key drivers of CO<sub>2</sub> emissions in Europe. Allowing for nonlinear effects of other covariates, the results hold. Policy implications are discussed.



**Conclusions:** Economic progress in advanced countries comes with environmental benefits. However, it needs to be paralleled by effective environmental regulations, so as to decouple economic growth from environmental impacts. Stricter measures are required in the near future in order to push energy-intensive industries to invest in green and eco-friendly technologies.



## Determinants of the EU region's hydrogen technologies innovation

Chiara Leggerini<sup>a\*</sup>, Mariasole Bannò <sup>a</sup>

\* corresponding author

<sup>a</sup> University of Brescia (Italy)

*Keywords: hydrogen, innovation, determinants, NUTS 2*

### Abstract

**Introduction:** Over the past two decades, significant advancements have been made in hydrogen technologies, positioning it as the energy source of the future. Many industrial sectors (chemical, petrochemical, metallurgical, food, electronic and energy) use hydrogen as a raw material [1]. These developments have been driven by the increasing need for green and sustainable hydrogen production methods [2]. Reviewing the literature many studies analyze the impact of policies on renewable innovations, or the relationship between green technologies and CO<sub>2</sub> emissions, few studies have evaluated the factors determined innovation in renewable innovations ([3], [4], [5],[6]). To the best of our knowledge, no study has focused on hydrogen technologies at the European NUTS 2 level.

**Objectives:** This study aims to comprehensively understand the key factors that determine innovation in hydrogen technologies within the European context. The goal is to provide valuable insights to guide policymakers in effectively promoting the ecological and energy transition at the regional level.

By identifying and analyzing the drivers behind innovation in this field, policymakers can make informed decisions and implement regional strategies to accelerate the development and adoption of sustainable hydrogen technologies. This, in turn, will contribute to achieving the broader objectives of promoting environmental sustainability and facilitating the transition to cleaner energy sources.

**Material and methods:** Researchers have mainly focused on studying the main determinants of innovation involving the more traditional renewable energy sources such as solar, wind, geothermal, hydro and marine ([6], [7],[8]). Given the importance that hydrogen technologies will have for the future of the ecological and energy transition, it is appropriate to identify the determinants for European nations to innovate in this field. Following [9] and [10] we used the number of patents registered at the European Patent Office (EPO) in the various hydrogen technologies as a proxy for innovation in hydrogen technologies. The data were retrieved from the OECD Patent Database, which offers, sorting by year of application, patents from 1978 to 2021 and also the possibility of having geolocation at the NUTS 2 level.

To conduct the study at the European NUTS 2 level, we reduced the time frame under investigation to have a significant number of patents made in the various European regions and to have a set of independent and control variables that could always be regional level. Therefore, the first year considered was 2000.

Many studies have looked at what determinants lead one state to innovate more than another, one of the variables that is often considered is a state's gross domestic product. Gross domestic product and R&D would seem to have a positive and significant impact on a state's ability to innovate ([11], [12],[13]). So we considered gross domestic product and R&D spending by individual regions as independent variables since innovation comes from continuous resource inputs. To look at specific funding in hydrogen technologies, we use the information provided by R&T Telescope, which provides exclusive and comprehensive insights from a vast array of exceptional research and development initiatives funded by the European Union, providing access to specific and in-depth information.

Being that states might have a different capacity to innovate, this factor from [7] was controlled by taking into account the total number of patents registered at EPO by a nation in a given year, this variable is found to be positive, suggesting that some of the variation in patent activity in renewable energy is due to changes in the general propensity to patent. To consider the capacity of individual regions in developing technologies for producing energy from renewable sources, we have considered the patents made in geothermal, hydro, oceanic, solar (PV and thermal), wind and energy generation of nuclear origin.

Following [6] who have studied the implementation of the Kyoto Protocol and shown that it has a strong positive impact on renewable patents we decided to study the effect of signing up to the 2030 agenda. We then created a dummy variable that takes a value of 0 for years prior to 2016 and 1 for years since 2016 to assess whether collective institutional commitment may have promoted innovation in this area. [14] and [15] have shown that the institutional environment can also positively



influence innovation, stimulating people and improving efficiency, so a measure of the quality of institutions was also considered among the dependent variables.

Finally, we decided to use a panel model to consider both the sample's diversity and the temporal evolution of the phenomenon. Given the count nature of the dependent variable, we decided to use a negative binomial model, also following [16], [8] and [17]

**Results:** The preliminary results suggest that innovation occurs differently across European regions. Considering R&D spending and gross domestic product, they positively impact innovation in hydrogen technologies. European funding is also found in renewable sources. Evaluating the regional capacity to generate patents in this sector, the more advanced regions are patent technologies involving hydrogen.

The general awareness and setting of shared objectives at European level through the 2030 Agenda have had a positive impact. Finally, considering the institutions, the better administered a region is, the more this favors innovation in hydrogen technologies.

**Conclusions:** Understanding the factors driving innovation in hydrogen technologies can enable developing and implementing technologies that reduce greenhouse gas emissions and promote the transition to a low-carbon economy. It can also reduce energy dependence by diversifying sources of energy supply, decreasing dependence on fossil fuels. It can create economic growth and job creation by creating policies and strategies based on these determinants to support the hydrogen industry. Several nations are investing in the development of hydrogen technologies, recognizing its potential in the context of a sustainable energy transition. Understanding the factors driving innovation in hydrogen technologies can help maintain international competitiveness by promoting the adoption and development of innovative solutions in the sector.

#### References

- [1] W. J. Martinez-Burgos *et al.*, «Hydrogen: Current advances and patented technologies of its renewable production», *J. Clean. Prod.*, vol. 286, p. 124970, mar. 2021, doi: 10.1016/j.jclepro.2020.124970.
- [2] S. Mona *et al.*, «Green technology for sustainable biohydrogen production (waste to energy): A review», *Sci. Total Environ.*, vol. 728, p. 138481, ago. 2020, doi: 10.1016/j.scitotenv.2020.138481.
- [3] C. B. Milindi e R. Inglesi-Lotz, «The role of green technology on carbon emissions: does it differ across countries' income levels?», *Appl. Econ.*, vol. 54, fasc. 29, pp. 3309–3339, giu. 2022, doi: 10.1080/00036846.2021.1998331.
- [4] Y.-J. Zhang, Y.-L. Peng, C.-Q. Ma, e B. Shen, «Can environmental innovation facilitate carbon emissions reduction? Evidence from China», *Energy Policy*, vol. 100, pp. 18–28, gen. 2017, doi: 10.1016/j.enpol.2016.10.005.
- [5] R. Hashmi e K. Alam, «Dynamic relationship among environmental regulation, innovation, CO2 emissions, population, and economic growth in OECD countries: A panel investigation», *J. Clean. Prod.*, vol. 231, pp. 1100–1109, set. 2019, doi: 10.1016/j.jclepro.2019.05.325.
- [6] S. Li e Q. Shao, «Exploring the determinants of renewable energy innovation considering the institutional factors: A negative binomial analysis», *Technol. Soc.*, vol. 67, p. 101680, nov. 2021, doi: 10.1016/j.techsoc.2021.101680.
- [7] N. Johnstone, I. Haščič, e D. Popp, «Renewable Energy Policies and Technological Innovation: Evidence Based on Patent Counts», *Environ. Resour. Econ.*, vol. 45, fasc. 1, pp. 133–155, gen. 2010, doi: 10.1007/s10640-009-9309-1.
- [8] E. Hille, W. Althammer, e H. Diederich, «Environmental regulation and innovation in renewable energy technologies: Does the policy instrument matter?», *Technol. Forecast. Soc. Change*, vol. 153, p. 119921, apr. 2020, doi: 10.1016/j.techfore.2020.119921.
- [9] G. Valacchi, J. Raffo, A. Daly, e D. Humphreys, «Mining innovation and economic cycles: how commodity prices affect mining related patenting?», *Miner. Econ.*, feb. 2023, doi: 10.1007/s13563-022-00359-7.
- [10] H. H. Trinh, L. Pham, D. T. H. Vo, e G. Phung, «Do Different Types of Technological Innovations Equally Contribute to the Energy-Growth Nexus? New Evidence from Patent Counts in the Era of Climate Change», SSRN, preprint, 2023. doi: 10.2139/ssrn.4415082.
- [11] University of Tirana, Albania, Faculty of Economics, M. Kapidani, E. Luci, e University of Tirana, Albania, Faculty of Economics, «The Effects on Innovation from Financial Sector Development: Evidence from Developing Countries», *J. Compet.*, vol. 11, fasc. 2, pp. 84–94, giu. 2019, doi: 10.7441/joc.2019.02.06.
- [12] R. E. Ortiz Henriquez, F. Crespo, C. Geldes, T. Alves Ferreira, e M. Castillo-Vergara, «Impact of R&D on the Innovation of Products and Processes in Latin Countries», *Axioms*, vol. 12, fasc. 2, p. 149, feb. 2023, doi: 10.3390/axioms12020149.
- [13] S. Abbas, Z. Ahmed, A. Sinha, O. Mariev, e F. Mahmood, «Toward fostering environmental innovation in OECD countries: Do fiscal decentralization, carbon pricing, and renewable energy investments matter?», *Gondwana Res.*, p. S1342937X2300076X, mar. 2023, doi: 10.1016/j.gr.2023.03.002.
- [14] W. G. Park e J. C. Ginarte, «INTELLECTUAL PROPERTY RIGHTS AND ECONOMIC GROWTH», *Contemp. Econ. Policy*, vol. 15, fasc. 3, pp. 51–61, lug. 1997, doi: 10.1111/j.1465-7287.1997.tb00477.x.
- [15] S. Bianchini, P. Llerena, e R. Martino, «The impact of R&D subsidies under different institutional frameworks», *Struct. Change Econ. Dyn.*, vol. 50, pp. 65–78, set. 2019, doi: 10.1016/j.strueco.2019.04.002.
- [16] A. Pitelis, N. Vasilakos, e K. Chalvatzis, «Fostering innovation in renewable energy technologies: Choice of policy instruments and effectiveness», *Renew. Energy*, vol. 151, pp. 1163–1172, mag. 2020, doi: 10.1016/j.renene.2019.11.100.
- [17] S. Li e Q. Shao, «Exploring the determinants of renewable energy innovation considering the institutional factors: A negative binomial analysis», *Technol. Soc.*, vol. 67, p. 101680, nov. 2021, doi: 10.1016/j.techsoc.2021.101680.



## Planning the role of hydrogen in the Campania region smart energy transition

V. Battaglia<sup>a\*</sup>, N. Massarotti<sup>a</sup>, L. Vanoli<sup>a</sup>

<sup>a</sup>University of Naples 'Parthenope', Centro Direzionale - Isola C4 80143 Napoli, Italy

\* corresponding author: vittoria.battaglia@uniparthenope.it

Keywords: Energy planning, Fuel cells, Mobility, EnergyPLAN

**Abstract** Energy systems characterized by high integration of renewable energy sources must face the challenge of dealing with intermittent surplus electricity generated by them. Electrolysers could potentially play a vital role in addressing this issue, since they can use the surplus electricity to produce hydrogen, employable as both an energy carrier and in industrial processes. The main objective of this study is to analyse the future energy strategy for Campania, an Italian region, that aligns with the European targets for reducing CO<sub>2</sub> emissions by 2050. This is done by modelling the current energy system and implementing a scenario for the year 2050 that includes a significant integration of RES and employs Power-to-gas technologies to harness surplus electricity and produce hydrogen to be used in the transportation sector. A techno-economic and environmental analysis was conducted to assess the potential of this strategy, using EnergyPLAN. **Introduction:** Existing energy systems use different energy grids to meet the electricity, heating, industry, and transport sector demands. In the future, this will have to change as energy systems with high integration of variable renewable energy sources will require to deal with the intermittent supply. The mismatch between demand and production from renewable energy sources can be dramatic, especially when their integration into the energy system is very high. For this reason, future energy systems, namely smart energy systems [1], will require coordination between grids, users and energy conversion technologies, in order to identify synergies, increase efficiency and reduce costs. One of the ways of managing the excess electricity production from renewables is to use it to feed electrolysers and produce hydrogen, which can be used in many applications. Power to gas is defined as technologies that transform excess electricity into hydrogen or methane, which can be utilized as a fuel or stored as an energy reserve. It has emerged as a promising approach to integrate renewable energy sources into the energy system. Once hydrogen is produced, it can be used in transport sector, both as a fuel in vehicles and as to produce e-fuels[2].

**Objectives:** The purpose of this study is to implement a smart energy model of an Italian region, Campania, that will have to meet the European decarbonization targets for the year 2050, using high integration of renewable energy sources (RES) and power-to-gas strategy to aid with the surplus electricity produced. It is done by implementing the smart energy model of the region for the year 2050, using EnergyPLAN [3] as the main environmental and techno-economic model. The results of this analysis are integrated with social key performance analysis as well.



**Material and methods:** The methodology applied to implement a future smart energy scenario started with the implementation of a reference model of the energy system under analysis, which, in this case, is an Italian region, Campania. For this step a bottom-up approach was used for the analysis of energy demand and energy supply analysis. The entire system was then built in the main model which is EnergyPLAN, an analytically programmed energy system analysis tool that simulates the hourly operation of an energy system over a year. Based on the performance of the reference scenario, a smart energy model was implemented considering a higher introduction of RES in the system together with a Power-to-heat strategy. A more detailed description of the methodology used in this work is available in[4]. Once evaluated the excess surplus energy produced by RES, a Power-to-Gas technology was used to abate it. The produced hydrogen was used in transport sector, replacing fossil fuel consumption.

**Results:** The methodology presented is applied to Campania region, in South Italy. The actual regional energy consumption for the year 2017 for each sector was modelled, using a bottom-up approach with analysis of GIS tools for the assessment of final energy needs. From the current energy system, a 2050 scenario based on the following assumptions, was implemented: i. electrification of the transport sector was expected to increase, covering a share of 28%; ii. the total programmable thermoelectric generation was predicted to half; iii. district heating and cooling networks would be powered by cogeneration plants fueled by natural gas and RES; iv. increase in installed wind and PV; v. use of manure biomass to produce biomethane. The results show that a strong integration of RES allows to achieve the sustainability goals set, but it also translates into a presence of excess electricity, for an annual total of about 2.4 TWh. Taking this into account, it is possible to use the whole surplus from RES to produce hydrogen that will be used for mobility, by using alkaline electrolyzers with an efficiency of 65%, for a total capacity of 1.3 GW. The social impact of the proposed scenario can be evaluated by specifically designed indexes.

**Conclusions:** The investigation focused on a future scenario that has already achieved the European environmental objective of reducing CO<sub>2</sub> emissions by 80% compared to the 1990 level. The findings of the authors suggest that there is room for further emission reductions and a means to utilize surplus electricity generated by RES. Future research should include different types of conversion technologies and the production of electrofuels.

## References

- [1] J. Z. Thellufsen *et al.*, "Smart energy cities in a 100% renewable energy context," *Renew. Sustain. Energy Rev.*, vol. 129, no. May, 2020.
- [2] "The Future of Hydrogen," *Futur. Hydrog.*, no. June, 2019.
- [3] "EnergyPLAN | Advanced energy systems analysis computer model." [Online]. Available: <https://www.energyplan.eu/>. [Accessed: 06-Mar-2020].
- [4] V. Battaglia, G. De Luca, S. Fabozzi, H. Lund, and L. Vanoli, "Integrated energy planning to meet 2050 European targets: A Southern Italian region case study," *Energy Strateg. Rev.*, vol. 41, no. March, p. 100844, 2022.

## Hydrogen Valleys: a catalyst for advancing the global hydrogen value chain

F. Del Mondo<sup>a</sup>, D. Pivetta<sup>a</sup>, M. Bogar<sup>a</sup>, N. Zuliani<sup>a</sup>, P. Sandrin<sup>b</sup>, R. Tacconi<sup>\*a</sup>

\* corresponding author: [tacconi@units.it](mailto:tacconi@units.it)

<sup>a</sup> Department of Engineering and Architecture, University of Trieste, Trieste, Italy

<sup>b</sup> AREA Science Park, Padriciano (Trieste), Italy

*Keywords: Decarbonisation, Hydrogen Policies, Hydrogen Strategies, Hydrogen valleys.*

### Abstract

The global shift towards decarbonisation and sustainable energy systems has sparked a growing interest in the development of a hydrogen-based economy. This paper explores the concept of 'hydrogen (H<sub>2</sub>) valleys' as focal points for the accelerated production, distribution and utilisation of H<sub>2</sub>. It presents technical and economic analyses of the development of H<sub>2</sub> valleys, highlighting the wide range of international initiatives and support mechanisms provided by countries around the world to promote the adoption of H<sub>2</sub> technologies. This study analyses and elaborates data available from [1] and other technical reports in the literature for 5 geographical areas/countries, representative of the policy approaches adopted to support H<sub>2</sub> valleys (hubs or clusters). Financing mechanisms, role of public and private sectors and general characteristics of H<sub>2</sub> valleys are described in the Table 1, which reports the main results of the analysis.

*Table 1: Main results of the analysis on hydrogen valleys development worldwide*

Area/country	N. H <sub>2</sub> valleys (large-scale)	Fundings (Public and/or Private)	Policies and initiatives	Peculiarities	Refs
Europe	62 (24)	Public and private	- Repower EU - H2020 Horizon - A hydrogen strategy for a climate-neutral Europe	Industry-focused, mobility and industry internal use. Collaboration between different H <sub>2</sub> valleys	[2,3]
Australia	4 (2)	Public and private	- Australia's National Hydrogen Strategy - Other regional fundings	Industry, energy and mobility internal uses and export potentials.	[4]
USA	4	Public and private	- U.S. National Clean Hydrogen Strategy and Roadmap	Industry-focused. Production and internal transport (trucks and pipelines).	[5]
Chile	2 (2)	Private	- National Green Hydrogen Strategy	Production from renewables and export potentials.	[6]
China	3	Public	- China Fuel Cell Subsidy Policy - Medium and Long-Term Planning for the Development of Hydrogen Energy Industry	Focus on mobility (cars, buses, trucks, forklift) and energy.	[7]
Middle East	3 (2)	Public and private	- Net Zero Emissions in 2050 and Green Hydrogen Strategy (Oman) - National Plan to Integrate Hydrogen into Energy Landscape (Israel)	Development of large-scale H <sub>2</sub> production plants and export potentials	[8,9]

European countries are leader in the development of H<sub>2</sub> valley (hosting 75% of global H<sub>2</sub> valleys) with 26 large-scale H<sub>2</sub> valleys (i.e. entailing a production of more than 10 t<sub>H<sub>2</sub></sub>/d) under development. Large-scale H<sub>2</sub> valleys can help reduce H<sub>2</sub> production costs, develop a large





infrastructure network and increase the scale of implemented technologies. Funding support from private and public sectors, generally operates by EU countries, goes beyond simply building infrastructure; it entails a long-term commitment to H<sub>2</sub> production and/or supply, breaking the chicken-and-egg dilemma that often hinders the construction of large-scale plants. One of the strengths of European policies lies in their promotion of cooperation among different H<sub>2</sub> valleys and the possibility of exchange between countries within the EU. Currently, 8 cross-border H<sub>2</sub> valleys are under development, ensuring enhanced energy and legislative interconnection among nations and improved resource sharing [1–3]. One example of transnational hydrogen valley is the North Adriatic Hydrogen Valley (NAHV) which compasses the territories of Friuli Venezia Giulia region (Italy), Slovenia and Croatia.

A different approach is adopted by Middle East countries, which hold promising potential as green H<sub>2</sub> exporters due to their abundant renewable energy resources. In these cases, H<sub>2</sub> production is almost entirely devoted to export overseas by shipping. The analysis emphasises that ports could play a key role in facilitating the development of infrastructure for both mobility (e.g. port vehicles and ships), energy-intensive industries and creating potential opportunity for green energy export/import. A global H<sub>2</sub> production is expected to be 42% by 2050 in port areas [10].

While in Europe, Australia, USA and Middle East a combination of public and private fundings, in China, the three H<sub>2</sub> clusters are totally financed by the government. It is worth noticing that H<sub>2</sub> utilization is focused on mobility applications, as evidenced by industry and energy planning for H<sub>2</sub> [7].

The combination of public-private fundings could lead to a greater diffusion of expertise and an accelerated and competitive development of technologies, as expected for EU hydrogen initiatives.

## References

- [1] H<sub>2</sub>Valleys | Mission Innovation Hydrogen Valley Platform n.d. <https://h2v.eu/> (accessed July 3, 2023).
- [2] Vivanco-Martín B, Iranzo A. Analysis of the European Strategy for Hydrogen: A Comprehensive Review. *Energies* 2023, 16, 2023. <https://doi.org/10.3390/EN16093866>.
- [3] EUR-Lex - 52020DC0301 - EN - EUR-Lex n.d. <https://eur-lex.europa.eu/legal-content/EN/TXT/?uri=CELEX:52020DC0301> (accessed July 3, 2023).
- [4] Government Hydrogen Policies for Australia | AHC n.d. <https://h2council.com.au/government-hydrogen-policies/> (accessed July 3, 2023).
- [5] U.S. National Clean Hydrogen Strategy and Roadmap n.d. <https://www.hydrogen.energy.gov/pdfs/us-national-clean-hydrogen-strategy-roadmap.pdf> (accessed July 3, 2023).
- [6] National Green Hydrogen Strategy - Chile n.d. [https://energia.gob.cl/sites/default/files/national\\_green\\_hydrogen\\_strategy\\_-\\_chile.pdf](https://energia.gob.cl/sites/default/files/national_green_hydrogen_strategy_-_chile.pdf) (accessed July 3, 2023).
- [7] Meng X, Chen M, Gu A, Wu X, Liu B, Zhou J, et al. China's hydrogen development strategy in the context of double carbon targets. *Nat Gas Ind B* 2022;9:521–47. <https://doi.org/10.1016/J.NGIB.2022.11.004>.
- [8] National hydrogen strategy of Israel n.d. <https://www.gov.il/en/departments/news/news-150523-2> (accessed July 3, 2023).
- [9] The Sultanate of Oman's National Strategy for an Orderly Transition to Net Zero n.d. [https://www.ea.gov.om/media/aaslyc3l/oman-net-zero-report-2022\\_screen.pdf](https://www.ea.gov.om/media/aaslyc3l/oman-net-zero-report-2022_screen.pdf) (accessed July 3, 2023).
- [10] Study on hydrogen in ports and industrial coastal areas n.d. [https://www.clean-hydrogen.europa.eu/media/news/press-release-study-hydrogen-ports-and-industrial-coastal-areas-2023-03-30\\_en](https://www.clean-hydrogen.europa.eu/media/news/press-release-study-hydrogen-ports-and-industrial-coastal-areas-2023-03-30_en) (accessed July 3, 2023).

## The hydrogen role in the Italian energy system for Net-Zero CO<sub>2</sub>

S. Campanari<sup>\*,a</sup>, P. Colbertaldo<sup>a</sup>, F. Parolin<sup>a</sup>, M. Motta<sup>a</sup>, F. Fattori<sup>a</sup>, F. Mezzera<sup>a</sup>

\*corresponding author: stefano.campanari@polimi.it

<sup>a</sup> Department of Energy, Politecnico di Milano – Via Lambruschini 4A, 20156, Milan, Italy

**Keywords:** hydrogen, energy system modeling, net-zero CO<sub>2</sub>.

### Abstract

Hydrogen allows a ‘sector-coupled’ evolution of the energy infrastructures towards a net zero-CO<sub>2</sub> emission target, acting as clean energy vector with multiple roles ranging from energy storage to decarbonization of hard-to-abate applications. The role of hydrogen in the national energy system can be evaluated through detailed integrated energy system models. This work shows the main results of ongoing simulation efforts, evidencing the impact of hydrogen in the different energy fields and the effect of different key assumptions on the results.

### Introduction

Clean hydrogen can be produced by different sources (from renewables as well as from low-carbon pathways, like blue H<sub>2</sub>), similarly to electricity. Hydrogen use enables the decarbonization of diverse sectors and applications (hard-to-electrify industrial processes, part of heavy-duty land transport, aviation and maritime transport, part of civil heating and power uses). In addition, hydrogen allows large-scale energy storage, coupling and interweaving of energy sectors with a resilient, multi-vector (or ‘multi-fuel’) energy infrastructure. Analysing the role of H<sub>2</sub> in long-term and low- or net-zero CO<sub>2</sub> emission scenarios requires the development of adequate integrated energy system modelling tools, able to perform the simulation and optimization of the national energy system [1,2].

### System description, Methods, and Data

The OMNI-ES framework, used for this work, adopts a multi-vector (electricity, hydrogen, methane blends, liquid fuels), multi-node (representing multiple regions), and multi-sector (civil, industrial, mobility land/sea/air) approach (Figure 1). The analysis is time-dependent (hourly balances in each node, tracking the power and storage evolution needs) and tracks the domestic and imported sources (incl. renewables, natural gas, biogas, waste, imports of electricity, hydrogen, and liquid fuels) and the energy networks along the Italian geography. Objective of the analysis is achieving the target of net-zero CO<sub>2</sub> at minimum total system cost (including CAPEX for new plants and revamping and OPEX for

O&M, domestic sources, energy vector import, inter-regional exchanges of energy vectors, carbon capture and storage).

The many assumptions behind the model, of which an example is reported in literature [2], are constantly updated by the research group to improve the representation of the evolution of the Italian energy system.

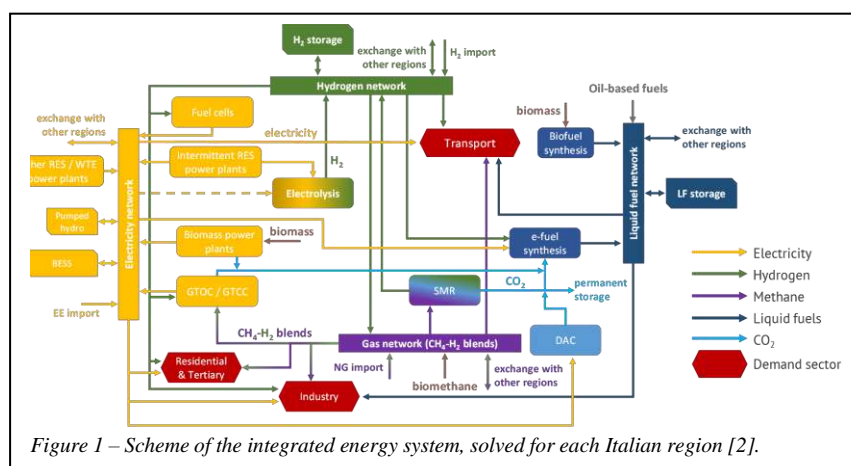









Figure 1 – Scheme of the integrated energy system, solved for each Italian region [2].

## Results and Discussion

An extract of results is reported in Figure 2. Hydrogen is largely adopted to decarbonize uses that currently rely on natural gas, in addition to being used in mobility. In this specific sector, electricity is largely used to decarbonize «light mobility» (passenger cars and LDV, small/short-range aviation and navigation), while hydrogen goes mostly for heavy-duty transport, part of aviation and navigation, and the remaining keeps relying on liquid fuels. As a whole, the introduction of hydrogen allows a substantial contribution to decarbonization (total Italy's 'baseline' emission of CO<sub>2</sub> is nearly 330 Mt/y).

Energy vector	Annual consumption (final uses + conversion)	Uses	Variation from 2020	H2 impact on CO <sub>2</sub> emissions reduction
Electricity (production RES + thermoelectric + import)	~ 800 TWh <sub>e</sub> /y	Direct final demand (~400 TWh <sub>e</sub> /y) + demand for mobility (~55 TWh <sub>e</sub> /y) + electrolysis + CO <sub>2</sub> capture units	~3x	6 Mt <sub>CO2</sub> /y avoided in power generation 
H <sub>2</sub> (domestic electrolysis or SMR + import)	~ 300 TWh <sub>LHV</sub> /y (~ 10 Mt <sub>H2</sub> /y)	Direct final demand for mobility (~130 TWh <sub>LHV</sub> /y) + industrial feedstock demand (~15 TWh <sub>LHV</sub> /y) + thermoelectric power generation, civil heating, industry (total 155 TWh <sub>LHV</sub> /y)	New vector	6 Mt <sub>CO2</sub> /y avoided in light mobility  32 Mt <sub>CO2</sub> /y avoided in HD mobility  6 Mt <sub>CO2</sub> /y avoided in aviation 
CH <sub>4</sub> <sup>(1)</sup> (domestic biomethane + domestic NG + import NG)	~ 100 TWh <sub>LHV</sub> /y (~ 10 mld Sm <sup>3</sup> /y)	Civil heating, industry, thermoelectric power generation, H <sub>2</sub> production via SMR+CCS	-90%	1 Mt <sub>CO2</sub> /y avoided in navigation  1 Mt <sub>CO2</sub> /y avoided in civil heating 
Liquid fuels <sup>(2)</sup>	~ 160 TWh <sub>LHV</sub> /y	Mobility and industrial feedstock	-80%	22 Mt <sub>CO2</sub> /y avoided in Industry 

<sup>(1)</sup> Distributed as NG or in blend with H<sub>2</sub> (with H<sub>2</sub> share optimized by the model).  
<sup>(2)</sup> Including grey and green options.

Figure 2 – Expected final consumptions (preliminary model result) for a long-term Net-Zero CO<sub>2</sub> target in the Italian energy system (left) and impact on CO<sub>2</sub> emission reduction (right).

Some interesting results are obtained through sensitivity analysis on some of the assumptions. For example, the role of import limits and of the characteristics of the imported vectors is remarkable. Results are shown in Table 2. Import prices have no impact on the energy balances, while the availability of zero-emission electricity from abroad significantly shifts towards the reliance on import. The availability of carbon-neutral liquid fuels is also critical to the net-zero CO<sub>2</sub> target, as a constraint on their import yields an increase in their domestic production, requiring more domestic H<sub>2</sub> production and renewable electricity generation for electrolysis supply. Another example of key sensitivity effects arise for the assumed capacity for CCS (not shown here for brevity), which yields a constant improvement of results when the annual assumed storage capacity is lifted e.g. from 20 MtCO<sub>2</sub>/y (lower bound assumed in existing long term strategy evaluations) to 40 MtCO<sub>2</sub>/y .

Table 2 – Effect of variation in imposed limits and characteristics of imported energy vectors.

	Reduction of import prices of EE and NG (-50%)	Reduction of CO <sub>2</sub> intensity of imported electricity (entirely renewable-based)	Reduction of liquid fuel import limit (-33%)
PV capacity	--	-20%	+20%
Wind capacity	--	-15%	+4%
Electrolysis capacity	--	-20%	+25%
Electricity import	--	+100%	+7%
Domestic e-fuel production	--	--	+1130%

## Acknowledgment

This work has been partly funded by the Hydrogen Joint Research Partnership (H<sub>2</sub> JRP) of Politecnico di Milano [3].

## References

- [1] M.G. Prina, G. Manzolini, D. Moser, B. Nastasi, W. Sparber, Classification and challenges of bottom-up energy system models - A review, *Renew. Sustain. Energy Rev.*, 129 (2020), 109917. DOI: 10.1016/j.rser.2020.109917
- [2] P. Colbertaldo, F. Parolin, S. Campanari, A comprehensive multi-node multi-vector multi-sector modelling framework to investigate integrated energy systems and assess decarbonisation needs, *Energy Convers. Manag.*, 291 (2023), 117168. DOI: 10.1016/j.enconman.2023.117168
- [3] Hydrogen Joint Research Partnership, <https://www.fondazionepolitecnico.it/progetti/hydrogen-jrp/>, 2023.



## On the use of ecosystemic knowledge approach for the definition of new guidelines for hydrogen as maritime fuel

Rossi M.<sup>c</sup>, Georgopoulou C.\*<sup>a</sup>, Di Maria C.\*<sup>b</sup>, Bionda A.<sup>c</sup>, Rautanen M.<sup>d</sup>, Ponzini R.<sup>e</sup>,  
Salvadore F.<sup>e</sup>, Di Ilio G.<sup>f</sup>, Cigolotti V.<sup>o</sup>, Minutillo M.<sup>p</sup>, Wannemacher Th.<sup>g</sup>, Baumann N.<sup>g</sup>,  
Mahos K.<sup>h</sup>, Tome M.<sup>i</sup>, Oikonomou F.<sup>j</sup>, Hamalainen A.<sup>k</sup>, Chillè F.<sup>l</sup>, Papagiannopoulos Y.<sup>m</sup>,  
Sakellaridis N.<sup>n</sup>, Boonen E. J.<sup>n</sup>, Penny Douska<sup>a</sup>, Koukoulopoulos L., Psaraftis G.<sup>a</sup>

\* corresponding author: Georgopoulou C., Di Maria C.

<sup>a</sup> DNV HELLAS SINGLE MEMBER SA

<sup>b</sup> UNI - ENTE ITALIANO DI NORMAZIONE

<sup>c</sup> POLITECNICO DI MILANO

<sup>d</sup> TEKNOLOGIAN TUTKIMUSKESKUS VTT OY

<sup>e</sup> CINECA CONSORZIO INTERUNIVERSITARIO

<sup>f</sup> UNIVERSITA DEGLI STUDI DI NAPOLI PARTHENOPE

<sup>g</sup> PROTON MOTOR FUEL CELL GMBH

<sup>h</sup> LEVANTE FERRIES NAFTIKI ETAIREIA

<sup>i</sup> GHENOVA INGENIERIA SL

<sup>j</sup> DANAOS SHIPPING COMPANY LIMITED

<sup>k</sup> OY WOIKOSKI AB

<sup>l</sup> IDF - INGEGNERIA DEL FUOCO SRL

<sup>m</sup> DIMOS ANDRAVIDAS-KYLLINIS

<sup>n</sup> SCHEEPSWERF DAMEN GORINCHEM BV

<sup>o</sup> ENEA

<sup>p</sup> UNIVERSITA' DEGLI STUDI DI SALERNO

*Keywords: new guidelines, ecosystemic knowledge, hydrogen as fuel, maritime sector*

### **Abstract**

This paper presents a methodological approach implemented in the e-SHyIPS project to combine industrial and academic expertise, to identify knowledge gaps for hydrogen as marine fuel and suggest studies for the derivation of relevant new guidelines. The paper presents how the knowledge ecosystem of e-SHyIPS developed a mapping of gaps in the IGF code with relation to hydrogen as fuel, and a resulting matrix of experiments to develop the necessary new knowledge. The results from the e-SHyIPS experiments will be gathered in a strategic roadmap to form advice on new guidelines for hydrogen as maritime fuel, supporting the update of the IGF Code, with a particular attention to safety.



### **Acknowledgment**

e-SHyIPS has received funding from the Fuel Cells and Hydrogen 2 Joint Undertaking (now Clean Hydrogen Partnership) under Grant Agreement No 101007226. This Joint Undertaking receives support from the European Union's Horizon 2020 Research and Innovation programme, Hydrogen Europe and Hydrogen Europe Research.



# The Viability of Climate Neutral Districts Integrating “Power on Demand” and “Power to Hydrogen” regimes: A Comparative Study of Simulation Tools

Kieran Quaine<sup>a</sup>, Elisabeth Sibille<sup>b,\*</sup>, Niusha Shakibi Nia<sup>a</sup>, Nikolaus Fleischhacker<sup>a</sup>, Guenter Simader<sup>b</sup>

\* corresponding author: Elisabeth Sibille

<sup>a</sup> FEN Research GmbH representing the Green Energy Center Europe

<sup>b</sup> Austrian Energy Agency

*Keywords: Climate Neutral District, Green Hydrogen, Grid Service, Simulation Tools, Power to Hydrogen*

## **Abstract**

### **Introduction:**

Due to the climate crisis, regional, national, and European resource-, energy- and climate-strategies foresee the reconstruction of the energy system from oil, coal and gas towards sun, wind and water by the means of electricity. Hence, the development and implementation of energy technologies supporting both the “power on demand” and complementary “power to hydrogen” processes are of essence [1]. This paper investigates the “power to hydrogen” process as a long-term storage technology, which benefits for existing energy infrastructure of districts have been pointed out in several demonstration projects [2][3]. Therefore, to cover a district’s energy demand and allow for grid alleviation, both short and long term energy storage - through the use of batteries and electrolytic green hydrogen - are introduced to the demand coverage system alongside intermittent Renewable Energy Sources (iRES) on the resource side [4].

**Objectives:** While the aim of this paper is to bring “power to hydrogen”, we must consider how electrolytic green hydrogen can support the energy system of districts – whether industrial, commercial, or residential [5]. Consequently, this paper will focus on comparing and contrasting different tools for modelling and simulating the energy balance of districts and their ability to include hydrogen-based solutions. This comparison will aim to give the reader a comprehensive overview of both the tools as well as their optimal use case, given a specified set of criteria.

**Material and methods:** To fulfil the objectives, two use cases are considered: MPREIS hydrogen production plant in Völs Austria and a localised energy community, namely the vicinity of the Green Energy Centre Europe [6][7]. Consequently, the selection of both modelling and simulation tools must be of high priority for this research paper. It is often the case that current tools are not sufficient in their entirety to tackle these energy problems [8][9]. As a result, we will offer a systematic, multi-criterial approach for selecting relevant tools. In addition, using the case studies specified we will endeavour to provide preliminary results on whether the decarbonisation of districts is viable in localised districts.

**Expected Results:** Based on the description of how to define a district with relation to energy communities [10], we will offer comprehensive multivariable selection criteria which identifies the key capabilities of the



modelling tools chosen as well as the potential for their further development and implementation. Using the selected tools we will endeavour to provide results that discuss their viability with the final aim to achieve climate neutral and more autonomy districts based on “power to hydrogen” and allow for grid alleviation (grid service). Lastly, we aim to propose recommendations about how to appropriately integrate hydrogen solutions into the modelling schemes, both in terms of the formulation and simulation of future projects.

**Conclusions:** Electrolytic green hydrogen is identified as a key technology for the reconstruction of the energy system and anchored in strategies as such. Its usefulness for the reconstruction of energy systems of districts must be determined.

### Acknowledgment

This project receives support by the Austrian IEA research cooperation on behalf of the Federal Ministry for Climate Action, Environment, Energy, Mobility, Innovation and Technology. In addition we would also like to offer thanks to the Green Energy Center Europe Codex Partnership and in particular MPREIS for providing support and resources for this research.

 Bundesministerium  
Klimaschutz, Umwelt,  
Energie, Mobilität,  
Innovation und Technologie

 **IEA Forschungskooperation**  
im Rahmen von open4innovation

 **FFG**  
Forschung wirkt.

### References

- [1] Oncel SS. Green energy engineering: Opening a green way for the future. *J Clean Prod* 2017;142:3095–100. <https://doi.org/10.1016/J.JCLEPRO.2016.10.158>.
- [2] Simader G, Vidovic P. IEA Fortschrittliche Brennstoffzellen (AFC) Annex 33: Brennstoffzellen für stationäre Anwendungen. 2019.
- [3] Leonhartsberger K, Bhat K, Ettwein F, Rao B-V, Stefan M, Berne P, et al. High-Level description of use-Cases and business models 2021. <https://project-clue.eu/deliverables/> (accessed April 27, 2023).
- [4] Jain IP. Hydrogen the fuel for 21st century. *Int J Hydrogen Energy* 2009;34:7368–78. <https://doi.org/10.1016/J.IJHYDENE.2009.05.093>.
- [5] Ishaq H, Dincer I, Crawford C. A review on hydrogen production and utilization: Challenges and opportunities. *Int J Hydrogen Energy* 2022;47:26238–64. <https://doi.org/10.1016/J.IJHYDENE.2021.11.149>.
- [6] Fleischhacker N, Shakibi Nia N, Coll M, Perwoeg E, Schreiner H, Burger A, et al. Establishment of Austria’s First Regional Green Hydrogen Economy: WIVA P&G HyWest. *Energies Journal* 2023. <https://doi.org/10.3390/en16093619>.
- [7] Successful EU project: Plant is used for research and produces green hydrogen. *Mein Bezirk* 2023. [https://www.meinbezirk.at/innsbruck/c-wirtschaft/anlage-dient-der-forschung-und-produziert-gruenen-wasserstoff\\_a5912296](https://www.meinbezirk.at/innsbruck/c-wirtschaft/anlage-dient-der-forschung-und-produziert-gruenen-wasserstoff_a5912296) (accessed April 21, 2023).
- [8] Allegrini J, Orehoung K, Mavromatidis G, Ruesch F, Dorer V, Evins R. A review of modelling approaches and tools for the simulation of district-scale energy systems. *Renewable and Sustainable Energy Reviews* 2015;52:1391–404. <https://doi.org/10.1016/J.RSER.2015.07.123>.
- [9] Murakami M, Nomura S, Tsubokura M, - al, Stichel M, Marx S, et al. Simulation tool for planning smart urban districts in a sustainable energy supply – integrating several sectors in high resolution. *J Phys Conf Ser* 2019;1343:012110. <https://doi.org/10.1088/1742-6596/1343/1/012110>.
- [10] Sibille E, Chriti M, Simader G, Vidovic P. Einsatz von dezentralen Brennstoffzellen in klimaneutralen Quartieren. Eine „State of the Art“ Studie mit der Analyse von bestehenden Quartieren im Bezug auf Klimaneutralität sowie die eingesetzten Komponenten, Preprint.



## A multi-criteria design tool for performance comparison of innovative energy systems for maritime sector

G.N. Montagna<sup>1,2</sup>, S. Piccardo<sup>1</sup>, T. Lamberti<sup>2</sup>, L. Magistri<sup>1</sup>, M. Rivarolo<sup>1</sup>

<sup>1</sup> Thermochemical Power Group, University of Genoa, via Montallegro 1, 16145 Genoa, Italy

<sup>2</sup> h2boat, Via Antonio Cecchi 4/4, 16129 Genoa, Italy

**Abstract.** This paper aims to present an innovative multi-criteria tool for the comparison of alternative and conventional on board energy systems for maritime vessels, both for hotel and propulsion loads, depending on the mission taken into account. The tool, developed in Matlab environment and named HELM (Helper for Energy Layouts in Maritime applications), includes an extended and up-to-date market database of many technologies in terms of power units and suitable fuel storage systems. A wide range of maps has been created, correlating costs, volumes, weights, emissions and fuel environmental hazards with the installed power and the operational hours, given by the user as input. In this work, the competitiveness of hydrogen technologies (PEM fuel cells and different H<sub>2</sub> storage systems) is demonstrated for two different maritime vessels typologies. It is worth noting that the multi-criteria analysis carried out has a general approach, allowing it to give preliminary information on the energy system, in order to respect new requirements (e.g. more and more stringent normative in terms of pollutant emissions in ports and restricted areas). HELM can be used for many design approaches, either for a new ship project or for already existing ships retrofit; furthermore, the database can be easily extended to other generation and storage technologies, as well as to different kind of vessels.

**Adopted Methods And Methodology.** In maritime applications, the evaluation of the most promising technologies must consider different aspects simultaneously (i.e. costs, emissions, volumes and weights); in order to reach reliable results, the inputs must describe the vessel and the navigation properly. HELM software adopts this approach, based on the multi criteria numerical method.

The needed inputs are: vessel type and dimensions, energy demand (required power and operational hours), navigation frequency and type, and permanency in emission-controlled areas (ECA). These inputs generate a numerical description of the case study. Moreover, the energy solutions are accurately described with other related data: power unit efficiency, battery support in satisfying energy demand, as well as substitution ratio for dual fuel ICE and CH<sub>2</sub> storage pressure. Then, HELM employs a comparison based on the constantly updated market data. The characteristics are identified as key parameters and they are collected in a set of maps in HELM. Volumes, weights and costs are directly linked to the power unit, while the fuels drive emissions and environmental hazard values. Based on multi criteria method, HELM carries out the comparison process with a score evaluation of all technologies as a sum of key parameters.

Following the commonly used design process, to investigate on the energy field in maritime sector, the useful measures are: weight, volume and cost. To consider the environmental impact, two parameters are evaluated: emissions (mainly CO<sub>2</sub> and NO<sub>x</sub>) and the environmental hazard, in case of fuel outboard spillage.

Besides its ease of use, one of HELM greatest advantages is its large and up-to-date database, able to provide reliable information for all the solutions, including the most recent technologies in the maritime sector. Its modular structure allows including a new technology by inserting its performance maps in the program code.

**Observed Results.** Two different case studies are investigated in this paper, both including hydrogen technologies: the first one is related to the propulsion system for a fast motor boat, while the second considers the energy demand for hotel load for a yacht.

The first analysed case is a fast motor boat, the Hynova 40, powered by an hybrid system with battery and PEMFC with compressed hydrogen at 350bar. HELM is set up with a power at 200kW with autonomy of 6 hours, and for FC the 15% of energy is provided by battery pack.

The Figure shows that ICE MDO is still one of the best solution for the contained volume, weight and costs due to the high maturity. Among the possible innovative solutions, PEMFC is a promising technology for small motor boat, in a scenario with high environmental interest; liquid and compressed storage systems are suitable



solutions when the volume and weight must be restrained. However, considering the operative condition for this case study as a leisure vessel, refrigerated storage systems (i.e. LH2 at -253 °C) are not considered adequate for practical application, as they require complex systems and continuous monitoring by specific personnel.

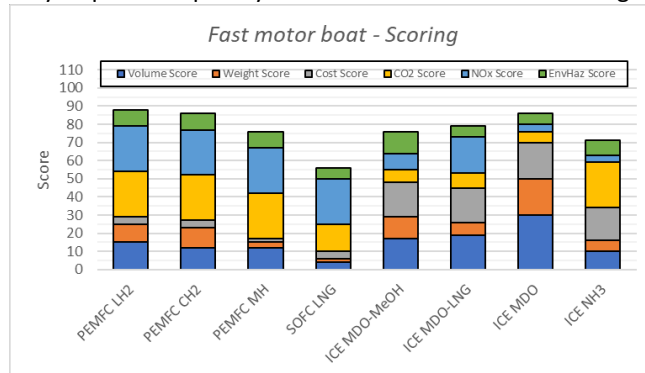

In the second case study, HELM is used to analyse the hotel load of a super yacht line from Baglietto shipyard built with a large battery pack. To increase the autonomy, a hydrogen system is developed and ready for on board installation. The considered power unit is a 200 kW PEMFC with 70 kg H2 stored in metal hydrides, and 198 kWh battery pack, that allows a zero emissions and free noise experience for 6 hours at full power. It is also included an electrolyser system to generate H2 autonomously. In an hotel analysis, all systems have a 15% of energy provided by the battery.

The Figure shows that PEMFC is a very promising technology for hotel load energy generation in a scenario with high environmental interest, and all the storage solutions have the scores higher than the one for traditional solution (ICE MDO). However, considering the operative condition for this case study as a leisure vessel, refrigerated storage systems as LNG and LH2 are not considered adequate, since they foresee complex systems, and they need continuous monitoring by specific personnel. The shipyard have chosen the metal hydride as storage system, because the refuelling can be done directly from the electrolyser and it can be installed on the hull bottom.

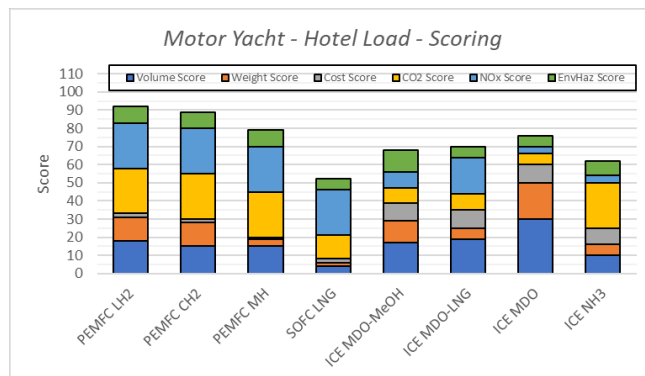

**Conclusions.** In both cases, the adopted solutions are among the best solutions defined by HELM. In general, the obtained results show that hydrogen technologies (PEMFC) can represent a worthy solution for small scale vessels, in particular in case of low-to-medium required autonomy, also allowing for reducing emissions to zero. Regarding hydrogen storage, three solutions are compared (CH2, LH2 and metal hydrides): despite LH2 is promising in terms of volume, the management on board can present drawbacks; metal hydrides are a promising solution, in particular when weights' importance is low.



## Hydrogen as an export commodity – costs and energy retention of hydrogen carriers within the export value chain

James T. Hinkley<sup>\*a</sup>, Alexander R. Heenan<sup>a</sup>, Adrian C.S. Low<sup>b</sup>, Matthew Watson<sup>b c</sup>

\* corresponding author: [jim.hinkley@vuw.ac.nz](mailto:jim.hinkley@vuw.ac.nz)

<sup>a</sup> Sustainable Energy Systems, School of Engineering and Computer Science, Victoria University of Wellington, P.O. Box 600, Wellington 6140, New Zealand

<sup>b</sup> Department of Chemical and Process Engineering, University of Canterbury, Private Bag 4800, Christchurch, New Zealand

<sup>c</sup> Biomolecular Interaction Centre, University of Canterbury, Private Bag 4800, Christchurch, New Zealand

*Keywords: ammonia, capital cost, energy efficiency, hydrogen carriers, liquid hydrogen*

### **Abstract**

The capital costs and the energy efficiency of the three most prominent carriers are explored to examine the optimal solution for the large-scale export of hydrogen from New Zealand to Japan. Process models were developed in ASPEN HYSYS to enable the capital cost of electrolysis and carrier formation plants to be estimated for a facility with a total power consumption of 600 MW. Mass and energy balances were used to evaluate the energy efficiency of hydrogen production and carrier formation. Estimates for the energy intensity of shipping from New Zealand to Japan were then used to determine the capital cost and energy retention of renewable energy to delivered hydrogen in the destination country.

### **Introduction:**

New Zealand is exploring the possibility of exporting hydrogen produced from its abundant renewable energy resources. A key question that arises is what is the “best” way to transport hydrogen internationally at large scale. There is no simple answer to this question, as the “best” option will depend on the customer and their intended usage, the efficiency and safety of the supply chain and the availability of critical infrastructure. In this paper, we discuss and extend the results of our recent study [1] that explored the capital cost and energy efficiency considerations of the three most prominent potential hydrogen carriers: liquid hydrogen, ammonia and the toluene/methylcyclohexane system (MCH).

### **Objectives:**

Our goals were to develop an internally consistent evaluation of the three carriers by developing our own process models and using the same cost estimation methodology for the



three options. In previous works, usually only one or two of the options are carefully modelled and then compared with literature values.

### **Material and methods:**

Models were developed in Aspen HYSYS (Version V12.1) for the process plants to produce all three carriers, for consistency of energy demand and capital cost estimates. In each case a flowsheet was developed to establish a realistic process schematic at the relevant scale. The plant was then scaled to give a combined power draw of 600MW for the electrolysis and carrier formation plants. Shipping energy requirements were estimated from the literature and the overall supply chain energy retention was calculated using the heat and mass balance data combined with estimates of the efficiency of international shipping.

### **Results:**

Despite significant differences in the amount of hydrogen produced, the overall capital envelopes were remarkably consistent (~\$2 billion). The contributions of the cost of electricity (at a net cost of \$65/MWh) and levelized cost of capital indicated that liquid hydrogen could potentially be the most cost-effective solution, although it requires the construction of new shipping vessels. Ammonia for direct use is comparable, and has no infrastructure barriers, but ammonia decomposition and MCH dehydrogenation are energy intensive and result in higher costs. The energy requirements of shipping varies between carriers due to the hydrogen density of the carrier which ranges from 6% to MCH to 100% for liquid hydrogen, although carrier density and the proportion of carrier mass to total vessel tonnage is also highly significant.

### **Conclusions:**

Our results show that liquid hydrogen has significant benefits over ammonia, but the lack of an existing shipping fleet is a major barrier to this option. Ammonia is promising as a short to medium term option as green ammonia will be required in the future and international shipping is readily achievable with conventional tankers of the kind used for LPG. Methyl cyclohexane also has some attractive features in terms of existing infrastructure and stability but the energy requirement for dehydrogenation is a major barrier.

### **References**

[1] Hinkley, J. T., Heenan, A. R., Low, A. C. S., & Watson, M. (2022). Hydrogen as an export commodity – Capital expenditure and energy evaluation of hydrogen carriers. *International Journal of Hydrogen Energy*, 47(85), 35959-35975. doi:10.1016/j.ijhydene.2022.08.192



## Unsteady simulation of a gas pipeline considering several hydrogen blends

Guzzo Gabriele<sup>1\*</sup>, Carcasci Carlo<sup>1</sup>

\* corresponding author: gabriele.guzzo@unifi.it

<sup>1</sup> University of Florence via Santa Marta, 3 50139 Florence (IT) Phone: +39 055 275 8783

*Keywords: Hydrogen; Linepack; Natural Gas Pipeline; Unsteady Simulation*

### Abstract

**Introduction:** Natural Gas (NG) is considered a transition fuel due to its lower carbon intensity compared to other fossil fuels such as coal and oil. Despite some advantages that have given it the appellation of transition fuel, it is still a fossil fuel and not a long-term sustainable solution to address climate change. Many countries have a well-developed NG supply chain consisting of extensive infrastructure such as transmission pipelines and distribution networks [1]. The difficulty of electrifying hard-to-abate sectors and the expertise developed around the management of energy transport using a molecular carrier have led many states to invest in the development of a H<sub>2</sub> economy [2]. The primary motivation behind the development of a hydrogen (H<sub>2</sub>) economy is to reduce greenhouse gas emissions by mitigating natural gas usage. The transition from NG to H<sub>2</sub> will be developed both through the transport of mixtures of the two gases with increasing H<sub>2</sub> concentration and through the development of pipelines dedicated to the transport of pure H<sub>2</sub> [3].

**Objectives:** This work provides a fluid-dynamic and energy interpretation of an unsteady state simulation of a gas pipeline linking the gas properties to the fluid-dynamic effects. The goal is to provide a better understanding of transient phenomena linking local fluid-dynamic variables and chemical properties of the mixture to more comprehensive parameters like linepack, power consumption at the compressor and the transport efficiency.

**Material and methods:** The test case consists of a pipeline with a compressor at the beginning. The length of the pipeline is 500 km, the diameter is 400 mm. Given a specific NG composition, several blends of this gas with H<sub>2</sub> are considered as fluid to cover the same energy demand. The molar fraction of H<sub>2</sub> used in the mixture are 0%, 10%, 20%, 50%, 75%, 100%. The pressure at the inlet node of the compressor station is set to 4.0 MPa and the compressor is supposed to work with a constant pressure ratio  $\beta$  equal to 2.2333. These two conditions imply that the outlet pressure at the compressor is set to 8.9332 MPa. The energy demand boundary condition is built through a sinusoidal translated function that ranges from 100 TJ/d to 20 TJ/d. The fluid-dynamic model adopted for the pipe is a 1-dimensional unsteady state isothermal model. The numerical scheme used to discretize the partial derivative equations, namely the continuity and the momentum equation is the first-order backward

discretization scheme in time and the first-order forward difference scheme in space. The compressor is modelled through a 0-dimensional model with lumped parameters with the aim of giving indicative results related to the power consumption to boost, with a constant pressure ratio, a flow-rate variable with the composition of the fluid. The unsteady state model is initialized with the fluid-dynamic solution obtained through a steady-state model.

**Results:** Increasing the H<sub>2</sub> molar fraction in the gas mixture affects the properties of the gas such as the higher heating value, the specific gravity, the compressibility factor, and the speed of sound. First, the results highlight a delay between the peak of the demand and the supply that is variable with the concentration. The higher the H<sub>2</sub> molar fraction is, the more compressible the gas is which means that the gas expands or contracts faster and with larger swings in response to changes in demand. Because of that in the test case analysed the delay in the peaks of demands and supply ranges from 3 hours in the case of pure H<sub>2</sub> to 5 hours in the case of NG. The highest pressure losses are reached in the case of a gas mixture with 75% H<sub>2</sub> molar fraction as expected also looking at the steady state results but the pressure losses swing increase always increasing the H<sub>2</sub> content. Also, the power required to compress the gas with a constant pressure ratio increases with the H<sub>2</sub> content. The unsteady simulation, capturing the larger supply swings shows the compressor power swings highlighting that the power ratio between the H<sub>2</sub> and the NG case is more than 4 and higher compared to the steady state result. Consequently, in the test case analysed the average transport efficiency decreases from 98.7% of NG to 95.3% of pure H<sub>2</sub>. Finally, the authors analysed the linepack which is an indicator of the flexibility of a pipeline representing the amount of energy stored in it. The results show that the higher the H<sub>2</sub> content is the lower the linepack is, decreasing more than 70% when comparing H<sub>2</sub> to NG.

**Conclusions:** In conclusion, the results show the importance of unsteady state simulations of transport gas pipelines that capture phenomena that steady state simulations do not. The testcase even if specific, is modelled and interpreted with a generalized approach and delivers considerations that pave the way to future works that can answer broader questions on flexibility, efficiency and reliability of these systems.

### References

- [1] G. Guzzo, L. Cheli, and C. Carcasci, 'Hydrogen blending in the Italian scenario: Effects on a real distribution network considering natural gas origin', *Journal of Cleaner Production*, vol. 379, p. 134682, Dec. 2022, doi: 10.1016/j.jclepro.2022.134682.
- [2] B. Miao, L. Giordano, and S. H. Chan, 'Long-distance renewable hydrogen transmission via cables and pipelines', *International Journal of Hydrogen Energy*, vol. 46, no. 36, pp. 18699–18718, May 2021, doi: 10.1016/j.ijhydene.2021.03.067.
- [3] M. Pellegrini, A. Guzzini, and C. Sacconi, 'A Preliminary Assessment of the Potential of Low Percentage Green Hydrogen Blending in the Italian Natural Gas Network', *Energies*, vol. 13, no. 21, p. 5570, Oct. 2020, doi: 10.3390/en13215570.



## Assessing the relative importance of hydrogen for a decarbonized Italian energy system through a model based scenario analysis

Francesco Gracceva\*<sup>a</sup>, Alessandro Agostini<sup>b</sup>, Claudio Carbone<sup>b</sup>

corresponding author: francesco.gracceva@enea.it

<sup>a</sup> ENEA - STAV

<sup>b</sup> ENEA – TERIN – PSU - ABI

*Keywords: hydrogen, Italian energy system, scenario analysis, TIMES model*

### Abstract

**Introduction:** Hydrogen has seen at least three waves of interest in recent decades, in the 1970s, 1990s and early 2020s, none of which translated into a substantial commercial development [1]. The current wave of interest, started at the end of the last decade, reflects the improvement in the outlook for hydrogen as a low-carbon energy carrier, supported by the declining costs of renewable electricity. The current wave is backed by an impressive increase in the optimism about the future role of hydrogen in the energy system, as depicted by the energy scenarios produced by main international institutions: in 2019 IEA WEO still didn't consider hydrogen as a separate item, therefore it did not provide any figure about its production/demand; a year later, WEO 2020 - scenario SDS - projected a rapid expansion of hydrogen production (from electrolysis and fossil fuels with CCUS), reaching 18 Mt in 2030 and 75 Mt by 2040 [2]. The projection became even more optimistic in the latest WEO, whose Net Zero Scenario projects hydrogen production up to 450 Mt in 2050 [3]. Indeed, now low-carbon hydrogen is widely seen as the main option that can help deliver deep emissions reductions across a wide range of hard-to-abate sector, i.e. aviation, shipping, iron and steel production, chemicals manufacturing, high-temperature industrial heat, long-distance and long-haul road transport. Moreover, the expected strong increase of energy production from non-programmable renewable energy sources implies that energy flexibility becomes crucial for maintaining energy security and ensure stability of supply, and hydrogen can provide a long-term storage option and dispatchable low-carbon power generation. This is a key difference between the current wave of interest in hydrogen and the previous ones, which focused mainly on the use of fuel cells in the transport sector. However, there are still several factors slowing the deployment of hydrogen. First, low-carbon hydrogen production cost is still high. Second, even a substantial reduction of hydrogen production cost would not be sufficient to make it a key carbon neutral energy carrier, which requires that hydrogen technologies along its whole value chain (production, transportation, storage, end-uses) reach TRL 9 and become economically competitive with respect to other low-carbon energy technologies, such as renewables and batteries. In short, the issue at stake is not limited to technological maturity, but it depends on the SRL, the system readiness level.



**Objectives:** The transformation required by a Net Zero energy system is so profound that its pathway and outcomes are highly uncertain. Model based analyses, which underpins much of academic research and energy policy-making, can help analysts to "explore" the uncertainty and get a better understanding of the key factors driving the future evolution of "complex" systems like hydrogen ("modeling for insights, not numbers"). By exploring a set of 18 alternative pathways to achieve the goal of a Net Zero Italian energy system by 2050, this paper aims to assess whether a Net-Zero transition is technically feasible, how challenging it is, what role can hydrogen play in it.

**Material and methods:** This paper first collect a set of long-term hydrogen scenarios produced in the international literature, then compare them with the outcome of a scenario analysis developed for Italy through a model based on the TIMES model generator. TIMES uses linear-programming to build bottom-up (technology explicit) models of an energy system and depict its least-cost evolution under given sets of assumptions and constraints. A set of 18 Net Zero Italy scenarios has been built by combining different assumptions on the future energy service demand to be satisfied and the actual deployment of a set of low-carbon energy technologies. i.e. low-carbon dispatchable electricity, biofuels, hydrogen and synfuels.

**Results:** The set of global scenarios, all consistent with either RCP 1.9 or RCP 2.6, included in the Shared Socioeconomic Pathways database, makes it clear the huge uncertainty surrounding the future of hydrogen: hydrogen production in 2050 ranges between 20 and 450 Mt, its share of final energy between 1% and 17% [4]. The scenario analysis carried out for Italy with the TIMES-Italy model shows, on one hand, that a scenario combining the 2030 Fit for 55 EU target and a Net-Zero target by 2050 is technically feasible, on the other hand that about 40% of the Net Zero system is made up of technologies which are currently still in the development phase and/ or not yet competitive, and hydrogen's role can be important.

**Conclusions:** The significant role played by low-carbon technologies that are not yet competitive in the Net Zero system has a notable implication, as it demonstrates how narrow the path that leads to zero net emissions actually is. Indeed, a necessary condition for the technical feasibility of a Net Zero 2050 scenario is that in the next three decades all the main innovative low-carbon technologies have a "optimistic" evolution. While in the event of a pessimistic evolution of even just one of the main low-carbon technology clusters, hydrogen included, the 2050 target becomes much more difficult to be achieved.

**Acknowledgment:** this work is funded by the PNRR – POR project on green hydrogen.

## References

- [1] IEA, The Future of Hydrogen, Paris.
- [2] IEA, World Energy Outlook 2020, Paris.
- [3] IEA, World Energy Outlook 2022, Paris.
- [4] Rihai et al, The SSP Pathways..., Global Environmental Change, Vol. 42, 153-168, 2017.
- [5] Rogelj J. et al., Scenarios towards limiting..., Nature Climate Change 8, 325-332, 2018.



## Exploring the Viability and Applications of Green Hydrogen: A Comprehensive Assessment of Project Success

Ilaria Goglia<sup>a,\*</sup>, Alessia Acampora<sup>a</sup>, Maria Claudia Lucchetti<sup>a</sup>, Roberto Merli<sup>a</sup>

\*corresponding author: [ilaria.goglia@uniroma.it](mailto:ilaria.goglia@uniroma.it) (I. Goglia)

<sup>a</sup> *Department of Business Studies –Roma Tre University, Via Silvio D’Amico 77, Rome, 00145, Italy.*

**Keywords:** *Decarbonization, European projects, Green Hydrogen, Sustainability.*

**Abstract** Hydrogen is an important energy vector able to support the decarbonization in energy intense and hard-to-abate sectors, while supporting the ecological transition among Europe. This work will cover the analysis of European projects in different sector highlighting the technical and economic features for assessing the current stage of development and future development opportunities.

**Introduction:** At the current stage, hydrogen production is largely unsustainable, with the predominant method being fossil combustion, contributing to approximately 3% of total CO<sub>2</sub> emissions [1]. However, the key lies in harnessing its sustainable and clean potential by utilizing electrolysis powered by renewable energy sources, which ensures carbon emission-free production. Unfortunately, this approach currently accounts for only 4% of total production, while the remaining 96% is derived from fossil fuels [2]. Governments across the European Union are adopting national policies and drafting roadmaps to face the environmental problem and accelerate the energetical transition by including clean hydrogen in the renewable energy mix [3].

**Objectives:** A preliminary analysis of few relevant projects will provide a real close-up of practical applications. These applications can be grouped into distinct areas, ranging from an overview of the hydrogen supply chain to its implementation in various industrial sectors, its utilization as a fuel in the mobility sector, and its specific application in the maritime industry. All these projects are addressing one main issue: overcome the convenience related to the use of fossil sources for hydrogen’s production [2]. The aim of this study is to assess the technical and economic feasibility of deploying green hydrogen technologies.

**Material and methods:** To provide a comprehensive analysis, a preliminary assessment was conducted based on extensive online research. The primary sources consulted for academic literature and project information were the European Commission website, CORDIS, Horizon 2020, and the FCH Europe websites. These sources were selected due to their comprehensive coverage of technical and economic aspects, including project objectives, deadlines, and other relevant information. To ensure a well-rounded understanding of the topic, the analysis encompassed various sectors.

**Results:** The methodological approach described enabled us to gain insights from multiple perspectives and ascertain the most suitable sectors for achieving a sustainable use of hydrogen. To facilitate this analysis, a table was created to highlight key information such as the country, energy sources, efficiency, costs, investments, as well as barriers and advantages associated with each sector.





By leveraging this research methodology, we aimed to gather a diverse range of information to support our assessment of the feasibility and potential benefits of green hydrogen projects. The data collected from these reliable sources enables us to provide an objective evaluation and draw robust conclusions regarding the technical and economic aspects of deploying green hydrogen technologies.

**Conclusions:** The projects analysed in this study share a common objective: to establish a scalable hydrogen business model that can serve as a blueprint for achieving environmental goals and facilitating a rapid energy transition not only within their respective regions but also for the rest of Europe. Hydrogen has demonstrated its versatility as a vector for energy, as it has the potential to replace fossil fuels in various sectors while supporting the integration of renewable energy sources. As these projects expand to larger scales, the cost of hydrogen production is expected to decrease, making it more competitive with traditional energy sources. This increased competitiveness has far-reaching implications, promoting economic growth and employment opportunities through the creation of new jobs in the emerging hydrogen economy. By capitalizing on the versatility and scalability of hydrogen, these initiatives are laying the groundwork for a sustainable energy future. They serve as pioneering examples of how hydrogen can play a pivotal role in meeting environmental targets, accelerating the energy transition, and fostering economic prosperity.

#### **Acknowledgment**

*This work was financially supported by Rome Technopole.*

#### **References**

- [1] N. Armaroli, Interviewee, *Idrogeno per la transizione energetica? Non siamo ancora pronti (purtroppo)*. [Intervista]. 2022 Settembre 2022.
- [2] M. S. M. T. S. C. T. Capurso, «Perspective of the role of hydrogen in the 21st century energy transition,» *Energy Conversion and Management*,, vol. 251, 2022.
- [3] European Council, «Infographic - National energy and climate plans,» 2019. [Online]. Available: <https://www.consilium.europa.eu/en/infographics/national-energy-and-climate-plans/>. [Consultato il giorno September 2022].
- [4] European Commission, «Green Hysland,» 2021. [Online]. Available: <https://cordis.europa.eu/project/id/101007201/reporting>. [Consultato il giorno September 2022].
- [5] European Commission, «Using hydrogen to reduce industry's carbon footprint,» 10 May 2021. [Online]. Available: <https://ec.europa.eu/research-and-innovation/en/projects/success-stories/all/using-hydrogen-reduce-industrys-carbon-footprint>. [Consultato il giorno Maggio 2023].



## Environmental And Economic Impact Assessment Of Using Fully Recycled Platinum As Catalyst In Pem Fuel Cells – A Review Study

Huseyin Yigit Cem (Altintas)\*<sup>a</sup>

\* corresponding author

<sup>a</sup> Energy Science and Technology/Energy Institute, Istanbul Technical University, Türkiye

**Introduction:** PGMs are commonly used in Polymer Exchange Membrane (PEM) Fuel Cells due to their catalytic behaviors despite listing as a moderate critical raw material in EU 2023 CRM Report. It causes a major dilemma in energy transitions. EU desires to be climate zero by 2050. To achieve this target hydrogen technology use must be boosted. While upwards movement in hydrogen fuel cell using causes increasing demand in PGMs though. It is expected till 2050, Pt consumption for hydrogen technologies will surpass 8 ktons in base case scenario [1]. Considering current conjecture of PGMs supply and Green House Gas emission of PGMs a novel holistic approach to supply chain must be developed.

Automotive industry opens a new window into supply chain with offering cheap and more sustainable PGMs from catalytic converters. Catalytic converters have been using over 50 years for reducing air pollution causes by gasoline cars. By way of EU's climate net zero target most of the gasoline cars will be scrapped ongoing years that causes a huge volume of scrap catalytic converters, waiting to be recycling. This can create huge PGM flow from recycling While PGM amount in automotive catalysts can range from 1 – 15 g [2], PEM Fuel cell that can power hydrogen car contain 30g - 60g. Average grade PGM ore concentration is range from 5 to 15 ppm [3].

Considering that nearly half of the cost of PEM is accounted from PGMs and thinking their environmental impact, recycled PGM using in PEM fuel cell makes them more feasible and environmentally friendly.

### **EXPERIMENTAL/THEORETICAL STUDY:**

This review study investigates environmental and economic aspects of recovered PGM (Platinum) usage in PEM Fuel cell catalyst. The study reviews current Pt reserves, market outlook, recycling industry, environmental and economic impact assessment respectively.

### **RESULTS AND DISCUSSION:**

Although Fuel cells are main contributor of green energy, their manufacturing is a highly carbon intensive process. The production of an FCEV releases approx.. 16 tons of  $CO_2$  eq., 22% of which comes straight from the PEMFC stack.[4] Yet, catalysts release significant amounts of  $CO_2$ , using secondary platinum can lower them by up to 50% depending on the content [5].



Also, the study shows that primary PGM production account 33.3 kg CO<sub>2</sub> -eq/g while secondary production from auto catalyst only causes 0.695 kg CO<sub>2</sub> -eq/g [6]. The big difference is result of low concentration of PGM ore and mining energy consumption. Consequently, using secondary PGM as a fuel cell catalyst can reduce 97.9% of GWP which is accounted from raw material.

Manufacturing fuel cells is a high costly process. In 2020, A manufacturing cost of 100 kW automotive fuel cell stack was around \$4000, merely 41% percent directly related to catalyst production [7] which was around \$1600. Considering average PGM use (30 g) in 100 kW PEMFC, raw platinum supply account \$1000. It corresponds to 62.5% of catalyst manufacturing and 25% percent of total cost.

Secondary platinum offers a good alternative for primary supply in terms of both price and supply chain issues. Average production cost of secondary platinum is \$13,500 (with recovery rate of 75%) [8]. Considering current platinum price per kg \$31,250, using secondary platinum maintain 56.8% percent cost reduction in catalysts production and 14.2% totally. That correspond to \$568 saving of raw material cost in PEMFC catalyst price. In forthcoming years, implementation of high efficiency recycling technologies and yielding number of scrap auto catalyst can cause < \$5000 production price per kg for secondary platinum.

## CONCLUSION:

The present study shows promising results, with state – of – art technologies using in secondary PGM from auto catalyst may save up to 25% from total cost and approx. 30% from total carbon emission of fuel cell stack manufacture. These rates will be much higher than forthcoming years by developing more efficient recycling techniques, easy access to scraps, and high technologies in catalyst production.

## REFERENCES

1. WB-Hydrogen-Report-2022.pdf (hydrogencouncil.com)
2. DFornalczyk, Agnieszka & Saternus, Mariola. (2009). Removal of platinum group metals from the used auto catalytic converter. *Metalurgija*. 48.
3. U.S. Geological Survey's 2014 Platinum Group Elements Fact Sheet
4. Evangelisti, S., Tagliaferri, C., Brett, D. J. L., & Lettieri, P. (2017). Life cycle assessment of a polymer electrolyte membrane fuel cell system for passenger vehicles. *Journal of Cleaner Production*, 142, 4339–4355. doi:10.1016/j.jclepro.2016.11.159
5. Garbe Sentasteban J. (2020) Life Cycle Assessment of PEM fuel cell vehicles Technische Universität Braunschweig, Braunschweig, Germany
6. 2022-06-21-New Environmental Profile of PGMs\_IPA.pdf (ipa-news.de)
7. Pollet, B. G., Kocha, S. S., & Staffell, I. (2019). Current status of automotive fuel cells for sustainable transport. *Current Opinion in Electrochemistry*, 16, 90–95. doi:10.1016/j.coelec.2019.04.021
8. Economic assessment of the PLATIRUS technologies - PLATIRUS



## The Carbon Footprint of Hydrogen Produced with State-of-the-Art Renewable Electricity in Italy Using Life Cycle Assessment Methodology

D. Bonalumi<sup>\*a</sup>, M. Kolahchian Tabrizi<sup>a</sup>, J. Famiglietti<sup>a</sup>, S. Campanari<sup>a</sup>

<sup>\*</sup> corresponding author: [davide.bonalumi@polimi.it](mailto:davide.bonalumi@polimi.it)

<sup>a</sup> Department of Energy, Politecnico di Milano – Via Lambruschini 4A, 20156, Milan, Italy

**Keywords:** Carbon footprint, Green Hydrogen, Life Cycle Assessment, Renewable Energy

### Abstract

The production of hydrogen will play a key role in reaching net-zero emissions. This paper reviews the publications on the life-cycle assessment of photovoltaic (PV)-based and wind-based hydrogen production focused on the carbon footprint. Moreover, it updates the global warming potential (GWP) values of the H<sub>2</sub> production process considering the state-of-the-art of PV panels and wind turbines for installation in Italy. The H<sub>2</sub> exploitation in transport internal combustion engines is evaluated.

**Introduction:** The production of hydrogen as both chemical feed and energy carriers using low-carbon technologies is one of the solutions to reach net-zero emissions. For future needs, a significant amount of hydrogen should be produced to satisfy the growing market demand.

**Objectives:** This work assesses the carbon footprint of the H<sub>2</sub> produced through an electrolysis system feed with the likely future installed renewable plants in the Italian context: photovoltaic and wind.

**Material and methods:** The main step to carry out the research is: (i) a description of the different hydrogen production technologies via water electrolysis, (ii) the electricity source (i.e., photovoltaic and wind), and (iii) the process-based life cycle assessment method. The articles selected for the literature review are identified using the Scopus database by searching the words “hydrogen” and “life cycle”. The search result is refined by the words “photovoltaic (PV)”, “wind,” and “electrolysis”.

The process-based Life Cycle Assessment (LCA) method is considered one of the most analytical methods to evaluate the environmental profile of products (goods and services), such as hydrogen. The LCA evaluation is implemented using attributional modeling, with the scope to evaluate the Global Warming Potential (GWP) impact of gaseous H<sub>2</sub> produced via alkaline electrolysis. Still, unlike many studies, the outcomes were achieved by implementing a market supply analysis of the production of PV modules and wind turbines and not directly using the inventory data published in the commercial databases. The outcomes have been obtained exploiting SimaPro 9.4 software, the ecoinvent 3.5 library cut-off method as the Life Cycle Inventory database. The functional unit is defined as the hydrogen weight (1 kg) following the proposed harmonized life cycle global warming impact of renewable hydrogen. The boundary system is cradle-to-gate (CTG), in which only the life cycle of hydrogen is considered up to its production. The exploitation of hydrogen has been investigated in the transport sector, estimating the CO<sub>2</sub>eq emitted for each kilometer driven.

The study conducted for the Italian case study has considered: (i) the baseline scenario, (ii) the photovoltaic and wind life cycle inventory supply chain updated, and (iii) the outcomes achieved.

The baseline scenario represents the production of H<sub>2</sub> using a 6 MW alkaline electrolyzer powered by PV and wind plants references implemented in the ecoinvent database. This electrolysis system produces 9600 tons of H<sub>2</sub> in its lifetime. The GWP values for each kg of hydrogen produced by the PV and wind are estimated. Only much less than 10% of the GWP value is generated by the production and operation (use of KOH, etc.) of the alkaline electrolyzer for H<sub>2</sub> production. In comparison, almost the other more than 90% is caused by solar PV and wind systems. Focusing on the PV case, the electricity produced using the single-Si modules available in ecoinvent results in 13% higher GHG



emission (0.5 kg CO<sub>2</sub> eq.) than the default multi-Si ground-mounted PV system. The main reason behind this worst environmental performance is the higher energy consumption of the production of the single-Si wafer modules. In other words, the 1% higher efficiency of single-Si panels, which results in lower PV plant area, does not overcompensate for the higher production energy demand. This statement can justify the choice of multi-Si panels for large-scale ground-mounted PV plants in the ecoinvent database.

**Results:** A one-at-a-time sensitivity analysis (OAT-SA) was conducted by varying the main factors of renewable-powered electrolysis systems. The PV plant and the wind plant are equipped with ecoinvent default components. OAT-SA includes the PV and wind system lifetime, electrolyzer operating hours in its lifecycle, the specific electricity consumption of the electrolyzer, solar irradiance (insolation) in the case of PV system, and wind speed profile in the case of the wind system. The study shows the GWP behavior of each kg of H<sub>2</sub> produced by the electrolysis system. Power plant lifetime and location of the power systems have higher impacts on the environmental profile of the produced hydrogen. For example, decreasing the PV system lifetime from 30 to 15 years increases the GWP value from around 3.8 to 7.4 kg CO<sub>2</sub> eq./kg H<sub>2</sub>. The location of the PV site can affect the GWP value remarkably. For places with abundant sunshine (GHI = 2200 kWh/m<sup>2</sup> year), the GWP value can drop around 2 kg CO<sub>2</sub> eq./kg H<sub>2</sub>. Increasing the specific electricity consumption of the electrolyzer, the GWP value increase, and vice versa. On the contrary, the variation in the lifetime of the electrolyzer does not cause a noticeable change in the GWP value. Based on the findings, electrolyzer production has a relatively smaller impact on the global warming potential (GWP) as compared to the PV system. The same approach is used for the wind system.

The market share for PV modules and wind turbines in the Italian context has been considered the same as the European one, and their supply chains have been evaluated. The updated scenario results in almost a 52% and 59% reduction in GWP values for each kg of H<sub>2</sub> for multi-Si and single-Si modules compared to the baseline scenario (ecoinvent default ground-mounted PV system), respectively. For the multi-Si panels, 3.8 kg CO<sub>2</sub> eq./kg H<sub>2</sub> is reduced to 1.8 kg CO<sub>2</sub> eq./kg H<sub>2</sub>, while for the single-Si modules, which is the state-of-the-art PV system technology, a 2.5 kg CO<sub>2</sub> eq./kg H<sub>2</sub> reduction in GWP is obtained. Based on the real data and updated scenario, the CO<sub>2</sub> eq. mitigation is equal to 40% and 50% for multi-Si and single-Si ground-mounted PV systems with respect to the baseline scenario. The GWP values decrease from 2.5 for Lombardy to 2.0 for Lazio and then to 1.9 kg CO<sub>2</sub> eq./kg H<sub>2</sub> for Sicily. The same approach is used for the wind power plant [1].

The hydrogen produced with the updated renewable energy systems is exploited in the transport sector. In particular, fuel consumption and emissions obtained by the Real Drive Emissions procedure were considered for some vehicles. The powertrains considered are both fossil fuel-based and fully battery-electric. Lifecycle CO<sub>2</sub>eq emissions were estimated in the event that the cars under consideration were powered by hydrogen.

**Conclusions:** The promising updated values of GWP suggest the necessity of the application of state-of-the-art PV modules for solar photovoltaic-based H<sub>2</sub> production projects to reduce the climate profile of this process

### Acknowledgment

This research was partly funded by the H2 JRP at Politecnico di Milano [2]

### References

[1] Kolahchian Tabrizi, M., Famiglietti, J., Bonalumi, D., & Campanari, S. (2023). The Carbon Footprint of Hydrogen Produced with State-of-the-Art Photovoltaic Electricity Using Life-Cycle Assessment Methodology. *Energies*, 16(13), 5190. <https://doi.org/10.3390/en16135190>

[2] <https://www.fondazionepolitecnico.it/en/initiatives/hydrogen-jrp/> (accessed on 15 June 2023)



# Novel Methods of Testing For Measurement of Natural Gas and Hydrogen Mixtures (THOTH2)

Matteo Robino <sup>\*a</sup>, Miguel Ballesteros <sup>b</sup>

\* corresponding author: [Matteo.Robino@snam.it](mailto:Matteo.Robino@snam.it)

<sup>a</sup> SNAM SpA, piazza S. Barbara 7, S. Donato Milanese (MI) Italy

<sup>b</sup> GERG Av. Palmerston 4, 1000 Bruxelles, Belgio

*Keywords: Hydrogen/natural gas mixture in gas grid, Hydrogen/natural gas mixture metering*

## Abstract

### Introduction:

Measurement performances must be ensured before large-scale uptake, for economic and fiscal aspects, safety, environmental and overall compliance reasons. Hydrogen, particularly mixtures of hydrogen and natural gas (H2NG), is not the exception and hence it is essential to increase confidence in the use/transport/measurement of H2NG and pure hydrogen in existing infrastructures to accelerate the decarbonization of the energy sector. The project “Novel methods of testing for measurement of natural gas and hydrogen mixtures” (THOTH2), funded through the Clean Hydrogen Partnership programme, aims to develop new validated methods, protocols and facilities for testing the metrological performances of various measuring devices installed in the gas distribution and transmission networks, when operated with H2NG mixtures up to 30 %vol. and pure H2.

### Objectives\_ Material and methods:

The share of hydrogen in the energy mix is expected to increase significantly in the long term, accounting for up to 12 % of the global energy demand by 2050 [1]. Several studies and projects have found that both transmission and distribution pipelines could accept certain %vol of H<sub>2</sub>, even up to 100 %, depending on the material and operating conditions. However, in addition to ensuring material compatibility, several other aspects have to be verified for the successful injection and transportation of H2NG mixtures. When using H2NG or pure H<sub>2</sub>, it is important to assess the behaviour of the different components in the gas measuring systems typically installed in the network. In addition to the development of standardized protocols to verify measuring devices' performances in H2NG, THOTH2 will investigate and verify the algorithms used in energy bills calculation. Fiscal measurement in the multi-gas era is one of the key challenges associated with the introduction of renewable gases in the existing gas network [2]. Measurements of flow and gas quality are essential for reliable billing, considering the decrease in energy content associated to the addition of hydrogen and the need to increase the flow to compensate for the energy decrease.

The THOTH2 project aims to develop new validated methodologies, protocols and facilities for testing the metrological performances of the existing measuring devices installed in the gas transmission and distribution networks, when operated with H2NG mixtures up to 30 %vol and pure H<sub>2</sub>. To achieve this, a consortium composed of gas infrastructure operators, together with research, metrology and academic partners, is designing the dedicated methodologies to test different types of measuring devices installed in the grids.

The measuring devices to assess include, among others, gas meters, volume conversion devices, pressure and temperature transmitters, gas quality analyzers, and leak detectors. A three-step approach is being employed: validation tests (ensuring measurement traceability and fit-for-purpose uncertainty), limit tests (for the determination of thresholds affecting measurement accuracy) and aging tests (for durability). Furthermore, the limits and tolerances of the tested measuring devices will be identified. After the initial review of the measuring devices, THOTH2 will



develop testing protocols and verification procedures, for gas flow meters, gas quality analyzers, pressure transmitters and any other relevant measuring devices.

The specific methodology for testing the main components of the gas grid will be developed to identify hydrogen limits and tolerances of gas meters, considering different factors and the periodic metrological inspection on test rigs. Different types of meters will be tested and compared in more laboratories, to validate accuracy and traceability. A similar approach will be used to develop the methodology to perform testing of quality analyzers, to identify hydrogen limits and tolerances, in stationary and dynamic conditions. Experimental validation will be conducted to validate the feasibility of the new testing protocols developed to evaluate the performance of measuring devices for the quality and quantity of H<sub>2</sub>NG mixtures. Subsequently, using the measuring devices selected at previous stages using the defined prioritization criteria, a methodology validation will be carried out, making the necessary corrections and iterations in case of protocol failure until the experimental validation succeeds. Finally, testing will be performed to determine the hydrogen limits and tolerance for the selected measuring devices, conducting tests with different percentages of H<sub>2</sub> (from 0 % to 100 % vol) and conditions.

#### **Results:**

The main expected result of THOTH<sub>2</sub> is the definition and validation of new methodologies for testing state-of-the-art gas measuring instrumentation. Outcomes will be complementary to parallel activities such as the project, metrology for the hydrogen supply chain (Met4H<sub>2</sub>) [3], which is developing the metrological traceability for various measurement systems, including flow and gas quality.

Moreover, THOTH<sub>2</sub> will contribute to the definition of new algorithms for measurement consistency between the reference value and the results of calibrated gas meters, considering that there is a lack of algorithms for gas volume converter in H<sub>2</sub>NG mixture with an H<sub>2</sub> content higher than 10 %vol, taking into account the changes in the compressibility factor due to the addition of hydrogen, compared to the standard calculation for natural gas.

In the end, THOTH<sub>2</sub> will produce scientific evidence by experimental tests in H<sub>2</sub>NG mixtures up to 100 % H<sub>2</sub>, based on the validated new methodology, and THOTH<sub>2</sub> will also provide recommendations for new guidelines or standards and/or revision of the existing ones.

#### **Conclusions and Acknowledgment:**

The expected outcomes of THOTH<sub>2</sub> include the review, update and filling of gaps in the normative and standard frameworks covering H<sub>2</sub>NG blends and pure H<sub>2</sub> measurements in the gas infrastructure, increased knowledge in the field of metering systems in H<sub>2</sub>NG and pure H<sub>2</sub>, and more scientific knowledge/experience about the performances of the existing devices in H<sub>2</sub>NG mixtures (up to 30 % vol. H<sub>2</sub>) and pure H<sub>2</sub>. The project will also contribute to the rollout and/or repurposing of preliminary plans to allow the injection of H<sub>2</sub> into the gas transmission and distribution infrastructures up to 30 %vol in the medium term.

Consequently, THOTH<sub>2</sub> will have a positive impact on unlocking the potential of gas networks to transport hydrogen, by enabling the creation of green gas markets, supporting the quantitative measurement of hydrogen flow into the grid, accurate calibration of measuring devices and more accurate billing. This will promote the use of green hydrogen in all various sectors, allowing faster decarbonization.

#### **References**

- [1] IRENA, 2022. Global Hydrogen Trade to Meet the 1.5°C climate goal
- [2] Domanski, K., Rueegg, A. Calorific value: fiscal measurement in the multi-gas era
- [3] Van der Veen, A., et al. 2022. Euramet publishable summary for 21GRD05 Met4H<sub>2</sub> Metrology for the hydrogen supply chain



## Comparative Study of Metal Oxide Nanoparticle Composites for Hydrogen Gas Sensing

Brigida Alfano<sup>a</sup>, Maria Lucia Miglietta<sup>\*a</sup>, Anna De Girolamo<sup>a</sup>, Ettore Massera<sup>a</sup>, Patricia Arroyo<sup>b</sup>, Jesús Lozano<sup>b</sup> and Tiziana Polichetti<sup>\*a</sup>

\* corresponding author: mara.miglietta@enea.it; tiziana.polichetti@enea.it

<sup>a</sup> Agenzia nazionale per le nuove tecnologie, l'energia e lo sviluppo economico sostenibile (ENEA), P.le E. Fermi 1, Portici, I-80055 Naples, Italy

<sup>b</sup> Industrial Engineering School, University of Extremadura, Av. Elvas s/n, 06006 Badajoz, Spain

*Keywords: hydrogen sensing, metal catalysts, metal oxides.*

### **Abstract**

#### **Introduction:**

Gaseous hydrogen is promising in reducing greenhouse gas emissions due to its clean energy generation, producing only water as a by-product [1]. So far, its extreme volatility and high flammability in air concentrations above 4% require careful handling and monitoring during storage, transportation, and distribution [2]. Presently, hydrogen sensors, predominantly based on metal oxides, face limitations including low sensitivity and the need for elevated temperatures for optimal performance [3]. Scientific literature suggests that incorporating noble metals like rhodium (Rh), palladium (Pd), and platinum (Pt) can significantly enhance sensor performance [4-6].

#### **Objectives:**

Herein some results achieved during the first year of research on hydrogen sensor development for distributed transport network control, a part of the POR H2 project, are presented. The study shows chemiresistive structures based in hydrogen-sensitive materials: indium tin oxide nanoparticles (ITO NPs) functionalized with graphene nanoplatelets (GNPs), together with Rh, Pd, and Pt nanoparticles. The chemosensors were tested to 0.5% H<sub>2</sub> diluted in synthetic air, at temperatures ranging from 50 to 250°C.

#### **Materials and Methods:**

GNPs were synthesized according to ref. [7] from commercial graphite flakes. Three dispersions (G-ITO-Pt, G-ITO-Pd, and G-ITO-Rh) based on ITO NPs/GNPs/noble metal NPs were prepared. Each solutions contained 5x10<sup>-3</sup> g of ITO dissolved in 2 mL of deionized water, added with 1 mL of colloidal dispersion of metal NPs and 1.2 mL of GNPs. Ultrasound treatment was applied for 1 hour. Chemiresistors were fabricated by drop-casting the dispersions onto an Al<sub>2</sub>O<sub>3</sub> substrate with interdigitated gold electrodes. Films were dried at 180°C for 1 hour, then annealed at 270°C for 1 hour.



## Results:

Figure 1 depicts a comparison of the dynamic response at their respective optimal operating temperatures. Each material exhibited response intensity dependent on the unique ITO-metal catalyst coupling. Device performance concerning operating temperature are aligned with existing literature [8].

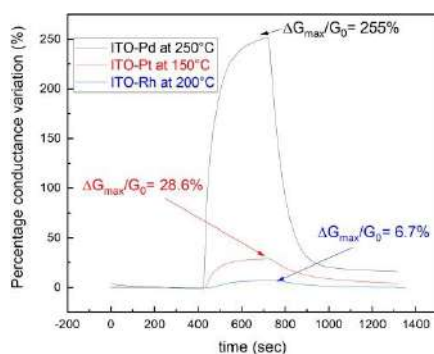

Figure 1. A comparison of the dynamic response of the prepared nanocomposite. Devices biased at 1 V. Sensing tests for 0.5% H<sub>2</sub> were conducted in synthetic air with 50% RH.

**Conclusions:** The study provides a basis for the development of sensors with optimized performance, in terms of operating temperature, response and recovery time.

## Acknowledgment

This research was funded by the Italian Ministry of Ecologic Transition (MiTE) through Operational Research Plan (POR), in the framework of Next Generation EU, Project title “Research and development of technologies for the H<sub>2</sub> supply chain”.

## References

- [8] Ball, M., & Wietschel, M. (2009). The future of hydrogen—opportunities and challenges. *International journal of hydrogen energy*, 34(2), 615–627.
- [9] Buttner, W. J., Post, M. B., Burgess, R., & Rivkin, C. (2011). An overview of hydrogen safety sensors and requirements. *International Journal of Hydrogen Energy*, 36(3), 2462–2470.
- [10] Wang, C., Yin, L., Zhang, L., Xiang, D., & Gao, R. (2010). Metal oxide gas sensors: sensitivity and influencing factors. *sensors*, 10(3), 2088–2106.
- [11] Wan, Q.; Lin, C.L.; Yu, X.B.; Wang, T.H. Room-temperature hydrogen storage characteristics of ZnO nanowires. *Appl. Phys. Lett.* 2004, 84, 124–126.
- [12] Kim, S.S.; Park, J.Y.; Choi, S.-W.; Kim, H.S.; Na, H.G.; Yang, J.C.; Kim, H.W. Significant enhancement of the sensing characteristics of In<sub>2</sub>O<sub>3</sub> nanowires by functionalization with Pt nanoparticles. *Nanotechnology* 2010, 21, 415502.
- [13] Sadek, A.Z.; Choopun, S.; Wlodarski, W.; Ippolito, S.J.; Kalantar-zadeh, K. Characterization of ZnO nanobelt-based gas sensor for H<sub>2</sub>, NO<sub>2</sub>, and hydrocarbon sensing. *IEEE. Sens. J.* 2007, 7, 919–924.
- [14] Fedi, F., Miglietta, M. L., Polichetti, T., Ricciardella, F., Massera, E., Ninno, D., & Di Francia, G. (2015). A study on the physicochemical properties of hydroalcoholic solutions to improve the direct exfoliation of natural graphite down to few-layers graphene. *Materials Research Express*, 2(3), 035601.
- [15] Darmadi, I., Nugroho, F. A. A., & Langhammer, C. (2020). High-performance nanostructured palladium-based hydrogen sensors—Current limitations and strategies for their mitigation. *ACS sensors*, 5(11), 3306–3327.