

The Effect of Thermal Stresses on the Electrical Resistance of Crimped Connections

Original

The Effect of Thermal Stresses on the Electrical Resistance of Crimped Connections / Galliana, F; Bellavia, L; Caria, Se; Perta, Ap; Roccato, Pe. - In: MAPAN. JOURNAL OF METROLOGY SOCIETY OF INDIA. - ISSN 0970-3950. - ELETTRONICO. - 38:(2023), pp. 71-82. [10.1007/s12647-022-00574-1]

Availability:

This version is available at: 11583/2971075 since: 2022-09-19T16:42:39Z

Publisher:

METROLOGY SOC INDIA

Published

DOI:10.1007/s12647-022-00574-1

Terms of use:

This article is made available under terms and conditions as specified in the corresponding bibliographic description in the repository

Publisher copyright

(Article begins on next page)



The Effect of Thermal Stresses on the Electrical Resistance of Crimped Connections

F. Galliana^{1*} , L. Bellavia¹, S. E. Caria¹, A. P. Perta² and P. E. Roccatò²

¹Department of Applied Metrology and Engineering, National Institute of Metrological Research (INRIM),
Strada delle Cacce 91, 10135 Turin, Italy

²Politecnico di Torino, C.so Duca degli Abruzzi 24, 10129 Torino, Italy

Received: 18 February 2022 / Accepted: 21 May 2022 / Published online: 18 June 2022

© The Author(s) 2022

Abstract: Cables headed with crimped lugs are frequently used in test laboratories in temperature rise tests carried out to validate electrical devices. The increase in the electrical resistance of the crimped connections can cause high dissipation of power and heat during these tests, impairing their outcome. This work evaluates the effect of thermal stresses on the resistance and on the dissipated power of crimped connections. This resistance was found to be more sensitive to thermal stresses than to mechanical ones analysed in a previous work. A limit of the dissipated power from crimped connections during temperature rise tests was estimated to be about 4 W corresponding to a crimp resistance of 24 $\mu\Omega$ for tests made at 400 A. Respecting these limits could avoid unnecessary rejections of equipment under test.

Keywords: Crimp technique; Thermal and mechanical stresses; Crimp resistance; Dissipated power; Lug; Temperature rise test; Test laboratory; Measurement uncertainty

1. Introduction

Electrical devices operating at high currents, such as those employed in electricity distribution and power systems, must comply in working conditions with temperature-rise limits to be validated according to the standards [1, 2]. They must not overheat during their operating conditions as this could cause a premature aging of their materials, an increase in the resistivity and of the oxidation of their internal conductors inducing damages or faults. To ensure that such devices are compliant to these standards they are submitted to temperature rise tests in order to check if they carry their nominal current (i.e. that normally applied) without exceeding the temperature limits established by the same standards for their safety and duration. In these tests, the cables have to be connected to a current generator and to the device under test to simulate its usual working conditions. These cables often end with lugs that are metal terminals consisting in a palm and a barrel [3, 4], Fig. 1a, b.

The lugs are frequently connected to the cables by crimping, a widespread and economic mechanical technique to connect electrical contacts by pressure [5, 6]. Crimping a lug to a cable is an irreversible operation permanently deforming both. The quality of a crimped connection and of its electrical resistance depend on the: material, cable section, crimp method, crimp profile, place and shape of the indents [7]. The role of crimped lugs is then important in a temperature rise test. If they are damaged or incorrectly crimped can cause a high temperature rise due to the power and heat dissipation that can affect or even invalidate the test. Focusing on the activity of test laboratories, the paper deals with the metrological aspects of crimped connections and in particular with the measurement of their electrical resistance. The aim of this work was the investigation of the changes of this resistance when crimped connections are submitted to thermal stresses. The results obtained, in addition to those in [4], could be important to improve the reliability of temperature rise tests. The paper gives a description of:

- The crimp technique;
- The crimp resistance;
- The measurement setup to measure the crimp resistance;

*Corresponding author, E-mail: f.galliana@inrim.it

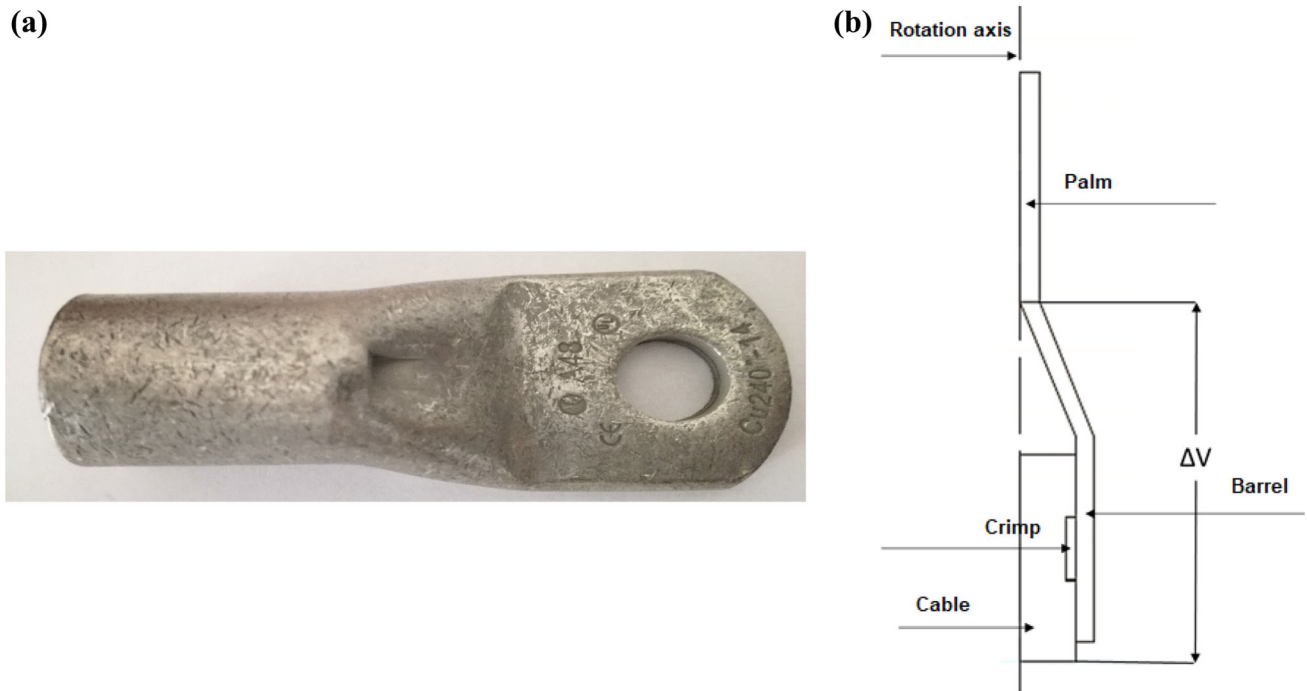

Fig. 1 a Lug Cembre A-48 M-14. b Cross section of a crimped connection cable-lug with a single indent crimp with the indication of where the voltage drop was measured

- The effects of thermal stresses on the crimp resistance;

Two temperature rise tests, made at the High Voltage and High Power Laboratory (LATFC) of the National Institute of Metrological Research (INRIM) are also described. From these tests, limit values of the crimp resistance and of the dissipated power of crimped connections to early identify potentially damaged lugs, are proposed. A flow-chart illustrating the paper steps is shown in Fig. 2.

This proposal represents the novelty of the work. Uncertainty budgets according to the ISO Guide of the Expression of the Uncertainties in measurements [8] are also given. This method can be useful and affordable for test laboratories and offers an alternative to other effective techniques as those based on thermographic and ultrasonic analysis [9, 10]. Nevertheless, the comparison of our method with these techniques, the technological analysis of poor electrical contacts and of the methods used to detect them, go beyond the scope of the paper. All the measurements were made in DC regime avoiding inductive coupling, except the current ones made with a clamp meter giving limited effects on external fields.

2. The Crimp Resistance

The electrical resistance of a crimped connection, crimp resistance (R_{crimp}), is made up of the equivalent resistances

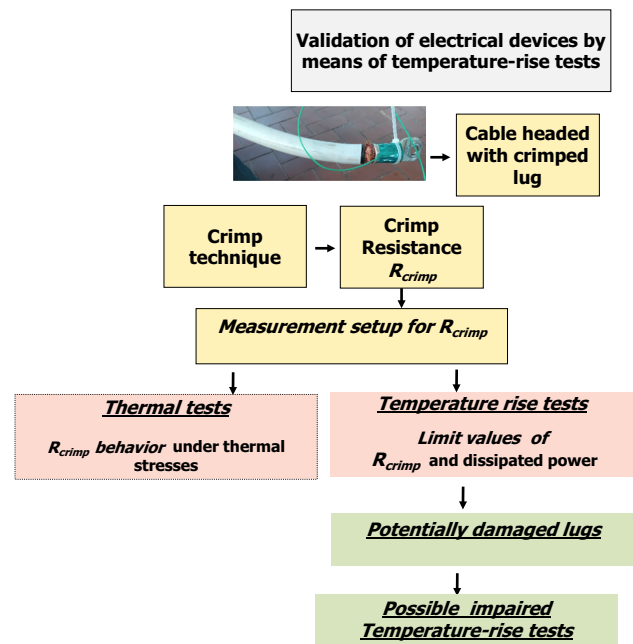

Fig. 2 Flow chart of the activity made and described in the paper. Firstly, brief explanations of the validation of electrical devices by means of temperature-rise tests, of the crimp technique and of the crimp resistance. In the following, thermal tests to study the behaviour of the crimp resistance under thermal stresses, and temperature-rise tests to identify limit values of the crimp resistance and of the dissipated power of crimp connections, were made

of the part of cable inside the crimped lug, of the lug itself in the crimped zone and of the contact between the cable and the palm of the lug (Fig. 3). This contact resistance is given by the sum of a constriction resistance and a film resistance.

Details are given in [3, 4, 11, 12]. In [4] an investigation of the dependence of R_{crimp} of crimped connections between lugs and a cable undergoing mechanical stresses was made. Lugs with different crimp profiles and made by different manufacturers were examined. All tested lugs showed a remarkable change of R_{crimp} in the first thermal stresses reaching after a stabilization value. In all cases, an R_{crimp} value lower than $15 \mu\Omega$, considered in [13] a limit value for reliable crimped connections, was observed. The electrical resistance of welded lugs was instead insensitive to this to this kind of stress. In [14] an investigation of the behaviour of R_{crimp} of crimped connections between lugs and cables of two different sections was made. The R_{crimp} values showed higher variability in lugs crimped to cables with larger section.

2.1. Measurement Methods and Setups

The measurements of R_{crimp} were made with two alternative methods: the first one is a voltammeter method while the second one consists in the direct measurement of the crimp resistance with a micro-ohmmeter. In Fig. 4, a block scheme of the two methods with the employed instruments and of the current supply is shown.

R_{crimp} was measured employing specifically: A current generator O.S.A.T Elettronica, max Voltage 8 V max current 1200 A, copper bars with a cross-section of 600 mm^2 , a test cable for low voltage (1 kV), headed with crimped, lugs, with length and section respectively 2 m and of 240 mm^2 , a current clamp meter Fluke mod. 355, a DMM HP mod. 34401A, an INRIM-built voltmetric clamp, a precision micro ohmmeter ICE mod. 20022, mod K thermocouples and a thermometer Fluke mod. 54 for the temperature measurements.¹ The traceability of the resistance measurements to the national standards maintained at INRIM is assured by means of the calibration of the micro ohmmeter (traceable to the dc resistance standard), of the DMM (traceable to the dc voltage standard) and of the current clamp meter (traceable to both national standards). The thermocouples and the Fluke mod. 54 thermometer are traceable to the national standard of temperature maintained at INRIM. In Fig. 5, a zoom of the measurement setup around the cable-lug connection to evaluate R_{crimp} with both methods, is shown.

¹Par14 Brand names are used for identification. Such use implies neither endorsement by INRIM nor assurance that the equipment is the best available.

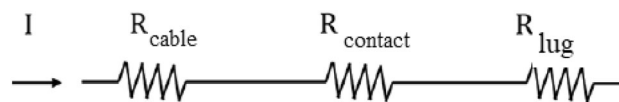

Fig. 3 Resistive equivalent circuit of a section of a crimped connection

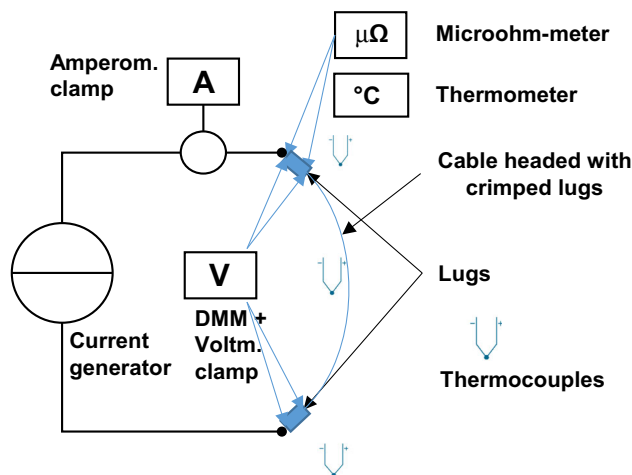

Fig. 4 Block scheme of the measurement setups for the measurements of R_{crimp} . One method is based on the direct measurement with a micro ohmmeter; the other is a voltammeter one based on the voltage measurement with a DMM and the voltmetric clamp and on the current measurement with an amperometric clamp

The voltmetric clamp is an auxiliary device, built at the LATFC to have a stable equipotential point on the cable to carry out the voltage measurements [14]. In Figs. 6 and 7 the place where the voltage was measured by the DMM and the connection of the lug to the microohm-meter, both for the evaluation of R_{crimp} , are respectively shown.

3. Effect of Thermal Stresses on the Electrical Resistance of a Crimped Connection

Liu et al. [15] reports an interesting study on the thermal dependence of the electrical resistance of crimped connections where good and bad crimp connections were submitted to thermal shocks showing that the contact resistance of better made crimped connections increased at a lower rate over time. In [16] a crimp connection was instead heated in an oven for some days. After this treatment, although with no damage evidence, it showed an intermittent high contact resistance. In test laboratories, during temperature rise tests, cables headed with crimped lugs are frequently submitted to thermal stresses, since their current can be higher than the nominal one. In a

temperature rise test on electrical devices used in distribution systems (switchboards, bus bars, etc.), each phase of the device is normally supplied by multiple cables. The different impedance among them induces an uneven distribution of currents. A test of the currents distribution was carried out measuring the currents in the cables supplying a low voltage bus bar (Fig. 8). Each phase of the device was supplied by six cables. The current measurements were made once the thermal equilibrium was reached. The results are shown in Table 1. The uncertainty of the current measurements was estimated from the accuracy specifications of the current clamp meter, as type B uncertainty contribution, and from the measurements standard deviation of the mean, as type A uncertainty contribution [8].

The majority of the cables carried a current of about 400 A but in the cable 6R flowed a current of about 800 A while other cables were underexploited as the cable 2R with a current of 232 A. Therefore, during a temperature rise test not all the cables are used in the same way and consequently they are not equally heated. This is due to that, in AC regime, the impedance takes an important role as outermost cables have larger loops and therefore higher impedance. In addition, as the cables are large and heavy, is not easy to arrange them and therefore they can have anomalous turns further increasing their impedance. For this reason, a test cable was submitted to thermal cycles to investigate the resistive behaviour of the crimped connections at its ends (lugs). The supply currents were 800 A and 1000 A. These values were chosen because high currents as in the cable 6R in the previous test are usual.

3.1. Thermal Tests

In Fig. 9 a photo of the system to supply the current to the test cable (heating system) for the thermal tests, is shown.

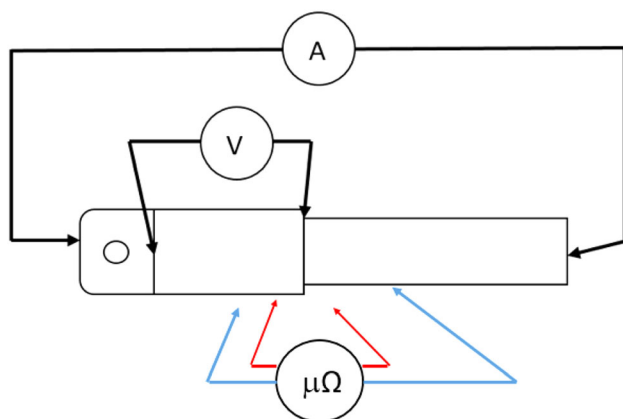

Fig. 5 Scheme of the current supply to the cable with a crimped lug and of the places in which the R_{crimp} measurements were made with both methods

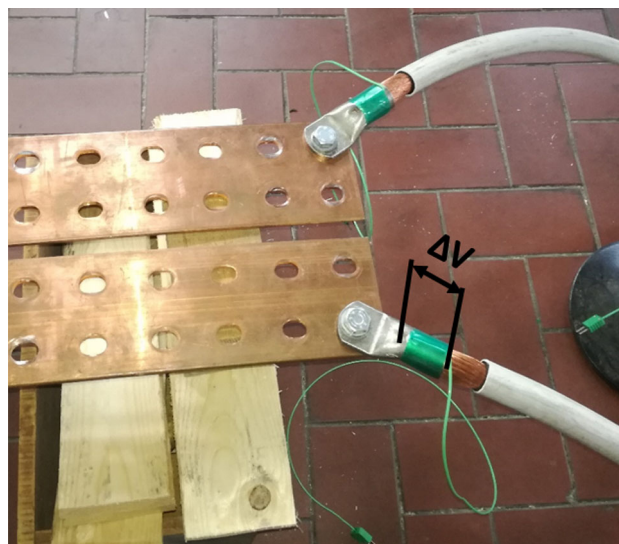

Fig. 6 Place in which the voltage drops were measured by the DMM to evaluate R_{crimp} with the voltammeter method. The current is measured with the current clamp meter

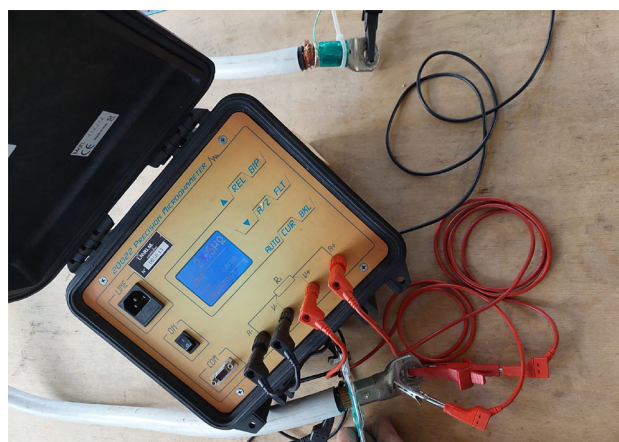

Fig. 7 View of the connection of the microohm-meter to the lug for the direct measurement of R_{crimp}

The current generator supplies the current through two copper bars.

The cable was subjected to five consecutive thermal cycles with supply currents of 800 A in the first and in the last two cycles and 1 kA in the third one. Two lugs with hexagonal crimp profile were crimped at its ends. The lug 1 (left side) was previously submitted to mechanical stresses reaching after them a R_{crimp} value of about $6 \mu\Omega$ [4]. These thermal cycles were realized to simulate the real thermal stresses to which the cables are submitted during temperature rise tests. Starting from a temperature of 20°C , each thermal cycle consisted in a heating time (6 h), followed by

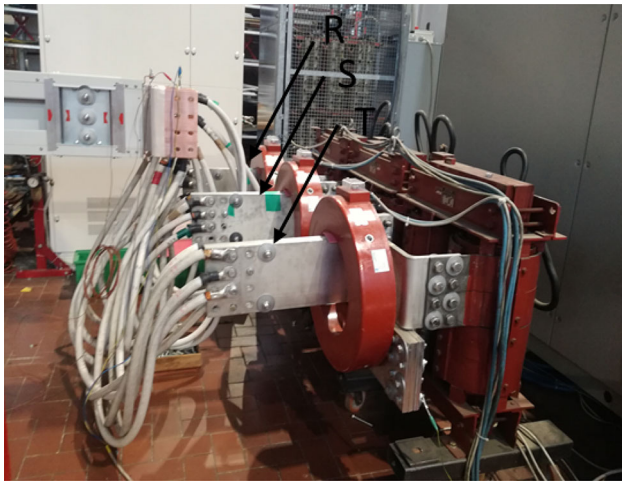

Fig. 8 Connection of test cables on a bus bar for low voltages

Table 1 Currents in cables in a temperature rise test on a bus bar in low voltage

Cable	Current (A)
1 T	345.8 ± 5.9
2 T	462.0 ± 6.9
3 T	371.4 ± 6.1
4 T	385.0 ± 6.2
5 T	414.0 ± 6.5
6 T	483.0 ± 7.1
<i>Total on phase T</i>	2518
1 S	331.9 ± 5.8
2 S	470.5 ± 7.0
3 S	541.5 ± 7.6
4 S	284.0 ± 5.4
5 S	521.0 ± 7.4
6 S	461.0 ± 6.9
<i>Total on phase S</i>	2521
1 R	277.9 ± 5.3
2 R	232.4 ± 4.9
3 R	397.6 ± 6.3
4 R	298.5 ± 5.5
5 R	541.0 ± 7.6
6 R	792.5 ± 9.7
<i>Total on phase R</i>	2530

a stabilization time (2 h) at the maximum temperature² (from 100 to 120 °C) and finally by a cooling time (8 h). The R_{crimp} measurements at the end of each thermal cycle (after the cooling time) and during the heating time were made respectively with the micro ohmmeter and by means

²Par20 The maximum temperature is detected when the temperature does not vary by more than 1 K/h.



Fig. 9 View of the heating setup with the OS.A.T current generator (right side) supplying, through two copper bars, the cable headed with the two crimped lugs whose R_{crimp} has to be measured

of the volt-ammeter method. These last measurements were made to verify both the reliability of the micro ohmmeter measurements and if R_{crimp} was already changing during the heating. Table 2 and Fig. 10 report the R_{crimp} values of the two lugs at the end of each thermal cycle. An increase of R_{crimp} at the end of each thermal cycle was observed.

In the first two cycles, R_{crimp} trend of the two lugs was similar, while after the third cycle R_{crimp} of the lug 2 increased at a higher rate than the lug 1. As the lug 2 was crimped in a different place than the lug 1, its higher increase of R_{crimp} was presumably due to this crimp position. The corresponding higher dissipated power induced a temperature of 120 °C on the same lug. R_{crimp} of both lugs after the last thermal cycle was about 25 $\mu\Omega$ while in [4] a maximum R_{crimp} under mechanical stresses of 9 $\mu\Omega$, was observed. Therefore, R_{crimp} seems more sensitive to thermal stresses than to mechanical ones. Anyway, the final value of R_{crimp} of the lug 2 was presumably due to its defective crimp.

R_{crimp} of the lug 1 changed at a higher rate when it was subjected to thermal stresses than to mechanical ones. Nevertheless, its final value was presumably also due to the previous mechanical stresses to which it was submitted. In Fig. 11, the R_{crimp} trend of this lug, starting from its crimping, then under mechanical and thermal stresses, is shown.

Figure 12 shows the voltammeter measurements made on the lug 1 during the heating time of the thermal cycle I compared with the measurement at the end of the cycle made with the micro-ohmmeter. Considering the uncertainties of the methods, estimated respectively in the

Table 2 R_{crimp} of the two lugs at the end of each thermal cycle (with micro-ohmmeter)

Thermal cycle	R_{crimp} of lug 1 at 20 °C ($\mu\Omega$)	R_{crimp} of lug 2 at 20 °C ($\mu\Omega$)
0	6.0	4.0
I	7.1	4.8
II	10.4	6.8
III	18.2	23.1
IV	19.7	25.4
V	25.2	25.3

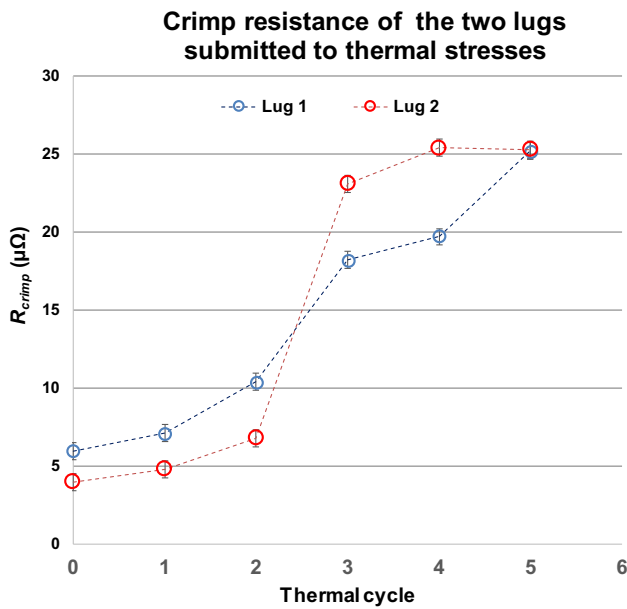

Fig. 10 Trend of the R_{crimp} values of the two lugs after each thermal cycle

following Tables 3 and 6, the measurements with the two methods agree at a satisfactory level.

3.2. Uncertainty Evaluation of the R_{crimp} Measurements with the Microhmmeter

The type A standard uncertainty of the R_{crimp} measurements at the end of each thermal cycle due to the possible different positions of the tip,³ was evaluated as in [14] giving $u(R_{crimp}) \cong 0.27 \mu\Omega$. To determine the total uncertainty of the R_{crimp} measurement, the component due to the micro ohmmeter was added. The budget is reported in Table 3.

³Par25 The tip is an electrode with an insulating coating for the handle, which, by means of a flexible conductor, is used to connect the DMM terminals to the terminals on which the voltage drop has to be measured.

R_{crimp} of lug 1 submitted to mechanical and thermal stresses

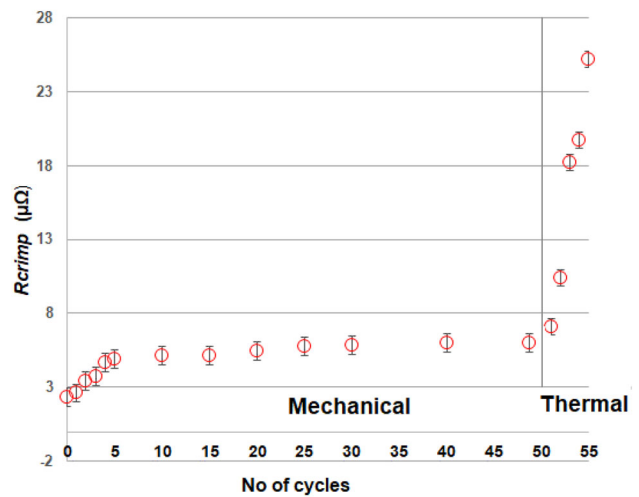

Fig. 11 R_{crimp} of lug 1 submitted first to mechanical stresses (the first fifty in Fig. 10) and after to thermal ones (last five)

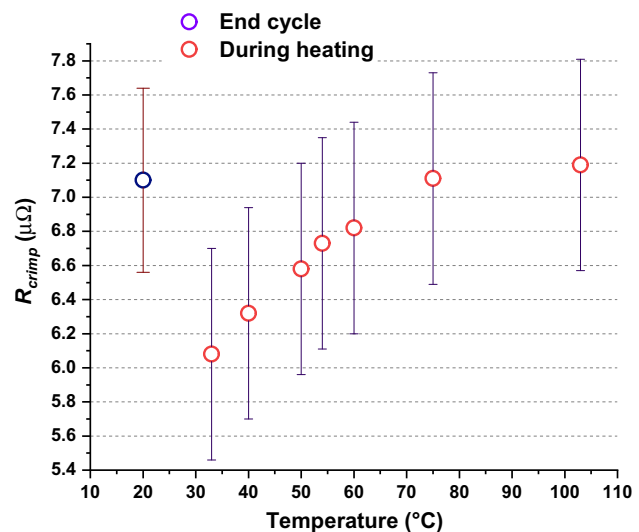

Fig. 12 Comparison of the R_{crimp} measurements. (These resistance values were reported at 20 °C taking into account the temperature coefficient of the lug material to be comparable with the resistance values measured before the cycle and after the cooling times (at 20 °C).) respectively at the end of the thermal cycle (blue dot) and during the heating period (red dots) in the thermal cycle I. These measurements were respectively made with the micro-ohmmeter and with the voltammeter method

4. Temperature Rise Tests

To investigate the behaviour of R_{crimp} in temperature rise tests, two analogous tests were carried out in which the cables were connected only to two of the three phases of a contactor to have mirror conditions on both poles. The supply current was 400 A. The involved phases are

Table 3 Simplified uncertainty budget of the measurement of R_{crimp} of the crimped connection after each thermal cycle with the microhmmeter

Uncertainty component	Type	Standard uncertainties ($\mu\Omega$)
Reproducibility due to the tip ^a	Normal A	0.27
Micro-ohmmeter accuracy	Rect. B	0.0021
$u(R_{\text{crimp}})^{\text{b}}$	RSS ^c	0.27
$U(R_{\text{crimp}})^{\text{d}}$		0.54

Bold values indicate a combination (root square) of the previous data

^aThe reproducibility of the tip was evaluated locking the clamp on the beginning of the cable and placing the tip on the inspection hole evaluating the voltage drop on the barrel of the lug. The measurements were used to calculate their standard deviation of the mean as type A standard uncertainty [8]. For further details, see [14]

^bCombined standard uncertainty [8, §2.3.4]

^cRSS = Ratio Square Sum

^dExpanded uncertainty [8, §2.3.5]. Typically, for a probability distribution approximately Gaussian and a confidence level of 95%, it is about twice the combined standard uncertainty

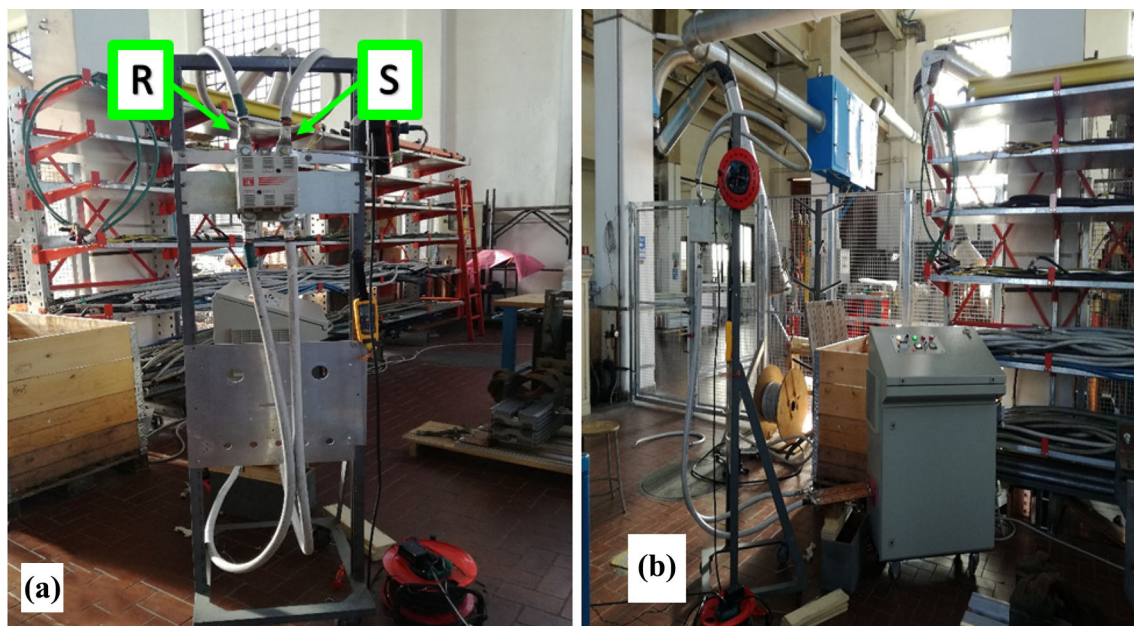

Fig. 13 Measurement setup for the temperature rise tests: front view (a); lateral view (b)

identified with R and S in Fig. 13a. The temperature change at the terminals of the contactor in the connection points with the test cables was measured. The measurement system to evaluate R_{crimp} was still the same used for the previous tests adding low voltage cables with 2 m length and 240 mm² section, normally used in temperature rise tests at the LATFC. Two cables for each phase were connected to the current generator through the copper bars and to the lower terminals of the contactor on the two involved phases. A third cable was short-circuited at the output of the contactor. Crimped lugs with high and low R_{crimp} at 20 °C were chosen to investigate the temperature difference on the terminals of the contactor when crimped lugs are in good or bad condition. In both tests, four lugs were used. In the two tests were involved respectively: three lugs

with R_{crimp} at 20 °C of about 5 $\mu\Omega$ and one with R_{crimp} about five times higher in the first one; a lug with R_{crimp} at 20 °C of about 5 $\mu\Omega$ and three with R_{crimp} at 20 °C about five times higher in the second one. Holes were drilled at the terminals of the contactor to measure the temperature. The measurements were performed once the contactor reached the thermal equilibrium detected measuring the temperature every 15-min. In the field of temperature rise tests, the temperature equilibrium is achieved when the temperature does not vary by more than 1 K/h. In Fig. 14a, b, the terminals on which the temperature measurements were carried out and the no. of the lugs involved in the tests, are respectively shown. The lugs 1 and 3 were connected to the phase R while the lugs 2 and 4 were connected to the phase S. R_{crimp} was evaluated between the

Fig. 14 **a** Terminals of connection with the contactor on which the temperature measurements were carried out. **b** No. of the lugs involved in the temperature rise tests

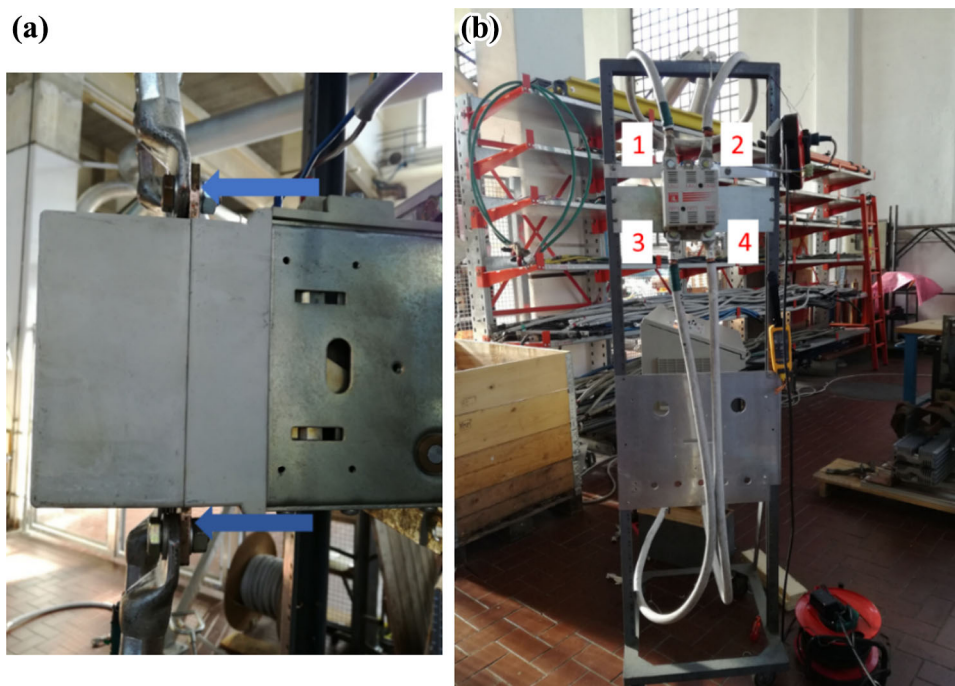

Fig. 15 View of the thermocouple place to measure the temperature rise of the lugs in the two tests

inspection hole of the lugs and the beginning of the corded cable (Fig. 5). All the temperature measurements were made by means of mod. K thermocouples and of the thermometer Fluke mod. 54 both calibrated in terms of the national standard of temperature. The thermocouples for the measurement of the temperature rise were placed on the lugs barrel (Fig. 15). The dissipated power was instead evaluated from the measurements of the currents and of R_{crimp} . The values of R_{crimp} and of the dissipated power for both tests are shown in Figs. 16, 17 and in Tables 4, 5.

4.1. Uncertainty Evaluation

Some simplified uncertainty budgets of the measurements of R_{crimp} , of the dissipated power and of the temperature rise are reported in Tables 6, 7, 8.

Multiplying these relative uncertainties for the R_{crimp} value of the lug 2 of the first test ($5.49 \mu\Omega$) the following absolute uncertainties are obtained: combined standard uncertainty $u(R_{\text{crimp}}) \cong 0.31 \mu\Omega$, expanded uncertainty $U(R_{\text{crimp}}) \cong 0.62 \mu\Omega$.

Multiplying these relative uncertainties for the power value of the lug 2 of the first test $P = 0.9 \text{ W}$ the following absolute uncertainties are obtained: combined standard uncertainty $u(P) \cong 0.054 \text{ W}$, expanded uncertainty $U(P) \cong 0.11 \text{ W}$.

Multiplying these relative uncertainties for the temperature rise value of the lug 4 $T \cong 58.5 \text{ }^\circ\text{C}$, the following absolute uncertainties are: combined standard uncertainty $u(\Delta\theta) \cong 1.27 \text{ }^\circ\text{C}$, expanded uncertainty $U(\Delta\theta) \cong 2.5 \text{ }^\circ\text{C}$.

5. Maximum Acceptable Crimp Resistance

In both tests, the temperature rise of the lugs with $R_{\text{crimp}} \cong 5 \mu\Omega$ at $20 \text{ }^\circ\text{C}$ was about 50 K. Instead, the temperature rise of the lug 3 in the second test and with R_{crimp} at $20 \text{ }^\circ\text{C}$ of $28.88 \mu\Omega$, was higher than 60 K. Thus, if the contactor was submitted to a real temperature rise test,

Fig. 16 Dissipated power and R_{crimp} along with their expanded uncertainties in the first test

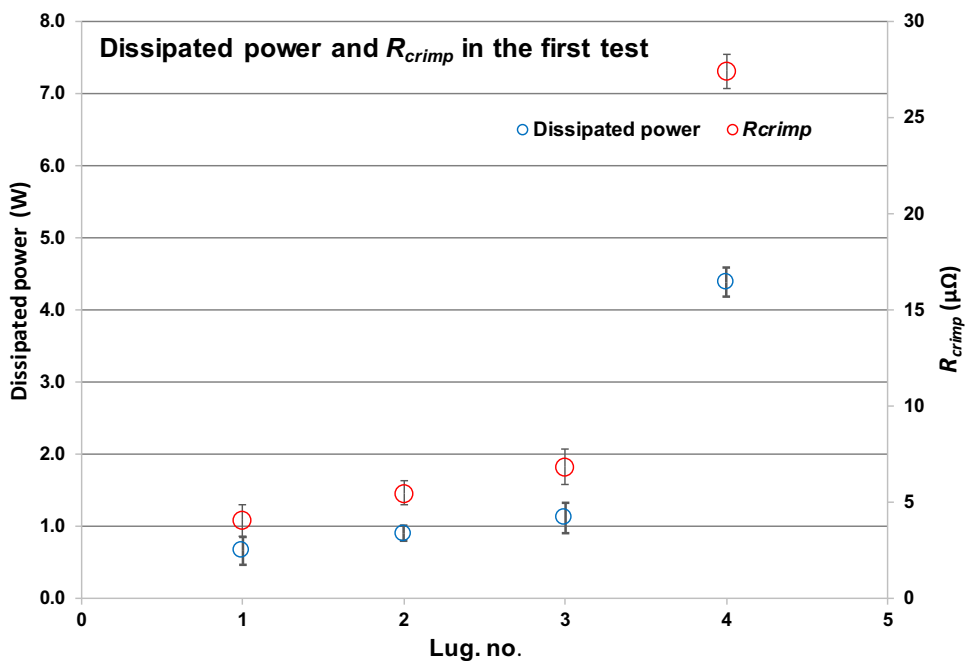
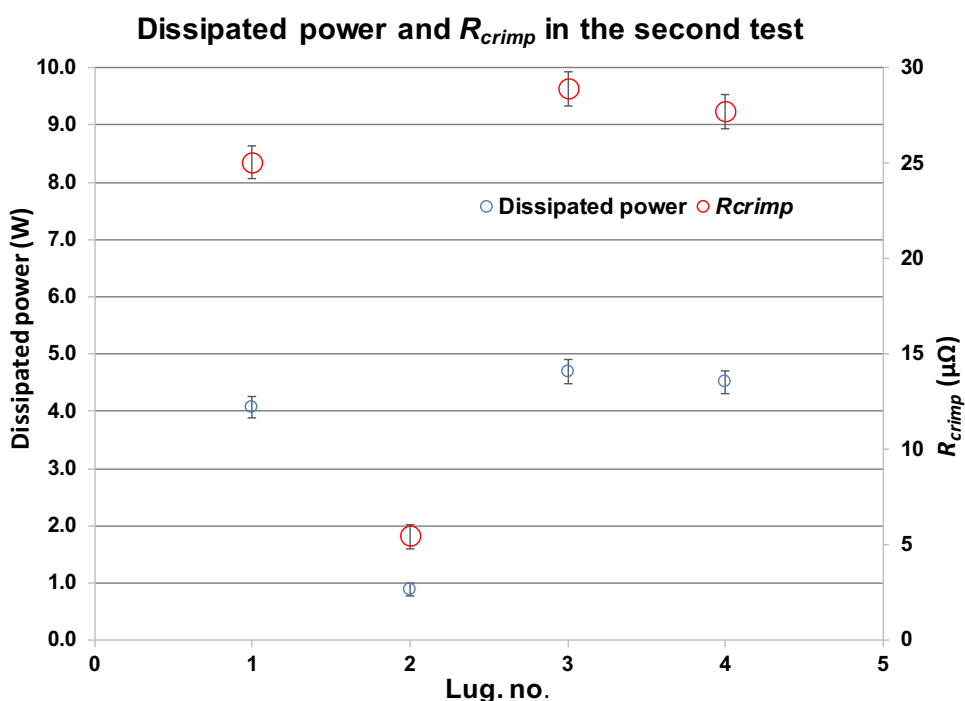

Fig. 17 Dissipated power and R_{crimp} along with their expanded uncertainties in the second test



so connected as in ordinary service, if equipped with terminals of untreated copper, it may not be validated.⁴ A value of the dissipated power above which the temperature rise on the crimped connections and on the terminals of the device under test can put its validation at risk, was estimated. From this value, a limit value of R_{crimp} of the same

lug can also be deduced. The power value was obtained analysing the trend of the dissipated power as function of the temperature rise $\Delta\theta$ on the terminals of the contactor in the two temperature rise tests. Figure 18 shows that this trend is approximately linear. The best fitting curve is:

$$W_{diss}(\Delta\theta) = 0.4518 \times \Delta\theta - 22.399 \tag{1}$$

An acceptable temperature rise limit can be 58 K as 60 K is considered an over-limit for terminals made of untreated copper [17]. The limit value of the dissipated

^{Par32} In [17] the temperature rise limits at the terminals of an equipment under test, according to their material are given. The lowest (60 K) is for untreated copper.

Table 4 Results of the first temperature rise test

	Lug 1	Lug2	Lug 3	Lug 4
R_{crimp} at 20 °C ($\mu\Omega$)	4.07 \pm 0.62	5.49 \pm 0.62	6.86 \pm 0.63	27.42 \pm 0.87
Temperature at the terminals (°C)	71.4 \pm 1.8	72.3 \pm 1.8	72.8 \pm 1.8	79.0 \pm 1.8
Dissipated power (W)	0.67 \pm 0.1	0.90 \pm 0.11	1.12 \pm 0.11	4.50 \pm 0.2
Temperature rise at the terminals (K)	50.5 \pm 2.5	51.4 \pm 2.5	51.9 \pm 2.5	58.1 \pm 2.5

Table 5 Results of the second temperature rise test

	Lug 1	Lug 2	Lug 3	Lug 4
R_{crimp} at 20 °C ($\mu\Omega$)	25.04 \pm 0.84	5.42 \pm 0.63	28.88 \pm 0.91	27.73 \pm 0.88
Temperature at the terminals (°C)	79.4 \pm 1.8	74.2 \pm 1.8	81.8 \pm 1.8	79.7 \pm 1.8
Dissipated power (W)	4.07 \pm 0.19	0.88 \pm 0.11	4.69 \pm 0.21	4.50 \pm 0.20
Temperature rise at the terminals (K)	58.6 \pm 2.5	53.4 \pm 2.5	61.0 \pm 2.5	58.9 \pm 2.5

Table 6 Uncertainty budget of the measurement of R_{crimp} of the lug 2 in the first test

Uncertainty component	Type	Relative standard uncertainties (%)
Reproducibility Volt. clamp ^a	Normal A	\cong 0.0055
Reproducibility of the tip	Normal A	\cong 0.32
DMM accuracy	Rect. B	\cong 5.5
Current clamp accuracy	Rect. B	\cong 0.92
Relative comb. stand. uncert	RSS	\cong 5.6

Bold values indicate a combination (root square) of the previous data

$$u_r(R_{\text{crimp}}) \cong 5.6\% \text{ and } U_r(R_{\text{crimp}}) \cong 11.2\%$$

^aThe reproducibility of the voltmetric clamp was evaluated locking the tip on the inspection hole of the terminal and making the measurements of the voltage drop between the inspection hole and the start of the barrel of the lug. The measurements were used to calculate their standard deviation of the mean as type A standard uncertainty [8]. For further details, see [14]

power, from (1) is $W_{\text{diss,lm}} \cong 3.81$ W, from which the limit value of $R_{\text{crimp}} \cong 24 \mu\Omega$ is obtained being the test carried out at 400 A. Then, it can be concluded that, for a correct validation of a device submitted to a temperature rise test, values on the order of 4 W and 24 $\mu\Omega$ can be considered as limit ones of the dissipated power and of the electrical resistance respectively of the crimped connections. It is then suggested to carry out periodic measurements on the available lugs and, if they are involved in tests at 400 A, to replace them when their R_{crimp} is about 24 $\mu\Omega$. If tests are made at other currents, the dissipated power value of about 4 W could be considered as limit value to take into account for replacing the lugs.

6. Conclusion

The investigations made and reported in the paper allowed the identification of limit values of the dissipated power and of the electrical resistance of crimped connections to

avoid not correct temperature rise tests.. In fact, with this novel method it is possible to early identify potentially damaged lugs. The investigation was made by means of electrical measurements traceable to national standards. Respecting these limit values can be an alternative to the use of other techniques, as thermography and ultrasonic inspection, to detect potentially damaged lugs. Technically speaking, the simplest solution to avoid excessive temperature rise could be to adopt welded connections, much less sensitive to stresses, in place of crimped ones. Nevertheless, welding all connections of test cables is more expensive than making crimped connections. The measurement of the electrical resistance of the crimped connections as soon as test cables are available in laboratory to early identify potentially damaged lugs, is then recommended. Periodic measurements have to be also carried out to identify possible weakening of the crimped connections. In the standards for electrical tests, requirements indicating the limit values of the crimp resistance and of the

Table 7 Uncertainty budget of the measurement of the dissipated power of the lug 2 in the first test

Uncertainty component	Type	Relative standard uncertainties (%)
Current, resistance readings	Normal A	0.89
Current clamp accuracy	Rect. B	1.8
Micro-ohmmeter accuracy	Rect. B	5.6
Relative comb. stand. uncert	RSS	5.95
Micro-ohmmeter accuracy	Rect. B	5.6
Relative comb. stand. uncert	RSS	5.95

Bold values indicate a combination (root square) of the previous data

$$u_r(P) \cong 5.95\% \text{ and } U_r(P) \cong 11.89\%$$

Table 8 Uncertainty budget of the measurement of the temperature rise on the lug 4 in both tests

Uncertainty component	Type	Relative standard uncertainties (%)
Temperature readings	Normal A	0.017
Thermometer accur. (T_{amb})	Rect. B	1.52
Thermometer acc. ($t_{terminals}$)	Rect. B	1.52
Relative comb. stand. uncert	RSS	2.15

Bold values indicate a combination (root square) of the previous data

$$u_r(\Delta\theta) \cong 2.15\% \text{ and } U_r(\Delta\theta) \cong 4.3\%$$

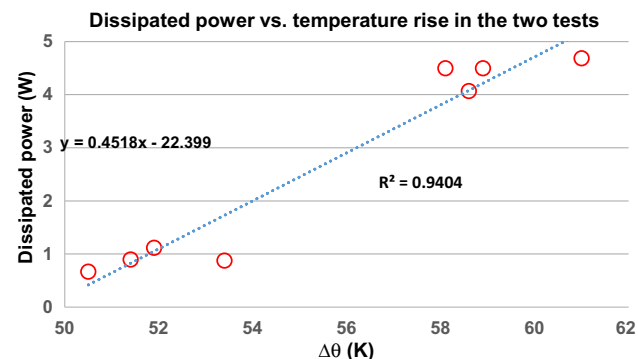
**Fig. 18** Dissipated power vs. the temperature rise by the lugs at the contactor terminals in the two temperature rise tests

dissipated power of the lugs as reference for their replacement could be added.

Funding Open access funding provided by Istituto Nazionale di Ricerca Metrologica within the CRUI-CARE Agreement.

Open Access This article is licensed under a Creative Commons Attribution 4.0 International License, which permits use, sharing, adaptation, distribution and reproduction in any medium or format, as long as you give appropriate credit to the original author(s) and the source, provide a link to the Creative Commons licence, and indicate if changes were made. The images or other third party material in this article are included in the article's Creative Commons licence, unless indicated otherwise in a credit line to the material. If material is not

included in the article's Creative Commons licence and your intended use is not permitted by statutory regulation or exceeds the permitted use, you will need to obtain permission directly from the copyright holder. To view a copy of this licence, visit <http://creativecommons.org/licenses/by/4.0/>.

References

- [1] IEC 60947-4-1:2018 Low-voltage switchgear switchgear and controlgear—Part 4-1: contactors and motor-starters - Electromechanical contactors and motor-starters Ed. 1.0.
- [2] IEC 61439-1 Low-voltage switchgear and controlgear assemblies—Part 1: General rules Ed. 3.0 2020.
- [3] ISO IEC 61238-1: 2004 Compression and mechanical connectors for power cables for rated voltages up to 36 kV ($Um = 42$ kV), Part 1: Test methods and requirements Ed. 1.0.
- [4] P.E. Roccatto, L. Bellavia, F. Galliana, P.P. Capra and A. Perta, Dependency of the Electrical Resistance in crimped connections on mechanical stresses. Engineering Research Express, 2 (2020) 035002.
- [5] Molex, Quality Crimp Handbook Rev.C, Release Date: 09-04-03, (2009) <https://media.digikey.com/pdf/data%20sheets/molex%20pdfs/quality%20crimp%20handbook.pdf>.
- [6] F. D. Cottrell, T. E. Kirejczyk, Crimp connection reliability Final technical rept. Sep 76-Sep 77, (1978). <https://apps.dtic.mil/sti/citations/ADA050505>.
- [7] R. M. M. Mohd, S. A. H. Huzainie, and B. A. G. Ahmad, A study of cable crimping factors affecting contact resistance of medium voltage cable ferrule and lug, 22nd Int. Conf. Electricity Distribution, Stockholm (2013) paper no. 1017.
- [8] JCGM 100:2008 Evaluation of measurement data - Guide to the expression of uncertainty in measurement First edition.
- [9] M. Finc, T. Kek, J. Grum, Use of thermography and ultrasonic inspection for evaluation of crimped wire connection quality, 18th World Conf. on Non-destr. Test. Durban, South Africa (2012) 1–10.
- [10] K. E. Cramer, D. F. Perey, W. T. Yost, Wire crimp connectors verification using ultrasonic inspection, IV Conferencia Panamericana de END Buenos Aires, 2007.
- [11] R. Holm, Holm, J. B. P. Else Williamson (ed.). Electric contacts: theory and application (reprint of 4th revised ed.). Berlin: Springer. ISBN 3-540-03875-2. SELIBR 5362583. (NB. A rewrite of the earlier "Electric Contacts Handbook"), (1979) [1967].
- [12] G. A. Cividjian, C. F. Ocoleanu, G. Manolea, Current distribution in crimped connections, Appl. Theor. Elec. (ICATE) 2t. Conf. on, Craiova, Romania (2014) 23–25.

- [13] D. Fournier (1998) Aging of defective electrical joints in underground power distribution systems 44th IEEE Holm Conf. on Electric. Contacts (2003) 179–192.
- [14] P.E. Roccatò, L. Bellavia, P.P. Capra, L. Cinnirella, F. Galliana and A. Perta, Influence of crimped connections in temperature rise tests. *Meas. Sci. Technol.*, 31 (2020) 1–6.
- [15] D. R. Liu, T. Bracket, S. McCarthy, Contact resistance comparison of good and bad crimp joints with tinned wires under thermal shock, Proc. 47th IEEE Holm Conf. Elec.Cont. Montreal, QC, Canada (2001) 35–43.
- [16] R. Liu, C. E. Heaton, “Failure Analysis of the Electric Crimp Joint on a Harness in an Automotive Environment,” SAE Technical Paper 2002-01-1054, (2002). <https://doi.org/10.4271/2002-01-1054>
- [17] IEC 60947-4-1:2020 Low-voltage switchgear and controlgear—Part 1: General rules.

Publisher’s Note Springer Nature remains neutral with regard to jurisdictional claims in published maps and institutional affiliations.