

Rapid prototyping of FBG-based optical sensors for vibration analysis of mechatronic systems

Original

Rapid prototyping of FBG-based optical sensors for vibration analysis of mechatronic systems / Dalla Vedova, M. D. L.; Quattrocchi, Gaetano; Aimasso, Alessandro; Marotta, Antonio; Ferro, C. G.; Maggiore, P.. - In: JOURNAL OF PHYSICS. CONFERENCE SERIES. - ISSN 1742-6588. - ELETTRONICO. - 2698:(2024). (Intervento presentato al convegno 15th International AIVELA Conference on Vibration Measurements by Laser and Noncontact Techniques, AIVELA 2023 tenutosi a Milano nel 2023) [10.1088/1742-6596/2698/1/012004].

Availability:

This version is available at: 11583/2991499 since: 2024-08-05T14:32:42Z

Publisher:

Institute of Physics

Published

DOI:10.1088/1742-6596/2698/1/012004

Terms of use:

This article is made available under terms and conditions as specified in the corresponding bibliographic description in the repository

Publisher copyright

(Article begins on next page)

Rapid prototyping of FBG-based optical sensors for vibration analysis of mechatronic systems

Matteo D L Dalla Vedova , Gaetano Quattrocchi , Alessandro Aimasso ,
Antonio Marotta , Carlo G Ferro , and Paolo Maggiore 

Dept. of Mechanical and Aerospace Engineering, Politecnico di Torino, Torino, Italy

matteo.dallavedova@polito.it

Abstract. The detection and study of vibrations play a fundamental role in the monitoring and safety of engineering systems. This is especially true in the aerospace sector, where the operating environment is often hostile, and the constraints on weights and dimensions are very tight. For these reasons, the research and application of sensors based on optical signal transmission are becoming increasingly important. The opportunity to implement distributed measurements along a single optical fiber, the small size and weight, and the high resistance to electromagnetic interference make this technology an ideal candidate for the development of next-generation aerial platforms. In this paper, the authors focus on designing and developing a novel sensor that employs Fiber Bragg Grating (FBG) for vibration detection. Their primary aim is to explore the potential and constraints of this technology and build an initial prototype for testing purposes. Additionally, the project enabled the authors to experiment with rapid prototyping techniques that rely on 3D printing and additive manufacturing. The impact of various design choices, such as materials, geometry, and manufacturing, on the demonstrator sensitivity was explored by analysing the problem mathematically. A Matlab script was developed to estimate dimensions, weights, and dynamic performances, and modelling FEM was used for validation.

1. Introduction

Vibration measurement is critical to modern engineering systems, representing a possible way to promptly identify potential criticalities and, therefore, ensure their safety and proper functioning. In most cases, abnormal behavior or damage in these systems results in unwanted vibrations, which can be used as an alarm bell or diagnostic tool. Nowhere is this more critical than in the aerospace sector, often characterized by harsh environmental conditions, and the constraints imposed on factors like weight and dimensions are exceedingly stringent. For this reason, the sensors used in onboard applications provide monitoring of a component's state of health, preventing the occurrence of faults. The typical architectures used in these areas are based on capacitive or piezoelectric technology. Although inexpensive and generally very accurate, these technologies cannot cope with the most extreme operating environments where external electromagnetic interference is present, and furthermore, distributed measurement is impossible. Given these demanding challenges, using sensors based on optical signal transmission is emerging as a more pivotal pursuit, and implementing FBG sensors is becoming increasingly popular in this field. What distinguishes these types of optical signal-based sensors, often defined FOVSs (i.e. Fiber Optical Vibration Sensors), are their remarkable capabilities, including the ability to conduct distributed measurements along a single optical fiber [1].

These sensors are characterized by their compact size and minimal weight and possess an enviable resistance to electromagnetic interference. These attributes collectively render this technology an up-and-coming candidate for propelling the advancement of next-generation aerial platforms.

FOVSS can be classified on the base of the principle of demodulation they use:

- Intensity demodulation-based: characterized by low cost and high bandwidth but is plagued by high measurement instability due to fiber bending and power fluctuations.
- Interferometric demodulation-based: can provide accurate and stable measurements but has bandwidth limitations, making measurement operations expensive and complicated.
- Wavelength demodulation-based: this is the operating principle of FBG-based FOVS and is characterized by the ability to obtain distributed measurements and being intrinsically resistant to light intensity fluctuations and losses due to fiber bending.

It is no coincidence that the latter has received the most attention in recent years, covering as much as 65% of all the literature on FOVS within the Academic Web of Science database [2]. As shown by equation (2), the FBG can sense axial stress along its length, which is why supports are required to convert the vibration signal into the axial deformation of the fiber. Typically, in a preliminary approach, support and fiber can be modeled as a mass-spring-damping system from which one can obtain the sensor's performance and related range of applications. These values are extremely sensitive to the type of bonding used, which plays a fundamental role in defining the sensor's measurement range, i.e., in determining a working zone where no signal distortion occurs [3-6]. In this work, the authors focus on developing an innovative sensor that harnesses the potentialities of Fiber Bragg Grating (FBG) to detect vibrations with suitable accuracy. The primary objective of their undertaking is the exploration of both the untapped potential and the limitations inherent in this cutting-edge technology. Concomitantly, the authors developed an initial prototype of this sensor, which is a critical step in evaluating its real-world applicability and efficacy. Furthermore, this project has allowed the authors to experiment with and assimilate rapid prototyping techniques, specifically those underpinned by 3D printing and additive manufacturing. This activity, concerning materials selection, geometric considerations, and manufacturing processes, has been performed by mathematical analysis to probe how design influences sensor sensitivity. A dedicated Matlab script has been crafted to facilitate this investigation, providing a tool for estimating crucial parameters such as dimensions, weight, and dynamic performance. In addition, Finite Element Method (FEM) modeling has been employed to validate their mathematical analysis outcomes, thereby ensuring the robustness of their findings.

2. Optical fiber and FBG sensors

Optical fiber is a composite material consisting of glass and polymer, with the unique ability to transmit light signals internally. This fiber possesses a cylindrical structure comprising distinct concentric layers, namely, the core, cladding, and an outer coating, in that order from the innermost to the outermost layer. The core and cladding, both composed of glass, play pivotal roles in facilitating the fiber's proper function. When light encounters the boundary between these two layers, it undergoes total internal reflection, thus remaining confined within the core and effectively transmitting information along the fiber's axis. To safeguard the fragile glass layers, an additional external coating is applied when needed, and further layers can be added if required [7]. As anticipated in chapter 1, FBG sensors offer substantial benefits for enhancing prognostic and diagnostic processes related to safety-critical components, and by extension, system health monitoring. These advantages stem from the inherent physical properties of optical fibers. Optical fibers ensure minimal invasiveness and exceptional lightweight characteristics, resulting in weight savings and the ability to instrument even remote or hard-to-reach areas. Most significantly, optical fibers exhibit immunity to electromagnetic interference, thereby eliminating concerns related to electromagnetic compatibility. Furthermore, optical fibers' electrical passivity and chemical inertness eliminate the risk of spark generation or potential fire hazards [8]. FBG sensors are created by introducing a periodic modulation of the core's refractive index within a section of optical fiber through laser-induced incisions. This process gives rise to a structure known as a Bragg grating.

Bragg gratings serve as selective frequency mirrors, reflecting a specific frequency within the electromagnetic spectrum while allowing all other frequencies to pass through. The reflected frequency, referred to as the Bragg frequency, represents the optical output of the sensor. This value, expressed in terms of wavelength, is directly proportional to the sensor's geometry. Consequently, it becomes possible to establish a correlation between a specific physical deformation applied to the fiber and the corresponding variation in the physical parameter acting upon it.

$$\lambda_B = 2n_{eff}\Lambda \quad (1)$$

The functionality of FBGs relies on the principle of Fresnel reflection [8], allowing for the creation of temperature and strain sensors. The mechanical deformation, $\Delta\varepsilon$, and temperature variation, ΔT , impact both the effective refractive index and the axial pitch of the fiber, resulting in a modification of the reflected wavelength. The change in the reflected wavelength, $\Delta\lambda_B$, can be expressed as follows:

$$\Delta\lambda_B = \lambda_B(1 + p_E)\Delta\varepsilon + \lambda_B(\alpha_\Lambda + \alpha_n)\Delta T \quad (2)$$

where, according to [9-10]:

- λ_B nominal reflected wavelength;
- p_E strain-optic coefficient of the fiber;
- $\Delta\varepsilon$ variation of fiber strain;
- α_Λ thermal expansion coefficient of the fiber;
- α_n thermo-optic coefficient of the fiber;
- ΔT variation of the local temperature.

If the local temperature remains constant (or its variation is negligible), then it can be assumed that the Bragg wavelength variation is solely due to the local deformation of the structure. This means it's possible to create an optical vibration sensor by engineering the FBG support to be sensitive to accelerations caused by mechanical vibrations induced locally.

3. Fiber Optical Vibration Sensors architecture

In recent years, the development of these types of optical sensors has led to numerous proposals for FBG-based vibration sensors. Depending on how vibration and fiber strain are linked, it is possible to identify three different architectures, namely pasted FBG-based [12-13], axial property of FBG-based [14-15], and transverse property of FBG-based [16-17]. In the pasted type, the sensor converts the vibration into the deformation of the elastic support, which, through adhesive, is transmitted to the FBG. This is probably the most used type, as it is characterized by a simple mathematical model and an easy-to-build support structure, usually a single component such as a cantilever beam that can be easily realized in 3D, thus making prototyping immediate. The most significant difficulties are encountered in the realization of the bonding and in determining its properties. It isn't easy to estimate the load transfer factor, which depends not only on the type of glue used but also on the environmental conditions, the aging of materials and the bonding geometry.

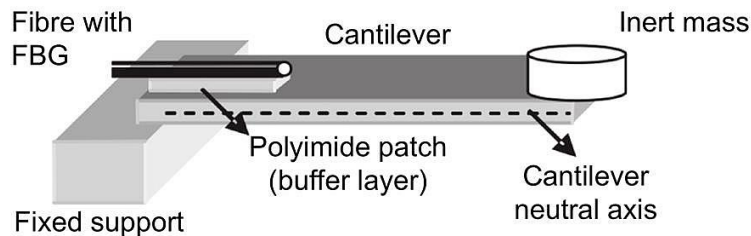

Figure 1. Pasted FBG-based solution.

The goal is to develop a workable design, evaluate its effectiveness, and build a mathematical model to predict its behavior, resulting in a tool that can be tested in the lab. That is why it's crucial to identify and justify the most demanding requirements that dictate many solutions implemented.

The first constraint considered is that of dimensions, which must be very small; the sensor must be capable of measuring the vibrations of the main mechanical components within an aerospace system where size and weight play a crucial role. In addition, it must be characterized by a suitable level of sensitivity. The support should be characterized by a resonance frequency of 200 [Hz] or more to guarantee a correct measurement of the most frequent vibrations within the main mechanical parts. It must also be able to avoid the occurrence of the Chirping phenomenon [18] and, as far as possible, compensate for the effect of temperature on the measurement [19]. Furthermore, obtaining a design characterized by a few parts and easily realized with the tools available is desired; its realization must be quickly and easily modified according to the experimental results, using a 3D printer.

3.1. FOVS support modelling

The proposed sensor is obtained by pasting FBGs on an adequately designed cantilever-type beam. The latter at the extremity features a lumped mass, while the fiber is fixed by gluing it to the surface of the support. When the assembly is subjected to vibrations, the mass imposes an inertial load of modulus $F = ma$ on the cantilever beam. The bending thus generated causes compression or tensile deformation of the part then transferred, with an appropriate reduction factor due to bonding, to the fiber. This is then picked up as a Bragg Wavelength variation by the detector and subsequently correlated to the acceleration value to which it has been subjected. Using support based on the cantilever beam simplifies the problem considerably, as it is characterized by simple geometries and characteristic equations. The related beam model is based on the Euler-Bernoulli theory and aims to obtain an equal-strength cantilever beam, i.e. which has equal strength in each of its sections (to limit the chirping phenomenon). This design allows constant deformations on the support surfaces and thus avoids non-uniform deformations of the Bragg grating. The abovementioned sensor geometry has been characterized by introducing the constitutive equations and verifying its properties. Using the data provided by the Matlab script, the related geometry has been created using Solidworks (Fig. 2). These CAD files are subsequently exported in STEP AP 203 format for verification through finite element analysis. This analysis, performed by Hypermesh 2021 and Optistruct solver, aims to verify the support natural frequencies and the deformation range of the surfaces.

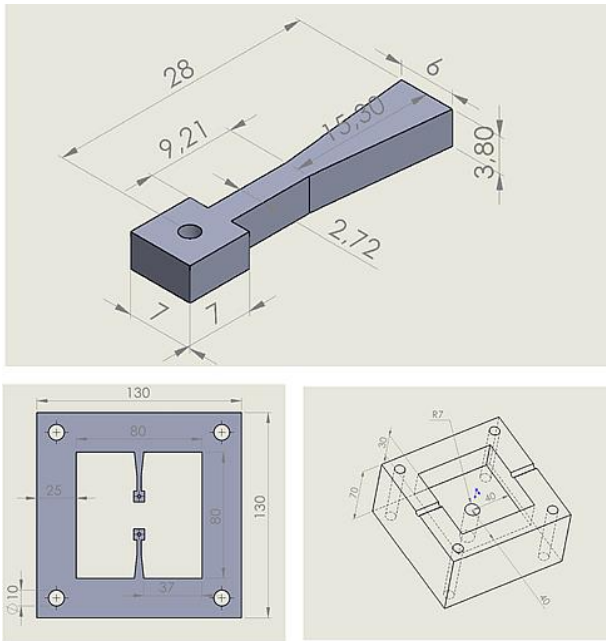

Figure 2. Schematic of cantilever beam (up), sensor mid support (lower left), base support (lower right).

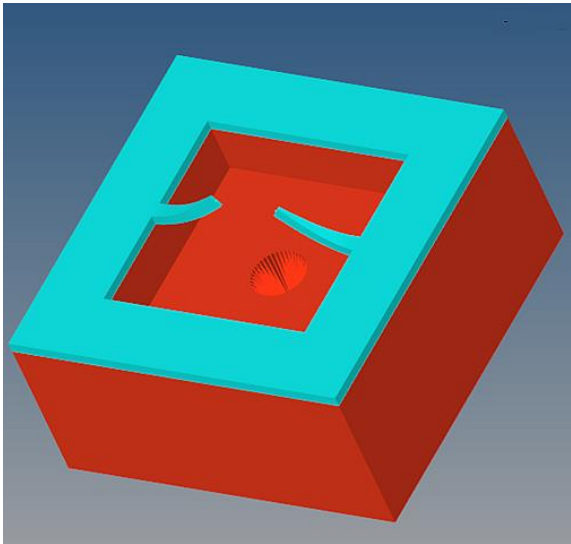

Figure 3. Solidworks axonometric sketch of the dynamic response of the proposed sensor.

Static analysis is conducted to visualize the compressive and tensile deformations due to bending using a step load of type linear static. Figure 4 shows a large area characterized by constant deformation, confirming the effectiveness of the equal-strength geometry.

4. Test Settings and Experimental Results

The performance of the proposed sensor has been tested using a dedicated experimental test bench. The vibrational inputs are developed by a Function Generator (controlling the shape and frequency of these signals). They are supplied by a mechanical shaker driving the linear oscillatory motion in the direction of interest (i.e. the vertical axe of the shaker depicted in Figure 4).

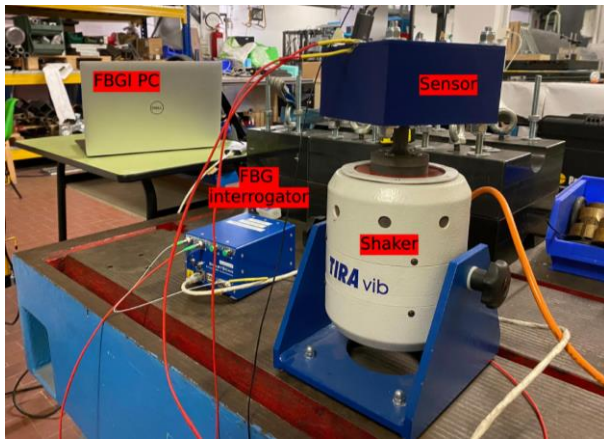

Figure 4. Experimental FOVS test bench.

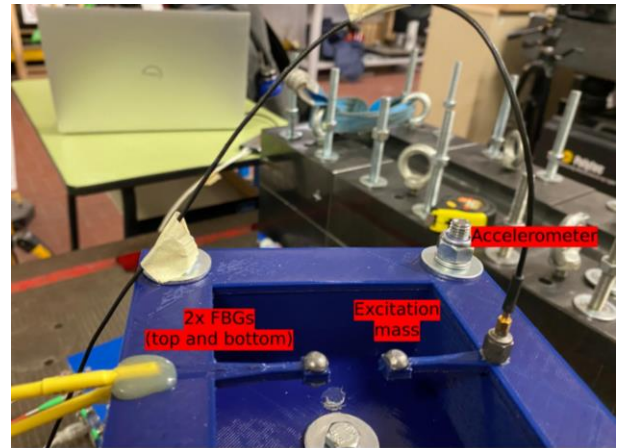

Figure 5. Detail of the proposed FBG sensors

The SmartScan FBG interrogator is managed via dedicated software (i.e. SmartSoft provided by Smart Fibres Ltd) and generates/acquires the optical signals feeding FBGs. In the considered layout, the FBG interrogator has a dedicated channel for each sensor and has the following features:

Table 1. SmartScan FBG Interrogator data sheet

Wavelength range	40 [nm] (1528-1568 [nm])
N° of optical channel	4
Maximum scan frequency	25 [KHz]
Repeatability]	< 1 [pm]
Dynamic range	37 [dB]
Dimensions	140x115x85 [mm]
Weight	0.9 [Kg]

The proposed FBG sensors are positioned on the cantilevers realized in the middle shell, as shown in Figure 5. The geometry of this support is designed to simplify printing operations, and it is symmetric to ensure dynamic stability during sollicitation and provide the possibility of multiple readings with different bonding and mass parameters. Two calibrated masses are positioned on the two ends of the cantilever beams. They are used to modulate the overall inertia of the two sensitive elements and the relative resonance frequency. A hole is inserted in middle shell as a housing for mounting an accelerometer. This is required to compare the acceleration value measured by the optical device. The lower shell (Figs. 3, 4 and 5) connects the sensors with the assembly of the mechanical shaker and transmits the vibrational inputs. The top part (or upper shell) of the prototype, not present in Figs. 5 and 6, is a casing protecting FBGs and ensuring free flexural movement of the support.

5. Preliminary experimental results

Several experimental tests have been performed to evaluate the performance of the proposed sensor and its compliance with the dynamic characteristics specified during the design phases. Acceleration data are collected for all the tests performed, both for constant sinusoidal excitation and constant amplitude chirps, which are helpful for structure characterization.

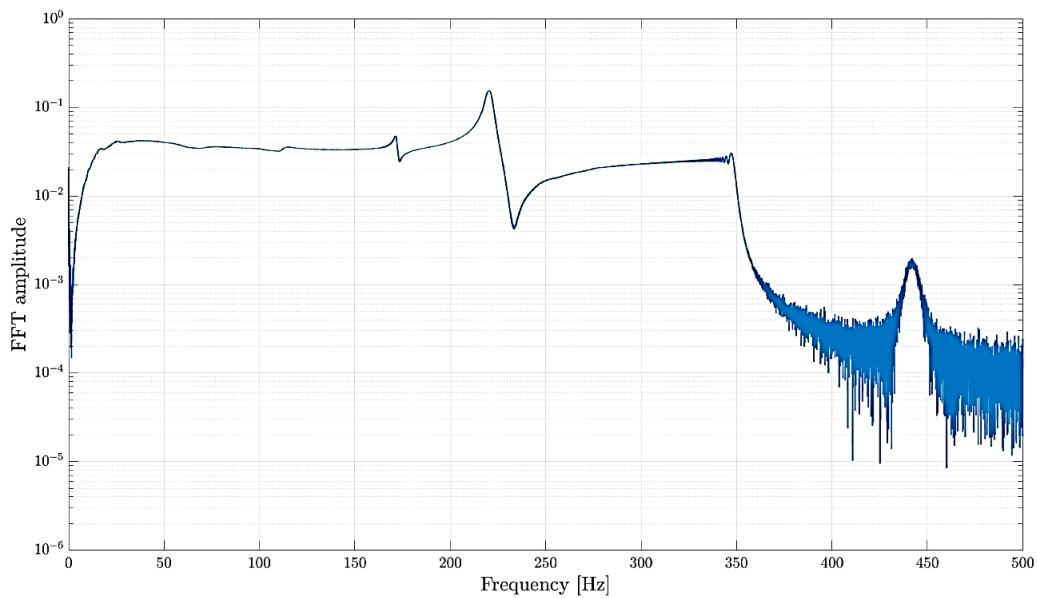

Figure 6. Dynamic response of the FOVS support (0-350 Hz, 1 V)

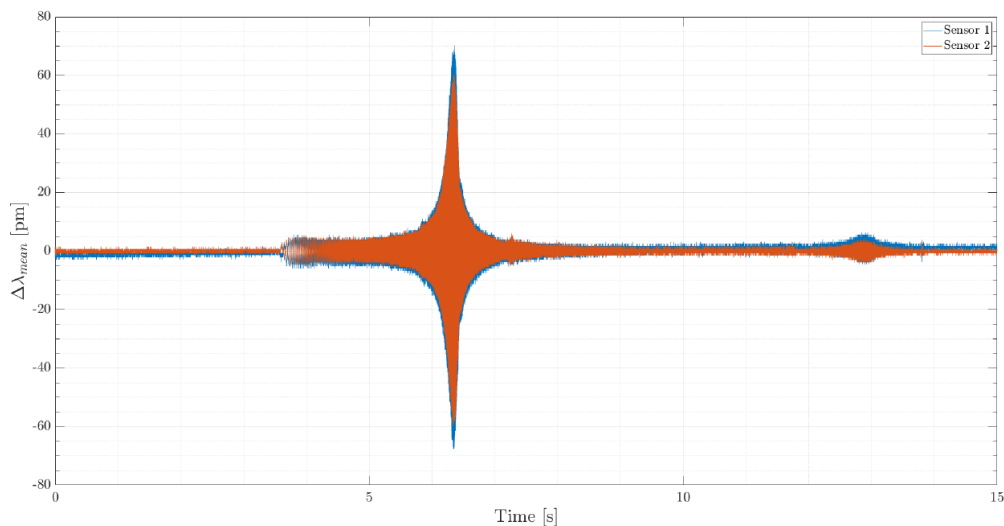

Figure 7. Response of the FOVS sensor to a chirp input (0-350 Hz, 1 V)

Figure 6 shows the Fast Fourier Transform (FFT) of the dynamic response of the sensor generated by a constant amplitude chirp between 0 and 350 Hz; it should be noted that such an FFT graph is referred to the same test shown - in terms of time response - in Figure 7.

The first support natural frequency is readily detectable at 220 Hz, and also the first harmonics at 440 Hz, even though that frequency is not directly excited. It should be noted that a minor resonance is also observable at 170 Hz and will need further investigation. It should be noted that the response is almost constant between 15 and 200 Hz. This behavior, expressly aimed by the authors when defining the design of the sensor, represents an advantage because it helps to characterize the cantilever while minimizing the influence of the support. In Figure 7 is reported the time response acquired by the FBG sensors under the same input conditions. The effect of the support dynamics is very modest; in fact, the two resonances at 170 Hz and 220 Hz can be detected but do not provide significant alteration of the FBGs readings. For each measure, the minimum detectable acceleration is also calculated, by setting the Bragg wavelength variation as the minimum, repeatable measure that FBGs can elaborate (1 pm).

6. Conclusions

This work illustrates the preliminary phases of the research carried out by the authors to define a practical, effective, and reliable approach to conceive, design, build, and experimentally test an innovative uniaxial optical sensor suitable for measuring vibrations in an aerospace environment. It can be observed that the sensitivity is almost constant in the range of interest, i.e. for frequencies lower than 200 Hz. On the other hand, when the excitation frequency approaches the natural frequency, a sharp increase in sensitivity can be observed. This behavior can be easily explained by the natural amplification provided by the cantilever which significantly increases the oscillation amplitude and thus the strain applied to the FBGs. This multidimensional investigation is encouraging for our research and represents a step forward in vibration detection and its practical applications in aerospace engineering. However, it should be noted that this work concerns a preliminary series of tests and other testing campaigns will need to be performed to completely characterize the effect of the support and the response curve of the cantilever. In fact, some experimental outcomes are still relatively far from the theoretical ones, and, therefore, the cause will need to be investigated.

Acknowledgments

All the authors would like to thank the Interdepartmental Center for Photonic Technologies (PhotoNext) of the Politecnico di Torino and the LINKS Foundation for their precious support.

References

- [1] Behbahani A, Pakmehr M and Stange W A 2020 Optical Communications and Sensing for Avionics *Springer Handbook of Optical Networks* (Springer) pp. 1125–1150
- [2] Tianliang L, Jinxiu G, Yuegang T and Zude Z 2020 Recent advances and tendency in fiber Bragg grating-based vibration sensor: A review *IEEE Sensors Journal* pp. 12074–12087
- [3] Berri P C, Dalla Vedova M D L, Maggiore P and Scolpito T 2019 Feasibility study of FBG-based sensors for prognostics in aerospace applications *Journal of Physics: Conference Series* vol 1249(1) n 012015
- [4] Dalla Vedova M D L, Berri P C, Maggiore P and Quattrocchi G 2020 Design and development of innovative FBG-based fiber optic sensors for aerospace applications *Journal of Physics: Conference Series* vol 1589(1) n 012012
- [5] Aimasso A., Dalla Vedova M D L, Maggiore P and Quattrocchi G 2022 Study of FBG-Based Optical Sensors for Thermal Measurements in Aerospace Applications *Journal of Physics: Conference Series* vol 2293
- [6] Aimasso A., Dalla Vedova M D L and Maggiore P 2022 Analysis of FBG Sensors Performances When Integrated Using Different Methods for Health and Structural Monitoring in Aerospace Applications *6th International Conference on System Reliability and Safety (ICSRS 2022)* pp. 138–144
- [7] Kasap Safa 2001 *Optoelectronics and Photonics : Principles and Practices* (Prentice Hall)
- [8] Ahuja D and D Parande 2012 Optical sensors and their applications *Journal of Scientific Research and Reviews* vol 1(5)

- [9] Jones K 2018 Temperature compensation of FBG strain sensors *Smart Fibres Ltd, Notes 04*
- [10] Santos J L and Farahi F 2018 *Handbook of Optical Sensors* (CRC Press)
- [11] Mihailov S J 2012 Fiber Bragg Grating Sensors for Harsh Environments *Sensors* vol 12 pp 1898–1918
- [12] Guang C, Keqin D, Qibo F, Xinran Y and Fangxiong T 2019 Strain transfer mechanism of grating ends fiber Bragg grating for structural health monitoring *Structural Durability & Health Monitoring* 13(3) p 289
- [13] Liang F, Tao C, Ruiya L and Shihua L 2016 Application of embedded fiber Bragg grating (FBG) sensors in monitoring health to 3D printing structures *IEEE Sensors Journal* vol 16(17) pp 6604–6610
- [14] Tianliang L, Yuegang T, Yi L, Yongzhi Q, Mingyao L and Zude Z 2015 A fiber Bragg grating sensing based triaxial vibration sensor *Sensors* vol 15(9) pp 24214–24229
- [15] Dakuan Y, Xueguang Q, Xiangyu W and Jianlin Z 2019 Study on a fiber Bragg grating accelerometer based on push-pull compliant cylinders *Eleventh International Conference on Information Optics and Photonics (CIOP 2019)* vol. 11209 pp 547–555
- [16] Kuo L, Chan T H T, Man Hong Yau, Thambiratnam D P and Hwa Yaw Tam 2014 Experimental verification of the modified spring-mass theory of fiber Bragg grating accelerometers using transverse forces *Applied Optics* vol 53(6) pp 1200–1211
- [17] Tianliang L, Chaoyang S, Yuegang T, Ruiya L, Zude Z and Hongliang R 2016 A diaphragm type fiber Bragg grating vibration sensor based on transverse property of optical fiber with temperature compensation *IEEE Sensors Journal* vol 17(4) pp 1021–1029
- [18] Bonopera M 2022 Fiber-Bragg-Grating-Based Displacement Sensors: Review of Recent Advances" *Materials* vol 15(16) n 5561
- [19] Brusa E, Dalla Vedova M D L, Giorio L and Maggiore P 2021 Thermal condition monitoring of large smart bearing through fiber optic sensors *Mechanics of Advanced Materials and Structures* vol 28(11) pp. 1187–1193