

In-vivo proximal monitoring system for plant water stress and biological activity based on stem electrical impedance

*Original*

In-vivo proximal monitoring system for plant water stress and biological activity based on stem electrical impedance / Calvo, Stefano; Barezzi, Mattia; Demarchi, Danilo; Garlando, Umberto. - ELETTRONICO. - (2023), pp. 80-85. (Intervento presentato al convegno 2023 9th International Workshop on Advances in Sensors and Interfaces (IWASI) tenutosi a Monopoli (Bari), Italy nel 08-09 June 2023) [10.1109/IWASI58316.2023.10164553].

*Availability:*

This version is available at: 11583/2980510 since: 2023-07-24T12:44:32Z

*Publisher:*

IEEE

*Published*

DOI:10.1109/IWASI58316.2023.10164553

*Terms of use:*

This article is made available under terms and conditions as specified in the corresponding bibliographic description in the repository

*Publisher copyright*

IEEE postprint/Author's Accepted Manuscript

©2023 IEEE. Personal use of this material is permitted. Permission from IEEE must be obtained for all other uses, in any current or future media, including reprinting/republishing this material for advertising or promotional purposes, creating new collecting works, for resale or lists, or reuse of any copyrighted component of this work in other works.

(Article begins on next page)

# In-vivo proximal monitoring system for plant water stress and biological activity based on stem electrical impedance

Stefano Calvo\*, Mattia Barezzi\*, Danilo Demarchi\*, and Umberto Garlando\*

\*Department of Electronics and Telecommunications, Politecnico di Torino, Torino, Italy

Email: stefano.calvo@polito.it

**Abstract**—Population growth and global warming are the main threats to food production. Food security, producing enough food for the entire population, is becoming harder, and new strategies must be applied. Smart agriculture tackles this problem by integrating field sensors and data with the farmers’ knowledge to increase crop yield and reduce resource waste.

This paper proposes a system to monitor the plant water stress status. This system monitors the plant directly and does not rely on environmental sensors. Acquired data are sent to a remote server thanks to LoRa communication. The designed system is low-power and relies on a single battery with more than five years of expected lifetime. The system monitors the trunk electrical impedance of plants thanks to a relaxation oscillator with a portion of the trunk in the feedback loop. This way, changes in the impedance are reflected in changes in the oscillator frequency.

Two systems were installed directly in the fields and connected to apple trees. Statistical analyses were performed on the acquired data. The correlation between the trunk frequency values and the soil water potential is above 75% for both plants.

The proposed system is low-power and low-cost and could be directly adopted in the fields. It can detect the water status of plants directly, avoiding environmental sensors.

**Index Terms**—Smart agriculture, water stress, stem electrical impedance, plants’ resilience

## I. INTRODUCTION

Feeding the entire world population has always been a challenging task to achieve. This task difficulty increased significantly in recent decades due to climate change and world population growth. A recent study estimates that the world population will reach 10 billion people within this century [1]. Moreover, anthropogenic climate change is dramatically reducing the amount of arable land all around the globe. A recent study claims that a territory equivalent to more than 15 times the extent of Italy has already been driven towards desertification [2]. Food production is one of the significant contributors to climate change. It is responsible for more than 25% of the global greenhouse gas (GHG) emissions and 70% of the total freshwater withdrawals [3], and its impact is destined to increase. Smart (or precision) Agriculture aims at reducing this impact and, at the same time, increasing yields. These two ambitious goals are usually pursued by monitoring the environment surrounding crops [4], [5]. Although this approach could provide valuable information regarding plants’ health status, it has been shown that this could deteriorate without a significant change in the environmental conditions [6]. Therefore, the attention focused on extracting information

from sensors placed directly on plants to gather more meaningful information [6]–[10].

Recently, researchers focused on plant stem (and trunk) electrical impedance. Analysis of plant stem electrical impedance can provide valuable information regarding its watering stress status since it is highly correlated to soil water potential (SWP) [6]. This latter parameter is widely employed to extract information regarding plants’ “thirst” [12], [13]. It estimates a plant’s effort to absorb water from the soil. Thus, it takes into account both soil texture and moisture. In-vivo analyses of stem electrical impedance carried out until now rely on complex, high-power, and time-consuming methodologies that involve expensive and hard-to-use bench instruments. Moreover, they were performed on trunk-less plants [6], [8], [9]. Therefore, these monitoring systems can not be deployed in an actual field where they have to be managed by inexperienced users (i.e., farmers) and are far from the power grid. This work presents a novel approach to achieve real-time and in-vivo sensing of crops’ watering stress status by indirectly measuring their stem electrical impedance. This goal was pursued with a simple, low-power, easy-to-use, easy-to-deploy sensor that can be easily integrated into a more comprehensive Wireless Sensor Network (WSN). The sensor presented in this work was tested on two apple trees growing inside two pots and placed in an actual field in Italy.

## II. EXPERIMENTAL SETUP

The system comprises a custom PCB and an off-the-shelf micro-controlling unit (MCU). A schematized depiction of the implemented system to read trunk impedance is depicted in fig.1 while the actual device is depicted in fig.2. The implemented MCU was an STM32WL55JC by ST Microelectronics mounted on a NUCLEO-STM32WL55JC1. It was chosen since it easily allows the implementation of LoRa [14] communication to send collected data to a base unit to perform both data storage and analysis. This communication protocol was exploited thanks to its reliability in sending and receiving data in long-range communications. Moreover, LoRa protocol implements an efficient power consumption adjustment depending on the distance between the transmitter and the receiver (gateway). This feature was crucial for achieving low power consumption. The custom PCB (mounted as a shield board on the NUCLEO) was designed to keep

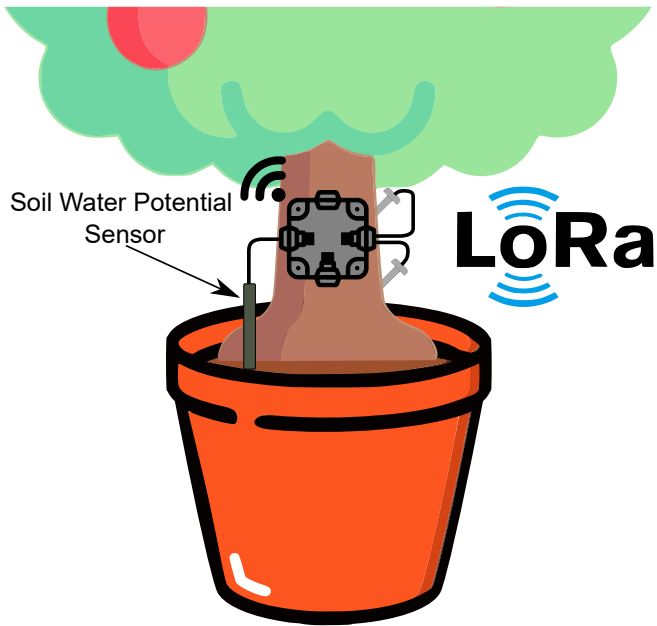

Fig. 1. Real implemented sensor schematized depiction.

the circuit complexity to a minimum and to achieve both the low-power consumption and low-maintenance features that smart agriculture applications require. Therefore it was equipped with a SAFT LS14500 battery to power the entire system, an ST Microelectronics STLQ020 voltage regulator, two Vishay SiP32431 pass transistors, and two Texas Instruments LMC555 timers used as relaxation oscillators. The whole system was encapsulated in an ENC-SW-8x5 box to prevent water infiltration. As depicted in fig.3, one LMC555 had a portion of the trunk in its feedback loop, allowing the system to perform indirect impedance analysis. In this way, its oscillating signal frequency (referred as trunk frequency) was inversely proportional to the trunk impedance modulus.

The connection between the integrated circuit and the plant was made thanks to the insertion of two stainless steel nails (used as electrodes) into the plant placed at a distance of about 5 cm as depicted in fig.1. These nails penetrated inside the trunk for a length of 1.5 cm to pierce the plant's inner vessels and limit the damage the electrodes' insertion could cause. Moreover, the electrode material was chosen to prevent oxidation and provide bio-compatibility. Since the LMC555 output signal is a square wave, it was directly fed to the MCU to read its frequency and send it to the closest gateway. Furthermore, the SWP was monitored thanks to an Irrrometer Watermark sensor. SWP was considered and used as a reference to evaluate the water stress status of the plants. This sensor is made of a porous piece of gypsum whose resistance depends on the soil water potential. Therefore, a readout circuit similar to the one exploited by authors in [6] was implemented in this work. The Watermark sensor was placed in the feedback loop of the other LMC555. Thus, its output signal frequency was related to the SWP condition. This signal was again fed to the MCU that read its frequency,

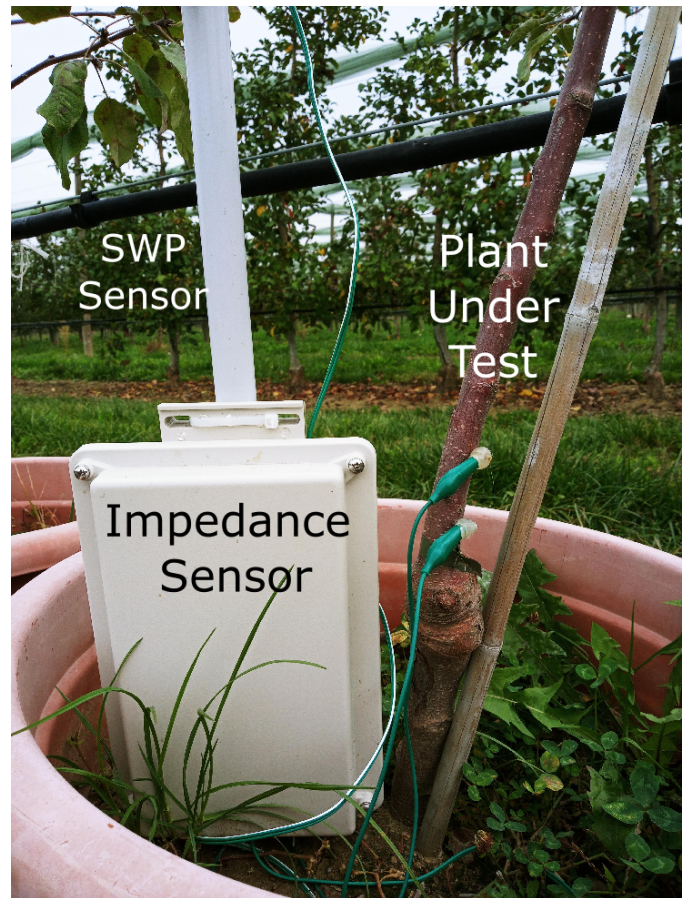

Fig. 2. Actual implemented device. This picture portrays the box containing the impedance sensor tied to the soil water potential sensor. This was done in the early stages because, as the picture shows, the apple tree's trunk was too thin to bear the weight. After a few weeks of growth, the device was hung to the tree as depicted in fig.1

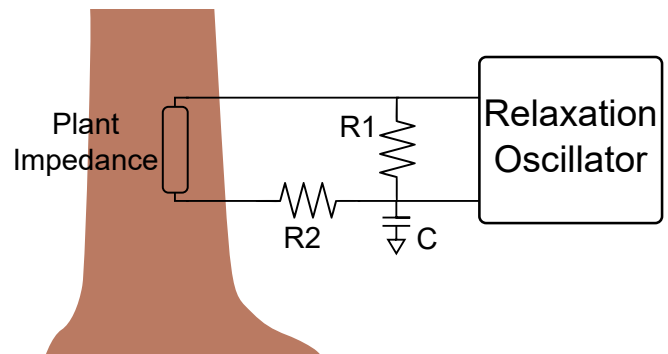

Fig. 3. Relaxation oscillator circuit. Resistances  $R_1$  and  $R_2$  together with the capacitor  $C$  limit the relaxation oscillator frequency to keep the MCU clock to a minimum, limiting the overall power consumption.

stored its value, and sent it. Since plants are living beings, their health status changes take time. Therefore, the elapsed time between two consecutive measurements was chosen to equal one hour. This way, energy consumption was kept to a minimum without affecting the monitoring accuracy. In fact, increasing measurement occurrences would not lead to much

more meaningful information, but it would affect the system estimated lifespan. Therefore, this choice offered a good trade-off between battery lifetime and information accuracy. The measurements' timing was achieved since the two pass transistors were employed to power gate the two LMC555. The MCU directly enabled the correct timer to perform the two measurements. The detailed measurements' timing is depicted in fig.4.

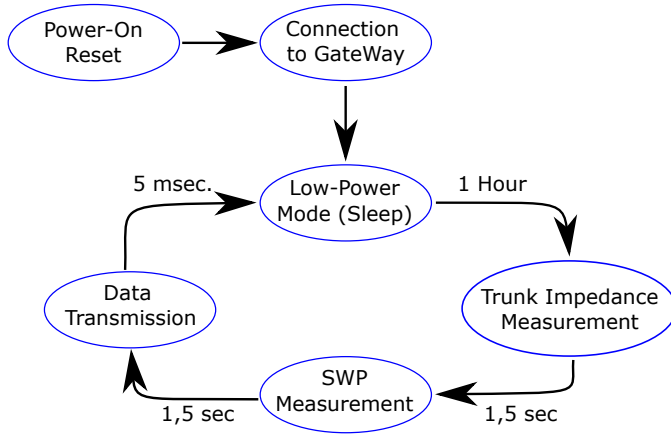

Fig. 4. Activation routine timing.

The described circuit, together with the measurement occurrences (one per hour), led to very low energy consumption compared to methodologies used up to now for trunks (or stem) impedance measurements. Similar approaches reported in [6], [8], [9] can not be compared with the proposed one in term of power consumption, since are based on bench instruments.

The whole system was powered by a regulated 3.3 V voltage, and its current consumption was:

- Less than  $2\mu\text{A}$  while the MCU was in the low-power mode, thus while measurements did not occur.
- Around  $5\text{ mA}$  while the system performed measurements that lasted  $3\text{ s}$  each one.
- Up to  $35\text{ mA}$  both to transmit data and connect to the closest gateway. Both these procedures took up to  $5\text{ ms}$  to complete.

Given this consumption, the expected lifetime of the system is more than five years.

### III. MEASUREMENTS AND RESULTS

Figs. 5, 6, 7, and 8 show the trunks frequencies for both trees during the data acquisition period.

Analyses were carried out in a field during late Summer, Autumn, and Winter (Northern Hemisphere). SWP increases correspond to rainy days or to watering events performed when needed. As expected, the trunk frequency's baseline varies among the two trees. Trunks frequencies showed maxima and minima that repeated daily. This behavior has already been noticed in tobacco stem impedances [6], [8]. Frequency maxima occurred during daytime, while minima at night. This behavior suggests that trunk impedance decreases when

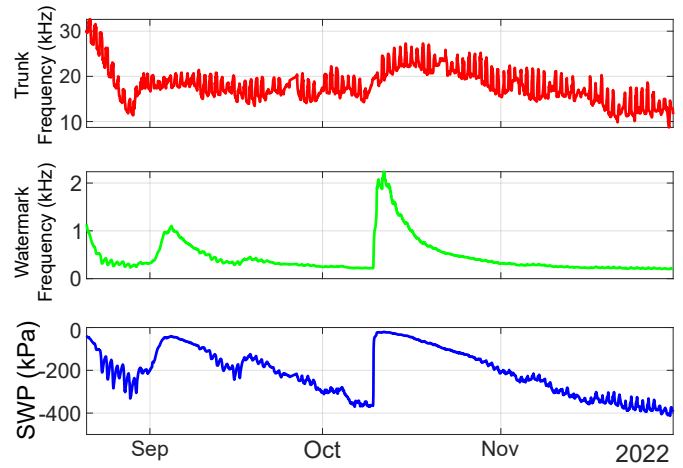

Fig. 5. Trunk frequency (red line), Watermark reading signal frequency (green line), and SWP evaluated for plant 1 during late summer and autumn.

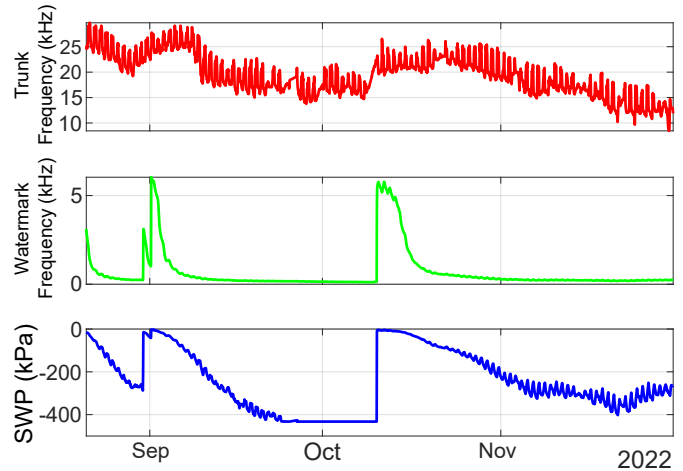

Fig. 6. Trunk frequency (red line), Watermark reading signal frequency (green line), and SWP evaluated for plant 2 during late summer and autumn.

photosynthesis occurs. Data have been divided into two sets to highlight that plants behave differently depending on the season. Furthermore, this split emphasizes that the trunk frequency behavior modifies in response to the change in biological activity that apple trees undergo during the cold season (winter) [16]. Figs. 5 and 6 represent data collected before the winter. They show that the SWP strongly influences trunk frequencies trends.

Rainy days and watering events are easily noticeable in these plots because they correspond to sharp increases in the SWP plot. During the warm season (summer and autumn), these events are followed by increased trunk frequency trends that occur with a certain delay. The two plant differ from each other mainly on the trunk frequency baseline. The reaction to watering events is very similar since it caused a relative trunk frequency increase with (almost) the same magnitude in both trees. The delay represents the time the tree needs to react to

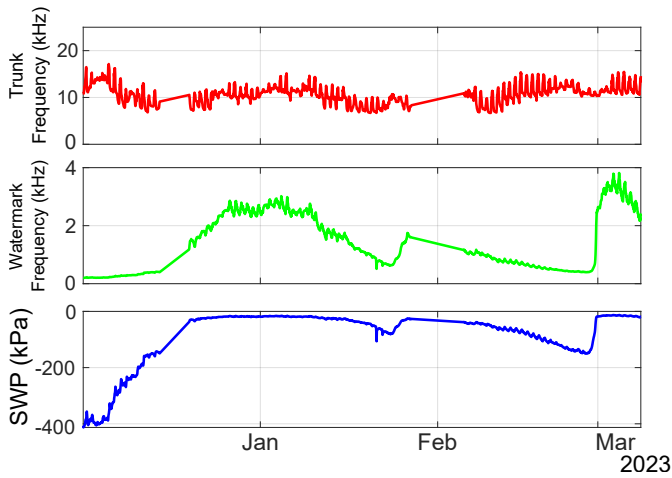

Fig. 7. Trunk frequency (red line), Watermark reading signal frequency (green line), and SWP evaluated for plant 1 during winter. The same y-axis range as figs.5 and 6 has been set to highlight trunk frequency's baseline drop and insensitivity to watering events.

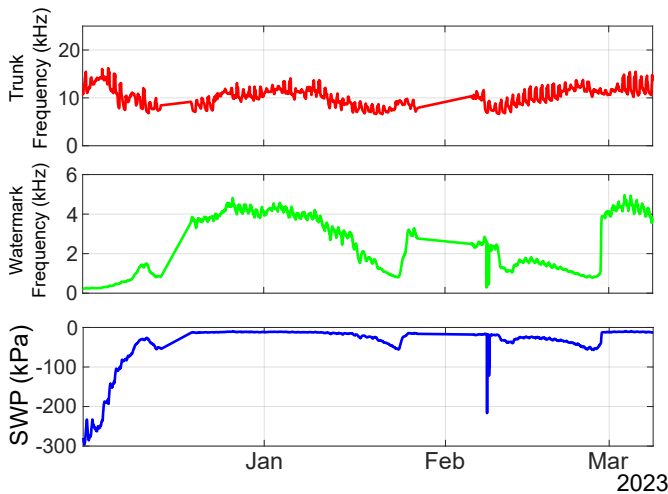

Fig. 8. Trunk frequency (red line), Watermark reading signal frequency (green line), and SWP evaluated for plant 2 during winter. Sharp decreases in SWP that occurred on February 8<sup>th</sup> are due to wrong sensors readings probably due to low temperatures. Therefore, these values have been discarded and compensated performing analysis. The same y-axis range as figs.5 and 6 has been set to highlight trunk frequency's baseline drop and insensitivity to watering events.

changes in external conditions. As figs. 7 and 8, a substantial non-reactivity towards watering events can be noticed during the cold season instead. This is particularly noticeable at the beginning of December. The increase that SWP faced was not followed by a substantial change in the trunk frequency trend. This behavior occurred for both trees.

For what concerns the warm season, trunk frequency trends increases are very easily noticeable in correspondence to the rain that occurred in mid-October: the most intense. This event caused a clear increase in both trunk frequencies trend. As stated before, this change took some time to occur. The increase that followed the watering event is about 30% for

both plants. This value is the relative increase that the trunk frequencies moving average underwent. This quantity is evaluated with a 24 samples lag (thus, one day) evaluated three days before and after the watering event. This choice focused on the long-term trunk frequency (and impedance) trend. Therefore, this manipulation allowed the smoothing of maxima and minima that trunk frequencies show daily.

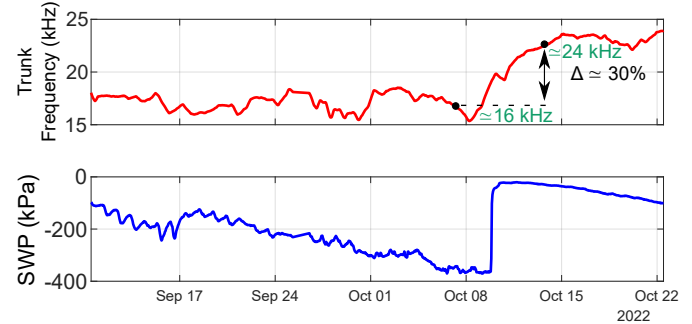

Fig. 9. Data relative to plant 1 focused on the rainy day that occurred on October 10<sup>th</sup>, thus during the warm season. The red line represents the trunk frequency moving average evaluated with a lag of 24 samples (one day). Watermark frequency has not been reported for clarity.

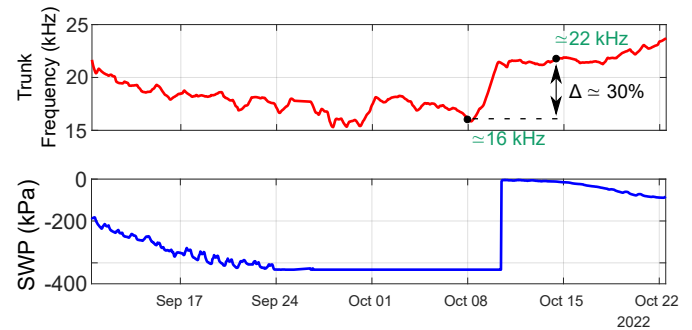

Fig. 10. Data relative to plant 2 focused on the rainy day that occurred on October 10<sup>th</sup>, thus during the warm season. The red line represents the trunk frequency moving average evaluated with a lag of 24 samples (one day). Watermark frequency has not been reported for clarity.

Specifically, trunk frequency related to plant 1 baseline, the approximate value around which daily cycles oscillate (evaluated with a moving average), increased from about 16 kHz to 24 kHz, while plant 2's one from about 16 kHz to 22 kHz. Figs. 7 and 8 represent data collected during winter. They do not show the same behavior. Both trunk frequencies significantly lowered their average values compared to the ones in the warm season, and their reactivity to watering events reduced considerably. In fig. 7, for example, SWP shows a sharp increase at the end of February that was not followed by a significant change in the trunk frequency. The two data sets (trunk frequency and SWP) seem uncorrelated. These behaviors have been highlighted in figs. 9, 10, and 11 where trunk frequencies moving averages and SWP around the rainy days have been reported. These figures clearly show that when the rainy day occurred in the cold season, it did not cause a change in the trunk frequency behavior. Its value did not



change significantly after the event. On the contrary, during the warm season, the rain caused a sharp rise for both plants.

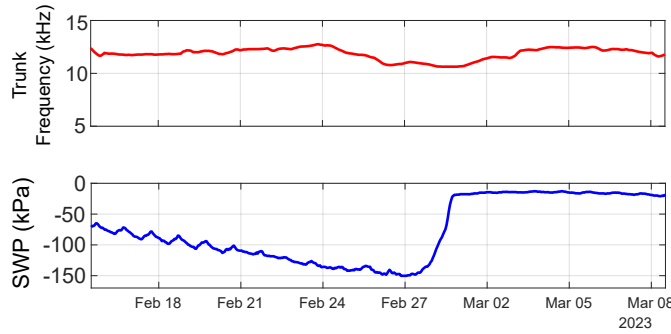

Fig. 11. Data relative to plant 1 focused on the rainy day that occurred on February 27<sup>th</sup>, thus during the cold season. The red line represents the trunk frequency moving average evaluated with a lag of 24 samples (one day). Watermark frequency has not been reported for clarity. The same y-axis range width (10 kHz) as in figs.9 and 10 has been used in the plots to show the trunk frequency response better. There is no significant change in the trunk frequency moving average trend.

#### IV. DATA ANALYSIS

Data sets presented in the previous section underwent a *Pearson's* correlation test. The test was done to understand the relationships among these quantities. Correlation coefficients (or p-values) range from -1 to 1, where -1 is the strongest negative correlation and 1 is the strongest positive. In tabs. I, III, II, and IV there are reported the p-values related to plant 1 and 2, respectively. Before performing *Pearson's* correlation tests, data were treated with a moving average with a lag equal to 24; therefore evaluated for 24 hours.

	<i>Trunk Frequency</i>	<i>SWP</i>
<i>Trunk Frequency</i>	1	0,75
<i>SWP</i>	0,75	1

TABLE I

CORRELATION COEFFICIENTS EVALUATED FOR PLANT 1 DURING THE SUMMER-AUTUMN PERIOD.

	<i>Trunk Frequency</i>	<i>SWP</i>
<i>Trunk Frequency</i>	1	0,79
<i>SWP</i>	0,79	1

TABLE II

CORRELATION COEFFICIENTS EVALUATED FOR PLANT 2 DURING THE SUMMER-AUTUMN PERIOD.

As already stated, this data manipulation allowed us to focus on the quantities' long-term behavior and smooth the oscillations that they undergo in the short term. This allowed us to not consider the daily maxima and minima that trunk frequencies show. Correlation tests performed and presented

in this section did not involve the Watermark frequency. The circuit setup and the resistive sensor characteristic ensure a cause-effect relation between SWP levels and Watermark frequency.

	<i>Trunk Frequency</i>	<i>SWP</i>
<i>Trunk Frequency</i>	1	0,01
<i>SWP</i>	0,01	1

TABLE III

CORRELATION COEFFICIENTS EVALUATED FOR PLANT 1 DURING THE WINTER PERIOD.

	<i>Trunk Frequency</i>	<i>SWP</i>
<i>Trunk Frequency</i>	1	0,17
<i>SWP</i>	0,17	1

TABLE IV

CORRELATION COEFFICIENTS EVALUATED FOR PLANT 2 DURING THE WINTER PERIOD.

	<i>Trunk Frequency</i>	<i>SWP</i>
<i>Trunk Frequency</i>	1	0,93
<i>SWP</i>	0,93	1

TABLE V

CORRELATION COEFFICIENTS EVALUATED FOR PLANT 2 DURING THE WARM SEASON FOCUSED AROUND THE WATERING EVENT OCCURRED ON OCTOBER 10<sup>TH</sup>.

P-values show that there is quite a strong correlation between SWP and trunk frequencies during the warm season. They are up to 0,79. Correlation between SWP and trunk frequency in the warm season is further inspected focusing on the period around a specific watering event, the one on October 10<sup>th</sup>. Table V shows correlation between the two quantities for plant 1 on a period of three days before and after the rain. Therefore, this choice allowed a better disentanglement of water stress's effect on trunk frequencies with respect to other parameters. The correlation coefficient raised up to 0,93 showing that, in the warm season, SWP and trunk frequency have a strong correlation. The same can be claimed regarding plant 2. P-values relative to the focus around the watering event are around 0,85. Correlation between SWP and trunk frequency almost vanishes when the test involved data collected during the cold season when apple trees enter dormancy [16]. These values show that it may be possible to the trunk frequency to understand plants' water stress when plants are biologically active. Moreover, it may provide valuable information regarding the biological activity itself.

## V. CONCLUSIONS

This work presented a simple method to sense trunk (or stem) electrical impedance using a purely digital circuit. This system is simple, easy to use, deployable in a field, compact, and very low-power. Trunk frequencies were sampled together with SWP, a widely employed parameter to assess plants' water stress status. Therefore, SWP was adopted to validate the system. Correlation tests performed on the two plants showed that trunk frequencies indicate water stress status during the seasons when the plant's biological activity reaches its peak. This paves the way for substituting complex and expensive SWP monitoring systems with cheap and simple ones. Moreover, these features offer the possibility to implement widespread SWP monitoring. This is a crucial goal to increase crops' resilience towards climate change effects. Moreover, since trunk frequencies showed a significant change in behavior during the cold season (thus, during the plant's dormancy period), it may be exploited to extract information regarding crops' biological activity. Further studies will be conducted to corroborate this hypothesis.

## REFERENCES

- [1] Roser, M. and Rod s-Guirao, L., "Future Population Growth", 2013, Our World in Data.
- [2] Burrell, A. L., J. P. Evans, and M. G. De Kauwe, "Anthropogenic climate change has driven over 5 million km<sup>2</sup> of drylands towards desertification.", *Nature communications* 11.1 (2020), 1-11.
- [3] Ritchie, H. and Roser, M., "Environmental Impacts of Food Production", *Our World in Data*, 2020.
- [4] Tenzin, S., Siyang, S., Pobkrut, T., and Kerdcharoen, T., "Low cost weather station for climate-smart agriculture", In 2017 9th international conference on knowledge and smart technology (KST) (pp. 172-177), IEEE.
- [5] Kasama, T., Koide, T., Bula, W. P., Yaji, Y., Endo, Y., and Miyake, R. (2019, March), "Low cost and robust field-deployable environmental sensor for smart agriculture", In 2019 2nd International Symposium on Devices, Circuits and Systems (ISDCS) (pp. 1-4), IEEE.
- [6] Garlando, U., Calvo, S., Barezzi, M., Sanginario, A., Ros, P. M., and Demarchi, D. (2022), "Ask the plants directly: Understanding plant needs using electrical impedance measurements", *Computers and Electronics in Agriculture*, 193, 106707.
- [7] V. Palazzari et al., "Leaf compatible "eco-friendly" temperature sensor clip for high density monitoring wireless networks," 2015 IEEE 15th Mediterranean Microwave Symposium (MMS), 2015, pp. 1-4, doi: 10.1109/MMS.2015.7375456.
- [8] U. Garlando et al., "Towards Optimal Green Plant Irrigation: Watering and Body Electrical Impedance," 2020 IEEE International Symposium on Circuits and Systems (ISCAS), 2020, pp. 1-5, doi: 10.1109/ISCAS45731.2020.9181290.
- [9] Garlando, U. and Bar-On, L. and Motto Ros, P. and Sanginario, A. and Calvo, S. and Martina, M. and Avni, A. and Shacham-Diamand, Y. and Demarchi, D., "Analysis of in vivo plant stem impedance variations in relation with external conditions daily cycle", 2021 IEEE International Symposium on Circuits and Systems (ISCAS), pp.1-5.
- [10] Zhao, Yicong and Gao, Shenghan and Zhu, Jia and Li, Jiameng and Xu, Hang and Xu, Kexin and Cheng, Huanyu and Huang, Xian, "Multifunctional stretchable sensors for continuous monitoring of long-term leaf physiology and microclimate", *ACS omega*, 2019, pp. 9522-9530.
- [11] P. M. Ros, E. Macrelli, A. Sanginario, Y. Shacham-Diamand and D. Demarchi, "Electronic System for Signal Transmission Inside Green Plant Body," 2019 IEEE International Symposium on Circuits and Systems (ISCAS), 2019, pp. 1-5, doi: 10.1109/ISCAS.2019.8702577.
- [12] Dasgupta, P., Das, B. S., and Sen, S. K., "Soil water potential and recoverable water stress in drought tolerant and susceptible rice varieties", *Agricultural Water Management*, 152, 110-118.
- [13] Yang, J., Liu, K., Wang, Z., Du, Y., and Zhang, J., "Water-saving and high-yielding irrigation for lowland rice by controlling limiting values of soil water potential", *Journal of Integrative Plant Biology*, 49(10), 1445-1454.
- [14] M. Barezzi et al., "Long-Range Low-Power Soil Water Content Monitoring System for Precision Agriculture," 2022 IEEE 13th Latin America Symposium on Circuits and System (LASCAS), 2022, pp. 1-4, doi: 10.1109/LASCAS53948.2022.9789070.
- [15] "Reading WATERMARK Soil Moisture Sensors" available at: <https://www.irrometer.com/200ss.html>.
- [16] Battey, Nick H., "Aspects of seasonality", *Journal of Experimental Botany*, 2000, pp. 1769-1780, doi: 10.1093/jexbot/51.352.1769.