

Development of Inflatable Heat Shield Technology for Re-Entry Systems in EFESTO project

Original

Development of Inflatable Heat Shield Technology for Re-Entry Systems in EFESTO project / Dietlein, Ingrid; Guidotti, Giuseppe; Pontijas Fuentes, Irene; Trovarelli, Federico; Rivero Martín, Alejandro; Schleutker, Thorn; Callsen, Steffen; Bergmann, Kevin; Julien, Cedric; Yann, Dauvois; Gardi, Roberto; Gambacciani, Giovanni; Governale, Giuseppe. - (2022). (Intervento presentato al convegno 9th EUROPEAN CONFERENCE FOR AERONAUTICS AND SPACE SCIENCES (EUCASS)) [10.13009/eucass2022-7198].

Availability:

This version is available at: 11583/2974736 since: 2023-01-17T17:51:28Z

Publisher:

9th EUROPEAN CONFERENCE FOR AERONAUTICS AND SPACE SCIENCES (EUCASS)

Published

DOI:10.13009/eucass2022-7198

Terms of use:

This article is made available under terms and conditions as specified in the corresponding bibliographic description in the repository

Publisher copyright

(Article begins on next page)

Development of Inflatable Heat Shield Technology for Re-Entry Systems in EFESTO project

Ingrid Dietlein¹, Giuseppe Guidotti², Irene Pontijas Fuentes², Federico Trovarelli², Alejandro Rivero Martin², Thorn Schleutker¹, Steffen Callsen¹, Kevin Bergmann¹, Cedric Julien³, Dauvois, Yann³, Roberto Gardi⁴, Giovanni Gambacciani⁵, Giuseppe Governale⁶

¹ DLR, Deutsches Zentrum für Luft- und Raumfahrt e.V (DLR), Bremen & Cologne, Germany, ingrid.dietlein@dlr.de

² DEIMOS Space S.L.U., Tres Cantos, Spain

³ Office National d'Etudes et de Recherches Aéronautiques (ONERA), Châtillon & Toulouse, France

⁴ CIRA, Centro Italiano Ricerche Aerospaziali, Capua – Caserta, Italy

⁵ Aviospace srl, Turin, Italy

⁶ Department of Mechanical and Aerospace Engineering, Politecnico di Torino, Turin, Italy

Abstract

The EFESTO project is funded by the European Union H2020 program. The purpose is to increase European capabilities in designing Inflatable Heat Shields for re-entry vehicles.

The technology of inflatable heat shields enables increasing the spectrum of space-based applications as it provides effective heat protection and deceleration capabilities for atmospheric descent while being comparatively mass and volume efficient which is a significant asset for a space mission.

The use of inflatable heat shields for Mars exploration and for Earth re-entry of a launcher upper-stage for later reuse were selected at the initial study phase as potential application for the HIAD technology. These two application cases are to demonstrate the performance of this technology under realistic conditions and to provide a representative study frame for the design of inflatable heat shields trained at tangible applications.

In the first part of the project, the work focused on the system design of both study cases. This work yielded an inflatable heat shield design that shows a reduced complexity in geometry compared to the initial design and is scalable for other applications. Several stacks of material layers for the Flexible Thermal Protection System (F-TPS) were traded against each other before selecting one reference definition for the consecutive project phases.

An intense test activity followed this phase. Part of the tests served for verifying the thermal performances of the F-TPS under relevant aerothermal environment using the plasma wind tunnel test infrastructure available within the consortium. In addition, a high-fidelity inflatable structure ground demonstrator was manufactured. This demonstrator served to consolidate the mechanical characterization of the inflatable system. This testing activity provided the data used for numerical cross-correlation and experimental-numerical rebuilding. Eventually, computational folding analysis completed the numerical activity during this project phase.

The final project phase is dedicated to the preliminary design of an in-orbit demonstration mission for the technology and design of the technology development roadmap. This potential future In-Orbit Demonstrator (IOD) shall provide knowledge of the system performance while evolving in a relevant environment. This will provide in-flight verification and validation of the developed inflatable heat shield technology.

This paper gives an overview of the project with a focus on system aspects of the EFESTO project about to be completed in the coming weeks.

1. Introduction

The EFESTO project, funded by the European Union 2020 program, aims at fostering European capabilities in developing inflatable heat shields for re-entry applications. This technology allows constructing heat shields that are large enough to reduce the ballistic coefficient of a given re-entry body while complying to the restrictive storage volume and mass requirements during launch and transfer. As such, inflatable heat shields represent a technology with the potential of enabling new and more ambitious applications than conventional rigid heat shields.

As representative study cases for such applications, the EFESTO project team has selected, from a set of several study case candidates, the retrieval of the VEGA upper stage AVUM with the intention of rendering this stage reusable and

a robotic exploration mission to Mars. In both application cases, the inflatable heat shield is used to aerodynamically decelerate the vehicle while protecting it from the heat generated during atmospheric descent.

System design work performed for both applications led to define a HIAD design offering good scalability and reduced geometrical complexity compared to the initial design. Mission analysis work performed allowed identifying a feasible re-entry corridor for both applications and to evaluate aerothermal heat loads encountered during re-entry setting the benchmark for the HIAD design itself. Aerothermodynamic analyses were performed to consolidate the design.

Extensive wind tunnel test campaigns allowed the verification and consolidation of relevant material properties of selected fabric stack-ups for the flexible thermal protection system (F-TPS). The experimental activity was complemented by testing operational aspects such as stowing and deploying and the static strength under pressure of the EFESTO design of an Inflatable Aerodynamic Device (IAD) on a semi-scale ground demonstrator at CIRA.

The EFESTO team has further investigated options for an in-orbit demonstration (IOD) of the EFESTO-IAD.

The entire work performed within EFESTO cannot be described sufficiently well within one paper. This paper will hence focus primarily on the system aspects concerning the two investigated applications and the IOD while only giving a rough overview of the other activities that are published in dedicated papers. A concise overview of the entire EFESTO project can be consulted in reference [1] whereas [2] and [3] present the test activities within the project and provides details the HIAD design activities during EFESTO.

2. System design of investigated application cases

This section describes the activities related to the system and IAD design for both selected application cases investigated within the EFESTO project. Within this activity phase, aerothermal and mission analysis were crucial for providing input data relevant to the IAD design and material selection.

2.1 Upper stage recovery: VEGA AVUM

Among several application cases, the recovery of an upper stage for the purpose of reusing it was identified as very promising from a commercial perspective. During an initial design loop during the early phases of the EFESTO project it was soon decided to investigate the application of the HIAD technology to the upper stage of the Vega rocket as a realistic and promising case with the AVUM being particularly well suited due to its compact layout.

After completing its commercial mission by injecting the payload into its target orbit, the AVUM upper stage performs a deorbiting manoeuvre for a safe demise over an uninhabited area at sea after a burnup in atmosphere during the unprotected descent. For a save recovery for later re-use by avoiding the burning up of the stage, the stage will be equipped with an IAD that protects this valuable hardware from aerothermal effects and decelerates it in order to limit mechanical loads on the structure during re-entry. Figure 1 provides a schematic view of the concept of operations (ConOps) for a VEGA AVUM recovery as envisaged for EFESTO. After a VEGA launch and injection of the payload into the target orbit (1), the deorbiting manoeuvre and the separation of the payload adapter is performed (2). At this point the HIAD is inflated and a controlled lifting entry phase commences (3). The centre of gravity (CoG) of the AVUM with the HIAD in re-entry configuration is off-set so that the vehicle is able to generate the necessary lift to be used for controlling the flight trajectory. The entry phase ends at around Mach 1.6 when the pilot chute is ejected to extract a drogue parachute that further decelerates the payload (4). A parafoil deployed at low subsonic conditions guides the vehicle to the targeted area of mid-air retrieval (MAR) by helicopter (5). The final step is the necessary refurbishment of the recovered stage (6) to prepare it for the following flight.

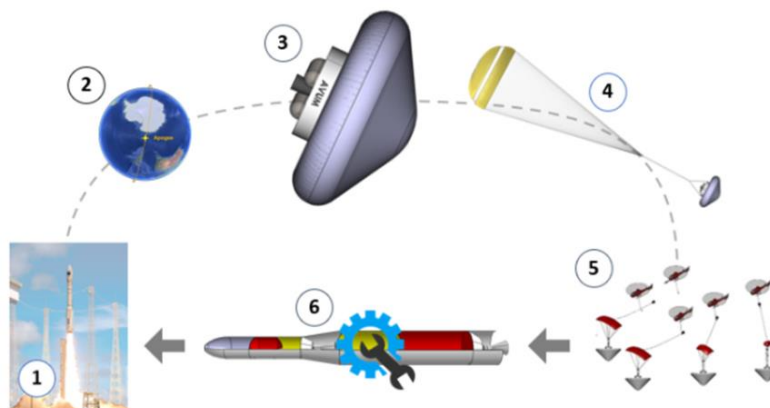

Figure 1: VEGA AVUM ConOps, [5].

Figure 2 presents a more detailed depiction of the ConOps during the flight itself as envisaged at this stage (stage 3 in the previous figure). During upper stage ascent the payload to be launched by VEGA is mounted atop of the external cone (e. g. Vespa or a dedicated structure). After insertion and release of the payload into the target orbit the AVUM is oriented prior to firing its engine for the de-orbit boost placing the AVUM with the external cone still attached to it on a re-entry path. After this manoeuvre the external cone is separated and continues its descent path along which it should burn up in the atmosphere. The AVUM itself then performs another rotation in order to orient it appropriately. Following the rotation, the HIAD is inflated in preparation to atmospheric re-entry.

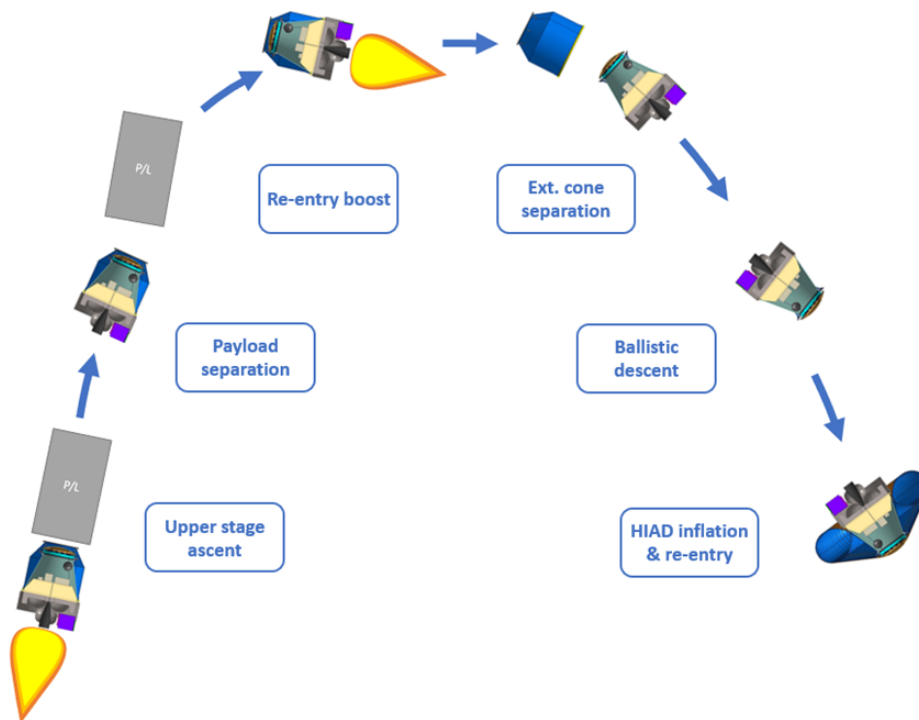

Figure 2: VEGA AVUM ConOps detail of flight phase.

Along the constraints as presented by the Vega User Manual [4], the system integration of the HIAD to the AVUM stage shall not modify the existing VEGA launcher subsystems distribution. To respond to this requirement, it is envisaged to store the HIAD within the available volume under the VESPA or a similar structure. This structure is discarded prior to HIAD inflation but ideally after the de-orbit burn in order for a demise in atmosphere by burning up. The resulting system configuration is shown in Figure 3. The inflatable structure consists of two integrated volumes pressurized using a cold gas generator (CGG). The annular torus has a tear-shaped cross section and an outer diameter of 4.8m while the secondary conical volume covers the lateral surface area of the cone that has a total height of 2.1m and an opening angle of 120° . The spherical rigid thermal protection system (R-TPS) nose has a radius of 1.3m. The resulting reference surface of the vehicle in entry configuration is approximately 18 m^2 .

An EFESTO cone is integrated to the AVUM and mounted on top of the cylindrical body structure of the stage. It provides an interface to the nose assembly and transmits loads to the stage. The nose assembly itself is suitably designed to integrate the R-TPS and the inflatable structure and the flexible thermal protection system (F-TPS).

In the rear of the stage the descent and landing (D&L) system is integrated consisting of a drogue and a pilot chute and finally a parafoil chute. For obtaining the required angle of attack of 15° during re-entry a trim mass had to be added so that the targeted centre of gravity (CoG) offset is achieved. A potentially necessary trim mass to be integrated in the VESPA for balancing the CoG in compliance with ascent requirements was not further investigated since beyond the scope of the project that focussed on the HIAD design.

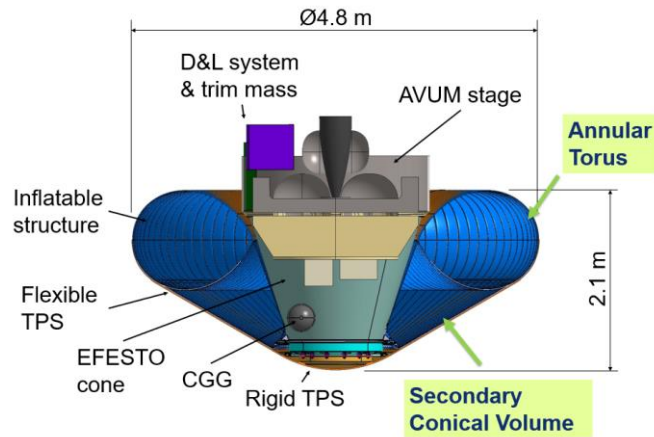

Figure 3: VEGA AVUM side view in re-entry configuration.

The mission analysis performed by DEIMOS yielded the definition of the 2-dimensional local entry corridor (LEC), indicating the flight path angle (FPA) vs ballistic coefficient (BC) envelop respecting limitations on maximum tolerable load factor and heat flux on the F-TPS cone and on landing accuracy for lower BC. This LEC for a velocity of 7.6 km/s at entry interface point (EIP) is shown in Figure 4. For the system mass of about 1100 kg and a HIAD diameter of 4.8 m ($BC = 46 \text{ kg/m}^2$) the flight path angle at the entry interface point (EIP) has to be between -3.79° and -1.97° . A shallower entry would result in excessive dispersions jeopardizing a safe mid-air retrieval. For the obtained system ballistic coefficient, the load factor limit is reached sooner than the heat flux limit in case of a steeper entry. In terms of heat flux limit, this fact should provide sufficient thermal margin for the HIAD.

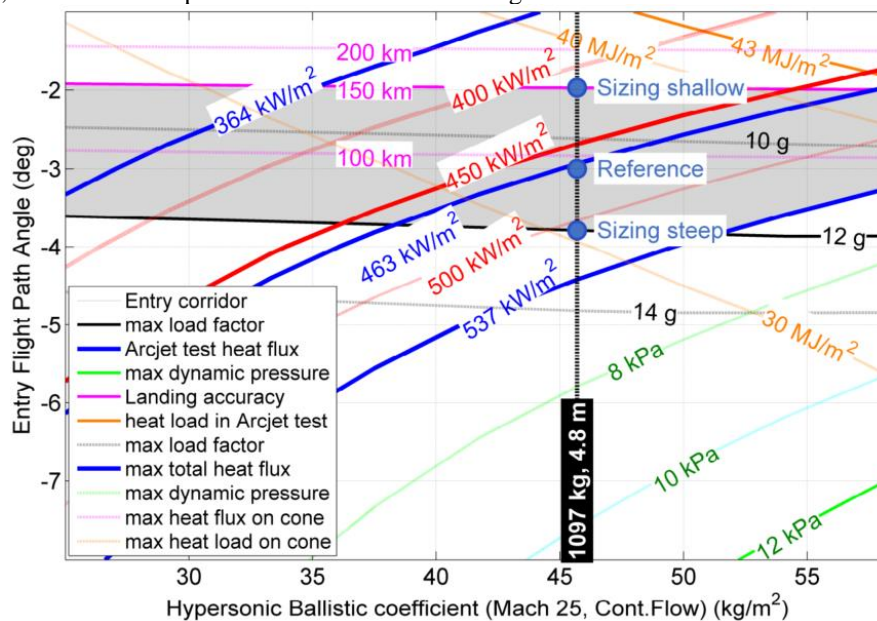

Figure 4: Earth entry mission scenario 2D LEC, [5].

Due to high dispersions at EIP, the flight path has to be actively controlled in order to meet the requirements related to the mid-air retrieval maneuver. This is accomplished by controlling the bank angle in order to use lift generated by flying at a constant angle of attack (AoA) between -10° and -20° to compensate these dispersions. An AoA of -15° provides a theoretical range capability of 300 to 400 km corresponding to a compensation of approximately 150 to 200 km of EIP position error as indicated by Figure 5. More details on the mission analysis can be found in [5].

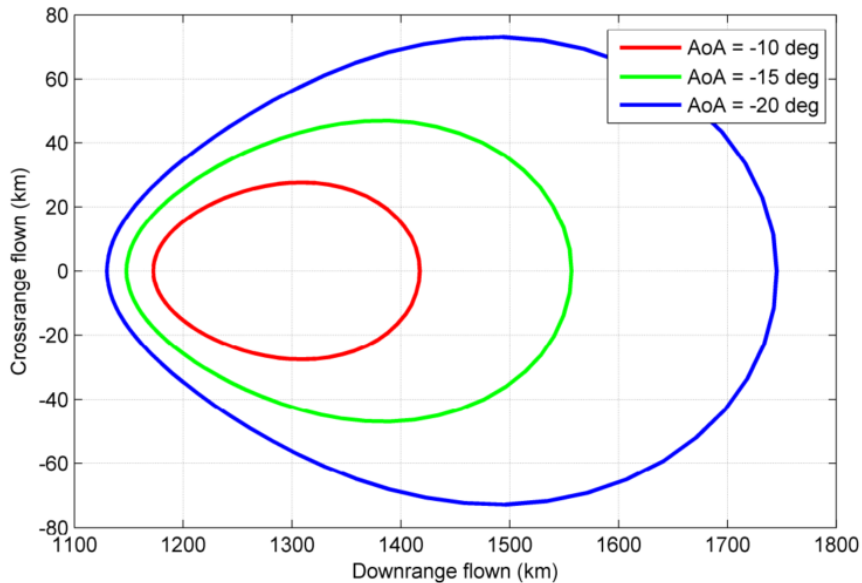

Figure 5: Range capability as a function of trim AoA, [5].

The HIAD design evolved considerably between the first design consisting of a torus stack similar to that used by NASA for the Inflatable Re-entry Vehicle Experiment (IRVE), [6], and the final design that was considerably reduced in complexity while increasing scalability. Its shape is defined by two major volumes, the annulus with a tear-shaped cross-section and the secondary conical volume, see Figure 3. The inflatable structure is designed in such a way that the correct shape is achieved after inflation forming the conical section and the rounded edge of the heat shield. It has to sustain the mechanical loads while containing the inflation gas throughout re-entry. On the sections of the heat shield exposed to the air flow thermal protection is to be provided. A rigid nose TPS ensures the heat protection and a fixed shape to the nose where the stagnation point is located during re-entry. The flexible part of the heat shield is protected by a flexible TPS on its exposed sections, see Figure 6. For more information on the IAD design, refer to reference [3].

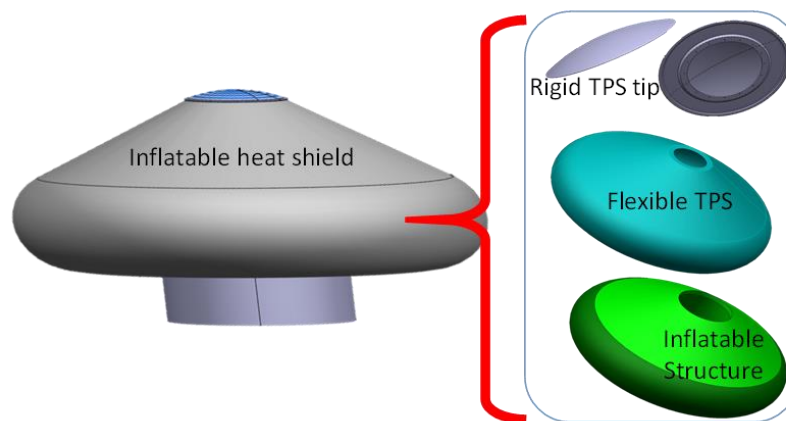

Figure 6: EFESTO IAD architecture for Earth application.

Figure 7 presents the mass distribution of major subsystems and the HIAD system. As can be seen, the HIAD, the inflatable structure, the F-TPS and the Inflation system does not exceed 16% of the total re-entry mass at 18% when including the rigid nose TPS.

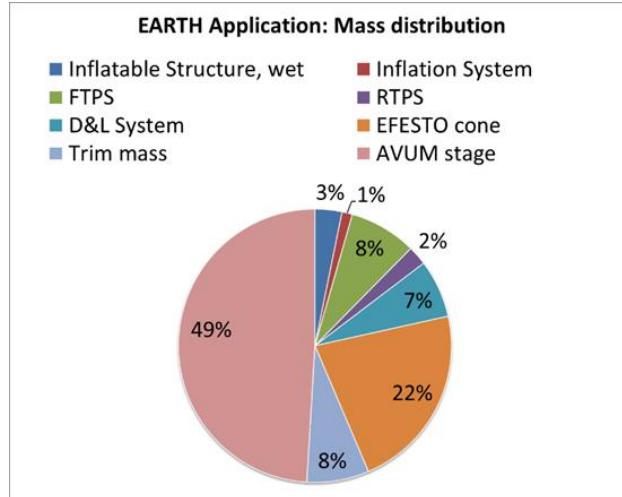

Figure 7: Distribution of mass for Earth application AVUM – re-entry configuration.

2.2 Mars robotic exploration

The second application case is that of using the HIAD technology for a scientific mission to Mars with a landing of a potentially mobile measurement station. This technology allows the implementation of a comparatively large aerodynamic decelerator that offers the possibility for a low comparatively ballistic coefficient and hence increased deceleration capabilities than conventional technologies which in turn opens up new opportunities to land on Mars latitudes unexplored due to high ground altitudes. The selected high-mass Mars exploration robotic baseline EDL mission is compatible with a launch in the 2030-2040 timeframe.

Following an interplanetary transfer, the vehicle will perform a direct entry at hyperbolic arrival velocity in the Mars atmosphere. As depicted in Figure 8, the first events consist of the cruise stage separation (1) followed by the separation of the bag protecting the stowed HIAD (2). After it gets inflated (3), the hypersonic re-entry phase starts. The HIAD provides aerodynamic deceleration until, after front shield ejection (4), it gets released at Mach 2.3 (5). Touchdown speed is achieved using supersonic rocket propulsion (SRP) down to ground (6), and finally a Skycrane-like system lowers the payload down to the surface (7).

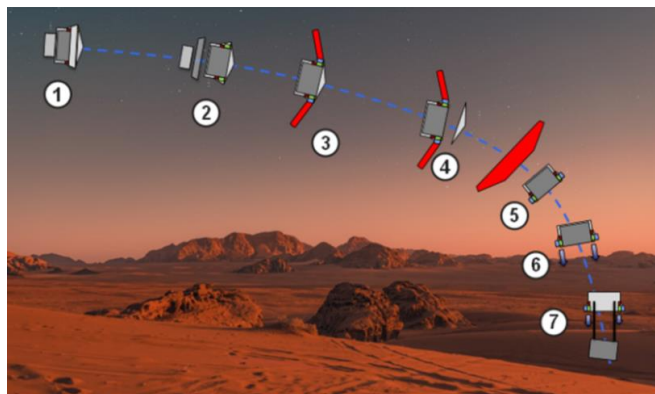

Figure 8: Mars HIAD robotic EDL mission ConOps, [5].

The payload to be lowered to the Mars surface is 2.5 metric tons and its dimensions are 2.8 m x 2.5 m. The carrier frame houses all relevant subsystems required for operating the descent module and the HIAD and integrated the SRP system consisting of a ring of multiple monopropellant Aerojet Rocketdyne MR-80B31100 thrusters to be ignited at Mach 2.3, [7].

The architecture of the HIAD (Figure 9) is very similar to that for the Earth application VEGA AVUM case consisting of a tear-shaped annular torus generating the outer rim of the conus of the heat shield itself formed by the secondary conical volume. In distinction to the VEGA AVUM HIAD the rear section of the vehicle is protected from the recirculation zone by a flexible back cover linking the annular torus with the rear edge of the carrier frame. Inflated

the HIAD shield measures 8.8 m in diameter and has a cone height of 2.6 m. The opening angle of this cone is 140° and the nose radius 1.75 m. The reference surface of the vehicle is approximately 60 m^2 .

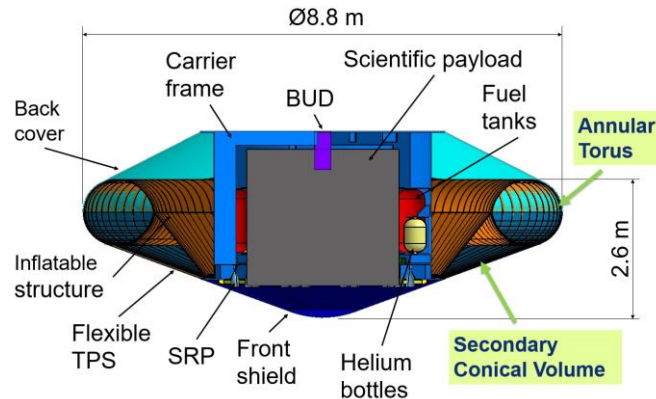

Figure 9: Mars scenario HIAD entry vehicle.

The LEC for the Mars application was determined for an EIP velocity of 6 km/s and a HIAD release at Mach 2.3. It is shown in Figure 10. For the obtained ballistic coefficient of 62 kg/m^2 corresponding to a descent mass of 6024 kg , the corridor ranges from -12.5° to -11.5° of flight path angle at EIP. The upper limit leading to a shallow entry is determined by the landing accuracy requirement whereas the lower limit (steep entry) is related to the limitation on maximum heat load of 531 kW/m^2 . It was found that the landing accuracy can be met with a ballistic re-entry therefore no active flight trajectory control is needed.

Even with adding 30 kW/m^2 for considering radiative heating, the resulting heat flux of 561 kW/m^2 is still well below the sizing heat flux of 590 kW/m^2 used for the F-TPS design. More information on the mission analysis activity can be consulted in [5].

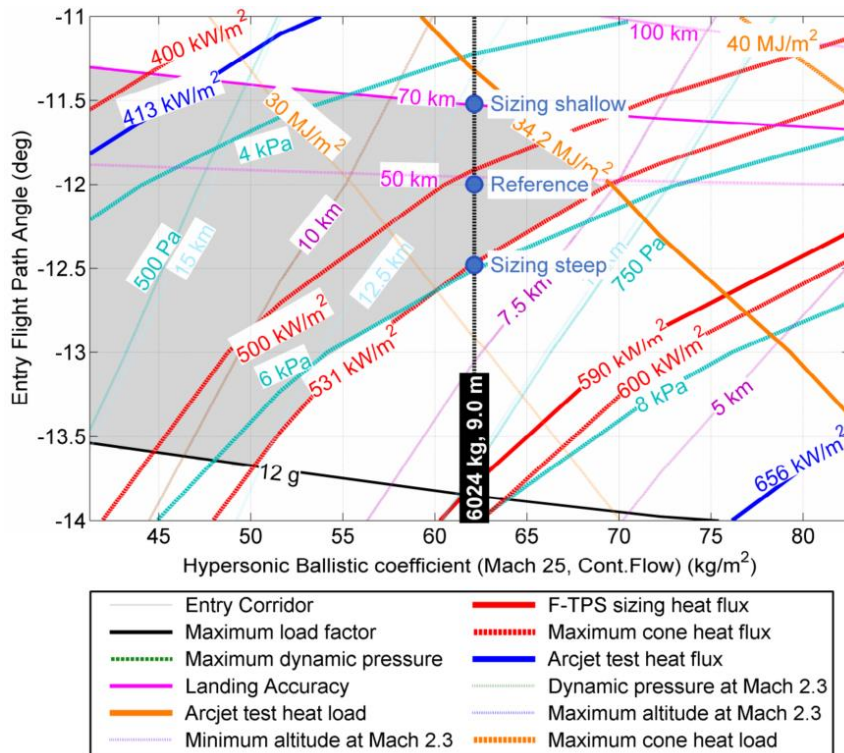

Figure 10: Mars entry mission scenario 2D LEC, [5].

The HIAD architecture is very similar to that for the Earth application, see Figure 11. The major difference, apart from the geometric key figures such as diameter and cone angle, is that a flexible back-shield was added in order to protect the vehicle from heat load due to recirculation phenomena. The rear plate of the carrier frame is protected by a multi-layered insulation (MLI) cover. For more details on the IAD design, refer to references [2] and [3].

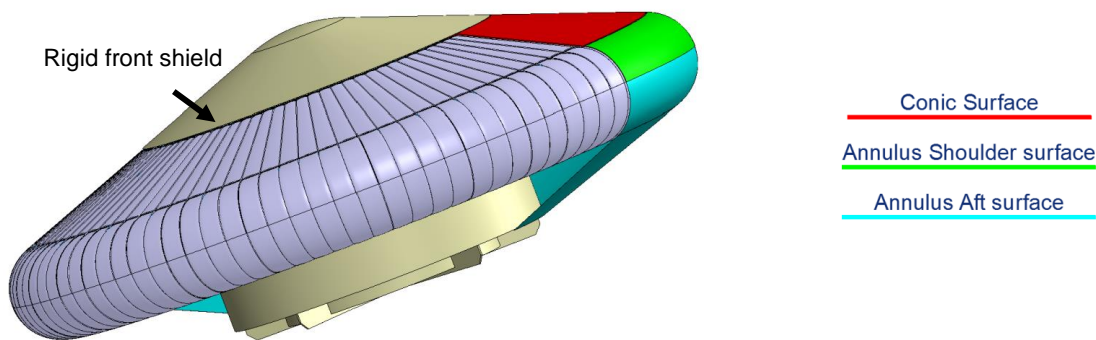

Figure 11: EFESTO IAD architecture for Mars application.

As shown in Figure 12, the HIAD, composed of the Inflatable Structure, the F-TPS and the Inflation System, amounts to only 7% of the total system mass of the descent module, despite the considerable heat shield size.

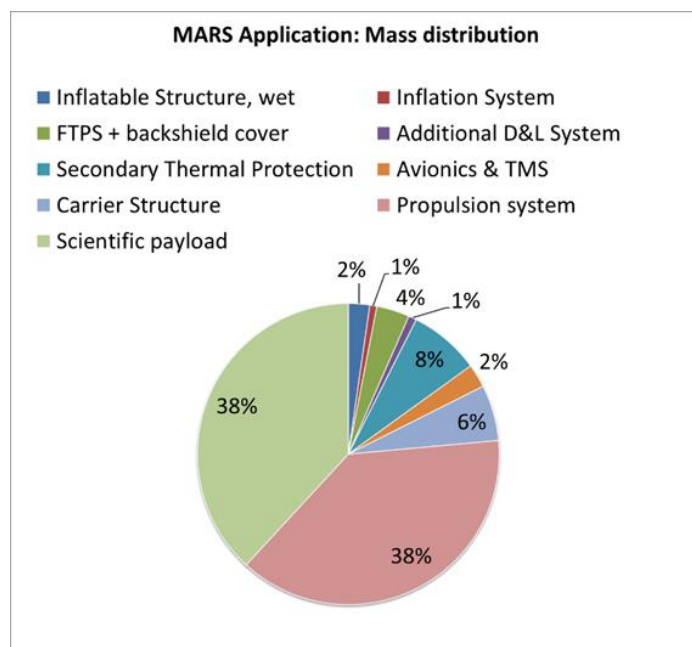

Figure 12: Distribution of mass for Mars application.

3. EFESTO test activities

This section can only give a very limited overview of the extended ground test activity performed within the EFESTO project. This is more exhaustively described in [2] and [3].

Part of these tests were dedicated to material characterization of the F-TPS. Several materials and stacks were evaluated and traded against each other considering how well they suite a F-TPS for the investigated applications. Materials were evaluated with respect to their thermal characteristics after a first down-selection based on former application in other space projects, on availability in Europe, resistance to oxidations, mechanical characteristics, density, bending capabilities etc. These material characterization tests performed by the Austrian Foundry Institute ÖGI were to consolidate the material selection by providing thermal properties (specific heat, thermal conductivity and diffusivity and the mass loss) to the F-TPS design process. To this end, measurements were performed on a broad temperature range to obtain a sound database ranging from room temperature up to temperatures of 1100°C-1300°C depending on the material and the applied technique.



Figure 13: F-TPS finished sample during thermal test, [2].

Additionally, F-TPS samples were exposed to experimental re-entry flight simulations within the DLR arc-heated wind tunnel facilities LBK in Cologne. These were performed to allow the characterization of the thermal performance of the developed F-TPS layouts and to evaluate their survivability with respect to the thermally and chemically aggressive entry flight environment. The L2K branch of this test facility allows heat fluxes up to 3 MW/m^2 at stagnation point pressures up to 250 hPa. In addition, different gases and mixtures such as Air, Nitrogen, Argon, Carbon Dioxide or mixtures simulating the Mars atmosphere can be used as test medium. The other branch, the L3K, while only using Air with a small proportion of Argon, can attain heat fluxes up to 10 MW/m^2 at stagnation pressures reaching 2000 hPa. These capabilities were used to simulate Earth re-entry and entry emulating Mars atmospheric conditions.

The samples were subjected to the tests in two setups, one being a stagnation flow setup for maximizing heat flux exposure thus serving the investigation of the F-TPS performance with respect to thermal and chemical boundary conditions. The second setup was that of a tangential flow setup allowing the assessment of the influence of tangential flow and the shear forces generated by the surface parallel flow component. A total of 65a tests in three campaigns based on both setups were performed under varying heat flux levels, total heat loads and test durations both in Air and in Mars atmospheric conditions. These tests considerably enhanced the understanding of the material properties and suitability with respect to the target applications investigated in EFESTO. Exhaustive details on the test results can be consulted in [2].

In addition to the material tests, a 2.4-meter diameter HIAD demonstrator for the Earth application was fabricated simultaneously being used as an Engineering Development Unit (EDU). The geometry of the HIAD was a semi-scale copy of the EFESTO HIAD for the Earth application. A detailed description of the EDU can be found in [3], from which Figure 14 was taken.



Figure 14: IAD with integrated F-TPS positioned in static deflection test pool, [3].

4. EFESTO technology roadmap and in-orbit demonstration candidate

Considerable progress of HIAD technology development was achieved by EFESTO pushing the TRL to 4/5. The development activity performed within EFESTO spans from extensive numerical model building and analysis to an extensive test campaign in the arcjet facility of DLR with the purpose of material characterization and a ground test campaign of a semi-scale demonstrator of the EFESTO HIAD at CIRA probing the mechanical properties of the design and increasing experience in the inflation and stowing process. For details of this extensive test campaigns, see references [2] and [3]. In addition to the system design for two application cases and the test campaigns, a candidate for an in-orbit demonstration of the EFESTO HIAD concept is designed on a preliminary level.

Further development and demonstration activities however are still necessary to push beyond the EFESTO status until reaching operational maturity. In this section a brief description of the technology roadmap is provided together with the activity within EFESTO to define a candidate for in-orbit demonstration of the EFESTO HIAD design.

3.1 Technology roadmap

The European advancements in the inflatable aerodynamic decelerators technology paves the way to enable future space missions allowing new scientific and technological achievements. These include the possibility of heavier payloads landed at higher elevations (e.g. of Mars), resulting in expanding the planetary exploration boundaries, or, by integrating the HIAD to the launch vehicle, the ability to recover some of its main components which could contribute to lowering launch costs.

To attain such operational capabilities, the EFESTO project was committed to the technology development of the F-TPS and the inflatable structure. The test campaigns described earlier are filling the gap between the current state of the art and the TRL for a future IOD mission which is foreseen by the EFESTO technology roadmap. A preliminary design of such an IOD candidate was performed as well.

The roadmap in Figure 15 is built on a technology context activity, assessing past, present, and future missions linked to the EFESTO activity by technology category. The current international efforts and space missions' goals are in line with the development of a technology capable of enlarging our landing and reusability capabilities.

Enabling the exploration of Mars in regions not yet accessible is of most scientific interest for the possible existence of life and to support future human exploration and colonization. The objective of enhancing reusability of Earth orbiting spacecraft by means of a potentially lightweight alternative to rigid decelerators is in line with the principle of affordability and sustainability, which represent key factors for the current space industry.

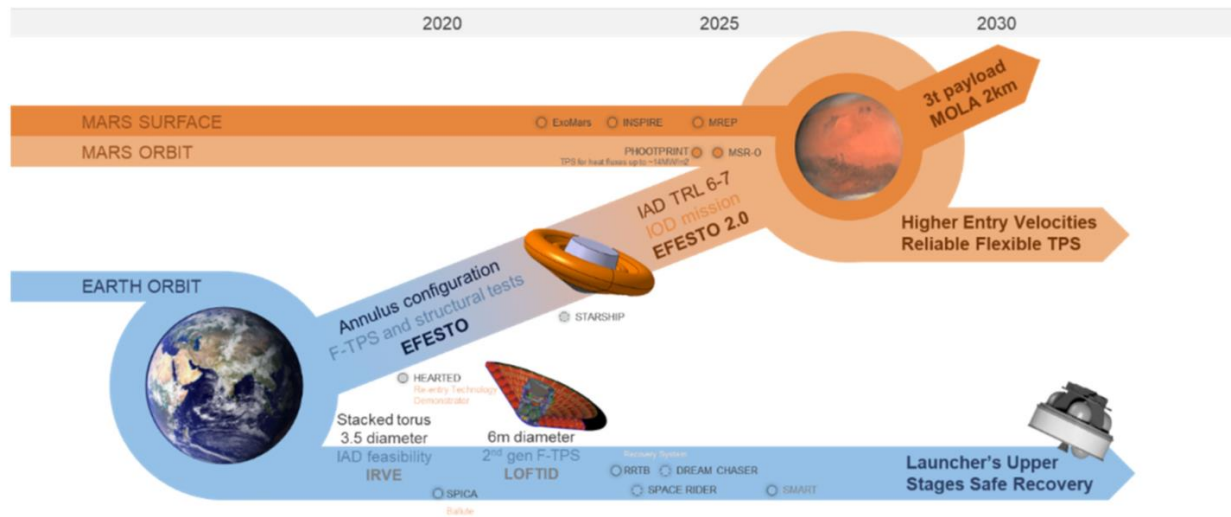

Figure 15: EFESTO technology roadmap.

3.2 System design of an IOD candidate

The first step of the activity related to the design of an IOD candidate was targeted at identifying the in-flight test needs feeding a set of high-level requirements. These high-level needs are:

1. Verify standard operation phases of an IAD system composed of a F-TPS and an inflatable structure (IAD deployment, shape fidelity during atmospheric re-entry etc.);

2. Basic model identification (aerodynamic, structural modes, shape deformation, pneumatic “modes”, structural loads etc.);
3. Validation of numerical models (CFD, FEM ...);
4. Survivability during re-entry while sustaining meaningful heat loads;
5. Maturation and consolidation of integration solutions (mechanical, pneumatic interfaces, packing, stowing etc.).

Alongside these high-level needs further requirements were formulated such as increasing the technology readiness level (TRL) to a range between 6 to 7 and to extend EFESTO heritage as much as possible. This latter requirement led to decide for an IOD reflecting an Earth-bound application such as the VEGA AVUM recovery investigated within the project and for which substantial data stemming from extensive numerical modelling, wind tunnel tests and the ground demonstrator exist. Considerations of launch costs and potential mission flexibility led the team to focus on small and medium-sized launch systems for the transportation of the IOD. A broad analysis on launch systems was performed including launchers under development. Without any intention of pre-selecting the launch system for this IOD candidate but merely for creating a realistic study reference a suitable launch system was identified from which payload and geometric limitations to the IOD were derived. The resulting study launch scenario foresees to launch the IOD with the launcher RFA One developed by the start-up Rocket Factory Augsburg. The launcher Spectrum currently developed by ISAR Aerospace could potentially serve as a backup solution within this study launch scenario. Both should be launched from Kourou in order to position the splash-down site of the IOD in waters that can be easily attained while avoiding impact on ground and ensuring sufficient visibility.

During the preliminary design iteration, it was finally decided to go ahead with a 1:1 shape of the HIAD since downscaling it would have resulted in a different nose radius or a modified cone angle which would have jeopardized the test needs identified for this IOD.

For the baseline concept, a ballistic re-entry at zero angle of attack was chosen for simplicity reasons. In addition, it was decided to recover the IOD in water similarly to IXV as this significantly increases the solution space for a launch and re-entry mission meeting all requirements such as maximum heat rate, mission safety etc.

An iteration between launcher capabilities, splash-down sites, safety considerations during ascent and re-entry plus a mission analysis yielding thermomechanical loads during re-entry allowed fixing the desired re-entry corridor for the IOD candidate. The velocity at the Entry Interface Point at 120 km altitude shall be 7.6 km/s with a flight path angle between -2.38° and -1.96° . The landing area is expected between the British Islands and Iceland.

The AVUM stage as shown in Figure 3 is replaced by the IOD central body providing housing of all essential subsystems such as three buoyancy bodies stored inside suitable containers and a dedicated inflation system, complemented by the inflation system for the HIAD, avionics and the in-flight measurement system. Figure 16 provides a cut view of the IOD in re-entry configuration and major geometric characteristics. It shall be noted that the named subsystems are by no means complete and that their position are not yet fixed at this preliminary study phase.

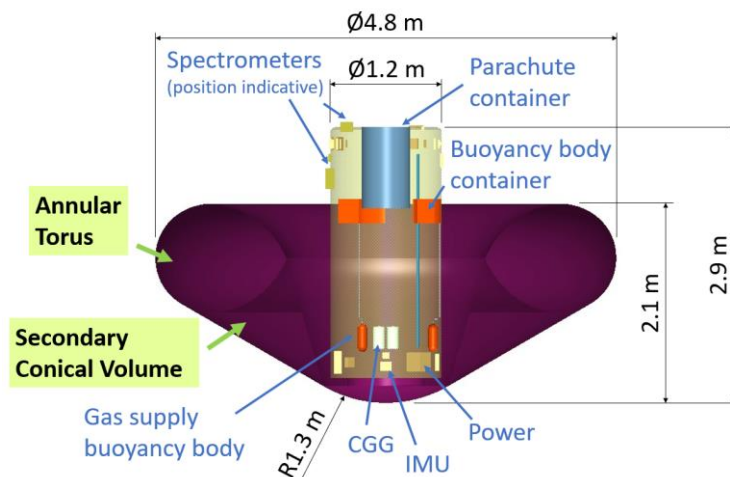

Figure 16: IOD side view in re-entry configuration.

The current design allows in addition the accommodation of a passenger payload of nearly 1 m^3 provided that the global CoG requirements are met. The launch mass of the baseline configuration was estimated to be approximately 860 kg.

On a very preliminary basis, alternative architectures were investigated as well:

1. A configuration with active attitude control using a suitable reaction control system (RCS) with a launch mass estimated to be approximately 920 kg, and

2. A configuration with ballistic re-entry at $\text{AoA} = 0^\circ$, but with a landing on ground and an estimated launch mass of roughly 895 kg.

The obtained mass estimations that include an appropriate system margin are, irrespective of the configuration, all compliant with a launch mass requirement of 960 kg maximum.

Figure 17 depicts a potential ConOps definition. After launch into a suitable unstable orbit placing the IOD on a re-entry path (1), the upper stage of the launcher will orient the IOD appropriately before being detached and placed on its own re-entry path for a safe demise (2). After detachment from the upper stage the actual test phase begins with HIAD inflation and atmospheric re-entry (3). After termination of the experimental phase the parachute system is deployed (4) for decelerating the IOD prior to splashdown in the sea where a waiting ship will perform recovery operations (5).

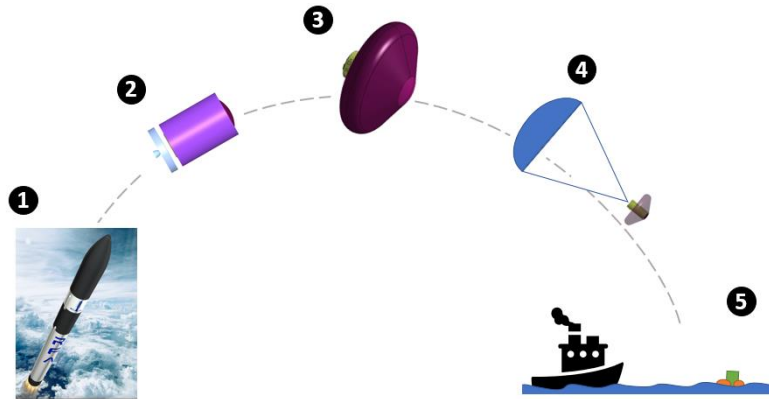

Figure 17: Potential IOD mission ConOps with sea recovery.

During system design of the two investigated applications the aerodynamic and aerothermodynamic performance were numerically investigated by ONERA, yielding – among others – the aerodynamic database as input for mission design. This work is detailed in [5]. Initial concerns that the modification of the central body geometry could lead to a heat load in the re-circularization zone could be met with a limitation of the maximum vehicle length. During the preliminary design loop for the IOD it was also verified numerically that the modified central body had little impact on the aerodynamics and aerothermodynamic behaviour so that the results from the Earth application could be used for the preliminary design of the IOD and no thermal protection had to be provided for the rear part.

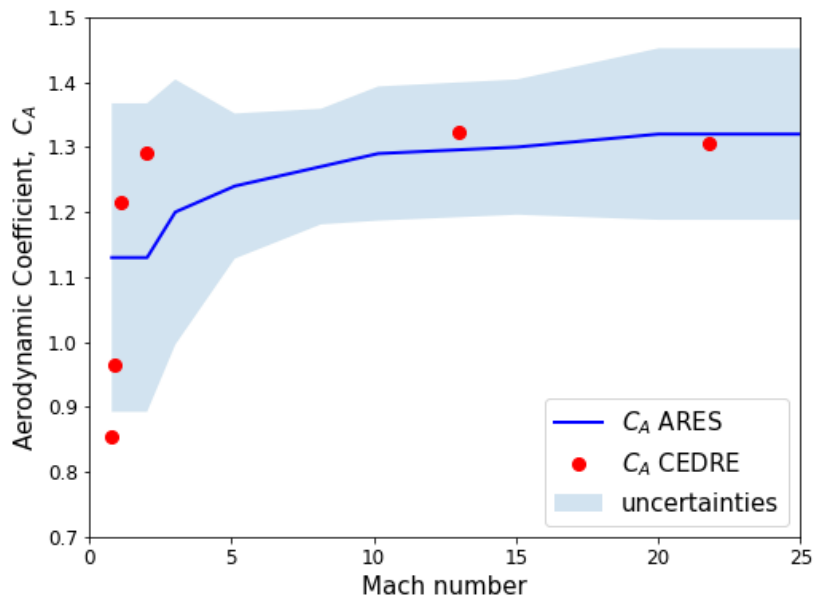

Figure 18: Evolution of the aerodynamic axial coefficient from Mach 25 to Mach 0.8.

Figure 18 presents the axial aerodynamic coefficient C_A for an angle of attack of 0° from Mach 25 to Mach 0.8. The continuous blue line shows the axial force coefficient as obtained by the ONERA's engineering code ARES complemented by results from computation points using the Navier-Stokes solver CHARME of the multi-physics

ONERA platform CEDRE (Calcul d'Écoulements Diphasiques Réactifs pour l'Énergétique). A very good agreement for higher Mach numbers was obtained whereas discrepancies increased for Mach numbers below Mach 2 due to the inaccuracy of the modified Newton model to predict the axial force in the supersonic and transonic regimes. However, the discrepancies are included in the aerodynamic margins, defined in [5]. For the final seconds of flight prior to parachute deployment the aerodynamic database was extended below Mach 1.6 until reaching Mach 0.8. For that purpose, first, atmospheric parameters were generated considering the aerodynamic coefficient constant, then its physical evolution versus Mach number was determined by CFD simulations, illustrated in Figure 18.

For the initial shape of the IOD central body, CFD calculations were performed with the purpose to verify that numerical aerothermodynamic results obtained for the operational vehicle can be used with sufficient confidence for the present study level of the IOD. The calculations on the IOD shape performed for an angle of attack of 15° at maximum heating point (see Figure 19) confirmed that the altered rear geometry had a negligible effect on the aerothermodynamics.

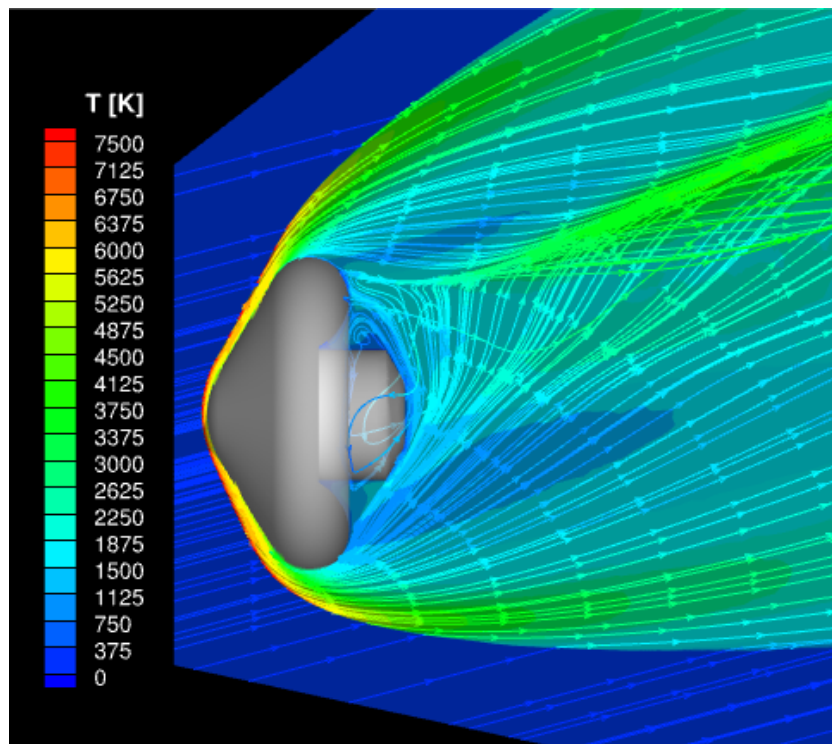

Figure 19: Temperature and flow field at angle of attack of 15° at maximum heating point for preliminary IOD shape.

Reference and sizing trajectories were constructed for a flight path angle of -2.17° and a velocity of 7.6 km/s at EIP for both the RFA One launcher and Spectrum from ISAR Aerospace. This included a Monte-Carlo analysis to verify the mission design with respect to the mission requirements and boundaries.

Both the launch vehicles solutions appear to allow for implementation of an end-to-end (E2E) suborbital flight followed by a re-entry path over the Atlantic Ocean ensuring on the one hand the fulfilment of the safety constraint to no fly over inhabited areas, and on the other the satisfaction of the scientific objectives related to the replication in-flight of the thermomechanical environment to test the key technologies of the inflatable heat shield.

The figure below represents a possible end-to-end flight from launch at Kourou with the ISAR-Spectrum launch vehicle (LV) till splashdown into the sea in the area of the Azores Islands.

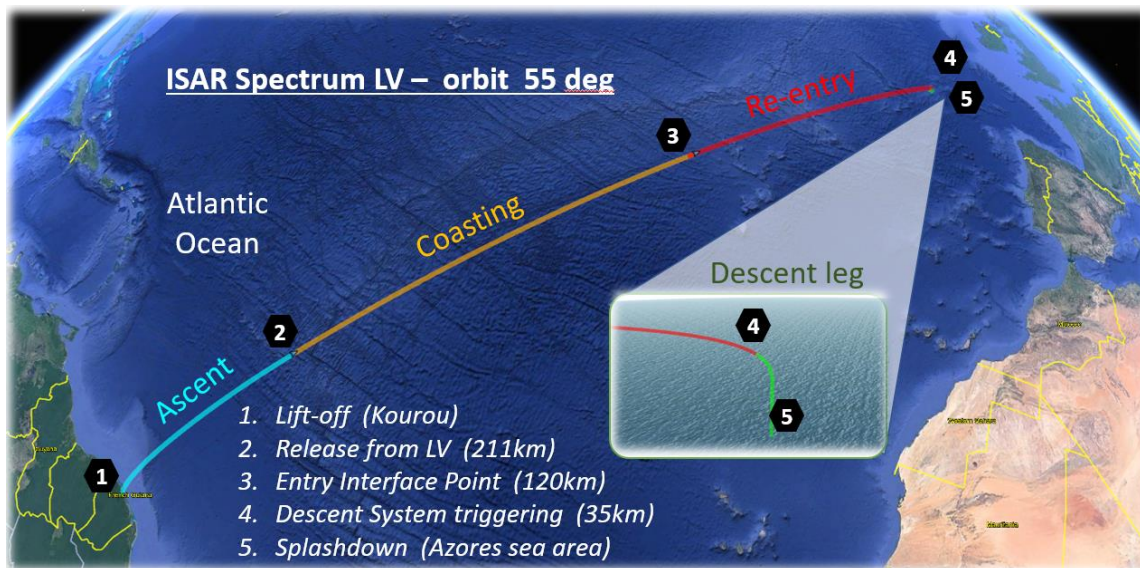

Figure 20: E2E trajectory with ISAR Spectrum LV, orbit inclination 55° mission scenario.

5. Conclusion

The EFESTO project allowed the development and furthering of know-how in Europe concerning HIAD technology and associated system design and engineering. The extensive test campaigns increased knowledge about material and F-TPS properties relevant to the application of this technology and about handling and operation of a HIAD system. The work furthermore increased confidence in the assessment of the potential and benefits of the HIAD technology for space application and in European capabilities in this field. The system design of the investigated applications led to the definition of a feasible system design integrating a consolidated HIAD concept. The obtained results show that the HIAD technology is an enabler for high-mass Mars exploration and for the retrieval of an upper stage with the purpose of re-use.

While the EFESTO project outcome represents a significant forward to an operational HIAD system further technology development activities are needed until reaching technological maturity. The technology roadmap as defined within EFESTO outlines a path towards this point passing by the development of a suitable in-orbit demonstration mission as a next step, with EFESTO providing a proposal of a candidate IOD mission.

Acknowledgement

This project has received funding from the European Union Horizon 2020 research and innovation programme under grant agreement No 821801. More information available at: <https://cordis.europa.eu/project/id/821801>.

The EFESTO consortium acknowledges essential contributions from Thin Red Line Aerospace and ALI Scarl Italia concerning the IAD Demonstrator design, manufacturing, integration and testing processes.

References

- [1] Guidotti, G. et al. 2022. The EFESTO project: Advanced European re-entry system based on inflatable heat shield. In: *2nd International Conference on Flight Vehicles, Aerothermodynamics and Re-entry Missions & Engineering*, Heilbronn, Germany, 2022.
- [2] Schleutker, T. et al. 2022. Flexible TPS design and testing for advanced European re-entry system based on inflatable heat shield for EFESTO project. In: *2nd International Conference on Flight Vehicles, Aerothermodynamics and Re-entry Missions & Engineering*, Heilbronn, Germany, 2022.
- [3] Gardi, R. et al. 2022. Design development and testing of the Inflatable Structure and its Demonstrator for the EFESTO project. In: *2nd International Conference on Flight Vehicles, Aerothermodynamics and Re-entry Missions & Engineering*, Heilbronn, Germany, 2022.
- [4] Arianespace. 2014. Vega User's Manual Edition 4 Revision 0 – April 2014.

- [5] Trovarelli, F. et al. 2021. Advanced European Re-Entry System Based on Inflatable Heat Shields EFESTO project overview: system and mission design and technology roadmap. In: *72nd International Astronautical Congress (IAC), Dubai, United Arab Emirates, 2021*.
- [6] Hughes, S. et al. 2005. Inflatable Re-entry Vehicle Experiment (IRVE) Design Overview. In: *18th American Institute of Aeronautics and Astronautics Aerodynamic Decelerator Systems Technology Conference and Seminar, 2005*.
- [7] Aerojet Rocketdyne. 2019. Aerojet Rocketdyne In-Space Product Data Sheets Monopropellant and Bipropellant Engines. In: *Publication by Aerojet Rocketdyne*.