

DIC vibration measurement through smartphone devices

Original

DIC vibration measurement through smartphone devices / Occhipinti, S.; Neri, P.; Fironne, C. M.; Botto, D.. - In: JOURNAL OF PHYSICS. CONFERENCE SERIES. - ISSN 1742-6588. - ELETTRONICO. - 2802:(2024). (31st A.I.VE.LA. Annual National Meeting Milan (ITA) 05/12/2023 - 06/12/2023) [10.1088/1742-6596/2802/1/012009].

Availability:

This version is available at: 11583/2993864 since: 2024-10-30T06:46:49Z

Publisher:

Institute of Physics

Published

DOI:10.1088/1742-6596/2802/1/012009

Terms of use:

This article is made available under terms and conditions as specified in the corresponding bibliographic description in the repository

Publisher copyright

(Article begins on next page)

PAPER • OPEN ACCESS

DIC vibration measurement through smartphone devices

To cite this article: Serena Occhipinti *et al* 2024 *J. Phys.: Conf. Ser.* **2802** 012009

View the [article online](#) for updates and enhancements.

You may also like

- [Interaction of 3D dewetting nanodroplets on homogeneous and chemically heterogeneous substrates](#)
M Asgari and A Moosavi
- [Propagation of two-wave solitons depending on phase-velocity parameters of two higher-dimensional dual-mode models in nonlinear physics](#)
Shailendra Singh and Santanu Saha Ray
- [Quasiperiodic oscillations and homoclinic orbits in the nonlinear nonlocal Schrödinger equation](#)
F Maucher, E Siminos, W Krolkowski *et al.*



The Electrochemical Society
Advancing solid state & electrochemical science & technology

247th ECS Meeting
Montréal, Canada
May 18-22, 2025
Palais des Congrès de Montréal

Abstracts due December 6th

Showcase your science!

ECS UNITED

DIC vibration measurement through smartphone devices

Serena Occhipinti¹, Paolo Neri², Christian Maria Firrone¹ and Daniele Botto¹

¹Department of Mechanical and Aerospace Engineering, Politecnico di Torino, Torino, Italy

²Department of Civil and Industrial Engineering, Università di Pisa, Pisa, Italy

E-mail: paolo.neri@unipi.it

Abstract. Digital Image Correlation (DIC) stands as a promising non-contact method for assessing the complete dynamics of vibrating structures. Utilizing one or two cameras, DIC can capture either 2D or 3D dynamics. Through subsequent post-processing of images, structural points are correlated across different time frames to derive displacement information. Given the abundance of camera options available, spanning frame rate, resolution, versatility, and quality, the selection process is dictated by specific application needs and financial considerations. This study seeks to explore the feasibility of utilizing the cameras integrated into a ubiquitous device of everyday life: the smartphone. The proposed approaches offer straightforward procedures suitable for educational purposes or early investigation of structure dynamics. The paper presents case studies and discusses simple experiments that students or DIC beginners can conduct on simple vibrating structures. Initially, a simple 2D dynamics was investigated by recording the vibration of a clamped beam with moving constraints using just a single smartphone. The L-type cross section of the beam emphasizes its in-plane motion. The frames were post-processed with open-source software and the deformed shapes were extracted. This assignment serves as an introductory exercise in DIC fundamentals. Subsequently, the focus shifts to investigating the 3D dynamics of the beam. Given the challenges associated with synchronizing multiple smartphone video acquisitions, the image of the beam was instead reflected by two mirrors, and these reflected images were recorded by a single smartphone. Then, the recorded images were split and processed to obtain the full-field 3D dynamics of the beam.

1 Introduction

The demand for accurate, non-contact, and cost-effective measurement methods continues to fuel research efforts. Among the available measurement techniques, Digital Image Correlation (DIC) has emerged as a powerful tool for capturing the full-field dynamics of vibrating structures. Traditional DIC setups typically entail the use of either one specialized camera (for 2D measurements) or two specialized cameras (for 3D measurements), in conjunction with lenses and custom-designed configurations. The high cost of dedicated cameras and lenses can make the technology inaccessible to those with limited resources. Consequently, experimental approaches aimed at reducing costs of DIC setups can be found in the literature. Hence, researchers have introduced pseudo 3D-DIC systems, distinguished by a single camera rather than the conventional two-camera arrangement, in conjunction with cost-negligible optical devices. Accurately designed setups have the capability to split light rays in order to create two sub-images on the camera sensor, thereby generating a double perspective of the specimen. These setups are cost-effective alternatives to traditional two-camera configuration for three-dimensional DIC measurements. For example, a single camera is used in conjunction with mirrors in [1, 2], with polarized



light in [3] and with transmission grating in [4] to create stereo-vision systems and perform accurate 3D-DIC. Utilizing a single camera not only saves the cost of the measurement device, but also enhances the technology usability by eliminating complexities related to synchronize multiple cameras. On the other hand, measurements conducted with pseudo-3D systems typically exhibit lower accuracy compared to those obtained with double-camera setups. It is due to the splitting of sensor resolution or the introduction of image distortions by the complex additional optical devices. However, despite the success in making this technology affordable for most research applications, all these approaches still necessitate the purchase of at least one dedicated camera. This requirement can be an obstacle to the wider adoption of DIC technology in various applications, such as in educational contexts.

In recent years, the ubiquitous presence of smartphones, equipped with increasingly advanced components, has opened up new possibilities for scientific applications. Smartphone-based measurements offers the advantage of portability, simplifying the acquisition process. In [5] smartphones were used for determining natural frequencies of the structures for System Health Monitoring (SHM) purposes. This was possible by leveraging the built-in accelerometers, speakers, and microphones of the smartphones. Furthermore, smartphone cameras have undergone exponential advancements in recent years, empowering users to capture high-quality images at high frame rates. Modern devices can achieve 4K resolution and an extraordinarily high frame-rate of up to 960 fps. Thus, the adoption of these ready-available, user-friendly, everyday instruments, for images acquisition, coupled with the availability of open-source DIC software for both single and double cameras DIC applications, make smartphones well-suited for students, occasional DIC users, and those with limited resources seeking to conduct full-field 2D or 3D DIC-measurements. Xie et al. [6] demonstrated the feasibility of using smartphones and DIC to monitor the bi-dimensional displacement and strain field during compression tests. Stoilov et al. [7] introduced a mobile smartphone application designed for real-time monitoring of 2D displacement/deformation fields using DIC algorithm. In the study by Mousa et al. [8], a single smartphone was employed to calculate the three-dimensional displacement field of a glass table. While this approach has proven effective in generating 3D displacement maps, it cannot be accurately classified as a three-dimensional measurement method. This is because it relies on a high-fidelity numerical model of the specimen to accurately derive out-of-plane motion from 2D-DIC measurements. In [9] 3D deformation measurements were performed through a portable smartphone-based pseudo 3D-DIC system. Stereo images were captured with a 3D-printed device consisting of four mirrors attached to a common smartphone and subsequently exported to a computer for displacement analysis by dedicated DIC software. The primary reason for the absence in the literature of 3D systems based on multiple smartphones is the crucial requirement to achieve optimal synchronization between the videos captured by each device. This synchronization is crucial for accurate 3D-DIC measurements. However, achieving video synchronization between smartphones is challenging due to the absence of a dedicated trigger channel in smartphone cameras. Although the literature has introduced hardware and software-based approaches, such as the one outlined in [10], for capturing time-synchronized image sequences from different devices, the complexity of these setups makes them unsuitable for students and occasional DIC users.

In this paper, challenges encountered in synchronizing two smartphone videos are discussed, wherein an external electronic circuit for triggering photos is introduced. This work seeks to explore easy to handle single smartphone-based DIC approaches, suitable for teaching purposes or for preliminary investigation of the dynamic of a specimen. Thus, two DIC setups are examined with the aim of extracting the first modal shape of a beam with a L-shaped cross section. Firstly, the deformed shape of the beam was approximated as a pure flexural mode, and the in-plane displacement components of one side of the beam were extracted to characterize the modal shape. Secondly, to bypass the challenges related to synchronizing two smartphone video acquisitions, a pseudo-3D system utilizing two mirrors was used to analyze the three-dimensional displacement maps of the beam.

2 Digital Image Correlation

Digital image correlation (DIC) is a well-established, non-contact, full-field technique for measuring the displacement and deformation of structures by analysing images under loading conditions. In the subset-based DIC algorithm, the reference image (the one used as the zero reference to calculate displacement and deformation) is divided into smaller regions, called subsets. Displacement and deformation of the object are then calculated using an iterative process to track the position of each subset and compare its shape in subsequent images with the reference image. Consequently, given a series of sample images captured by a camera positioned perpendicular to the movement, it is possible to generate a two-dimensional displacement map for the entire measurement interval at each moment captured by the camera.

For three-dimensional digital image correlation (3D-DIC) measurements, it is essential to acquire at least one stereo image pair at each time of measurement. 3D-DIC allows in-plane and out-of-plane motion of a sample to be measured, thus eliminating 2D-DIC errors caused by misalignment between the camera and the sample. Indeed, in 2D-DIC the out-of-plane movement of the sample (parallel to the camera sensor) cannot be measured and, if present, leads to errors in the in-plane movement measurement. Traditionally, 3D-DIC involves the acquisition of two sets of images with two cameras positioned at relative angles. However, pseudo 3D-DIC setups have been developed in the literature as a cost-effective alternative to the traditional two-camera configuration. These configurations, which are characterised by the use of a single camera, address the limitation of synchronising video from multiple smartphones. Using external optical devices, such as planar mirrors, these systems split the incoming light beams to create two sub-images on the camera sensor, thus generating a dual perspective of the sample using a single camera sensor. Moreover, in 3D-DIC measurements, a calibration process is essential to determine the transformation to map each image point on the camera sensor to its corresponding 3D point in the global coordinate system. Calibration algorithms take as input the characteristics of a calibration target and its images captured by the 3D-DIC (or pseudo 3D-DIC) setup. According to the pinhole optical model [11], this process results in the identification of intrinsic parameters, which define the geometric and optical characteristics of the camera, and extrinsic parameters, which define the position and orientation of the camera relative to a global coordinate system. For pseudo 3D DIC setups, this process calculates the parameters of an equivalent two-camera configuration.

In this paper, both 2D and 3D analysis were performed using open source programs. Ncorr [12] was used to perform the 2D-DIC analysis. For 3D-DIC, the MATLAB Computer Vision Toolbox [13] was used to calibrate the pseudo 3D-DIC setup and to triangulate the image points computed by the 2D-DIC algorithm at each frame.

3 Multi-smartphone camera synchronization

Synchronizing smartphone cameras is a challenging task. Synchronization can be software-based, where smartphones are connected via the same WiFi, see for example [14], or through external hardware trigger signals. The complexity of software-based approaches and the fact that their performance is highly dependent on the characteristics of smartphones makes them unsuitable for the purpose of this work. In this context, since most smartphone models support an external trigger (selfie stick) for capturing photos, this section illustrates the initial efforts made to capture time-synchronised image sequences from two smartphones using external hardware. The presented approach uses an electronic circuit to simulate a selfie stick that triggers the camera of two smartphones. These accessories typically consist of passive electronic circuits utilizing the headphone jack port to transmit a signal to the smartphone. Headphone jack ports typically comprise up to four pins: microphone, ground, left, and right channels, as illustrated in Fig. 1a. Most smartphones test the resistance between the microphone and ground pins. When the resistance exceeds a certain threshold (approximately 5 k Ω), the phone identifies the presence of a microphone. However, when the resistance falls below a specific threshold (about 400 Ω), the phone activates certain features, such as volume up/down or pause. Subsequently, the camera application detects these functionalities and activates the photo-capturing. To emulate a selfie stick for a single phone, the circuit employed is relatively simple, necessitating only two resistors and a button, as depicted in Fig. 1b.

When two or more smartphones need to be synchronized, the process becomes more complex due to the inability to connect the smartphones to the same ground without risking damage to the devices. Furthermore, the circuit must be controlled with a signal generator to control the acquisition. The circuitry consists of one input, the external trigger, and two outputs, the two headphone jacks. These outputs should receive the same signal but remain electronically independent to prevent short circuits and mutual interactions. When the input voltage is around zero, the output has a resistance equal to that of a microphone, while around 3V, the output exhibits a resistance corresponding to the volume-up function. Fig. 2b shows the schematic of the designed circuit, named the "selfie-stick" circuit. This circuit uses optocouplers, namely a semiconductor device that allows an electrical signal to be transmitted between two isolated circuits. Industrially produced optocouplers, such as the 4N35 used in this circuit, are relatively inexpensive. The response time of 4N35 is 3 μ s. Figure 2a presents a prototype of this circuit assembled on a breadboard. The yellow push-button visible in the image can be substituted with a pulse signal generator. To evaluate the performance of this synchronization device, it was connected to two smartphones, that were placed in front of a computer screen displaying a digital stopwatch at 60 fps. The tested smartphones are of identical model (Huawei Mate S), restored to factory condition, with most options turned off (Wi-Fi, Bluetooth), and all apps disabled. This was

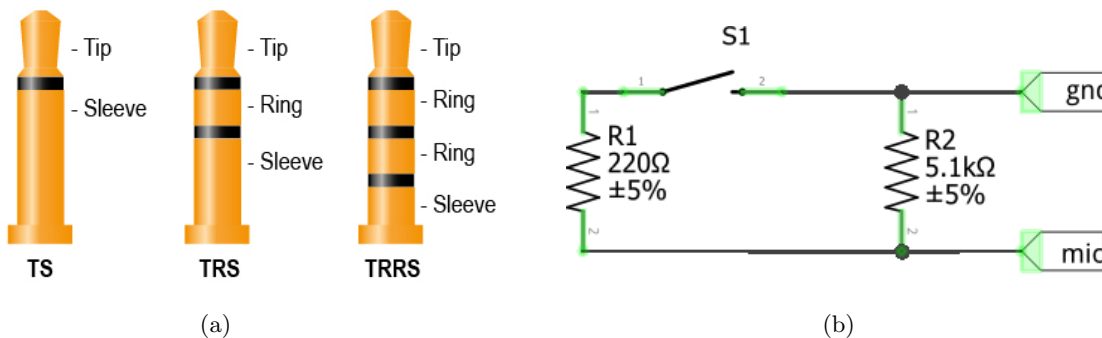

Figure 1: Representation of a 4-pin jack connector (a) and scheme of the circuitry of a selfie stick for a single phone (b).

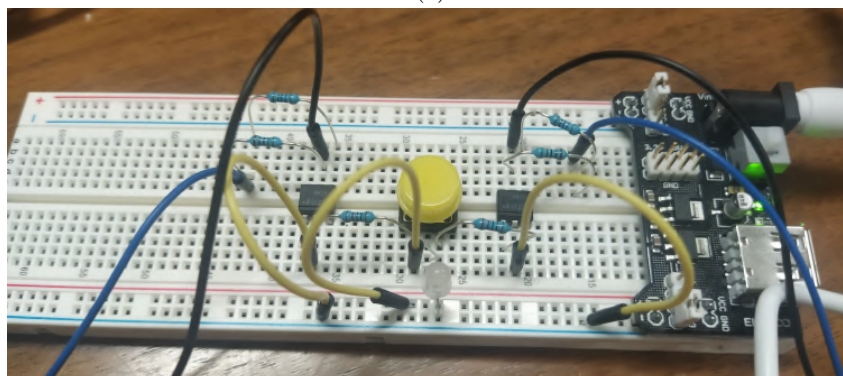
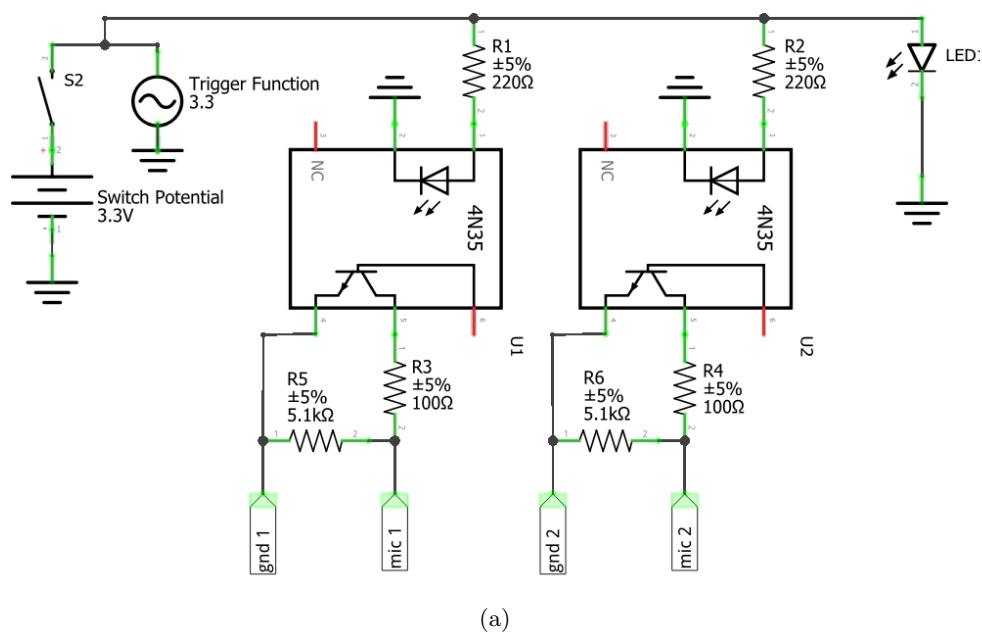

Figure 2: Scheme (a) and prototype (b) of the circuit to give a common external camera trigger to two smartphones.

done to ensure that no external factors would slow down the phones during the experiment. The smartphone cameras were triggered periodically using the selfie-stick circuit and an external function generator. The input signal to the selfie-stick circuit was generated by a function generator producing a square wave with an amplitude of 3.320 V, an offset of 1.65 V, a duty cycle of 3%, and a frequency of 0.5 Hz. Each smartphone captured a photo every 2 seconds. This interval seemed to be the right compromise between the speed of the experiment and ensuring that each image is not affected by the processing of the previous one. Subsequently, the digital stopwatch readings from each image pair were extracted using text recognition. The delay between two images was calculated as the time difference between these readings. The camera shutter speed, which denotes the duration of light exposure on the sensor, was set to its shortest possible duration (1/4000s) to prevent any blurring in images. Thus, 140 image pairs were captured and analyzed. Figure 3 shows the results of the analysis in terms of histogram and probability density function (pdf, assumed as normal distribution) of the delay between two images in one of the experiment. The mean value of the delay is low, less than 5ms, and due to the symmetry of the histogram we can infer that no phone was less responsive than the other on trigger. However, the standard deviation of the distribution is very high, about 130 ms, and this means that the delay between two images cannot be neglected. In conclusion, this triggering method cannot be used to perform dynamic DIC where high-speed motion makes this delay unacceptable for considering image pairs synchronous and a significant number of usable image pairs are required.

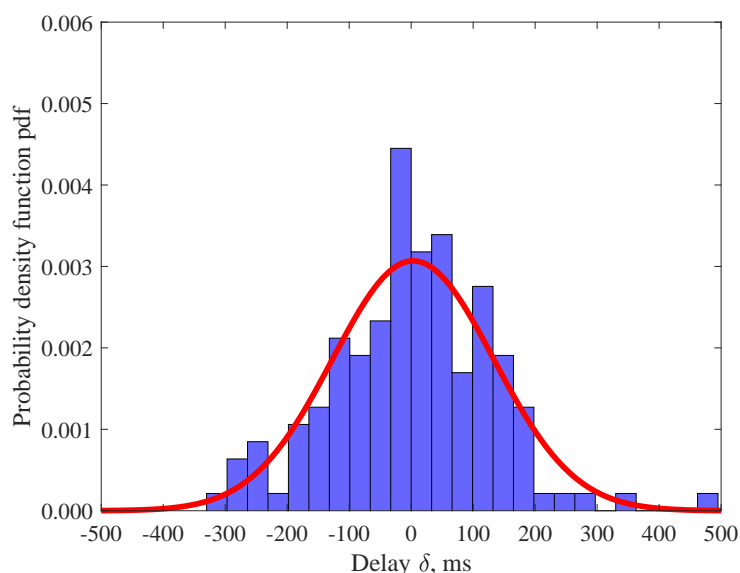

Figure 3: Distribution of the delays between two images during experiment.

4 Experimental setup and results

Figure 4a illustrates the test case, which consists of a PVC beam attached at one end to the moving coil of a shaker, while the other end is free to move. The beam has an L-shaped section geometry and a uniform thickness of 2 mm. The edge attached to the shaker is 20 mm wide, while the other one extends 10 mm. The total length of the beam is 280 mm, with a length of the clamped portion of 4 mm. Surface preparation is essential for correctly performing the DIC when the specimen lacks suitable color characteristics. This is because DIC analysis relies on the uniqueness of subsets of pixels on the specimen surface to ensure that they are tracked in each image. Typically, a speckle pattern is generated on the specimen surface for this purpose. In this experiment, the beam surface was first sprayed with white paint, followed by the application of a black speckle pattern. To investigate the first modal shape of the beam, a sinusoidal signal at 33 Hz, which corresponds to its first resonant frequency, was sent to the shaker. The excited modal shape is mainly flexural, but because of the geometry of the beam section, it also has a torsional component. Modal analysis performed on a FEM model of the beam in Ansys APDL confirms this expected result, as shown in Fig. 4b.

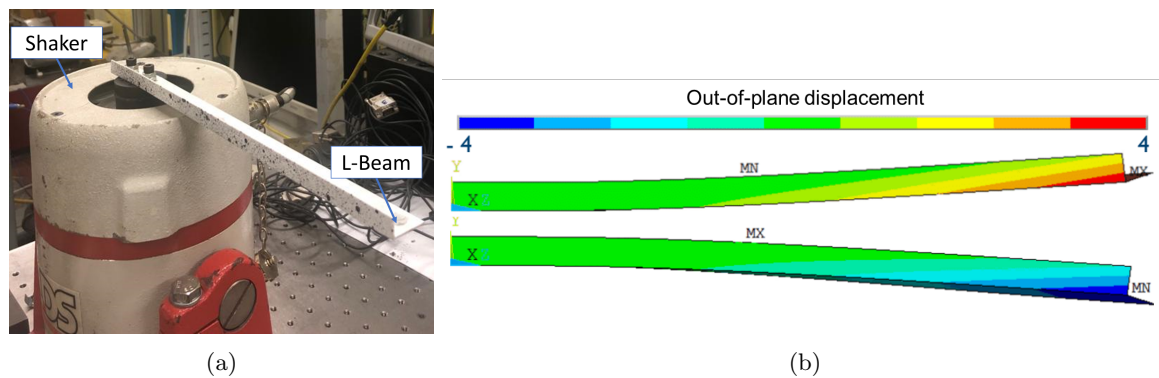

Figure 4: a) Test case: beam clamped to a shaker exciting its first mode shape. b) First mode shape of the beam computed in Ansys APDL, revealing torsional and bending components. Color map refers to the out-of-plane displacement.

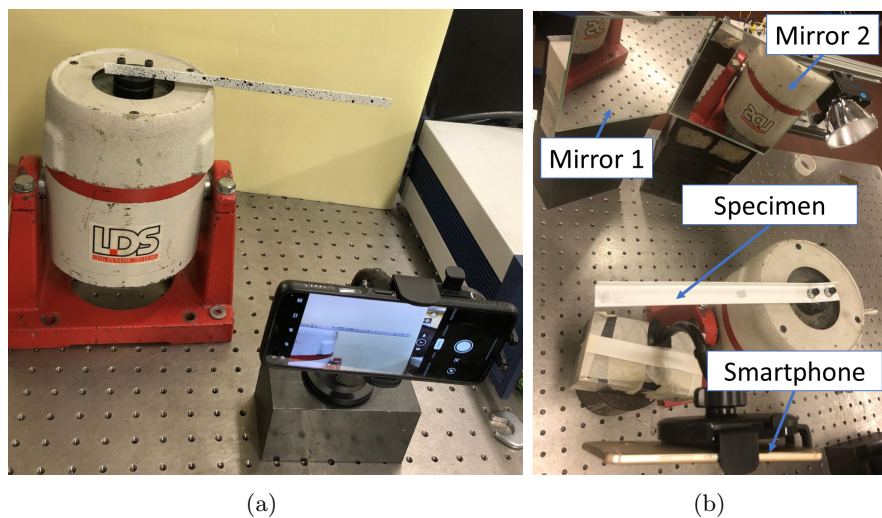

Figure 5: DIC setups: a) Smartphone placement for 2D DIC analysis to keep the camera sensor parallel to the measured edge of the beam. b) Pseudo 3D-DIC system consisting of a smartphone for image capture and two mirrors.

The beam motion was studied by two different DIC setups, shown in Fig. 5. In tests with both setups, the smartphone was set to capture images at 120 fps using the minimum shutter speed and a resolution of 1980x1080 pixels. Once the images were captured, they were exported to a computer for analysis using DIC software.

The first setups involves only one smartphone, allowing us to study the in-plane motion of one edge of the beam. Consequently, during this analysis, the torsional beam motion was neglected and the smartphone was accurately placed in front of the beam. This setup was suitable to capture the bending component of the deformed shape, as shown by the vertical (y-direction) displacement map resulting from the 2D-DIC analysis in Fig. 6a. However, it should be noted that the out-of-plane component of the motion, due to its torsional component and unavoidable misalignment between the camera and the beam, leads to inaccuracies in in-plane motion measurements. This occurs because changes in the scene caused by the torsion of the beam are perceived as in-plane deformation by the 2D-DIC software. Conducting a 3D-DIC analysis, capable of distinguishing all motion components, could mitigate this error. Efforts to synchronise smartphone cameras, discussed in section 3, have revealed difficulties that make them unsuitable for the purposes of this work. Therefore, a pseudo 3D-DIC setup was used. It is shown in Figure 5b and consists of two mirrors and a smartphone. The two mirrors are positioned at a relative angle and allow to simultaneously capture images of a calibration pattern and the movement of

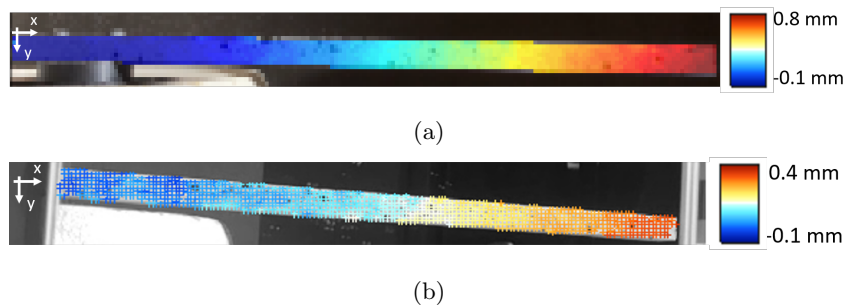

Figure 6: Displacement in the y -direction of a clamped L-beam excited at its first resonance frequency. The results were obtained using smartphone-based DIC approaches: a) Single smartphone 2D-DIC analysis; b) Pseudo-3D DIC system with mirrors and a smartphone.



Figure 7: Out-of-plane displacement map of a clamped L-beam excited at its first resonance frequency obtained using the smartphone-based Pseudo 3D-DIC setup.

the beam from two different perspectives. Thus, this setup allows 3D-DIC analysis by dividing each frame into two images to be analyzed using 3D-DIC algorithm. Also this setup effectively captured the bending component of the deformed shape of the beam. However, it struggles to accurately analyze out-of-plane motion, as shown in Fig.7. This is mainly due to the splitting of the image sensor and the resulting low image resolution, which is not suitable for analyzing the small amplitude motion due to beam torsion.

5 Conclusion

This study presents two different setups for performing Digital Image Correlation (DIC) analysis using a smartphone. They were used to capture the deformed shape of a plastic beam with an L-section geometry excited at a frequency close to its first resonance. Two-dimensional DIC analysis (2D-DIC) is easier than 3D-DIC. It requires the use of a single smartphone and eliminates the need for a stereo-calibration process. However, it's important to note that 2D-DIC typically exhibits lower accuracy than 3D-DIC when compared at the same image scale. This is due to out-of-plane motion caused by the actual movement of the specimen or misalignment between the camera and its plane of motion, which introduces errors into the in-plane measurements. The use of 3D-DIC is therefore recommended for cases involving non-planar motion. Attempts to synchronise multiple smartphone cameras demonstrate the difficulties of this process. In particular, external synchronisation hardware was built and tested. The test was conducted using two identical smartphones at a low frame rate, representing simpler acquisition conditions with respect to the settings required for dynamic testing. However, the delay between most of the acquired image pairs makes this device unsuitable for acquiring video for DIC processing. The adoption of a single smartphone for 3D-DIC analysis (referred to as pseudo 3D-DIC) simplifies the implementation of the technology by eliminating the need for synchronization between multiple cameras. On the other hand, measurements from pseudo-3D systems generally show lower accuracy than those performed with systems employing multiple cameras. This can be attributed to the division of sensor resolution and the introduction of image distortions due to the complexity of additional optical devices. Thus, two easy-to-handle DIC hardware are presented with the aim of providing relatively inexpensive solutions for practising with DIC technology. The proposed procedures are well-suited for teaching purposes, as they yield results from tests that students or beginners can conduct on simple vibrating structures. They also serve for initial qualitative analysis of structural motion.

References

- [1] S. Barone, P. Neri, A. Paoli, and A. V. Razionale. Low-frame-rate single camera system for 3d full-field high-frequency vibration measurements. *Mech Syst Signal Pr*, 123:143–152, may 2019.
- [2] M. Inaba, T. Hara, and H. Inoue. A stereo viewer based on a single camera with view-control mechanisms. In *Proceedings of 1993 IEEE/RSJ International Conference on Intelligent Robots and Systems (IROS '93)*, volume 3, pages 1857–1865 vol.3. IEEE, 1993.
- [3] J. Li, X. Dan, W. Xu, Y. Wang, G. Yang, and L. Yang. 3d digital image correlation using single color camera pseudo-stereo system. *Opt. Laser Technol.*, 95:1–7, oct 2017.
- [4] S. Xia, A. Gdoutou, and G. Ravichandran. Diffraction assisted image correlation: A novel method for measuring three-dimensional deformation using two-dimensional digital image correlation. *Exp. Mech.*, 53(5):755–765, oct 2012.
- [5] G. Morgenthal and H. Höpfner. The application of smartphones to measuring transient structural displacements. *J. Civ. Struct. Health Monit.*, 2(3-4):149–161, oct 2012.
- [6] B. Xie, X. Zhao, J. Li, X. Yan, and X. Lv. Research on 2d digital image correlation measurement based on smartphones. In *Health Monit. Struct. Biol. Syst. XIII*. SPIE, apr 2019.
- [7] G Stoilov, D Pashkouleva, and V Kavardzhikov. Smartphone application for structural health monitoring. *IOP Conference Series: Materials Science and Engineering*, 951(1):012026, oct 2020.
- [8] M. Mousa and M. M. Yussof. A simple two-dimensional digital image correlation model for out of plane displacement using smartphone camera. *J. Eng. Sci. Technol.*, 16:10–17, 02 2021.
- [9] L. Yu, R. Tao, and G. Lubineau. Accurate 3d shape, displacement and deformation measurement using a smartphone. *Sensors*, 19(3):719, feb 2019.
- [10] S. Ansari, N. Wadhwa, R. Garg, and J. Chen. Wireless software synchronization of multiple distributed cameras. In *2019 IEEE International Conference on Computational Photography (ICCP)*. IEEE, may 2019.
- [11] R. Hartley and A. Zissermanw. *Multiple View Geometry in Computer Vision*. Cambridge University Press, March 2004.
- [12] J. Blaber, B. Adair, and A. Antoniou. Ncorr: Open-source 2d digital image correlation matlab software. *Exp. Mech.*, 55(6):1105–1122, mar 2015.
- [13] Inc. The MathWorks. *Image Processing and Computer Vision Toolbox*. Natick, Massachusetts, United State, 2023.
- [14] R. Latimer, J. Holloway, A. Veeraraghavan, and A. Sabharwal. Socialsync: Sub-frame synchronization in a smartphone camera network. In *Computer Vision - ECCV 2014 Workshops*, volume 8926 of *Lecture Notes in Computer Science*, pages 561–575. Springer International Publishing, 2015.