

Design and development of a wearable device for real-time health monitoring and telemedicine

Original

Design and development of a wearable device for real-time health monitoring and telemedicine / Randazzo, V., Reineri, M., Pasero, E.. - ELETTRONICO. - (2025), pp. 1-6. (2025 10th International Conference on Smart and Sustainable Technologies (SpliTech) Bol and Split (Cro) 16-20 June 2025) [10.23919/splitech65624.2025.11091665].

Availability:

This version is available at: 11583/3002292 since: 2025-08-01T12:51:30Z

Publisher:

IEEE

Published

DOI:10.23919/splitech65624.2025.11091665

Terms of use:

This article is made available under terms and conditions as specified in the corresponding bibliographic description in the repository

Publisher copyright

IEEE postprint/Author's Accepted Manuscript

©2025 IEEE. Personal use of this material is permitted. Permission from IEEE must be obtained for all other uses, in any current or future media, including reprinting/republishing this material for advertising or promotional purposes, creating new collecting works, for resale or lists, or reuse of any copyrighted component of this work in other works.

(Article begins on next page)

Design and development of a wearable device for real-time health monitoring and telemedicine

Vincenzo Randazzo

Department of Electronics and Telecommunications

Politecnico di Torino

Turin, Italy

vincenzo.randazzo@polito.it

Matteo Reineri

DET

Politecnico di Torino

Turin, Italy

Eros Pasero

Department of Electronics and Telecommunications

Politecnico di Torino

Turin, Italy

eros.pasero@polito.it

Abstract—Wearable medical devices have evolved from basic fitness trackers to sophisticated health-monitoring tools capable of acquiring vital physiological parameters. This paper presents the design and development of an enhanced version of the PulsECG, a wearable device aimed at real-time health monitoring. The upgraded smartwatch integrates electrocardiogram (ECG), photoplethysmography (PPG) for oxygen saturation measurement, a body temperature sensor, and an accelerometer for movement analysis. The system features optimized printed circuit board (PCB) design, low-power consumption, and data transmission via Bluetooth to a smartphone application. The added temperature and motion sensors enhance the device's ability to monitor user activity and detect potential health anomalies, making it particularly useful for telemedicine applications and chronic disease management. Compared to traditional medical monitoring systems, this wearable device offers a non-invasive and convenient solution for continuous health tracking. Validation tests demonstrate the device's ability to acquire reliable ECG, PPG, motion, and temperature data, while maintaining user comfort and ease of use, supporting its application in telemedicine and continuous health tracking. The presented advancements contribute to the growing field of wearable healthcare technology, improving accessibility and efficiency in remote patient monitoring.

Index Terms—Telemedicine, Human-body temperature measurement, PulsECG, ECG, PPG, accelerometer, wearable devices

I. INTRODUCTION

Once only used to count steps and tell time, smartwatches are now, in some cases, real medical monitoring devices with accurate healthcare tools. They allow users to read phone notifications or send simple messages, but also provide a wide choice of sports tracking features, as well as a constant monitoring of the main vital signs.

The market of wearable healthcare devices has exponentially increased in the last years. Due to the need of consumers to monitor their own health, the trend will continue to grow. A research done by Grand View Research estimates the global wearable medical device market size was valued at USD 42.74 billion in 2024 and is expected to expand at a compound annual growth rate (CAGR) of 25.53% from 2025 to 2030 [1]. Meanwhile, the market size of wearable medical device for cardiac monitoring exceeded USD 1.5 billion in 2020 and is anticipated to grow at a CAGR of over 24.7% between 2021 and 2027 [2].

The high demand, in particular for smartwatches, brought the biggest technology companies, e.g. Apple and Samsung, to work together with medical counterpart to design an increasing number of devices for telemedicine and self-monitoring. The business is, as always in such cases, trying to build watches with more and more functionalities without affecting dimensions and comfort [3]. The race of the major companies for lead the wearable fitness market, has brought benefits also on the wearable healthcare technology [4]. Wearable healthcare devices were mainly designed to collect the user health data. However, they are not limited to data acquisition but they can also send information to a doctor or other healthcare clinics in real time, for a better patient monitoring and pathologies analysis. An example of how the business has evolved is Apple. Leader in smartphone market, Apple launched the Apple Heart Study application in 2017 to monitor user heart rhythms with its smartwatch and alert those who are experiencing atrial fibrillation [5].

Based on product, the market is segmented into Holter monitors, smartwatches, defibrillators, pulse oximeters, and other products [6]. The smartwatches segment dominated the wearable cardiac devices market accounting for 28.2% of revenue share in 2024 [2] and is likely to remain dominant for the next years.

Due to the increasing average age in the population and the need to reduce health care spending, telemedicine is widespread [7]. This trend is undoubtedly related to the effect of Covid-19 pandemic which has led to increased awareness of personal health monitoring [8]. Another driver in the development of this market is the need of a constant monitoring of some chronic diseases [9], [10], such as diabetes and hypertension. For these examples, it is required a continuous monitoring of various physiological parameters as blood sugar levels and blood pressure. These types of diseases are expected to increase over the next few years, all due to the sedentary lifestyle that characterizes our society.

This paper describes the second generation of the PulsECG [11], previously developed by the authors at the Neuronica Lab to measure blood oxygenation and electrocardiogram. In this work, a temperature sensor and an accelerometer were added to the device to monitor the user body temperature and movements.

II. MARKET AVAILABLE SMARTWATCH FEATURES

The spread of the smartwatch instead the traditional ones pass through the willingness of the people to taking care of yourself and easily discover its state of health [12]. The main features supported by current smartwatches are:

- The mirroring of the main smartphone utilities: the user can see notifications, write simple messages, manage music or use GPS-based apps.
- Record and provide meaningful information about their sport activity: e.g. the duration, the distance covered, or the calories burned.
- The periodic measurement of some vital parameters like the heartbeat, or SpO_2 saturation.

Any smartwatch model allow the user to see and share his data directly on his smartphone. If on the one hand people can better discover their body, taking interest about their health, the biggest opportunity of this technology is their ease of use in telemedicine applications [13]. Medical wearable devices in some cases can replace big and uncomfortable equipments, making easier read and control a lot of vital parameters of patients [14].

III. ACQUIRED VITAL SIGNS

In the following, it is provided a brief description of the main acquired healthcare signals.

A. Electrocardiogram

The electrocardiogram (ECG) is the graphical representation of the heart electrical activity. Potential differences of cardiac pulses are propagated along the human body and they can be acquired by electrodes on the skin. A typical ECG segment, shown in Fig. 1, is characterized by some fiducial points - namely P,Q,R,S,T - as well as their intervals [15]:

- P wave: it is the first wave of the segment and identifies the atrial depolarization (atrial electrical activation).
- Q wave: first negative deflection. The wave has a small size and corresponds to the interventricular depolarization;
- R wave: first positive deflection. It represents the depolarization of the left ventricle, i.e. the heartbeat.
- S wave: second negative deflection. It has low size like Q wave and shows the depolarization of the left ventricle back part.
- T wave: the first positive wave after the QRS compound, it represent the ventricular repolarization. The repolarization is the recovery of the base electric conditions. This little wave is not always visible.
- PR interval: the interval between the begin of the P wave and the begin of the QRS compound. It represents the necessary time for the atrial depolarization to reach ventricles.
- QRS complex: it identifies the ventricular depolarization.
- ST segment: the distance between S wave and T wave, it represents the time interval between the ventricular depolarization and the ventricular repolarization.

- QT interval: the distance between the begin of the QRS compound and the end of T wave. It identifies the whole ventricular electrical activity.

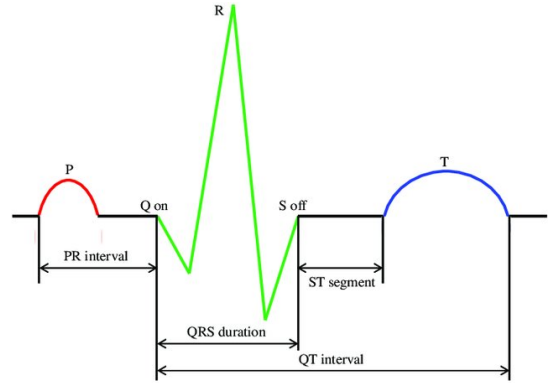

Fig. 1. The fiducial points and features of an ECG signal [16]

B. Heart-rate

The heart rate is defined as the number of heart beats that occur in one minute (*bpm*). Usually, the heart rate in normal conditions goes from 60 and 100 bpm. There are different methods to evaluate the heart rate through the heart trace: the easiest is to divide 300 for the number of the square between two R waves. Fig. 2 shows an example of a heart rate of 85 rpm measured from an ECG trace.

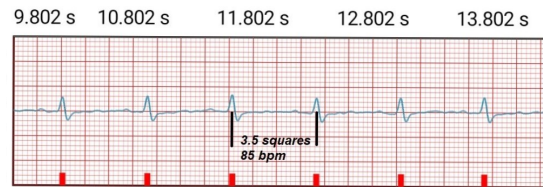

Fig. 2. Heart-rate evaluation from ECG

C. Oxygen saturation - SpO_2

The oxygen saturation is a blood characteristic that indicates the percentage of haemoglobin full of oxygen respect the total number. In standard conditions, during the breath, red blood cells full of haemoglobin take the oxygen to transport it. Standard levels of SpO_2 is between 95% and 100%. Lower values of are defined as *hypoxemia*. This status can be taken by cardiopulmonary criticality, sleep apnea, some medicines or high altitude. Common symptoms are migraine, high heart rate, cough or cyanosis. The measurement of this parameter is done thanks two different sections of the sensor, as shown in Fig. 3: the transmitter and the receiver. The transmitter is composed by a led that emits light into the finger. Haemoglobin with oxygen absorbs infrared light, haemoglobin without oxygen absorbs red light. The receiver collect all the reflected light not absorbed by the finger. The difference between the emitted and received light allow the sensor to evaluate the percentage of SpO_2 in blood.

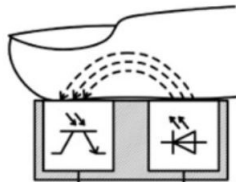

Fig. 3. SpO₂ measurement description

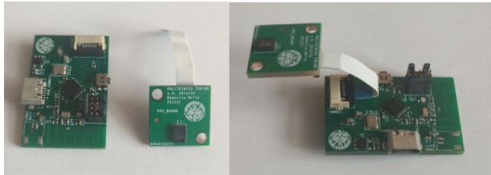

Fig. 4. The PulsECG device

D. Body temperature

The temperature of the superficial skin is strongly influenced by environmental conditions and clothing, especially at the extremities (hands and feet). To give an idea, if the ambient temperature is 20° C and the clothing light, the temperature at the level of the arms drops to 32° C, while on the outermost skin layers the temperature ranges from 28° C (fingertips) onwards. Also, these values mentioned above are only a point of reference, but each person has different temperatures. Some factors on which body temperature depends are: ambient temperature; characteristics of the individual person (gender, age); nutrition; training and physical activity.

For these reasons, each person can have different temperatures from another, even though they are both healthy. One way to be able to estimate one's body temperature is to use Liebermeister's rule [17], which shows how the heart rate is strongly influenced to body temperature: the heart rate increases by 8-10 beats per minute for every degree centigrade the user has relative to his or her base temperature. Long term monitoring could make the watch capable of detecting the user's resting body levels and help with heart rate measurements to refine the body temperature measurement.

IV. THE DEVICE

The PulseECG is a healthcare wearable developed to acquire two main vital measurements:

- The electrocardiogram, giving the heart trace and the heart rate value.
- The oxygen saturation in blood.

The watch is composed by two printed circuit boards, shown in Fig. 4: the biggest board has the energy management components, the microcontroller and ECG filter section. The second board has the oxygen saturation measurement with the SpO₂ sensor. Flat wires allow the electrical connection between the printed circuit board (PCBs).

There are also two electrodes: they are the interface of the watch with the user. One electrode is located on the bottom

side of the watch, in contact with the wrist. The other one, on the upper side, is in contact with the user only when it is touched with a finger. Signals received from electrodes will be filtered and elaborated by the ECG board and microcontroller.

The watch is connected through Bluetooth connection with the smartphone application, which processes the data sent by the watch and shows the ECG and SpO₂ graphs. Charts are stored in an archive with the timestamp of the measurement. The operating principle is based on the potential difference of electrical pulses that pass through electrodes. The signals are read with the analog to digital converter (ADC) of the microcontroller and, then, data are sent to the smartphone application, which stores it in the smartphone memory. When the finger touches the upper electrodes, the SpO₂ sensor measures the oxygen saturation.

This work extends the previous version by adding new sensors, which implied a redesign of the existing printed circuit board (PCB):

- temperature body sensor: it is connected to the electrode in contact with the skin in order to read the temperature of the user when is wearing the watch. For this implementation a new dedicated PCB was designed, which does not increase the surface needed for the watch because it was placed exactly below the ECG board.
- accelerometer for motion detection: used to elaborate every data concerned the movement of the user. The accelerometer has been placed on the main PCB, near the push button, without the need to increase the previous board size.

Finally, the new device was designed to host a flash memory to store the acquisitions directly into the device, so that in case of miscommunication with the smartphone app, acquired data would not be lost.

In order to add the new functionalities, mentioned above, the PulsECG hardware design required the development of three separated PCBs, connected through flat cables:

- ECG board: the main board, the largest. It includes the power management, data processing, the ECG front-end, and the accelerometer.
- PPG board: in this board there is the PPG sensor and the flash memory.
- Temperature board: it contains the temperature sensor.

Since the device was designed to be used as a wearable tool, during the PCB design phase, particular attention was put in reducing as much as possible its size, as well as to minimize its power consumption. At this purpose, were selected only low-power components.

A. ECG board

This is the main and largest PCB. Its architecture is inspired from the ECG Watch device [18], [19]. Indeed, the board front-end for ECG analogue signal filtering is kept as simple as possible to avoid acquisition artifacts. More in detail, the ECG board, shown in Fig. 5, has the following structure:

- the microcontroller, the Texas Instruments (TI) CC2640R2F [20], in the middle of the board, an

Arm Cortex-M3 with a 2.4 GHz RF transceiver compatible with Bluetooth Low Energy (BLE) 5.1;

- the 3-axis accelerometer, the Memsic MXC6655XA [21], in the bottom of the board, described in Sec. IV-B;
- the 3.7 V 190mAh Li-Po battery, and the micro-USB connector, in the top left of the drawing;
- the power management circuit, in the top left of the drawing, made by the battery gauge, the battery charger, the voltage regulator, the ST microelectronics DVIULC6-2M6 [22] ESD protection diode, and the mosfet for isolating the device during battery charging;
- the BLE patch antenna on the left;
- the ECG analog front-end on the right side, based on the TI INA333 [23] and TI OPA4330 [24] amplifiers;
- the EVQ-PUB02K push button [25] to wake up the device;
- the LEDs: one red (SML-P11UTT86R [26]) to signal the device is charging, and one green (SML-P13PTT86R [27]), driven by the microcontroller when the watch is on.

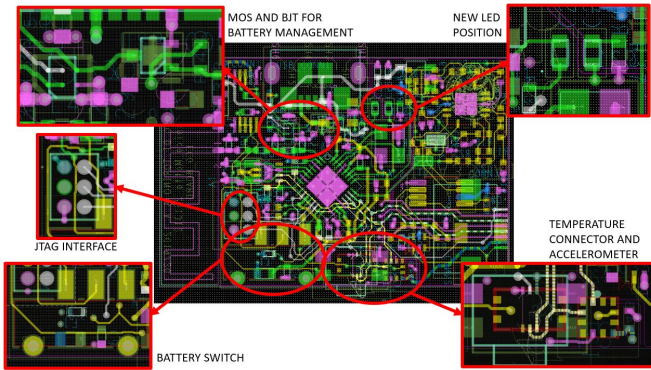

Fig. 5. ECG PCB

B. Accelerometer

The Memsic MXC6655XA is an ultra-low power, low-noise, integrated digital output 3-axis accelerometer with a feature set optimized for wearables and consumer product motion sensing [21]. It can operate from 1.8 V to 3.6 V and has 12-bit resolution, which is used to understand if: the user is wearing or not the device, and the user physical activity level. The former can be used to put the device in sleep mode and, thus, increase battery duration; the latter to correct the heart rate and oxygen saturation measurements, and to detect user falls. Therefore, for the proposed use case, it is not necessary to have a very accurate accelerometer, since it must only measure falls or inactivities.

C. PPG board

The PPG board contains the SpO_2 sensor MAXM86161 [28], and the Flash memory unit W25N01GV [29].

The MAXM86161 is an ultra-low-power optical data acquisition system based on an 19-bit ADC. On the transmitter side, the MAXM86161 has three programmable high-current LED

drivers. On the receiver side, MAXM86161 consists of a high efficiency PIN photo-diode and an optical readout channel. The LED current DACs have 8 bits of dynamic range with four programmable full-scale ranges of 31 mA, 62 mA, 94 mA, and 124 mA. The LED pulse width can be programmed from 14.8 us to 117.3 us to allow the algorithms to optimize the accuracy.

The W25N01GV (1G-bit) Serial SLC NAND Flash Memory provides a storage solution for systems with limited space, pins and power. The W25N SpiFlash family incorporates the popular SPI interface and the traditional large NAND non-volatile memory space. They are ideal for code shadowing to RAM, executing code directly from Dual/Quad SPI (XIP) and storing voice, text and data.

D. Temperature board

To avoid temperature bias coming from ground planes and the circuit heating, it was chosen to put the MAX30205 human body temperature sensor [30] in a separate board. The sensor accurately - 16-Bit (0.00390625°C) temperature resolution - measures human temperature (0.1° C accuracy in the range 37° C to 39° C) and can provide an overtemperature alarm output. Accuracy meets clinical thermometry specification of the ASTM E1112 standard [31]. Communication is through an I2C-compatible, 2-wire serial interface.

V. VALIDATION AND TESTING

A. ECG and PPG validation

To verify that the board update and component soldering activities have been properly performed, a simple ECG and PPG acquisition through the application was performed. Already implemented in the previous PulsECG version, it was important know that the new implementations have not affected existing functionality. Fig. 6 shows that the device is still able to acquire good ECG and PPG, as its predecessor.

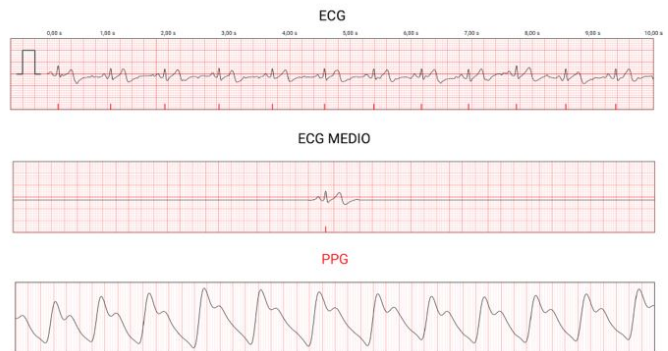

Fig. 6. Example of ECG and PPG acquisition

B. Orientation testing

One of the most common information that accelerometers can give is its position in space. To do so, it uses the gravity: depending on the axis on which it feels the exertion of this force, it can derive in which way the sensor is positioned

relative to the vertical. Fig. 7 shows the accelerometer is able to recognize all the possible device orientations:

- In "BOARD" column there is the picture of the board under test, at the orientation where the measurement was taken.
- In "AXIS" column there is the indication of the axis orientation referred to the board orientation in the picture.
- In "HEX BYTE" column there is the value of the accelerometer orientation register, obtained during the measurement, in hexadecimal value.
- In "POS" columns the register value is unpacked obtaining the bit useful to have the space information for each axis.











BOARD	AXES	HEX BYTE	POS[3]	POS[2]	POS[1]	POS[0]
		0x1F 0x1D 0x1C 0x1E	1 1 1 1	1 1 1 1	1 0 0 1	1 1 0 0
		0x18 0x19 0x1B 0x1A	1 1 1 1	0 0 0 0	0 0 1 1	0 1 1 0
		0x14 0x10	0 0	1 0	0 0	0 0
		0x16 0x12	0 0	1 0	1 1	0 0
		0x17 0x13	0 0	1 0	1 1	1 1
		0x15 0x11	0 0	1 0	0 0	1 1

Fig. 7. Accelerometer orientation test

C. Acceleration testing

To validate the accelerometer behaviour in dynamic conditions, a free fall test was performed, as shown in Fig. 8. Even when stationary, the accelerometer senses the force of gravity. This implies that under static conditions on the vertical axis it will never read acceleration equal to zero, but it will value $\pm g$ depending on the axis orientation. During free fall, the accelerometer will feel the force of gravity bringing the value close to 0. It can be seen from the graph that the fall occurred along the Z axis. Since it is impossible to keep the device perfectly straight during the fall, the impact with the ground does not occur with the Z axis perfectly vertical. From this, it follows that the board lands in a disjointed manner and the accelerations/decelerations due to the bounce phase are seen in all axes, before returning to the static condition of the device stationary on the desk. However, Fig. 8 shows the chosen accelerometer can be used for monitoring physical activity and detecting falls.

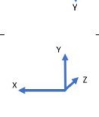
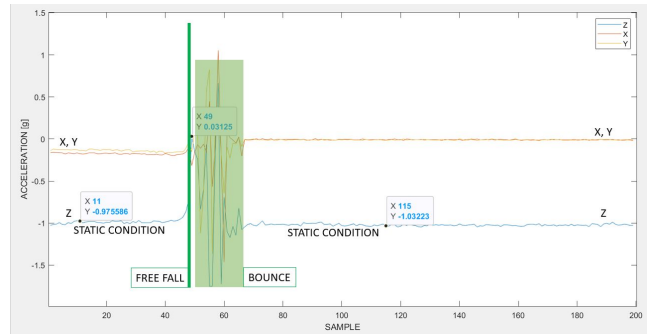

Fig. 8. Free fall test

D. Temperature testing

The first temperature test carried out is the verification of the correct measurement of ambient temperature. The values measured by the sensor, shown in Fig. 9, were compared with the temperature read by the MAX30205 evaluation board, shown in Fig. 10. As it can be noted, these two values are coherent, i.e. 29.8° C

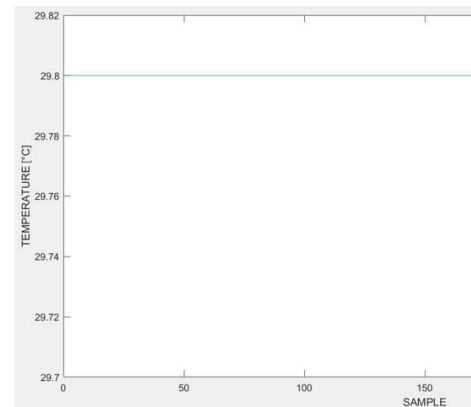

Fig. 9. Ambient temperature test with PCB board

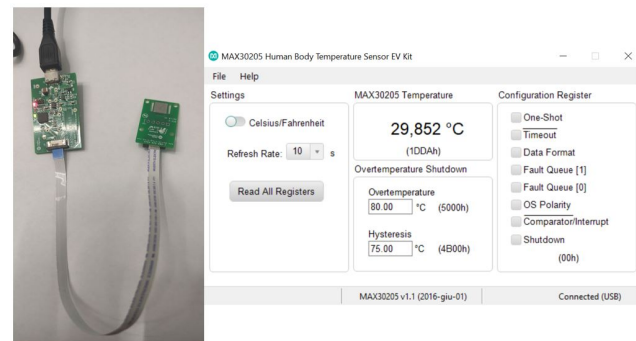

Fig. 10. Ambient temperature test with evaluation board

The second temperature test is performed by holding the finger over the temperature board for 2.5 minutes. Also in this case, temperatures of PulseECG and the evaluation board are very similar, as shown by Fig. 11.

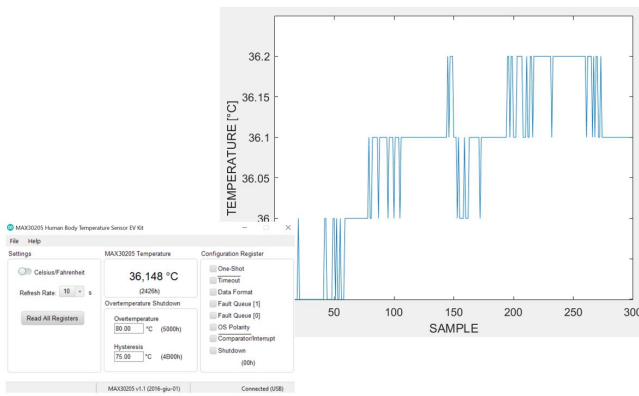

Fig. 11. Finger temperature test

VI. CONCLUSIONS

The second-generation of PulsECG smartwatch represents a significant step forward in wearable medical technology, offering an expanded set of features for comprehensive health monitoring. The integration of an ECG sensor, PPG module, body temperature sensor, and accelerometer enables a holistic approach to patient data acquisition while maintaining a compact and power-efficient design. Validation tests demonstrate the device's ability to acquire reliable ECG, PPG, motion, and temperature data, while maintaining user comfort and ease of use, supporting its application in telemedicine, non-invasive continuous health tracking, and remote patient monitoring.

Future developments may focus on refining AI-driven data analysis for anomaly detection, integrating additional biometric sensors, and enhancing device connectivity with cloud-based healthcare platforms. Expanding clinical validation studies and regulatory approvals will be essential for widespread adoption in medical applications. With continuous advancements, wearable devices like the PulsECG have the potential to revolutionize telemedicine, enabling early disease detection and personalized healthcare solutions.

ACKNOWLEDGMENT

The authors thanks Jacopo Ferretti for his initial support.

REFERENCES

- [1] G. V. Research, "Wearable Medical Devices Market Size | Industry Report 2030."
- [2] G. M. Insights, "Wearable Cardiac Devices Market Size, Growth Forecasts 2034."
- [3] N. Muñoz-Urtubia, A. Vega-Muñoz, C. Estrada-Muñoz, G. Salazar-Sepúlveda, N. Contreras-Barraza, N. Salinas-Martínez, P. Méndez-Celis, and J. Carmelo-Adsuar, "Wearable biosensors for human health: A bibliometric analysis from 2007 to 2022," *Digital health*, vol. 10, p. 20552076241256876, 2024.
- [4] D. Fuller, E. Colwell, J. Low, K. Orychock, M. A. Tobin, B. Simango, R. Buote, D. Van Heerden, H. Luan, K. Cullen, *et al.*, "Reliability and validity of commercially available wearable devices for measuring steps, energy expenditure, and heart rate: systematic review," *JMIR mHealth and uHealth*, vol. 8, no. 9, p. e18694, 2020.
- [5] M. P. Turakhia, M. Desai, H. Hedlin, A. Rajmane, N. Talati, T. Ferris, S. Desai, D. Nag, M. Patel, P. Kowey, *et al.*, "Rationale and design of a large-scale, app-based study to identify cardiac arrhythmias using a smartwatch: The apple heart study," *American heart journal*, vol. 207, pp. 66–75, 2019.

- [6] A. A. Silverio, C. G. Suarez, L. A. A. Silverio, J. Y. Dino, J. B. Duran, and G. E. G. Catambing, "An unobtrusive, wireless and wearable single-site blood pressure monitor based on an armband using electrocardiography (ecg) and reflectance photoplethysmography (ppg) signal processing," *Electronics*, vol. 12, no. 7, p. 1538, 2023.
- [7] V. Randazzo, E. Pasero, and S. Navaretti, "Vital-ecg: A portable wearable hospital," in *2018 IEEE Sensors Applications Symposium (SAS)*, pp. 1–6, IEEE, 2018.
- [8] J. R. Walter, S. Xu, and J. A. Rogers, "From lab to life: how wearable devices can improve health equity," *Nature communications*, vol. 15, no. 1, p. 123, 2024.
- [9] Y. Guo, X. Liu, S. Peng, X. Jiang, K. Xu, C. Chen, Z. Wang, C. Dai, and W. Chen, "A review of wearable and unobtrusive sensing technologies for chronic disease management," *Computers in Biology and Medicine*, vol. 129, p. 104163, 2021.
- [10] R. S. Santos, M. McInnis, and J. Salinet, "Diagnostic and monitoring of atrial fibrillation using wearable devices: A scoping review," in *Brazilian Congress on Biomedical Engineering*, pp. 791–798, Springer, 2020.
- [11] V. Randazzo, P. Buccellato, J. Ferretti, F. Delrio, and E. Pasero, "Pulsecg-a cuffless non-invasive blood pressure monitoring device through neural network analysis of ecg and ppg signals," in *2024 IEEE 22nd Mediterranean Electrotechnical Conference (MELECON)*, pp. 1030–1035, IEEE, 2024.
- [12] A. A. Smith, R. Li, and Z. T. H. Tse, "Reshaping healthcare with wearable biosensors," *Scientific Reports*, vol. 13, no. 1, p. 4998, 2023.
- [13] A. Azizan, W. Ahmed, and A. H. A. Razak, "Sensing health: a bibliometric analysis of wearable sensors in healthcare," *Health and Technology*, vol. 14, no. 1, pp. 15–34, 2024.
- [14] V. Randazzo, J. Ferretti, and E. Pasero, "A wearable smart device to monitor multiple vital parameters—vital ecg," *Electronics*, vol. 9, no. 2, p. 300, 2020.
- [15] V. Randazzo, E. Puleo, A. Paviglianiti, A. Vallan, and E. Pasero, "Development and validation of an algorithm for the digitization of ecg paper images," *Sensors*, vol. 22, no. 19, p. 7138, 2022.
- [16] S. Lee, Y. Jeong, J. Kwak, D. Park, and K. H. Park, "Advanced real-time dynamic programming in the polygonal approximation of ecg signals for a lightweight embedded device," *IEEE Access*, vol. 7, pp. 162850–162861, 2019.
- [17] B. S. Shah, "A mirror-image relationship between temperature and pulse," *JAMA*, vol. 242, no. 25, pp. 2760–2761, 1979.
- [18] V. Randazzo, J. Ferretti, and E. Pasero, "Anytime ecg monitoring through the use of a low-cost, user-friendly, wearable device," *Sensors*, vol. 21, no. 18, p. 6036, 2021.
- [19] V. Randazzo, J. Ferretti, and E. Pasero, "Ecg watch: a real time wireless wearable ecg," in *2019 IEEE International Symposium on Medical Measurements and Applications (MeMeA)*, pp. 1–6, IEEE, 2019.
- [20] "CC2640R2F data sheet, product information and support | TI.com." <https://www.ti.com/product/CC2640R2F>.
- [21] "MXC6655XA-Thermal Accelerometer-MEMSIC Semiconductor Co., Ltd." <https://www.memsic.com/thermal-accelerometer-71>.
- [22] "DVIULC6-2x6 - Ultra Low capacitance 2 lines ESD protection - STMicroelectronics." <https://www.st.com/en/protections-and-emifilters/dviulc6-2x6.html>.
- [23] "INA333 data sheet, product information and support | TI.com." <https://www.ti.com/product/INA333>.
- [24] "OPA4330 data sheet, product information and support | TI.com." <https://www.ti.com/product/OPA4330>.
- [25] "EVQ PUB02K | Panasonic Industrial Devices." <https://na.industrial.panasonic.com/products/switches-encoders-interface-devices/switches/series/79279/model/79356>.
- [26] "SML-P11UT(R) - Data Sheet, Product Detail | ROHM.com."
- [27] "SML-P13PT(R) - Data Sheet, Product Detail | ROHM.com."
- [28] "MAXM86161 Datasheet and Product Info | Analog Devices." <https://www.analog.com/en/products/maxm86161.html>.
- [29] "W25N01GV - QspiNAND Flash - Code Storage Flash Memory - Winbond."
- [30] "MAX30205 Datasheet and Product Info | Analog Devices." <https://www.analog.com/en/products/max30205.html>.
- [31] *Annual Book of ASTM Standards*, vol. 13.01, ch. Standard Specification for Electronic Thermometer for Intermittent Determination of Patient Temperature. ASTM international, 2018.