

A model-based approach to long-term energy planning: the case-study of the Turin Airport

Original

A model-based approach to long-term energy planning: the case-study of the Turin Airport / Prussi, M.; Laveneziana, L.; Misul, D.; Chiaramonti, D.; Odisio, M.; Restaldo, G.. - In: JOURNAL OF PHYSICS. CONFERENCE SERIES. - ISSN 1742-6588. - ELETTRONICO. - 2648:(2023), pp. 1-19. (78th ATI Annual Congress (Energy transition: Research and innovation for industry, communities and the territory Carpi (Italia) 14/09/2023) [10.1088/1742-6596/2648/1/012034].

Availability:

This version is available at: 11583/2984839 since: 2024-01-04T17:24:07Z

Publisher:

IOP Publishing Ltd

Published

DOI:10.1088/1742-6596/2648/1/012034

Terms of use:

This article is made available under terms and conditions as specified in the corresponding bibliographic description in the repository

Publisher copyright

(Article begins on next page)

PAPER • OPEN ACCESS

A model-based approach to long-term energy planning: the case-study of the Turin Airport

To cite this article: M. Prussi *et al* 2023 *J. Phys.: Conf. Ser.* **2648** 012034

View the [article online](#) for updates and enhancements.

You may also like

- [Anti-nuclei production at the LHC measured with ALICE](#)
Stefania Bufalino and for the ALICE Collaboration
- [The Takagi Equations in Evaluating the Contributions of some Systematic Errors in Scanning LLL X-ray Interferometers](#)
E Vittone and G Zosi
- [Towards a Model of Local and Collective Mechanisms in Multicellular Tumor Spheroids Growth](#)
P P Delsanto, L Morra, S Delsanto et al.

PRIME
PACIFIC RIM MEETING
ON ELECTROCHEMICAL
AND SOLID STATE SCIENCE

HONOLULU, HI
Oct 6-11, 2024

Abstract submission deadline:
April 12, 2024

Learn more and submit!

Joint Meeting of
The Electrochemical Society
•
The Electrochemical Society of Japan
•
Korea Electrochemical Society

A model-based approach to long-term energy planning: the case-study of the Turin Airport

M. Prussi^{1,†}, L. Laveneziana¹, D. Misul¹, D. Chiaramonti¹, M. Odisio², G. Restaldo²

¹ Polytechnic University of Turin, Department of Energy (DENERG), Corso Duca degli Abruzzi 24, Turin, Italy

² SAGAT S.p.A., Società Azionaria Gestione Aeroporto Torino, Strada San Maurizio 12, Caselle Torinese, Turin, Italy

E-mail: †matteo.prussi@polito.it

Abstract. Urged by the concerns relating to climate change and the energy crises, several companies and industries have been undertaking a deeply transformation of their energy system. Energy planning, especially with a long-term perspective, has assumed a renewed importance. The traditional approaches about energy planning, typically relying on a single-project analyses and a short-term vision, appear today unsuitable for evaluating the disruptive transformation of the energy system. In this paper, we propose an energy system optimization approach, based on a detailed energy planning, and we discuss its application to an energy intensive industry: airports. In the context of the European TULIPS project, the energy system of the fellow airport of Turin was modelled in the open-source OSeMOSYS framework. The model was then validated on a set of reference years of operation of the airport. The results of the modelling exercise showed minor variations with respect to real-world data, with a percent error well below 2.5%. Having assessed the ability of the model to reproduce the behavior of the energy system, future studies will be devoted to the development of a decarbonisation roadmap for Turin Airport.

1. Introduction

Despite the downfall suffered during the Covid-19 crisis, air traffic is expected to quickly realign to the steady growth observed before 2019 [1]. According to a recent ICAO study [2], passenger travel demand in the European area is projected to increase by 2.5% annually over the next 30-year period. Strongly bounded with the passengers demand, the concerns about the environmental impact of aviation, a notoriously hard-to-abate sector, are becoming a key element for the sector development [3].

While much attention is usually paid to the decarbonisation of flight operations, the impact of aviation-related activities taking place on-ground is often not spotted in existing literature. Airports are transport infrastructures which are expected to play a crucial role in supporting the aviation sector. Airport are energy- and material-intensive industries [4]. Although the literature comparing the relative impact of flight against ground operations is scarce, some studies suggest that the Greenhouse Gas (GHG) emissions associated with airport operations should definitely not be neglected [4, 5]. To this extent several airport operators and international associations have committed to reduce their environmental impact [6]. Among the numerous initiatives supporting this transition, it is worth mentioning the Net Zero 2050 resolution put forward by the Airport Council International (ACI) Europe [7] [8].

Turin airport is among the organisations which committed to the Net Zero 2050 target. The airport is located in the Piedmont region, in northern Italy. Turin Airport is representative of a large regional airport, with a passenger traffic of 4 million people, and about 45 thousand scheduled flights (2019 data) per year. On the pathway towards the Net Zero 2050 goal, it plans to reduce its emissions by 58% in 2030 (2009 reference) [9]. To this aim, Turin Airport is



developing a transition roadmap, which would radically transform the energy system of the airport. Energy models could offer a valuable support to this challenging process.

A rich body of literature has investigated the application of energy models to airport infrastructures [10–14]. A considerable number of studies has applied building energy models to assess the thermal performance of the airport facilities [15, 16], in particular the passengers terminal [17–20]. Others have analysed single components of the energy system, such as photovoltaic plants [21], and Combined Heat and Power (CHP) or Combined Cooling Heat and Power (CCHP) units [22–26]. Only few studies have analysed the airport at the system level, but taking into consideration only one or few years of operation [27–29]. None of the reviewed studies was able to conjugate a system-level planning with a long-term perspective. Neglecting long-term dynamics in the planning process (varying energy prices, emergence of disruptive technologies, etc.) could lead to economically sub-optimal solutions. Moreover, given the extent of the modifications needed to decarbonise the airport infrastructure, a system-level approach would be needed to capture the interactions between different components of the energy system. In summary, it can be argued that traditional tools of analysis could be unfitted to support the development of a transition roadmap for airports.

In this work, conducted in the context of the European TULIPS project [30], we propose an energy system optimisation approach to support energy planning, investigating its application to the case-study of Turin Airport. Based on a review conducted by the authors in a previous work, the open-source OSeMOSYS framework was selected for the analysis. Among the factors contributing to this choice there are the ability of OSeMOSYS to represent long-term dynamics and the flexibility of the code. The latter, in particular, allows to easily adapt the model to the case under study. Here, the existing energy system of the airport is modelled with the OSeMOSYS framework and the model is calibrated on three known years of operation. Having assessed the ability of the model to reproduce the behavior of the energy system, future studies will be devoted to the development of a decarbonisation roadmap for Turin Airport.

2. Materials and Methods

2.1. The OSeMOSYS framework

The sustainable transition of airports will require substantial interventions on many aspects of the energy system, both on the generation and consumption side. Examples of available measures are the investment in on-site renewable generation, energy efficiency, switching to renewable or low-carbon fuels, and many others [10, 31]. Negative emissions technologies could also play a role in the future [32].

Common methodologies applied to energy planning rely on single-project analysis and are characterized by a short-term perspective. However, neglecting the interactions between different components of the energy system could lead to economically sub-optimal solutions. For instance, the optimal size of a photovoltaic system could be significantly affected by the reduction of electricity consumption determined by energy efficiency measures. In addition, neglecting long-term dynamics could lead to more costly configuration of the system [33]. For instance, the increase in the energy price, and the advent of disruptive technologies and infrastructures can severely influence the development of a long-term energy strategy. Given the extent of the changes needed to decarbonise the airport operations, the methodologies commonly applied to energy planning could be unsuitable for modern challenges.

In this work, we propose an energy system optimisation approach to energy planning in airports. Energy System Optimisation Models (ESOM) are widely used for energy planning and

policy assessment at national and international level [34]. However, their application to local energy planning is gaining momentum [35].

Broadly speaking, ESOM simulate the behaviour of interconnected elements of the energy system, from the generation to the consumption side. These elements include resources, energy vectors, generation, conversion and storage technologies, appliances, and energy demands. Alternative technological options can competitively satisfy the demand for an energy vector, as shown in the Reference Energy System in (RES) in Figure 1.

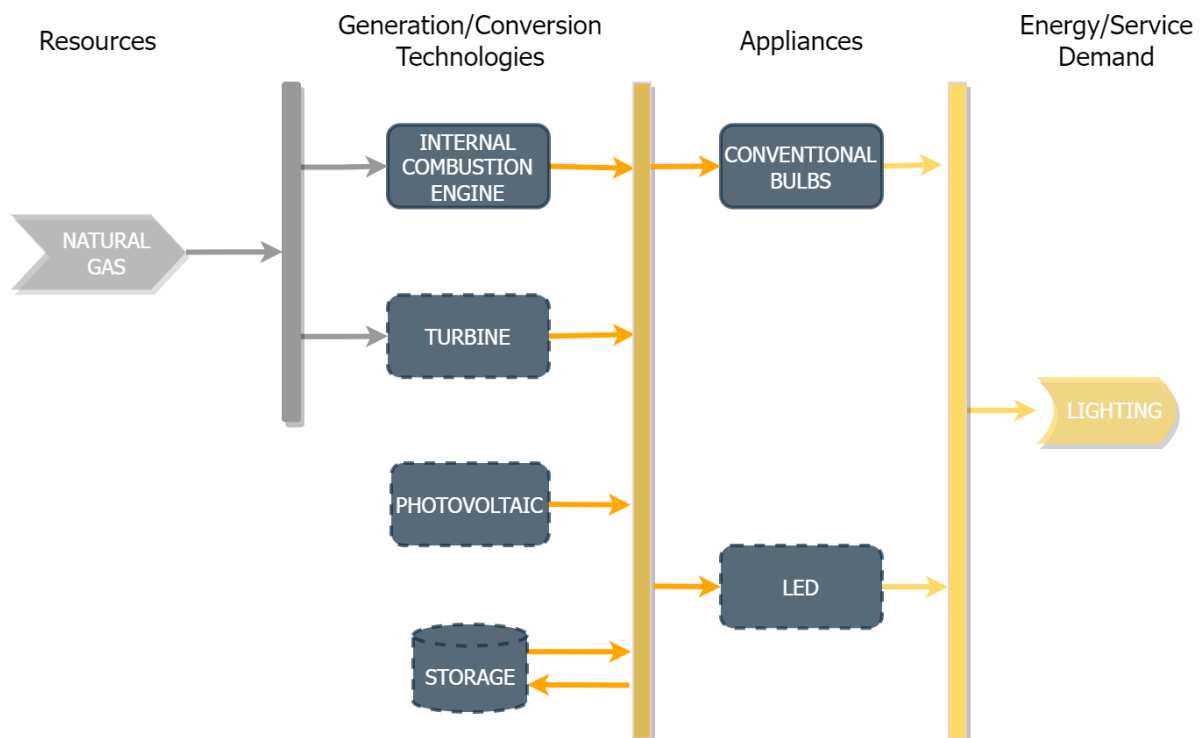

Figure 1: Typical representation of an energy system in ESOM. Arrows and vertical lines represent energy vectors. Energy vectors are progressively converted from the resources to the demand side by technologies, represented by boxes. Solid lines denote existing technologies, whereas dashed ones indicate potential investments.

From a methodological standpoint, ESOM find the optimal configuration of the system which satisfies the energy demand under a set of technical, economic and environmental constraints. Although various objective functions can be used [36], the optimal result is typically determined through the minimisation of total system discounted costs. These can include the investment and operative costs of the technologies, the purchase of energy from the market, taxes, incentives, etc. By mean of an optimisation algorithm, the model determines the size of technologies to be installed and the dispatch of energy which minimises system costs.

The landscape of ESOM is very wide [37, 38] and several modelling frameworks are currently available. Based on an extensive review conducted by the authors in a previous work [39], the OSeMOSYS framework [40, 41] was selected to perform the analysis. OSeMOSYS is an established

ESOM, which has been used for the planning of energy systems at the global [42], national [43, 44], city [45, 46] and village [47, 48] scale.

The model provides a large number of functions to characterise long-term dynamics, such as variable energy and carbon prices, energy demand and year-dependent environmental and renewable targets.

Actually, the code has been significantly improved through the years. Several modules exist which has expanded OSeMOSYS capabilities, enhancing the representation of storage [49, 50], the short-term operation of technologies [51, 52], as well as the handling of uncertainties [53].

The modular structure and ease-of-use of OSeMOSYS allows the quick adaptation of the code to the particular application. Notably, it makes it possible to introduce complexity only when deemed necessary. Therefore, the limitations of the OSeMOSYS framework can be selectively addressed, based on the specific case-study.

2.2. The case-study of Turin Airport

Turin Airport is situated in the Piedmont region, in northern Italy, few kilometers far from the homonymous city of Turin (Figure 2). Placed in a Cfb climatic zone, the location experiences an average yearly temperature of 14 °C. The site covers an area of 294 hectares which hosts a complex of more than 30 buildings.



Figure 2: Location and top view of Turin Airport's site.

The total volume of the constructions is above 750'000 m^3 , with a floor surface of about 170'000 m^2 . The main building is the passengers terminal, which alone accounts for a volume of 230'000 m^3 . The airport also features a second terminal for private flights. The rest of the buildings is various in scope and extension. Some of them are public, such as the covered parking and the remote check-in, while others are offices reserved to employees. Many of them are technical buildings providing support to airport services and aircraft operations, such as plant rooms, hangars and the Baggage Handling System (BHS) edifice.

In 2019, the last year before the pandemic crisis, the airport processed more than 43'000 flights, supporting the boarding and deboarding of nearly 4 million passengers. According to the classification laid out by the European Commission [54], these numbers place Turin Airport among the large regional airports, in the C category.

Table 1: Basic information on Turin Airport. Operative data on airport movements relate to the year 2019.

Denomination	TurinAirport	Volume	753'605m ³
IATA/ICAOcode	TRN/LIMF	Surface	173'760m ²
Location	AeroportoSandroPertini-CaselleTorinese	Passengers	3.95 millions
Latitude	45° 11'31"	Flights	43'292
Longitude	07° 39'07"	Baggage	806'463
Altitude	300 m a.s.l.	Freights	4'950tons
Climaticzone	Cfb		
Yearly average temperature	14.08 °C		

Turin Airport has undertaken a challenging pathway to improve its environmental sustainability and its efficiency in the use of resources. During the last decade, the airport has rolled-out a package of energy efficiency measures targeting the lighting and Heating, Ventilation and Air Conditioning (HVAC) systems. These measures have proved their effectiveness in reducing the demand for all the energy vectors of the airport, as shown in Figure 3. Following the peak demand of nearly 37 GWh in 2006, the consumption has been steadily declining, reaching 26 GWh in 2019. Meanwhile, the number of passengers have seen a continuous growth, meaning that the reduction of energy consumption has been achieved despite the increase of airport activities. In 2020 Turin Airport renewed its ISO 50001 certification, confirming its will to further improve the management of the energy system.

In 2022, Turin Airport endorsed the Toulouse declaration [6], reaffirming the commitment to reducing its GHG emissions. The airport has recently earned the level 3 of the Airport Carbon Accreditation (ACA), the carbon management certification constituted by ACI Europe [55]. This level of accreditation certifies that the airport has developed a plan to reduce its GHG emissions, also engaging other relevant stakeholders in the process. Turin Airport is also engaged in the Net Zero 2050 program, and it plans to reduce its emissions by 58% in 2030 (2009 reference) [9]. In line with this vision, the GHG emissions of the airport have been falling in the recent years (Figure 4). The major contributions to this reduction were brought by the implementation of efficiency measures and by the concurrent decarbonisation of the Italian electricity grid [56]. Nevertheless, stronger actions would be needed to achieve the ambitious targets set for 2030 and 2050.

2.3. The airport energy system

The airport carries out a multitude of activities in support of the boarding/deboarding of passengers and landing/take-off of flights. The passenger is the main customer on the landside, where several facilities (terminal buildings, parking, etc.) offer a variety of services. Among others, there are the lighting and air conditioning of the buildings, alongside the movement and processing of passengers and baggage. On the airside, the main customer is the aircraft, which is supported in the on-ground operations by a heterogeneous group of Ground Support Equipment (GSE). On this side, typical services include the handling of the aircraft, passengers and cargo, the provision of power to the aircraft through Ground Power Units (GPU) and the maintenance and lighting of the runways.

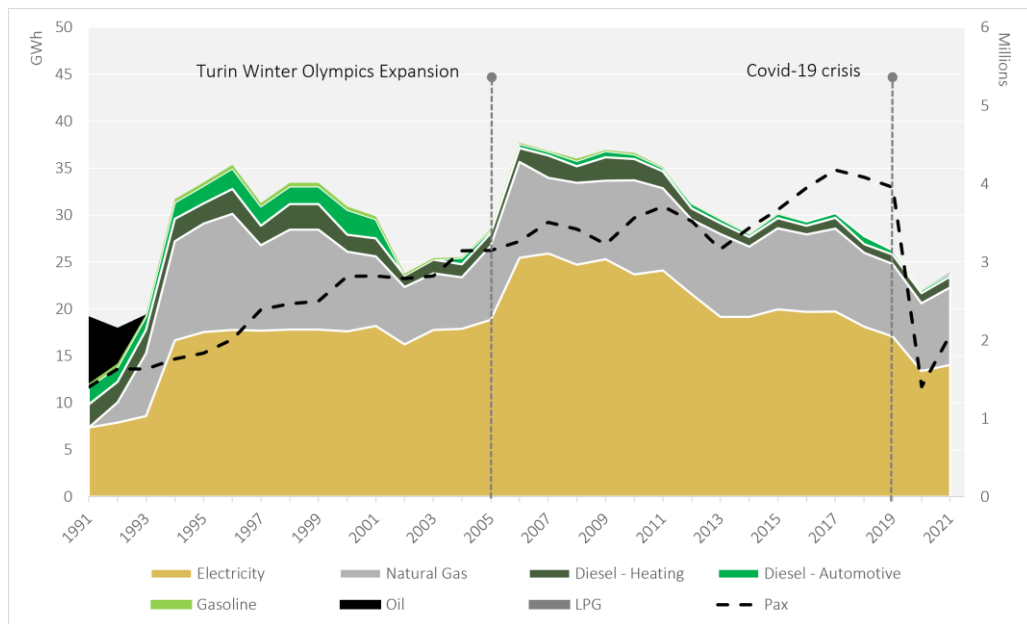

Figure 3: Historical energy consumption (left axis) and number of passengers (right axis) of Turin Airport's. Energy consumption is reported for each energy vector.

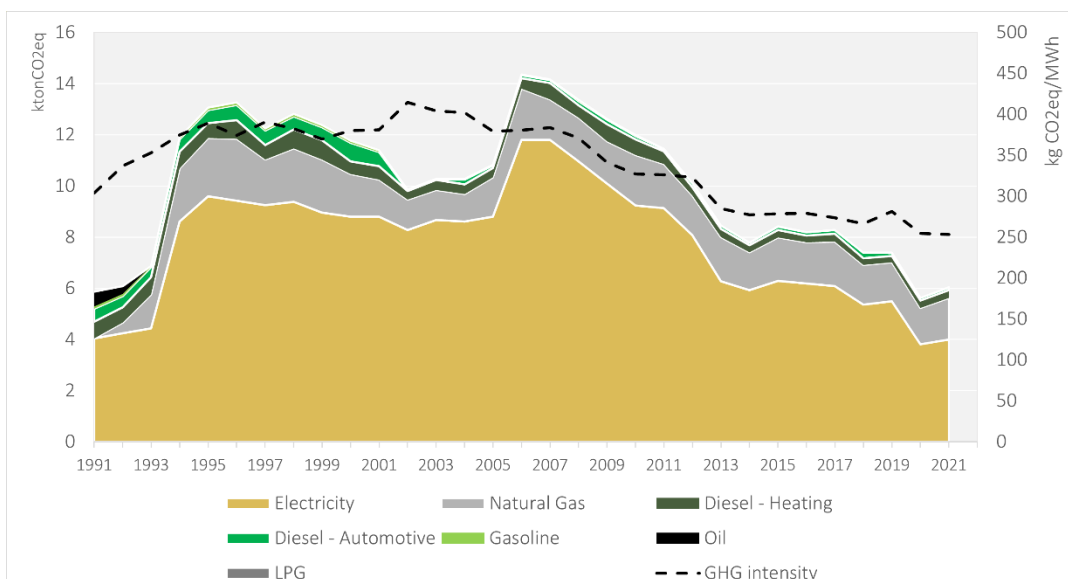

Figure 4: Historical GHG emissions (left axis) and GHG emissions intensity (right axis). Historical emissions are reported for each energy vector.

The operation of the airport consumes a large amount of natural resources. Figure 5a shows that the consumption of primary energy stood at 4.0 ktoe in 2019. The airport relies on three main energy vectors: grid electricity, natural gas and fossil diesel. Of these energy vectors, grid electricity alone makes up 80% of primary energy consumption. LPG and fossil petrol instead constitute a negligible share. As there is no on-site power production, all the resources are

imported from outside the airport boundaries. The Figure 5b shows a detailed breakdown of the final use of the main energy vectors.

In 2019, the airport consumed nearly 17 GWh of electricity. A 30% of this satisfied the demand for internal and external lighting, while an equal share served for the cooling and ventilation loads. Interestingly, about 10% of the electricity demand covered an array of small and disparate services (Misc), such as data elaboration centres, computers, monitors, etc. Another relevant share was consumed by the companies conducting their activities within the airport borders (Tenants), such as bars, restaurants and shops. About 10% of the electricity consumption (Other) was not monitored.

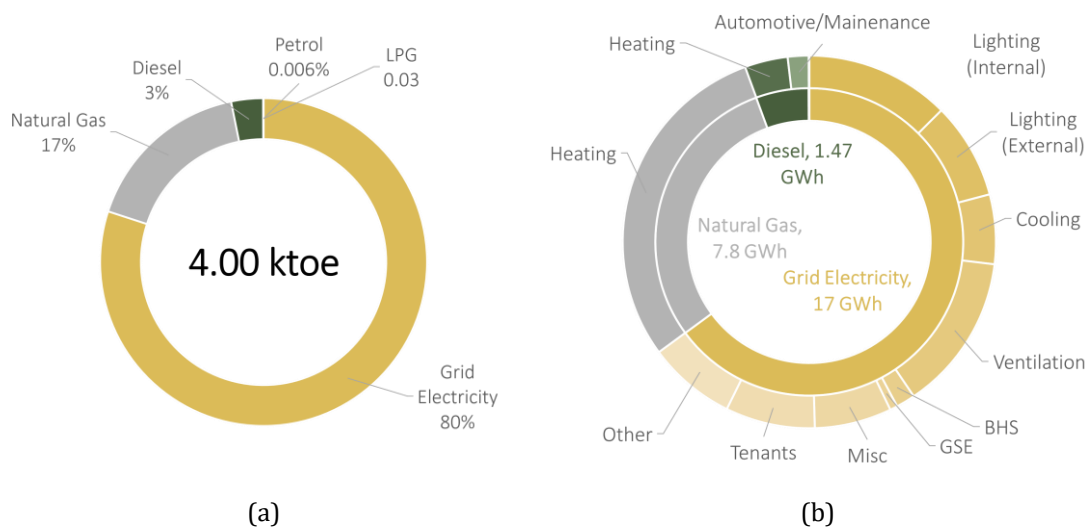

Figure 5: Primary energy consumption (a) and final use of energy vectors (b) of the airport in 2019. Primary energy consumption was computed using the conversion factors provided by ARERA [57].

The majority of the purchased natural gas was used for heating and for the generation of hot water. Most of the diesel was burned for heating purposes, while a minor share served to fuel the airport cars, for operations both on land and airside, and runway maintenance vehicles, such as de-icers.

The Figure 6 illustrates the distribution of airport consumption through the year, for each energy vector. Driven by colder temperatures, the consumption of natural gas and diesel is higher in winter, especially in January. The peak electricity consumption is reached in the summer months, when the cooling system is switched on, implying a high dependency of energy demand on weather conditions. The lowest energy demand is registered in May, when both the heating and cooling systems are off.

As can be expected by the extension of the airport complex, the heating, cooling and air conditioning system is quite articulated. Figure 7 gives a high-level representation of the HVAC system. The main heating network distributes hot water to a group of buildings, including the terminal. The hot water is generated in a technical building by three large boilers, fed by natural gas. The terminal serving private flights has its own heating system, still fed by natural gas. Conversely, several isolated buildings, mainly located on the airside, are served by boilers fed by diesel.

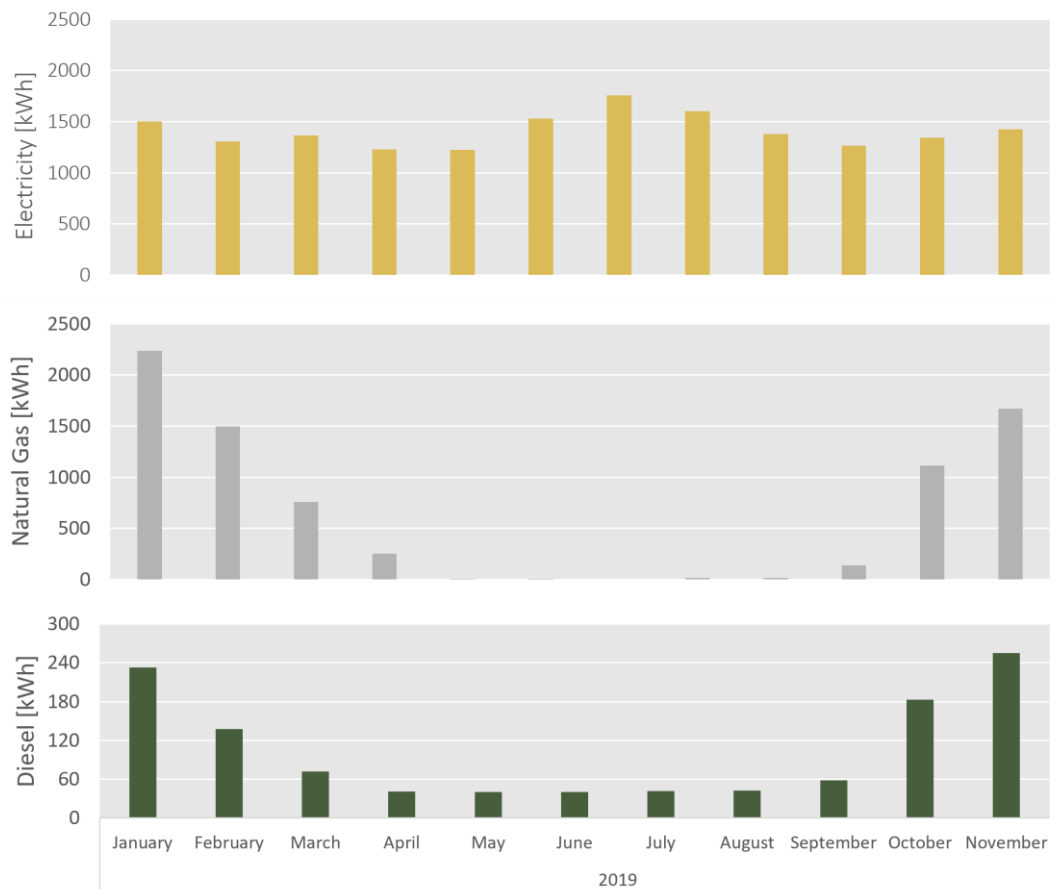

Figure 6: Distribution of airport consumption through the year (2019 data).

The cooling and ventilation loads are fulfilled by Air Handling Units (AHU) and cooling units serving a single or a small group of buildings. The cooling units serving the terminal are of the water-cooled type, whereas those serving smaller buildings are air-cooled. The cooling load is provided by screw compression chillers powered by electricity. Table 2 reports the installed power of the HVAC equipment.

Table 2: Installed capacity of the HVAC equipment. The capacity of the boiler is expressed in kW thermal. The capacity of compression chillers is expressed in kW cooling.

Equipment	Installed Capacity (kW)
Natural gas boiler (district network)	8'835
Natural gas boiler (other)	1'420
Diesel boiler	2'879
Compression chillers	7'944

3. Results and Discussion

3.1. Turin airport energy system as modelled in OSeMOSYS

The airport is a complex and highly articulated energy system. Modelling its evolution over several decades would entail a major computational burden. Therefore, a certain level of aggregation of the airport energy demand and technologies has been necessary. For the scope of this work, the RES of the airport was represented as in Figure 8.

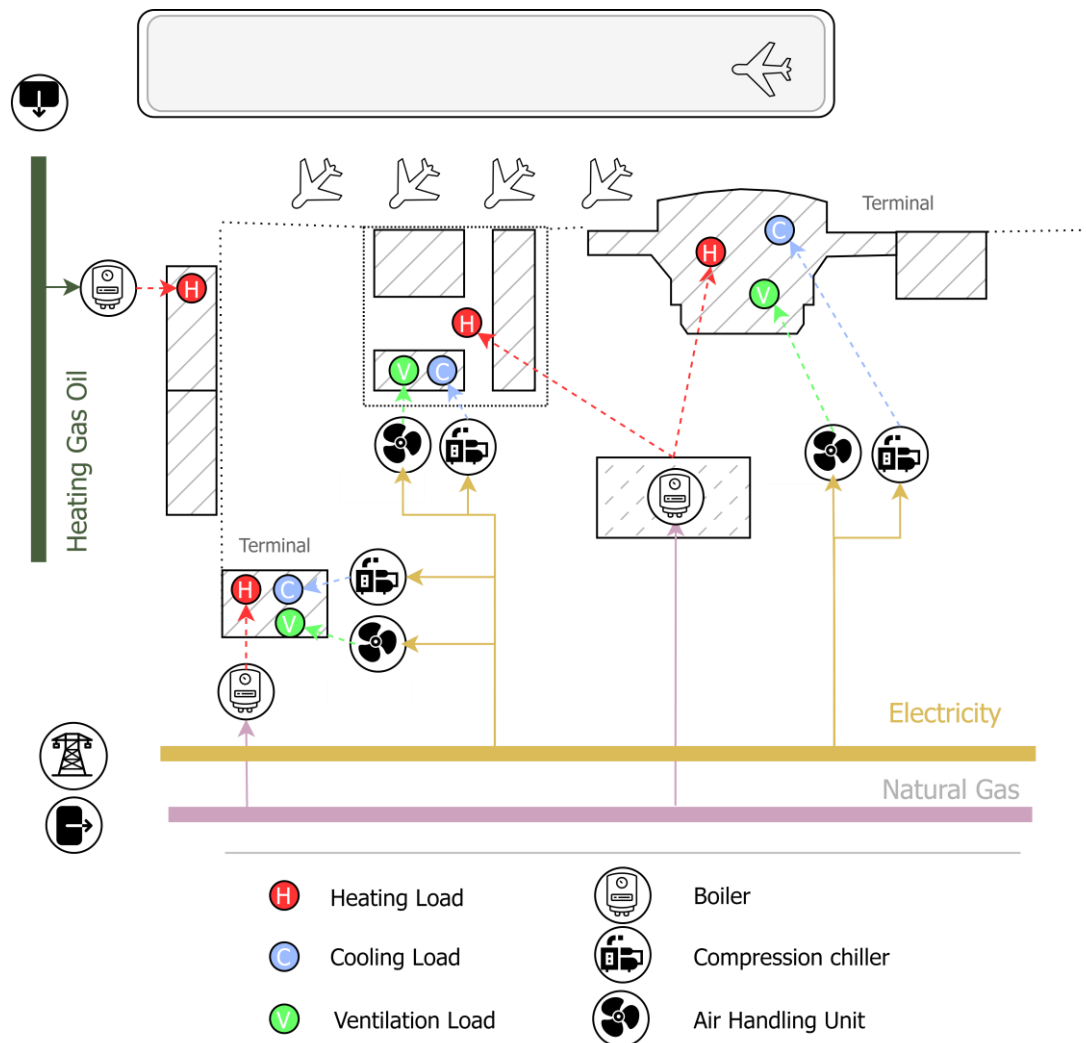

Figure 7: High-level representation of the HVAC system of the airport.

The heating system was divided on the basis of the three main types identified in Subsection 2.3: a separate heating demand was defined for the buildings served by the main thermal network (MAIN), for the second terminal (SECONDARY) and for the ancillary buildings, mainly located on the airside (ANCILLARY). This articulation has been necessary as the thermal loads are satisfied by different technologies and infrastructures, i.e., the thermal demand of the second terminal cannot be satisfied by the thermal network.

The electric system of the airport does not present particular complexity or specific bottlenecks, and therefore the copperplate approach can be justified. However, the electricity consumption related to the different services was segregated from the various energy demand. This enables the study of the impact of energy efficiency measures on the energy demand of particular services and appliances (lighting, cooling, PC, electric motors, etc.). Given the scope of this paper, only the lighting and cooling services were segregated but results can be generalised to other services, such as AHU and electric motors.

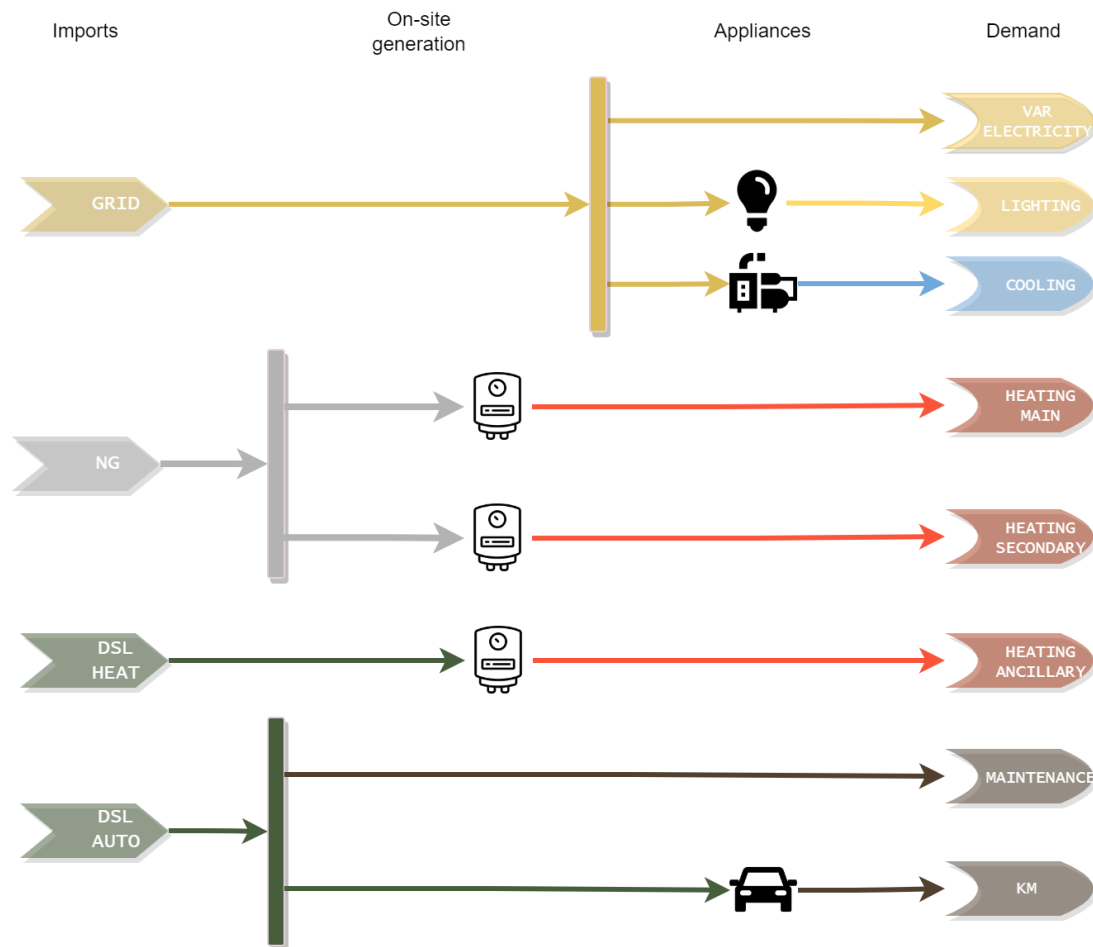

Figure 8: RES of the existing airport energy system.

Finally, the demand of fossil fuel for automotive purposes was separated in light duty vehicles, like cars, and heavy-duty vehicles, like those apt to the maintenance of the runway. The former are likely to be substituted by electric vehicles in the near future. Therefore, it makes sense to represent alternative conversion technologies able to satisfy the demand. Conversely, the electrification of heavy-duty vehicles is less likely. Therefore, the only noticeable measure that could be undertaken would be switching to an alternative fuel, like biodiesel. This intervention does not require the representation of the technology in the model.

The data used for the calibration of the model are reported in the following tables. Table 3 reports the demand for the different energy vectors and services used in the model. Table 4 reports the conversion coefficients of the aggregated technologies, as modelled in this work. The

aggregated conversion coefficients were computed as the average of the efficiencies of single technologies, weighted over their annual contribution to the satisfaction of the demand. Finally, Table 6 and 5 reports respectively the emission factors and costs associated with each energy vector entering the system.

The historical data on energy consumption and the technical data on heating, cooling and other equipment were extracted from the documents prepared by the airport for the ISO 50001 certification. The prices of the different energy vectors were taken from airport's bills. For the emissions factors of the various energy vectors and the grid electricity, the values were derived from the national emissions inventory hosted on the ISPRA website¹.

3.2. Model calibration

This section reports the results of the calibration of the model over the operative period 2019-2021.

Table 3: Demand for the different energy vectors and services represented in the model.

Demand	2019	2020	2021	Units
Various electricity	10.8	7.30	7.76	GWh
Lighting	0.51	0.50	0.51	Tlmh
Cooling	3.77	2.85	3.91	GWh (cooling)
Main Heating	6.71	6.05	7.23	GWh (thermal)
Secondary Heating	0.66	0.68	0.50	GWh (thermal)
Ancillary Heating	0.89	0.98	1.03	GWh (thermal)
Maintenance Vehicles	0.30	0.24	0.23	GWh (fuel)
Light-duty Vehicles	4.36	3.42	3.37	100'000 km

Table 4: Conversion coefficient of the different technologies represented in the model.

Technology	Conversion coefficient	Units
Light bulbs	87.6	lm/W
Compression chillers	5.02	kW (cooling)/kW (electric)
Boiler (Main)	0.923	kW (thermal)/kW (fuel)
Boiler (Secondary)	0.930	kW (thermal)/kW (fuel)
Boiler (Ancillary)	0.916	kW (thermal)/kW (fuel)
Light-duty vehicles	40.4	kWh (fuel)/100 km

¹ <http://emissioni.sina.isprambiente.it/inventario-nazionale/>

Table 5: Costs of the different energy vectors imported in the model (in c€/kWh).

Energy vector	2019	2020	2021
Grid electricity	13.6	12.7	20.9
Natural Gas	3.82	3.23	3.69
Diesel (Automotive)	13.6	12.1	13.7
Diesel (Heating)	7.9	6.9	7.8

Table 6: Emission factors of the different energy vectors imported in the model (in gCO_{2,eq}/kWh).

Energy vector	2019	2020	2021
Grid electricity	321	285	285
Natural Gas		194	
Diesel (Automotive)		269	
Diesel (Heating)		266	

The Figure 9a and 9b show respectively the consumption for each energy vector and the associated costs for the modelled period. The error of the model in reproducing the real quantities is reported as percent variation from the real value. As can be seen by the comparison of the simulated and real data, the dispatch and economic patterns were correctly represented by the model, the percent variation being always well below 2.5%. The largest deviation was registered for the electricity vector in 2021. This error can be traced back to the approximation of the installed power of LED bulbs, which was not available for the year 2021. Figure 9c shows that also the emissions associated to each energy vector were accurately reproduced by the model.

It is interesting to notice that, despite the lower consumption of electricity due the trail of the Covid-19 pandemic, the costs registered in 2021 are higher than in 2019, mainly due to the increased electricity price (Table 5).

The consumption of electricity makes up the largest share of energy used by the airport. Moreover, it has to be noticed that, for what concerns both emissions and costs, the contribution of electricity is even more pronounced due to the higher price and emission factor.

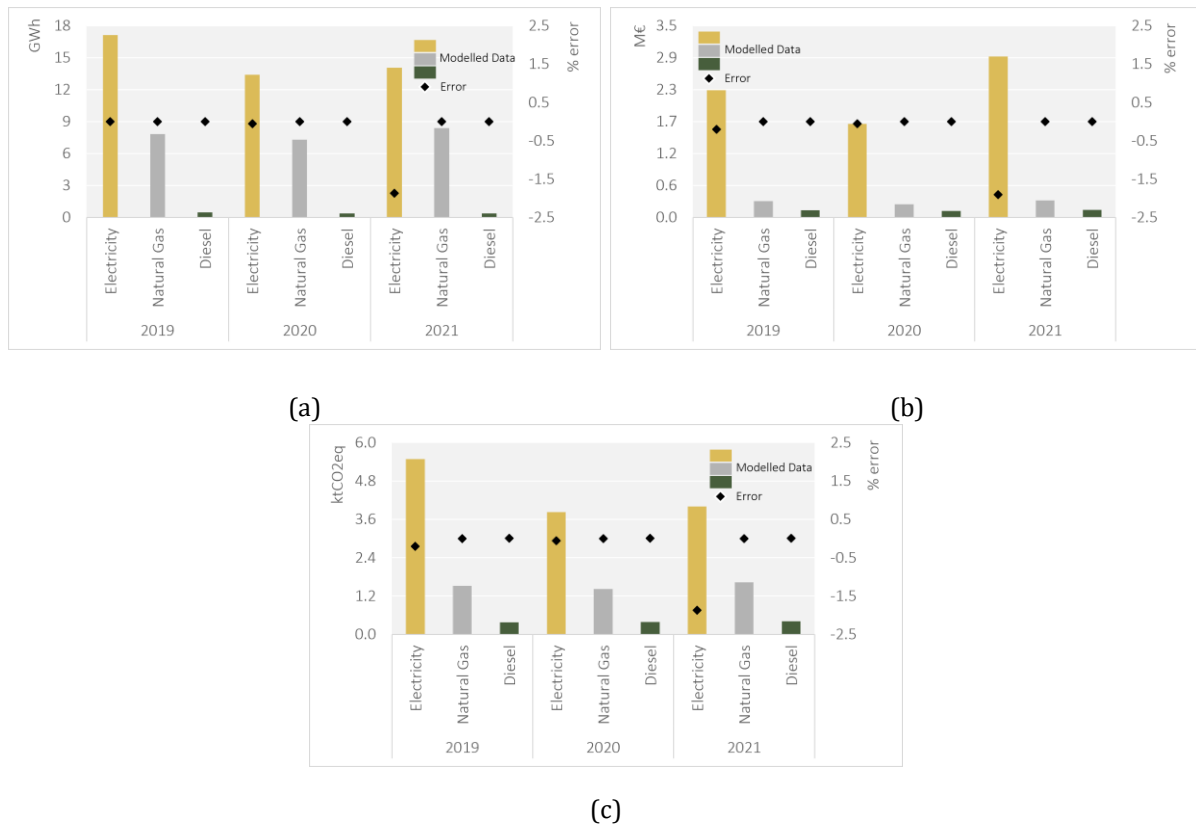

Figure 9: Comparison of modelled and real data. The percentage error (right-axis) is reported as percent deviation from real value. (a) Energy consumption, (b) costs, (c) emissions.

3.3. Perspective and future work

In this paper, the existing energy system of Turin Airport has been first characterised and then modeled by means of the OSeMOSYS framework. The ability of the model to reproduce emissions and costs patterns of the system was assessed through the comparison with some reference years of operation of the airport.

Having completed the calibration of the model, on the existing system, future studies will focus on the introduction of innovative technologies, and solutions for the future airport infrastructure.

Figure 10 provides an overview of the measures which will be implemented in future developments of the model. In line with the plan laid out by Turin Airport, the integration of a smart-grid concept will be investigated. The smart-grid will feature advanced energy components, such as batteries and hydrogen storage, as well as a fuel-cell based CCHP system. Additionally, the feasibility of heat pump systems and the implementation of a package of efficiency measures will be studied with the specific aim to develop a long-term roadmap to support the energy transition of Turin Airport.

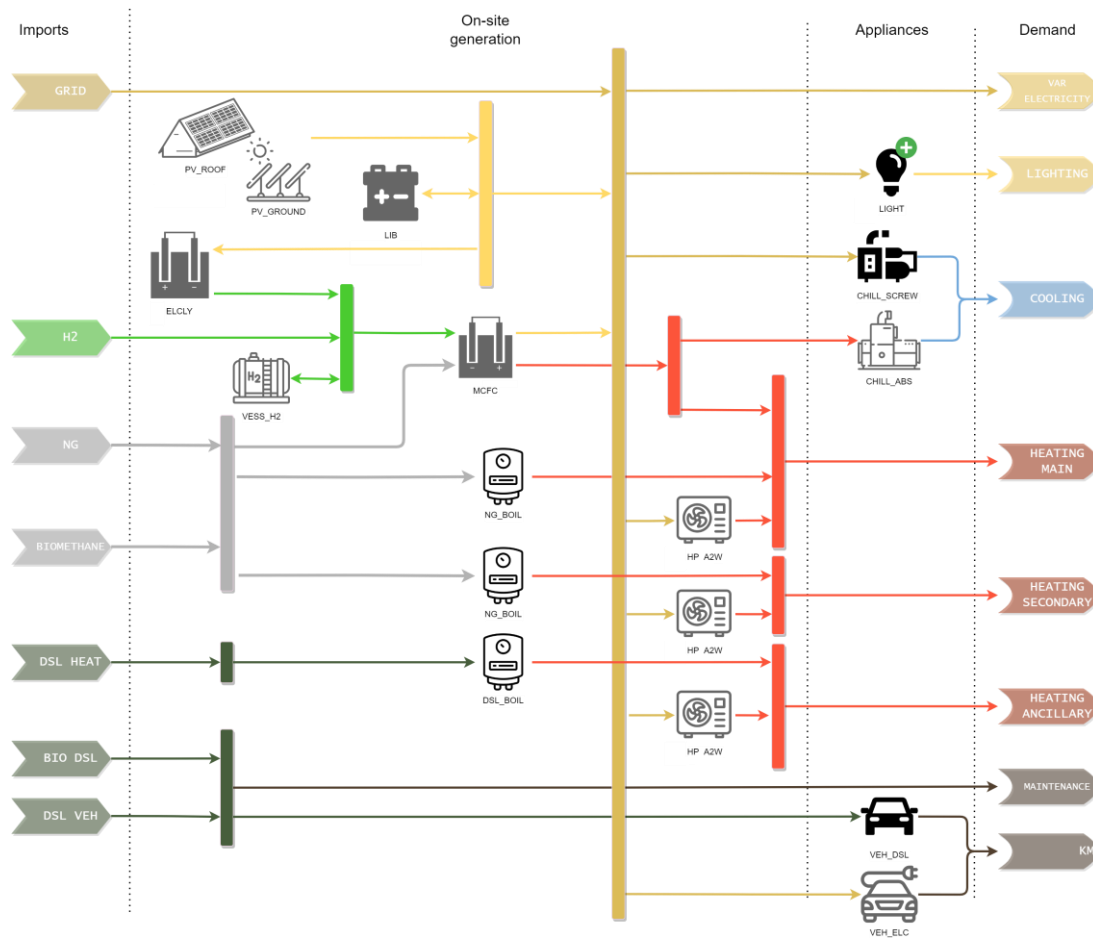

Figure 10: RES of the potential expansion of the airport energy system.

Preliminary estimates show that the measures which will be included in the model have a great potential to reduce the airport's carbon footprint. For the emission savings reported in Figure 11, we assumed a system composed by a 3 MW photovoltaic plant, a 250 kW_e Solid Oxide Fuel Cell, the complete substitution of conventional light bulbs with LED and the full electrification of the heating segment. The fuel cell was assumed to be fed with a 70-30 %vol blend of hydrogen and biomethane.

Despite the necessarily preliminary nature of these estimates, it clearly results that, being these measures adopted, the airport could cope with the rise of emissions deriving from Increased airport activities, achieving nearly a reduction of 2.0 kt CO_{2eq} with respect to present levels. The model implemented in the OSeMOSYS framework will enable to investigate how and when these measures should be implemented in a such a way to achieve economic optimality.

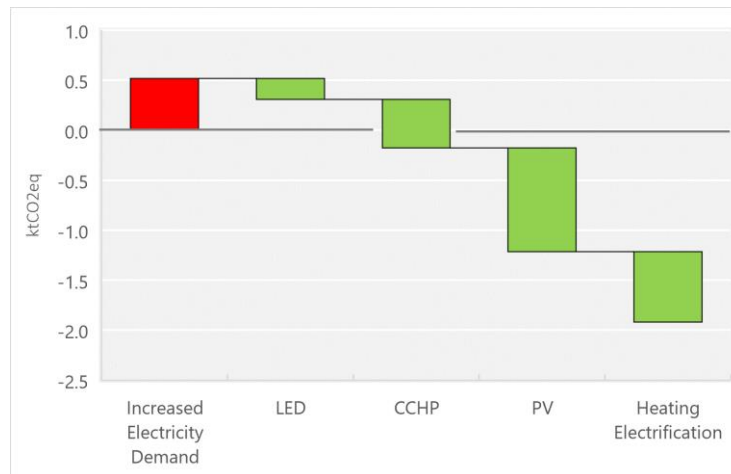

Figure 11: Potential emission savings with respect to present levels. Emissions savings were estimated assuming a 3 MW PV plant, a 250 kWe Solid Oxide Fuel Cell fueled by a 70-30 %vol blend of hydrogen and biomethane the complete substitution of conventional light bulbs with LED and the full electrification of the heating segment.

4. Conclusions

The sustainable transition of airports is a key part of the decarbonisation of the civil aviation sector. The transition will require substantial investments in innovative technologies which will shape the future airport energy system. The implementation of these disruptive changes should be carefully evaluated, also by means of a specifically designed roadmap, based on a long-term approach. In this view, energy system models could offer a valuable support to the planning process.

In this work, an energy system optimisation approach was proposed for the case-study of Turin Airport. The existing energy system of the airport was analysed and implemented in the OSeMOSYS framework. The model has been calibrated on three known years of operation of the airport. The results of the simulations showed that the realised model was able to reproduce the consumption, emissions and costs patterns of the airport.

The set up model, based on the existing energy system, allows for defining future studies focusing on the development of a long-term transition roadmap for the airport. The modelled system will be integrated with the smart-grid concept foreseen by Turin Airport, featuring solar power, hydrogen and CCHP fuel cell unit. Additionally, the model will be enriched by a range of energy efficiency measures, relating to the lighting and HVAC services. The final system will be studied under various scenarios, in order to identify the optimal development pathways.

Acknowledgments This work has received funding support from the European Union's Horizon 2020 research and innovation programme under grant agreement N. 01036996 (TULIPS)

Abbreviations

ACI	Airport Council International
AHU	Air Handling Unit
BHS	Baggage Handling System
CHP	Combined Heat and Power
CCHP	Combined Cooling Heat and Power
GPU	Ground Power Unit
GSE	Ground Support Equipment
ICAO	International Civil Aviation Organization
RES	Reference Energy System

References

- [1] EUROCONTROL. *Traffic Forecast*. May 2023. url: <https://www.eurocontrol.int/our-data>.
- [2] Multi-Disciplinary Working Group on Long-Term Traffic Forecasts (MDWG-LTF) under the Aviation Data and Analysis Panel (ADAP). *Developing a Long Term Air Traffic Demand Forecast Model Methodology*. International Civil Aviation Organisation, 2022.
- [3] International Energy Agency. *Aviation - Tracking Report*. May 2023. url: <https://www.iea.org/reports/aviation>.
- [4] Fiona Greer, Jasenka Rakas, and Arpad Horvath. "Airports and environmental sustainability: A comprehensive review". In: *Environmental Research Letters* 15 (10 Oct. 2020). doi: 10.1088/1748-9326/abb42a.
- [5] Farooq Sher et al. "Unprecedented Impacts of Aviation Emissions on Global Environmental and Climate Change Scenario". In: *Current Pollution Reports* 7 (4 2021), pp. 549–564. doi: 10.1007/s40726-021-00206-3.
- [6] *Toulouse declaration on future sustainability and decarbonisation of aviation*. 2022.
- [7] Airport Council International Europe. *Net Zero 2050*. May 2023. url: <https://www.acieurope.org/netzero>.
- [8] Airport Council International. *Long-Term Carbon Goal Study for Airports*. 2021.
- [9] Sagat S.p.A. *Corporate Social Responsibility Report*. Sagat S.p.A, 2021.
- [10] Sergio Ortega Alba and Mario Manana. "Energy research in airports: A review". In: *Energies* 9 (5 2016), pp. 1–19. doi: 10.3390/en9050349.
- [11] Sergio Ortega Alba and Mario Manana. "Energy research in airports: A review". In: *Energies* 9 (5 2016). doi: 10.3390/en9050349.
- [12] Bob Geldermans, Alexander Wandl, and Andy Van Den Dobbelen. *Mapping and managing essential resource flows in airport regions-the case of Amsterdam Airport Schiphol*. 2014.
- [13] Glenn Baxter, Roberto Sabatini, and Graham Wild. "Sustainable Airport Energy Management: a Case Study of Copenhagen Airport". In: (). doi: 10.13140/RG.2.1.1163.2806.
- [14] Glenn Baxter, Panarat Srisaeng, and Graham Wild. "An assessment of airport sustainability, part 2-Energy management at Copenhagen Airport". In: *Resources* 7 (2 June 2018). doi: 10.3390/resources7020032.
- [15] *Improving Energy Efficiency in Egyptian Airports: A Case Study of Sharm-Elshiekh Airport*. IEEE, Dec. 2019, pp. 289–294. doi: 10.1109/MEPCON47431.2019.9008220.

- [16] B Griffith et al. *Energy Design Analysis and Evaluation of a Proposed Air Rescue and Fire Fighting Administration Building for Teterboro Airport*. National Renewable Energy Laboratory, 2003.
- [17] D. Abdulhameed Mambo, Mahroo Efthekhari, and Thomas Steffen. "Occupancy-Driven Supervisory Control Strategies to Minimise Energy Consumption of Airport Terminal Building". In: *Sustainability in Energy and Buildings* (2013), pp. 479–489. doi: 10.1007/978-3-642-36645-1_45.
- [18] Adem C,elik, Mehmet Yilmaz, and Omer Faruk Yildiz. "Energy analysis of cold climate" region airports: a case study for airport terminal in Erzurum, Turkey". In: *International Journal of Sustainable Aviation* 7 (1 2021), p. 1. doi: 10.1504/IJSA.2021.10037374.
- [19] *Sustainable airports and NZEB: The real case of Rome International Airport*. 2015, pp. 1492–1497. doi: 10.1109/EEEIC.2015.7165392.
- [20] F Zeren. "ENERGY PERFORMANCE ANALYSIS OF ADNAN MENDERES INTERNATIONAL AIRPORT (ADM)". Izmir Institute of Technology, 2010.
- [21] Glenn Baxter. "ENVIRONMENTALLY SUSTAINABLE AIRPORT ENERGY MANAGEMENT USING SOLAR POWER TECHNOLOGY: THE CASE OF ADELAIDE AIRPORT, AUSTRALIA". In: *INTERNATIONAL JOURNAL FOR TRAFFIC AND TRANSPORT ENGINEERING* 9 (1 Mar. 2019), pp. 81–100. doi: 10.7708/ijtte.2019.9(1).07.
- [22] Livio de Santoli et al. "Building integrated bioenergy production (BIBP): Economic sustainability analysis of Bari airport CHP (combined heat and power) upgrade fueled with bioenergy from short chain". In: *Renewable Energy* 81 (Sept. 2015), pp. 499–508. doi: 10.1016/j.renene.2015.03.057.
- [23] E. Cardona et al. "Energy saving in airports by trigeneration. Part II: Short and long term planning for the Malpensa 2000 CHCP plant". In: *Applied Thermal Engineering* 26 (14-15 Oct. 2006), pp. 1437–1447. doi: 10.1016/j.applthermaleng.2006.01.020.
- [24] E. Cardona, A. Piacentino, and F. Cardona. "Energy saving in airports by trigeneration. Part I: Assessing economic and technical potential". In: *Applied Thermal Engineering* 26 (14-15 Oct. 2006), pp. 1427–1436. doi: 10.1016/j.applthermaleng.2006.01.019.
- [25] *Trigeneration in tertiary sector: a case study*. June 2013.
- [26] Wantana Somcharoenwattana et al. "Study of operational parameters improvement of natural-gas cogeneration plant in public buildings in Thailand". In: *Energy and Buildings* 43 (4 Apr. 2011), pp. 925–934. doi: 10.1016/j.enbuild.2010.12.016.
- [27] Birol Kilkis and Siir Kilkis. "New exergy metrics for energy, environment, and economy nexus and optimum design model for nearly-zero exergy airport (nZEXAP) systems". In: *Energy* 140 (Dec. 2017), pp. 1329–1349. doi: 10.1016/j.energy.2017.04.129.
- [28] Tullio de Rubeis et al. "Multi-year consumption analysis and innovative energy perspectives: The case study of Leonardo da Vinci International Airport of Rome". In: *Energy Conversion and Management* 128 (Nov. 2016), pp. 261–272. doi: 10.1016/j.enconman.2016.09.076.
- [29] Birol Kilkis. "Energy consumption and CO2 emission responsibilities of terminal buildings: A case study for the future Istanbul International Airport". In: *Energy and Buildings* 76 (2014), pp. 109–118. doi: 10.1016/j.enbuild.2014.02.049.

- [30] *TULIPS Project - Green Airports*. May 2023. url: <https://tulips-greenairports.eu/>.
- [31] Andrew J Rowlings and Arron R Walker. *Sustainable Energy Options for the Future Airport Metropolis*. 2008, pp. 21–26.
- [32] Airport Council International. *Developing an Airport Net Zero Carbon Roadmap Summary of existing roadmaps*. 2022.
- [33] Zachary K Pecenek, Michael Stadler, and Kelsey Fahy. “Efficient multi-year economic energy planning in microgrids”. In: *Applied Energy* (2019). doi: 10.1016/J.APENERGY. 2019.113771.
- [34] Dongran Song et al. “A critical survey of integrated energy system: Summaries, methodologies and analysis”. In: *Energy Conversion and Management* 266 (Aug. 2022), p. 115863. doi: 10.1016/j.enconman.2022.115863.
- [35] Etienne Cuisinier et al. “Techno-economic planning of local energy systems through optimization models: a survey of current methods”. In: *International Journal of Energy Research* 45 (4 Mar. 2021), pp. 4888–4931. doi: 10.1002/ER.6208.
- [36] Poul Alberg Østergaard. “Reviewing optimisation criteria for energy systems analyses of renewable energy integration”. In: *Energy* (2009). doi: 10.1016/j.energy.2009.05.004.
- [37] Hans Kristian Ringkjøb, Peter M. Haugan, and Ida Marie Solbrekke. “A review of modelling tools for energy and electricity systems with large shares of variable renewables”. In: *Renewable and Sustainable Energy Reviews* 96 (April 2017 2018), pp. 440–459. doi: 10.1016/j.rser.2018.08.002.
- [38] Markus Groissböck. “Are open source energy system optimization tools mature enough for serious use?” In: *Renewable and Sustainable Energy Reviews* 102 (April 2018 2019), pp. 234–248. doi: 10.1016/j.rser.2018.11.020.
- [39] Lorenzo Laveneziana, Matteo Prussi, and David Chiaramonti. “Critical review of energy planning models for the sustainable development at company level”. In: *in-print* (2023).
- [40] Mark Howells et al. “OSeMOSYS: The Open Source Energy Modeling System. An introduction to its ethos, structure and development.” In: *Energy Policy* 39 (10 Oct. 2011), pp. 5850–5870. doi: 10.1016/j.enpol.2011.06.033.
- [41] M. Welsch et al. “Modelling elements of Smart Grids - Enhancing the OSeMOSYS (Open Source Energy Modelling System) code”. In: *Energy* 46 (1 2012), pp. 337–350. doi: 10.1016/j.energy.2012.08.017.
- [42] Climate Compatible Growth. *OSeMOSYS Global*. May 2023. url: <http://osemosys.global/>.
- [43] Republic of Cyprus. *Cyprus’ Integrated national energy and climate plan for the period 2021-2030*. 2020, p. 45.
- [44] Manuel Welsch et al. “Incorporating flexibility requirements into long-term energy system models - A case study on high levels of renewable electricity penetration in Ireland”. In: *Applied Energy* 135 (Dec. 2014), pp. 600–615. doi: 10.1016/j.apenergy.2014.08.072.
- [45] Benjamin D. Leibowicz et al. “Optimal decarbonization pathways for urban residential building energy services”. In: *Applied Energy* 230 (Nov. 2018), pp. 1311–1325. doi: 10.1016/j.apenergy.2018.09.046.
- [46] Ion Smeureanu et al. “Modeling Residential Space Heating Energy for Romania”. In: *International Journal of Environmental and Ecological Engineering* 9 (8 2015).

- [47] Annalisa Tognollo. “Energy demand analysis within long-term rural energy planning: a critical review and simulation for more appropriate modelling approach”. Politecnico di Milano, 2015.
- [48] Francesco Fuso Nerini et al. “Estimating the cost of energy access: The case of the village of Suro Craic in Timor Leste”. In: *Energy* 79 (C 2015), pp. 385–397. doi: 10.1016/j.energy.2014.11.025.
- [49] Andrea Palombelli et al. “Development of functionalities for improved storage modelling in OSeMOSYS”. In: *Energy* 195 (Mar. 2020). doi: 10.1016/j.energy.2020.117025.
- [50] T. Niet. “Storage end effects: An evaluation of common storage modelling assumptions”. In: *Journal of Energy Storage* 27 (Feb. 2020). doi: 10.1016/j.est.2019.101050.
- [51] Manuel Welsch et al. “Supporting security and adequacy in future energy systems: The need to enhance long-term energy system models to better treat issues related to variability”. In: *International Journal of Energy Research* 39 (3 Mar. 2015), pp. 377–396. doi: 10.1002/er.3250.
- [52] Francesco Gardumi et al. “Representation of balancing options for variable renewables in long-term energy system models: An application to OSeMOSYS”. In: *Energies* 12 (12 2019). doi: 10.3390/en12122366.
- [53] Dennis Dreier and Mark Howells. “OSeMOSYS-PuLP: A Stochastic Modeling Framework for Long-Term Energy Systems Modeling”. In: *energies* (2019). doi: <https://doi.org/10.3390/en12071382>.
- [54] European Commission. *2005/C 312/01, Communication from the Commission — Community guidelines on financing of airports and start-up aid to airlines departing from regional airports*. 2005.
- [55] Airport Council International. *Airport Carbon Accreditation*. May 2023. url: <https://www.airportcarbonaccreditation.org/>.
- [56] Antonio Caputo. *Fattore di emissione atmosferica di gas a effetto serra nel settore elettrico nazionale e nei principali Paesi Europei*. Istituto Superiore per la Protezione e la Ricerca Ambientale, 2020.
- [57] ARERA. *Delibera EEN 3/08, Aggiornamento del fattore di conversione dei kWh in tonnellate equivalenti di petrolio connesso al meccanismo dei titoli di efficienza energetica*. 2008.