

LIN-MM: Multiplexed Message Authentication Code for Local Interconnect Network message authentication in road vehicles

Original

LIN-MM: Multiplexed Message Authentication Code for Local Interconnect Network message authentication in road vehicles / Oberti, Franco; Sanchez, Ernesto; Savino, Alessandro; Parisi, Filippo; Brero, Mirco; DI CARLO, Stefano. - ELETTRONICO. - (2022), pp. 1-7. (IEEE 28th International Symposium on On-Line Testing and Robust System Design IOLTS 2022 Torino 12-14 September 2022) [10.1109/IOLTS56730.2022.9897819].

Availability:

This version is available at: 11583/2982772 since: 2023-10-05T10:04:28Z

Publisher:

Institute of Electrical and Electronics Engineers

Published

DOI:10.1109/IOLTS56730.2022.9897819

Terms of use:

This article is made available under terms and conditions as specified in the corresponding bibliographic description in the repository

Publisher copyright

IEEE postprint/Author's Accepted Manuscript

©2022 IEEE. Personal use of this material is permitted. Permission from IEEE must be obtained for all other uses, in any current or future media, including reprinting/republishing this material for advertising or promotional purposes, creating new collecting works, for resale or lists, or reuse of any copyrighted component of this work in other works.

(Article begins on next page)

LIN-MM: Multiplexed Message Authentication Code for Local Interconnect Network message authentication in road vehicles

Franco Oberti^{1,2}, Ernesto Sanchez¹, Alessandro Savino¹, Filippo Parisi², Mirco Brero², and Stefano Di Carlo¹
¹Control and Computer Engineering Department, Politecnico di Torino, Torino, Italy
²PUNCH Softronix S.r.l., Torino, Italy

Abstract—The automotive market is profitable for cyberattacks with the constant shift toward interconnected vehicles. Electronic Control Units (ECUs) installed on cars often operate in a critical and hostile environment. Hence, both carmakers and governments have supported initiatives to mitigate risks and threats belonging to the automotive domain. The Local Interconnect Network (LIN) is one of the most used communication protocols in the automotive field. Today’s LIN buses have just a few light security mechanisms to assure integrity through Message Authentication Codes (MAC). However, several limitations with strong constraints make applying those techniques to LIN networks challenging, leaving several vehicles still unprotected. This paper presents LIN Multiplexed MAC (LIN-MM), a new approach for exploiting signal modulation to multiplex MAC data with standard LIN communication. LIN-MM allows for transmitting MAC payloads, maintaining full-back compatibility with all versions of the standard LIN protocol.

Index Terms—LIN Protocol, Automotive, Secure Embedded System, Secure LIN Network, Multiplexed MAC.

I. INTRODUCTION

Nowadays, the automotive field is turning into a profitable domain for attackers[1]. Vehicles and related systems are operating in an enduring inimical environment[2]. Therefore, carmakers and governments are becoming increasingly sensitive about road vehicle cyber-attacks.

The United Nations Economic Commission for Europe (UNECE)[3] is promoting explicit legislation on road vehicles cybersecurity. In particular, the existing Work of Parties on the Adoption of Harmonized Technical United Nations Regulations for Wheeled Vehicles (WP29) [4] endorsed two new regulation bullets: UN Regulation No. 155 (UNR155) [5] and UN Regulation No. 156 (UNR 156)[6]. The first focuses on the vehicle’s cybersecurity management system (CSMS), while the latter introduces the requirement of building a software update management architecture. The ISO/SAE 21434:2021 Road vehicles Cybersecurity engineering requirements[7] is a new standard introduced by the automotive industry to secure all supply chain developments in compliance with UNR155 and UNR156 regulations.

Authors contacts: {franco.oberti, alessandro.savino, ernesto.sanchez, stefano.dicarlo}@polito.it and {filippo.paris, mirco.brero}@punchtorino.com

Henceforth, every road vehicle, both permanently and seamlessly connected, must satisfy UNR155 and UNR156 regulations. Motorcycles and agriculture vehicles are unique temporary exceptions. Cybersecurity conformity is crucial because it consents access to vehicle markets under UNECE statutes. Each violation of these security directives forbids selling with a massive loss of money. With this upcoming scenario, the entire automotive industry has increased the effort to apply security in its products and improve research activities.

The most widespread security threats in the automotive domain exploit communication channels among modules [8], [9], [10]. Several of these attacks exploit vulnerabilities of the primary automotive communication protocol, i.e., the Controller Area Network (CAN) protocol [11]. Therefore, the current literature proposes several solid secure mechanisms to protect CAN networks [12] and make them resilient to attacks. However, other protocols, such as the Local Interconnect Network (LIN), are gaining importance in the automotive domain [13].

Four European carmakers (i.e., BMW, Volkswagen Group, Volvo Cars, Mercedes-Benz) formed the LIN consortium in the late 1990s. At the same time, both Volcano Automotive Group and Motorola provided consulting services, especially in the networking and hardware fields. The first LIN version 1.1 was deployed in 1999. A solid requirements document was available only in 2002, with version 1.3. One year later, version 2.0 expanded the diagnostic features. The latest known release of the protocol is version 2.2A [13] released in 2010. In 2016, the CAN in Automation (CiA) organization made the LIN protocol a standard (ISO 17987: 2016). Despite being of age, the LIN protocol is being spread in automotive applications following a positive trend of growth: starting from 200 million nodes in 2010 to reaching 700 million in 2020. Despite several studies confirming critical vulnerabilities associated with this protocol, [14], [15], [16], [17], the research community has been scarcely active in proposing efficient countermeasures.

This work introduces LIN Multiplexed MAC (LIN-MM), a novel technique to multiplex a data digest of a LIN payload with the payload itself. The computed digest includes both a Message Authentication Code (MAC), and a Message Integrity Code (MIC)[18] to guarantee the integrity and authenticity of transmitted LIN data frames. LIN-MM is designed to avoid modifying the original LIN data frame, thus providing

full back compatibility with the standard protocol. Moreover, by multiplexing both data and authentication codes, robust optimization in the digest validation is provided, reducing the processing time.

The paper has the following organization: section II introduces the basic organization of a state-of-the-art vehicle LIN network, while section III describes the considered attack model on the LIN vector. Section IV describes the LIN-MM architecture, and section V provides experimental results and validation of the proposed solution. Eventually, section VI summarizes the main contributions and concludes the paper.

II. LIN PROTOCOL OVERVIEW

Modern automotive applications embed over one hundred Electronic Control Units (ECUs). ECUs are connected to other ECUs, sensors, and actuators for managing vehicle systems [19]. Many control strategies are processed in real-time, enhancing the network’s complexity. The Local Interconnected Network (LIN) and Controller Area Network (CAN) are the main communication protocols used on standard vehicle networks. While the CAN provides high-speed communication with solid reliability, the LIN serves domains where high performance and reliability are not primary targets. Thus, the LIN protocol is a viable solution for building a low-cost vehicle communication network. The LIN is a broadcast network with serial master-slave communication and 16 nodes connectable to the bus. A single master manages up to 15 slave nodes for each LIN network (Figure 1).

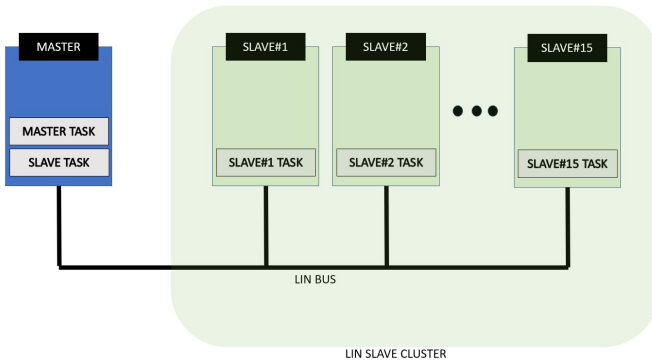

Fig. 1: LIN Network Scheme

The main advantages of the LIN are the simplified wiring (i.e., a single wire supported by the major manufacturers), no licenses, and self-synchronization. These are the reasons the LIN is very competitive in terms of costs. The limitations are a slow baud rate of up to 20K bit/s and a small data frame of 8-byte. The master manages the LIN network, always starting the communication with the slaves. A slave contacted by the master replies with a data message. In this scheme, the master polls each slave on a time base. The master assigns a time slot for the slave to reply. This approach makes collision detection unnecessary on a LIN network, meaning that only one device, the master, requires a precise oscillator. The LIN nodes are based on microcontrollers. The LIN is compatible with the

Universal Asynchronous Receiver Transmitter (UART) and the Serial Communications Interface (SCI) specifications, making hardware and software implementations simple.

The LIN single wire bus can reach up to 19.2 kbit/s, with a maximum length of 40 meters, although the LIN 2.2 specifications have increased the communication speed up to 20 kbit/s. The LIN master and slave frames differ (Figure 2). The master frame comprises three fields: break field, synch field, and a protected identifier (PID), i.e., a 6-bit field identifying the target slave. The slave data frame includes up to 8 data bytes followed by an 8 bits Cycling Redundancy Check (CRC). The battery voltage provides the nominal operating voltage for the LIN bus. The sender and receiver have different voltage level requirements. For the dominant bit (logic 0), the sender forces a voltage up to 20% of the battery level on the LIN bus. The receiver interprets a dominant bit when it reads a voltage on the bus lower than 40% of the battery level. For a recessive bit (logic 1), the sender applies 80% of the battery voltage on the bus. At the same time, the receiver interprets a recessive bit reading a level higher than 60% of the reference battery voltage (Figure 3). Different voltage thresholds between sender and receiver handle the possibility of ground shiftings in a vehicle bus, making the system more robust to occasional voltage dropping.

Typical applications of the LIN in automotive include cruise windshield wipers, turning signals, climate sensors, mirrors, door locks, seat motors, and sensors and actuators belonging to the Powertrain perimeter like the Mass Air Flow (MAF) sensor and cooling fans.

III. LIN ATTACK VECTOR ANALYSIS

ECUs act as masters in a LIN network, while sensors and actuators are usually slave devices. Every LIN transaction follows the same schema. The master sends a header that includes a PID identifying a task carried out by a slave node (e.g., ask a sensor to report the measured physical quantity or command an actuator to set itself to a new target position).

LIN slaves are the primary attack vector against LIN networks due to their high vulnerability exposure. The literature reports four possible primary attacks able to compromise the security of the LIN bus [20], [21], [22].

In the *message spoofing attack*, the attacker sniffs the bus traffic to identify the proper time slot to inject a spoofed message directed to a victim node. Spoofed messages can be used to sleep a slave node, alter the SYNC field to tamper with synchronization, or inject illegitimate messages. In general, this attack aims to destroy bus communication. Technical ability is not required to mount this attack. The attacker can exploit the dominant and recessive electrical states to cause frame corruption and Denial of Service (DoS).

Similar to the spoofing attack, the *Man in the Middle attack (MitM)* exploits an external malicious module to dissect a portion of the LIN bus. The malicious module can disconnect a victim node and a part of the LIN bus. Therefore, the attacker can hijack LIN frames from and to the disconnected LIN branch (Figure 4).

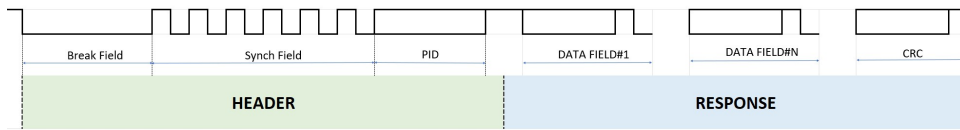

Fig. 2: LIN Frame Format

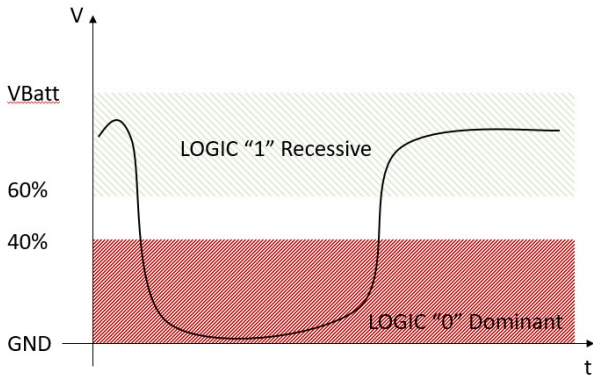

Fig. 3: LIN Electrical Signal

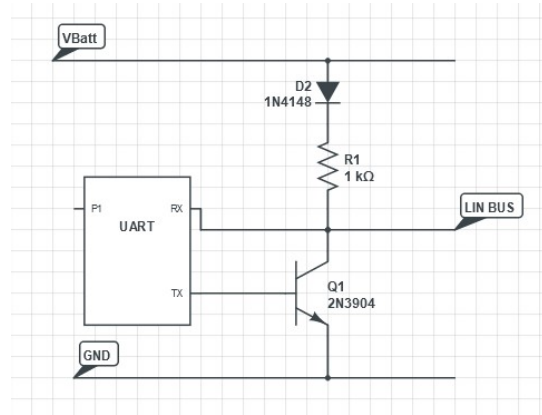

Fig. 5: LIN Transceiver Scheme

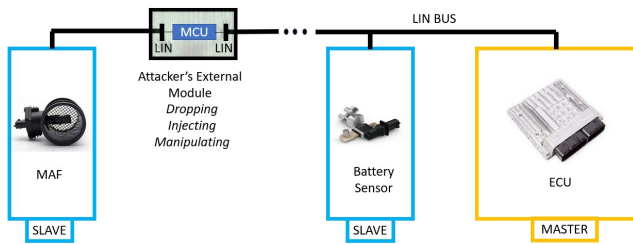

Fig. 4: LIN MitM Attack Scheme

The *response collision attacks* happens when an illegitimate response message is transmitted together with a legitimate frame. According to the specifications, if a node detects a collision, it asserts an error bit and stops transmitting, waiting for the next transmission slot. A collision is detected when, during transmission, the electrical level observed on the bus is not coherent with the transmitted logical level. Checking the electrical level of the bus during transmission is possible thanks to the electrical implementation of the LIN transceiver (Figure 5).

The attacker can either send a false header playing as a master node or wait for the legitimate master frame and manipulate the message [21]. The goal is to trigger an unexpected response colliding with the legitimate one. The legitimate slave node drops the transmission while the attacker can send an illegitimate response frame to the master node. The master node considers the attacker's message legit when the checksum code is correct.

The *header collision attack* is similar to the response

collision attack, but the attack vector is now a master header frame instead of a slave response frame. The attacker injects an illegitimate header on the LIN bus to provoke collision with an allowed header. Again, in case of collision, the master stops transmitting, and the attacker can inject a malicious frame that can redirect a request to a different slave. In this way, the attacker can tamper with the sequence of responses of the LIN network and even isolate a victim node. This attack can slide down a vehicle's windows, lock or unlock the car, or lock steering wheels while vehicles are traveling along the road.

The main difficulty of injecting an incorrect response on the LIN network lies in exploiting physical access to the LIN bus. Direct access through external modules, as shown in Figure 4 provides complete control of the bus. However, it is possible to gain partial LIN access through the CAN network. Usually, the master LIN nodes are connected to the CAN bus [16]. An attacker can reach the LIN bus through the CAN On-Board Diagnostic (OBD) port mounted in a vehicle cabin, using recent hacking techniques [17], [15].

To avoid the response and header collision attacks, Takahashi et al. [21] suggest that a slave node sends out an abnormal signal, which would overwrite a false message sent by an attacker if it detects that the bus value does not match its response. The solution is limited because the slave communicates when the master releases the appropriate time slot, so the countermeasure is not immediate. Additional suggestions include incorporating MAC and assigning essential data to the first byte of transmission, as the first byte is more difficult to corrupt. The main limitation is that the MAC code erodes the frame data payload. The LIN protocol has a maximum data payload of 8 bytes. By NIST's guidelines [23], a robust MAC code cannot be less than 64 bits, which is precisely the entire

LIN payload length. The current mitigation is to reduce the MAC digest to 4 bytes providing protection that does not meet the automotive security standards.

To the best of our knowledge, the LIN attacks described above are all possible LIN exploits that literature reports in automotive research.

IV. LIN-MM

Multiplexed Message Authentication Code for Local Interconnect Network (LIN-MM) is a new solution to introduce message authentication code compliant with NIST’s guidelines [23] in a standard LIN network without reducing the LIN payload size. LIN-MM is not intrusive and ensures full back compatibility with standard LIN devices. Moreover, LIN-MM eliminates the MAC transmission latency by transmitting it concurrently with the data payload. To the best of our knowledge, this is the first study on security applied to LIN networks.

LIN-MM applies signal modulation to multiplex the MAC bitstream with the electrical signal of the LIN frame (Figure 6). In particular, LIN-MM exploits On-Off Keying (OOK) [24], one of the most straightforward digital modulation schemes, to transform the MAC bitstream into an electrical signal. OOK uses a carrier signal; it turns the carrier “On” when transmitting a logic ‘1’ and turns it “Off” when transmitting a logic ‘0’. The modulated carrier is added to the original LIN electrical signal to multiplex the MAC bitstream with the LIN bitstream. The full 8-byte payload of a LIN response is available to implement advanced features using LIN-MM.

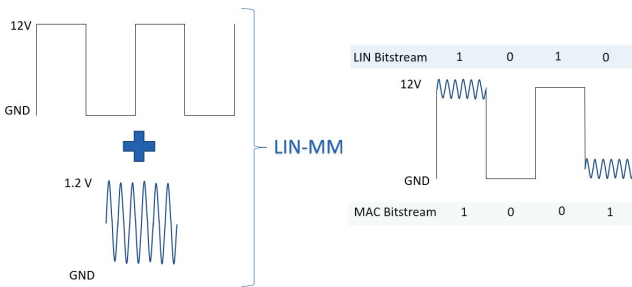

Fig. 6: LIN-MM Physical Electrical Signal

In its current implementation, LIN-MM is limited to the slave responses. The 8-byte payload of a slave response is enough to carry the information of a 64-bit MAC code compliant with NIST recommendations. Even if the same technique can be applied to the master header frames, the limited length only allows multiplexing short and less secure codes.

A. LIN-MM Slave Architecture

As illustrated in Figure 7, the LIN-MM Slave pairs a standard LIN transceiver with a custom LIN-MM carrier generator. This component generates a modulated carrier signal based on the MAC bitstream. The original LIN signal and the carrier signal are added to create the LIN-MM electrical signal.

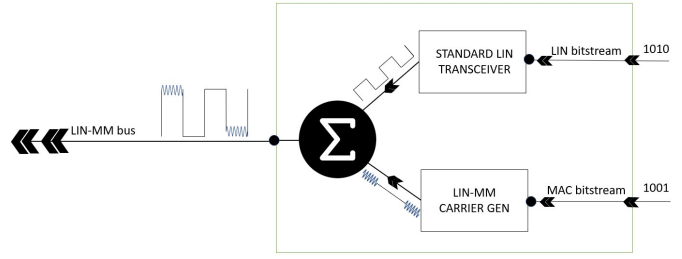

Fig. 7: LIN-MM Slave Block-Scheme in transmission

The LIN-MM carrier generator is composed of a multiplexer accepting two inputs: the carrier provided by a dedicated signal generator and GND (Figure 8). The MAC bitstream controls the multiplexer commutation. It switches the multiplexer to the carrier signal when the corresponding MAC bit is ‘1’; it changes to GND otherwise. The standard LIN transceiver and the LIN-MM carrier generator are synchronized properly to multiplex the two signals.

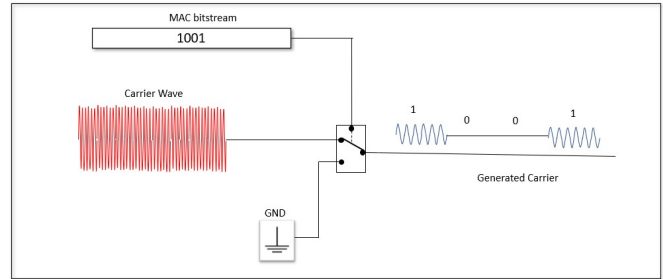

Fig. 8: LIN-MM Carrier Generator Block-Scheme

The carrier frequency (f_c) must be selected to enable its isolation from the LIN signal through filtering, even in case of noise. The proposed implementation exploits a 100 kHz sinusoidal signal that can be easily separated from the 20 kbit/s LIN signal. The carrier frequency is synchronous with the pure LIN signal, and both share the same sample time windows. Considering $V_{batt} = 12V$, the carrier amplitude is set to 1.2V to keep the generated signal within the LIN electrical specifications (section IV).

B. LIN-MM Master

Figure 9 shows the architecture of the LIN-MM Master composed of two main blocks: a standard LIN transceiver and a demodulation block. The standard LIN transceiver processes the LIN-MM signal. The MAC multiplexed signal is noise canceled by the internal transceiver filters. The demodulation block is introduced to demodulate and reconstruct the MAC bitstream from the physically received signal.

The LIN-MM demodulation block comprises three subsystems (Figure 10a). Figure 10 shows the effect of these subsystems on the processed signal.

A pass-band filter with a center frequency f_c at the carrier’s frequency isolates the carrier’s contribution from the rest of the

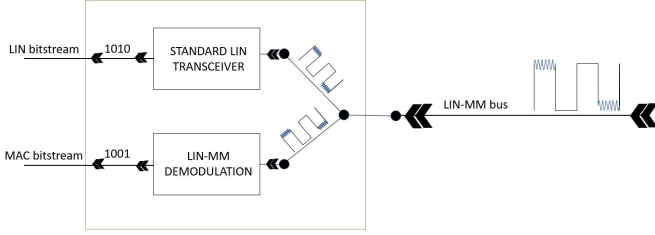
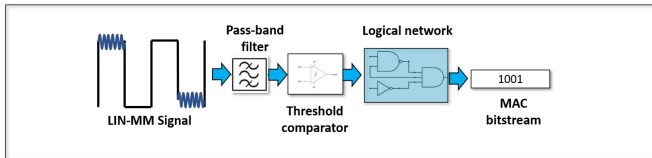

Fig. 9: LIN-MM Master Block-Scheme in receiving

signal. With $f_c = 100kHz$ the filter is designed with a bandwidth $BW = 50kHz$ corresponding to a low-pass frequency $f_l = 75kHz$ and a high-pass frequency $f_h = 125kHz$.

A threshold comparator transforms the analog sinusoidal carrier into a signal in the digital domain with a bit transmission rate equal to the carrier frequency.

Finally, a digital network reconstructs the MAC bitstream. It acts as a digital counter synchronized with the LIN bit signal. The counter is reset at the beginning of each LIN period (i.e., LIN bit transmission period) and counts the number of digital pulses generated by the comparator. At the end of the LIN period, a MAC logic '0' is reconstructed if the counter detected less than three pulses, a logic '1' otherwise. This approach allows for reliable MAC bitstream reconstruction, with a robust resilience to noise that may generate spurious spikes. With this schema, the MAC bitstream can be reconstructed with a delay of a single LIN period.



(a) LIN-MM Demodulation Block pipeline

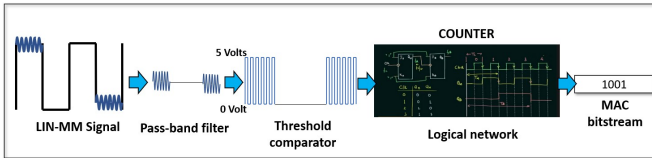

(b) LIN-MM Demodulation Block Signal Profile

Fig. 10: LIN-MM Demodulation Block Scheme

V. EXPERIMENTAL RESULTS

An LTSpice [25] prototype implementation of a LIN-MM architecture composed of a Master and a Slave node was implemented to prove the feasibility of the proposed schema and therefore validate and verify the LIN-MM functionality. Figure 11 shows a high-level block scheme of the prototype architecture. The master node sends a LIN header frame to the slave node that replies with a LIN response message.

The response message encapsulates a 64-bit MAC digest for authenticating the transmitted data. The system works with a 19.2k bit/s baud rate. The entire architecture is implemented with a standard LIN transceiver.

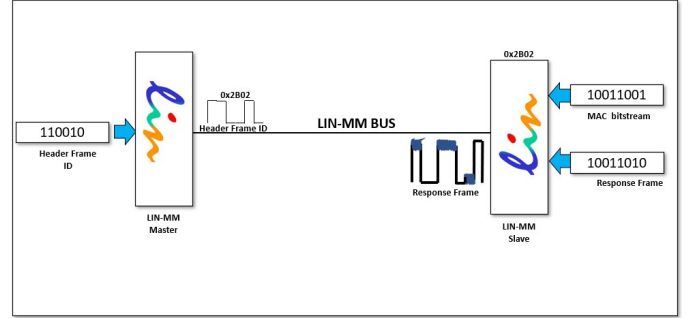

Fig. 11: LIN-MM Spice Model Block Scheme

A. Functional validation

Figure 12 provides a functional validation of the proposed architecture showing the LIN-MM Response Frame, produced by the LIN slave node (Figure 11). The first signal (red) shows the physical, electrical signal on the LIN bus. The second signal (blue) shows the MAC bitstream encapsulated in the LIN-MM signal.

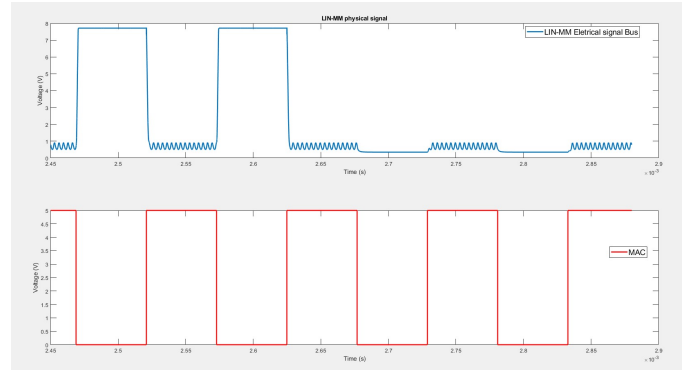

Fig. 12: LIN-MM Response Frame

As expected, the LIN-MM physical signal shows the presence of the carrier in correspondence to MAC bits at logic '1'. In contrast, no carrier is present in correspondence of MAC bits at logic '0'.

Figure 13 shows the MAC bitstream propagation time. The blue signal is the MAC bitstream generated by the LIN-MM slave, while the red line is the MAC bitstream reconstructed by the LIN-MM Master. The MAC bitstream propagation latency time is 52us, limited to one LIN period sample.

B. Overhead evaluation

Implementing the LIN-MM requires introducing an additional plug-in module to all nodes that require secure LIN communication. Comparing the standard LIN transceiver hardware with the LIN-MM transceiver, we estimate an increment

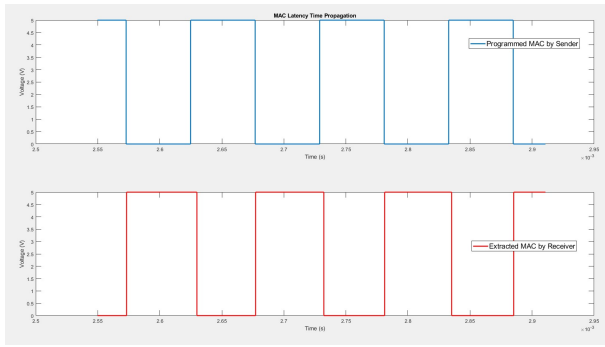

Fig. 13: MAC bitstream time propagation.

in the price of 2% per part. This estimation is obtained by using the price of a standard LIN transceiver as a reference and considering the cost of the additional discrete components required to implement the LIN-MM modulation and demodulation blocks. This overhead is acceptable considering that the only alternative solution to guarantee adequate security levels would be to migrate from the LIN protocol to a more secure CAN protocol that would introduce higher costs. In the current LIN-MM architecture, the master node only requires demodulation, while slave nodes need modulation capability. Even if no results on power consumption are not reported, the power overhead is negligible given that only a few low-power additional components are used for building up the modulator and demodulator.

The LIN-MM receiver obtains the full MAC bit stream 50us after receiving the LIN payload with a very short latency time. LIN-MM introduces a significant performance improvement compared to today's insecure implementations with a 32-bit MAC code embedded in the payload, where the latency time is around 190ms.

Eventually, let us discuss the LIN-MM impact on the hardware and vehicle architecture. The LIN-MM solution is fully compatible with standard hardware and can work on a hybrid network. It permits upgrading the sensible asset nodes to LIN-MM while keeping nodes with no security implications on legacy hardware.

In conclusion, the experimental results support the initial expectations. The LIN-MM concept achieves the main features to multiplex the MAC code directly at the LIN physical signal level. This achievement is crucial to confirm the security level improvement of LIN-MM compared with the standard LIN network.

C. Security analysis

The keystone of LIN-MM is a mechanism to multiplex at the electrical level a MAC digest with a standard LIN signal.

The proof of the security of the LIN-MM solution holds under the infeasibility hypothesis. We assume the use of state-of-the-art secure cryptographic algorithms with proper key lengths.

Employing a state-of-the-art automotive hardware control module, LIN-MM can be implemented to work with a state-of-

the-art Cipher-based Message Authentication Code (CMAC) based on the Advanced Encryption Standard 128-bit Cipher (AES128) with Block Chaining (CBC) modality. The introduction of the MAC code guarantees integrity and authentication on LIN communication with significant mitigation of the attacks introduced in section III. CMAC-128bits with a truncated digest to 8 bytes guarantees a considerable security level increment. Sixty-four bits are the minimum digest's length for considering the MAC code as secure. Today, solutions embedding a 32-bit digest in the LIN data payload cannot guarantee this level of security.

By guaranteeing integrity and authenticity of LIN response frames, LIN-MM ensures resiliency from the attacks that exploit the response frame as a vector, i.e., Spoofing, Man in the Middle (MitM), and Response collision attacks.

On the contrary, LIN-MM is not a viable security mechanism for those attacks that use the header frame as a vector, i.e., Header collision attacks. The primary constraint, in this case, is that the header frame is not large enough to multiplex a robust MAC code. Moreover, the LIN-MM is ineffective as a countermeasure for *Denial of Service (DoS)* attacks.

The LIN-MM architecture requires sharing a secret key between the master and the slave nodes. Storing this secret key is not a significant issue, given that all LIN nodes are based on microcontrollers. In this context, the key management infrastructure becomes an important issue that must be considered before deploying this solution at a commercial level.

D. Noise analysis

During LT-Spice simulation, we executed specific experiments to evaluate the resilience of the protocol to noise. Considering a steady battery voltage reference (VBatt) of 13.5 volts, the experiment showed a degraded noise tolerance band of around 9%. In this condition, we measured an electrical noise equal to 2.7% of the LIN noise band ability in the worst-case scenario. Neither LIN vehicle noise models nor in-vehicle acquisitions are available. Therefore, to perform these experiments, we adapted a known CAN network noise model. Evaluation makes us confident that applying the LIN-MM architecture in a real vehicle, even if considering the noise tolerance degradation driven by the modulation part, the embedded system runs with an acceptable margin within the noise tolerance band.

VI. CONCLUSION

LIN-MM is an attempt to upgrade the standard adopted LIN hardware in the automotive domain to fulfill the new challenges of the upcoming security regulations and requirements, keeping the associated cost as low as possible. LIN-MM is back-compatible with today's LIN devices. It can work in a hybrid network that mixes LIN and LIN-MM devices, making it a very flexible solution. This approach reduces the costs of upgrading the existing vehicle fleet to cybersecurity regulations. The conducted security analysis shows a visible improvement in terms of security for the LIN network, especially concerning the first three kinds of attack described

in section III. The last category of attacks, i.e., Header collision attacks, is still in place with no mitigation driven by LIN-MM architecture. Currently, we are working to enhance the LIN-MM architecture on a new version preliminary named (Type-B) to address this vulnerability by providing integrity to the LIN Header Frame.

REFERENCES

- [1] Data Bridge, “Global automotive cyber security market—industry trends and forecast to 2028,” 2021. [Online]. Available: <https://www.databridgemarketresearch.com/reports/global-automotive-cyber-security-market>
- [2] S. Ghosh, *4. Perspective: the vehicle manufacturers’ take on cybersecurity*. Society of Automotive Engineers, 2016, pp. 19–24.
- [3] UNECE, “Transport - vehicle regulations, wltip task force on on-board-diagnostic (obd),” 2012. [Online]. Available: <https://wiki.unece.org/pages/viewpage.action?pageId=2523184>
- [4] UN Economic Commission for Europe, “Unece world forum for harmonization of vehicle regulations (wp.29),” 2021. [Online]. Available: <https://unece.org/wp29-introduction>
- [5] UN Economic Commission for Europe, “Un regulation no. 155 - cyber security and cyber security management system,” 2021. [Online]. Available: <https://unece.org/transport/documents/2021/03/standards/un-regulation-no-155-cyber-security-and-cyber-security>
- [6] UN Economic Commission for Europe, “Un regulation no. 156 - software update and software update management system,” 2021. [Online]. Available: <https://unece.org/transport/documents/2021/03/standards/un-regulation-no-156-software-update-and-software-update>
- [7] International Organization for Standardization, “Iso/sae 21434:2021 road vehicles — cybersecurity engineering,” 2021. [Online]. Available: <https://www.iso.org/standard/70918.html>
- [8] F. Oberti, E. Sanchez, A. Savino, F. Parisi, and S. Di Carlo, “Mitigation of automotive control modules hardware replacement-based attacks through hardware signature,” in *2021 51st Annual IEEE/IFIP International Conference on Dependable Systems and Networks - Supplemental Volume (DSN-S)*, 2021, pp. 13–14.
- [9] F. Oberti, E. Sanchez, A. Savino, F. Parisi, and S. Di Carlo, “Taurum p2t: Advanced secure can-fd architecture for road vehicle,” in *2021 IEEE 27th International Symposium on On-Line Testing and Robust System Design (IOLTS)*. IEEE, 2021, pp. 1–7.
- [10] F. Oberti, A. Savino, E. Sanchez, F. Parisi, and S. Di Carlo, “Ext-aurum p2t: an extended secure can-fd architecture for road vehicles,” *IEEE Transactions on Device and Materials Reliability*, pp. 1–1, 2022.
- [11] International Organization for Standardization, “Iso 11898-3:2006 road vehicles — controller area network (can) — part 3: Low-speed, fault-tolerant, medium-dependent interface,” 2006. [Online]. Available: <https://www.iso.org/standard/36055.html>
- [12] C. Lin and A. Sangiovanni-Vincentelli, “Cyber-security for the controller area network (can) communication protocol,” in *2012 International Conference on Cyber Security*, 2012, pp. 1–7.
- [13] International Organization for Standardization, “Iso 17987-1:2016 road vehicles — local interconnect network (lin) — part 1: General information and use case definition,” 2016. [Online]. Available: <https://www.iso.org/standard/61222.html>
- [14] S. G. Philipsen, B. Andersen, and B. Singh, “Threats and attacks to modern vehicles,” in *2021 IEEE International Conference on Internet of Things and Intelligence Systems (IoT&IS)*, 2021, pp. 22–27.
- [15] HACKADAY, “Embed with elliot: Lin is for hackers,” 2022. [Online]. Available: <https://hackaday.com/2017/05/26/embed-with-elliott-lin-is-for-hackers/>
- [16] J. Deng, L. Yu, Y. Fu, O. Hambolu, and R. R. Brooks, “Chapter 6 - security and data privacy of modern automobiles,” in *Data Analytics for Intelligent Transportation Systems*, M. Chowdhury, A. Apon, and K. Dey, Eds. Elsevier, 2017, pp. 131–163. [Online]. Available: <https://www.sciencedirect.com/science/article/pii/B9780128097151000067>
- [17] A. Martínez-Cruz, K. A. Ramírez-Gutiérrez, C. Feregrino-Uribe, and A. Morales-Reyes, “Security on in-vehicle communication protocols: Issues, challenges, and future research directions,” *Computer Communications*, vol. 180, pp. 1–20, 2021. [Online]. Available: <https://www.sciencedirect.com/science/article/pii/S0140366421003297>
- [18] RFC, “Internet security glossary, version 2,” 2007. [Online]. Available: <https://datatracker.ietf.org/doc/html/rfc4949>
- [19] A. Albert *et al.*, “Comparison of event-triggered and time-triggered concepts with regard to distributed control systems,” *Embedded world*, vol. 2004, pp. 235–252, 2004.
- [20] F. Paez and H. Kaschel, “Towards a robust computer security layer for the lin bus,” in *2021 IEEE International Conference on Automation/XXIV Congress of the Chilean Association of Automatic Control (ICA-ACCA)*, 2021, pp. 1–8.
- [21] J. Takahashi, Y. Aragane, T. Miyazawa, H. Fuji, H. Yamashita, K. Hayakawa, S. Ukai, and H. Hayakawa, “Automotive attacks and countermeasures on lin-bus,” *Journal of Information Processing*, vol. 25, pp. 220–228, 02 2017.
- [22] Z. El-Rewini, K. Sadatsharan, D. F. Selvaraj, S. J. Plathottam, and P. Ranganathan, “Cybersecurity challenges in vehicular communications,” *Vehicular Communications*, vol. 23, p. 100214, 2020. [Online]. Available: <https://www.sciencedirect.com/science/article/pii/S221420961930261X>
- [23] NIST, “Recommendation for block cipher modes of operation: The cmac mode for authentication,” 2016. [Online]. Available: <https://www.nist.gov/publications/recommendation-block-cipher-modes-operation-cmac-mode-authentication-0>
- [24] M. Forzati, “Phase modulation techniques for on-off keying transmission,” vol. 1, 08 2007, pp. 24–29.
- [25] Analog Devices. Ltspice simulator. [Online]. Available: <https://www.analog.com/en/design-center/design-tools-and-calculators/ltspice-simulator.html>